

A photograph of a hospital room. In the foreground, a bed with white linens is visible. To the right, there is a medical monitor on a stand and a control panel with various buttons and lights. A window with a view of green trees is in the background. A purple chair is positioned near the window.

# The Path to Radical Energy Improvement Runs Through Ventilation Code Reform

ASHRAE Orange Chapter, April 2016

KAISER PERMANENTE. thrive

## “Small Hospital, Big Idea” Competition, 2011



In 2011, my company held a design contest, where we asked designers to dream up the hospital of the future. We narrowed the submissions down to three finalists. The finalists put together full-blown proposals.

All three of the finalists proposed net zero hospitals. All three of them said the hospital of the future would be a net zero building.

My boss, at the time, told me “you better get out in front of this net-zero hospital thing. They all talked about net zero hospitals. Our leadership loved it. It’s totally lined up with our brand, and our public image. So, this is coming.”

He says “Go find out where all the net zero buildings are, and see how they’re doing it.”

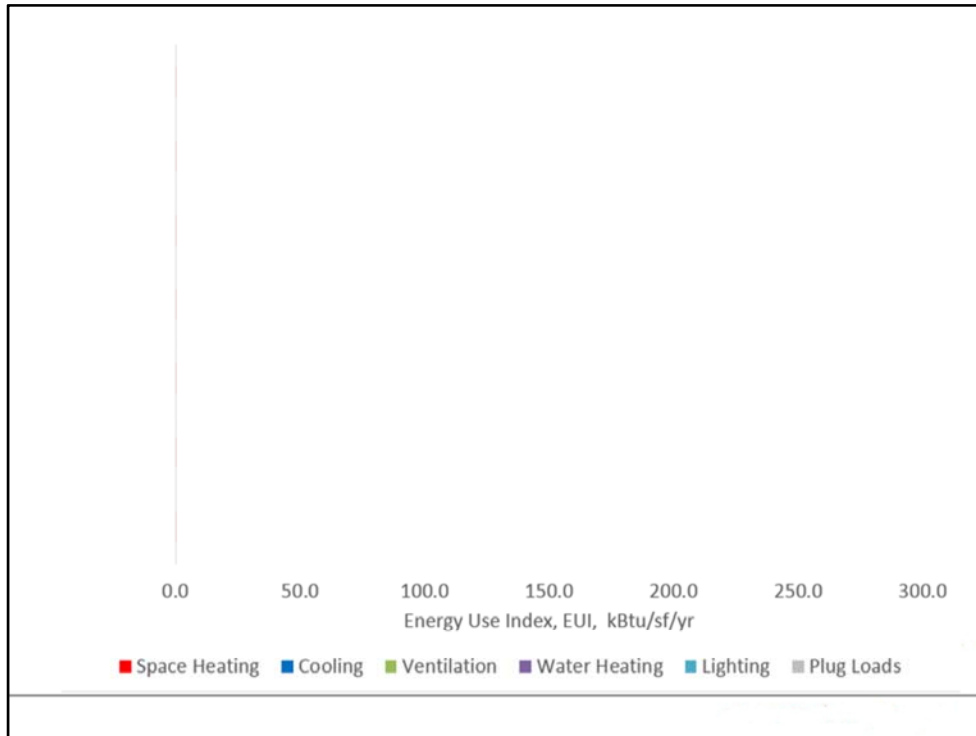

Building energy is in units of EUI. EUI stands for “energy use index” or “energy use intensity”, either. It is in kbtu/sf/yr.

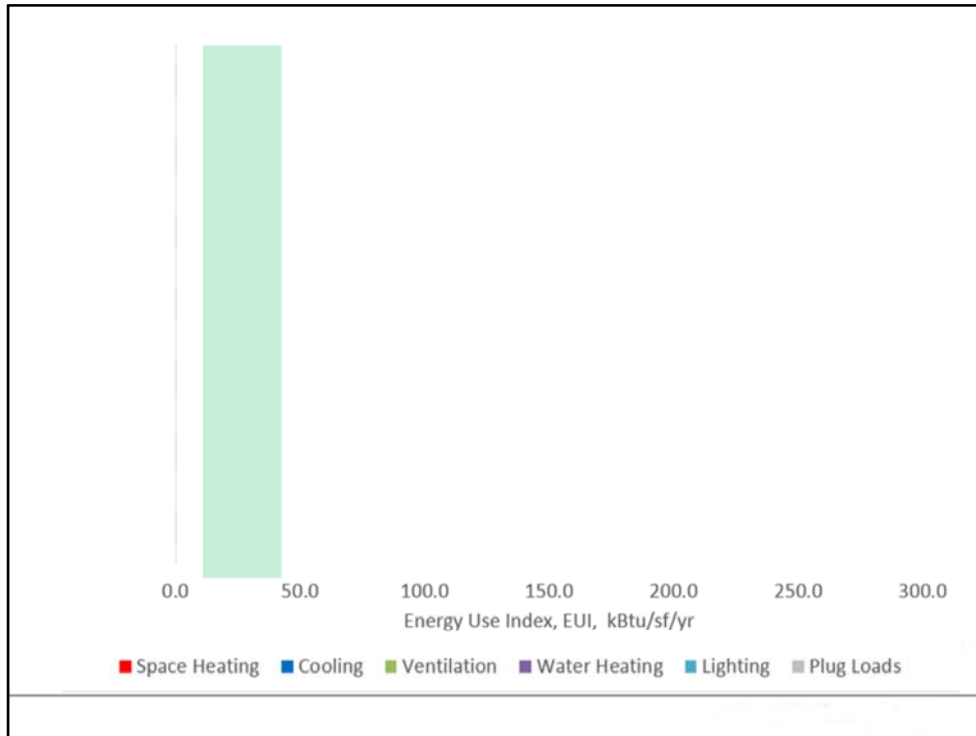

When the energy gurus talk about “net zero”, they use a target EUI range of 20-45 kbtu/sf/yeer.

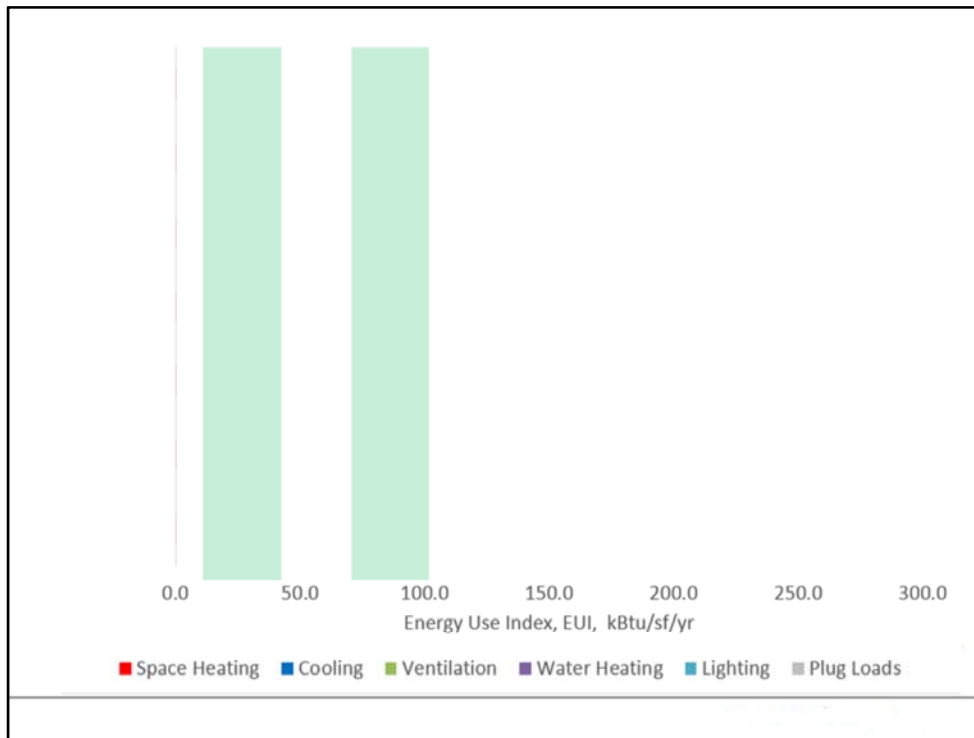

Those net zero hospital proposals I told you about were a little higher. They were about 65-100.

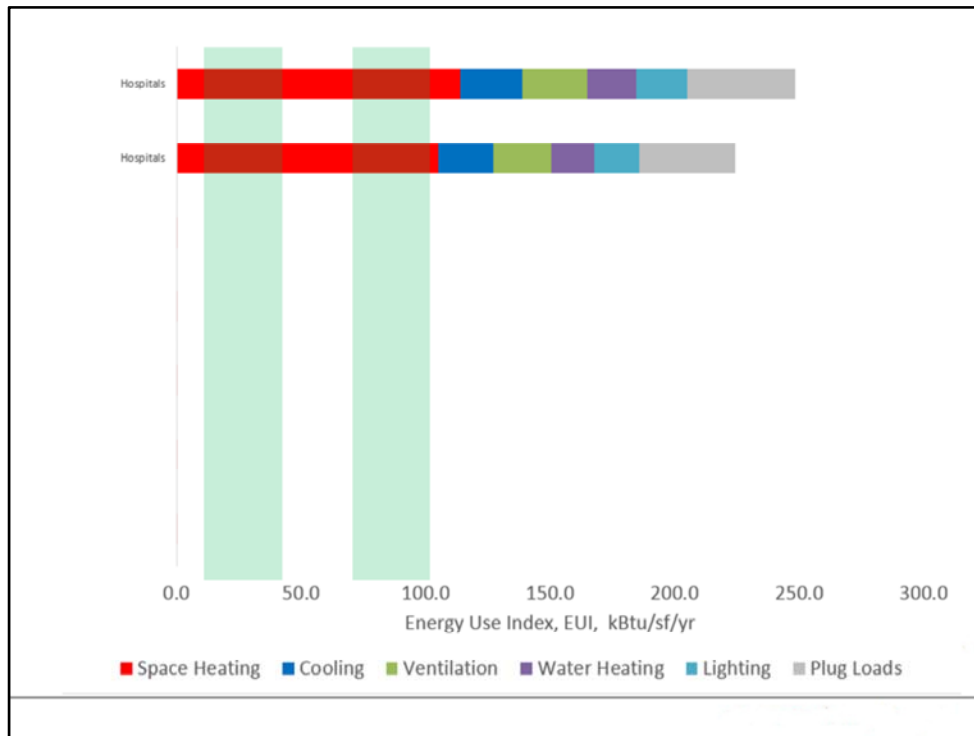

- Ok, here's the national average US hospital.
- And, here's my average (KP hospitals). OK, so far this looks scary, right?

Clearly, the most energy is in HVAC. We can save energy in lighting systems, or medical equipment loads. Those are great. But, HVAC is the big one.

OR are kind of a red herring, too, BTW. ORs use a lot of energy. But, they don't make up much footprint of one of our hospitals. We could cut our OR energy in half and only move this by 5%.

*So, we need to talk about HVAC. And, its almost, like, not a discussion about details. Its more like our general approach to HVAC.*

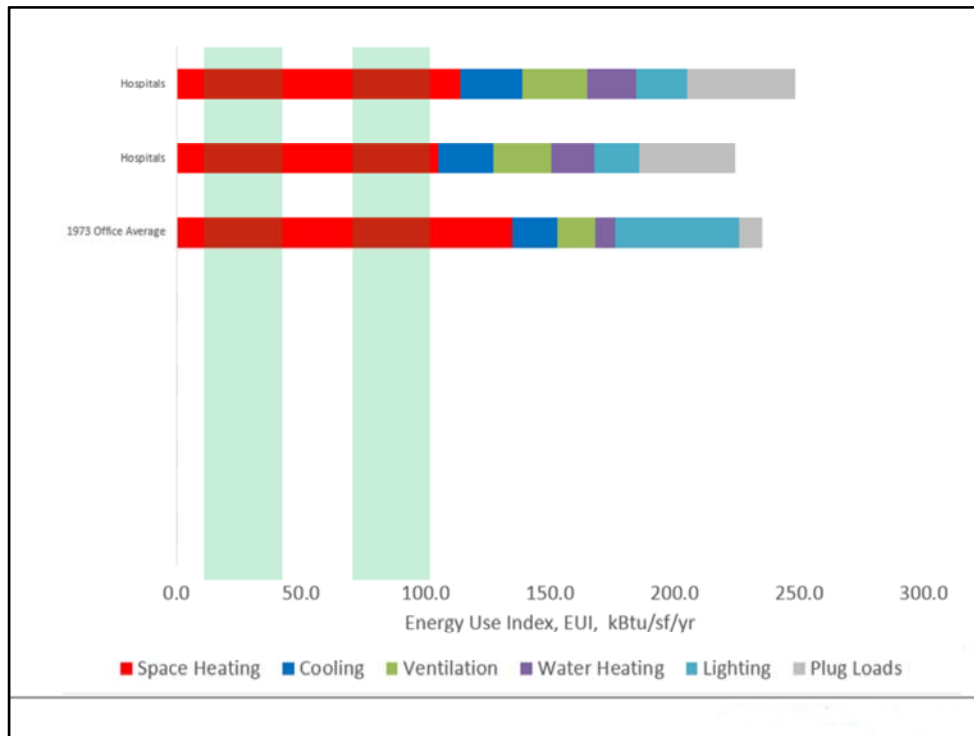

This is the average US office building from the early 1970s. You're like: "OK. That's random. Why is he showing me an office building from the 70s?"

Well, that's before we had energy standards. The first US building energy standard was ASHRAE Standard 90. It came out in 1976.

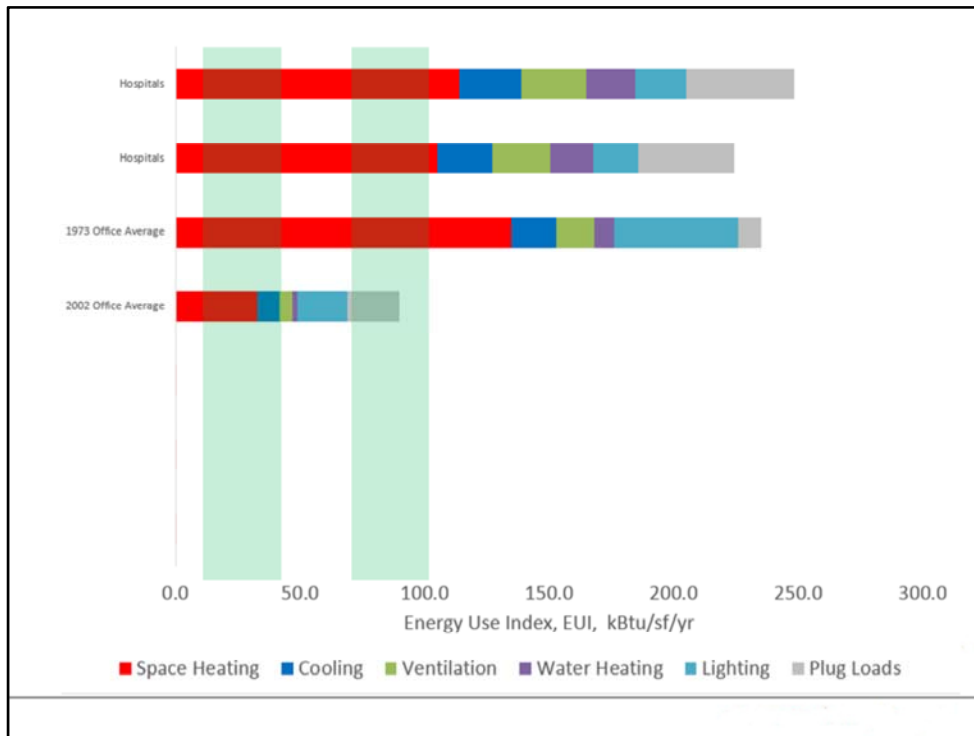

Here's the average US office building from 2002.

60% reduction energy. 70% reduction in HVAC. 75% reduction in the heating.  
Remember that. We're going to talk about that.



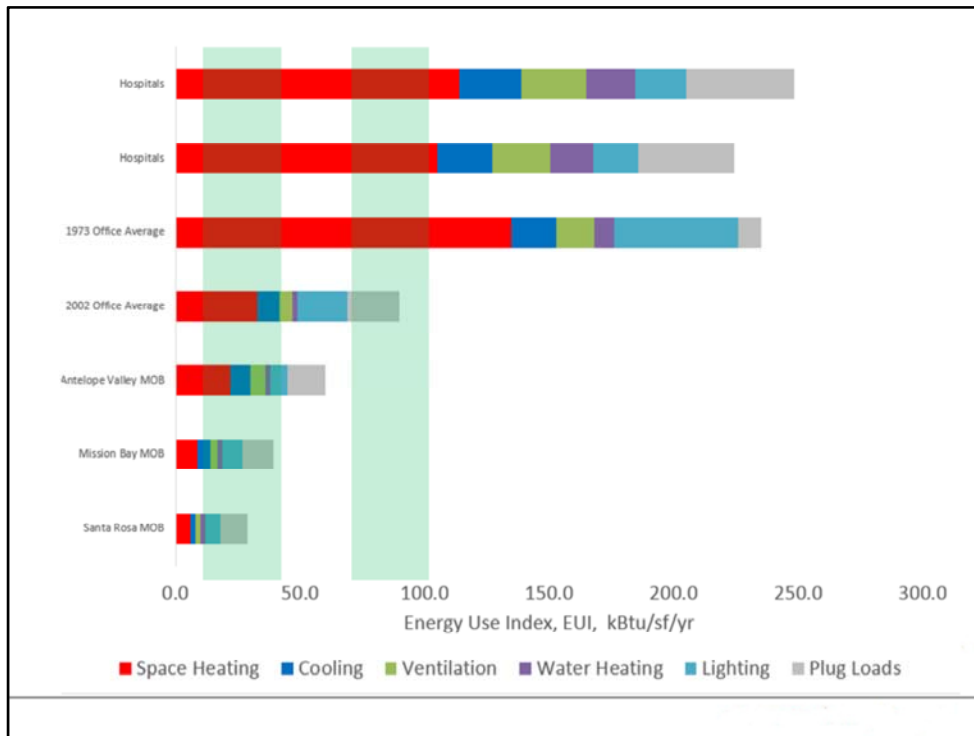

Here's some recent stuff. These are Medical Office Buildings (MOB- I call medical office buildings MOB), we've been doing. And, we're getting closer and closer. Kaiser will have a net zero capable or net-zero MOB in the next few years.

But, the hospitals are way off.

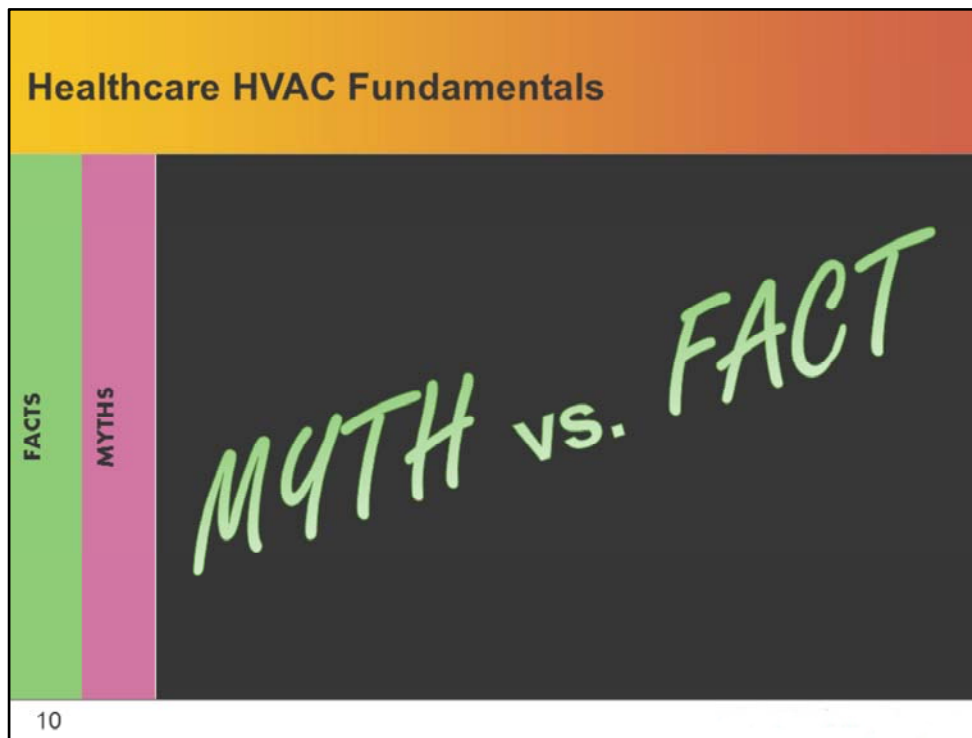

So, we' need to talk about the general approach to HVAC in health care. Let's hit this topic head-on. So, I'm going to show you two sets of slides, here: "The Facts" and "The Myths".

Here's my guarantee: You'll see a slide in the next 15 minutes that either teaches you something you never knew, or upsets you - because its totally opposite to something you believe. One or the other, in the next 15 minutes, or your money back!!

# 1. Airborne diseases

FACTS

- Tuberculosis (Wells, 1934)
- Smallpox
- Chickenpox (varicella-zoster)
- Measles
- Mumps
- Rubella

| ACH | Minutes required for removal efficiency <sup>†</sup> |       |
|-----|--|-------|
|     | 99%  | 99.9% |
| 2   | 138  | 207   |
| 4   | 69   | 104   |
| 6   | 46   | 69    |
| 12  | 23   | 35    |
| 15  | 18   | 28    |
| 20  | 14   | 21    |
| 50  | 6  | 8     |
| 400 | <1   | 1     |

\* This table can be used to estimate the time necessary to clear the air of airborne *Mycobacterium tuberculosis* after the source patient leaves the area or when aerosol-producing procedures are complete.  
<sup>†</sup> Time in minutes to reduce the airborne concentration by 99% or 99.9%.

FIGURE 3. Example of negative-pressure room control for airborne infection isolation (AII)<sup>†</sup>

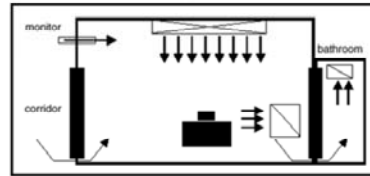

Source: Adopted from Heating/Piping/Air Conditioning (HPAC) Engineering, October 2000, Penton Media, Inc.  
 Note: Stacked black boxes represent patient's bed. Long open box with cross-hatch represents supply air. Open boxes with single diagonal slashes represent air exhaust registers. Arrows indicate direction of airflow.  
<sup>†</sup> Possible uses include treatment or procedure rooms, bronchoscopy rooms, and autopsy.

- Negative-pressure room engineering features include
- negative pressure (greater exhaust than supply air volume);
  - pressure differential of 2.5 Pa (0.01-in. water gauge);
  - airflow differential >125-cfm supply versus exhaust;
  - sealed room, approximately 0.5-sq. ft. leakage;
  - clean to dirty airflow;
  - monitoring;
  - ≥12 air exchanges/hr (ACH) new or renovation, 6 ACH existing; and
  - exhaust to outside or HEPA-filtered if recirculated.

Source: CDC. Guidelines for Environmental Infection Control in Health-Care Facilities.  
<http://www.cdc.gov/mmwr/preview/mmwrhtml/rr5210a1.htm>.

First, the facts:

To deal with Tuberculosis and the other (quote) “truly airborne” diseases, we isolate patients into dedicated rooms. They have negative pressurization, and 100% exhaust. They are discreet spaces. They’re called Airborne Isolation Rooms.

## 2. Protective environments

FACTS

- Solid organ transplants
- Hematopoietic stem cell transplant (HSCT)
- chemotherapy-induced neutropenia



FIGURE 1. Example of positive-pressure room control for protection from airborne environmental microbes<sup>1</sup>

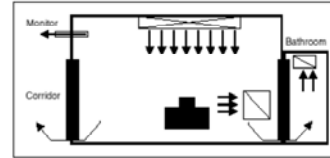

Source: Adapted from Heating/Piping/Air Conditioning (HPAC) Engineering, October 2000, Penton Media, Inc.

Note: Stacked black boxes represent patient's bed. Long open box with cross-hatch represents supply air. Open boxes with single, diagonal slashes represent air exhaust registers. Arrows indicate directions of airflow.

<sup>1</sup>Possible uses include immunocompromised patient rooms (e.g., hematopoietic stem cell transplant or solid organ transplant procedure rooms) and orthopedic operating rooms.

<sup>2</sup>Positive-pressure room engineering features include

- positive pressure (greater supply than exhaust air volume);
- pressure differential range of 2.5–8 Pa (0.01–0.03-in. water gauge), ideal at 8 Pa;
- airflow differential >125-cfm supply versus exhaust;
- sealed room, approximately 0.5-sq. ft. leakage;
- clean to dirty airflow;
- monitoring;
- ≥12 air changes/hr (ACH); and
- return air if recirculated.

Source: CDC. Guidelines for Environmental Infection Control in Health-Care Facilities. <http://www.cdc.gov/mmwr/preview/mmwrhtml/rr5210a1.htm>.

12

Protective Environments (PEs) for severely immunocompromised patients. This is my niece, Ashley, she had a double lung transplant! During recovery, the slightest fungal contamination could have killed her. So, she's in a clean room 2000 with HEPA filters and positive pressure in this photo. We call that a "protective environments".

### 3. Infection Control Risk Assessment (ICRA)

- Construction (demolition)
- Aspergilliosis

Source: ASHE. Infection Control Risk Assessment Tool.  
[http://www.ashe.org/resources/tools/pdfs/assessment\\_icra.pdf](http://www.ashe.org/resources/tools/pdfs/assessment_icra.pdf)

FACTS



| Infection Control Construction Permit |   | Permit No.  |
|---------------------------------------|---|---|
| Location of Construction              |   | Permit Site/Date  |
| Project Coordinator                   |   | Estimated Duration  |
| Contractor Performing Work            |   | Permit Expiration Date  |
| Supervisor                            |   | Telephone   |
| ISS. I. No.                           | CONSTRUCTION ACTIVITY   | ISS. No.   INFECTION CONTROL RISK GROUP   |
|                                       | CLASS II, demolition, interior finish activity  | GROUP 2, Low Risk   |
|                                       | TYPE II: High walls, floor demolition, interior finish work   | GROUP 2, Moderate Risk  |
|                                       | TYPE II: Major demolition and construction activities   | GROUP 3, High/Moderate Risk   |
|                                       | TYPE II: Major demolition and construction activities   | GROUP 4, Highest Risk   |
| CLASS I                               | 1. Remove work to be replaced or demolished using dust-free construction techniques.  | 1. Vapor Barriers for Remediating   |
|                                       | 2. Immediately replace and seal any air displaced for removal.  |   |
| CLASS II                              | 1. Provide positive pressure to prevent air from being drawn into adjacent areas.   | 6. Control construction noise before transport to nearby controlled activities.   |
|                                       | 2. Water wet work surfaces to control dust with misting.  | 7. Use any and all equipment with HEPA filtered vacuum motor having work area.  |
|                                       | 3. Seal unused doors with dust caps.  | 8. Place dust mats at entrance and exit of work area.   |
|                                       | 4. Wash off and seal air vents.   | 9. Isolate HEPA system in areas where work is being performed, unless other work is completed.  |
|                                       | 5. Wipe surfaces with disinfectant/sanitizers.  | 10. Vacuum work with HEPA filtered vacuums.   |
| CLASS III                             | 1. Observe infection control permit before construction begins.   | 11. Seal gaps with appropriate materials.   |
|                                       | 2. Determine HEPA system in areas where work is being done is properly maintained at the start of work.   | 12. Remove debris materials carefully to eliminate generation of dust and debris associated with construction.  |
|                                       | 3. Complete all critical barriers or equipment control cables sealed before construction begins.  | 13. Control construction noise before transport to nearby controlled activities.  |
| Notes                                 | 4. Minimum negative air pressure within work site utilizing HEPA equipped air filtration units.   | 14. Cover transport receptacle in carts. Tape covering.   |
|                                       | 5. Do not remove barriers from work area until complete project is checked by Infection Prevention & Control and approved by Environmental Services.  | 15. Tape covering, unless HEPA system where work was performed.   |
| CLASS IV                              | 1. Observe infection control permit before construction begins.   | 6. Do not remove barriers from work area until completed project is checked by Infection Prevention & Control and approved by Environmental Services. |
|                                       | 2. Determine HEPA system in areas where work is being done is properly maintained at the start of work.   | 7. Vacuum work with HEPA filtered vacuums.  |
|                                       | 3. Complete all critical barriers or equipment control cables sealed before construction begins.  | 8. Place dust mats at entrance and exit of work area.   |
| Notes                                 | 4. Minimum negative air pressure within work site utilizing HEPA equipped air filtration units.   | 9. Isolate HEPA system in areas where work is being performed, unless other work is completed.  |
|                                       | 5. Seal floors, pipes, conduits, and penetrations appropriately.  | 10. Vacuum work with HEPA filtered vacuums.   |
|                                       | 6. Complete construction and repair of penetrations in areas through the walls or floor, etc. in accordance with ICRA.                                | 11. Remove debris materials carefully to eliminate generation of dust and debris associated with construction.  |
|                                       | 7. Observe infection control permit before starting work only if they can hear and/or see work outside that air-controlled work from their work area. | 12. Control construction noise before transport to nearby controlled activities.  |
|                                       | 8. All personnel entering work site are required to wear shoe covers.   | 13. Cover transport receptacle in carts. Tape covering.   |
|                                       |   | 14. Tape covering, unless HEPA system where work was performed.   |
| Additional Requirements:              |   |   |
| Issue Number                          | Issue Date  | Permit Authorized By  |
| Permit Request No.                    | Permit Authorized No.   | Issue   |

KAISER PERMANENTE. thrive

Construction dust can be a source of those fungal spores (e.g. aspergillus). This can be a big risk, particularly if Ashley's Protective Room is next door. So, we do an Infection Control Risk Assessment (ICRA) on every project. And, we deploy construction practices, like air barriers and pressure controls, to reduce risks.

## 4. Operating rooms

FACTS

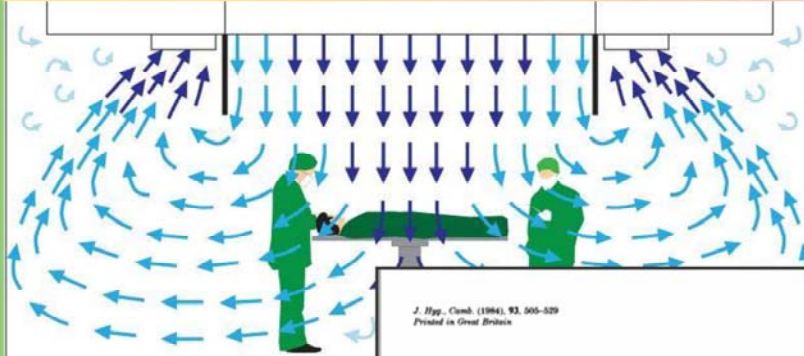

SSI = Surgical Site Infection

See: Lidwell et al. 1984 & 1986

*J. Hyg., Camb.* (1984), **93**, 505-529  
Printed in Great Britain

505

**Infection and sepsis after operations for total hip or knee-joint replacement: influence of ultraclean air, prophylactic antibiotics and other factors**

By O. M. LIDWELL\*

*Formerly of the Cross Infection Reference Laboratory, Colindale, London*

E. J. L. LOWBURY

*Formerly of the Medical Research Council Burns Unit, Accident Hospital, Birmingham.*

Clean air in ORs has been correlated to a reduced Surgical Site Infection rate. We call that "SSI". The effect was demonstrated in longer, joint-replacement procedures back in the mid 80s. Most of us believe it scales to other surgical procedures.

## 5. Sterile air for sterile processes

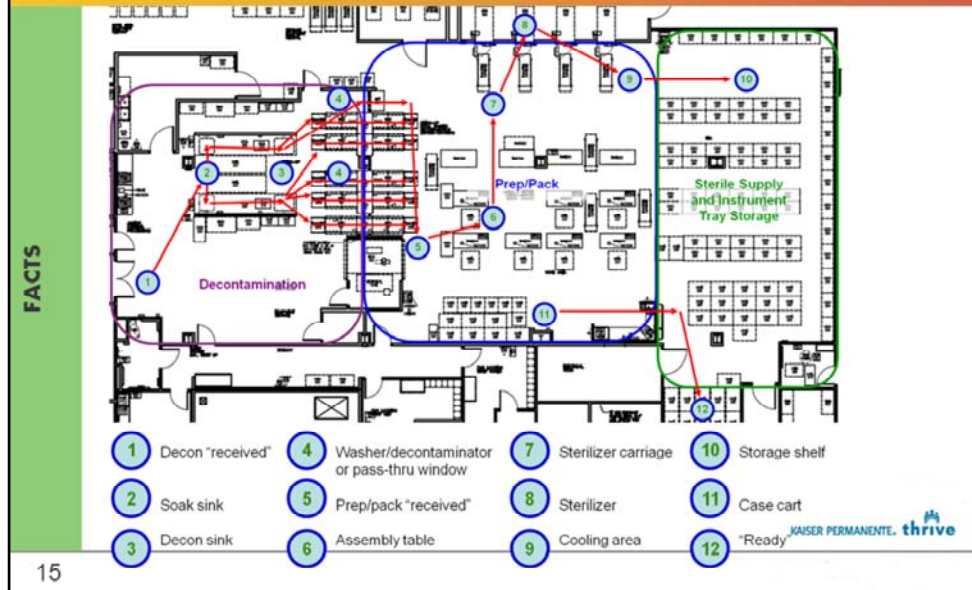

We also use clean air systems in sterile areas, like sterile processing and compounding pharmacies. I can't show you a specific study here. There's not really direct evidence for every aspect of sterile process design. But, clean air is part of the "budndle" of risk mitigation measures we do.

## 6. U.V. Lights (and other technologies) “kill” bugs

FACTS

Table 2. Comparison of selected upper-air UVGI room experiments<sup>a</sup>

| Study                       | Microorganisms                    | Fan | Method <sup>b</sup> | Upper-zone irradiance (μW/cm <sup>2</sup> ) | UV lamps (W)     | Room size (m <sup>2</sup> ) | RH (%) | Mechanical ventilation ACH | UVGI Effect   |                   |
|-----------------------------|-----------------------------------|-----|---------------------|---|------------------|-----------------------------|--------|----------------------------|---------------|-------------------|
|                             |                                   |     |                     |   |                  |                             |        |                            | eACH          | Effectiveness (%) |
| Kethley and Branch [1972]   | <i>S. marcescens</i> (2.7 μm CMD) | No  | CG                  | 10–170 <sup>2</sup>                         | 60               | 46                          | 40–50  | 6                          | 39            | —                 |
| Kethley and Branch [1972]   | <i>S. marcescens</i> (5.2 μm CMD) | No  | CG                  | 10–170 <sup>2</sup>                         | 60               | 46                          | 40–50  | 6                          | 18            | —                 |
| Ko et al. [2002]            | <i>S. marcescens</i>              | No  | CG                  | —   | 59 <sup>3</sup>  | 46                          | 44–64  | 6                          | —             | 53 (40–68)        |
| Ko et al. [2002]            | <i>S. marcescens</i>              | No  | CG                  | —   | 59 <sup>3</sup>  | 46                          | 30–52  | 6                          | —             | 86 (81–89)        |
| Miller and Macher [2000]    | <i>B. subtilis</i> spores         | Yes | CG                  | 25  | 15 <sup>5</sup>  | 36                          | —      | 2                          | —             | 56–58             |
| Miller and Macher [2000]    | <i>B. subtilis</i> spores         | Yes | Decay               | 25  | 15 <sup>5</sup>  | 36                          | —      | 2                          | 3.8           | —                 |
| Xu [2001], Xu et al. [2003] | <i>B. subtilis</i> spores         | Yes | CG                  | 42 <sup>**</sup>                            | 216 <sup>4</sup> | 87                          | 50     | 0                          | —             | 78–82             |
| First et al. [2007]         | <i>B. subtilis</i> spores         | Yes | CG                  | —   | 61 <sup>1</sup>  | 41                          | 50     | 2                          | 3.8 (3.3–4.4) | —                 |
| First et al. [2007]         | <i>B. subtilis</i> spores         | Yes | CG                  | —   | 61 <sup>11</sup> | 41                          | 50     | 6                          | 33 (30–36)    | —                 |
| First et al. [2007]         | <i>B. subtilis</i> spores         | Yes | CG                  | —   | 61 <sup>11</sup> | 41                          | 50     | 2                          | 49            | —                 |

Source: CDC NIOSH. 2009. Environmental Control for Tuberculosis: Basic Upper-Room Ultraviolet Germicidal Irradiation Guidelines for Healthcare Settings. <http://www.cdc.gov/niosh/docs/2009-105/pdfs/2009-105.pdf>

KAISER PERMANENTE. thrive

16

UV light, and other technologies like UV work. The UV people would love for me to say we should use these everywhere. I’m not going to say that; I don’t believe that. There are case studies showing these made a difference.



## 7. "Droplets" aren't "Airborne"

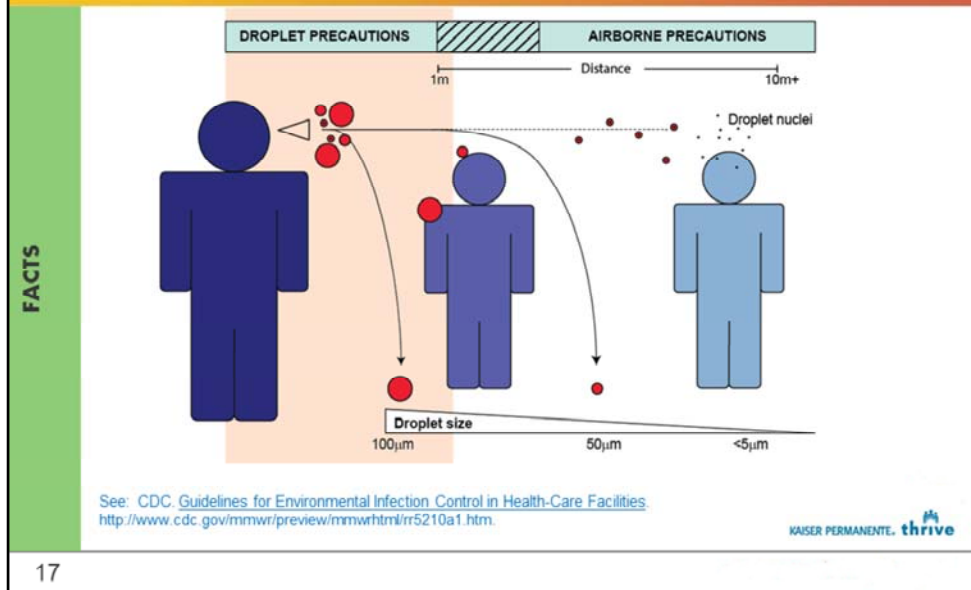

Finally, "Droplet Diseases" are different from "Airborne Diseases". Molecules 50  $\mu\text{m}$  and bigger settle out of air and land on surfaces, within 10-15 feet of the source. Influenza is one of those "large" molecules. If I'm standing up here coughing out influenza, and you're in the first two rows, you're screwed. But, if you're in the back of the room, you're OK, just don't come up and touch me. And, from everything I've read to date, there's no way to configure these diffusers to protect you guys in the front row.

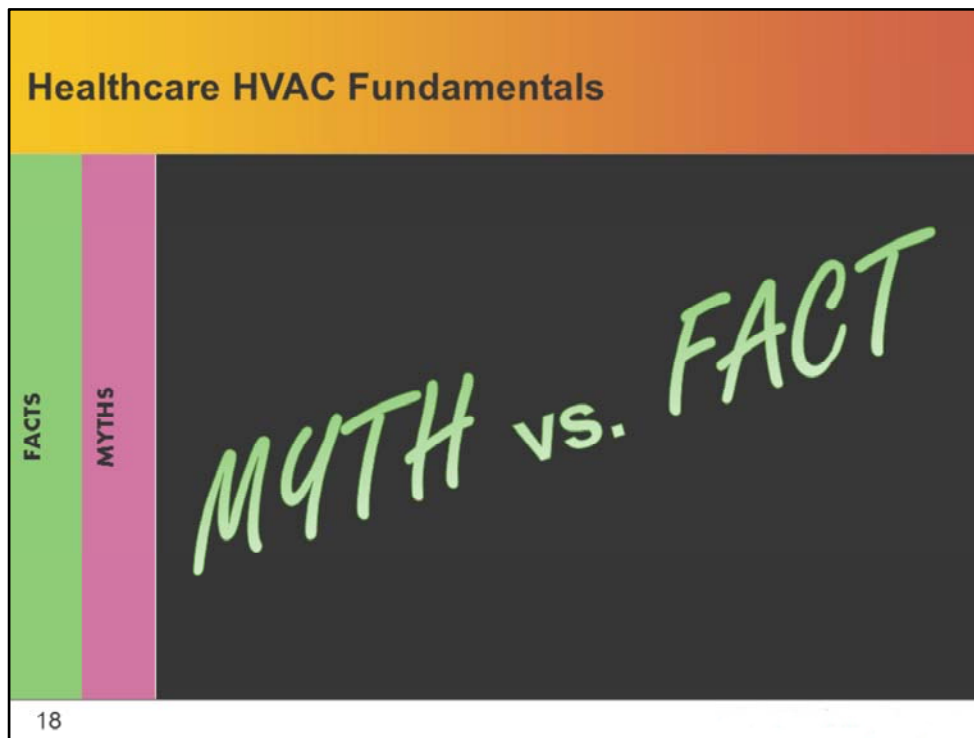

Now, let's review some of the myths. I need to want to introduce this list by saying that I believed just about all of these, three or four years ago.

## Myth 1: Hospital ventilation is “normal ventilation”

MYTHS

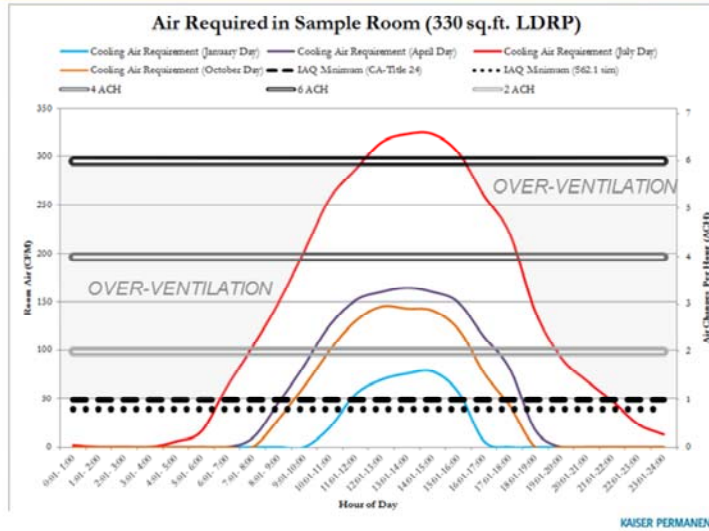

19

The ventilation rates we use are “normal”. That might be true, if you were using water source heat pumps or fan coils. But, over 85% of hospitals have central air systems. So, these rates are minimums – you use them every hour of the year. We over-ventilating most of our spaces most of the time. And, our outside air rates are much higher than everyone else’s.

## Myth 2: 100% Outside Air / 100% Exhaust Air

MYTHS

See ASHRAE  
Research Project  
(RP) 312, 1986

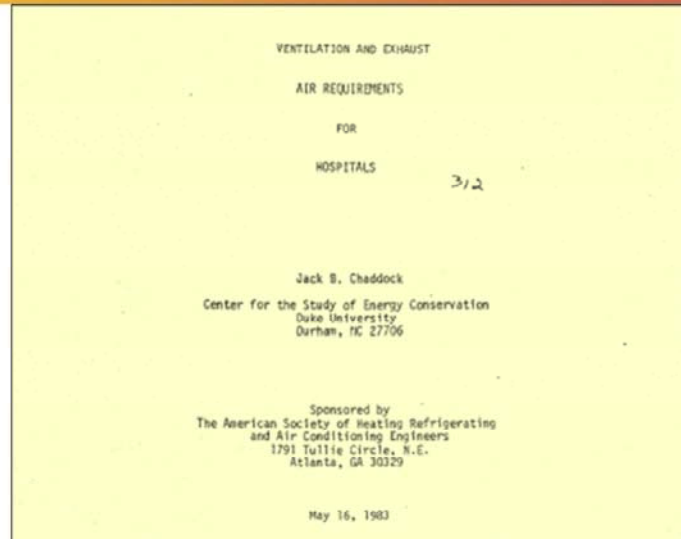

20

100% outside air, or 100% exhaust. In the US, this is less popular. It's very popular in England. I've had British engineers tell me they would never do return air in a hospital. So, we sometimes hear it in the US- someone will say "its better" to use 100% OA. But, lots of modern US hospitals use return air; it's totally fine. There was research on this topic in the 1980s. It pretty well debunked this one.

### Myth 3: Every space needs airborne protection

MYTHS



#### “Truly Airborne”

- Tuberculosis (Wells, 1934)
- Smallpox
- Chickenpox (varicella-zoster)
- Measles
- Mumps
- Rubella

KAISER PERMANENTE. thrive

21

All spaces need to protect against airborne diseases. Not true. Today, we have isolation rooms. Those really became standard practice in the 1990s, by the way. Also, 5 years ago, I would have guessed there were hundreds, or thousands, of airborne diseases. It turns out, and I mentioned before, there's only a few (quote) "truly airborne" diseases: tuberculosis, smallpox, chickenpox, measles, mumps, and rubella. I've already had chickenpox, and I have all my immunizations. So, the only one I'm susceptible to is TB. There's 10,000 cases of TB in the US every year. Now, sometimes we hear someone say something like "the next, undiscovered, airborne pandemic disease could walk into your building tomorrow". And, that statement is true. But, it's true with a probability of 1 times ten to the minus 10 or so. So, when you're doing risk management for very low probability events, you have to be careful about spending money. If you bet \$1 on that, you're going to lose that \$1 ten billion times before you get a hit. At our Fontana hospital, we have a pandemic contingency plan. There is a portion of the parking lot designated for the CDC to set up their tents. And, the annual cost of that is about right. (Gesture zero)

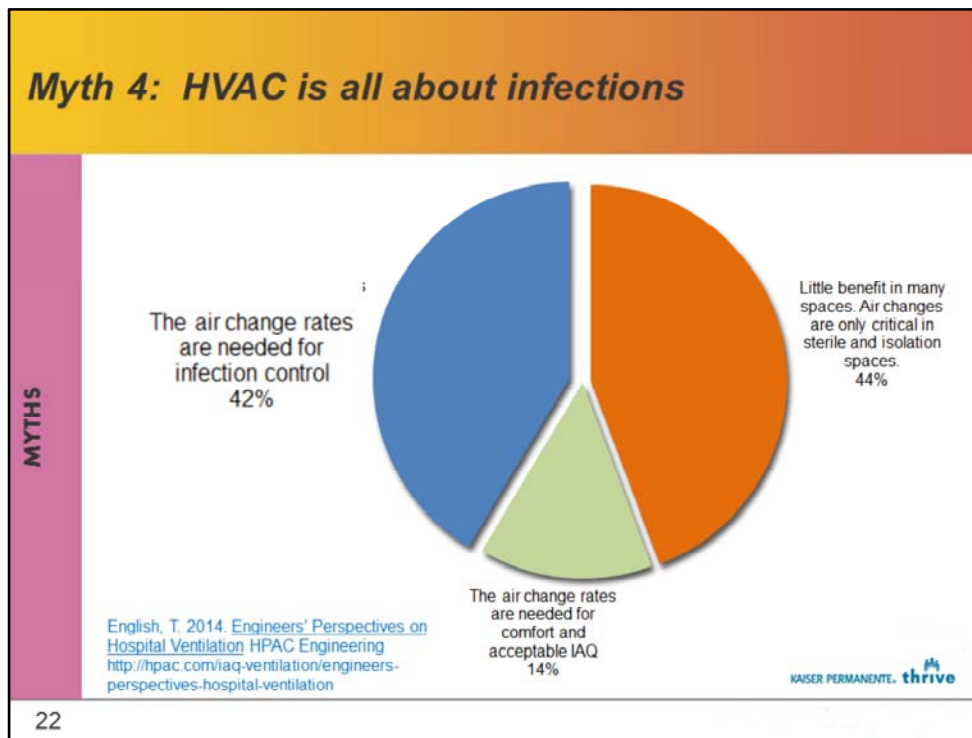

Everything we do in hospital HVAC is related to infections. Is anyone in here a hospital design engineer? This idea is popular among HVAC engineers, but not everyone else. We did this survey in 2013 of HVAC design engineers. About 40% said the reason we use air changes is to prevent infections. I believe that comes from good intentions by us HVAC people. It also comes from repetition: about 3 times a year, there's an article in the HVAC trade journals about health care HVAC. And it open with a paragraph about Hospital Acquired Infections (HAI).

## Myth 4: HVAC is all about infections

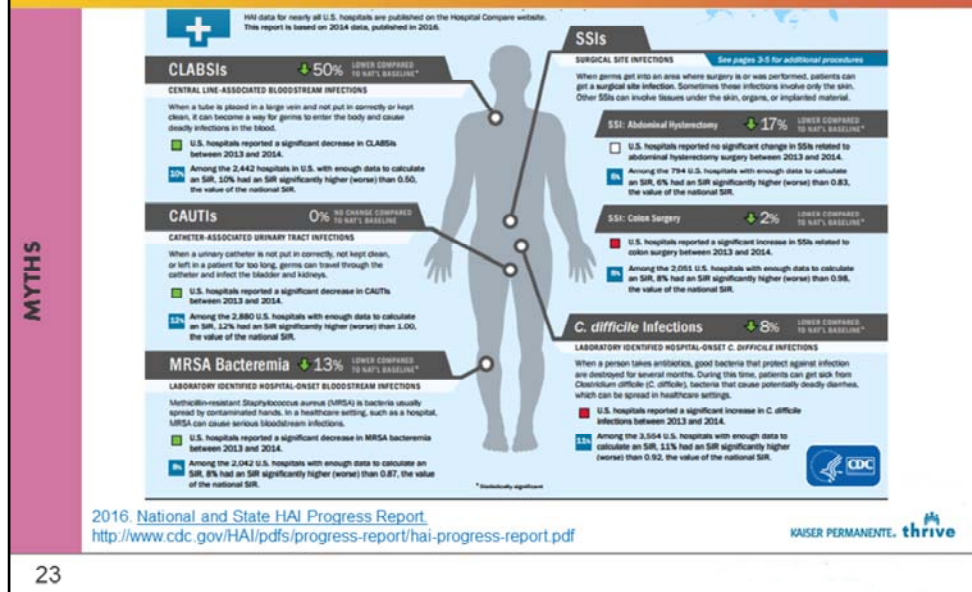

Now, if you ask someone who's not an HVAC engineer, like an epidemiologist, "what are the Top5 ways to prevent a catheter infection", HVAC won't be in the Top 5. For Surgical site infections (SSI). Sure. We already talked about that. But, for these other major categories of infections – bloodstream infections, catheter infections, MERSA or C.Dif – HVAC isn't in the Top 5, or the Top 10. In fact, and don't let this hurt your ego, HVAC doesn't even make the top 50 things to do to prevent a catheter infection. It really doesn't make the list at all.

## Myth 5: Temperature and Humidity “Perfection”

MYTHS

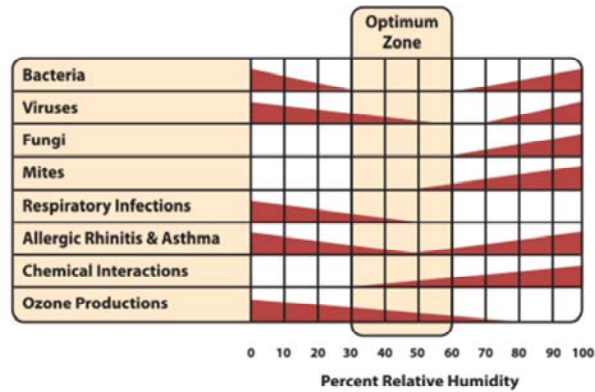

See: Sterling et al. 1985

KAISER PERMANENTE. thrive

24

Temperatures, humidity, and bacterial growth. True story: We had an inspector visit a facility on a low humidity morning. She found spaces below the code range. She declared it a threat to life, and issued a 24 hour notice to correct, or else shut down that part of the facility. Most of us, on my side of table, felt that was extreme. But, I can also totally empathize with her. Again, read the HVAC trade literature of the last 10 years. We say over and over and over how important humidity is. And, there's some truth to this. This graphic is called "Sterling chart". Has everyone seen this before? You can find it in the sales literature of every humidifier manufacturer, everywhere. And, look, if you have 80% humidity in your building for a 6 months, you've got risks! But, if you're humidity falls from 30% to 25% for a couple days, is that a threat to life? There's really no evidence to support that.



## Myth 6: Filters, Filters, Filters

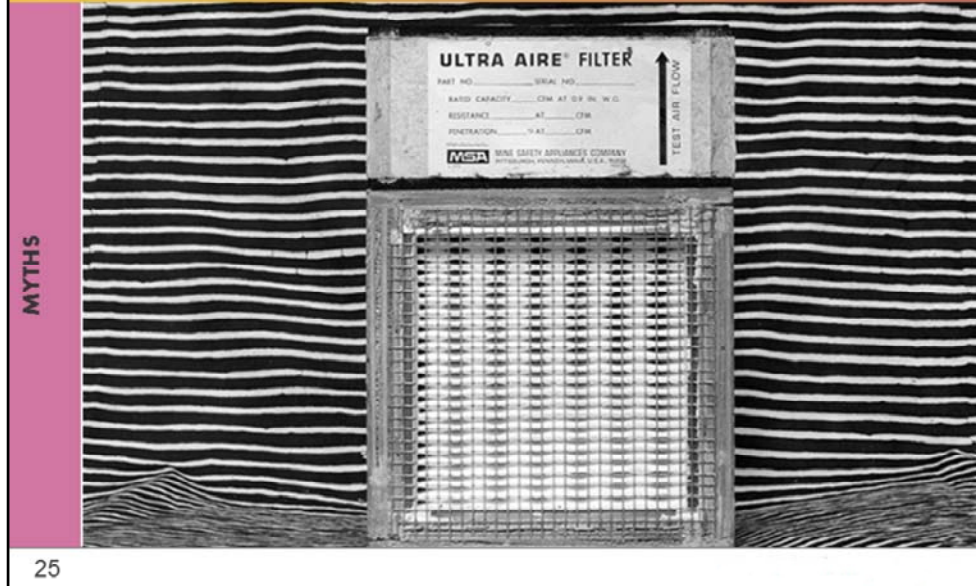

Filters, Filters, Everywhere! 50 years ago, most hospitals had operable windows and natural ventilation. In a lot of the world today, that's still very common. We started using filters in the '60s as they became available.

## Myth: Filters, Filters, Filters

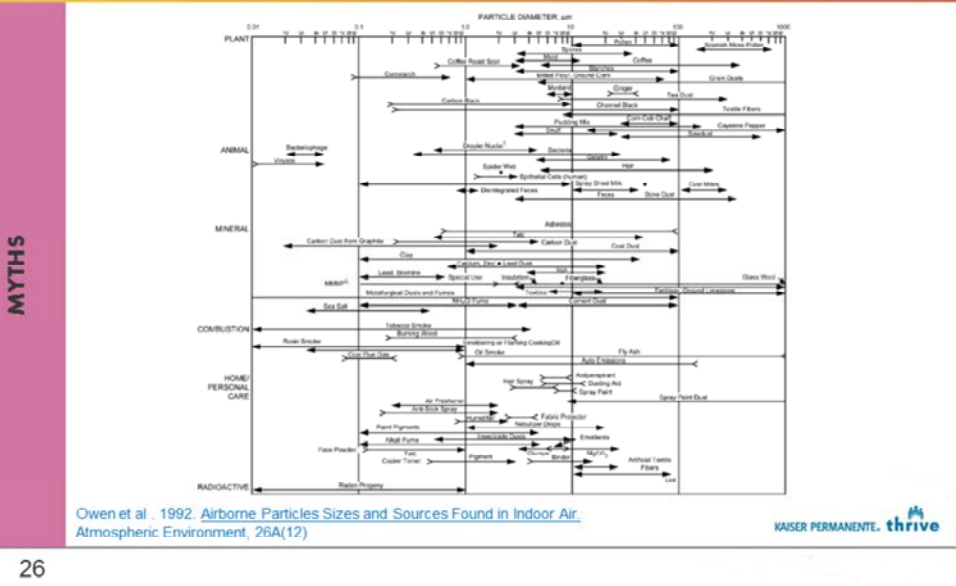

And, we keep learning more and more about what's in our air, outside and inside. But, when I look at this graphic, I'm thinking oh my god, there's horrifying things in the air; Get it all out!! Or, for God's sake, don't go outside. And, that's kind of what's happened. Natural ventilation has gone away. And, we keep upping the game on filters. Now we use pre and final filters. When I did design, I always put pre and final filters in hospitals, right? In Europe, they think we're batty. They use natural ventilation every day. They put filters in their AC units, to protect the coil and all that. But, they don't insist on two stages of filters everywhere.

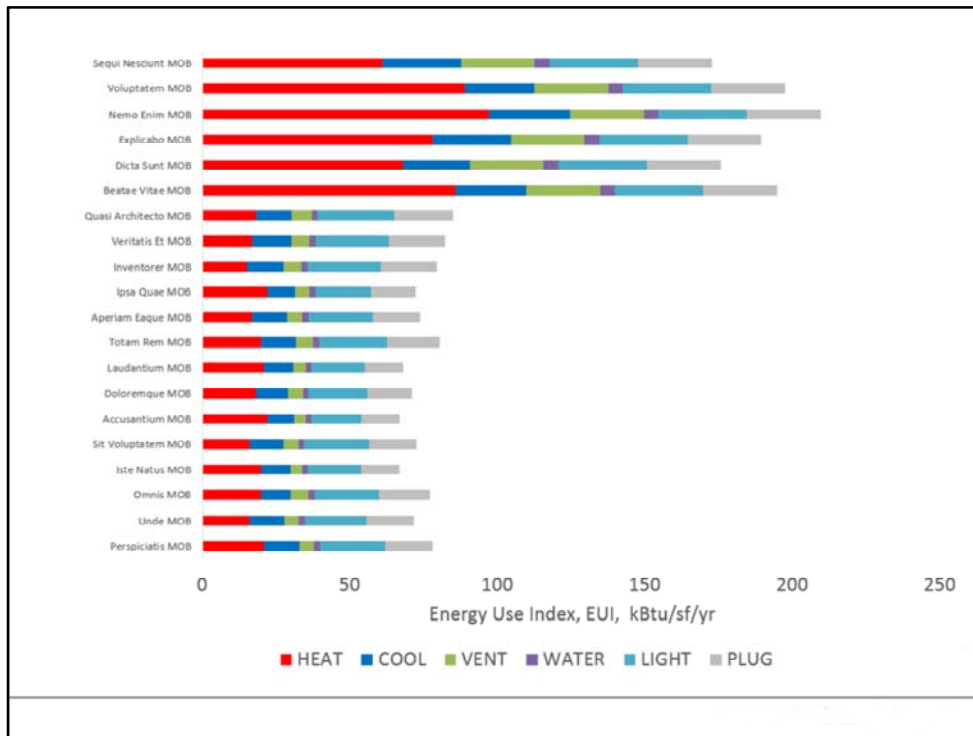

OK. Let's go back to energy. I want to talk about MOB's. These are all Kaiser MOB's. The names have been changed to protect the innocent. This is a sample. We have 200 MOB's, I'm only showing 20 here. But, look at the energy signatures. What you're seeing here is this group of MOB's that look a lot like office buildings, and this group that look a lot like hospitals. We found this phenomenon about 4 years ago. First we thought it might be certain departments or services. But, Nope. If you look at the asset reports for these facilities, you find the clue to what's going on.

You'd find (wait for it) Return ducts.

Confused?

Well, allow me to explain.

| TABLE 7.1 Design Parameters                        |   |                     |                   |   |   |                                 |                          |
|--|---|---------------------|-------------------|---|---|---------------------------------|--------------------------|
| Function of Space                                  | Pressure Relationship to Adjacent Areas (n) | Minimum Outdoor ach | Minimum Total ach | All Room Air Exhausted Directly to Outdoors (j) | Air Recirculated by Means of Room Units (a) | Design Relative Humidity (k), % | Design Temperature °F/°C |
| <b>SURGERY AND CRITICAL CARE</b>                   |   |                     |                   |   |   |                                 |                          |
| Operating room (Class B and C) (m), (n), (o)       | Positive                                    | 4                   | 20                | NR  | No  | 20-60                           | 68-75/20-24              |
| Operating/surgical cystoscopic rooms, (m), (n) (o) | Positive                                    | 4                   | 20                | NR  | No  | 20-60                           | 68-75/20-24              |
| Delivery room (Caesarean) (m), (n), (o)            | Positive                                    | 4                   | 20                | NR  | No  | 20-60                           | 68-75/20-24              |
| Substerile service area                            | NR  | 2                   | 6                 | NR  | No  | NR                              | NR                       |
| Recovery room                                      | NR  | 2                   | 6                 | NR  | No  | 20-60                           | 70-75/21-24              |
| Critical and intensive care                        | NR  | 2                   | 6                 | NR  | No  | 30-60                           | 70-75/21-24              |
| Intermediate care (s)                              | NR  | 2                   | 6                 | NR  | NR  | max 60                          | 70-75/21-24              |
| Wound intensive care (burn unit)                   | NR  | 2                   | 6                 | NR  | No  | 40-60                           | 70-75/21-24              |
| Newborn intensive care                             | Positive                                    | 2                   | 6                 | NR  | No  | 30-60                           | 72-78/22-26              |
| Treatment room (p)                                 | NR  | 2                   | 6                 | NR  | NR  | 20-60                           | 70-75/21-24              |
| Trauma room (crisis or shock) (c)                  | Positive                                    | 3                   | 15                | NR  | No  | 20-60                           | 70-75/21-24              |
| Medical/anesthesia gas storage (r)                 | Negative                                    | NR                  | 8                 | Yes   | NR  | NR                              | NR                       |
| Laser eye room                                     | Positive                                    | 3                   | 15                | NR  | No  | 20-60                           | 70-75/21-24              |
| ER waiting rooms                                   | Negative                                    | 2                   | 12                | Yes (q)   | NR  | max 65                          | 70-75/21-24              |
| Triage   | Negative                                    | 2                   | 12                | Yes (q)   | NR  | max 60                          | 70-75/21-24              |
| ER decontamination                                 | Negative                                    | 2                   | 12                | Yes   | No  | NR                              | NR                       |
| Radiology waiting rooms                            | Negative                                    | 2                   | 12                | Yes (q), (w)                                    | NR  | max 60                          | 70-75/21-24              |
| Procedure room (Class A surgery) (o), (d)          | Positive                                    | 3                   | 15                | NR  | No  | 20-60                           | 70-75/21-24              |
| Emergency department exam/treatment room (p)       | NR  | 2                   | 6                 | NR  | NR  | max 60                          | 70-75/21-24              |
| <b>INPATIENT NURSING</b>                           |   |                     |                   |   |   |                                 |                          |
| Patient room                                       | NR  | 2                   | 4 (y)             | NR  | NR  | max 60                          | 70-75/21-24              |
| Nourishment area or room                           | NR  | NR                  | 2                 | NR  | NR  | NR                              | NR                       |
| Toilet room  | Negative                                    | NR                  | 10                | Yes   | No  | NR                              | NR                       |

Note: NR = no requirement

When we design hospitals, we use this **air change table**. This is the national one, in California its Table 4-A. Its really big on air balance. It has specific air minimums, and pressure requirements for a lot of the rooms. To get that balance, you want return ducts.

But, when you do a commercial building, we don't do this. We balance the systems at peak supply, and you balance the exhaust. But, the system is more dynamic. And, when balance is dynamic, we use the space above the ceiling as a return plenum. That also saves money, BTW.

## Energy crisis

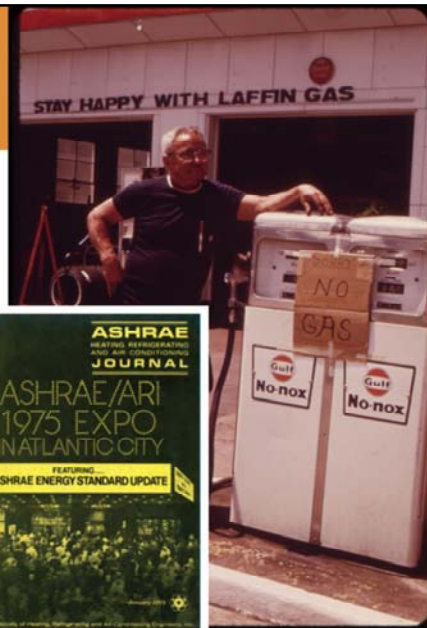

KAISER PERMANENTE. thrive

I'm going to circle back to that 1976 energy standard. See, prior to 1976, a lot of central systems were constant volume.

## Central System Energy (circa 1970)

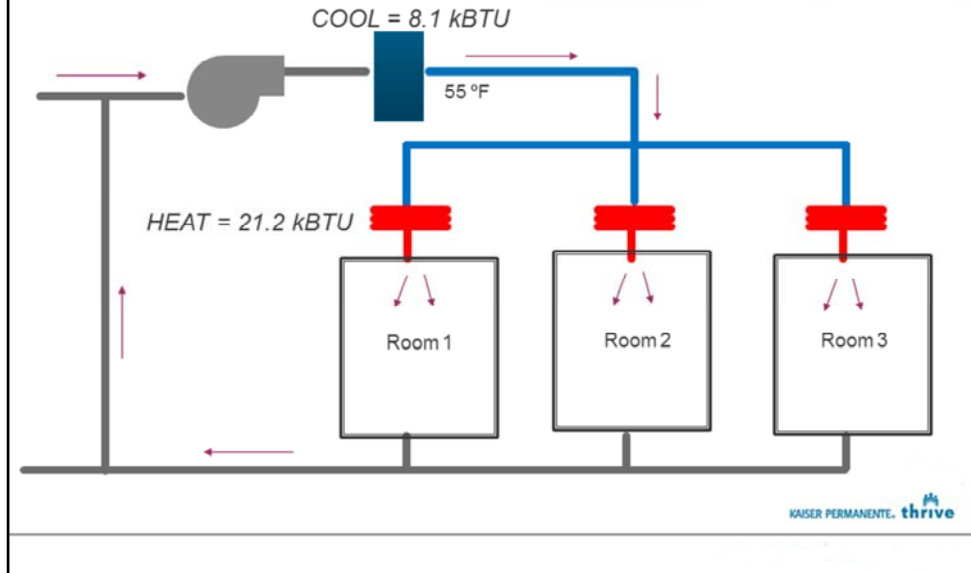

Here's that system. You have a central air system, over here, where you cool all the air down to a nice cold temperature. But, out in the rooms, here, you don't always need all that cold air. So, at each room, you put in a heating coil, to re-heat the air back up. We call that terminal reheat.

Now, this works. You balance all the air just right, and it works great! But, it happens to use a ton of energy. *Most of that heating energy has nothing to do with the temperature outside.*

## Central System Energy (post 1976)

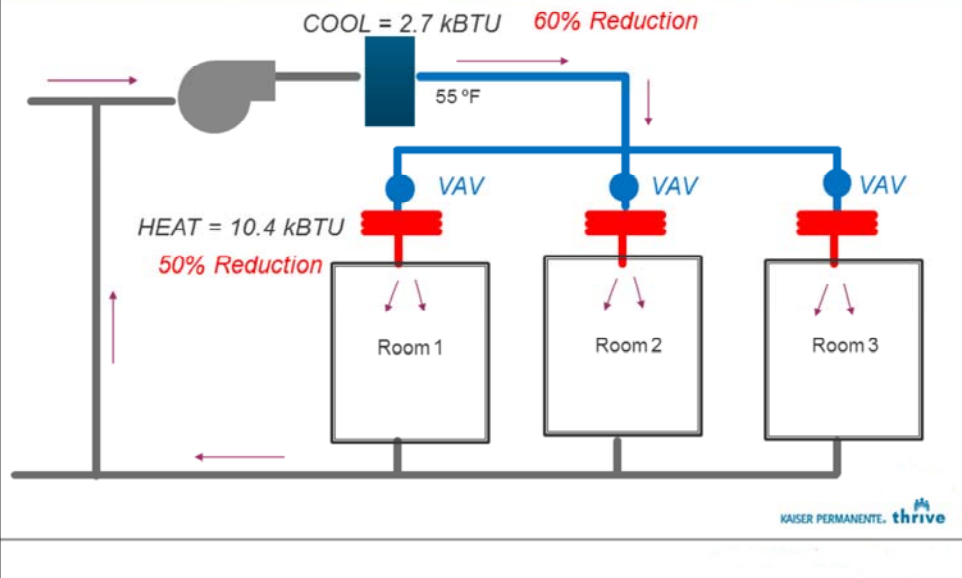

So the energy codes banned this practice. But, they banned it in a clever way. You had to add VAV controls. Reduce the air to 30% of the peak, prior to heating it. We call that “30% VAV”. In the modern energy codes, its more like 10% VAV.

## Central System Energy (typ. 1990s)

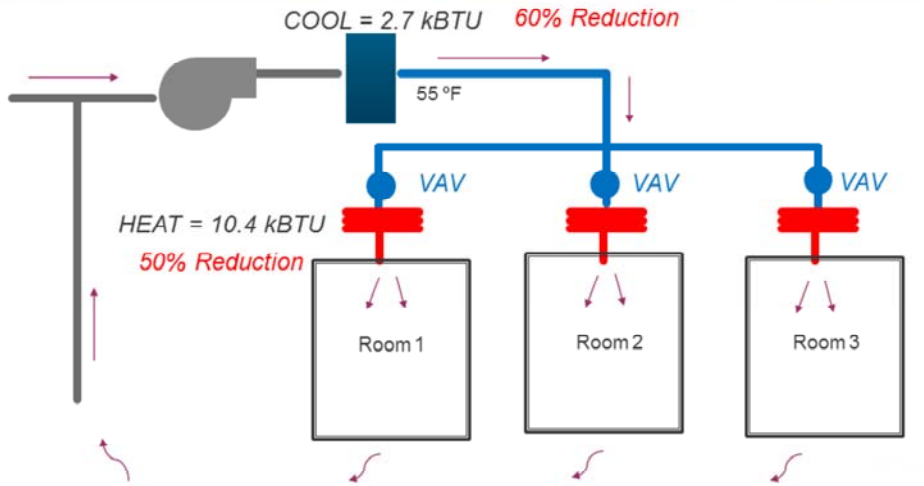

KAISER PERMANENTE. thrive

And, once you start doing VAV supply air, its real common to get rid of those return ducts, let the return air just float back to the system.



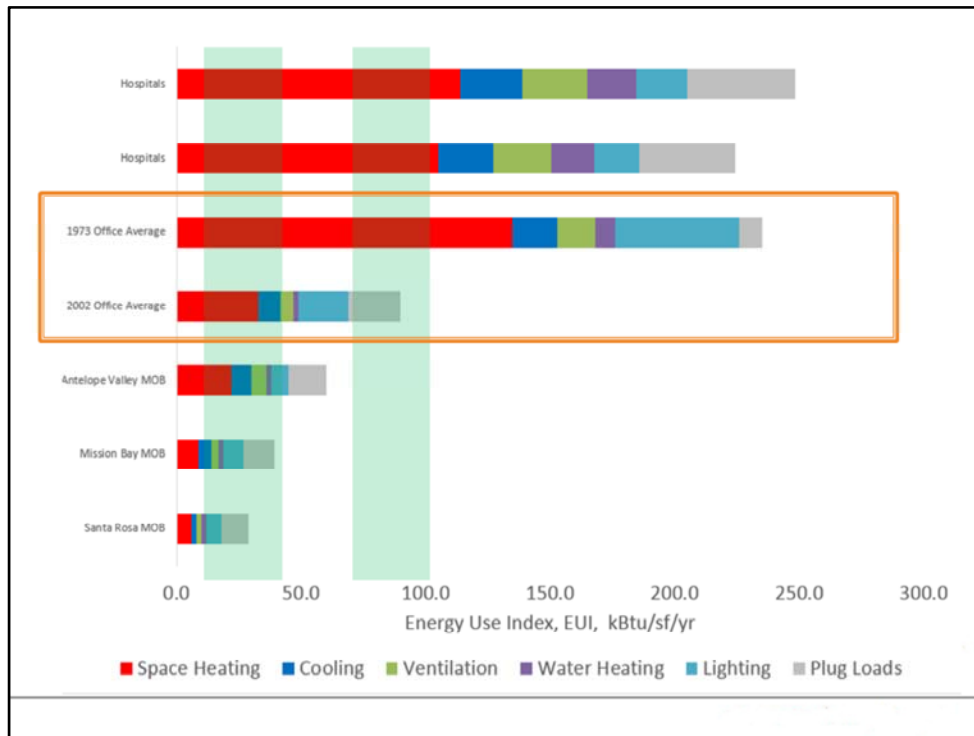

And, just to flash this slide back up - this worked. From the 1970s to today, we've seen that 60% reduction in energy. And, the biggest savings we've seen is heating energy.

But, hospital ventilation systems have always been exempted from the energy standards. We still use that terminal reheat system. Sometimes we use VAV, but its not 30% VAV. We only dial back the air about 20%. So, its more like 80% VAV.

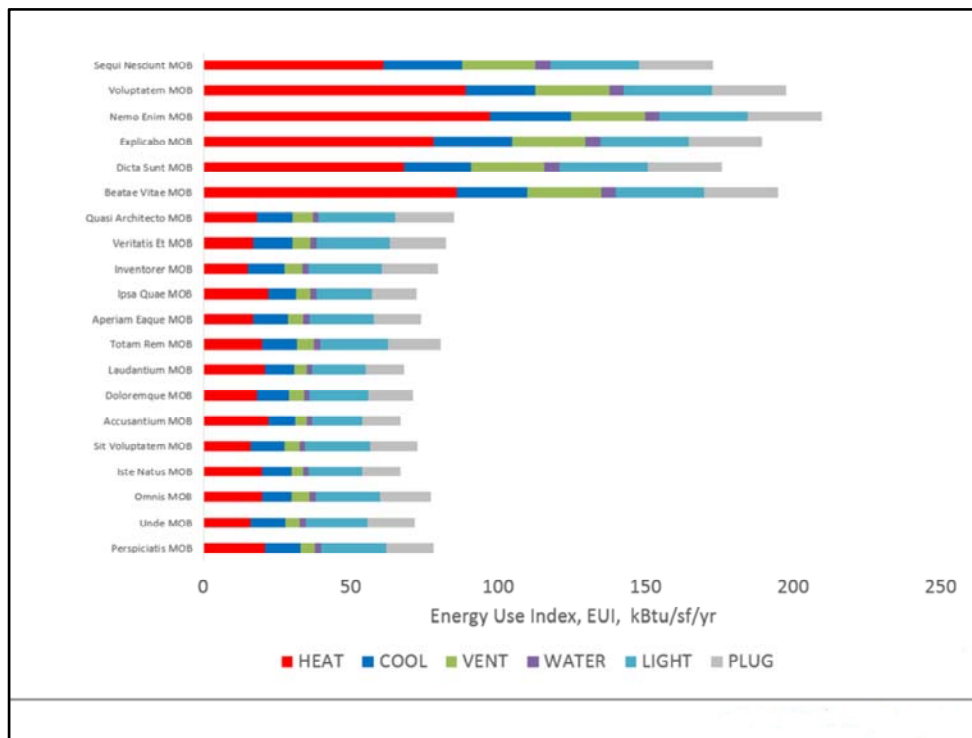

So, back to these MOB. Here's the story, as near as I can tell: The design engineers, here, followed the air change table. And, they kind of did the right thing. The national guidelines say you should use the air change table for all health care buildings.

The engineers down here weren't doing that. They used the codes and standards for commercial buildings.

These buildings cost less, and use less energy. These buildings cost more, and use more energy.

So, Is it worth it? Same services. Do we get better outcomes in these buildings? Or, conversely, is this ok? Do we get employee complaints in these?

And, the answer is: they're both fine. The people in the buildings don't know the difference.

There are engineers MOB who believe this is wrong. I know a consultant, works down the street from Kaiser Headquarters. Smart guy. Good engineer. You could call him today, and he'll tell you return air plenums are bad; "you can't balance the system, you can't maintain pressures"; he'll tell you disaster is imminent.

But, the moral of the story: If you want to save energy, don't use the air change table

## KP HVAC Standards (2012, 2015)

- Follow local laws and regulations
- Apply appropriate air controls in *Operating Spaces* or *Isolation Spaces*
- Apply Standards of Care for Indoor Air Quality (IAQ) and Comfort
  - ANSI/ASHRAE 62.1, OSHA, NIOSH, ANSI/ASHRAE 55
  - IMC: 15-25 cfm per person
  - Energy Codes: 30% Minimum VAV for Reheat

KAISER PERMANENTE. thrive

We made this an official decision. Our architects and engineers are not to use the air change table unless they are specifically required to by law.

I remember the first engineer who was really uncomfortable with this. My engineering team reviews energy models on our projects. And, it stands out like a sore thumb. You take one look at the energy model... “he’s using air changes”. So, my guy tells this guy, “take out the air changes and re-run the model”. And, this engineer said “no”. He goes: “Listen, those air changes are standard of care. I can’t ignore those, that’d be unethical”. So, our project manager calls me, pissed off, says: listen, gimme a recommendation for a new engineer out here; I gotta fire this guy. And, its gonna cost me a month of my schedule.

Hold on. (Motion) We got on the phone with this engineer. We finally struck a deal. I told him, listen, I’ll send you a letter on our letterhead, with my signature, specifically telling you “use the other code”. Now, I don’t know if that guy ever got comfortable with the idea. But, I do know he got to finish the project.

We’ve had that discussion, three or four times, with engineers and architects.

| TABLE 7.1 Design Parameters                        |   |                     |                   |   |   |                                 |                          |
|--|---|---------------------|-------------------|---|---|---------------------------------|--------------------------|
| Function of Space                                  | Pressure Relationship to Adjacent Areas (n) | Minimum Outdoor ach | Minimum Total ach | All Room Air Exhausted Directly to Outdoors (j) | Air Recirculated by Means of Room Units (a) | Design Relative Humidity (k), % | Design Temperature °F/°C |
| <b>SURGERY AND CRITICAL CARE</b>                   |   |                     |                   |   |   |                                 |                          |
| Operating room (Class B and C) (m), (n), (o)       | Positive                                    | 4                   | 20                | NR  | No  | 20-60                           | 68-75/20-24              |
| Operating/surgical cystoscopic rooms, (m), (n) (o) | Positive                                    | 4                   | 20                | NR  | No  | 20-60                           | 68-75/20-24              |
| Delivery room (Caesarean) (m), (n), (o)            | Positive                                    | 4                   | 20                | NR  | No  | 20-60                           | 68-75/20-24              |
| Substerile service area                            | NR  | 2                   | 6                 | NR  | No  | NR                              | NR                       |
| Recovery room                                      | NR  | 2                   | 6                 | NR  | No  | 20-60                           | 70-75/21-24              |
| Critical and intensive care                        | NR  | 2                   | 6                 | NR  | No  | 30-60                           | 70-75/21-24              |
| Intermediate care (s)                              | NR  | 2                   | 6                 | NR  | NR  | max 60                          | 70-75/21-24              |
| Wound intensive care (burn unit)                   | NR  | 2                   | 6                 | NR  | No  | 40-60                           | 70-75/21-24              |
| Newborn intensive care                             | Positive                                    | 2                   | 6                 | NR  | No  | 30-60                           | 72-78/22-26              |
| Treatment room (p)                                 | NR  | 2                   | 6                 | NR  | NR  | 20-60                           | 70-75/21-24              |
| Trauma room (crisis or shock) (c)                  | Positive                                    | 3                   | 15                | NR  | No  | 20-60                           | 70-75/21-24              |
| Medical/anesthesia gas storage (r)                 | Negative                                    | NR                  | 8                 | Yes   | NR  | NR                              | NR                       |
| Laser eye room                                     | Positive                                    | 3                   | 15                | NR  | No  | 20-60                           | 70-75/21-24              |
| ER waiting rooms                                   | Negative                                    | 2                   | 12                | Yes (q)   | NR  | max 65                          | 70-75/21-24              |
| Triage   | Negative                                    | 2                   | 12                | Yes (q)   | NR  | max 60                          | 70-75/21-24              |
| ER decontamination                                 | Negative                                    | 2                   | 12                | Yes   | No  | NR                              | NR                       |
| Radiology waiting rooms                            | Negative                                    | 2                   | 12                | Yes (q), (w)                                    | NR  | max 60                          | 70-75/21-24              |
| Procedure room (Class A surgery) (o), (d)          | Positive                                    | 3                   | 15                | NR  | No  | 20-60                           | 70-75/21-24              |
| Emergency department exam/treatment room (p)       | NR  | 2                   | 6                 | NR  | NR  | max 60                          | 70-75/21-24              |
| <b>INPATIENT NURSING</b>                           |   |                     |                   |   |   |                                 |                          |
| Patient room                                       | NR  | 2                   | 4 (y)             | NR  | NR  | max 60                          | 70-75/21-24              |
| Nourishment area or room                           | NR  | NR                  | 2                 | NR  | NR  | NR                              | NR                       |
| Toilet room  | Negative                                    | NR                  | 10                | Yes   | No  | NR                              | NR                       |

Note: NR = no requirement

But, what about hospitals? Can we stop using air changes there, too??

Well. No. No. Because it's the law. In our buildings and in our practice, first and foremost, we will obey the law. But, I'm talking longer term here. I'm talking about changing the law.

Towards the end of 2013, I started researching like crazy. I pulled materials from our clinical library, I went the university library, I pored through the scientific databases. I put together this 20-page paper. My wife called it my "manifesto". I sent a draft of it to our regional director of infection control and quality. She reads it for me. I drive up to Pasadena and meet with her. And, I told her: "listen, I'm scared. What I see here is like the emperor isn't wearing any clothes. If I'm wrong, you need to tell me." And, we talked it over, she kind of smiled and said "You Go get 'em, Kiddo!" She called me "kiddo". I remember that.

**TABLE 7.1 Design Parameters**

| Function of Space                                  | Pressure Relationship to Adjacent Areas (n) | Minimum Outdoor ach | Minimum Total ach | All Room Air Exhausted Directly to Outdoors (j) | Air Recirculated by Means of Room Units (a) | Design Relative Humidity (k), % | Design Temperature °F/°C |
|--|---|---------------------|-------------------|---|---|---------------------------------|--------------------------|
| <b>SURGERY AND CRITICAL CARE</b>                   |   |                     |                   |   |   |                                 |                          |
| Operating room (Class B and C) (m), (n), (o)       | Positive                                    | 4                   | 20                | NR  | No  | 20-60                           | 68-75/20-24              |
| Operating/surgical cystoscopic rooms, (m), (n) (o) | Positive                                    | 4                   | 20                | NR  | No  | 20-60                           | 68-75/20-24              |
| Delivery room (Caesarean) (m), (n), (o)            | Positive                                    | 4                   | 20                | NR  | No  | 20-60                           | 68-75/20-24              |
| Substerile service area                            | NR  | 2                   | 6                 | NR  | No  | NR                              | NR                       |
| Recovery room                                      | NR  | 2                   | 6                 | NR  | No  | 20-60                           | 70-75/21-24              |
| Critical and intensive care                        | NR  | 2                   | 6                 | NR  | No  | 30-60                           | 70-75/21-24              |
| Intermediate care (s)                              | NR  | 2                   | 6                 | NR  | NR  | max 60                          | 70-75/21-24              |
| Wound intensive care (burn unit)                   | NR  | 2                   | 6                 | NR  | No  | 40-60                           | 70-75/21-24              |
| Newborn intensive care                             | Positive                                    | 2                   | 6                 | NR  | No  | 30-60                           | 72-78/22-26              |
| Treatment room (p)                                 | NR  | 2                   | 6                 | NR  | NR  | 20-60                           | 70-75/21-24              |
| Trauma room (crisis or shock) (c)                  | Positive                                    | 3                   | 15                | NR  | No  | 20-60                           | 70-75/21-24              |
| Medical/anesthesia gas storage (r)                 | Negative                                    | NR                  | 8                 | Yes   | NR  | NR                              | NR                       |
| Laser eye room                                     | Positive                                    | 3                   | 15                | NR  | No  | 20-60                           | 70-75/21-24              |
| ER waiting rooms                                   | Negative                                    | 2                   | 12                | Yes (q)   | NR  | max 65                          | 70-75/21-24              |
| Triage   | Negative                                    | 2                   | 12                | Yes (q)   | NR  | max 60                          | 70-75/21-24              |
| ER decontamination                                 | Negative                                    | 2                   | 12                | Yes   | No  | NR                              | NR                       |
| Radiology waiting rooms                            | Negative                                    | 2                   | 12                | Yes (q), (w)                                    | NR  | max 60                          | 70-75/21-24              |
| Procedure room (Class A surgery) (o), (d)          | Positive                                    | 3                   | 15                | NR  | No  | 20-60                           | 70-75/21-24              |
| Emergency department exam/treatment room (p)       | NR  | 2                   | 6                 | NR  | NR  | max 60                          | 70-75/21-24              |
| <b>INPATIENT NURSING</b>                           |   |                     |                   |   |   |                                 |                          |
| Patient room                                       | NR  | 2                   | 4 (y)             | NR  | NR  | max 60                          | 70-75/21-24              |
| Nourishment area or room                           | NR  | NR                  | 2                 | NR  | NR  | NR                              | NR                       |
| Toilet room  | Negative                                    | NR                  | 10                | Yes   | No  | NR                              | NR                       |

Note: NR = no requirement

I'm going to tell you a story from that research. We have this number, 2 ACH. It's the most common number in the table. It's our outside air ventilation number. We use it for most spaces.

I tracked this number through history. It was in the code in the 1970s, it was there in the 60s. I found it in the 40s. the 20s, and the 1910s. I kept going back.

And, finally, the earliest reference I found is this one....

## 2 Air Changes Per Hour

- Nightingale, 1859<sup>[1]</sup>
- Muir, 1877<sup>[2]</sup> *"Twice per hour"*
- 1879 – Thomas Edison, 'first light bulb'
- Billings, 1893<sup>[3]</sup>

[1] Nightingale, F. 1859. Notes on Hospitals, 1st Edition, London: John W. Parker & Son

[2] Muir, W. 1877. "Report of the Army Medical Department for the Year 1877, Volume XIX," Her Majesty's Stationary Office., London

[3] Billings, J. 1893. Ventilation and Heating The Engineering Record, New York



It comes from the 1870s.

So, I call 2 ACH "the horse and buggy number". It predates the light bulb, the car, for sure, and most of the railroads.

Let me tell what it was like to be in hospital prior to the 1870s. Patients were in wards, often unventilated, lit by candles or oil burning lamps. They did not bathe often. They didn't have bathrooms. You'd do your business in a bedpan, put it under your bed, and wait for nurse to come around and empty the bedpans. So wards had this horrible smell and hygiene problem. Famously pointed out by Florence Nightingale. So, starting in 1870s and 1880s, architects started putting in ventilation. They put in enough window area to (and I quote) "exchange the volume of air twice per hour". So, you'll find that number, 2 ACH, in the architectural literature of 140 years ago. We're still using it today.

(Pause).

I'm going to repeat that. You'll find that number, 2 ACH, in the architectural literature of 140 years ago. We're still using it today.

## Indoor Air Quality

ventilation rate procedure (VRP) *occupant types, and categories of occupant contamination* accounting for occupant diversity CLASSIFYING SPACES BY PROCESS CONTAMINATION ventilation effectiveness of different diffuser types in heating and cooling condition TABULATED OUTDOOR AIR RATES PER PERSON *tabulated outdoor air rates per area* assigning system ventilation effectiveness based on outdoor air percentage *minimum outdoor air quality assessment* air treatment for non-compliant outdoor air INDOOR AIR QUALITY DEFINITIONS TLV threshold limit values PEL personal exposure limits OEL occupational exposure limits odor control EXHAUST AIR *minimum ventilation* multiple space process *natural ventilation procedure* indoor air quality procedure VARIABLE OCCUPANCY CONDITIONS exhaust and outdoor air separation performance

KAISER PERMANENTE. thrive

Look. We can do better than this. My people. HVAC engineers. We can do better than this. Because, while we've been using this number for the last 140 years, HVAC engineering has made tons of progress.

In ventilation, we have the ventilation rate procedure, we're on like the third iteration. We have design tools for different occupant types, occupant diversity, and different contamination sources. We know how ventilation effectiveness varies for different diffuser types, different seasons, and different system fractions. We've got TLVs PELs OELs. We have target concentration values for thousands of individual chemicals in air.

That's 50 years of knowledge. None of that is in the 2 ACH number.



# Indoor Air Quality

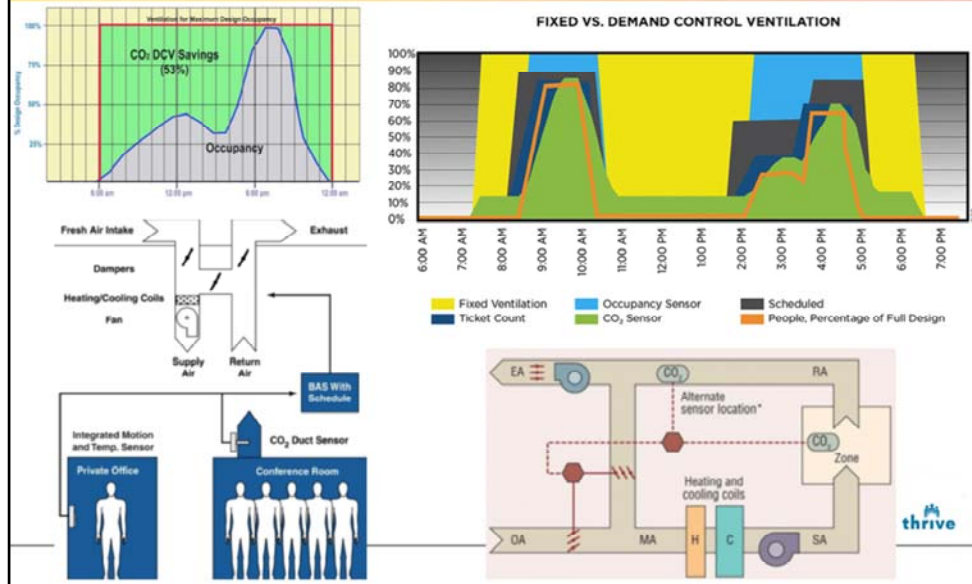

We've had demand control ventilation (DCV) technology for 20 years. We can measure air quality by proxy, and put ventilation where its needed, and when its needed. We do this in classrooms, dining rooms, and meeting rooms. Every movie theatre built in California since 2001 uses this technology. And, its not just CO<sub>2</sub>. Our new lab building has a multi-variable, real-time air quality control system. It controls contaminant levels in the building, and it also modulates the exhaust discharge, based on the wind speed. It's amazing.

In hospitals, this is literally illegal.

# Comfort according to PPD / PMV

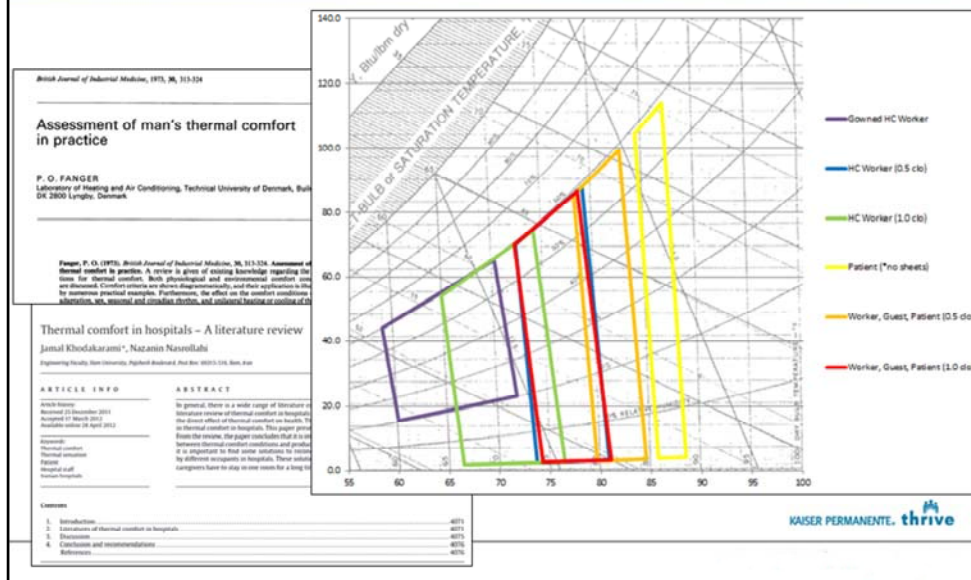

Comfort has been a big area of research in the last 40 years. Fanger set up the model in the 70's. But, since the green buildings movement took off, there have been hundreds - thousands - of thermal comfort studies, including in hospitals. Today, we have an algorithm to predicts the "percent of people dissatisfied" and the "predicted mean vote" of a population. We call it PPD/PMV. We've more-or-less standardized the comfort survey process. So, when researchers collect survey comfort, they can compare it to the all the other studies.

# Human Thermal Comfort

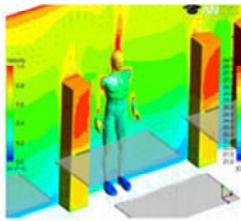
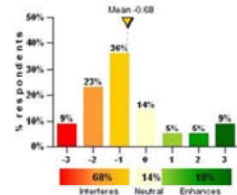

CBE Thermal Comfort Tool

ASHRAE-55 EN 15251 Compare Ranges Upload

Select method: Pkwy method

✓ Complies with ASHRAE Standard 55-2013

Air temperature: 25 °C  
 Use operative temperature:

Mean radiant temperature: 25 °C

Air speed: 0.1 m/s  
 Local air speed control:

Humidity: 50 %  
 Relative humidity:

Metabolic rate: 1.1 met  
 Typing: 1.1

Clothing level: 0.5 clo  
 Typical summer jacket:

Create custom assembly  
 Dynamic predictive clothing  
 LEED documentation

Global temp: Indoor Cal Specify SI Local ?  
 pressure: DP discomfort help

PPD: 5%  
 Sensation: Neutral  
 SET: 24.0°C

Psychrometric chart (air temperature)

NOTE: In this psychrometric chart the abscissa is the dry-bulb temperature, and the mean radiant temperature (MRT) is fixed, combined by the equation. Each point on the chart has the same PMV, which defines the comfort zone boundary. In this way you can see how changes in MRT affect thermal comfort. You can also still use the operative temperature button, and each point will have the same SET.

Web based tool:  
<http://comfort.cbe.berkeley.edu/>

KAISER PERMANENTE thrive

That survey form is used internationally. So, we're seeing correlated data on thermal comfort from all over the world. Then, we've incorporated those algorithms into CFD modeling tools. So, we can do comfort predictions, during design, in virtual buildings.

Then, my favorite is the web-tool. It works in a standard browser window. So, I've sat there and run comfort scenarios on my iPad on an airplane. But, in health care, we don't use any of this.

| TABLE 7.1 Design Parameters                        |   |                     |                   |   |   |                                 |                          |
|--|---|---------------------|-------------------|---|---|---------------------------------|--------------------------|
| Function of Space                                  | Pressure Relationship to Adjacent Areas (n) | Minimum Outdoor ach | Minimum Total ach | All Room Air Exhausted Directly to Outdoors (j) | Air Recirculated by Means of Room Units (a) | Design Relative Humidity (k), % | Design Temperature °F/°C |
| <b>SURGERY AND CRITICAL CARE</b>                   |   |                     |                   |   |   |                                 |                          |
| Operating room (Class B and C) (m), (n), (o)       | Positive                                    | 4                   | 20                | NR  | No  | 20-60                           | 68-75/20-24              |
| Operating/surgical cystoscopic rooms, (m), (n) (o) | Positive                                    | 4                   | 20                | NR  | No  | 20-60                           | 68-75/20-24              |
| Delivery room (Caesarean) (m), (n), (o)            | Positive                                    | 4                   | 20                | NR  | No  | 20-60                           | 68-75/20-24              |
| Substerile service area                            | NR  | 2                   | 6                 | NR  | No  | NR                              | NR                       |
| Recovery room                                      | NR  | 2                   | 6                 | NR  | No  | 20-60                           | 70-75/21-24              |
| Critical and intensive care                        | NR  | 2                   | 6                 | NR  | No  | 30-60                           | 70-75/21-24              |
| Intermediate care (s)                              | NR  | 2                   | 6                 | NR  | NR  | max 60                          | 70-75/21-24              |
| Wound intensive care (burn unit)                   | NR  | 2                   | 6                 | NR  | No  | 40-60                           | 70-75/21-24              |
| Newborn intensive care                             | Positive                                    | 2                   | 6                 | NR  | No  | 30-60                           | 72-78/22-26              |
| Treatment room (p)                                 | NR  | 2                   | 6                 | NR  | NR  | 20-60                           | 70-75/21-24              |
| Trauma room (crisis or shock) (c)                  | Positive                                    | 3                   | 15                | NR  | No  | 20-60                           | 70-75/21-24              |
| Medical/anesthesia gas storage (r)                 | Negative                                    | NR                  | 8                 | Yes   | NR  | NR                              | NR                       |
| Laser eye room                                     | Positive                                    | 3                   | 15                | NR  | No  | 20-60                           | 70-75/21-24              |
| ER waiting rooms                                   | Negative                                    | 2                   | 12                | Yes (q)   | NR  | max 65                          | 70-75/21-24              |
| Triage   | Negative                                    | 2                   | 12                | Yes (q)   | NR  | max 60                          | 70-75/21-24              |
| ER decontamination                                 | Negative                                    | 2                   | 12                | Yes   | No  | NR                              | NR                       |
| Radiology waiting rooms                            | Negative                                    | 2                   | 12                | Yes (q), (w)                                    | NR  | max 60                          | 70-75/21-24              |
| Procedure room (Class A surgery) (o), (d)          | Positive                                    | 3                   | 15                | NR  | No  | 20-60                           | 70-75/21-24              |
| Emergency department exam/treatment room (p)       | NR  | 2                   | 6                 | NR  | NR  | max 60                          | 70-75/21-24              |
| <b>INPATIENT NURSING</b>                           |   |                     |                   |   |   |                                 |                          |
| Patient room                                       | NR  | 2                   | 4 (y)             | NR  | NR  | max 60                          | 70-75/21-24              |
| Nourishment area or room                           | NR  | NR                  | 2                 | NR  | NR  | NR                              | NR                       |
| Toilet room  | Negative                                    | NR                  | 10                | Yes   | No  | NR                              | NR                       |

Note: NR = no requirement

Instead, we have a table of temperatures, that we wrote into the code 40 years ago, before any of the research was done. And, no. They don't match. I checked.

My thing is: We literally don't need this table. We have a whole modern design toolkit for HVAC, and we're using this instead.

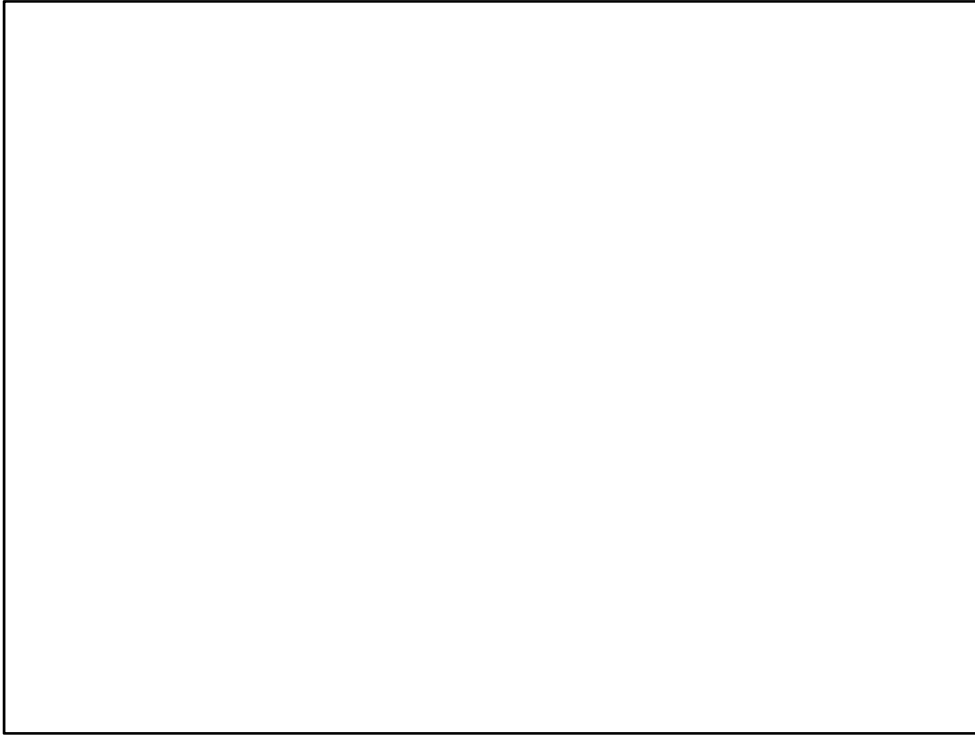

Hospital HVAC engineers: Imagine that this table were gone - tomorrow. Not only gone from the code, but all previous versions erased.



And, I come to you tomorrow. And, I want to hire you for this project. It's a patient floor. Staff's in the middle. There's an isolation room up in the corner. Without that table, could you design an HVAC system to keep these spaces comfortable, control odors, have good air quality, and keep the air in that isolation room separated?

Yea. Of course you could.

Could you also make it low energy? net zero? I think you could.

| TABLE 7.1 Design Parameters                        |   |                     |                   |   |   |                                 |                          |
|--|---|---------------------|-------------------|---|---|---------------------------------|--------------------------|
| Function of Space                                  | Pressure Relationship to Adjacent Areas (n) | Minimum Outdoor ach | Minimum Total ach | All Room Air Exhausted Directly to Outdoors (j) | Air Recirculated by Means of Room Units (a) | Design Relative Humidity (k), % | Design Temperature °F/°C |
| <b>SURGERY AND CRITICAL CARE</b>                   |   |                     |                   |   |   |                                 |                          |
| Operating room (Class B and C) (m), (n), (o)       | Positive                                    | 4                   | 20                | NR  | No  | 20-60                           | 68-75/20-24              |
| Operating/surgical cystoscopic rooms, (m), (n) (o) | Positive                                    | 4                   | 20                | NR  | No  | 20-60                           | 68-75/20-24              |
| Delivery room (Caesarean) (m), (n), (o)            | Positive                                    | 4                   | 20                | NR  | No  | 20-60                           | 68-75/20-24              |
| Substerile service area                            | NR  | 2                   | 6                 | NR  | No  | NR                              | NR                       |
| Recovery room                                      | NR  | 2                   | 6                 | NR  | No  | 20-60                           | 70-75/21-24              |
| Critical and intensive care                        | NR  | 2                   | 6                 | NR  | No  | 30-60                           | 70-75/21-24              |
| Intermediate care (s)                              | NR  | 2                   | 6                 | NR  | NR  | max 60                          | 70-75/21-24              |
| Wound intensive care (burn unit)                   | NR  | 2                   | 6                 | NR  | No  | 40-60                           | 70-75/21-24              |
| Newborn intensive care                             | Positive                                    | 2                   | 6                 | NR  | No  | 30-60                           | 72-78/22-26              |
| Treatment room (p)                                 | NR  | 2                   | 6                 | NR  | NR  | 20-60                           | 70-75/21-24              |
| Trauma room (crisis or shock) (c)                  | Positive                                    | 3                   | 15                | NR  | No  | 20-60                           | 70-75/21-24              |
| Medical/anesthesia gas storage (r)                 | Negative                                    | NR                  | 8                 | Yes   | NR  | NR                              | NR                       |
| Laser eye room                                     | Positive                                    | 3                   | 15                | NR  | No  | 20-60                           | 70-75/21-24              |
| ER waiting rooms                                   | Negative                                    | 2                   | 12                | Yes (q)   | NR  | max 65                          | 70-75/21-24              |
| Triage   | Negative                                    | 2                   | 12                | Yes (q)   | NR  | max 60                          | 70-75/21-24              |
| ER decontamination                                 | Negative                                    | 2                   | 12                | Yes   | No  | NR                              | NR                       |
| Radiology waiting rooms                            | Negative                                    | 2                   | 12                | Yes (q), (w)                                    | NR  | max 60                          | 70-75/21-24              |
| Procedure room (Class A surgery) (o), (d)          | Positive                                    | 3                   | 15                | NR  | No  | 20-60                           | 70-75/21-24              |
| Emergency department exam/treatment room (p)       | NR  | 2                   | 6                 | NR  | NR  | max 60                          | 70-75/21-24              |
| <b>INPATIENT NURSING</b>                           |   |                     |                   |   |   |                                 |                          |
| Patient room                                       | NR  | 2                   | 4 (y)             | NR  | NR  | max 60                          | 70-75/21-24              |
| Nourishment area or room                           | NR  | NR                  | 2                 | NR  | NR  | NR                              | NR                       |
| Toilet room  | Negative                                    | NR                  | 10                | Yes   | No  | NR                              | NR                       |

Note: NR = no requirement

How can get some new ideas flowing? Well, first you need to understand how powerful some of this mythology is.

I'll never forget. I was in Seattle. I'd just explained to a committee the story I told you about our MOBs, how we don't use air changes. And, one guy looks me square in the eyes, and he goes: "Well, Travis, how many people are you willing to KILL??"

(Gesture) OK, the answer is none. If there was the slightest chance in a million years of that, I wouldn't be talking about it. But, he was serious.

That's not even the most extreme one. I had another guy tell me: "We do 6 ACH in patient rooms. Before we reduce that to some other number, we need proof, beyond all doubt, that it'll be safe for patients." And he goes: "If you play around with airflows without the research, that's doing human experimentation." Human experimentation. He was serious.

Now, the funny thing is –I think its funny; he don't think its funny at all - they changed it to 4 ACH, like, six months later. No research.

## The “California Special”

Table 1: Selected Space Requirements (Source: 2013 California Mechanical Code, Table 4a)

| A: Area Designations                                       | C: Minimum Air Changes If 100% OSA | Recirculating Systems                 |                                       |
|--|------------------------------------|---------------------------------------|---------------------------------------|
|  |                                    | D: Minimum Air Changes Of Outdoor Air | E: Minimum Total Air Changes Per Hour |
| Operating room, cardiac catheterization lab and cystoscopy | 12                                 | 5                                     | 20                                    |
| Delivery room, cesarean operating room                     | 12                                 | 5                                     | 20                                    |
| Operating room   | 12                                 | 5                                     | 20                                    |
| Trauma Room (3)  | 12                                 | 5                                     | 20                                    |
| Patient Room   | 2                                  | 2                                     | 6                                     |
| Administrative   | 2                                  | 2                                     | 4                                     |
| Labor/delivery/recovery room                               | 2                                  | 2                                     | 6                                     |
| Angiograph room  | 12                                 | 5                                     | 15                                    |
| Pharmacy/medicine room                                     | 2                                  | 2                                     | 4                                     |
| Soiled workroom (utility room)                             | 4                                  | 2                                     | 10                                    |
| Clean workroom   | 4                                  | 2                                     | 6                                     |
| Staff sleep rooms  | 2                                  | 2                                     | 4                                     |
| Lactation  | 2                                  | 2                                     | 6                                     |
| Observation/seclusion room                                 | 2                                  | 2                                     | 6                                     |
| Speech therapy/audiology room                              | 2                                  | 2                                     | 6                                     |

The other funny thing is in California, our code says you can go down to 2 ACH in patient rooms if you have 100% outside air. That’s been in the code my whole career. I was using that as a young designer, long before read any of this stuff. Since then, I’ve learned that 100% outside air is a myth, but this is still in the code. People are using it. It that human experimentation? No. its not.

Here’s the thing. If health care ventilation had only ever been done one way, those guys would be right. I’d agree with them.

But, it’s not true. There’s not only one way. It’s not even true in the Inland Empire, let alone California, the county, or the world. I’ve walked hospitals built in the late 70s where they grandfathered in old mechanical systems. You can put patients there. It’s not a human experiment. Nobody’s being hurt by the air conditioning.



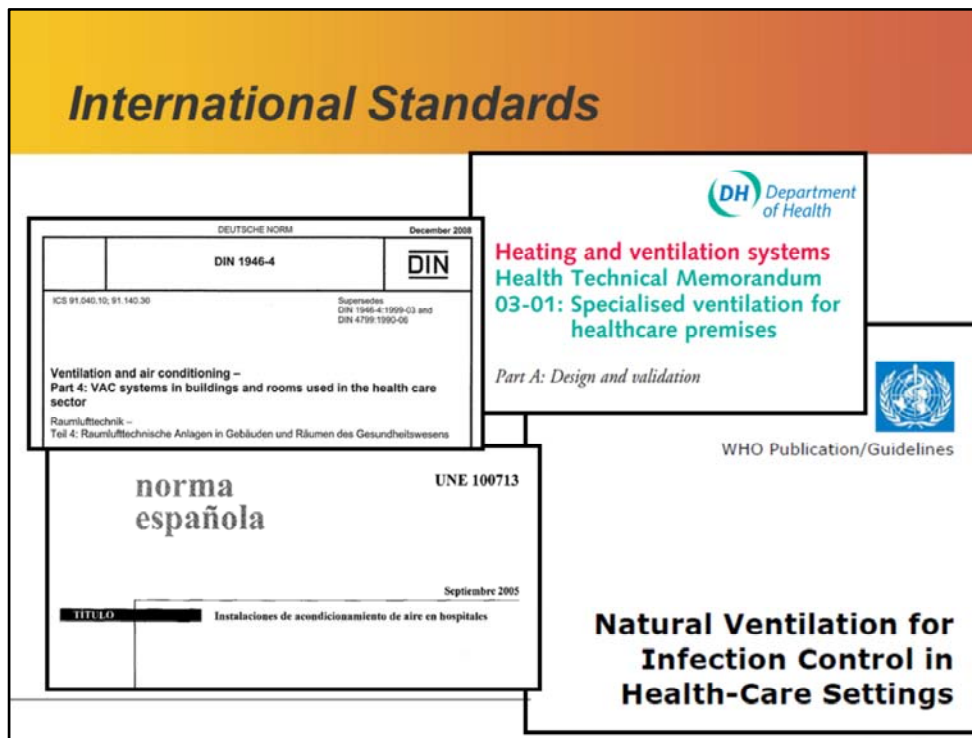











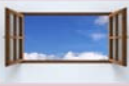



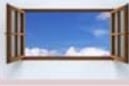
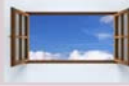

The easiest way to get perspective on US health care ventilation is to look around the world. They do things different.

I've read health care ventilation stuff from the UK, Germany, Spain, and Canada, a little bit from Australia, Latin America, and Japan.

Sometimes, the contrasts are downright shocking.

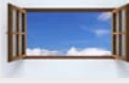
We talked about humidity: Well, Germany doesn't print a minimum humidity requirement in their ORs! In England, they tell you not to use humidifiers. They say "humidifiers create too much risk", which I totally agree with for SCAL, BTW.

Here's another one: In Germany and Japan, they use natural ventilation in outpatient surgery rooms! Yea! As a US engineer, the first time I read that, it was, like, horrifying.

|                                 | US  | UK  | Ger  | WHO   |
|---------------------------------|---|---|--|---|
| Patient Rooms / Wards           |  |  |  |  |
| Protective Environments         |  |  |  |  |
| Isolation Rooms                 |  |  |  |  |
| Procedures, Minor Interventions |  |  |  |  |
| Surgery Rooms                   |  |  |  |  |
| Regulated Rooms                 | 85  | 40  | 30   | -   |

Actually, natural ventilation is a good way to compare standards.

In the US, we require filters everywhere. The WHO standards allow NV everywhere, for economic reasons. If you can afford filtered air, put it in your ORs and protective environments.

The German standard and the British standard, encourage natural ventilation quite a bit. And those are full-blown HVAC standards. They includes ORs, isolation rooms, and protective environments. Its not like they're missing something.

The biggest contrast is this bottom line, here. the “number of regulated rooms”. We regulate more spaces than anyone – except Canada; they're worse!

But, a lot of those “regulated rooms” are restrooms, janitor rooms, corridors, and dining areas – we don't need those. A janitors' closet in a hospital is no different from a janitors' closet anywhere else. So, just use the “normal” code, right? A lot of the international standards take that approach. They put “special” requirements in a lot fewer spaces.

## A Future Code Paradigm

- Clear and transparent identification of clinical effects.
- Sound basis in indoor air quality
- Sound basis in thermal comfort

KAISER PERMANENTE. thrive

Code reform doesn't need to take a long time. What we really need are options. And, I believe we can build a new health care HVAC standard, entirely by plagiarism. Just need to pull together ideas from different sources. This is the outline that I've suggested:

- A clear and transparent identification of clinical intents. This is super important, because there's so much mythology. Half this presentation was about mythology. We need to clean that up.
- And, then everything else should use, the very best HVAC tools and practices. Comfort, IAQ. I firmly believe it hurts us to be outside the sphere of the "mainstream" engineering knowledge.



Does anyone know what these are? These are air quality measuring devices.

See – when we put ventilation rates in our codes, standards, or engineering textbooks, those are our best guess at how much ventilation we need in most cases, to get air quality. And, in the 1870s, when 2 ACH was our best guess, we didn't have this technology. In the 1970s, when 20 cfm per person was our best guess, this technology was pretty sparse. In the 1990s, when S62 re-wrote our best guess, this technology was still pretty elite. But, today? Why guess?

We talk a lot about positive pressure, right? In one of our facilities, we had an inspection go wrong, and now we're monitoring positive pressure in each of a dozen procedure rooms, every day. And, keep telling anyone who'll listen: positive pressure doesn't mean the room air is clean. You can have positive pressure and still have dirty air in the room. And, you can have a room with perfectly clean air under slightly negative pressure. That particle counter up there can take a sample of the air and tell you, in 30 seconds, how clean the air is.

We're spending \$2 million in energy per year ventilating our average ½ million sf hospital. I could hire a professional hygienist, with these tools, to run an air quality program on the building, for 1/10<sup>th</sup> of that. And, if I did that, I could drop those ventilation rates down to whatever level works, solve whatever air quality problems I have based on real data, so that my environment is safe and I know it, plus, I'll save a

million or two in energy, and save the planet at the same time.

## Groups

- Healthcare Without Harm
- Practice Greenhealth
- ASHRAE, TC9.4 – Health Care Facilities
- American Society of Healthcare Engineers
- Code-Authoring Bodies
  - Facilities Guidelines Institute
  - ASHRAE SSPC 170 – Ventilation for health care facilities

Since 2012, my group has tried to change the public discourse. You see me giving a lot of presentations. We submit proposals to the code groups every 6 months. So far, they're rejecting all of it. But, we're trying to work with them.

**THANK YOU**

What do you see in the future?

There will be net-zero hospitals.

**Travis R. English, P.E.**  
**Director of Engineering**  
**Chief Design Engineer**  
**Kaiser Permanente**  
**National Facilities Services**  
**Facilities Planning & Design**  
[travis.r.english@kp.org](mailto:travis.r.english@kp.org)  
**O: 714-572-7475**  
**M: 714-469-9553**

KAISER PERMANENTE. thrive

There have been a few examples of net-zero, or near net-zero, hospitals. But, frankly, they didn't eat their vegetables. They've invested in large scale renewable energy. Nobody's been able to deeply reduce consumption.

In MOBs, we're making great progress. Our MOBs should be net zero ready by 2025, same as everyone else.

To really move the needle on hospitals, we have to address HVAC, with a new HVAC toolkit. That'll open the door to much lower consumption, net zero hospitals, a much more sustainable health care building sector.