

Global Biodiversity Assessment

V.H. Heywood, Executive Editor **R.T. Watson**, Chair



Published for the United Nations Environment Programme



Published for the United Nations Environment Programme
by the Press Syndicate of the University of Cambridge
The Pitt Building, Trumpington Street, Cambridge CB2 1RP
40 West 20th Street, New York, NY 10011-4211, USA
10 Stamford Road, Oakleigh, Melbourne 3166, Australia

© United Nations Environment Programme 1995

First published 1995

Printed in Great Britain at the University Press, Cambridge

A catalogue record for this book is available from the British Library

Library of Congress cataloguing in publication data available

ISBN 0 521 56403 4 hardback

ISBN 0 521 56481 6 paperback

Also available from Cambridge University Press: Global Biodiversity Assessment Summary for Policy-Makers
(ISBN 0 521 564808)

Disclaimer

The Global Biodiversity Assessment (GBA) is an independent, peer-reviewed analysis of the biological and social aspects of biodiversity, commissioned by the United Nations Environment Programme (UNEP) and funded principally by the Global Environment Facility (GEF). The contents of the GBA do not necessarily reflect the views or policies of UNEP nor of the GEF, nor are they an official record.

The designations employed and the presentations made do not imply the expression of any opinion whatsoever on the part of UNEP concerning the legal status of any country, territory or city, or its authority, nor concerning the delimitation of its frontiers and boundaries.

Contents

<i>Foreword</i>	vii
<i>Preface</i>	ix
<i>Acknowledgements</i>	xi
1 Introduction V.H. Heywood, I. Baste (Co-ordinators)	1
2 Characterization of biodiversity F.A. Bisby (Focal Point Co-ordinator)	21
3 Magnitude and distribution of biodiversity D.L. Hawksworth (Focal Point Co-ordinator), M.T. Kalin-Arroyo (Co-ordinator)	107
4 Generation, maintenance and loss of biodiversity R. Barbault (Focal Point Co-ordinator), S.D. Sastrapradja (Co-ordinator)	193
5 Biodiversity and ecosystem functioning: basic principles H.A. Mooney (Focal Point Co-ordinator), J. Lubchenco, R. Dirzo, O.E. Sala (Co-ordinators)	275
6 Biodiversity and ecosystem functioning: ecosystem analyses H.A. Mooney (Focal Point Co-ordinator), J. Lubchenco, R. Dirzo, O.E. Sala (Co-ordinators)	327
7 Inventorying and monitoring of biodiversity N.E. Stork (Focal Point Co-ordinator), M.J. Samways (Co-ordinator)	453
8 The resource base for biodiversity assessments D.L. Hawksworth (Focal Point Co-ordinator)	545
9 Data and information management and communication S. Olivieri (Focal Point Co-ordinator), J. Harrison, J.R. Busby (Co-ordinators)	607
10 Biotechnology B. Barlow (Focal Point Co-ordinator), G.T. Tzotzos (Co-ordinator)	671
11 Human influences on biodiversity J.A. McNeely (Focal Point Co-ordinator), M. Gadgil, C. Levêque, C. Padoch, K. Redford (Co-ordinators)	711
12 Economic values of biodiversity C. Perrings (Focal Point Co-ordinator)	823
13 Measures for conservation of biodiversity and sustainable use of its components K. Miller (Focal Point Co-ordinator), M.H. Allegretti, N. Johnson, B. Jonsson (Co-ordinators)	915
<i>Annex 1 Organization of the Global Biodiversity Assessment</i>	1063
<i>Annex 2 List of institutions and staff involved in the GBA project</i>	1067
<i>Annex 3 Venues, dates and participants in GBA meetings and workshops</i>	1068
<i>Annex 4 Contributors to the Global Biodiversity Assessment</i>	1075
<i>Annex 5 List of peer reviewers of the Global Biodiversity Assessment</i>	1088
<i>Annex 6 Glossary</i>	1104
<i>Annex 7 List of acronyms</i>	1120
Index	1125

Foreword

Biodiversity represents the very foundation of human existence. Yet by our heedless actions we are eroding this biological capital at an alarming rate. Even today, despite the destruction that we have inflicted on the environment and its natural bounty, its resilience is taken for granted. But the more we learn of the workings of the natural world, the clearer it becomes that there is a limit to the disruption that the environment can endure.

Besides the profound ethical and aesthetic implications, it is clear that the loss of biodiversity has serious economic and social costs. The genes, species, ecosystems and human knowledge which are being lost represent a living library of options available for adapting to local and global change. Biodiversity is part of our daily lives and livelihoods and constitutes the resources upon which families, communities, nations and future generations depend.

The basis of any discipline is not the answers it gets, but the questions it asks. As an exercise in biodiversity conservation, a number of questions can be asked: What are the values associated with biodiversity? How can benefits be generated from this resource? How can these benefits be shared in a fair and equitable manner? How do humans influence biodiversity? What are the underlying causes for this influence and what are their ecological consequences? How do the natural dynamics of biodiversity and the human-induced changes in biodiversity affect the values of goods and services provided by biodiversity to society?

Taken together these questions bring out the multi-dimensional challenge that the issue of biodiversity conservation poses to policy-makers and scientists alike.

Fortunately, the international community has recognized this challenge. The entry into force of the Convention on Biological Diversity, in December 1993, is illustrative not only of this recognition but also a change in the overall strategy in conserving biodiversity. It signals a move to a more proactive position that simultaneously seeks to meet people's needs from biological resources while ensuring the long-term sustainability of Earth's biological capital.

The United Nations Environment Programme has played a key role in the development of the issues relating to biodiversity. Our efforts have included the forging of the Convention on Biological Diversity, its follow-up, and have included efforts to strengthen the national and global base of knowledge on biodiversity.

This endeavour lies at the very core of UNEP's three-fold mandate:

- to catalyse awareness on global environmental problems;
- to build consensus on action to address those problems;
- to promote and support successful programmes and activities of a catalytic nature.

An essential element is the collection and dissemination of knowledge generated by scientific research. In this regard the scientific community has been and shall continue to be UNEP's key partner in carrying out our mandate.

It was in this spirit that UNEP commissioned the Global Biodiversity Assessment (GBA) project. Underlying this endeavour was an attempt to mobilize the global scientific community to analyse the present state-of-the-art knowledge and understanding of biodiversity and the nature of our interactions with it; in other words, to provide the scientific information to answer some of the questions posed above.

It must be noted here that, unlike the global agreements on Climate Change and Ozone Depletion, no formal scientific assessment was carried out prior to the final negotiation of the Convention on Biological Diversity. The Parties to the Convention clearly recognize the lack of knowledge regarding biodiversity, and the urgent need to develop our knowledge base in this area. However, let me hasten to add, there have been no formal links between the Assessment and the Convention.

Nevertheless, governments were regularly informed of the progress made in the development of this document. UNEP was gratified when we received written submissions from experts from more than 80 countries, who peer-reviewed various parts of the Assessment in their personal capacity.

The document at hand is the result of an ambitious scientific endeavour, the outcome of the invaluable contributions of more than a thousand experts worldwide. It reflects a broad spectrum of views.

The GBA is an independent critical, peer-reviewed scientific analysis of the current issues, theories and views regarding the main aspects of biodiversity. The Assessment does not concern itself with the assessment of the state of country-level or regional biodiversity. This was the fear expressed by some constituencies when this project was initiated. Its perspective is global with a focus on general concepts and principles. It does

not present any policy recommendations, although it does draw attention to possible policy implications of its major findings and to existing gaps in knowledge and capacity.

Although the GBA does provide an analysis of a wide range of biological and social science issues pertaining to biodiversity, its range is by no means exhaustive. Issues such as fair and equitable sharing of benefits, financial mechanisms and technology transfer have not been treated as extensively as the more scientific issues.

The emergence of new issues – scientific, economic and social – relating to biodiversity in the near future is a distinct possibility. In this context GBA should be regarded as a timely assessment of the subject as perceived by the global scientific community.

UNEP believes that the GBA will provide a compendium of knowledge for the benefit of those

involved in the implementation of the Convention on Biological Diversity and it will also serve as a useful tool for the scientific body of the Convention to begin its work. I also hope that the Assessment will provide a significant conceptual input in the implementation of the relevant chapters of Agenda 21 and some initiatives put forth by the Commission on Sustainable Development (CSD).

Clearly the aim of the Assessment was not to present a consensus document. It is, however, an important step in building scientific consensus and creating the foundation for implementing political consensus. It is my fond hope that this document will succeed on both these counts.

Elizabeth Dowdeswell
Executive Director, UNEP

Preface

Unlike other environmental treaties, such as the Convention on Climate Change and the Montreal Protocol on Substances that Deplete the Ozone Layer, no formal knowledge assessment was carried out prior to the negotiation of the Convention on Biological Diversity. The need for such a comprehensive review of current knowledge in the broad field of biodiversity was recommended to UNEP by the Scientific Advisory Panel (STAP) of the Global Environment Facility (GEF). In response to this challenge, UNEP launched the **Global Biodiversity Assessment** following the submission of a project to the Global Environment Facility for funding. This was endorsed by the Participants' meeting in Abidjan in 1992 for inclusion in the Fourth Tranche.

A Preparatory Group for the Global Biodiversity Assessment (PGGBA) was convened by UNEP's Assistant Executive Director in Montreal, Canada, on 15–16 March 1993. The Preparatory Group discussed the objectives of the proposed Assessment and produced a preliminary outline of its content.

The GBA project was formally approved by UNEP on 3 May 1993 and subsequently it nominated a Steering Group for the Assessment (SGGBA) which met in Trondheim, Norway, on 31 May–2 June 1993. The Steering Group reviewed the policy to be adopted in preparing the Assessment, and after detailed consideration approved a Draft List of Contents. It also developed a timetable and suggested names of potential Section Co-ordinators and Lead Authors.

The method adopted for preparation of the Assessment has clear similarities with those successfully applied by the Intergovernmental Panel on Climate Change and the Montreal Protocol on Substances that Deplete the Ozone Layer. The complexity of the issues led to the establishment of thirteen teams of experts for the preparation of the GBA, each with up to four Co-ordinators and several Lead or Contributing Authors, numbering altogether some 300 experts from over 50 countries. Every effort was made to ensure as broad a geographical balance as possible in the selection of Co-ordinators and authors, and to ensure that both developing and developed countries were adequately represented. A Focal Point Co-ordinator was appointed for each team and the teams were provided with the necessary financial resources to allow them to prepare the text of the Sections. Each team met in one or more

workshops to plan the detailed content of each chapter, exchange views, and allocate responsibilities for particular parts of the text. The workshops were attended by co-ordinators, authors and invited specialists as well as by members of the Management Group. Editorial guidelines were prepared by the Executive Editor who also participated in the development of most Sections. The materials received for each chapter were reviewed and edited by the Focal Point Co-ordinators and then submitted as a first draft of the Section.

During the preparation of the GBA emphasis has been placed on ensuring open-ness, transparency and broad participation. A major feature in this regard has been the submission of the draft text to extensive peer review. Unlike the climate and ozone assessments, the GBA has had no intergovernmental component or direct link to the Convention on Biological Diversity or other intergovernmental process. None the less, governments have been kept informed throughout by means of correspondence, informal contact, and presentations of the GBA in conjunction with intergovernmental meetings. The draft Phase 2 text was submitted to the Subsidiary Body on Scientific, Technical and Technological Advice (SBSTTA) of the Convention on Biological Diversity for their use as a background document. Governments were also invited to nominate experts to peer-review the first draft of the GBA in their personal capacity, and nominations were received from about 50 governments. Altogether more than 1100 experts from more than 80 nations have participated in the peer review process and hundreds of written submissions have been made.

Several meetings between the Chairman, Executive Editor, the Co-ordinators and UNEP have been held to review the whole text and detect gaps, overlaps and inconsistencies in the text. They also prepared a first draft of the Summary for Policy-Makers (SPM) and the SPM Editorial Group met on several occasions to finalize the text of the Summary. A second draft of the main GBA was prepared, taking into account the comments received, and this was put through another peer-review process. It was also subjected to a major review in the form of an expert workshop that took place in Panama City from 12 to 16 June 1995. A third draft of the Assessment was then prepared, edited and made ready for publication. A flow chart showing the different

Flow-chart of the various stages of the GBA process.

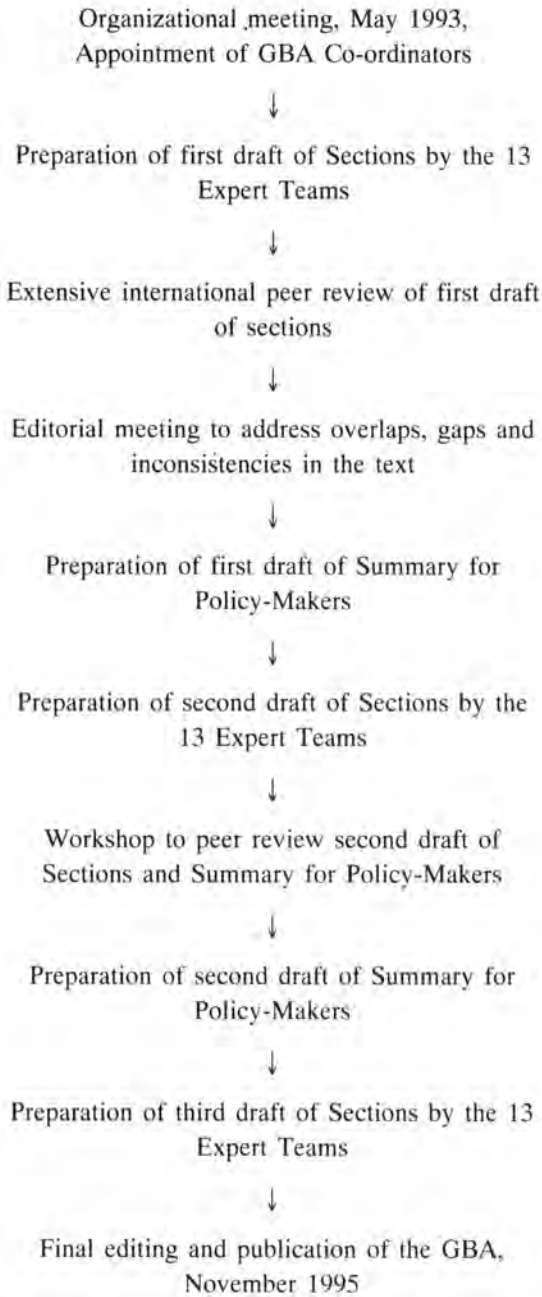

stages of preparation of the GBA is shown in the accompanying Figure.

In a subject as complex as biodiversity, it is not surprising that many of the topics reviewed in the GBA are subject to different interpretations and viewpoints. We tried to take this diversity of opinion into account. Some topics appear in more than one Section of the GBA when it is necessary to deal with them in different contexts. We have attempted to cross-reference all these cases.

Due to circumstances beyond our control it was not possible to include a Section on the larger dimensions of human values in biodiversity as had been planned. However, arrangements have been made for this to be completed and issued as a separate publication by UNEP.

As Executive Editor, I should like to thank all the Co-ordinators, Lead Authors and their staff for their forbearance and good humour in undertaking all the various phases of preparation of their Sections and in attending to what must have seemed a never-ending set of requests from me for all kinds of information and assistance. I must also pay tribute to the staff of the GBA office in Reading who worked long and hard to see through the final preparation of the manuscripts for the publishers – Anne Phillips, Keith Gardner and Victoria Bonham. My thanks are also due to the staff of Cambridge University Press: Alan Crowden and Maria Murphy, who negotiated the publication arrangements and saw the book through the press, and Tony Tomlinson who, as production manager, arranged for the manuscript to be set, proofed and printed. Jane Bulleid, the copy-editor, performed the heroic task of converting a very large and complex manuscript into a form suitable for printing. Martyn Bramwell undertook a general edit of the manuscripts in record time.

Vernon Heywood
Executive Editor

Acknowledgements

The Global Biodiversity Assessment has benefited from having received contributions from more than 1500 experts from the academic community and international organizations. Many of them have laboured long hours in contributing to the Assessment. Without their dedication, co-operation, advice and support the successful completion of this project would not have been possible. On behalf of UNEP I should like to extend my particular gratitude to the Chair of the Assessment Dr Robert T. Watson, the Executive Editor Professor Vernon H. Heywood and the Section Co-ordinators for their dedicated work. My sincere appreciation is also extended to the Lead Authors and other Contributors and to the Peer Reviewers for their written contributions and comments. UNEP would also like to thank the Honorary Advisers Dr Peter H. Raven, Professor Emil Salim, Dr M.S. Swaminathan and Professor E.O. Wilson for their support and the members of the Steering Group for the guidance they provided in

the early stages of the GBA. I also wish to acknowledge the valuable work done by the Editorial Group in preparing the Summary for Policy-Makers. UNEP highly appreciates the support from governments and scientific institutions who submitted suggestions for Peer Reviewers. I should also like to extend my thanks to the staff in UNEP and co-operating institutions who contributed in so many ways. And lastly I wish to thank those people who made it possible to meet the ambitious publication schedule of the Assessment – the Publishers Cambridge University Press, the copy-editor, the indexer, designers, graphic artists, production staff, typesetters and printers. To all those who participated in the project UNEP is deeply indebted.

Reuben Olembó

Deputy Executive Director

1

Introduction

V.H. HEYWOOD, I. BASTE

Lead Authors:

V.H. Heywood, I. Baste, K.A. Gardner

Contributors:

K. Hindar, B. Jonsson, P. Schei

CONTENTS

1.0 Introducing biodiversity	5		
1.1 Aims and objectives	7		
1.1.1 Objective of the Assessment	7		
1.1.2 Linkages with the Convention on Biological Diversity and other initiatives	7		
1.2 Defining and characterizing biodiversity	8		
1.3 The coverage of the Assessment	10		
1.3.1 Biological aspects	10		
1.3.1.1 The magnitude and distribution of organismal diversity	10		
1.3.1.2 The dynamics of biodiversity: genetics, speciation and extinction	11		
		1.3.1.3 The dynamics of biodiversity: ecosystem functioning	12
		1.3.2 Human society and biodiversity	12
		1.3.2.1 Cultural diversity	12
		1.3.2.2 The values of biodiversity	14
		1.3.3 Strategies for biodiversity conservation and sustainable use	15
		1.3.3.1 Basic principles	15
		1.3.3.2 Conservation approaches	16
		1.3.3.3 Improving the knowledge base	17
		1.3.3.4 Human and institutional capacity	17
		1.3.3.5 Global and national co-ordination	17
		References	18

1.0 Introducing biodiversity

Throughout the world, increasing interest is being expressed in environmental issues, largely as a result of the serious concern that is felt about the present state of both the local and global environment and the predictions that have been made about future trends. This awareness is based on a realization that the state of the Earth's biological systems is of fundamental importance for human society and that our influence on these systems is increasing exponentially. During the last decade, much of this interest and concern has focused on the issue of biodiversity. The scientific and social concepts and issues involved are highly complex and often poorly understood and badly explained. To address these matters, a global science assessment of what is known about biodiversity has been prepared by some of the world's leading natural and social scientists.

Are we facing a global biodiversity crisis, or indeed are we in the midst of one, as several authors have suggested? These and similar questions have been asked during the past two decades, arising out of a growing concern at the prospect of a rapidly accelerating loss of species, populations, domesticated varieties and natural habitats such as tropical rain forests and wetlands. Recent estimates suggest that more than half the habitable surface of the planet has already been significantly altered by human activity (Hannah and Bowles 1995). It has also been suggested that we are on the verge of mass extinctions of species (Myers 1979; Wilson 1985). These concerns have been coupled with a realization that our knowledge of the diversity and variability of plants, animals, microorganisms and the ecosystems in which they occur is woefully incomplete. It is this situation that led to the introduction of the notion of **biological diversity** – the total variability of life on Earth – which first emerged some fifteen years ago (Lovejoy 1980a, b; Wilson 1985; Norse *et al.* 1986; Wilson and Peters 1988; Reid and Miller 1989; McNeely *et al.* 1990; Chauvet and Olivier 1993).¹

Although the term biological diversity, or its short form **biodiversity**,² is rather new, the origins of the concept go far back in time. Questions regarding the diversity of life have occupied people's minds for as long as we have inhabited this planet. The need to divide the diversity of plants, animals and microorganisms on land and in the oceans, into groups that can be recognized and communicated about, is a basic human trait and allows us to find our way around the planet. Classification is an essential process in our daily lives (Davis and Heywood 1963) and a necessary tool for our survival. For example, we need to know which plants, animals and fungi are useful, and which are poisonous or dangerous. This activity of classifying diversity is known as **taxonomy**. All communities employ what are called **folk classifications** for the species used in everyday life, and these species are

referred to by vernacular names. The first attempts to produce formal classifications of plants and animals go back to the times of Aristotle in the twenty-fourth century BP while modern biological taxonomy dates from the mid-eighteenth century. Our knowledge of the diversity of organisms remained extremely limited until then, but increased greatly during the past 200 years as the world was opened up by exploration, colonization and trade. Nonetheless, even today we are not certain to an order of magnitude how many species occupy our planet, although a working figure of 13 million is accepted here, only about an eighth of which have so far been described. All the species we can observe on the planet today are the result of the processes of evolution through time, and modern taxonomic procedures seek to establish the patterns of evolutionary relationship between them.

Ideas regarding the linkages and relationships between organisms and their environment, both biotic and abiotic (**ecology**), developed from the eighteenth century onwards as naturalists such as Darwin, Humboldt and Wallace observed the patterns of distribution of species and vegetation types in their natural environments, but it was not until the early part of the twentieth century that ecology developed formal tools for the measurement and modelling of these relationships and their diversity. **Ecological diversity** refers to the numbers of species in given areas, the ecological roles that these species play, the way that the composition of species changes as we move across a region, and the groupings of species (ecosystems) that occur in particular areas (such as grassland or forest), together with the processes and interactions that take place within and between these systems. It also covers the diversity of ecosystems in landscapes, of landscapes in biomes and of biomes on the planet.

Again, although some of the basic facts of heredity have been known since biblical times, and deliberate breeding and hybridization experiments have been undertaken since the eighteenth century, formal genetics only started with the experiments of Mendel in the second half of the nineteenth century. The idea of **genetic diversity** is even

1. It appears that the term biological diversity was first defined as including two related concepts, genetic diversity (the amount of genetic variability within species) and ecological diversity (the number of species in a community of organisms) by Norse and McManus (1980); see also Harper and Hawksworth (1994).

2. The contracted form 'biodiversity' was apparently coined by Walter G. Rosen in 1985 for the first planning meeting of the 'National Forum on Biodiversity' held in Washington DC in September 1986, the proceedings of which (Wilson and Peters 1988) brought the notion of biodiversity to the attention of a wide field of scientists and others. Other wide-ranging surveys of the field were published by Reid and Miller (1989), McNeely *et al.* (1990) and Pineda *et al.* (1991).

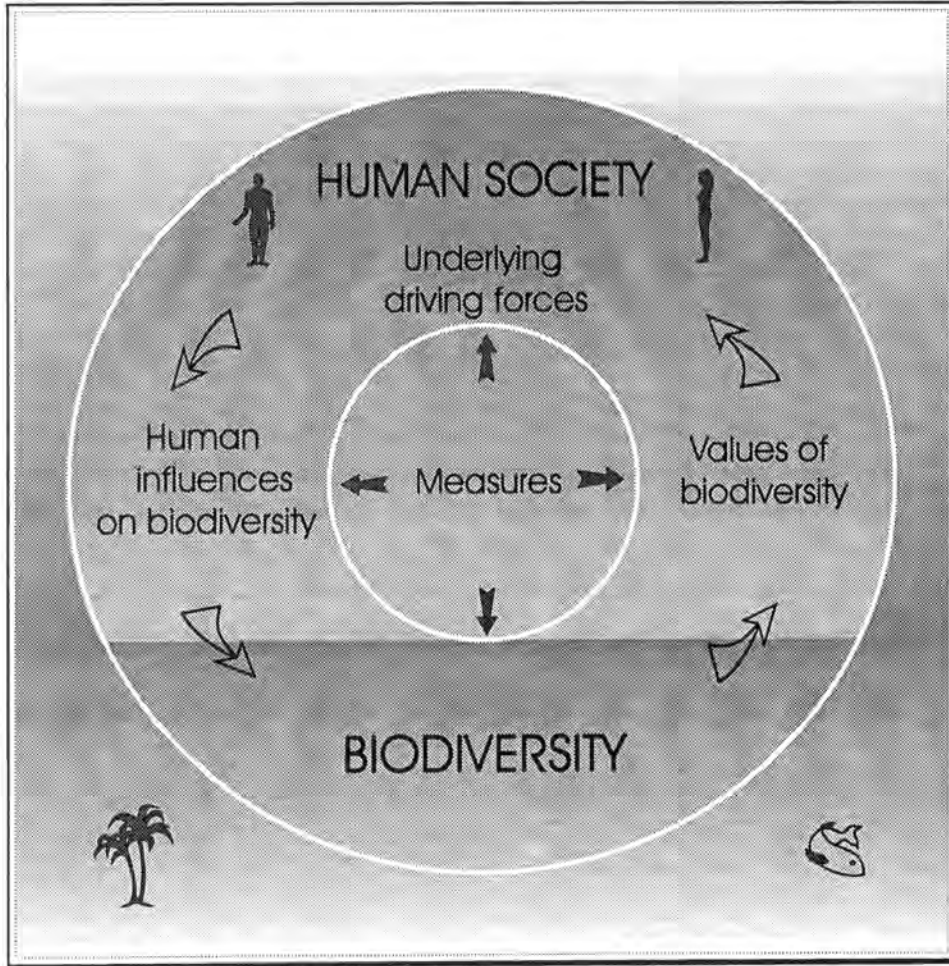

Figure 1.0-1: The interaction between human society and biodiversity.

more recent and focus on it stems in part from concern at the loss of genetic variability in crop plants, leading to the development of the genetic resources sector which deals with the sampling, collection and storage of the genetic variability of crop varieties and domesticated breeds (Plucknett *et al.* 1987; Juma 1989). Genetic diversity refers to variation within and variation between populations of species, and is measured in terms of, for example, variation between genes or between DNA or amino acid sequences, as well as numbers of breeds, strains and distinct populations. Recent insights into genetic variability and the development of biotechnological techniques have provided us with the means to use and manipulate this genetic information with much greater facility than previously.

Increasing environmental awareness over the past few decades has highlighted the need to enhance our understanding of the ways in which human society and biodiversity interact. The scope of biodiversity has, in consequence, been widened further so as to include the human dimension. We need to understand the cycles of interactions that take place between biodiversity and human society (Figure 1.0-1) and we now have to ask questions

about biodiversity such as: How is it valued in different cultures? How is it influenced by human action and activities? How can biological resources be used sustainably? How can the benefits derived from their use be shared fairly and equitably?

The importance that the global community places on these issues is underscored by the emphasis given to them at the 1992 United Nations Conference on Environment and Development (UNCED) and the entry into force of the Convention on Biological Diversity (CBD) at the end of 1993. About 120 countries are now parties to the Convention, which has become one of the major priorities amongst environmental issues. As a consequence, conservation of biodiversity, the sustainable use of its components and the fair and equitable sharing of its benefits have acquired a new political dimension, both globally and nationally. They are now firmly on the agenda of each signatory state and this has led to the need for a close analysis of all the issues raised by the provisions of the Convention and a search for ways in which they can be implemented effectively.

1.1 Aims and objectives

1.1.1 Objective of the Assessment

The objective of the Assessment is to:

provide an independent, critical, peer-reviewed, scientific analysis of the current issues, theories and views regarding the main global aspects of biodiversity. It assesses the current state of knowledge, identifies gaps in knowledge and critical scientific issues, and draws attention to those issues where scientists have reached a consensus of view and those where uncertainty has led to conflicting viewpoints and therefore a need for further research.

About 1500 scientific experts from all over the world have contributed to its preparation and pooled their knowledge, so as to present here as comprehensive and balanced a picture as possible of the many and varied components that go to make up biodiversity. It is believed that this assessment will constitute an important basis for decision-making and for further research in the field of biodiversity at all levels of society, locally as well as globally. The perspective in the GBA is global, like the international science on which it is based, with a focus on general concepts and principles. It is hoped that this perspective will assist both the global community and individual countries when addressing their particular biodiversity challenges.

1.1.2 Linkages with the Convention on Biological Diversity and other initiatives

The Convention on Biological Diversity (CBD) was negotiated prior to the United Nations Conference on Environment and Development (UNCED) held in Rio de Janeiro in 1992. It entered into force on 29 December 1993 and is one of the most significant and far-reaching environmental treaties ever developed (see Box 1.1-1).

The Convention states in its preamble that The Contracting Parties are 'aware of the general lack of information and knowledge regarding biological diversity and of the urgent need to develop scientific, technical and institutional capacities to provide the basic understanding upon which to plan and implement appropriate measures'.

This recognition is also the basis for the GBA but apart from this recognition there have been no formal links between the Assessment and the Convention. The Assessment has not been part of the Convention process and indeed UNEP and the Management Group have been at pains to avoid any sense of attempting to pre-empt the Convention, its mechanisms or its actions. The GBA is not an official statement on global biodiversity as such: rather it is a considered view by the world's scientific community on the state-of-the art in our knowledge and understanding of the multitude of issues involved in biological diversity.

Box 1.1-1: The Convention on Biological Diversity.

Preparations for a Convention on Biological Diversity were initiated by the Governing Council of UNEP in 1987 through the establishment of an Ad Hoc Working Group of Experts on Biological Diversity which met in 1988. The Ad Hoc Working Group was followed in 1991 by an Intergovernmental Negotiating Committee for a Convention on Biological Diversity. The agreed text of the Convention on Biological Diversity (CBD) was adopted by 101 governments in Nairobi in May 1992 and signed by 159 governments and the European Union at the United Nations Conference on Environment and Development (UNCED) held in Rio de Janeiro in June 1992. The Convention entered into force on 29 December 1993 and the first meeting of the Conference of Parties was held in Nassau, Bahamas, in November–December 1994. About 120 governments are now parties to the Convention.

The broad scope of the convention is illustrated in its Article 1, Objectives, which states:

The objectives of this Convention, to be pursued in accordance with its relevant provisions, are the conservation of biological diversity, the sustainable use of its components and the fair and equitable sharing of benefits arising out of the utilization of genetic resources, including by appropriate access to genetic resources and by appropriate transfer of relevant technologies, taking into account all rights over those resources and to technologies, and by appropriate funding.

It is not the objective of the GBA to develop recommendations, although occasionally it draws attention to possible policy implications of its major findings, and to gaps in knowledge or capacity. The Assessment is a compendium of knowledge which can be drawn upon by decision-makers, officials, scientists and any others who are involved in the follow-up and implementation of the Convention on Biological Diversity. It is expected that the Assessment will be useful for the implementation of several Chapters of UNCED Agenda 21, such as Chapter 15 on Biodiversity and Chapter 16 on Biotechnology, as well as for the FAO Undertaking on Plant Genetic Resources.

It is also believed that the GBA will provide a significant conceptual input in several initiatives put in hand by the Committee on Sustainable Development (CSD), for example with regards to issues of forestry and oceans.

An analysis of our knowledge of measures that can promote fair and equitable sharing of benefits from the use of genetic resources is not specifically addressed in the Assessment. Nor does the Assessment address measures for

Box 1.1-2: Some recent international biodiversity initiatives.

The **UNEP Biodiversity Country Studies Project**, initiated 1991, consisting of bilaterally and GEF-funded studies in developing countries, implemented in co-operation with donor countries and UNDP. Nineteen studies have been completed and several more are in preparation;

- **Global Biodiversity Strategy.** Guidelines for Action to Save, Study, and Use Earth's Biotic Wealth Sustainably and Equitably. WRI/ IUCN/UNEP, Washington DC (1992);
- **Global Biodiversity: Status of the Earth's Living Resources.** World Conservation Monitoring Centre. Chapman & Hall, London (1992);
- **Caring for the Earth: A Strategy for Sustainable Living.** IUCN/ UNEP/ WWF, Gland, Switzerland (1991);
- **Global Marine Biological Diversity: A Strategy for Building Conservation into Decision Making.** Center for Marine Conservation. IUCN/ WWF/ UNEP, The World Bank. E.A. Norse (ed.). Island Press, Washington DC (1993);
- The Proceedings of the **Norway/UNEP Expert Conference on Biodiversity.** O.T. Sandlund and P.J. Schei (eds). Directorate for Nature Management/Norwegian Institute for Nature Research, Trondheim (1993);
- **From Genes to Ecosystems: A Research Agenda for Biodiversity.** O.T. Solbrig (ed.). IUBS/SCOPE/ UNESCO, Paris (1991).

technology transfer or financial mechanisms. These are important issues in the Convention on Biological Diversity. They were not included in the GBA at the time of its initiation because they were seen as being somewhat outside the scope of such an apolitical scientific assessment. Occasional reference will be made to these issues but a separate Assessment would be needed if they were to be explored fully. They are, moreover, matters that the Conference of the Parties to the Convention (CBD) may wish to address through the activities of the Subsidiary Body on Scientific, Technical and Technological Advice (SBSTTA) or some other mechanism.

The GBA represents the first comprehensive, global, scientific knowledge assessment to be carried out in the broad field of biodiversity. Its preparation has been based principally on an assessment of the relevant scientific literature, taking into account other major biodiversity initiatives, both national and international. It is, however, quite independent of any of these. Some of the more important initiatives in the field of biodiversity that have taken place outside the CBD process are given in Boxes 1.1-2 and 1.1-3.

1.2 Defining and characterizing biodiversity

The multifaceted nature of biodiversity is reflected in the many definitions that have been put forward. Perhaps the first definitions to recognize specifically the three principal components (ecosystems, species and genes) in common use today (e.g. Chauvet and Olivier 1993; Barbault 1994),

were published by Norse *et al.* (1986), and the United States Office of Technology Assessment (OTA 1987). These three major components of biodiversity are recognized in the definition adopted in Article 2, Use of Terms, in the Convention on Biological Diversity, as follows:

'Biological diversity' means the variability among living organisms from all sources, including, inter alia, terrestrial, marine and other aquatic ecosystems and the ecological complexes of which they are part; this includes diversity within species, between species and of ecosystems.

Strictly speaking the word biodiversity refers to the quality, range or extent of differences between the biological entities in a given set. In total it would thus be the diversity of all life and is a characteristic or property of nature, not an entity or a resource. But the word has also come to be used in a looser fashion for the set of diverse organisms themselves, i.e. not the *diversity* of all life on earth, but *all life itself*. In some contexts the usages are distinct, in others there is ambiguity. 'A biodiverse ecosystem', or 'the generation of biodiversity in rain forests' clearly refer to the quality or range of diversity. 'Who owns the biodiversity of the forest?', 'Let us list the biodiversity present in this one ecosystem' are in contrast references to the forms that exist, albeit in a diverse system, rather than the actual diversity among them.

In addition to this duality of usage, biodiversity is, not surprisingly, perceived differently by different interest

Box 1.1-3: Some recent national and regional biodiversity initiatives.

- *Biodiversity in Canada: a science assessment for Environment Canada*. Biodiversity Assessment Team, Environment Canada, Ottawa (1994).
- *Botanical Diversity in Southern Africa*. (ed. B.J. Huntley), National Botanical Institute, Pretoria (1994).
- *Biodiversity Dynamics and Environment: Diversitas-France: A research programme for the Rio challenges*. R. Barbault, Biology International No. 28 (1994).
- *National Biodiversity Strategies or Action Plans* have been prepared or are in preparation for:

Australia	Germany	The Philippines
Bulgaria	Indonesia	Russia
Canada	Netherlands	United Kingdom
Chile	Norway	Vietnam
China		

[See WRI/UNEP/IUCN, *National Biodiversity Plans. Guidelines based on Early Country Experience Around the World*. WRI, Washington, DC (1995).]

groups. Thus the scientist studying the maintenance of biodiversity in ecosystems may focus on processes which maintain the variety of organisms, regardless of which ones they are. By contrast, a lawyer establishing legal rights over the biodiversity of a national park may be thinking purely of the set of objects, the plants, animals or microbes, and very definitely which ones they are, rather than the variation between them. Similarly, perceptions will differ between those who live in developed and developing countries and between those who live in cities and rural areas.

While the imprecision of definition and diversity of perception are sometimes viewed as a weakness of the concept of biodiversity, they can also be considered a strength in making biodiversity a unifying concept, bringing together people from different disciplines and interests with a common goal – the understanding, conservation and wise use of biological diversity and resources (Heywood 1993).

For the purposes of the the Global Biodiversity Assessment, biodiversity is defined as the total diversity and variability of living things and of the systems of which they are a part. This covers the total range of variation in and variability among systems and organisms, at the bioregional, landscape, ecosystem and habitat levels, at the various organismal levels down to species, populations and individuals, and at the level of the population and genes (see Box 1.2-1). It also covers the complex sets of structural and functional relationships within and between these different levels of organization, including human action, and their origins and evolution in space and time.

Looking more closely at the three components by which biodiversity is most conveniently assessed (Box 1.2-1), they all have a hierarchical nature and overlap. Each is

covered by a major biological discipline (Box 1.2-2) – ecology, genetics and taxonomy – although the taxonomic hierarchy (which provides the framework for organismal diversity) does not strictly speaking include populations and individuals as named units. The population can be seen as the linking unit: it has in fact merited its own field, population biology. Section 2 of the Assessment discusses the way in which biodiversity in these various component fields and levels is characterized, and establishes a vocabulary for subsequent sections.

The **species** is the basic unit of classification and the most practical and commonly used currency when referring to biodiversity (Section 2.1). When biologists talk of organisms they nearly always refer to species, rather than individuals or populations. Although the species may be defined as a group of similar organisms that interbreed or share a common lineage of descent, there is no universal agreement on how to define a species: in practice, concepts differ from group to group. Issues that have to be addressed include: What effects has such uncertainty had on our understanding and handling of biodiversity? How far are we handicapped by the lack of comparability between species in different taxonomic groups, such as flowering plants and bacteria? Is a unifying concept likely to be achieved, and how desirable an objective is this?

While species are for many purposes the basic unit of biodiversity, they are made up of populations (rarely a single one). The local breeding population is the fundamental unit on which evolution and natural selection operates. Populations may vary in size from handfuls of individuals (even a single individual in extreme cases) to hundreds of millions. These individuals contain genetic information and it is this genetic diversity (Section 2.2)

Box 1.2-1: The composition and levels of biodiversity.

Ecological diversity		Organismal diversity
biomes		kingdoms
bioregions		phyla
landscapes		families
ecosystems		genera
habitats		species
niche	Genetic diversity	subspecies
populations	populations	populations
	individuals	individuals
	chromosomes	
	genes	
	nucleotides	
Cultural diversity: human interactions at all levels		

which determines their survival and evolutionary fate and which therefore underlies species diversity. It is the selection and manipulation of genetic variability in crop plants and domesticated animals that provides the raw material of agriculture.

Species do not occur in isolation but exist in a very wide array of ecological groupings, which we can recognize as distinct. These, together with the physical environment, form the main ecoregions and biomes of the world – the habitats for humankind. As discussed in Section 2.3, a universal classification of Large Marine Ecosystems has been developed for the oceans but there is no equivalent for terrestrial ecosystems. Also addressed are the questions of how effective are the various methods used for comparing terrestrial ecosystems or units of vegetation, and the restraints on preparing a unified system.

Separating biodiversity into three components – genetic, organismal and ecological – is not without its difficulties since they are intimately interlinked and actions at any one level will impact on other levels of the hierarchies. Each of the three corresponding disciplines – genetics, systematics and ecology – has tended to view biodiversity as referring primarily to its own component and only very recently have we seen attempts to unite the components in a universal paradigm (Cousins 1994; Huston 1994; Jones and Lawton 1994).

1.3 The coverage of the Assessment

The GBA can be considered under three main themes: the biological issues of biodiversity (Sections 2, 3, 4, 5 and 6); the ways in which biodiversity interacts with humans and how it is valued by them (Sections 11 and 12); and the strategies, techniques and resources by which it may be conserved and used sustainably (Sections 7, 8, 9, 10 and 13).

1.3.1 Biological aspects

1.3.1.1 The magnitude and distribution of organismal diversity
The coverage of the Assessment is intended to be comprehensive in terms of the classes of organisms discussed and the range of ecosystems considered. Thus it deals with both wild and domesticated plants and animals, and with fungi, protoctists, bacteria and viruses. It treats terrestrial, soil, aquatic and marine ecosystems, including natural, semi-natural and human-dominated habitats.

As discussed in Section 3.1, our knowledge of the living world is remarkably limited as regards the number of species we have described scientifically. It is only for certain groups such as birds, mammals and flowering plants that our level of knowledge is reasonably comprehensive. The species we know and have described tend to be those that impinge on human life or activities – be they social, aesthetic or economic. As regards the rest, we have so far learned to live remarkably successfully with ignorance, although calls have been made in recent years to ‘complete the inventory’ of the Earth’s species, through initiatives such as *Systematics Agenda 2000* (1994). How much effort needs to be placed on the cataloguing and description of species and the elucidation of their relationships? Can we, and indeed should we, aim to describe all the species of organisms living on our planet? What priority should be given to this goal relative to other aspects of biodiversity conservation and understanding? On which groups of organisms and in which ecosystems should such efforts be focused?

As pointed out in Section 2.1, what information we do have about species is often poorly organized. For example, there is no global master list of the species that are recognized today. Also, the specimens and associated descriptions of species are widely dispersed, frequently outside their countries of origin and difficult to locate. The extent to which this hampers accurate communication about biodiversity and the options for and ways of resolving the problem are also discussed in Sections in 2, 7 and 8.

Species richness alone is not an adequate measure of the biodiversity of organisms. As shown in Section 2.1, it may also be necessary to consider ‘higher’ groups such as phyla and kingdoms, as well as their evolutionary or phylogenetic positions, when making comparisons of the biodiversity of particular areas. For example, the ‘value’ of an individual species will depend in some circumstances on its evolutionary distinctiveness. Recently, various measures of ‘taxic diversity’ have been proposed to deal with this. Section 2.1 discusses the extent to which these contribute to biodiversity measurement while questions about what their role should be in determining conservation priorities are considered in Section 13.

Species and their populations vary widely in their abundance and geographical distribution. As considered in Sections 3.3 and 3.4, some are cosmopolitan, some are

continental in scale, some show disjunct distributions between continents, and yet others are restricted (endemic) to single countries, islands, mountain tops or even individual rocks. Natural distribution patterns have been severely altered over the centuries by human activities, particularly as a consequence of increased global communications and travel (see Sections 6 and 11).

1.3.1.2 *The dynamics of biodiversity: genetics, speciation and extinction*

Biodiversity is dynamic: species and their populations are in a constant state of evolutionary change. They vary in distribution from year to year and the ecosystems in which they occur are in a constant state of flux. All these changes, as well as human-induced modifications of biodiversity, must be seen against the background of its 3.5 billion year history.

The patterns of present-day diversity of organisms result from the combined effects of speciation (diversification) and extinction. To understand these, we have to investigate the underlying (genetic) processes involved, estimate the relative past and present rates at which they occur and try to distinguish how these rates are being altered by human activities (Sections 4 and 11).

Until recently our knowledge of biodiversity at the genetic level has been limited mainly by the availability of techniques for its study, a situation that has now been reversed as new and sophisticated techniques are increasingly becoming available and being applied to more and more species. It is evident from these studies that for most species a vast amount of genetic diversity exists in

their populations and individuals (see Section 3.1). But what is the actual relationship between genetic diversity and the continued survival and adaptation of species? How is this diversity partitioned – is it mostly within or between populations? Do we need to maintain *all* the diversity within a species or are some components of it more important than others for survival and adaptation? What processes or driving forces may lead to loss or erosion of this diversity in wild populations, and to what extent do reductions in diversity occur as species are fragmented or reduced in geographic range? (See Section 4.2.)

The processes by which species evolve are discussed in Section 4.3. This raises the issue of the ways in which human activities might be affecting the rate of 'natural' speciation (as opposed to domestication). For example, while geographical isolation is considered a driving force bringing about speciation, what are the effects of fragmenting previously continuous habitats, and of creating 'new' ones such as urban areas? Is the overall global homogenization of habitats reducing the potential for speciation? One way by which humans have clearly accelerated the diversification process is through artificial selection and breeding of domesticated plants and animals (Sections 2.2 and 11). This diversification is likely to accelerate with increasingly efficient methods of manipulating genetic material through biotechnology, which is considered by Section 10.

When we come to consider the rates at which species have become extinct in the past, in response to major climatic, geological and other events, the principal sources of data are: the geological and fossil records (Section 4.1),

Box 1.2-2: The biological disciplines of biodiversity.

- **Evolutionary biology** provides the intellectual and conceptual background for all modern biological science. It provides explanations of how biodiversity arose, and the processes, such as speciation and extinction, by which it continues to change.
- **Taxonomy** is the practice by which the different groups of organism are described and classified in a hierarchical system and thereby provides a reference system for biology. Scientific classifications are the means we use for dividing up the world of organisms into usable units about which we can communicate. **Biological systematics** is the approach whereby similarities and differences between these groups are examined and their evolutionary relationships elucidated.
- **Ecology** deals with the relationships, both structural and functional, between organisms and the biotic and abiotic environments in which they occur, and provides a classification of the different types of habitat.
- **Genetics** seeks to understand the hereditary basis of variation and evolutionary change at all levels.
- **Population biology** brings together information about the genetic structure, spatial, age and size structure, and dynamics of populations of plants, animals and micro-organisms. The population is the fundamental linking unit between the three biodiversity components.

written historical records (Section 11.1), and information derived from living organisms in the form of inherited characters, access to which has been greatly increased by the wider availability of genetic techniques (Section 4.1). Although biodiversity as a whole has clearly increased with time, we need to ask questions such as: Has this been a roughly linear process or have there been wide fluctuations, such as periods of rapid speciation or mass extinction?

A great deal of attention has been focused recently on the possibility that we are facing a mass extinction spasm, the like of which has not been seen before in the fossil record. In fact, the rate at which species are likely to become extinct in the near future is very uncertain. If we look at the number of recorded species extinctions since 1600 it is barely in four figures, which contrasts with several predictions of imminent or actual massive extinctions that have been made in the period 1980–95, based mainly on a species–area model derived from the field of island biogeography. This discrepancy between field knowledge and predictions; the applicability of the model to continental situations, where ecosystem fragmentation as much as loss of area is the important consideration; and other ways of predicting rates of extinction, are reviewed in Section 4.4. Also, from what we know and can predict of present extinction rates, how do they compare with the historical record? Can we meaningfully talk about ‘background’ rates of extinction as a means of comparison? How and where are the known and likely extinctions happening? Since species–area calculations produce predictions for the number of species that are committed to extinction, how long will they be able to persevere before actually going extinct? Will the time-lag be long enough for us to ‘rescue’ or restore many of them? Since most of our information on extinctions derives from a few groups of organisms, notably flowering plants, mammals and birds, how far can we extrapolate to other groups such as nematodes and insects?

Whatever the uncertainties may be about the scale of extinctions, what is clear is that many species will be reduced to small and fragmented populations in the near future. Conserving these will require intimate knowledge of the biology of small populations. This raises the issue of ‘minimum viable population’ (MVP) levels, below which species maintain insufficient numbers to prevent them from being ‘committed to extinction’. The efforts now being made to calculate these levels are discussed in Section 4.2.

1.3.1.3 The dynamics of biodiversity: ecosystem functioning

Ecological communities, together with the physical environment, form the main ecoregions and biomes of the world. Each kind of ecological community provides a range of services on which we depend, such as watershed protection, soil stabilization and pollution control, as well as providing the environmental context in which species

exist. Section 5.1 provides an overview of these services. Those provided by individual biomes, and the way in which they relate to biodiversity, are elucidated in Section 6.

The continued functioning of ecosystems is dependent on their constituent species and their distribution, as well as on the genetic variation within those species (see Section 5.2) and the dynamics of the interactions that exist between different species and between them and the physical environment. Disturbance is a key factor in analysing the dynamics of communities and its role on the functioning and maintenance of ecosystems is assessed in Section 5.3. Questions raised there include: How are humans changing disturbance regimes? Are these changes always negative, at local or global levels?

The extent to which humans are modifying or converting ecosystems in the various biomes is reviewed in Section 6. What is the rate of desertification of the drier areas of the world? How accurate are our estimates of recent and current rates of conversion of tropical forests, both humid and dry? The problems and challenges of monitoring such changes are discussed in Section 4.

A question frequently raised is that of whether all the diversity of species is needed. This raises the question of just how much functional redundancy there is in ecosystems. Are all the species in them necessary for the maintenance and survival of the ecosystem? Or are there keystone species or clusters of species? What levels of species diversity are needed to maintain the functional efficiency and richness of our landscapes? Or are other factors more important? These and related topics are discussed in Sections 4.5 and 5.2, as well as throughout Section 6. Even where species appear to be sufficiently similar to others (with respect to their functional roles) for their loss not to have any immediate consequences, do we know what will happen over long periods of time?

Since many organisms, such as migratory birds and fish, are dependent on more than one ecosystem during their life cycles, it is essential to consider ecosystem functioning at different spatial and temporal scales, a theme which underlies Sections 6 and 7.

1.3.2 Human society and biodiversity

Although biodiversity can be considered a synthesis of the various biological disciplines that contribute to it (see Box 1.2-2), it clearly covers issues far beyond the confines of biology. We also need to understand the evolution of human society and its relationship with biological diversity (Section 11.1). Thus it is also necessary to include insights from the socioeconomic and applied sciences.

1.3.2.1 Cultural diversity

The values, driving forces and human influences, as well as the measures for the conservation and sustainable use of biodiversity, vary greatly within and between different cultures. This aspect of biodiversity is, therefore,

sometimes referred to as **cultural diversity**, recognizing the important role of sociological, ethical, religious and ethnobiological values in human activities. The different cultural dimensions in different parts of the world have played a major role in the ways in which biodiversity is perceived, maintained, preserved, used and appreciated. In the past, high levels of cultural diversity have been dependent on high levels of biological diversity which in turn supported them. The importance of this interdependence is now beginning to be recognized again in traditional resource management systems in many developing countries (Gómez Pompa and Jiménez-Osornio 1989; Gadgil and Berkes 1991).

An understanding of the many aspects of human influences on biodiversity, and their underlying driving forces, is of crucial importance for setting priorities and directing conservation and sustainable use measures. How can the different human influences and social and economic driving forces be categorized, and how are they linked (Section 11.2)?

As scientists we now generally consider that humans form part of global biodiversity although until recently the human species was treated by science as separate from the rest of nature. We now recognize the extent of the effects that humans had on biodiversity in the past; Section 11.1 reviews the history of these effects and compares how different cultures have used and valued biodiversity and the resources obtained from it. The section also addresses basic issues such as: What lessons can we draw from history and different cultural experiences?

Only recently have the overall scale and global implications of human activities on biological diversity been widely appreciated, largely because the changes they cause are the result of an accumulation of countless small-scale actions (Orians 1993). Another reason for the change in our perception was the change in magnitude of this transformation of the biosphere. As cogently summarized by Kates *et al.* (1990):

The magnitude of human-induced environmental change at the global scale is enormous. Transformed, managed and utilized ecosystems constitute about half of the ice-free earth; human-mobilized material and energy flows rival those of nature. The greater part of change in most of these components of the biosphere over the last three centuries has been human-induced.

Globally, humans are now the dominant influence on biodiversity. For example, one recent study has estimated that today humans use or pre-empt *c.* 40% of the terrestrial component of net primary productivity (total photosynthetic production) (Vitousek *et al.* 1986), although this is difficult for us to conceive or perceive. The main forces driving the global transformation of the biosphere –

human population growth, together with increasing resource consumption and socio-cultural change – are continuing to increase, so that this figure is still likely to rise considerably. This raises the question of the carrying capacity of the planet and whether we can continue to increase our demands on it without limits (Section 11).

It is clear that no part of the world can be considered truly 'undisturbed': the world's habitats have been so significantly modified by human action that terms such as 'undisturbed' or 'virgin forest' are nowadays considered of little value (Section 11.2). The different ways in which human influences affect biodiversity, at all its different levels, are considered under five main headings in the GBA (Section 11.2): (1) agriculture and fisheries and the overharvesting of resources; (2) habitat destruction, conversion, fragmentation and degradation; (3) introduction of exotic or invasive organisms and diseases; (4) pollution of soil, water and atmosphere; and (5) global change. Sections 4, 5 and 6 address the biological effects of these influences, raising questions about their effects on the maintenance and survival of species and populations, the health and productivity of ecosystems, and the biological and ecological integrity of human-modified ecosystems. Can we perceive or predict the long-term effects of these actions, particularly ecological 'knock-on' effects such as occur when top predators or pollinators are eliminated from an ecosystem? How do these changes eventually impact on human society?

Many of the changes observed in our landscapes are due almost entirely to the effects over the centuries of agriculture, silviculture, road building, industrial development, urbanization and pollution. These changes have often led to a series of fragmented landscapes consisting of mosaics of human-dominated vegetation interspersed with small patches of 'natural' or 'semi-natural' vegetation. This Assessment deals, therefore, not only with 'natural' or 'semi-natural' ecosystems but also with those that are human-dominated such as crop lands, grazing lands, plantation forests, industrial crop plantations, wastelands and areas that are set aside from agriculture. Indeed most biodiversity exists in human-dominated ecosystems (Pimentel *et al.* 1992). Section 13 discusses these issues and such points as: Do the newer concepts of landscape ecology, 'cultural landscapes' and the bio-regional approach to conservation and sustainable use and management of resources require the setting of new targets and goals? How do they provide more effective approaches to familiar challenges?

How much attention should be paid to the new patterns of biodiversity that have been created by humans through planting trees, shrubs and other ornamentals in parks and gardens, in street and roadside plantings, and in rehabilitated habitats in industrial and urban situations? A large part of the human population now lives in or around

cities and by the year 2025 an estimated 80% of the residents of developed countries will live in cities while throughout the world only 40% will live in rural areas (UN 1989). Urban and peri-urban biodiversity is therefore of major importance for scientific, cultural and educational reasons. How far should it be encouraged? What role does it play? Some would argue that such 'artificial' (i.e. human-generated) biodiversity should not be our concern (Angermeier 1994) and that we should not advocate the protection of diversity but rather the protection of ecological integrity (Angermeier and Karr 1994). But as already noted, so much of biodiversity has been modified by human activities, and in so many ways, that it is now virtually impossible to draw a clear dividing line between what is 'natural' and what is 'artificial'.

It is often pointed out that most of human nutrition is obtained from a handful of crop plants such as maize, wheat, rice, potatoes, cassava, plantains, peas, beans and lentils, supplemented by a small number of domesticated animals. Given the enormous diversity of species that are believed to exist, this raises the question of the extent to which we need all these species. As pointed out in Section 11, this apparent dependence on a small number of species, especially of the plant world, is misleading; in fact tens of thousands of plant species and a considerable number of animals species are used in local traditional economies. Plants used in traditional medicine alone amount to some 25 000–30 000 species.

Traditional methods of plant and animal breeding have played a major role in shaping significant parts of the Earth's biodiversity during the last few millennia (see Sections 2.2, 11). In its modern guise, biotechnology and gene transfer methods involving plants, animals and micro-organisms are powerful tools with huge potential impacts (Section 10). These techniques can give added value to elements of biodiversity and thus may contribute to a change in conservation priorities (Reid *et al.* 1993). Focus on the use of genetic resources, and the fair and equitable sharing of the benefits arising out of their use, are central issues in the Convention on Biological Diversity. Questions arising out of this (Sections 10, 13) include: What are the risks of relying on such a narrow range of genetic resources? What are the impacts of biotechnology on genetic resources and on biodiversity in general? How can any negative impact be reduced or avoided?

1.3.2.2 *The values of biodiversity*

Today there is world-wide concern at the extent to which biodiversity is being lost and at the same time a growing appreciation of the importance of this diversity, whether measured in economic, social, aesthetic or moral terms. Indeed, it has been pointed out by philosophers of science that, although scientists often insist that their work is value neutral, conservation biologists need to acknowledge that

ethical conflicts frequently underlie the problems they study (Noss 1992). Parallel to the hierarchies of biological organization (Box 1.2-1) they recognize another hierarchy, which has been called an ethical sequence by Leopold (1949). This sequence runs from concern for self, through that for family, social group and species and beyond, through individuals of other sentient animals, and all other species, to a broad 'ecosystem-land-Earth' concern, equivalent to a 'broader ecological self' (Noss 1992). An explanation for the apparent obsession of humans with the diversity of the natural world has been proposed by E.O. Wilson (Wilson 1984; Kellert and Wilson 1993) as the 'biophilia' hypothesis – that human evolutionary history has led us to have an innate tendency to focus on life and life-like processes and that affiliating with other forms of life is a basic human need, materially, intellectually and spiritually. On the other hand it may be argued that civilization has led to our turning away from nature as a source of values in favour of other value systems, especially consumption of biological resources. Our concern with diversity has also been interpreted as part of the innate human need to dominate our environment by classifying and ordering the objects and organisms it houses.

The values placed on biodiversity are strongly linked to the human influences on it and their underlying social and economic driving forces. They are also dependent on some degree of knowledge of the scientific role of particular elements or processes of biodiversity in the functioning of our ecosystems and societies. It is a widely held view amongst environmentalists that environmental values transcend economic costs (Turner and Pearce 1993). However, while it is undoubtedly true that the multiple values of biodiversity are not adequately captured in its market value, if we want to commit and prioritize resources to its conservation and sustainable use, then applying economic measures to its evaluation is unavoidable. Section 12 introduces the field of environmental economics and explores the complex relationship between ethical, environmental and economic values. Questions raised include: How important is biodiversity for humanity? How can known and potential values of biodiversity be categorized, assessed and measured? Can distinctions be usefully made between local and global values of biodiversity? How well are biodiversity values presently reflected by market values? What can be done to reflect more adequately biodiversity values in economic analyses?

A key part of the development of environmental economics is the provision of incentives. How can the benefits derived from individual biological resources be balanced against the social costs caused by the loss of the diversity of organisms? If individuals are to have the incentive to forgo direct economic benefits in order to conserve biodiversity for greater social or global benefits, then what mechanisms must be established to return a share

Box 1.3-1: Conservation, preservation and sustainable use.

The notion of biodiversity is closely associated with that of its conservation, preservation and sustainable use, especially following the publication of the *World Conservation Strategy* (IUCN 1980), the report of the World Commission on Environment and Development (*Our Common Future*) (WCED 1987), *Caring for the Earth: A Strategy for Sustainable Living* (IUCN/UNEP/WWF 1991), and the *Global Biodiversity Strategy* (WRI/IUCN/UNEP 1992). The notion of sustainability is regarded as a guiding principle for development (hence 'sustainable development') and development is sustainable only if it is ecologically sound. The tortuous relationships between conservation and sustainability and the many different ways in which the latter concept has been defined are the subject of intense and continuing debate. These are discussed in Sections 12 and 13.

Conservation is a term not defined in the Convention on Biological Diversity. The term is used here both in the narrower sense of **preservation** or maintenance of some or all of the components of biological diversity, and in the broader sense to include also sustainable use of the components, or their recovery or restoration – or both. There are occasions when it is useful to refer to these different components separately although in practice the concepts are intimately linked.

Sustainable use is employed in this Assessment according to the definition given in the Convention on Biological Diversity:

'Sustainable use' means the use of components of biological diversity in a way and at a rate that does not lead to the long-term decline of biological diversity, thereby maintaining its potential to meet the needs and aspirations of present and future generations.

It does not, however, carry with it the implication that the biodiversity or resources can be handed on to future generations completely unchanged. Virtually all forms of use lead to some change or loss in biodiversity, however small.

of these global and social benefits to those individuals? Which land tenure and property regimes give the greatest incentives for conservation and sustainable use of biodiversity? Such questions are addressed in Sections 11 and 12.

1.3.3 Strategies for biodiversity conservation and sustainable use

1.3.3.1 Basic principles

As emphasized by the Convention on Biological Diversity, any strategy to slow the loss of biodiversity and to enhance its contributions to development must integrate three essential elements: conservation of biodiversity, sustainable use of its components and the equitable sharing of benefits (Box 1.3-1). In the development of national strategies and action plans, as called for in the Convention on Biological Diversity, we need to know if there are conceptual approaches available to address conservation and sustainable use in broad terms: internationally, nationally, or locally, in a bio-region, landscape or ecological community, for instance. We need to ask questions such as: How can we alter social and economic driving forces? What kind of legislative measures are needed for conservation and sustainable use? How can we effectively use and co-ordinate the current data on biodiversity, and deploy the available human resources and the wide array of available conservation techniques? And how can we

integrate conservation and development programmes? Chapter 1 of Section 13 of the GBA aims to provide an over-arching conceptual framework for handling the enormous challenges involved in developing an integrated approach to conservation.

The issues of scientific uncertainty and scientific debate are recurrent themes in the Assessment and are addressed in each section. Managing with these uncertainties is one of the greatest challenges faced by scientists and decision-makers in the field of environment and development, for example with regard to social and economic factors, value estimates, ecological fluctuations, immediate and long-term effects of human impacts and effectiveness of measures. The Convention on Biological Diversity does specifically address the issue of scientific uncertainty with regard to biodiversity in one section of its preamble:

Noting that where there is a threat of significant reduction or loss of biological diversity, lack of full scientific certainty should not be used as a reason for postponing measures to avoid or minimize such a threat.

This concern is related to what is often referred to as the **precautionary principle**, which states that policy-makers should proceed cautiously when making interventions in the natural environment so as to safeguard against unexpectedly

severe future costs. It has to be used prudently, however, and should be applied only when there is a serious probability of adverse consequences. It must not be used as a blanket prescription for inaction in the face of uncertainty.

1.3.3.2 Conservation approaches

Traditionally, conservation has been polarized into two separate approaches: *ex situ* and *in situ*, with ecologists and many conservationists expressing strong preference for the latter while agriculturalists and species-orientated biologists have emphasized the former.

It is almost a truism that the conservation of biodiversity is best achieved in the wild, i.e. in 'natural' ecosystems. This is, however, an oversimplification. In the case of domesticated diversity, considerable effort has been invested in recent decades into conserving *ex situ* the genetic variability represented by the hundreds of thousands of land races or primitive cultivars that have arisen in the relatively small number of crop species that humans have cultivated on a large scale over the last several thousand years, as well as the much smaller number of races of animals they have domesticated. This variability, referred to as **genetic resources**, is maintained in various forms of gene bank for future use in breeding programmes, as discussed in Sections 2 and 8. How much further effort is needed to sample and store the genetic variability in these crops and domesticated animals? How effective and efficient are the different methods of storage? How extensive and how serious is the loss of genetic diversity (genetic erosion) in crop cultivars? Should more effort be invested in developing genetic resources of minor crops and species used in local indigenous economies, including, for example, medicinal plants? Not only are *ex situ* culture collections vital for the maintenance of micro-organisms, but they are also the only effective way by which we can have access to them or indeed determine their very existence.

Current approaches to conservation are in fact very different from those in use until recently. In the last few years, there has been a paradigm shift by conservationists from viewing conservation as essentially a matter of protecting areas and ecosystems (*in situ* conservation) to a much more open and integrated approach. The earlier view was characterized by setting aside and fencing off areas or samples of ecosystems (protected areas), using a minimum of intervention and management. The objective was to maintain the maximum amount of diversity (ecosystem or species), and allow the fenced-off species to continue evolving – the so-called 'hands-off' approach. In special circumstances, the protected areas were supplemented by *ex situ* maintenance of samples of species. More recent approaches apply a variety of tools and techniques as appropriate to a particular situation (**integrated** or **complementary** conservation).

New approaches emphasize that conservation is a dynamic process and nearly always requires some form of intervention or management. They acknowledge the dynamics of ecosystems, species and populations, and recognize the critical importance of questions of temporal and spatial scale. We have to consider just how variable they are in space and time: not only do species and their populations change in distribution and composition from year to year, as reviewed in Section 4, but ecosystems too are in a constant state of flux because of their inherent dynamics, as well as responding to changes in the local environment and climate (see Section 6). As a consequence vegetation may show dramatic changes over short periods of time, thus posing considerable challenges for conservation management. Moreover, the processes of succession in ecosystems are often cyclical and do not necessarily lead to identical results, so that the kind of community found may differ according to small changes in dynamics and processes. Do we want to conserve particular biological states or to preserve natural processes? Other questions posed are: Do we want to maintain the succession as such, or what stage, for instance, of vegetational development and composition do we wish to conserve – as it is today, as it was 10, 50, 100 years ago? Which species or combinations do we wish to retain? What form and degree of intervention is needed to achieve these results? How can the capacity of ecosystems to adapt to change be maintained? Section 13 includes a discussion of these issues.

In addition to the variable dynamics, we also have to take into account the range of different scales involved in conservation actions. Individual states are primarily concerned with biodiversity within their own frontiers but this has to be recognized as part of a global scene. A species that is rare in one country may be common in an adjacent one. Moreover, the very existence of a phenomenon may only be perceptible at a certain scale and so the scale at which biodiversity is studied may well affect our ability to perceive particular patterns or processes. As Noss and Harris (1986) have pointed out, conservation strategies are most effective when they address phenomena at multiple spatial scales and levels of organization (cf. also Noss 1990, 1992).

The new conservation paradigm also recognizes the important role of humans in biodiversity dynamics. One of the main problems of the 'hands-off' approach was that it failed to take into account the roles and requirements of local people, who were often excluded from protected areas despite the fact that the biodiversity in the reserve was often at least partially conserved and maintained by them. Modern conservation programmes now have multiple management objectives, and multiple-use reserves, with areas set aside for different purposes such as preservation or various levels of extraction. In some ways this approach

mirrors traditional practices. The continued need for integration of development and conservation is stressed throughout the GBA, and particularly in Section 13.

The threat of global climate change adds another dimension of concern for conservation planning. The effects of global change on ecological systems, species migration and survival, and on biodiversity in general, are difficult to predict because of our lack of understanding of the effects of greenhouse gases, direct human action, and many other factors on the way these systems function and the way in which species adapt. Despite the still considerable uncertainty as to the detail, it is widely agreed that the effects of climate change on ecosystems and their component species could well be significant and lead to major realignments and regroupings of species as has happened previously in the Earth's history (see Section 4.1). The possible impacts of global change on biodiversity and other scenarios for the future are considered in Section 11.4.

1.3.3.3 Improving the knowledge base

Throughout the Assessment, attention has been drawn to the large gaps in our knowledge in all areas and at all levels of biodiversity. As Sections 3 and 7 make clear, much of the basic inventory of biodiversity has not yet been undertaken, even at the level of species. But how do we set priorities for inventory programmes? Should we, for example, concentrate on certain poorly-known groups such as soil microorganisms, or should we focus our efforts more on surveying areas that are on the point of being converted to agriculture, or flooded to form dams? How can such long- and short-term goals be incorporated into a cohesive strategy?

Closely linked with inventory is the **monitoring** of biological diversity which is essential to provide feedback in adaptive management programmes. Monitoring – the repeated measurement of biological entities or processes over a time series – requires an adequate baseline inventory. Monitoring can be carried out over a range of different scales, from satellite monitoring of the whole planet to following demographic changes in individual populations of plants, animals or microorganisms. As discussed in Section 7, monitoring must therefore be clearly goal-orientated but at the same time should follow standardized procedures and statistical analyses so as to allow comparison with other studies, past and present. Careful planning, both logistical and financial is vital, and we need to ask questions such as: What are the techniques available? Are they cost-effective? How widely can they be applied? What have we achieved so far in these areas?

The rapidly accelerating generation of data about biodiversity, together with the vast amount of already accumulated information, risks overwhelming us if effective action is not taken to handle and co-ordinate it.

Thus, the study of biodiversity is heavily dependent on the rapidly developing field of information technology, and data and information management, which is discussed in Section 9. Appropriate data management is essential for linking the data obtained from inventorying and monitoring to the decision-making process. Yet, as Sections 2, 7 and 13 point out, the data we have at present, particularly at the taxonomic level, are highly diffuse, unevenly distributed with respect to their country of origin, and often difficult to access, partly because of the large number of disciplines that contribute and the wide variety of users, but also for historical reasons. Resolving this problem is a key issue when considering biodiversity. How can the data and information be made readily available and accessible to decision-makers, scientists and the general public? How can developing countries access the information they need in order to execute their national biodiversity programmes in line with the convention? How much effort and how many resources are needed, for example, to produce a global species list? What role will the global communication networks such as the Internet have in facilitating effective information flow? The issue of intellectual property rights, particularly with respect to recent controversies over the patenting of genetic information, has important implications in this context. These are among the issues reviewed in Sections 9, 10, 12 and particularly Section 13.

1.3.3.4 Human and institutional capacity

It is not just the data and information sources that are unevenly distributed. The human resources (e.g. scientists) and institutional resources (e.g. systematic reference collections, botanic gardens, genetic resource collections) for biodiversity understanding and management are also found largely outside the areas of greatest diversity. Are the facilities adequate even in the most well-developed countries? What are the options for redistributing some of these key resources? The extent and distribution of the resources are examined in Section 8, which also, together with Sections 7 and 13, asks what can be done to improve the situation.

1.3.3.5 Global and national co-ordination

The uneven distribution of resources and information, the difficulty of accessing information, the separation between the collectors and users of that information and the wide range of disciplines and perspectives involved in biodiversity make effective global and national co-ordination a priority for biodiversity management. More effective national and international organization of the knowledge we do possess would greatly enhance the effectiveness of the way in which we manage our planet's resources. An essential starting point is to look at biodiversity from a global perspective and assess what we

know, a process to which it is hoped the GBA will make a significant contribution.

References

- Angermeier, P.L.** 1994. Does biodiversity include artificial biodiversity? *Conservation Biology* **8**: 600–602.
- Angermeier, P.L.** and Karr, J.R. 1994. Biological integrity versus biological diversity as policy directives. *BioScience* **44**: 690–697.
- Barbault, R.** 1994. *Des baleines, des bactéries et des hommes*. Editions Odile Jacob, Paris.
- Barbault, R.** 1994. Biodiversity Dynamics and Environment: Diversitas-France: A research programme for the Rio challenges. *Biology International* No. 28.
- Biodiversity in Canada: a science assessment for Environment Canada.** 1994. Biodiversity Assessment Team. Environment Canada, Ottawa.
- Botanical Diversity in Southern Africa.** 1994. B.J. Huntley (ed.). National Botanical Institute, Pretoria.
- Chauvet, M.** and Olivier, L. 1993. *La biodiversité. Enjeu planétaire. Préserver notre patrimoine génétique*. Editions Sang de la Terre, Paris.
- Cousins, S.H.** 1994. Taxonomy and functional biotic measurements, or, will the Ark work? In: Forey, P.L., Humphries, C.J. and Vane-Wright, R.I. (eds), *Systematics and Conservation Evaluation*. 397–419. Oxford University Press, Oxford.
- Davis, P.H.** and Heywood, V.H. 1963. *Principles of Angiosperm Taxonomy*. Oliver and Boyd, Edinburgh.
- Gadgil, M.** and Berkes, F. 1991. Traditional resource management systems. *Resource Management and Optimization* **8**: 127–141.
- Gómez-Pompa, A.** and Jiménez-Osornio, J.J. 1989. Some reflections on intensive traditional agriculture. In: Gladwin, C. and Truman, K. (eds), *Food and Farm: Current debates. Monographs in Economic Anthropology* **7**: 221–253.
- Hannah, L.** and Bowles, I. 1995. Letters: Global priorities. *BioScience* **45**: 122.
- Harper, J.L.** and Hawksworth, D.L. 1994. Biodiversity: measurement and estimation. Preface. *Philosophical Transactions of the Royal Society of London, B* **345**: 5–12.
- Heywood, V.H.** 1993. The new science of synthesis. *Naturopa* No. **73**, 4–5.
- Huston, M.A.** 1994. *Biological Diversity: The coexistence of species on changing landscapes*. Cambridge University Press, Cambridge.
- IUCN/ UNEP/WWF** 1980. *World Conservation Strategy*. IUCN, Gland, Switzerland.
- IUCN/UNEP/WWF** 1991. *Caring for the Earth: A strategy for sustainable living*. IUCN, Gland.
- Jones, C.G.** and Lawton, J.H. (eds) 1994. *Linking Species and Ecosystems*. Chapman and Hall, London.
- Juma, C.** 1989. *The Gene-hunters. Biotechnology and the scramble for seed*. Princeton University Press, Princeton, NJ.
- Kates, R.W., Turner, B.L.** and Clark, W.C. 1990. The Great Transformation. In: Turner, B.L., Clark, W.C., Kates, R.W., Richards, J.F., Mathews, J.T. and Meyer, W.B. (eds), *The Earth as Transformed by Human Action*. 1–17. Cambridge University Press, New York.
- Kellert, S.R.** and Wilson, E.O. (eds). 1993. *The Biophilia Hypothesis*. Island Press, Washington, DC.
- Leopold, A.** 1949. *A Sand County almanac*. Oxford University Press, New York.
- Lovejoy, T.E.** 1980a. Foreword. In: Soulé, M.E. and Wilcox, B.A. (eds), *Conservation Biology: An evolutionary-ecological perspective*, v–ix. Sinauer Associates, Sunderland, Mass.
- Lovejoy, T.E.** 1980b. Changes in biological diversity. In: *The Global 2000 Report to the President*. Vol. 2 (The technical report). Penguin Books, Harmondsworth.
- McNeely, J.A., Miller, K.R., Reid, W., Mittermeier, R.** and Werner, T. 1990. *Conserving the World's Biological Diversity*. IUCN, WRI, World Bank, WWF-US, C.I. Washington, DC.
- Myers, N.** 1979. *The Sinking Ark: A new look at the problem of disappearing species*. Pergamon Press, New York.
- Norse, E.A.** (ed.) 1993. *Global Marine Biological Diversity: A strategy for building conservation into decision making*. Center for Marine Conservation. IUCN/WWF/UNEP, The World Bank. Island Press, Washington, DC.
- Norse, E.A.** and McManus, R.E. 1980. Ecology and living resources biological diversity. In: *Environmental Quality 1980: The eleventh annual report of the Council on Environmental Quality*. 31–80. Council on Environmental Quality, Washington, DC.
- Norse, E.A., Rosenbaum, K.L., Wilcove, D.S., Wilcox, B.A., Romme, W.H., Johnston, D.W.** and Stout, M.L. 1986. *Conserving Biological Diversity in our National Forests*. The Wilderness Society, Washington, DC.
- Noss, R.F.** 1990. Indicators for monitoring biodiversity: a hierarchical approach. *Conservation Biology* **4**: 355–364.
- Noss, R.F.** 1992. Issues of scale in conservation biology. In: Fiedler, P.L. and Jain, S.K. (eds), *Conservation Biology*. 240–250. Chapman and Hall, New York.
- Noss, R.F.** and Harris, L.D. 1986. Nodes, networks and MUMs: preserving diversity at all scales. *Environmental Management* **10**: 299–309.
- Orians, G.H.** 1993. Policy implications of global climate change. In: Kareiva, P., Kingsolver, J.G. and Huey, R.B. (eds), *Biotic Interactions and Global Change*. 467–479. Sinauer Associates, Sunderland, Mass.
- Pineda, F.D., Cado, M.A., de Miguel, J.M.** and Montsalvo, J. (eds). 1991. *Diversidad Biológica (Biological Diversity)*. Fundación Ramón Areces, Madrid.
- OTA** 1987. Office of Technology Assessment. *Technologies to Maintain Biological Diversity*. OTA-F-330. Washington, DC.
- Pimentel, D., Stachow, U., Tackacs, D.A., Brubaker, H.W., Dumas, A.R., Meraney, J.J., O'Neil, J.A.S.,** and Onsi, D.E. 1992. Conserving biological diversity in agricultural/forestry systems. *BioScience* **42**: 354–362.
- Plucknett, D.L., Smith, N.J.H., Williams, J.T.** and Anishetty, M.N. 1987. *Gene Banks And the World's Food*. Princeton University Press, Princeton, NJ.
- Reid, W.V., Laird, A.L., Mayer, A.M., Gámez, R., Sittenfeld, A., Janzen, D.H., Gollin, M.A.** and Juma, C. 1993. *Biodiversity Prospecting: Using genetic resources for sustainable development*. World Resources Institute, Washington, DC.

- Reid, W.V.** and Miller, K.R. 1989. *Keeping Options Alive*. World Resources Institute, Washington, DC.
- Sandlund, O.T.** and Schei, P.J. (eds). 1993. *Norway Expert Conference on Biodiversity*. Directorate for Nature Management/Norwegian Institute for Nature Research, Trondheim.
- Solbrig, O.T.** (ed.) 1991. *From Genes to Ecosystems: A research agenda for biodiversity*. IUBS/SCOPE/UNESCO, Paris.
- Systematics Agenda 2000**. 1994. Produced by Systematics Agenda 2000. A Consortium of the American Society of Plant Taxonomists, the Society of Systematic Biologists, and the Willi Hennig Society, in co-operation with the Association of Systematics Collections, New York.
- Turner, R.K.** and Pearce D.W. 1993. Sustainable economic development: economic and ethical principles. In: Barbier, E.B. (ed.), *Economics and Ecology*. Chapman and Hall, London.
- UN** 1989. *World Population Prospects*. United Nations, New York.
- Vitousek, P.M.**, Ehrlich, P., Ehrlich, A. and Matson, P. 1986. Human appropriation of the products of photosynthesis. *BioScience* **36**: 368–373.
- Wilson, E.O.** 1984. *Biophilia*. Harvard University Press, Cambridge, Mass.
- Wilson, E.O.** 1985. The biological diversity crisis. *BioScience* **35**: 700–706.
- Wilson, E.O.** 1992. *The diversity of Life*. Penguin, London (paperback 1994).
- Wilson, E.O.** and Peters, F.M. (eds) 1988. *Biodiversity*. National Academy Press, Washington, DC.
- WCED** 1987. *Our Common Future*. Report of the World Commission on Environment and Development. Oxford University Press, Oxford.
- WCMC** 1992. *Global Biodiversity: Status of the Earth's living resources*. World Conservation Monitoring Centre. Chapman and Hall, London.
- WRI/IUCN/UNEP** 1992. *Global Biodiversity Strategy*. WRI/IUCN/UNEP, Washington, DC.
- WRI/UNEP/IUCN** 1995. *National Biodiversity Plans. Guidelines based on early country experience around the world*. WRI, Washington, DC.

2

Characterization of Biodiversity

F.A. BISBY

Lead Authors:

*F.A. Bisby and J. Coddington (Chapter 2.1); J.P. Thorpe, J. Smartt (Chapter 2.2);
R. Hengeveld, P.J. Edwards, S.J. Duffield (Chapter 2.3)*

Contributors:

*J. Cracraft, D.L. Hawksworth, D. Lipscomb, N.R. Morin, P. Munyenyembe, G.J. Olsen,
D.L.J. Quicke, M.H.V. van Regenmortel, Y.R. Roskov (Chapter 2.1); A.L. Allcock,
M. Chauvet, K.A. Crandall, D.R. Given, S.J.G. Hall, J.M. Iriondo, T.M. Lewinsohn,
S.M. Lynch, G.M. Mace, A.M. Solé-Cava, E. Stackebrandt, A.R. Templeton, P.C. Watts
(Chapter 2.2); M.T. Kalin-Arroyo, J. Bullock, R.G.H. Bunce, E.A. Norse, A. Magurran,
K. Natarajan, S.L. Pimm, R.E. Ricklefs (Chapter 2.3)*

CONTENTS

Executive Summary	25		
2.0 Introduction to the characterization of biodiversity	27		
2.0.1 What is biodiversity?	27		
2.0.2 What components of biodiversity are to be characterized?	27		
2.0.3 What is meant by characterizing biodiversity?	27		
2.1 Biodiversity from a taxonomic and evolutionary perspective	27		
2.1.0 Introduction: patterns of living organisms – classification and evolution	27		
2.1.0.1 Folk classifications and the origin of scientific taxonomy	29		
2.1.1 The basics of taxonomic characterization: what taxonomists do	31		
2.1.1.1 The role of specimens in taxonomy	31		
2.1.1.2 Stability of scientific names	33		
2.1.2 Characterizing flora, fauna and microbiota: preparing Floras, handbooks and keys	33		
2.1.2.1 The amount of research work involved	34		
2.1.2.2 Modern developments: databases and expert identification systems	35		
2.1.3 Characterizing systematic patterns: the species, their evolution and their classification	36		
2.1.3.1 Analysing systematic data to reconstruct evolutionary history	36		
2.1.3.2 From phylogenetic trees to formal classifications	38		
2.1.3.3 Why do classification schemes change?	38		
2.1.4 Characterizing species	40		
2.1.4.1 The morphological species concept	41		
2.1.4.2 The biological species concept	41		
2.1.4.3 The phylogenetic species concept	43		
2.1.4.4 The pluralistic approach	44		
2.1.5 The power of taxonomy and taxonomic products	46		
2.1.5.1 Taxonomic products: an essential technological infrastructure for biotechnology, natural resources management, and regulation	46		
2.1.5.2 As a summary of biodiversity and evolutionary patterns	47		
2.1.5.3 As a basis for prediction	49		
2.1.5.4 Other uses of taxonomic techniques	50		
2.1.6 Taxonomic measures of species diversity	51		
2.1.6.1 Evaluating taxonomic isolation of individual species			51
2.1.6.2 Measuring taxonomic diversity of biota or ecosystems			53
2.1.7 Conclusion			53
References			53
2.2 Genetic diversity as a component of biodiversity	57		
2.2.0 Introduction	57		
2.2.1 Partitioning of genetic variability below the species level	61		
2.2.1.1 Analysis of karyotypic variation	63		
2.2.1.1.1 Karyotypic variation analysis techniques			63
2.2.1.1.2 Genetic diversity studies			63
2.2.1.1.3 Assessment			64
2.2.1.2 Molecular methods for assessing levels of genetic diversity	65		
2.2.1.2.1 Allozymes			65
2.2.1.2.2 Restriction fragment length polymorphism (RFLP)			67
2.2.1.2.3 Multi-locus DNA fingerprinting of minisatellite loci			68
2.2.1.2.4 Single-locus DNA fingerprinting of minisatellite loci			68
2.2.1.2.5 Gene cloning and polymerase chain reaction (PCR)			68
2.2.1.2.6 Nucleotide sequences			69
2.2.1.2.7 Applications of PCR			69
2.2.1.2.8 Conclusions			69
2.2.2 Patterns of differentiation under domestication	70		
2.2.2.1 Characterizing biodiversity within domesticated species			73
2.2.2.2 The genetic basis of cultivars and breeds			75
2.2.2.3 Species complexes and gene flow			76
2.2.2.4 Future developments			77
2.2.3 Investigating genetic diversity	77		
2.2.3.1 Type of biological material available			79
2.2.3.2 Research and development			79
2.2.4 Case studies of the use of genetic techniques in studies of within-species and between-species diversity			79
2.2.4.1 <i>Partula</i>			79
2.2.4.2 <i>Anolis</i>			81
References			82

2.3 Biodiversity from an ecological perspective	88	2.3.3 Diversity between areas	94
2.3.1 Introduction	88	2.3.3.1 The general difficulties in classifying ecological communities	94
2.3.2 Diversity within areas	88	2.3.3.2 Classifications based on species composition	96
2.3.2.1 Species richness and species diversity	88	2.3.3.2.1 Phytosociology	96
2.3.2.1.1 Comparing diversity across species groups: coherence of patterns	90	2.3.3.2.2 Global classifications of species distribution	97
2.3.2.1.2 Comparing areas of different sizes	90	2.3.3.3 Global classifications of ecosystems	100
2.3.2.1.3 The relative abundance of species	91	2.3.3.4 Characterising and classifying landscapes	102
2.3.2.2 Taxic diversity	91	2.3.3.5 Diversity in ecological systems	102
2.3.2.3 Functional diversity	92	2.3.3.6 The importance of better ecological classifications	102
2.3.2.3.1 Autecological diversity (species in isolation)	92	2.3.4 Conclusions	103
2.3.2.3.2 Synecological diversity (species in communities)	93	References	104

EXECUTIVE SUMMARY

- The recognition and characterization of biodiversity depends critically on the work of three scientific disciplines. *Taxonomy* provides the reference system and depicts the pattern or tree of diversity for all organisms (Chapter 2.1). *Genetics* gives a direct knowledge of the gene variations found within and between species (Chapter 2.2). *Ecology* provides knowledge of the varied ecological systems in which taxonomic and genetic diversity is located, and of which it provides the functional components (Chapter 2.3).
- There appear to be no short cuts to full examination of biodiversity. All three disciplines report in this assessment that, having characterized only part of the world's biological diversity, it will be necessary to undertake similar work to survey the remainder. While predictions can be made, they are no substitute for full enumeration. It is in the nature of biodiversity that surprises and uniqueness abound; predictive methods, such as the use of indicator species, latitudinal gradients, and mapping of hotspots, are of limited value.
- Taxonomy provides the core reference system and knowledge-base on which all discussion of biodiversity hinges: the framework within which biodiversity is recognized and in which species diversity characterization occurs. The most commonly used units of biological diversity are *species*, the basic kinds of organisms.
- Taxonomic characterization of the world's organisms is a mammoth but essential strategic task with which only limited progress has been made: just 1.75 of the estimated 13 to 14 million species have so far been described, and most of these are still poorly known in biological terms. There is not even a comprehensive catalogue of these 1.75 million known species.
- Despite its universal usage as a basic unit of taxonomy, it is difficult to agree on an exact definition of what constitutes a species. As a result there is considerable variation in concept and usage which may be reflected in differing classifications and species totals.
- Taxonomists have the task of enumerating which species exist and placing them in a *taxonomic hierarchy*. This taxonomic hierarchy serves both as a classification used for reference purposes and as a summary of the evolutionary tree. It can also be used to predict properties of certain organisms. The hierarchy is characterized by observation of the patterns of resemblances in comparative features such as morphology, anatomy, chemistry (including molecular data), behaviour and life-history.
- Systematic and evolutionary studies provide valuable knowledge about the evolutionary origins and patterns of life, the scientific map of diversity. This is the map that must be used in planning conservation, prospecting, exploitation, regulation, and sustainable use.
- It is considered important that assessments used in the evaluation of resources and conservation options make adequate use of *taxic diversity* measures which take into account not just numbers of species but their taxonomic positions and the differing contributions that different species make. The map or tree of diversity is occupied by very varied densities of species: in some parts there are thousands of species, in others just one or two. It follows that the very few species in certain parts of the pattern are of exceptionally high scientific value.
- Genetic diversity is the diversity of the sets of genes carried by different organisms; it occurs not only on a small scale between organisms of the same population, but on a progressively larger scale between organisms in different populations of the same species, between closely related species such as those in the same genus, and between more distantly related species, those in different families, orders, kingdoms and domains. Genetic diversity may be characterized by a range of techniques: by observation of inherited genetic traits, by viewing under the microscope the chromosomes that carry the genes, and by reading the genetic information carried on the chromosomes using molecular techniques.
- Genes transmit features from one generation to the next, so determining by inheritance and in interaction with the environment, the pattern of variation realized in features

seen within and between species. Similarly alterations in the genes carried forward to future generations mark the path of evolution. Yet scientists observe that in neither case is there a strictly one-to-one relationship between genetic diversity and the realized diversity of organisms characterized by taxonomists.

- Genetic analysis, including molecular techniques, provides a formidable tool for gaining access to precise gene differences both within and between species. Within species genetic details can characterise the traits and the populations on which natural selection and the process of evolution is acting. Between closely related species gene comparisons can reveal details of speciation and colonization.
 - It is selection acting on genetic diversity that carries forward both ecological adaptation and microevolution: to limit or reduce the genetic diversity within a species is to limit or reduce its potential or actual role in the ecological and evolutionary development of the biosphere.
 - The food plants, animals, fungi and other micro-organisms on which all humankind depend arise from genetic variants of originally wild organisms. The genetic resources in both wild and domesticated organisms thus represent a patrimony of resources for future use. Even the present well-developed food crops and animal resources are constantly at risk because of the rapid adaptation of pests and diseases: skilful and extensive manipulation of genetic resources is needed even to maintain agricultural productivity.
 - Organisms are not evenly distributed: they occur in an intricate spatial mosaic, classified on a world scale into *biogeographic zones*, *biomes*, *ecoregions* and *oceanic realms*, and at a variety of smaller scales within *landscapes* into *ecosystems*, *communities* and *assemblages*.
 - In terrestrial systems the community found at any one point can be characterized by the physical environment (ecoregion), the physiognomic type (biome), and the floristic/faunistic (biogeographic) zone in which it occurs. In marine systems communities are characterized in terms of the physical environment and the faunistic (biogeographic) zone.
 - The units of classification used on a global scale differ in how they are recognised and consequently in the distinctions between their subdivisions. Biogeographic zones differ taxonomically in the flora and fauna present, even between areas of similar physical environment (e.g. within the same ecoregion) or similar physiognomy (e.g. within the same biome). Conversely, the physiognomic differences between biomes within one biogeographic zone are paralleled by those within another.
 - All existing global classifications of ecological systems are to some extent inadequate, either in their methodology or in their spatial coverage, or in both. A robust classification of the world's ecosystems which can be used to map the distribution of ecological resources is urgently needed.
 - The biodiversity within an area can be characterized by measures of *species richness*, *species diversity*, *taxic diversity* and *functional diversity* – each highlighting different perspectives.
 - (a) Species richness (also called α -diversity) measures the number of species within an area, giving equal weight to each species.
 - (b) Species diversity measures the species in an area, adjusting for both sampling effects and species abundance.
 - (c) Taxic diversity measures the taxonomic dispersion of species, thus emphasizing evolutionarily isolated species that contribute greatly to the assemblage of features or options.
 - (d) Functional diversity assesses the richness of functional features and interrelations in an area, identifying *food webs* along with *keystone species* and *guilds*, characterised by a variety of measures, strategies and spectra.
 - A serious limitation on all measures of species diversity in an ecosystem is our inability to survey all organisms at any site: only a few taxonomic groups are sufficiently known for complete field surveys to be made.
 - At the smaller scale, landscapes are composed of areas characterised as ecosystems or communities. The diversity between areas is measured as β -diversity, the change in species present.
 - *Systems diversity* is assessed as the richness of ecological systems in a region or landscape.
-

2.0 Introduction to the characterization of biodiversity

2.0.1 What is biodiversity?

As explained in Section 1, biodiversity means the variability among living organisms from all sources and the ecological systems of which they are a part; this includes diversity within species, between species and of ecosystems. Were life to occur on other planets, or living organisms to be rescued from fossils preserved millions of years ago, the concept could include these as well. It can be partitioned, so that we can talk of the biodiversity of a country, of an area, or of an ecosystem, of a group of organisms, or within a single species.

Biodiversity can be set in a time frame so that species extinctions, the disappearance of ecological associations, or the loss of genetic variants in an extant species can all be classed as losses of biodiversity. New elements of life – by mutation, by natural or artificial selection, by speciation or artificial breeding, by biotechnology, or by ecological manipulation – can similarly be viewed as additions to biodiversity.

2.0.2 What is meant by characterizing biodiversity?

The scientific characterization of biodiversity involves what may seem like two different processes, the observation and characterization of the main units of variation (e.g. genes, species and ecosystems), and the quantification of variation within and between them (genetic distance, taxonomic relatedness, etc.). In reality they are part of the same process: the analysis of pattern defines the units as well as characterizing their variation.

In each of the three chapters that follow an assessment is made both of the reference framework and units used, and of the methods for quantifying variation. Chapter 2.1 deals with the central issue of characterizing species or taxonomic diversity. Chapter 2.2 assesses genetic diversity that occurs both within and between species. Chapter 2.3 introduces the diversity of ecological systems in which this species and genetic diversity occurs, a theme further developed in Sections 5 and 6.

A number of techniques described here are of wide application both in characterizing diversity and in topics addressed in later sections. The molecular techniques described as part of genetic diversity (Chapter 2.2) are widely used in taxonomic analysis (2.1) and in biotechnology (Section 10). The taxic diversity measures described in 2.1 are increasingly of interest in the comparison of ecological systems (2.3). No attempt is made to appraise cultural diversity: with its human and cultural dimensions, this is left until Sections 11 and 12.

Lastly, we should comment that this assessment of characterization units and techniques leaves rather a dissected view of biodiversity at different levels of description. It is for other sections to assess our knowledge of how the system works as a whole.

2.1 Biodiversity from a taxonomic and evolutionary perspective

This chapter contains an introduction to the taxonomic and evolutionary characterization biodiversity (2.1.0–2.1.4). This is followed by an overview of the power and utility of taxonomic products in general biodiversity usage (2.1.5), and in the particular context of species diversity assessment (2.1.6).

2.1.0 Introduction: patterns of living organisms – classification and evolution

The study of the different kinds of living organisms, the variations among and between them, how they are distinguished one from another, and their patterns of relationship, is known as *taxonomy* or *biosystematics* (see Box 2.1-1 for strict definitions). Taxonomy is thus fundamental in providing the units and the pattern to humankind's notion of species diversity. Indeed, the first estimates of global biodiversity were those made by taxonomists.

At one end of the range of taxonomic studies are rather practical operations such as naming and cataloguing what kinds of organisms exist (including the preparation of checklists, plant Floras, animal handbooks, computerized identification tools, etc.), the information science aspect of taxonomy. At the other end are sophisticated studies of the branching tree and geographic patterns of evolution by descent (known as *phylogeny*) and taxonomic measures of biodiversity. Simple introductory texts are provided by Ross (1974), Jeffrey (1982), Heywood (1976) and Llorente-Bousquets (1990).

Despite the sometimes bewildering complexity of forms observed, biosystematists have succeeded in most major groups in recognizing the patterns of variation and occurrence that are observed. The patterns can be depicted graphically as nested hierarchies, boxes within boxes, or branching trees (Figure 2.1-1) which, as we shall see later, can be thought of either as a nested classification or as a tree of descent. This practice originated simply as a human method of organizing knowledge, as in Aristotle's principle of Logical Division (Turrill 1942), where organisms are divided into contrasted classes: A, not A; useful, not useful; woody, not woody. Similarly, in Diderot's *Encyclopédie* (Diderot 1751–65) all knowledge, including both biology and many other topics, is connected on a hierarchical tree printed inside the book's covers. But since the acceptance of Darwin's theory of evolution by descent with modification (Darwin 1859), the success of using a hierarchy is attributed to organisms having evolved by descent with modification through time, a process that produces a branching tree. The pattern of life actually is intrinsically tree-like and hierarchical in variation pattern.

At the lowest level of this hierarchy are individual organisms which live and die (e.g. a particular dog, a

Box 2.1-1: Definitions of taxonomy and biosystematics.*A distinction between taxonomy and biosystematics*

Taxonomy in the strict sense refers to all information science aspects of handling the different sets of organisms. The word is sometimes used in contexts outside biology so, strictly, one should speak of biological taxonomy. Mayr (1969) defines it thus:

Taxonomy is the theory and practice of classifying organisms.

It can be thought of as having four components (Bisby 1984; Abbott *et al.* 1985; Radford 1986; Hawksworth and Bisby 1988):

- (i) the classification
- (ii) the nomenclature
- (iii) circumscriptions or descriptions
- (iv) identification aids

Biosystematics is a broader topic, which includes taxonomy, but also includes the full breadth and richness of associated biological disciplines, including elements of evolution, phylogeny, population genetics and biogeography (Hawksworth and Bisby 1988; Quicke 1993). In the late 1930s the term systematics was used in Britain to emphasize the move away from classical taxonomy, as in the phrase 'The New Systematics', and the establishment of 'The Systematics Association'. Simpson (1961) and Mayr (1969) define it thus:

Systematics is the scientific study of the kinds and diversity of organisms and of any and all relationships among them.

Again the word is used in non-biological contexts: biosystematics makes clear the biological context.

particular tree, a particular bacterium). Individuals occur usually as members of more-or-less continuously existing *populations*, which can be variously characterized, depending on their *breeding systems*, either as being related by the process of mating amongst their immediate ancestors (as among humans, among beetles and among palm trees), or as having a common descent from a single recent ancestor (as in the HIV virus). These populations themselves fall into patterns, some being clearly similar and of the same *species*, others being different to varying degrees and thus of different species e.g. species of rats: Norway rat (*Rattus norvegicus*), roof rat (*Rattus rattus*); species of *Prunus*: plum, cherry, peach, apricot; species of large cats: lion, jaguar, leopard, tiger. Even though the exact definition of a species is a matter for debate, the species is used universally as the basic category of the classification.

As the common names sometimes imply, some species are clearly members of recognizable larger aggregations (or the descendants of a common ancestral form) known as *genera* (singular, *genus*): e.g. date palm, canary date palm, dwarf date palm – species in the date palm genus *Phoenix*. This process of aggregating similar or related forms can be continued to form larger aggregations. Genera are

aggregated into *families*, families into *orders*, and so on up the hierarchy as shown in Table 2.1-1. The higher categories of the hierarchy, such as families and orders, are vitally important for communication; they permit discussion, generalization and information retrieval about particular sets of organisms. The overall result is a hierarchical classification going the whole way from species (or even *subspecies*, or human-made varieties called *cultivars* or *breeds*, within species) up to the major *kingdoms* such as plants, animals and fungi.

To give some idea of our progress in understanding life on Earth a comprehensive, detailed classification of living organisms on earth compiled into a single work (Parker 1982) recognizes 4 kingdoms, 64 phyla, 146 classes, 869 orders and about 7000 families. However, recent advances in the study of cell organelles and DNA sequences have led to rapid changes in the topmost categories: Whittaker (1969) and Margulis and Schwartz (1982) propose five kingdoms and Woese (1994) places three domains above the kingdoms (as depicted in Figure 2.1-5). The total of 1.75 million species thought to have been described to the present day represents a small fraction of the 13 to 14 million species estimated to exist in total. There is at present no comprehensive catalogue even of these 1.75

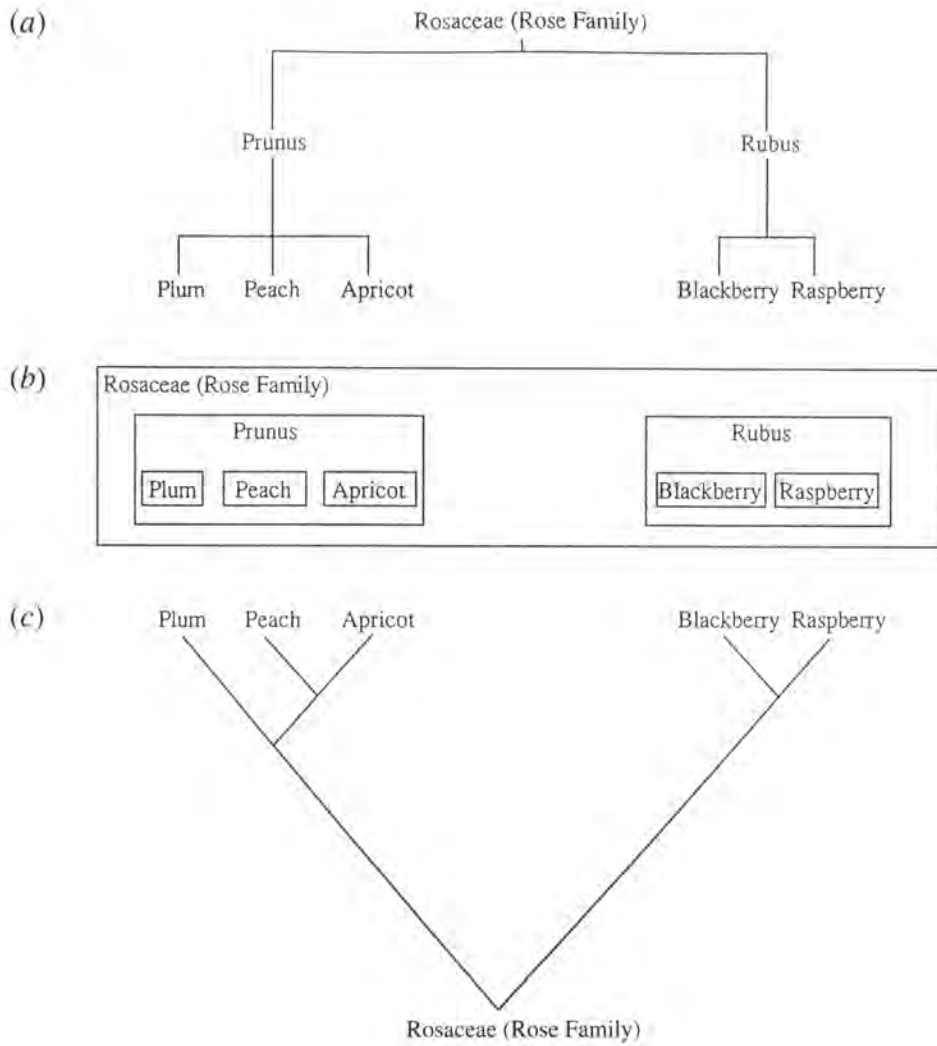

Figure 2.1-1: Three graphical representations of the taxonomic hierarchy of some members of the Rosaceae: (a) nested hierarchy; (b) box-within-box, and (c) a branching tree.

million species (see Chapter 3.1 for further discussion and Tables 3.1.2-1 and 3.1.2-2 for species counts).

Two properties of the taxonomic hierarchy are pivotal to its value in characterizing species diversity. First, the hierarchy provides a reference system that permits the summary, storage and retrieval of information about all organisms (Simpson 1961; Blackwelder 1967; Mayr 1969; Farris 1979; Bisby 1984). Secondly, the hierarchy attempts to be natural, by reflecting the presumed pathway of evolution and the pattern of resemblances among the organisms (Darwin 1859; Haeckel 1866; Cain 1954; Simpson 1961; Mayr 1963; Davis and Heywood 1963; Hennig 1966).

2.1.0.1 Folk classifications and the origin of scientific taxonomy

Throughout history humans have classified organisms. We use our innate classificatory abilities every day: we eat rice

in quantity but not peppercorns. In supermarkets many foods are arranged by species. All human societies have *folk taxonomies* – traditional classifications of organisms often associated with cultural, survival and culinary practices (Berlin 1992). The Inuit of East Hudson Bay recognize two major kinds of animals, *umajuq* which are game animals, and *umajuquti* which are domestic ones (Atran 1990). The Tzeltal Indians of Chiapas, Mexico, use four life-forms – trees, herbs, grasses and vines (Table 2.1-2; Berlin *et al.* 1974), a system which contains logical structures (generic taxa) analogous to the genus and species of scientific taxonomy.

It is from these folk classifications that scientific taxonomy emerged, initially in Europe, bringing together the more formalized cataloguing of medicinal herbs, worldwide collecting expeditions, particularly by the seafaring nations, and the dawn of scientific discovery in biology. Mediaeval herbals contained descriptions of herbal extracts

Table 2.1-1: Major taxonomic categories.

Categories (in descending rank)		Examples	
<i>Informal category above kingdom</i>			
Domain	Eucarya	Eucarya	Eucarya
<i>Formal categories recognized</i>			
Kingdom*	Animalia	Plantae	Protoctista
Phylum (Division)*	Chordata	Tracheophyta	Ciliophora
Class (Super-, Sub-)*	Mammalia	Angiospermae	Oligohymenophora
Order (Super-, Sub-)*	Primates	Fabales	Hymenostomatida
Family (Super-, Sub-)*	Hominidae	Leguminosae	Parameciidae
Tribe (Super-, Sub-)*	Hominini	Vicieae	–
Genus (Super-, Sub-)*	<i>Homo</i>	<i>Pisum</i>	<i>Paramecium</i>
Section (Sub-)*	–	–	–
Species (Super-, Sub-)*	<i>Homo sapiens</i>	<i>Pisum sativum</i>	<i>Paramecium caudatum</i>
Variety (also Form)	–	<i>P. sativum</i> var. <i>sativum</i>	–
Cultivar Group, Cultivar	–	(Sugar Pea Group) cv. 'Olympia'	–
<i>Further informal categories used</i>			
Special form			
Pathovar			
Race			
Breed			

* These categories are often subdivided still further by the addition of the prefixes sub- or super- in addition to the stem ranks themselves, e.g. a superfamily may contain several families, and a family several subfamilies.

Table 2.1-2: Folk taxonomy of the Tzeltal Indians of Chiapas, Mexico (from Berlin et al. 1974).

Category	Number of generic taxa
te? 'trees'	178
wamal 'herbs'	119
?ak 'grasses'	35
?ak 'vines'	24
Unaffiliated taxa	97
Ambiguous taxa	18
Total	471

and crude illustrations of the plants from which they came, often with a number of animal extracts and even inanimate items alongside. The thoughtless copying of such works and the attempts to shoe-horn into them new discoveries from all over the world soon led to chaos. It was against this background that the cataloguing energies of the eighteenth century Swedish naturalist Carl Linnaeus, and the first attempts at natural classification by the French naturalists, were so badly needed.

For a long time species were named using a descriptive Latin phrase, but no formal system was widespread. It was Linnaeus who adopted the binomial system in later editions of his master catalogues *Systema Naturae* (Linnaeus 1735) and *Species Plantarum* (Linnaeus 1753), and a system of nomenclature broadly similar to his has continued to the present day. It is now formally embodied in the various

Table 2.1-3: The Codes and Committees that define rules and recommendations for the scientific names of taxa.

Relevant publication or authority	Abbreviation	Latest edition
International Code of Zoological Nomenclature	ICZN	ICZN 1985
International Code of Botanical Nomenclature ¹	ICBN	Greuter <i>et al.</i> 1994
International Code of Nomenclature of Bacteria ^{1,2}	ICNB	Sneath 1992
International Committee on the Taxonomy of Viruses	ICTV	Franki <i>et al.</i> 1990; Mayo 1994
International Code of Nomenclature of Cultivated Plants	ICNCP	Brickell <i>et al.</i> 1980

1. Blue-green algae (Cyanobacteria) have variously been treated as plants or bacteria, giving rise to confusing applications of both ICBN and ICNB.

2. Fungi are covered by the ICBN/as are Cyanobacteria and certain Protozoa.

international rules for nomenclature and almost universally endorsed as the *scientific names* of organisms. Starting in the same period, much of the classification that we use today was put in place by de Jussieu, Adanson, Cuvier, Lamarck and Geoffroy Saint-Hilaire. It was they who recognized the major natural groupings of animals and plants, albeit without Darwin's insights into evolution or today's understanding of phylogenetic taxonomy. The classification and nomenclature system has developed continuously from that time and now enables workers in all sorts of professions from all over the world to communicate reasonably effectively about the same organisms, be they plants, animals, fungi or other microorganisms.

2.1.1 The basics of taxonomic characterization: what taxonomists do

There are common elements to nearly all taxonomic studies despite the different practices relevant to different groups of organisms (Blackwelder 1967; Davis and Heywood 1963). Most studies start from the examination of live or preserved specimens, either because newly discovered specimens do not fit the known patterns, or because specimens are being re-examined to solve a problem in the existing taxonomy. Some specimens are found to belong to already-known species. They are identified and the data associated with the specimen are added to the documentation for the species, possibly adding new localities, or variations in the description. Others prove to be of a previously unnamed organism. After careful research in the literature, and thorough examination of the new taxon, a new species, subspecies or variety is described and named using the international codes of nomenclature (see Table 2.1-3).

Ideally most taxonomic studies would be *revisions* of an entire group of organisms over its complete geographical range – a whole genus, family or order – but this is difficult to achieve both because of the labour involved and because

of the logistics needed to see specimens or cultures and study the organisms over several continents. Depending on the size of the group and its distribution, it may take anything from three to ten years of full-time work, in extreme cases even a lifetime, for a taxonomist to complete. The advantage is that all species can be examined in a comparable way, and that if all have been examined, decisions and descriptions of genera and families will not be confounded by intermediate or more extreme species missed out of the study. Such studies involve examining all available specimens, often by loans from the major collections supplemented by local and specialist collections, followed by the publication of a clear summary of the taxa. It is also important to ascertain the correct name for each taxon plus synonyms where they occur.

2.1.1.1 The role of specimens in taxonomy

Collections of biological specimens serve several distinct fundamental functions in the characterization of biodiversity. One of these, discussed here, is as the raw material for taxonomy: all taxonomic research is based on the comparison of large numbers of specimens. Equally important for biodiversity survey and inventory is the use of these same collections of specimens as the raw data for biological recording, discussed in Section 7: the time, the place, and the species for each biodiversity data point come from one of these specimens. We thus think of the collections of living and preserved specimens as fundamental resources for biodiversity assessment worldwide, the subject of Chapter 3.2. A third, specialist, usage is for so-called *type specimens* used to fix the application of names to organisms, discussed in 2.1.1.2.

The specimens needed by taxonomists cover a very wide range: preserved specimens in museums and herbaria; living specimens in zoos, aquaria, botanic gardens, arboreta, germplasm banks and culture collections; and associated data such as descriptions, illustrations, chemical

versus nocturnality, migration, circadian rhythms in depth for oceanic plankton), can all contribute to a systematic study. Many species build burrows, nests, brood chambers, retreats, webs, moulting chambers, egg-sacs, and other such constructs. Where these behaviours reflect heritable variation they provide valuable sources of systematic data revealing patterns of variation comparable to those in morphology and anatomy. Samples destined for gene sequencing, particular forms of anatomical comparison, or chemical analysis may require special techniques of preservation. Videotapes of behaviour or audiotapes of calls are obtainable only through fieldwork and must be stored and preserved in special repositories.

Each specimen collected in the field and deposited in one of the public collections is of potential value far beyond the particular study or programme for which it was collected. There is a consequent responsibility on the collector to establish without doubt the minimum parameters: location (increasingly giving precise latitude and longitude using a global positioning device), altitude or depth, date of collection and an identifying unique collector's name and number. Other valuable data are items that cannot be derived from the specimen at a later date – such as substrate, odour, sounds, colours (which often fade), behaviours, and position on a host. Maximum benefit will be obtained if, possibly after immediate usages, every specimen is deposited in a public collection where it can be used many times to contribute to biodiversity knowledge: the resources thus generated are reviewed in Chapter 3.2. For the system of specimen usage to work well amongst taxonomists it is important that at least one duplicate of each specimen, or the single specimen itself, be deposited at a public collection in the country of origin (this is usually a condition of collecting permits), and that such collections should make the specimens available for loan to taxonomists.

2.1.1.2 Stability of scientific names

The object of scientific nomenclature is to provide a stable unique name for each organism (Jeffrey 1989). The usage and giving of names is governed by the various international codes of nomenclature which, for historical and biological reasons, are slightly different for certain major groups of organisms (Table 2.1-3). All of the codes provide a mechanism for publishing a new name for a newly recognized taxon, for fixing a name to a particular organism by citing a *type*, and for arbitrating between synonyms where a taxon has accidentally been named more than once, or where two taxa have been united into one. The type of a species name is a particular cited specimen in a particular collection, the *type specimen*. The continued preservation of type specimens in public collections is important so that subsequent checks can be made that the right name is being applied to the right organism.

In many cases the giving of names has proved to be a troublesome business (Quicke 1993). On the one hand it is essential that taxonomists continue to map the pattern of variation and descent: this leads to changes in the classification and consequent changes of names, an inevitable price to pay for progress. We do need these changes if modern data and new discoveries are to be incorporated into our view of the taxonomy. More troubling, however, are cases of seemingly unnecessary name changes arising from different interpretations of the rules, or the continual discovery of older names that take priority under some of the codes. Recent discussions have started a move to eliminate such nomenclatural changes, either by permitting certain names to be conserved, or by listing names in current usage and protecting them from the priority of older names (Hawksworth 1991, 1992).

Some problems arise from the existence of different codes for different groups of organisms. Certain organisms, such as the blue-green algae, have even been treated variably under one code or another, leading to ambiguity or duplication (Table 2.1-3). There are also cases of organisms under different codes being given the same name: the names must be unique but only within the domain of one code. Steps are being taken to harmonize the existing codes and a working body of IUBS is now discussing the difficult task of preparing a unified code for all organisms (Hawksworth 1994; Hawksworth *et al.* 1994).

Common or vernacular names, although often used very precisely in a given community, are usually neither unique nor universal. The problem is a tendency to re-use common names for wholly or slightly different organisms as human communities, colonial powers and languages have moved from one place to another. The names *raetam* and *retama*, for instance, cover a wide range of plant species in Arabic-, Spanish- and Portuguese-speaking countries.

2.1.2 Characterizing flora, fauna and microbiota: preparing Floras, handbooks and keys

One of the main tasks of taxonomy is to characterize the species of plants, animals and microorganisms so that they can be recognized, used and studied by others. With the exception of the orally communicated folk taxonomies of indigenous peoples, biologists all over the world have, since the eighteenth century, drawn their knowledge on species characterization from the primary catalogues created by the fieldwork and research of an international community of taxonomists. Key elements in these primary works are (1) the classification (what species and higher taxa exist), (2) the nomenclature (unique scientific names for the species and higher taxa), (3) descriptions of the organisms in these species and higher taxa, and (4) identification aids (with which to identify to which species and higher taxon a freshly encountered specimen belongs). Linnaeus called his primary catalogue a *Systema Naturae*

(Linnaeus 1753) and recent electronic publications use phrases such as Species Diversity Information System (e.g. the ILDIS *LegumeLine* database, Zarucchi *et al.* 1994; Bisby *et al.* 1994) and Expert Identification Systems (e.g. the ETI CD-ROM *Linnaeus Protist, Lobsters of the World*, Estep *et al.* 1992; Estep and Rey 1993; Holthius 1994): but the majority are published books called Floras, Faunas, Monographs, Catalogues, Checklists, Handbooks or Keys.

Vascular plant primary catalogues fall into two classes: Floras and monographs. Floras document all of the higher plants in a given land area, such as local Floras, national Floras and regional Floras. National Floras exist for quite a large set of nations (see Frodin (1984) for coverage) and regional Floras have been completed for the former USSR (Komarov *et al.* 1934–60), for Europe (Tutin *et al.* 1964–80) and for West Tropical Africa (Hutchinson and Dalziel 1927–36). Projects are in progress for some other regions (e.g. *Flora of North America*, Morin 1993 *et seq.*; *Flora Malesiana*, van Steenis 1948 *et seq.*) but for many species-rich tropical areas there is still no effective inventory. Botanical monographs document all plants in a given higher taxon world-wide or in a region, as in generic and family monographs.

In practice the study of a major taxon world-wide is often not practicable, so there are few world-wide monographs, mostly of genera, and rather more regional monographs of genera or families. Again, there are no recent monographs of the large or tropical plant families.

For animals, the pattern is much less tidy, and for good reason! The equivalent to the plant scene would be Faunas (all animals of an area) and monographs (all animals in a group, world-wide). But there are so many more animal species, and they belong to widely different groups, each of which may have its own discipline of specialists, such as entomologists, herpetologists, ornithologists, lepidopterists, etc. Most descriptive works are restricted to a single higher taxon and are variously local, national or occasionally regional in scope. The result is an even more patchy coverage than is found in plants with not only some overlaps, but very, very large gaps: many major groups are uncatalogued for large parts of the world. Even the best-covered countries (in Western Europe and North America) have far from complete coverage of all animal groups. Standing way above the other problems is the difficulty in cataloguing insects (over 950 000 world-wide Wilson 1992), of which the beetles, Coleoptera, dominate with 290 000 species. Where Fauna projects have been undertaken, as in the *Faune de France* (FFSSN 1921–66), the work is always segmented into different volumes researched by different authors. There are rather few guides to the coverage of the world's animals: notable are Sims and Hollis (1980), *Animal Identification* in three volumes covering marine and brackish water animals (Vol. 1), land and freshwater animals excluding insects

(Vol. 2) and insects (Vol. 3), and *Key Works for Northwestern Europe* (Sims *et al.* 1988).

Lastly – what is the level of treatment of the other major groups, such as marine and lower plants, marine animals, fungi, bacteria and the viruses? There are some groups that are partially covered: the bryophytes, mosses and liverworts (rather few species and reasonably accessible to field botanists), fish (of economic importance), some bacteria (of medical importance) and some fungal groups (of economic importance). For most of the rest, coverage is sparse indeed: few coherent catalogues exist even for the many species known to taxonomists, let alone the vast numbers of species yet to be discovered.

2.1.2.1 The amount of research work involved

The type and amount of research needed to create one of these primary works varies enormously, particularly with how many species are to be covered, whether the group of organisms is well or poorly known, and how well explored is the region to be covered. For poorly-known groups and little-explored areas, years of field exploration may be needed both to accumulate sufficient specimens of each species encountered and to increase the chances that all species in the area have been encountered. Conversely, for well-known groups and much-explored areas there may already be a plethora of material lodged in museums or herbaria: the problems relate more to seeing all this material (borrowing it or visiting it), and to sorting out conflicts in existing taxonomic treatments of the organisms. Depending on how full a treatment is prepared, and particularly on whether all four elements are represented (classification, nomenclature, description and keys), the creator of the work will need to pass the following milestones:

1. Form a concept of the exact set of species being treated, often involving decisions on:
 - what are the species: how are they delimited, how are problems of apparent overlap, intermediacy, hybridization and discontinuity dealt with;
 - how are these species classified, either within the existing published classification, by extending the classification, by adjudicating between alternative views, or by creating a new classification.
2. Form an opinion on the correct (or new) name for each species and each higher taxon, and on the names and taxa from other treatments to be placed in synonymy.
3. Create a description of each species by studying the range of variation within that species as evidenced by field observations or by examining preserved specimens. The range of variability in one area may be greater or

Figure 2.1-3: (a) Annual rates of production of the major regional Floras (Polhill 1990).

Flora	Started	First issue	Species published	Total	%	Species/year	Actual or projected completion
Europaea	1958	1964	11 557	–	100	770	1978
SSR	1931	1933	17 520	–	100	515	1964
Australia	1979	1981	2 631	18 000	15	329	2043
West Tropical Africa	1951	1954	7 349	–	100	387	1972
Neotropica	1968	1968	4 624	90 000	5	220	2397
Southern Africa		1966	2 834	19 500	15	123	2124
Zambesiaca	1956	1960	3 215	9 300	35	110	2044
Tropical East Africa	1949	1952	6 425	10 500	61	173	2013
Malesiana	1947	1954	4 837	25 000	19	138	2135

(b) Total number of species treatments published in major regional Floras, in five-year intervals (Polhill 1990).

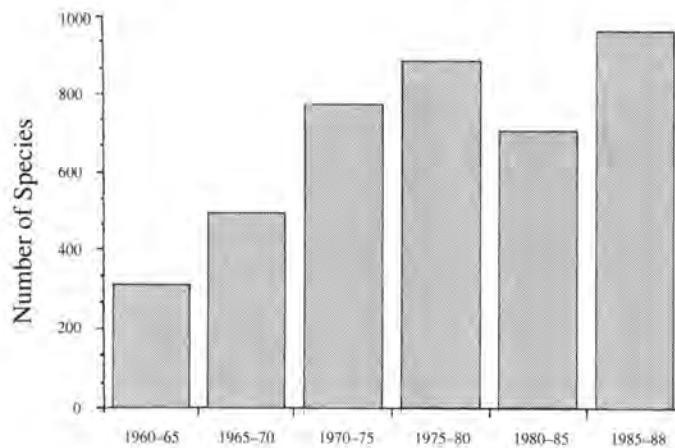

less than that recorded in other works for other areas. Additional descriptive features such as illustrations, distribution maps, ecological features, etc. may be added as well.

4. Create an identification key that leads unambiguously to an identification for freshly encountered specimens. Where possible easily visible, clearly demarcated characters should be used.

To give some idea of the amount of work involved, we cite the successful completion of *Flora Europaea* (Tutin *et al.* 1964–80). Its five volumes, containing a medium (synoptic) rather than full treatment of 11 557 plant species from the well-known, well-collected flora of Europe took 25 years work for a network of full- and part-time specialists to complete. But progress is much slower in the tropical regional Floras where more original research and fieldwork is needed, as illustrated in Polhill’s (1990) comparison of nine regional Floras summarized in Figure 2.1–3 *a* and *b*.

Floras, Faunas, monographs, many handbooks, and guides all tend to contain all four elements – classification, nomenclature, descriptions and keys. However, there can be substantial variations in how complete the descriptions are, whether voucher specimens are cited, whether illustrations and maps are included and in the extent of additional ecological, behavioural or economic information given. Checklists normally contain the classification and nomenclature of species, but accompanied by just a geographical distribution – no descriptions or identification aids. They are produced either as quicker projects, or to cover a wider geographical or taxonomic range than could otherwise be contemplated for full treatment. Keys are sometimes published alone, as a preliminary to fuller treatment, as companions to existing works, or to resolve urgent needs for identification in economic or medical contexts.

2.1.2.2 Modern developments: databases and expert identification systems

This is written at a time of unprecedented change in the technology and dissemination of primary and other taxonomic works. Information technology is rapidly

bringing in electronic communication amongst dispersed taxonomic contributors working as teams, the creation of major taxonomic works as databases, and the electronic dissemination of information to users by communications networks such as Internet or by CD-ROM disks. Some of the electronic products are simply electronic versions or compilations from existing primary works, but increasingly major primary projects are being compiled in this way: for instance the ICLARM/FAO FishBase international project on fish (Lourdes *et al.* 1994; Froese and Pauly 1994) incorporates the primary database on fish genera and species (Eschmeyer 1990, 1992), and the ILDIS species diversity system on legume plants is based on a fresh synthesis of the species taxonomy of Leguminosae by a world-wide network of experts (Zarucchi *et al.* 1994; Bisby *et al.* 1994).

A particularly important development is the bringing together of two technologies, the use of descriptive data tables in computer identification routines (Pankhurst 1975, 1978, 1991; Dallwitz 1974, 1980), and the facilities in modern computing environments to use windows containing diagrams, illustrations, photographs and maps. The resulting expert identification systems such as those produced by the Dallwitz school using the DELTA format (*Beetle Larvae of the World*, Lawrence *et al.* 1994; *Families of Flowering Plants*, Watson and Dallwitz 1994) and by ETI, the Expert Centre for Taxonomic Identification (*Linnaeus Protist*, Estep and Ray 1993; *Lobsters of the World*, Holthius 1994) are surely the sign of things to come.

Electronic means are also opening up the possibility of creating master catalogues both of larger and larger groups, and eventually of all known organisms. The IOPI World Plant Checklist (Burnett 1993; Bisby *et al.* 1993) and the BIOTA Terrestrial Arthropods projects (Hodges and Thompson, in press), for instance, propose to list all plants and all terrestrial arthropods. Very many groups of organisms now have rapidly progressing master catalogue systems (Bisby 1993, 1994) and the Species 2000 program of IUBS, CODATA and IUMS is proposing that many of these create a federated system which could lead to an index of all of the world's known organisms.

2.1.3 Characterizing systematic patterns: the species, their evolution and their classification

With the publication of Darwin's *On the Origin of Species...* in 1859, a major change was initiated in the way that the hierarchy of life was understood. Darwin's theory of evolution made sense of the natural patterns observed in the variation between organisms. Evolution occurs when organisms experience genetic mutations or recombinations, or when gene frequencies in populations change because of differing rates of reproduction or mortality. Through natural selection or genetic drift these heritable changes may spread throughout the population and over time can

lead to the production of new lineages closely similar to their relatives but differing by the possession of one or more new features (Ridley 1985, 1993; Futuyma 1987; Skelton 1993). If this new lineage continues to diversify throughout evolutionary time-spans, a wholly new higher taxon (lineage or clade) comes into being. Such lineage diversification produces a strictly hierarchical pattern. The roughly 4.5 billion years of biotic evolution has led to an enormous diversity of living forms on Earth. These forms can be grouped as sets within sets (a nested, hierarchical pattern) based on how recently they shared a common ancestor.

Darwin's observations of selective breeding and the way in which characteristics could be inherited, coupled with the immense diversity of different forms, for example of the birds and reptiles he saw on his voyage to the Galapagos, suggested to him that heritable differences between individuals could build up to produce new species and consequently higher taxa over long periods of time. Darwin himself was unaware of the mechanisms of genetics, but later studies have revealed how characters are heritable and mutable. Genetic mutation and recombination can each produce heritable novel characters which either by the process of natural selection or by non-selected random genetic drift lead to populations in different places diverging from one another over time (refer to Chapters 4.2 and 4.3).

Thus the products of evolution are arrayed in natural groups which all people, to a greater or lesser extent, can recognize. The evolutionary explanation of this pattern and diversity is the most important rationale for the taxonomic system used by scientists. This arrangement of the diversity of forms of organisms into a hierarchy serves our goals of communication, and information storage and retrieval, by reflecting the evolutionary process that created these forms in the first place.

2.1.3.1 Analysing systematic data to reconstruct evolutionary history

The results of the evolutionary process described above can be reconstructed by careful comparative study of the taxa involved (Hennig 1966; Eldredge and Cracraft 1980; Wiley 1981; Crisci 1983; Forey *et al.* 1992). Evolutionary mutation results in one of three patterns: new features arise, old features are lost, or pre-existing features are transformed to a greater or lesser extent. Any of these patterns are evolutionary changes. In practice, taxonomists find such heritable changes at all levels of the taxonomic hierarchy and at all levels of organismic organization, from single changes in DNA sequences to large changes in skeletal organization or even the entire body plan of the organism.

Because descendants inherit the features of their ancestors, a new mutation that first appeared in the ancestor

tends to be passed to its descendants. The set of all organisms, living and dead, that descended from that original modified ancestor is known as a lineage or clade. The novel mutation is known as a character, trait or feature. The old version of the trait is termed primitive, and the new version is derived. Over immense spans of geological time, speciation may occur so that the lineage splits into several to many species. Subsequently mutations may occur that delimit subsidiary lineages. From a strictly taxonomic point of view, why these changes occur, or whether they are beneficial, neutral or even detrimental to the species in which they occurred is irrelevant. What matters is that any given group of taxa both agree and differ in which characters they possess. Thus spiders are the only Arachnids that have terminal abdominal spinnerets and thoracic poison glands that open through the fang. On the other hand, only some spiders can make viscid, sticky silk; the webs of other species are dry. The simplest hypothesis is that the common ancestor of all spiders had spinnerets and fangs, but that only the common ancestor of a particular subset of spiders made viscid silk. For this simple case it is easy to see how important events in evolutionary history are reconstructed. The evolution of poison fangs and spinnerets marks the origin of spiders, and the invention of viscid silk marks the origin of a particular subfamily of spiders, the Araneoidea.

In evolutionary theory, characters of organisms that are similar because of inheritance from a common ancestor are called homologies. Classic examples are the wings or feathers of birds. No other group has feathers, and close examination of any feather discloses additional complex similarities that substantiate the homology of feathers. Another example is the sting of a wasp, actually the modified female ovipositor. Only some Hymenopteran species have stings, and in all of these species the sting is always the modified female ovipositor.

If evolution consisted only of the gain of complex homologies that were never lost by descendants, reconstructing evolutionary history would be simple indeed. Two processes complicate the issue. First, natural selection is amazingly efficient at moulding what appears to be the same feature from different starting points, a phenomenon termed evolutionary convergence. The wings of birds and bats are so similar that many years ago the homology of the two features was an open question. Detailed comparison, however, revealed substantial differences. The fleshy, spiny stems of some African *Euphorbia* plants are convergent on those of New World cacti. Porpoises are mammals, not fish, despite their fins. However, often the only way to test if two features are convergent or truly homologous is through quantitative analysis.

The second process that complicates systematic analysis is loss of features. Snakes originally had two pairs of limbs like other terrestrial vertebrates, but most have lost all trace of

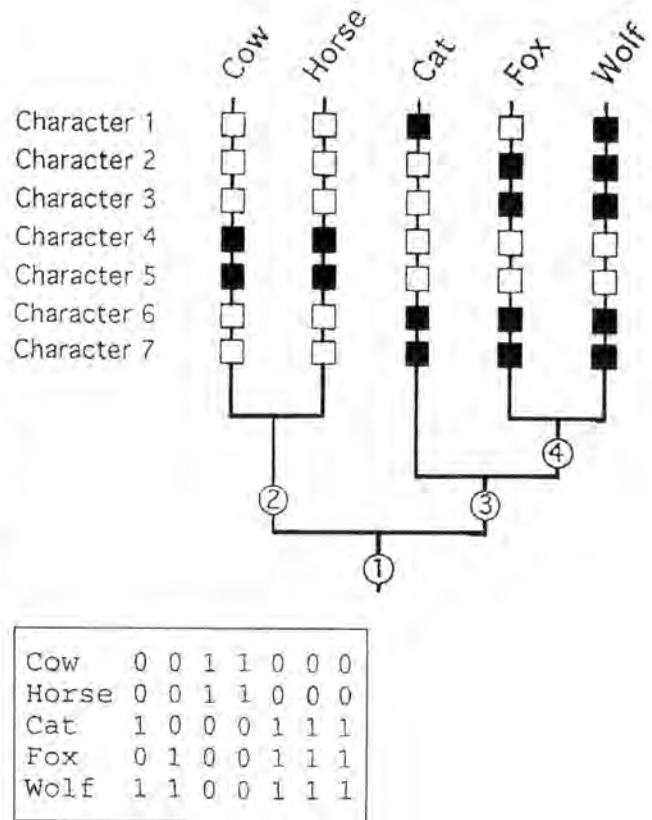
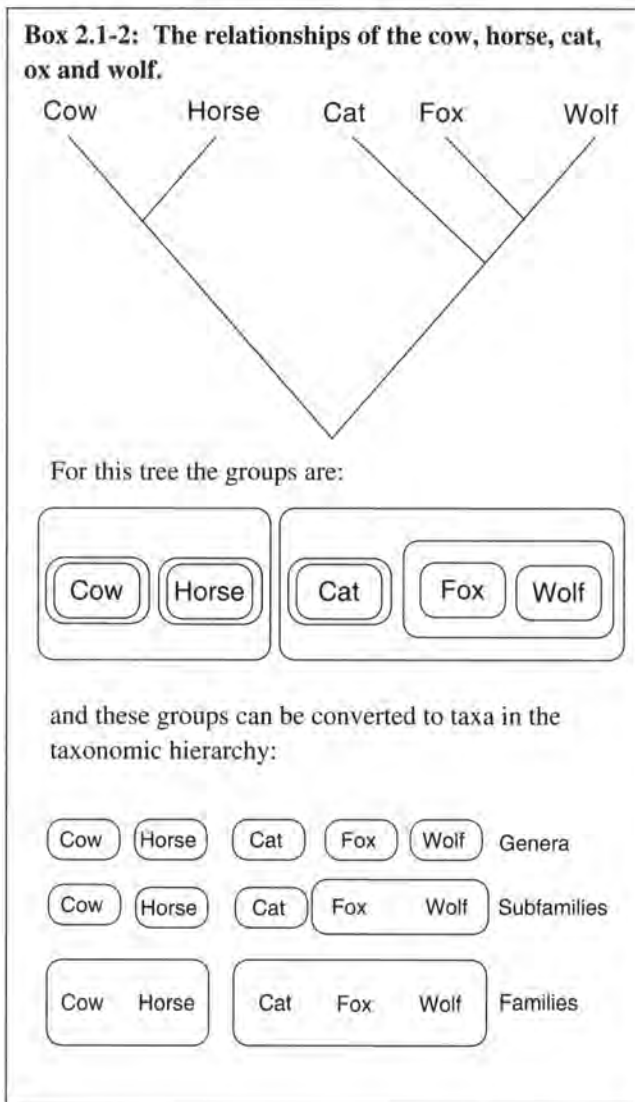

Figure 2.1-4: A simple data matrix and the implied phylogenetic hypothesis of four taxonomic groups.

them. Fleas may not have wings, but many other features betray their relation to winged insects. Once again, it is frequently impossible to distinguish secondary loss of features from primitive absence except through quantitative analysis.

In practice, systematic data are compiled as a matrix of characters by taxa and analysed quantitatively by computer. By reading across (or down) the matrix, one can either read off all the relevant characters of a particular taxon, or conversely see which of a number of taxa possess a particular feature. The computer analysis is designed to provide the best possible estimate of the phylogeny of the group (as described above), expressed as a branching diagram or evolutionary tree. Such diagrams are often called trees, phylograms, dendrograms, or cladograms (because they indicate relationships between clades of organisms). For simple examples of straightforward data, the best estimate of the phylogeny is often obvious (Figure 2.1-4), but for larger numbers of taxa and characters, computer algorithms are used to produce estimates (Kitching 1992). A number of different algorithms are currently available (e.g. parsimony, maximum likelihood, or neighbour-joining techniques), and the subject of which provides the best estimate under what circumstances is an area of very active research (Swofford and Olsen 1990).



2.1.3.2 From phylogenetic trees to formal classifications

The trees that result from comparing characters in species are usually thought to be a graphic representation of the evolutionary relatedness of the taxa. These trees should be viewed as relative statements of relationship. For example, in Box 2.1-2 the wolf and the fox are hypothesized to share a more recent common ancestor with one another than with the cat, but the cat, wolf and fox all share a more recent common ancestor with one another than with the hoofed mammals such as cow and horse: the tree, therefore, shows a hierarchy of relationships. A tree does not explicitly hypothesize ancestor–descendant relationships. For example, the tree hypothesizes that wolf and fox are related, but not that wolves evolved from foxes or that foxes evolved from wolves.

One of the tasks of a taxonomist is to convert this graphic representation of relationship into the formal hierarchical classification of taxonomic categories such as genus, family, order, etc. In converting the tree to a classification, the systematist gives groups that share a common ancestor the formal taxonomic names. Such groups are called *monophyletic taxa* and they are

recognized because they share unique derived characters. The tree shows several sets of most closely related taxa that are nested within larger sets that contain additional taxa. These larger groups are, in turn, nested within even larger groups. By this process the phylogenetic tree is transformed into the taxonomic hierarchy used as a classification. In creating categories, systematists choose sets that naturally reflect the hierarchy inherent in the tree.

Despite the utility of the traditional taxonomic hierarchy in summarizing diversity and evolutionary relatedness, there are real problems in incorporating elements of the phylogeny into the hierarchy in a precise way. The difficulties relate to the subjectivity in deciding taxonomic rank, and the fact that phylogenies often imply hierarchies with more levels and greater asymmetry than is allowed in the taxonomic hierarchy. A simple example given in Box 2.1-3 makes this clear.

Some biologists (lumpers) stress similarities held in common by the organisms being studied and so tend to group several species into a single genus as in Box 2.1-3 (a). Others (splitters) stress differences between the species and so tend to divide the species into several different genera (Corliss 1976) as in Box 2.1-3 (d).

As a group of species is studied in more detail, it is not uncommon for it to be ever more finely subdivided or for the group as a whole to be elevated to a higher taxonomic category. This simply reflects the fact that detailed study uncovers more characters that emphasize the differences among the species. Microsporidia, which comprise a unique group of obligate, intracellular parasitic protists, are such a group now receiving increased taxonomic attention. Until recently, their ubiquity did not cause a threat to humans and few systematists worked to describe and classify the species. But since 1985, physicians have documented an unusual rise in worldwide infections in AIDS patients caused by four genera (*Encephalitozoon*, *Nosema*, *Pleistophora* and *Enterocytozoon*), and identifying microsporidian species is impeding diagnosis and effective treatment of patients. As a result, research has been focused on the group and the number and diversity of forms observed have risen sharply.

2.1.3.3 Why do classification schemes change?

Scientists working in genetic resources, biotechnology, agriculture, conservation and other disciplines that use existing classifications are often disconcerted to find that systematists change the classification scheme. These changes are, however, just the logical consequences of discovery of new data and new taxa, and correction of two kinds of mistaken interpretation.

New technologies constantly give rise to new sources of character information. New information reveals new similarities and differences among taxa that cause us to revise the placement of a taxon in a tree, or to choose to

Box 2.1-3: A phylogenetic tree which shows relative relatedness between ten species (A–J).

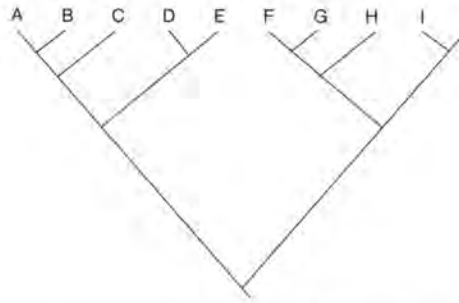

In this tree, A and B share a common ancestor and so are called sister taxa. Examining this tree you see that D and E, F and G, and I and J are also sister taxa. The sister group to species C is the group A + B, and so forth. There are several different ways to sort these species into acceptable, monophyletic genera, shown below. For example, the decision to place taxon C as one of many species in a genus (a) or as a single species in its own genus (d) is an artificial decision based on the personal preference of the taxonomist.

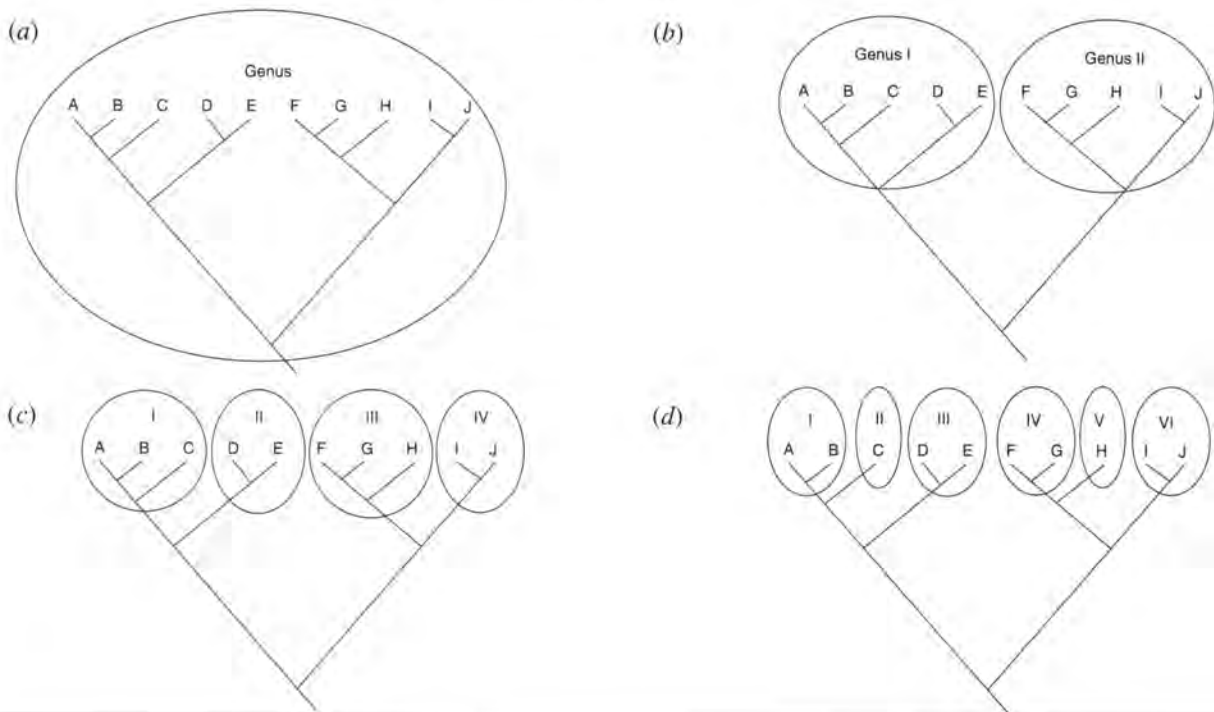

lump or split a taxon within an existing classification. An example of this sort of change is illustrated dramatically by the revision of prokaryote classifications resulting from molecular genetic data that have become available only within the past decade (Figure 2.1-5).

The discovery of previously unknown species will also change classifications. If unique, these species will have to have new taxa created for them. In addition, they have new characters or new combinations of characters whose study revises our hypotheses about evolutionary relationships of all the taxa. There have been some recent spectacular discoveries of new vertebrates such as the plankton-feeding megamouth shark described in 1983, the Vu Quang antelope of Southeast Asia in 1993, and the golden bamboo lemur (*Haplemur aureus*) from Madagascar in 1986. But

this is only the tip of the iceberg. Many more new species (especially microscopic organisms) are waiting to be discovered. Indeed, we cannot presently say how many species exist on Earth and some people's estimates range over an order of magnitude, from 5 to 80 million species. For most species that have been documented, relatively little is known about their historical relationships, biological characteristics, or distributions within the Earth's habitats and ecosystems.

The first common sort of interpretative mistake that bedevils systematic analysis is the discovery that the defining features of a taxon are convergent rather than homologous (see 2.1.3.1). The taxon then is known to be *polyphyletic* (the taxa do not share a recent common ancestor but instead the group has been defined by a

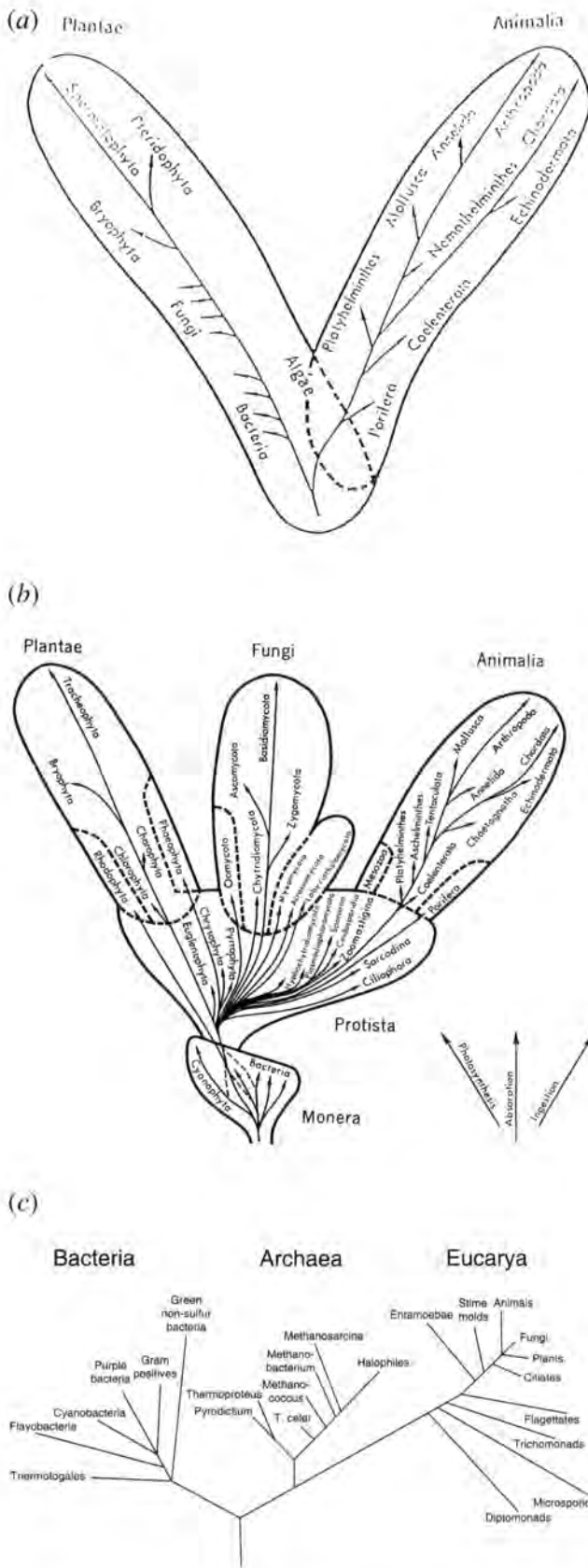

Figure 2.1-5: Fundamentally different views of the taxonomy of life based on (a) gross morphology (two kingdoms as reconstructed by Whittaker 1969), (b) cell structure and organelles (five kingdoms, Whittaker 1969) and (c) DNA sequence data (three domains, Woese 1994).

superficial similarity that does not indicate evolutionary relatedness). When this happens, the polyphyletic groups are abandoned and several monophyletic taxa are created in its place. For example, in Figure 2.1-4, the evidence of character 1 conflicts with that of 2 and 3. Either characters 2 and 3 are homologous and 1 is convergent, or the reverse. If scientists did not know of characters 2 and 3, but only of 1 and 4-7, the evidence of character 1 would group the cat with the wolf to the exclusion of the fox. Hence discovery of characters distributed as 2 and 3 can change phylogenetic hypotheses. In practice, most systematists do not change official classifications until the new results have been corroborated and widely accepted, but the pace of taxonomic discovery is so fast that classificatory change is still rather frequent. A real example is the almost complete restructuring of bacterial classification in the last 15 years (Figure 2.1-5).

The second common error found in taxonomic classifications occurs because primitive features of organisms have been mistakenly interpreted as novelties, or derived features, and used to define a group (see 2.1.3.1). In Figure 2.1-4, the cow, horse and cat are alike in characters 2 and 3. However, grouping these three taxa on the basis of characters 2 and 3 would be incorrect because they share no unique common ancestor. The only ancestor that includes cows, horses, and cats also includes foxes and wolves. The implication is that any biological prediction made for cows, horses and cats will either be true also for foxes and wolves (if it evolved at node 1, Figure 2.1-4), or for an even more inclusive group of mammals (if it evolved prior to node 1). Groups defined by primitive features are called paraphyletic because they include only some of the descendants' most recent common ancestors. For example, scientists used to call all animals except vertebrates the Invertebrata. But the only defining trait of invertebrates is the absence of a vertebral column, an absence equally well shared with tomatoes and, for that matter, stones. Aside from the original observation (that some species lack vertebrae), invertebrates as a group share no traits not also present in at least some vertebrates.

2.1.4 Characterizing species

For as long as humans have observed the tremendous diversity of life, they have attempted to sort organisms into recognizable kinds and to give names to them. In all groups of organisms the basic unit of classification is the *species*. The earlier concept of fixed and unchangeable kinds can be traced to the idealism of Plato and Aristotle. Belief in the notion of fixity continued to influence biology into the nineteenth century until destroyed by evolutionary thinking.

Today, species are recognized and conceptualized in three rather different ways. They may be seen to be distinct (the *morphological species concept*); members of the species may be united by shared inheritance from common ancestry (the *phylogenetic species concept*); and there may

be biological processes such as mating, recognition and behaviour that unite members of one species and distinguish them from others (the *biological species concept*). In many groups large numbers of species are easily recognizable, and, if investigated sufficiently, may satisfy all or several of these criteria. But in other groups and in other species, variation patterns may be obscure or insufficient information may be available: in some it may be difficult to find a workable species concept, in others a minority of species are in complexes where the boundaries are uncertain. It is, after all, an amazing achievement even to attempt to categorize into comparable units organisms as different as elephants and bacteria. Despite the universal and successful usage of the species, its precise definition is, and probably always will be, the subject of vigorous debate within the taxonomic discipline. There is no scientifically precise, universally applicable species definition. In practice there is no choice but to pursue a pluralist approach, using where appropriate one or other of the three main concepts given above.

A theoretical view is that each element in the classification is a hypothesis. This illustrates nicely the relation between the three main species concepts. The description of a species on the basis of the morphological concept is interpreted as hypotheses that (1) its unifying characteristics were inherited from common ancestors (the phylogenetic concept) and (2) there is in place some biological mechanism that maintains its distinctness from adjacent species (the biological concept). These hypotheses can then be tested.

The time when the species was considered the smallest unit of variation observed is long past. Detailed observation and knowledge of genetics mean that today biologists are extremely conscious of the range of variation that occurs within each species (see Chapter 2.2), and of the possibilities for classifying subunits within the species – subspecies, varieties and informal races in the wild; or cultivar groups, cultivars and breeds under domestication (see Table 2.1-1). However, the morphological and phylogenetic species concepts do still depend on being the smallest unit that is clearly distinct, or clearly diagnosable.

2.1.4.1 The morphological species concept

The most widely used method of recognizing species is referred to as the *morphological species concept*, defined in Box 2.1-4. The term morphological is, however, a misnomer as the concept is applied to any sort of comparative information on heritable characteristics (Davis and Heywood 1963) such as data on behaviour, phytochemistry and microanatomy. In the ideal case there is continuity of variation within and a distinct discontinuity between species. In practice it is the presence of clear discontinuities such as a correlated discontinuity in two or more characters that circumscribes the species (Hedberg 1958; Davis and Heywood 1963). Ideally all members will possess the diagnostic

characters of the species. In reality some species are polythetic, that is, defined by a combination of characters, any one of which might be absent in one member of the species, a property analogous to fuzzy sets in mathematics.

A variant of this concept is the *monotypic species*, widely used in the great Russian schools of taxonomy. Here emphasis has been on the smallest indivisible unit, that is, on uniform homogeneity within the units rather than clear discontinuity between them (Komarov 1944; Juzepczuk 1958). Such a system was considered by some authors to be advantageous in floristic work and in inventorying natural or genetic resources: every recognizably distinct form is named and catalogued separately.

A special case is used in the recognition of bacterial species where there are few morphological features. The DNA/DNA hybridization technique is used to assess the DNA resemblances of different bacterial strains. Strains with DNA resemblances above 70% are treated as members of the same species.

2.1.4.2 The biological species concept

In the nineteenth and early twentieth centuries attention turned to species as biological units, giving rise to what we now call the *biological species concept* (defined in Box 2.1-5). The concept emphasizes interconnected populations of interbreeding organisms. The key criterion for delimiting species boundaries is *reproductive isolation* (Vavilov 1931; Mayr 1963, 1970; Zavadsky 1968). The classical literature also refers to the *polytypic concept*, referring to something broadly equivalent to the biological species (Vavilov 1931;

Box 2.1-4: Morphological species concept.

Morphological species concept (Du Rietz 1930; Cain 1954; Mayr 1963; Shaw 1964)

The smallest natural populations permanently separated from each other by a distinct discontinuity in the series of biotypes.

Comment: The concept most commonly used by practising systematists. Many schools of application suggest a minimum of two correlated characters to characterize a sufficient discontinuity.

Criticism: Morphological or comparative criteria may not reflect actual links that hold organisms together into a natural unit. In sexually outbreeding organisms, some morphologically distinctive forms can freely interbreed to produce healthy, fertile offspring while other similar forms do not interbreed. Well known cases include cryptic species, polytypic species and ecophenotypes (Mayr 1963, 1982).

Box 2.1-5: Biological species concepts.**Biological species concept I** (Dobzhansky 1937; Mayr 1940, 1969)

A species is a group of interbreeding natural populations that are unable to successfully mate or reproduce with other such groups.

Comment: One of the most popular species concepts because it conforms to the popular view of how evolution occurs. An important point of this definition is that species are not distinguished by degree of difference, but by failure to reproduce with other species. Two species may appear extremely similar, but if they do not interbreed then they are two distinct species.

Criticisms:

- (a) It is irrelevant to asexual or parthenogenetic organisms where reproduction occurs without interbreeding even though their role in the ecosystem is the same as sexual species.
- (b) Relatedness and ability to reproduce are not always tightly linked (Rosen 1979; Baum 1992).
- (c) The amount of interbreeding between groups varies and it is not clear how much is necessary to identify two groups as belonging to the same species or how little indicates that the two are separate species. This question has been particularly troublesome in botany where phenomena such as natural hybridization, polyploidy, apomixis and interspecific introgression (see Chapter 2.2) complicate the delimitation of species (Levin 1979; Grant 1981).
- (d) Although the biological species concept may be accepted by biologists as an accurate description of what species are, it may not be used in practice by systematists because it can rarely be applied to real groups of organisms. Often reproductive isolation is inferred (not observed) from the absence of individuals with intermediate characteristics between two groups or by making assumptions about specific evolutionary processes (Mishler and Brandon 1987). Interbreeding is very difficult to observe in nature especially if groups are geographically or temporally separated. The systematist is effectively left having to guess whether groups would interbreed if they were living in the same time and place. Simply bringing the groups together in captivity or cultivation and seeing if they will cross is not sufficient as it is well known that under such artificial conditions many organisms will fail to breed even if they are members of the same species in the wild. Furthermore, separate species may breed in artificial conditions, even if they would not do so in the wild.

Biological species concept II (Mayr 1982)

A species is a group of interbreeding natural populations unable to successfully mate or reproduce with other such groups, and which occupies a specific niche in nature.

Comment: The introduction of 'niche' broadens the original biological species concept to include asexual and parthenogenetic species.

Criticisms: Criticisms b, c, and d of the biological species definition I (above) also apply to this concept. Furthermore, problems with defining 'niche' make this concept hard to apply in natural settings (Hengeveld 1988).

Recognition species concept (Paterson 1978, 1982, 1985; Vrba 1984)

A species is a group of organisms that recognize each other for the purpose of mating and fertilization.

Comment: This concept shifts attention from isolating mechanisms as barriers to breeding, to features that facilitate breeding among members of a species. It is supposed that the systematist is able to determine what features are important to the organisms in mate recognition. If this is possible, one could distinguish natural species in the same manner that the organisms do.

Criticism: Determining whether a feature is used to recognize potential mates is difficult or impossible to do in many wild populations. Furthermore, species that occasionally form hybrids would be considered the same species by this concept (Butlin 1987).

Cohesion species concept (Templeton 1989)

The smallest group of cohesive individuals that share intrinsic cohesion mechanisms.

Comment: Like the biological species concept and the recognition species concept, the cohesion concept accepts interbreeding ability as a mechanism that binds organisms into a group. In addition, it recognizes other mechanisms, such as niche requirement, as causing cohesion too.

Criticism: Cohesion is operationally difficult to recognize and applying this concept to problems of recognizing species in nature is almost impossible. Furthermore, it is not clear how to interpret varying degrees of cohesion between groups (Endler 1989).

Ecological species concept (Van Valen 1976)

A lineage which occupies an adaptive zone different in some way from that of any other lineage in its range and which evolves separately from all lineages outside its range.

Comment: The ecological species concept supposes that niches are discrete adaptive zones with gaps between. If an organism whose attributes adapt it for life in one of the gaps between niches will be maladapted: it will be fit to exploit resources that do not exist, or to avoid non-existent parasites or predators.

Criticism: Adaptive zones may be difficult to define in the real world, making this a difficult concept to apply practically. Furthermore, it is based on the often false premise that two species cannot occupy the same niche even for a short period of time (Wiley 1978).

Zavadsky 1968; Takhtajan 1984; Agaev 1987). In some cases a complex pattern of various forms is bounded by a discontinuity and the taxonomist infers, but without experimental work, that this is one polymorphic biological species.

The biological species concept has functioned well when applied to the major well-known groups of sexually outbreeding organisms. Indeed the link with population genetics and ecology had proved so robust that to many experimental and field biologists this has become the true species that exists as a biological unit, and whose membership can be determined by biological testing (see Chapters 2.2 and 2.3). What are often forgotten, however, are the real limitations on the applicability and functioning of the biological species concept (see Box 2.1-5). By its very definition it can only be applied to organisms with sexual breeding, and a large number of organisms do not fall in this category. Reproductive isolation also proves to be incomplete in some groups: it is particularly in plants that natural hybridization, introgression, the formation of polyploids from hybrids, and hybridization between polyploids (see also Chapter 2.2) all create circumstances where there is no clear demarcation (Stebbins 1950; Grant 1981). Manipulation of these mechanisms is of intense interest to plant breeders (see Chapter 2.2) and has led to development of the gene-pool concept (Harlan and de Wet 1971), where Gene pool 1, (Figure 2.1-6), Gene pool 2, and Gene pool 3 represent various outer levels of hybridization and occasional gene flow. But even this eminently practical scheme can be challenged on the basis that in nature there

are many examples of populations separated by only a few kilometres that rarely if ever exchange genes (Ehrlich and Raven 1969; Levin 1979).

2.1.4.3 The phylogenetic species concept

A second set of species concepts views species as the terminal twigs on the evolutionary tree. Speciation is the process by which new lineages originate. Similar

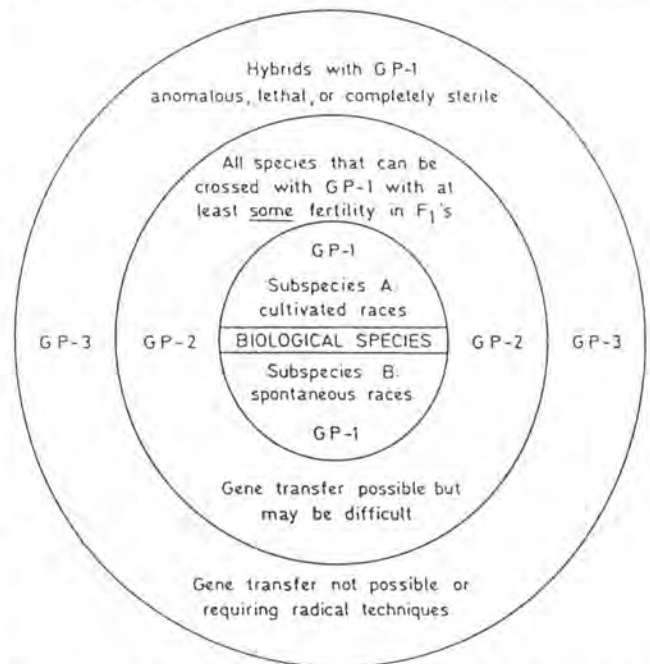

Figure 2.1-6: The gene-pool concept proposed by Harlan and de Wet (1971). Satisfactory only after all the taxa concerned have been intensively studied and satisfactorily classified.

Box 2.1-6: Evolutionary species concepts.

Evolutionary species concept (Simpson 1951, 1961; Wiley 1978)

A species is a single lineage of ancestor–descendant populations which is distinct from other such lineages and which has its own evolutionary tendencies and historical fate.

Comment: This broad definition is intended to define species in terms of the evolutionary process and would thus include living, extinct, sexual and asexual organisms.

Criticism: The concept is difficult to use when trying to identify species in nature because the criteria – evolutionary tendency and historical fate – are vague and difficult to observe (Hecht and Hoffman 1986).

Phylogenetic species concept (Rosen 1979; Eldredge and Cracraft 1980; Nelson and Platnick 1980; Cracraft 1983; Nixon and Wheeler 1990, 1992)

A species is the smallest group of organisms that is diagnosably distinct from other such clusters and within which there is a parental pattern of ancestry and descent.

Comment: This concept focuses on the phylogenetic history of organisms and considers a species to be the last diagnosable or undivided twig on a phylogenetic tree.

Criticism: As pointed out by Wheeler (1990), application of the phylogenetic species concept would almost certainly give far greater estimates of the total number of species than the more traditional biological species concept. As taxa are examined in more detail (especially with molecular genetic techniques), the chances of finding slight differences between small subgroups increases, and those would be named as separate species under this definition.

organisms, regardless of mode of breeding, owe elements of their resemblances to inheritance from a common ancestor. We thus have the *evolutionary species concept* (Simpson 1951) and the *phylogenetic species concept* (Cracraft 1983) (see Box 2.1-6). A difficulty, at least in long time-spans, is that an evolving species may eventually become so different that it can be considered a different species. At what point in time is the separation made (Lovtrup 1979)? In practice these concepts again recognize species on the basis of distinguishing characteristics: the results may not be much different from applying the morphological concept, in some cases, the emphasis is placed on the smallest phylogenetic element, so that, as with the monotypic concept, each recognizable unit may become a species.

A special form of the phylogenetic species concept has been adapted (ICTV 1991) for the definition of virus species. A virus species is a polythetic class of virus that constitutes a replicating lineage and occupies a particular ecological niche (Van Regenmortel 1990). The niche of a virus can often be quite clearly demarcated by environmental determinants such as host, tissue and vector tropisms (Franki *et al.* 1991).

2.1.4.4 The pluralistic approach

One can argue that for the whole of species diversity to be built on such an uncertain unit as the species is very unsatisfactory. It is, however, the best: the only unit that we have! Because many patterns of variation are found in

nature, a pluralistic approach to species demarcation is necessary to answer to the needs of taxonomists and other scientists working with different groups of organisms (Mishler and Donoghue 1982).

The vast majority of species are still recognized by taxonomists on the basis of observed discontinuity (the morphological species concept). Experimental investigation of breeding patterns and careful phylogenetic analysis enrich our knowledge and in many cases clarify species circumscriptions, but they are too expensive to apply to all species. In practice the classical process is cheap, effective and answers most needs.

One practical effect of the debate on species definitions is that the species concepts actually applied may be broader or narrower at different times or between taxonomists in different places. What are described and given the rank of separate species in one treatment may sometimes be aggregated into a single more inclusive species in another. Units given originally as separate species may then be described and named by another author as subspecies or varieties within one broader species. For example, several species of peas (wild species *Pisum elatius* and *Pisum humile*, and cultivated species *Pisum arvense* and *Pisum sativum*) were subsequently found to be interfertile and thus thought of as members of just one species (now *Pisum sativum*) using the biological species concept (Makasheva 1979). However, the originally discernable units are now referred to as botanical varieties within the one species (e.g.

Box 2.1-7: Different layouts for printed classifications. (a) is part of a Checklist giving a linear listing of taxa (Corbet & Hill 1991). (b) is part of a Flora showing the taxa again in linear sequence but now with descriptions and keys included in the sequence (Tutin *et al.* 1964–80).

(a) Checklist layout.

SUBORDER MICROCHIROPTERA

Family Rhinopomatidae



Greater mouse-tailed bat
(*Rhinopoma microphyllum*)

Mouse-tailed bats (rat-tailed bats, long-tailed bats); 3 species; Morocco, Senegal – Thailand, Sumatra; mainly desert and steppe; insectivorous.

Rhinopoma

<i>R. hardwickii</i>	Lesser mouse-tailed bat	Morocco, Mauretania, Nigeria – Kenya – Thailand
<i>R. microphyllum</i>	Greater mouse-tailed bat	Senegal – India; Sumatra
<i>R. muscatellum</i>		S Arabia – W Pakistan

Family Emballonuridae

Sheath-tailed bats (sac-winged bats, pouched bats, ghost bats); c. 49 species; tropics and subtropics of world; insectivorous.

Subfamily Emballonurinae

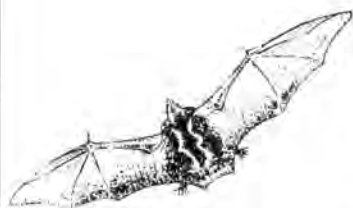

Sac-winged bat
(*Saccopteryx bilineata*)

Emballonura; Old-world sheath-tailed bats; Madagascar, S Burma – Pacific Islands.

<i>E. alecto</i> (<i>rivalis</i>)	Philippine sheath-tailed bat	Philippines, Borneo – S Moluccas, Tanimbar Is; ref. 4.143
<i>E. atrata</i>	Peters' sheath-tailed bat	Madagascar
<i>E. beccarii</i>	Beccari's sheath-tailed bat	New Guinea, etc.
<i>E. diana</i>	Rennell Island sheath-tailed bat	New Guinea, New Ireland, Malaita, Rennell Is, Solomons; ref. 4.26

(b) Flora or Fauna layout.

CLXVII. DIPSACACEAE¹

Annual to perennial herbs, rarely shrubs. Leaves opposite or verticillate, exstipulate. Florets in a dense, cymose capitulum subtended by involucre bracts, often with marginal flowers radiate, rarely in a spike of verticillasters. Florets hermaphrodite or female, usually zygomorphic, each with a basal epicalyx (involucre) of connate bracteoles which may be expanded distally into a *corona*, often subtended by a receptacular scale. Calyx small, cupuliform or divided into 4–5 teeth or of numerous teeth or setae. Corolla-lobes 4–5, subequal, or corolla 2-lipped. Stamens 2 or 4, epipetalous, alternating with corolla-lobes. Ovary inferior, 1-locular; ovule 1, pendent; stigma simple or 2-lobed. Fruit dry, indehiscent, enclosed in epicalyx and often surmounted by persistent calyx; seed 1, endospermic, with straight embryo.

- | | |
|--|--------------------------|
| 1 Inflorescence a spike of verticillasters | 1. Morina |
| 1 Inflorescence of 1 or more capitula | |
| 2 Stems with prickles | 3. Dipsacus |
| 2 Stems without prickles | |
| 3 Involucre bracts connate in basal half; calyx-setae present only in central florets of capitulum | 10. Pycnocomon |
| 3 Involucre bracts free; calyx-setae present or absent in all florets | |
| 4 Calyx-setae plumose | |
| 5 Fruiting involucre with longitudinal furrows running the whole length | 7. Pteroccephalus |

¹ Edit. D. M. Moore.

² By J. F. M. Cannon.

- | | |
|--|-----------------------|
| 5 Fruiting involucre with 8 pits in distal half, furrowed below | 9. Tremastelma |
| 4 Calyx-setae absent or, if present, not plumose | |
| 6 Calyx-setae or -teeth (6–18–16–24); receptacle hairy, without scales | 6. Knautia |
| 6 Calyx-setae or -teeth 4–5 or absent; receptacle not hairy, with scales | |
| 7 Marginal florets radiate; corolla 5-lobed | 8. Scabiosa |
| 7 Marginal and central florets subequal; corolla 4-lobed | |
| 8 Involucre bracts in more than 3 rows | 2. Cephalaria |
| 8 Involucre bracts in 1–3 rows | |
| 9 Calyx-setae 4–5; involucre angled | 4. Succisa |
| 9 Calyx-setae absent; involucre ± terete | 5. Succisella |

1. Morina L.²

Perennial herbs. Leaves verticillate, spinose. Inflorescence a spike of many-flowered, bracteate verticillasters. Involucre long, infundibuliform, spiny. Calyx deeply 2-lobed. Corolla with curved tube, distinctly 2-lipped. Fertile stamens 2. Fruit with an oblique apex, rugose.

1. M. persica L., *Sp. Pl.* 28 (1753). Robust plant 30–90 cm. Leaves 15–20 × 1–2 cm, linear to elliptical, dentate to pinnatifid, glabrous. Verticillasters rather distant; bracts 2–4.5 × c. 1 cm, ovate-triangular, sometimes pinnatifid near base, with marginal spines up to c. 1 cm. Calyx-lobes subequal, entire or emarginate.

P. sativum var. *elatius*, etc.; Davis 1970). The reverse process can be seen with the application of phylogenetic species concepts to birds, where recognizably distinct subspecies under the biological species concept, usually geographical races, could be segregated into separate species using the phylogenetic concept. Regional inconsistency in assignment of the species rank by taxonomists can be seen in *Flora Europaea* (Tutin *et al.* 1964–80), where species described by Russian botanists using a monotypic concept have in a few instances been listed alongside wider species described by Western Europeans using the biological species concept. The broom genus *Chamaecytisus* is, for example, given as having a large number of narrow-concept species whose distribution stops abruptly at the boundary of the former Soviet bloc countries, and fewer broad-concept species west of this boundary.

For the vast majority of species the exact definition used makes little difference to the unit circumscribed. Only for the minority, usually where there are clusters of similar forms, can the concept used have the effects described. But users of the taxonomy should be aware that total species numbers may vary from one treatment to another, and in some groups the question of rarity and endemism may interrelate with varying views of what constitutes species.

This brings to an end our introduction to taxonomic and evolutionary characterization (2.1.0–2.1.4). What follows in Section 2.1.5 illustrates the wide and fundamental way in which the taxonomy underpins all knowledge of biodiversity: it provides a rich information structure and a picture of the natural map of diversity. Lastly, Section 2.1.6 highlights the view of many taxonomists and evolutionary biologists that the mere counting of species is a rather uninformative and unrepresentative way of measuring species diversity. The taxonomy provides a map, and species diversity should be characterized as dispersion on this map, with particular value given to distant islands and wide-ranging spans.

2.1.5 The power of taxonomy and taxonomic products

2.1.5.1 Taxonomic products: an essential technological infrastructure for biotechnology, natural resources management, and regulation

The single most important use of taxonomy is to provide the core reference system for organisms used throughout biology and its associated sciences and industries. The taxonomic classification is similarly the core reference system for biodiversity (Janzen 1993). This reference system is made available through the range of taxonomic products such as the Floras, handbooks and keys already discussed. The dissemination of certain basic information about the organisms is also traditionally incorporated with some of these, such as morphological descriptions and

images of flowers and leaves for plants, maps plus behavioural and song descriptions for birds, etc.

How are these products actually used to disseminate the reference system? Whilst there are many variations in detail, they are composed of just four principal features, each with its own function:

(1) **The classification.** The classification is given either as a concise checklist or by the structure provided by the sequence of organism entries in the book. (see Boxes 2.1-7 and 2.1-8). The classification provides reference information on the existence and taxonomic position of each organism.

Much the commonest starting point is the name of an organism. From the name one can learn what the organism looks like, where it occurs, what other organisms have similar characteristics or are genetically related to it, and much else about its biology and role in the environment: the name and the place in the classification provide a vehicle through which this information is obtained.

What if the enquirer does not know the name? In this case the enquirer must first go to the identification routine: find out the name of the organism under scrutiny. The quest for further information can then be the standard one starting from the name.

(2) **The nomenclature.** The nomenclature provides the scientific names used to label and retrieve organisms and groups of organisms. Users also need to be alerted to cases where an organism or group of organisms has previously been known by other names which can be treated as synonyms for the same. Because the names are needed to label the entries they are presented as part of the classification in products such as handbooks and Floras. Checking what the names are, and checking the spellings and authors are important infrastructure services for those dealing with organisms in many biological professions. Examples are given in Box 2.1-9.

(3) **Descriptions/circumscriptions.** To be logically complete, a taxonomy needs to provide not only a statement about what are the taxa, but also to circumscribe the range of variation among organisms found in each taxon. In practice, detailed circumscriptions are often kept for the technical taxonomic literature, but descriptions giving a word picture of the organism, or images of various sorts are often included as shown in Box 2.1-10. This important feature means that using many taxonomic products a user can find out what the organism listed looks like. So the enquiries illustrated in the boxes above (to find species related to *Vicia serratifolia*, or to check the name of Broom) can lead to a description, illustration and geographical distribution information for the species in question, as illustrated in Box 2.1-10.

(4) **Identification aids.** A variety of devices can be provided so that the user can examine an unknown specimen and determine where it belongs in the

Box 2.1-8: Examples of factual responses that can be obtained from the classification.

(1) Position

Where does taxon X fit in the classification? In which order, class or phylum is it to be found? Response, if X = Genus *Apis* (hive bees) –
 in the order Hymenoptera (bees, ants and wasps)
 in the class Insecta (insects)
 in the phylum Arthropoda

(2) Members of a set

What other taxa resemble taxon Y? or What is the complete list of members of the taxon containing Y? Response, if Y = *Vicia serratifolia*
 – one of 7 species in Section Faba of genus *Vicia*
 – the 7 species are:
Vicia narbonensis
Vicia serratifolia
Vicia johannis
Vicia galilaea
Vicia kalakhensis
Vicia hyaeniscyamus
Vicia faba

(3) Subordinate taxa

What are the members of taxon Z? or Provide a systematic catalogue of all members of taxon Z? Response, if Z = Genus *Acetobacter*
Acetobacter aceti subsp. *aceti*
Acetobacter aceti subsp. *orleanensis*
Acetobacter diazotrophicus
Acetobacter hansenii
Acetobacter liquefaciens
Acetobacter pasteurianus subsp. *ascendens*
Acetobacter pasteurianus subsp. *estunensis*
Acetobacter pasteurianus subsp. *lovaniensis*
Acetobacter pasteurianus subsp. *paradoxus*
Acetobacter pasteurianus subsp. *pasteurianus*
Acetobacter peroxydans
Acetobacter xylinum

classification. The commonest device is the key (see Box 2.1-11) in which the user answers a series of questions about contrasted descriptive features, and by elimination arrives at the identification of what the organism is.

2.1.5.2 As a summary of biodiversity and evolutionary patterns

The taxonomy provides considerably more than the bare bones factual information system described above (the reference system): it also provides a summary of the pattern

Box 2.1-9: Examples.

What is the correct (accepted) name for organisms labelled X?

e.g. if X = *Sarothamnus scoparius* (Broom)
 response: *Cytisus scoparius*
 (all species formerly known as *Sarothamnus* now usually included in *Cytisus*)

e.g. if X = *Vicia narbonensis* var. *serratifolia*
 response: *Vicia serratifolia*
 (now accepted as a separate species)

e.g. if X = *Cytisus scoparius*
 response: *Cytisus scoparius*
 (correct as given)

Under what names has taxon Y been known in the past?

e.g. if Y = *Rattus exulans* (Polynesian rat)
 response: *Rattus exulans* (accepted name)
Rattus bocourti (synonym)
Rattus ephippium (synonym)

of diversity and of the pattern of evolution in a group of organisms. The patterns are to be seen in the tree structure of the taxonomic hierarchy. Consider for instance the partial taxonomic hierarchy of gymnosperms shown in Figure 2.1-7.

The hierarchy depicted shows the reader that *Ginkgo biloba* (the maidenhair tree) is the only living representative of the order Ginkgoales, and that it is thus very isolated and distinct in terms of diversity from the nearest other group, the Coniferales (Conifers). Conversely, the Coniferales is made up of seven families, each of which contains several genera and many species, amounting to a total of 610 species (Mabberley 1987). For instance, the Pinaceae (Pine family) contains 10 genera, of which *Pinus* contains about 120 species world-wide and *Abies* 55 (Rushforth 1987). *Pinus* and *Abies* species are thus nowhere near being so isolated as *Ginkgo biloba*: each species has a number of other species so close or similar as to be in the same genus, and a number of close or similar genera exist within the same family and in six related families. This then is the description of a pattern of species diversity. This diversity pattern allows us to quantify the diversity of, say, forests composed of just two species of gymnosperm: the forest whose two species are both pines (*Pinus* spp.) has low diversity (they are both in the same genus), the forest with one *Pinus* and one *Abies* comes next (its species are in related genera of the same family), whilst

Box 2.1-10: Examples of descriptions, illustrations and maps from Greenwood 1987 (a), and Valdes et al. 1987 (b). The description in a) is part of a “diagnosis” or “circumscription”, an exact complete technical description of the animal. The description in b) is a brief synoptic description that could be used by botanists in general.

(a) Part of a ‘diagnosis’ and illustrations from Greenwood 1987.

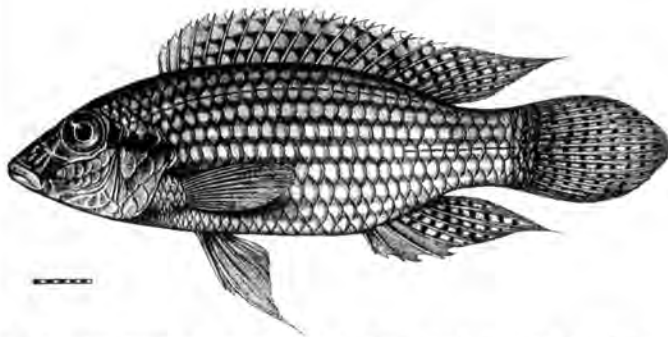

Fig. 21 *Parananchromis longirostris*; holotype. From the original drawing by J. Green. Scale bar in mms.

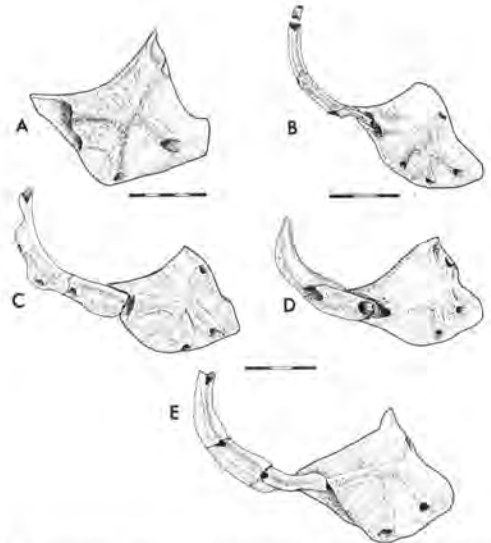

Fig. 5 Right infraorbital bones of A. *Pelmatochromis huetikoferti* (lachrymal only), B. *Chromidotilapia guentheri* (lachrymal+4 others), C. *Parananchromis longirostris* (lachrymal+2 others), D. *Pelmatochromis pulcher* (lachrymal+2 others), E. *Thysia anserigi* (lachrymal+2 others). Scale bar in mms.

(b) A description, map and illustration from Valdes et al. 1987.



Muy raro. Rupícola. Algeciras.
Distribución general. Regiones
Eurosiibertana y Mediterránea.

3. ***Polypodium interjectum*** Shivas, *Journ. Linn. Soc. London (Bot.)* 58: 29 (1961)
P. vulgare subsp. *prionodes* (Ascherson) Rothm., *Mitt. Thüring. Bot. Vereins* 38: 106 (1929)
P. vulgare auct., non L., *Sp. Pl.* 1085 (1753)

Rizoma más o menos largo con escamas densas. Escamas de (2-) 3-6 (-8) mm, lineal-lanceoladas. Hojas de (14-) 17-22 (-30) cm; limbo generalmente más largo que el pecíolo, con la anchura máxima hacia la mitad, de ovado a ovado-lanceolado, gradualmente acuminado. Pinnas agudas. Soros elípticos, sin parafisos, a veces con pelos glandulares. Anillo del esporangio con (4-) 7 (-13) células engrosadas y 2-3 células en la base. $2n = 222$. *Esporula de Julio a Septiembre.*

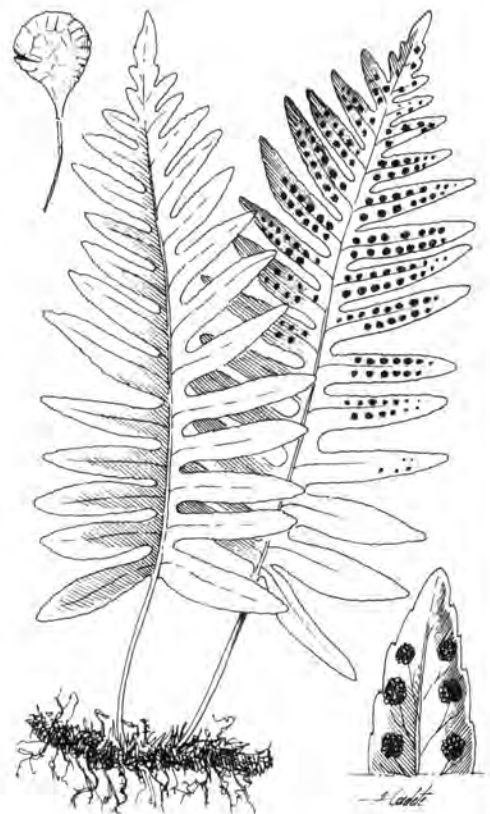

Box 2.1-11: Two examples of printed identification keys. (a) 'indented' type – the first two contrasting leads are labelled '1'; if the lower of these is selected, the next pair labelled '2' are indented, and so on. (b) The 'bracketed' type, where the contrasting leads are printed (or sometimes bracketed) one below the other, J2 and its partner, J3 and its partner, etc.

(a) Indented key to genera Turkish Gymnospermae (Davis 1970).

SPERMATOPHYTA

Gymnospermae

Krause, K. 1936. *Türkiyenin Gymnospermleri*. Ankara. Kayacik, H. 1959. *Orman ve Park Ağaçlarının Özel Sistematigi*. 1. Cilt: *Gymnospermae (Acik Tohumlar)*. Istanbul.

Key to Genera

1. Leaves reduced to scales at the nodes; equisetoid shrubs (*Ephedraceae*)
 - Ephedra**
1. Leaves not reduced to scales at the nodes; trees or shrubs, not equisetoid
 2. Mature leaves scale-like, imbricate and adpressed, or linear-lanceolate and articulate at the base (*Cupressaceae*)
 3. All leaves scale-like and imbricate; fruit a woody cone; seeds winged
 - Cupressus**
 3. At least the juvenile leaves linear-lanceolate, not scale-like and imbricate; fruit fleshy, berry-like; seeds unwinged
 - Juniperus**
 2. Mature leaves oblong-linear, not articulate at the base
 4. Leaves without resin canals; fruit surrounded by a fleshy aril (*Taxaceae*)
 - Taxus**
 4. Leaves with resin canals; fruit a woody cone, exarillate (*Pinaceae*)
 5. Mature leaves borne on short shoots, in whorls or fascicles of two
 6. Leaves in fascicles of two, each fascicle surrounded by a sheath at the base
 - Pinus**
 6. Leaves in whorls, without sheaths at the base
 - Cedrus**
 5. Mature leaves borne spirally on long shoots; short shoots absent
 7. Branchlets with numerous peg-like projections persisting after leaf-fall; cones pendulous, falling as a whole
 - Picea**
 7. Branchlets without such projections; cones erect, the scales falling from the persistent axis
 - Abies**

(b) Bracketed key to beetle families of Britain (Unwin 1984).

Beetles with elytra covering most of the abdomen. Antennae clubbed, and tarsi with some segments lobed beneath.

J1 Number of tarsal segments:

Note: in this key, small cylindrical tarsal segments (arrowed) immediately following a bilobed segment are ignored. Claws do not count as segments. Tarsal characters may be easier to see if a drop of water is placed on the tarsus.

- Tarsi with 5 segments J2
- Tarsi with 4 segments J5
- Tarsi with 3 segments J19



J2 Thorax constricted basally, beetles with a very obvious "waist". Thorax with outstanding long hairs **CLERIDAE**

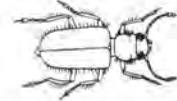

— Beetles without a distinct "waist" between thorax and elytra J3

J3 Eyes oval, over twice as high as wide, occupying most of the height of the head **BUPRESTIDAE**



— Eyes approximately circular J4

J4 Oval beetles with a wide turned-out rim to the elytra and the thorax giving a terrapin-like appearance. Tibiae not flattened and expanded **PELTIDAE**

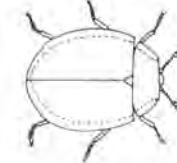

— Beetles with at most a narrow "beading" on thorax and elytra. Tibiae flattened and expanded **EROTYLIDAE**

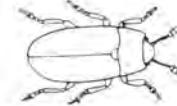

the forest (if such were to exist) with one *Pinus* and *Ginkgo biloba* has a relatively enormous diversity, because its two species are in separate orders. This patterned or qualitative view of diversity provides the basis for taxonomic or taxic measures of diversity discussed in the next section.

The same classification hierarchy can be taken to imply the shape of the evolutionary tree or phylogeny. For instance, two elements of the evolutionary pattern might be:

1. that *Ginkgo* separated from the evolutionary line of conifers at an early date, and
2. that members of the Coniferales are thought to be monophyletic, that is with a common ancestor more recent than the one they share with *Ginkgo* and with all the descendants of that common ancestor included in the Coniferales group.

However, as noted earlier, the taxonomic hierarchy can at best only loosely mirror the branching pattern of the cladistic tree. A more precise view of the hypothesized route of evolution will be obtained by examining in addition any published phylogenies for the group.

2.1.5.3 As a basis for prediction

The natural pattern reflected in the taxonomy enables scientists to make predictions about as yet unobserved features of organisms. These predictions are only probabilistic, but they can provide a powerful and economically important basis for directing future biological research. One example is the successful search for castanospermine-like substances of possible significance in HIV research in South American legume plants of the genus *Alexa*. The substances were first discovered in an Australian plant cultivated in South Africa. This was *Castanospermum australe* (Moreton Bay chestnut), the only species at that time in the genus. When phytochemists wanted to look for the substances in other plants, taxonomists predicted that the highest chance of finding similar properties would be in geographically distant *Alexa*, a South American group but, taxonomically, the closest genus to *Castanospermum*. The prediction was correct and substances related to castanospermine were successfully isolated from the South American plants. In contrast, the chances of locating the substances rapidly by a random (and consequently expensive) search amongst the 280 000 or so Flowering Plants, or indeed amongst the 1.75 million known

to a postulated African female, ancestral to all modern humans. Another use is to reconstruct the evolution of complex molecules where different variants of the molecule are present in the same organism: a classic example is the evolution of globin and haemoglobin molecules (Jeffreys 1982).

2.1.6 Taxonomic measures of species diversity

A matter for substantial debate is the question of whether all species, or indeed all higher taxa (families, genera, etc.), are to be valued equally. As described in Chapter 2.3, the most widely used measure of within-area diversity is species richness, a simple count of the number of species present, or the diversity of an ecosystem. All species are thus counted as equal. In contrast, there is a view that individual species vary enormously in the contribution they make to diversity because of their taxonomic position, and that as a consequence measures of ecosystem diversity should include a taxonomic measure of diversity amongst the species contained. Two particular arguments are the widely expressed view (IUCN 1980) that taxonomically isolated species or species of isolated genera are of high value (such as the ginkgo, *Ginkgo biloba*, the tuatara, *Sphenodon*, or the coelocanth, *Latimeria chalumnae*) and that when valuing sets of species, a wide taxonomic range of species encompasses more species diversity than an equal number of closely related species from the same genus. Faith (1992) introduced the concept of *feature diversity* and links this to the discussion on option value and conserving variation for future use (McNeely *et al.* 1990).

Although most taxonomists and evolutionary biologists have clear concepts of taxonomic isolation and of taxonomic diversity, there were until recently no precise measures by which these concepts could be quantified. Initial suggestions by May (1990), Faith and Cawsey (1990) and Vane-Wright *et al.* (1991) led to proposals for a quantitative framework which is further developed, along with examples of application to conservation evaluation, in the symposium volume *Systematics and Conservation Evaluation* (Forey *et al.* 1994).

2.1.6.1 Evaluating taxonomic isolation of individual species

The traditional method of referring to isolated species has been to label a taxon in the classification as *monotypic*: a *monotypic genus*, *monotypic tribe*, *monotypic family* or *monotypic order* contains just one species. A quantitative scale, analogous to what is called node counting (Faith 1994) is implied in this measure. For instance, use of the phrase *monotypic genus* implies that the one species is isolated at one level of the taxonomy, but maybe not at the next level, where this and other genera may belong to the same tribe. *Monotypic family* (one species in a family) means that the tribe and genus levels must also be monotypic, so this family

is monotypic at all three levels. Examples include *Ginkgo biloba*, sole species in the Ginkgoaceae discussed above, the fern *Loxoma cunninghamii* (New Zealand), sole species in the genus *Loxoma*, and many others. The node-counting analogy, however, is obscured by the fact that taxonomists do not bother to name monotypic taxa at many ranks for a single species as it would serve no purpose, whereas in species-rich groups they use many intermediate ranks (subfamily, tribe, subtribe, subgenus, section, subsection). Whether or not a group is monotypic must be seen in relation to a time frame. The Ginkgoaceae, for instance, is monotypic today, but other now extinct species occurred earlier in the fossil record.

The monotypic measure is a measure of isolation from the isolated species to the nearest other species in the classification, or if the tree is derived from a phylogeny, from the closest related species. Several authors (Faith and Cawsey 1990; Crozier 1992; Faith 1992; Weitzman 1992) have proposed quantitative measures of species distinctiveness. The method of Faith (1992) measures spanning sub-tree length (distance along branches of the phylogenetic tree) between an isolated species and its closest related species, ideally measured on a fully worked phylogeny. Where a phylogenetic tree is not available Faith suggests using the distances along branches of the classification tree, effectively node counting as with traditional monotypic statements.

These measures may be used in conservation evaluation where a set of species is already protected (e.g. by law, within other reserves, in other countries), to evaluate which is the most isolated species whose additional protection would add most to the set already conserved. Faith (1992)



Figure 2.1-8: A map of Australia showing botanic regions. Numbered regions are those making high contributions to phylogenetic diversity (from Faith 1994).

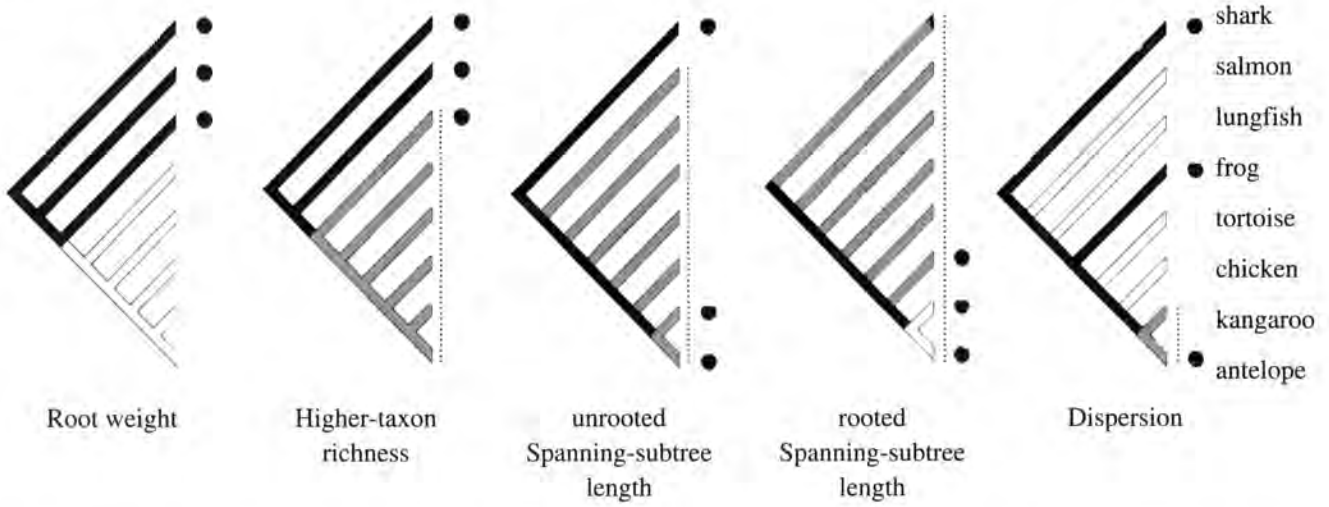

Figure 2.1-9: Classification of eight surviving species showing which biotas of just three species would score most highly when using each of the measures of taxonomic diversity. The selected species are shown by black spots, with any equally highly scoring alternatives for each choice shown bracketed by dotted lines. The groups within the classification that are essential to represent high diversity value using each measure are shown in black, groups which remain alternative choices are shown stippled, and groups which are of low diversity value are shown in white outlined in black (from Williams & Humphries 1994).

describes using his measure to evaluate orchid floras in Australia. Thirty-two species and two endemic genera, *Trichoglottis* and *Aphyllorchis*, occur in the Cape York region (Region 40 in Fig. 2.1-8). He applies his measure (to the albeit poorly known phylogeny of orchids) to evaluate which of the 71 regions contains other orchid species whose degree of taxonomic isolation would add most if added to the protected set. Region 63 (Central Coast, New South Wales) and Region 1 (SW Western Australia) add

most, followed by Regions 53, 66, 67 and 71. The result is interesting both because of the evident complementarity implied (Regions 40, 63 and 1 are at diametrically opposite corners of Australia with widely different habitats), and because the ranking of evaluations was different from that obtained by valuing numbers of endemic species, the species traditionally thought of as valuable or at risk. Complementarity means that effective conservation of a valuable subset of taxa requires attention to conserving

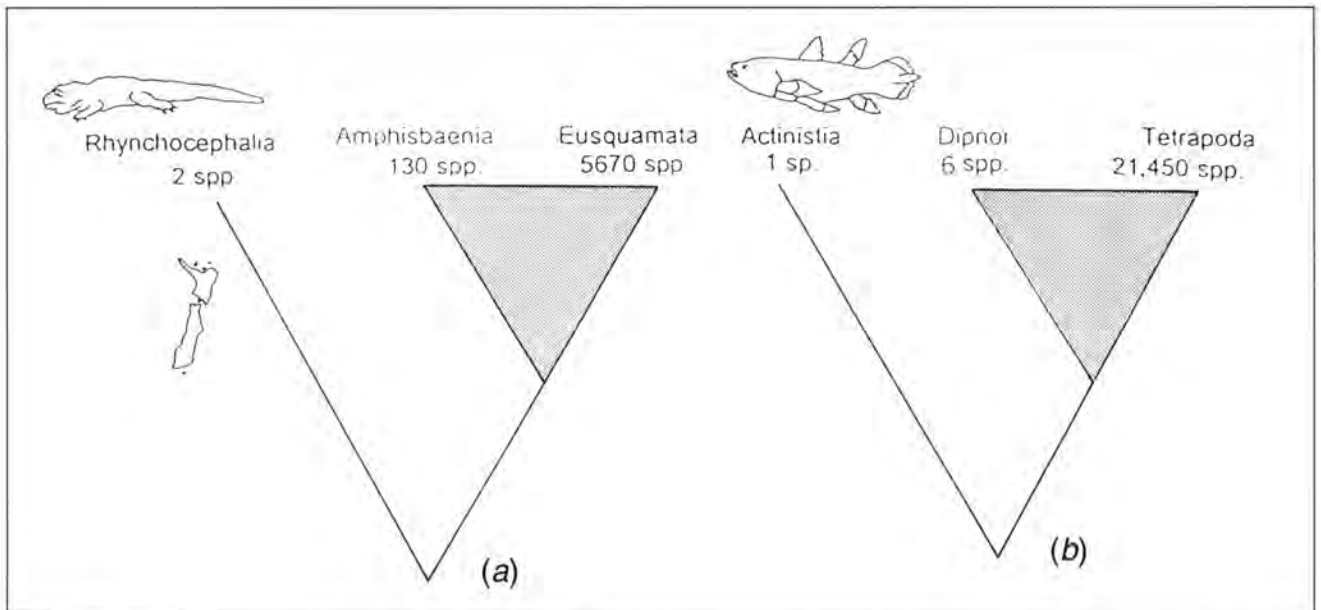

Figure 2.1-10: (a) Systematic position of *Sphenodon* (see Daugherty *et al.* 1990). Inset indicates geographical distribution of *Sphenodon*, restricted to the islands of New Zealand. (b) Systematic position of *Latimeria* (see Rosen *et al.* 1981). Inset indicates the geographical distribution of *Latimeria*, restricted to deep water habitats off the islands of Grande Comore and Anjouan.

taxonomically different, complementary taxa often in different habitats, rather than focusing on single species hot-spots or areas of endemism.

2.1.6.2 Measuring taxonomic diversity of biota or ecosystems

Williams and Humphries (1994) review the methods proposed for measuring the taxonomic spread or diversity covered by a set of species, such as those in a single ecosystem or biota. They too assume that the methods will be most widely applied to the taxonomic hierarchy itself, although in some cases a phylogeny may be available. The differences between the measures are illustrated in Figure 2.1-9, taken from their paper, which illustrates how different measures would lead to the selection of different species for conservation in an example set.

It has been suggested that a key element in taxonomic diversity is the number of higher taxa present, or to focus on the *basal taxa* in a phylogeny or cladistic tree (Williams *et al.* 1991; Stiassny 1992). Stiassny and de Pinna (1994) have reported an intriguing number of cases of high-level phylogenetic asymmetry where the basal taxa on a tree are both monotypic or bi-typic relict species, *and* endemic, *and* rare, such as *Sphenodon* and *Latimeria* illustrated in Figure 2.1-10. Endemism and rarity are eco-geographic features, however, largely unrelated to taxonomic isolatedness. Two of the measures that take into account higher taxa, the root weighted method of evaluation (Vane-Wright *et al.* 1991) and the higher taxon richness method (Williams *et al.* 1991), are illustrated in the comparisons in Figure 2.1-10.

Versions of a direct measure of taxonomic spread have been proposed by Faith (1992), as the node-counting version of phylogenetic diversity, and by Williams *et al.* (1993) as cladistic path length. Both can be referred to as *spanning-subtree length* measures. The number of nodes on the taxonomic tree needed to link the taxa is counted, each node being counted only once.

Finally, Williams and Humphries (1994) have attempted to refine spanning sub-tree length with their *cladistic dispersion* measure which values an even representation, or evenly dispersed taxa where alternative biotas would otherwise tie on spanning sub-tree length. The method is again visualized in Figure 2.1-9.

2.1.7 Conclusion

1. Taxonomy provides the core reference system and knowledge base on which all discussion of biodiversity hinges, providing the framework within which biodiversity characterization occurs. Taxonomic characterization for all known organisms is a mammoth but essential infrastructure task with which only limited progress is being made: just 1.75 of the estimated 13 million species have so far been described, and most of

these are still poorly known in biological terms. There is not even a comprehensive catalogue of these 1.75 million known species.

2. Systematic and evolutionary studies are now providing valuable knowledge about the phylogeny of life, the scientific map of diversity. This is the map on which conservation, prospecting, exploitation, regulation and sustainable use must be planned and, indeed, without which all might be lost. It is important that assessments used in the evaluation of resources and conservation options make adequate use of taxonomic diversity measures that do take into account the positions and differing contributions made by different species.

References

- Abbott, L.A., Bisby, F.A. and Rogers, D.J. 1985. *Taxonomic Analysis in Biology: Computers, models and databases*. Columbia University Press, New York.
- Agae, M.G. 1987. Vavilov's concept of species and its development. *Genetica* **23** (11): 1949-1960 [In Russian].
- Alford, D.V. 1975. *Bumblebees*. Davis-Poynter, London.
- Atran, S. 1990. *Cognitive foundations of Natural History. Towards an Anthropology of Science*. Cambridge University Press, Cambridge.
- Berlin, B. 1992. *Ethnobiological Classification: Principles of categorization of plants and animals in traditional societies*. Princeton University Press, Princeton, NJ.
- Berlin, B., Breedlove, D.E. and Raven, P.H. 1974. *Principles of Tzeltal Plant Classification*. Academic Press, New York.
- Bisby, F.A. 1984. Information services in taxonomy. In: Allkin, R. and Bisby, F.A. (eds), *Databases in Systematics*. 17-33. Academic Press, London.
- Bisby, F.A. 1993. Progress with inventories. *Nature* **363**: 11.
- Bisby, F.A. 1994. Global master species databases and biodiversity. *Biology International* **29**: 33-40.
- Bisby, F.A., Polhill, R.M., Zarucchi, J.L., Adams, B.R. and Hollis, S. 1994. *LegumeLine (ILDIS Phase 1 Database)*. Bath Information and Data Services, Bath.
- Bisby, F.A., Russell, G.F. and Pankhurst, R.J. (eds) 1993. *Designs for a Global Plant Species Information System*. Oxford University Press, Oxford.
- Blackwelder, R.E. 1967. *Taxonomy: A text and reference book*. John Wiley, London.
- Brickell, C.D., Voss, E.G., Kelly, A.F., Schneider, F. and Richens, R.H. (eds) 1980. *International Code of Nomenclature of Cultivated Plants*. [Regnum Vegetabile No. 36]. Bohn, Schlechtema and Holkema, Utrecht.
- Burnett, J. 1993. IOPI: genesis of GPSIS? In: (Bisby, F.A., Russell, G.F. and Pankhurst, R.J. (eds), *Designs for a Global Plant Species Information System*. 334-342. Clarendon Press, Oxford.
- Butlin, R.K. 1987. Species, speciation, and reinforcement. *American Naturalist* **130**: 461-464.

- Cain, A.J.** 1954. *Animal Species and Their Evolution*. Princeton University Press, Princeton, NJ.
- Corbett, G.B.** and Hill, J.E. 1991. *A World List of Mammalian Species*, 3rd edn. Oxford University Press, Oxford.
- Cracraft, J.** 1983. Species concepts and speciation analysis. *Ornithology* **1**: 159–187.
- Crisci, J.** 1993. *Introducción a la teoría y práctica de la taxonomía numérica*. Secretaria General de la Organización del los Estados Americanos, Washington, DC.
- Crozier, R.H.** 1992. Genetic diversity and the agony of choice. *Biological Conservation* **61**: 11–15.
- Dallwitz, M.J.** 1974. A flexible computer program for generating diagnostic keys. *Systematic Zoology* **23**: 50–57.
- Dallwitz, M.J.** 1980. A general system for coding taxonomic descriptions. *Taxon* **29**: 41–46.
- Davis, P.H.** (ed.) 1965–88. *Flora of Turkey*. Edinburgh University Press, Edinburgh.
- Davis, P.H.** and Heywood, V.H. 1963. *Principles of Angiosperm Taxonomy*. Oliver and Boyd, Edinburgh.
- Darwin, C.** 1859. *On the Origin of Species by means of Natural Selection*. John Murray, London.
- Diderot, D.** 1751–65. *L'Encyclopédie, ou Dictionnaire des sciences, des arts et des métiers*. Le Breton, Paris.
- Dobzhansky, T.** 1937. *Genetics and the Origin of Species*. Columbia University Press, New York.
- Du Rietz, G.E.** 1930. The fundamental units of biological diversity. *Svensk. Bot. Tidskr.* **24**: 333–428.
- Eldredge, N.** and Cracraft, J. 1980. *Phylogenetic Patterns and the Evolutionary Process*. Columbia University Press, New York.
- Endler, J.A.** 1989. Conceptual and other problems in speciation. In: Otte, D. and Endler, J.A. (eds), *Speciation and its Consequences*, 625–648. Sinauer Associates, Sunderland, Mass.
- Eshmeyer, W.N.** 1990. *Catalogue of the Genera of Recent Fishes*. California Academy of Sciences, San Francisco.
- Eshmeyer, W.N.** 1992. (I) Biosystematic information systems: their design and utility, and (II) Information data bases for ichthyology. In: Wu, J.-L. and Chen, C.-P. (eds), *Proceedings of the Workshop on Information Management of Zoo-resources in Taiwan*, 55–68. National Science Council and Academia Sinica, Taipei.
- Estep, K.W., Rey, F., Bjorklung, K., Dale, T., Heimdal, B.R., van Hertum, A.J.W., Hill, D., Hodell, D., Syvertsen, E.E., Tabgen, K. and Thronsen, J.** 1992. *Deus creavit, Linnaeus disposuit: an international effort to create a catalogue and expert system for the identification of protistan species*. *Sarsia* **77**: 275–285.
- Estep, K.W.** and Rey, F. 1993. *Linnaeus Protist* (CD-ROM). ETI, Amsterdam.
- Faith, D.P.** 1992. Conservation evaluation and phylogenetic diversity. *Biological Conservation* **61**: 1–10.
- Faith, D.P.** 1994. Phylogenetic diversity: a general framework for the prediction of feature diversity. In: Forey, P.L., Humphries, C.J. and Vane-Wright, R.I. (eds), *Systematics and Conservation Evaluation*, 235–249. Clarendon Press, Oxford.
- Faith, D.P.** and Cawsey, E.M. 1990. PHYLOREP, software for phylogenetic representativeness. Limited circulation.
- Farris, J.S.** 1979. The information content of the phylogenetic system. *Systematic Zoology* **28**: 483–519.
- FFSSN** (Fédération française des sociétés des sciences naturelles). 1921–66. *Faune de France* (68 volumes). Lechevalier, Paris (1921–66)/Toulousaine/Librairie de la Faculté des Sciences.
- Forey, P.L., Humphries, C.J., Kitching, I.J., Scotland, R.W., Siebert, D.J. and Williams, D.M.** 1992. *Cladistics: A practical course in systematics*. Clarendon Press, Oxford.
- Forey, P.L., Humphries, C.J. and Vane-Wright, R.I.** (eds) 1994. *Systematics and Conservation Evaluation*. Clarendon Press, Oxford.
- Franki, R.I.B., Fauquet, C.M., Knudson, D.L. and Brown, F.** 1990. Classification and nomenclature of viruses. *Archives of Virology Supplement* **2**: 1–445.
- Frodin, D.G.** 1984. *Guide to Standard Floras of the World*. Cambridge University Press, Cambridge.
- Froese, R. and Pauly, D.** 1994. A strategy and a structure for a database on aquatic diversity. In: Wu, J.-L., Hu, Y. and Westrum, E.F. (eds), *Data sources in Asian–Oceanic countries*, 209–220. CODATA, Ann Arbor, Mich.
- Futuyma, D.J.** 1987. *Evolutionary Biology*, 2nd edn. Sinauer Associates, Wokingham.
- Grant, V.** 1981. *Plant Speciation*, 2nd edn. Columbia University Press, New York.
- Greenwood, P.H.** 1987. The genera of pelmatochromic fishes (Teleostei, Cichlidae). *Bulletin of the British Museum of Natural History (Zoology)* **53**: 139–203.
- Greuter, W., Barrie, F., Burdet, H.M., Chaloner, W.G., Demoulin, V., Hawksworth, D.L., Jørgensen, P.M., Nicholson, D.H., Silva, P.C., Trehane, P. and McNeill, J.** (eds) 1994. *International Code of Botanical Nomenclature (Tokyo Code)*. [Regnum Vegetabile No. 131.] Koeltz Scientific Books, Königstein.
- Haeckel, E.** 1866. *Generelle Morphologie der Organismen – Allgemeine Grundzüge der organischen Formen – Wissenschaft, Mechanisch begründet durch die von Charles Darwin reformirte Descendenz – Theorie*. 2 vols. George Riemer, Berlin.
- Hawksworth, D.L.** (ed.) 1991. *Improving the Stability of Names: Needs and options*. Koeltz, Königstein.
- Hawksworth, D.L.** 1992. The need for a more effective biological nomenclature for the 21st century. *Botanical Journal of the Linnean Society* **109**: 543–567.
- Hawksworth, D.L.** 1994. Developing the bionomenclatural base crucial to biodiversity programmes. *Biology International* **29**: 24–32.
- Hawksworth, D.L.** and Bisby, F.A. 1988. Systematics: the keystone of biology. In: Hawksworth, D.L. (ed.), *Prospects in Systematics*, 3–30. Oxford University Press, Oxford.
- Hawksworth, D.L., McNeill, J., Sneath, P.H.A., Trehane, R.P. and Tubbs, P.K.** 1994. Towards a harmonized bionomenclature for life on Earth. *Biology International, Special Issue No. 30*.
- Hecht, M.K. and Hoffman, A.** 1986. Why not neo-Darwinism? A critique of paleobiological challenges. *Oxford Survey of Evolutionary Biology* **3**: 1–47.
- Hedberg, O.** 1958. Taxonomic treatment of vicarious taxa. *Uppsala University Årsskr.* **6**: 186–195.
- Hengeveld, R.** 1988. Mayr's ecological species criterion. *Systematic Zoology* **37**: 47–55.

- Hennig**, W. 1966. *Phylogenetic Systematics*. University of Illinois Press, Urbana.
- Heywood**, V.H. 1976. *Plant Taxonomy*, 2nd edn. Edward Arnold, London.
- Hodges**, R.W. and Thompson, F.C. 1995. The Biota Nomenclatorial Database Project: creating a check list of the terrestrial arthropods of the World. In: Bardinet, C., Glaeser, P. and Royer, J.J. (eds), *Biosciences and Biodiversity* (CODA Volume E, Environmental Issues): 297–309. CODATA, Paris.
- Holthius**, L.B. 1994. *Lobsters of the World* (CD-ROM). ETI, Amsterdam.
- Hutchinson**, J. and Dalziel, J.M. 1927–36. *Flora of West Tropical Africa*. Crown Agents, London. [2nd edn 1953–72].
- Huxley**, J. (ed.) *The New Systematics*. Systematics Association, London. Reprinted 1971.
- International Commission on Zoological Nomenclature** 1985. *International Code for Zoological Nomenclature*. 3rd edn. International Trust for Zoological Nomenclature, London.
- International Union for the Conservation of Nature** (IUCN) 1980. *World Conservation Strategy, Living Resource Conservation for Sustainable Development*. IUCN, UNEP and WWF, Gland, Switzerland.
- Janzen**, D.H. 1993. Taxonomy: universal and essential infrastructure for development and management of tropical wildland biodiversity. In: Sandlund, O.T. and Schei, P.J. (eds), *UNEP Expert Conference on Biodiversity*. 100–113. NINA, Trondheim.
- Jeffrey**, C. 1982. *Introduction to Plant Taxonomy*. Cambridge University Press, Cambridge.
- Jeffrey**, C. 1989. *Biological Nomenclature*, 3rd edn. Edward Arnold, London.
- Jeffreys**, A.J. 1982. Evolution of globin genes. In: Dover, G.A. and Flavell, R.B. (eds), *Genome Evolution*. 157–176. Academic Press, London.
- Juzepczuk** S.V. 1958. Komarov's concept of species and its historical development and reflection of the 'Flora of the USSR' *Problemy vida v botanike, Leningrad* 1: 130–203. [In Russian.]
- Kitching**, I.J. 1992. Tree-building techniques. In: Forey, P.L., Humphries, C.J., Kitching, I.J., Scotland, R.W., Siebert, D.J. and Williams, D.M. (eds), *Cladistics: A practical course in systematics*. 44–71. Clarendon Press, Oxford.
- Komarov**, V.L. (later vols. Schischkin, B.K. and Bobrov, E.) 1934–60. *Flora URSS* (30 vols.). Akademiya Nauk, St Petersburg.
- Komarov** V.L. 1944. Studies on species of plants. Izdatelstvo Akademii Nauk SSSR, Moscow and Leningrad [in Russian].
- Lawrence**, J., Hastings, M., Dallwitz, M.J. and Paine, T. 1994. *Beetle larvae of the world*. CD-Rom, CSIRO Publications, East Melbourne.
- Linnaeus**, C. 1735. *Systema Naturae*. Haak, Leiden.
- Linnaeus**, C. 1753. *Species Plantarum*. Facsimile edn. 1957, Roy Society, London.
- Llorente Bousquets**, J. 1990. *La Búsqueda del Método Natural*. Subsecretaría de Educación Superior e Investigación Científica del la SEP y del Consejo Nacional de Ciencia y Tecnología, Mexico City.
- Lourdes**, M., Palomares, D. and Froese, R. 1974. FishBase, a data source with key information on Indo-Pacific fishes. In: Wu, J.-L., Hu, Y. and Westrum, E.F. (eds), *Data sources in Asian-Oceanic countries*. 221–228. CODATA, Ann Arbor, Mich.
- Mabberley**, D.J. 1987. *The Plant-book*. Cambridge University Press, Cambridge.
- McNeely**, J.A., Miller, K.R., Reid, W.V., Mittermeier, R.A. and Werner, T.B. 1990. *Conserving the World's Biological Diversity*. IUCN, WRI, CI, WWF and World Bank, Washington, DC.
- Makasheva**, R.K. 1979. In: Brezhnev D.D. (ed.), *Flora of cultivated plants*, Vol. IV part 1. Kolos, St Petersburg.
- Matthews**, R.E.F. 1979. Classification and nomenclature of viruses: third report of the International Committee on Taxonomy of viruses. *Intervirology* 12: 129–296.
- May**, R.M. 1990. Taxonomy as destiny. *Nature* 347: 129–130.
- Mayo**, M.A. 1994. Modifications to the rules for virus nomenclature. *Archives of Virology* (in press).
- Mayr**, E. 1940. Speciation phenomena in birds. *American Naturalist* 74: 249–278.
- Mayr**, E. 1963. *Animal Species and Evolution*. Harvard University Press, Cambridge, Mass.
- Mayr**, E. 1969. *Principles of Systematic Zoology*. McGraw-Hill, New York.
- Mayr**, E. 1982. *The Growth of Biological Thought: Diversity, evolution, and inheritance*. Harvard University Press, Cambridge, Mass.
- Mishler**, B.D. and Brandon, R.N. 1987. Individuality, pluralism, and the phylogenetic species concept. *Biol. Philos.*, 2: 397–414.
- Mishler**, B.D. and Donoghue, M.J. 1982. Species concepts: a case for pluralism. *Systematic Zoology* 31: 491–503.
- Morin**, N.R. (ed.) 1993 et seq. *Flora of North America North of Mexico* (2 vols.). Oxford University Press, New York.
- Nelson**, G. 1989. Species and taxa: systematics and evolution. In: Otte, D. and Endler, J.A. (eds), *Speciation and its Consequences*. 60–81. Sinauer Associates, Sunderland, Mass.
- Nelson**, G. and Platnick, N. 1981. *Systematics and Biogeography: Cladistics and vicariance*. Columbia University Press, New York.
- Nixon**, K.C. and Wheeler, Q.D. 1990. An amplification of the phylogenetic species concept. *Cladistics* 6: 211–223.
- Nixon**, K.C. and Wheeler, Q.D. 1992. Extinction and the origin of species. In: Novachek, M.J. and Wheeler, Q.D. (eds), *Extinction and Phylogeny*. Columbia University Press, New York.
- Pankhurst**, R.J. 1971. *Practical Taxonomic Computing*. Cambridge University Press, Cambridge.
- Pankhurst**, R.J. (ed.) 1975. *Biological Identification with Computers*. Systematics Association Special Volume No. 7. Academic Press, London.
- Pankhurst**, R.J. 1978. *Biological Identification*. Edward Arnold, London.
- Parker**, S.P. (ed.) 1982. *Synopsis and Classification of Living Organisms* (2 vols.). McGraw-Hill, New York.
- Paterson**, H.E.H. 1978. More evidence against speciation by reinforcement. *South African Journal of Science* 74: 369–371.
- Paterson**, H.E.H. 1982. Perspectives on speciation by reinforcement. *South African Journal of Science*. 78: 53–57.
- Paterson**, H.E.H. 1985. The recognition concept of species. In: Vrba, E. (ed.), *Species and Speciation*. Transvaal Museum Monograph 4: 21–29.

- Polhill, R.M.** 1990. Production rates of major regional floras. In: George, A.S., Kalkman, C. and Geesink, R. (eds), *The Future of Flora Malesiana*. 11–20. Nijhoff, The Hague.
- Quicke, D.L.J.** 1993. *Principles and Techniques of Contemporary Taxonomy*. Blackie Academic and Professional, Glasgow.
- Radford, A.E.** 1986. *Fundamentals of Plant Systematics*. Harper and Row, New York.
- Ragge, D.R.** and Reynolds, W.J. 1984. The taxonomy of western European grasshoppers of the genus *Euchorthippus*, with special reference to their songs (Orthoptera: Acrididae). *Bulletin of the British Museum of Natural History (Entomology)* **49**: 103–151.
- Ridley, M.** 1985. *The Problems of Evolution*. Oxford University Press, Oxford.
- Ridley, M.** 1993. *Evolution*. Blackwell Scientific, Oxford.
- Rojas, M.** 1992. The species problem and conservation: what are we protecting? *Conservation Biology* **6**: 170–178.
- Raven, P.H., Evert, R.F.** and Eichhorn, S.E. 1992. *Biology of Plants*, 5th edn. Worth Publishers, London.
- Ross, H.H.** 1974. *Biological Systematics*. Addison-Wesley, Reading.
- Rushforth, K.D.** 1987. *Conifers*. Facts On File Publications, New York.
- Shaw, A. B.** 1964. *Time in Stratigraphy*. McGraw-Hill, New York.
- Sims, R.W.** and Hollis, D. (ed.) 1980. *Animal Identification: A reference guide* (3 vols.). British Museum (Natural History), London.
- Sims, R.W. et al.** 1988. *Key Works to the Fauna and Flora of the British Isles and Northwestern Europe*. Academic Press, London.
- Skelton, P.** (ed.) 1993. *Evolution: A biological and palaeontological approach*. Addison-Wesley, Wokingham.
- Simpson, G.G.** 1951. The species concept. *Evolution* **5**: 285–293.
- Simpson, G.G.** 1961. *Principles of Animal Taxonomy*. Columbia University Press, New York.
- Sleigh, M.A., Rice, J., Tong, S.M., O'Conner, C.D., Giles, I.G.** and Burkill, P.H. 1994. Analysis of rRNA gene sequences shows a common flagellate 'genus' to be polyphyletic (in press).
- Sneath, P.H.A.** 1992. *International Code of Nomenclature of Bacteria, 1990 Revision*. American Society for Microbiology, Washington, DC.
- Sokal, R.R.** and Crovello, T.J. 1970. The biological species concept: a critical evaluation. *American Naturalist* **104**: 127–153.
- Stebbins, L.** 1950. *Variation and Evolution in Plants*. Columbia University Press, New York.
- Stevens, P.F.** 1988. New Guinea. In: Campbell, D.G. and Hammond, H.D. (eds), *Floristic Inventory of Tropical Countries*. 120–132. New York Botanical Garden, New York.
- Stiasny, M.L.J.** 1992. Phylogenetic analysis and the role of systematics in the biodiversity crisis. In: Eldredge, N. (ed.), *Systematics, Ecology and the Biodiversity Crisis*. 109–120. Columbia University Press, New York.
- Stiasny, M.L.J.** and de Pinna, M.C.C. 1994. Basal taxa and the role of cladistic patterns in the evaluation of conservation priorities: a view from freshwater. In: Forey, P.L., Humphries, C.J. and Vane-Wright, R.I. (eds), *Systematics and Conservation Evaluation*. 235–249. Clarendon Press, Oxford.
- Swofford, D.L.** and Olsen, G.J. 1990. Phylogeny reconstruction. In: Hillis, D.M. and Moritz, C. (eds), *Molecular Systematics*. 411–501. Sinauer Associates, Sunderland, Mass.
- Takhtajan, A.L.** 1984. Introduction. In: V. Grant (ed.), *Plant Speciation*, Russian Edition. 5–9. Mir, Moscow. [in Russian].
- Templeton, A.R.** 1989. The meaning of species and speciation. In: Otte, D. and Endler, J.A. (eds), *Speciation and its Consequences*. 3–27. Sinauer Associates, Sunderland, Mass.
- Turrill, W.B.** 1942. Taxonomy and phylogeny. *Botanical Reviews* **8**: 247–270, 473–532, 655–707.
- Tutin, T.G., Heywood, V.H., Burges, N.A., Moore, D.M., Valentine, D.H., Walters, S.M.** and Webb, D.A. (eds) 1964–80. *Flora Europaea* (5 vols.). Cambridge University Press, Cambridge.
- Unwin, D.M.** 1984. A key to the families of British Coleoptera (and Strepsiptera). *Field Studies* **6**: 149–197.
- Valdés, B., Talavera, S.** and Fernández-Galiano, E. (eds) 1987. *Flora vascular de Andalucía Occidental*. Ketres Edition, Barcelona.
- Vane-Wright, R.I., Humphries, C.J.** and Williams, P.H. 1991. What to protect? Systematics and the agony of choice. *Biological Conservation* **55**: 235–254.
- Van Valen, L.** 1976. Ecological species, multispecies and oaks. *Taxon* **25**: 233–239.
- Van Steenis, C.G.G.J.** (ed.) 1948 et seq. *Flora Malesiana*. Nijhoff, The Hague/Klumer, Dordrecht.
- Vavilov, N.I.** 1931. The Linnean species as a system. *Gosudarstvennoe izdatelstvo sel'skokozyaistvennoi i kolkhoznoi literatury*, Moscow and Leningrad.
- Vigilant, L.** and Stoneking, M. 1991. Eve Hypothesis. *Science* **253**: 1503.
- Vrba, E. S.** 1984. Patterns in the fossil record and evolutionary processes. In: Ho, M.-W. and Saunders, P.T. (eds), *Beyond NeoDarwinism: An introduction to the new evolutionary paradigm*. 115–142. Academic Press, London.
- Wain-Hobson, S.** and Myers, G. (1990). Too close for comfort. *Nature* **347**: 18.
- Watson, L.** and Dallwitz, M.J. 1994. *Families of Flowering Plants: Interactive identification and information retrieval*. CD-ROM. CSIRO Publications, East Melbourne.
- Weitzman, M.L.** 1992. On diversity. *Quarterly Journal of Economics* **107**: 363–405.
- Wheeler, Q.D.** 1990. Insect diversity and cladistic constraints. *Entomological Society of America* **83**: 1031–1047.
- Whittaker, R.H.** 1969. New concepts of kingdoms of organisms. *Science* **163**: 150–160.
- Wiley, E. O.** 1979. The annotated Linnean hierarchy, with comments on natural taxa and competing systems. *Systematic Zoology* **28**: 308–337.
- Wiley, E.O.** 1978. The evolutionary species concept reconsidered. *Systematic Zoologist* **27**: 17–26.
- Wiley, E.O.** 1981. *Phylogenetics: The theory and practice of phylogenetic systematics*. John Wiley, New York.
- Williams, P.H.** and Humphries, C.J. 1994. Biodiversity, taxonomic relatedness, and endemism in conservation. In: Forey, P.L., Humphries, C.J. and Vane-Wright, R.I. (eds), *Systematics and Conservation Evaluation*. 269–287. Clarendon Press, Oxford.

Williams, P.H., Humphries, C.J. and Vane-Wright, R.I. 1991. Measuring biodiversity: taxonomic relatedness for conservation priorities. *Australian Systematic Botany* 4: 665–679.

Williams, P.H. Vane-Wright, R.I. and Humphries, C.J. 1993. Measuring biodiversity for choosing conservation areas. In: LaSalle, J. and Gauld, I.D. (eds), *Hymenoptera and Biodiversity*. 309–328. CAB International, Wallingford.

Wilson, E.O. 1992. *The Diversity of Life*. Belknap Press, Cambridge, Mass.

Woese, C.R. 1994. There must be a prokaryote somewhere: microbiology's search for itself. *Microbiological Reviews*, March 1994: 1–9.

Zavadsky, K.M. 1968. *Species and Speciation*. Nauka, Leningrad [in Russian].

2.2 Genetic diversity as a component of biodiversity

2.2.0 Introduction

In this Chapter we outline various aspects of biological diversity within the species. This diversity is variously termed subspecific (meaning below the species level), intraspecific or infraspecific (both meaning within the species, but the former term apparently more favoured by zoologists and the latter by botanists). A major aspect of this is obviously what is termed genetic diversity (see below), but it should be borne in mind that within biology, genetics and systematics are, or at least should be, intimately linked and that there are a considerable number of groupings below the species level which have taxonomic or systematic implications without necessarily being clearly defined in genetic terms. A number of the subspecific groupings more commonly referred to are outlined in Box 2.2-1. Some of these (e.g. subspecies, varieties) are or have been used as straightforward subspecific taxa. Others (e.g. ecotypes, chemotypes) imply differences based upon other than conventional systematic characters or (e.g. cytotypes, hybrids) have mainly genetic implications. The explanations suggested for these terms are not intended to be strict definitions and for many of them the intended meaning differs, often subtly, between authors and between fields of research and some, like the organisms they describe, have evolved with time and may no longer be used in precisely the same sense as they were by earlier workers. However, irrespective of meaning and usage, such intraspecific groupings generally can be assumed to imply some, albeit imprecise, level of genetic differentiation or genetic biodiversity.

Genetic diversity is a critical component to issues of biodiversity. It is the genetic diversity within species that allows a species the opportunity to evolve under changing environments and selection pressures. This section will overview the main fields of evolutionary genetics as applied to the assessment of biodiversity and introduce briefly various techniques available to assay genetic diversity within and between species.

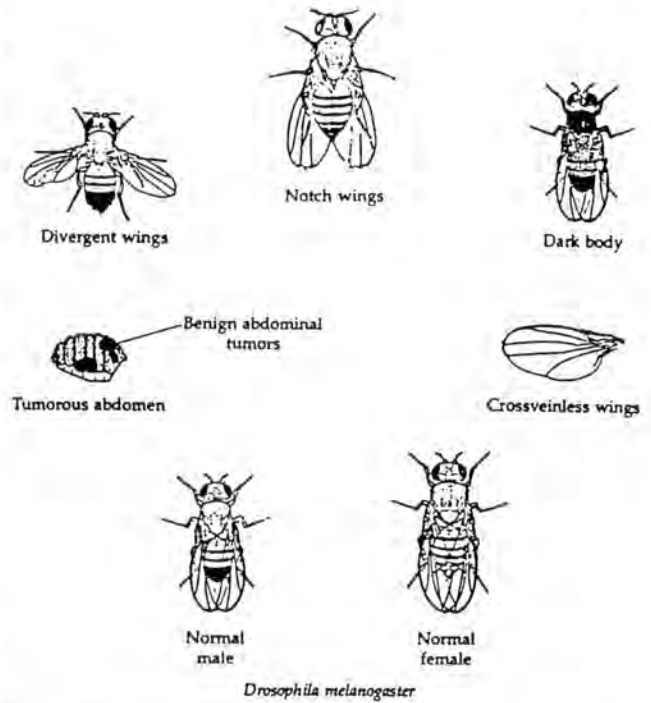

Figure 2.2-1: Examples of some phenotypic variants found in natural *Drosophila melanogaster* populations: sketches of normal flies are presented for comparison. A relatively small proportion of such abnormal flies owe their abnormality to single mutant genes (from Hartl and Clark 1989).

The variability that we observe among individuals (*phenotype*) results partly from the interaction of genetic differences (*genotype*) with their surrounding environments. Genetic diversity both within species and among higher taxonomic groups can be assayed directly by surveying the actual genetic material (i.e. the *genotype*). The genetic diversity occurs in the form of nucleotide variation within the genome. When this variation causes a change in a given protein, the variants are termed *alleles*. Allelic variation occurs at various genetic *loci*, or gene positions within a chromosome. Genetically variable loci are termed *polymorphic* or are said to show *polymorphism*. Genetic diversity can also be assayed indirectly by measuring a phenotype with a presumed or demonstrated underlying genetic basis (Figure 2.2-1). As one moves up the taxonomic hierarchy, genetic diversity tends to increase with increasing taxonomic diversity, both within organismal groups (Figure 2.2-2a) and across groups as a whole (Figure 2.2-2b).

The recognition that natural populations have high levels of genetic variation is something comparatively recent and followed from the application of allozyme electrophoresis to population genetics (Hubby and Lewontin 1966). This resulted in debate as to the factors responsible for the maintenance of these high levels of variation: the 'neutralists' claimed that genetic variation accumulated through mutation to form new alleles, which remained in

Box 2.2-1: Definition of terms.***Clines***

These are examples of regional variation in one or more characters which vary unidirectionally over a significant geographical distance. One of the problems with detecting clines (and even with the concept) is that their detection and characterizing is through sampling a range of populations which may make it difficult to know if variation is gradual or punctuated. It is assumed that clines are responses to gradual regional changes in such factors as climate (e.g. high to low rainfall), altitude and distance (e.g. decreasing maritime influence), but suggested that clines do not always match obvious changes in habitat parameters. Examples include regional changes in morphology of North American trees such as Douglas fir and spruce species, Australian eucalyptus, and *Celmisia spectabilis* along the Southern Alps of New Zealand (Given 1994).

Ecotypes

In those instances where there are morphologically distinctive forms of taxa restricted to identifiably different habitats the term 'ecotype' is used. Ecotypes may therefore overlap geographically, and often will, but are frequently identified in terms of restriction to particular soils, or climatic regimes (e.g. low versus high rainfall ecotypes). Examples of ecotypes include glaucous and non-glaucous forms of *Phyllocladus aspleniifolius* in New Zealand where this has partial correlation with altitude and with soil type.

Chemotypes / pathotypes

Similar to the above but identified in terms of chemical characteristics, physiological characteristics and pathological distinctiveness, which may not necessarily have an obvious morphological or genetic correlation. These may be widespread, but obviously are more difficult to detect because they are examples of 'cryptic taxa' (i.e. they are not morphologically obvious). They have been detected in several New Zealand plant groups, e.g. South Island *Chionochoa*, some Hymenophyllaceae.

Cytotypes

This term is used for forms of an organism which may not be readily distinguished morphologically, but which have clear differences in, for example, the number or conformation of chromosomes. Examples occur particularly in the fern genera *Asplenium* and *Dryopteris*. They are also known in the whelk genera *Thais* and *Nucella* in North America and Europe respectively.

Varieties and subspecies

Species often consist of two or more forms which can be distinguished on the basis of, for example, morphology or colour. If considered sufficiently different to require some taxonomic distinction, but not to be separate species, such forms may be given the status of subspecies. An example is the migratory passerine bird *Motacilla alba* (white wagtail), which breeds over much of the Palaearctic, but with such plumage variation in different areas that several subspecies are recognized (see Cramp *et al.* 1988). Varieties were often used in older taxonomic work to give names to colour morphs or other distinguishable forms within a species. For example, Gosse (1860) gave varietal names to many colour morphs of the intertidal sea anemone *Actinia equina* occurring around Britain.

Polytypic and monotypic taxa

Many (perhaps most) species consist of a single scientifically recognized entity, termed monotypic. Others may consist of two or more entities (subspecies, varieties) and are polytypic. Most species are related to other species which collectively form genera: these in turn are aggregated into families, and so on upwards through the taxonomic hierarchy as described in Chapter 2.1.

Hybrids

When species hybridize, some of the offspring may be fertile (forming a hybrid swarm), and true-breeding forms may become genetically stable. These can disperse and establish new colonies. The remainder of the swarm may often become extinct because of lack of fitness. If habitats are sharply distinct and there is only a small intermediate zone between them, hybrids of species from each habitat may be unable to survive. However, where there is a wide transition from one to another, fertile hybrids, (or offspring capable of vegetative reproduction) may be able to exploit

the intermediate site, or 'ecotone'. This has occurred with *Ceanothus* in parts of central California (*C. cuneatus* and *C. gloriosus*), *Platanus* – the sycamore or plane trees – (*P. orientalis* of Eurasia and *P. occidentalis* of North America giving *P. × hybrida*: the London Plane) and *Celmisia* in New Zealand (*Celmisia spectabilis* and *C. lyallii* giving *C. × pseudolyallii*). Hybridism is widespread in some particular plant groups and regions (e.g. New Zealand where hybridism is rampant, especially where habitat change has created 'intermediate' habitats). Many hybrids are sterile but there are others which are at least partially sexually reproducing and form hybrid swarms. When this occurs there may be a gradation from one parent to the other, through a series of intermediate plants. Hybridism has a significant role to play in evolution of new taxa. This is especially the case where the hybrids have different chromosome numbers from the parent species (amphidybrids: hybrid plus polyploidy), and so the offspring are reproductively isolated. Hybridity has mixed results for biodiversity. Positive input is one means of enhancing genetic diversity – an obvious one, for it allows the mixing of different genotypes. Offspring from such unions are often more vigorous than either parent. This is the phenomenon of 'heterosis' or hybrid vigour. The explanation is that most individuals carry genes which are disadvantageous. Unrelated individuals are less likely to carry the same such genes than are close relatives. Therefore in hybrids, the progeny are more likely to have disadvantageous genes masked by 'normal' dominant ones. Heterosis is important to conservation biology because of its relationship to fitness (see Ledig 1986). However, other hybrids, even between closely related species are inferior to either parent. In fact, interspecies hybridism is often associated with breakdown of finely tuned gene complexes and with developmental instability. Corn (*Zea mays*) is the classic example of heterosis but even here there is an optimum amount of parental divergence for maximum hybrid vigour. With greater parental difference decline in fitness sets in: this is referred to as 'outbreeding depression' or 'coadaptation'.

The marine grass, *Spartina × townsendii*, was first formally recognized and described in 1881 from specimens collected near Hythe, Southampton Water, England, although it had been collected as early as 1870 or possibly earlier. It is generally believed on morphological and cytological grounds to have resulted from hybridization between the indigenous *S. maritima* and introduced *S. alterniflora*. Original plants were male-sterile, but hybridisation was followed by doubling of chromosome number to produce fertile, vigorous offspring which behaves as a 'good' species. This has been described as *Spartina anglica*.

Negative implications of hybridization

Hybridization between a widespread species and a narrow endemic can end up eliminating much of the genetic diversity present in the narrow endemic. This is the case of *Centaurea avilae* Pau, a narrow endemic of Central Spain, which grows in Sierra de Gredos at 1800–2000 m altitude. The habitat of the species is frequently visited by mountaineers, who use it as a camp-site. This has led to the nitrification of part of the habitat and its colonization by the more widespread *C. alba* L. The two species are hybridizing and the original genotype arrangements of *C. avilae* are being lost (Blanca *et al.* 1987). Another example is *Acaena pallida*, a local sand-dune endemic of New Zealand, which is being hybridized with *A. novae-zelandiae* naturalized from Australia.

For 100 years the distributions of British *Gentianella* have decreased in numbers of individuals and sites. Only one species, *G. amarella*, seems not to be seriously diminishing, although it has been adversely affected by people and the loss of rabbits. Several species may be the victims of environmental changes which have caused breakdowns in breeding barriers. These species have geographic ranges within that of more widespread *G. amarella*. They are not genetically isolated from the more widespread species. As habitat changes allow *G. amarella* to invade the ranges of the other species, introgressive hybridization occurs. Hybrid populations are weighted morphologically towards *G. amarella*, so that there is gradual 'absorption' of the rarer species into the more abundant one. Examination of herbarium specimens and field data supports this hypothesis for the gradual extirpation of several rare species and it is assumed that (at least in their 'pure' form) these will disappear.

Conservation of *Agave arizonica*, a recurring hybrid

Soon after its discovery in 1959, *Agave arizonica*, one of the rarest and most attractive agaves in Arizona, was known from about ten sites over an area of about 50 km² in the New River Mountains. By March 1984 ten new sites were known from the region, but only one of the original clones had persisted. All sites are within the distribution area of two other species of *Agave* – *A. toumeyana* subsp. *bella* and *A. chrysantha*. Comparison showed that *A. arizonica* is intermediate between the other two species, and it has been concluded that it is a recurring hybrid between them. Many

Box 2.2-1 cont.

species of *Agave* have arisen by hybridization, this group of plants adopting polyploidy, hybridization and vegetative reproduction as evolutionary strategies. However, because of the hybrid nature of *Agave arizonica*, attempts have been made to remove it from lists of endangered species – specific reasons have been its low reproductive potential, the inability to maintain itself in discrete populations in nature, and its uselessness as an easily created plant through artificial propagation. This raises the question of the best means of dealing with species that appear to be of recent hybrid origin in this and other genera. *Agave arizonica* may be an early stage in the evolution of a new species, before reproductive patterns have become fixed (DeLamater and Hodgson 1987).

Aggregate species

Aggregate species are species that are generally characterized by being very widely distributed, often with a wide variety of habitats, and with a large degree of (usually) morphological variation, which can be correlated with geographic and/or habitat variation. The infraspecific components (microspecies) are difficult to recognize as species in their own right, yet may behave as independent species locally. In some instances they may form 'circle species' in which microspecies are replaced sequentially, in circular fashion over a whole continent (or large geographic area): $a > b > c > \text{etc.} \dots n > a$. Investigation of many aggregate species shows that they are at least in part apomictic in their breeding system. There is a tendency for new microspecies to arise spontaneously in answer to changed environmental parameters. Examples of classic aggregate species include the genera *Rubus* (especially the European 'blackberry' species), *Hieracium* and *Rosa*.

Polyploid complexes

Polyploids are especially widespread among plants – situations where there is increase in the number of chromosome complements (or sets) above the usual diploid level. Although often said to be disadvantageous, and even an evolutionary dead-end, polyploidy has been widespread and probably highly significant in the evolution of most plant groups. Polyploidy is regarded as one of the fastest ways of speciation in plants because genetic barriers between the individuals that undergo polyploidy and the original population are formed in just one generation. It is estimated that one-third of the angiosperm species have more than two chromosome complements (are polyploids). For example, in the fern family, Hymenophyllaceae, there are a range of base chromosome numbers and most species are parts of polyploid sequences based on these, modified by aneuploidy or reduction in number as well. Within some species of *Hymenophyllum* there are polyploid sequences within species.

Polyploidy is more frequent in some particular families and regions. New Zealand has a particularly high level of polyploidy, especially in Poaceae and Asteraceae. In the latter, the genus *Celmisia*, which is in the same general group of genera as *Erigeron* and *Aster*, the lowest ploidy level recorded is $n = 12$, and there are species that are $n = 24$, $n = 36$. The related genus *Olearia* has ploidy levels ranging from probable diploids and tetraploids to at least $n = 24$, with series based on $n = 4$, $n = 6$, $n = 10$.

Polyploidy not only occurs between species but can occur within species. An example is *Asplenium trichomanes*. This species which has world-wide distribution, has at least three karyotypes (diploid, tetraploid and octoploid) which have been recognized in formal taxonomy of the species. Another example is *Narcissus bulbocodium* L. where diploid ($2n = 14$), triploid ($2n = 21$), tetraploid ($2n = 28$), pentaploid ($2n = 35$) and hexaploid ($2n = 42$) karyotypes are known. Polyploidy is a lot less frequent in animals than in plants and it has played a less important role in its evolution. Polyploidy is rare among animal species, generally because in most groups polyploids seem to be either non-viable or sterile. They appear to be relatively common in sea anemones (e.g. Shaw *et al.* 1987).

the population because they were selectively equivalent to the original ones (i.e. selectively neutral; Kimura, 1983, 1991), whilst the 'selectionists' interpreted the high levels of gene variation as adaptation to a number of different environmental parameters (reviewed by e.g. Lewontin 1974; Nevo *et al.* 1984). However, it became well established that, whatever the reason, most natural populations had high genetic diversity. All current methods

used relate to the estimation and comparison of genetic diversity in different organisms.

Genetic diversity originates by mutation, but different processes determine the extent to which it is maintained within populations. The relative importance of these processes varies substantially among different organisms as a consequence of their ecology and life histories. *Natural selection* operates via the differential survival and

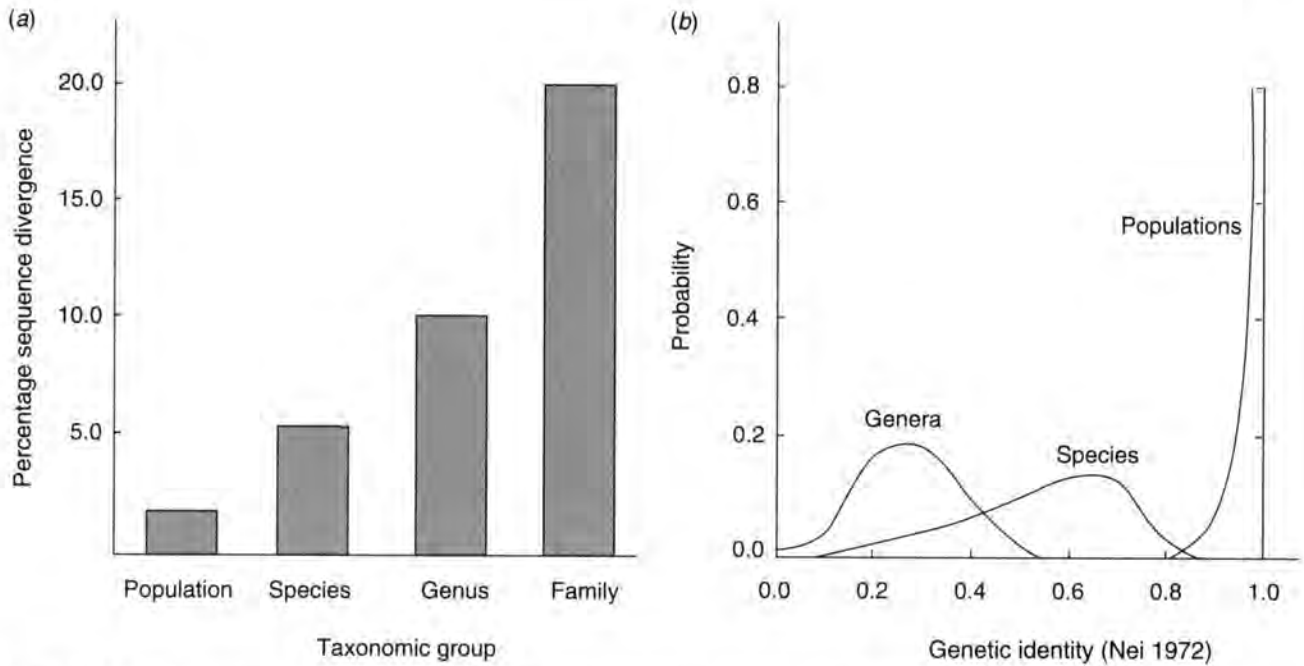

Figure 2.2-2: (a) Percentage sequence divergence for the 16S region of the mitochondrial DNA obtained from nested taxonomic groups of freshwater crayfish (Decapoda: Cambaridae, Parastacidae). Average percentage sequence divergence is shown between two of the stated taxonomic groups, e.g. 1.8% sequence divergence between populations of a single species. Sequence divergences are calculated from data given in Crandall and Fitzpatrick (1994). (b) Allozyme divergences. Probability against Nei's Genetic Identity for genera, species and populations. (Redrawn from Thorpe 1982.)

reproductive success of individual organisms. Those individuals with well adapted phenotypes will pass on a greater proportion of their genes to the next generation. As a consequence, gene frequencies in the population change allowing individuals to adapt to changing environments. Therefore the capacity for populations to persist under changing environmental conditions is at least partly determined by the amount of genetic variability. A second process that alters gene frequencies is *genetic drift*. Random assortment of genes at each generation means that some may increase in frequency, some may decrease and some may be lost. The importance of genetic drift as a source of genetic variation is inversely related to population size. The manner in which genetic drift may affect genetic variation in populations was shown empirically by Bonnell and Selander (1974) in an early study of genetic variability at enzyme loci in the elephant seal *Mirounga angustirostris*. Hunters had reduced the total population of this species to only several individuals before legal protection was granted earlier this century. Although the population is now much larger, genetic variability has been almost eliminated, presumably through the predictable effects of genetic drift on the previously very small population size. Gene frequencies may also be altered through *migration* if migrants entering the population have different genotypes and interbreed with residents. The importance of migration in altering gene frequencies increases if the number of effective migrants is large and if

gene frequencies differ substantially between the migrants and residents. Analytical techniques for detecting the influence of these various processes are described in Chapter 2.2.3 (Box 2.2-4). The processes generating and maintaining genetic variation within and among populations are expounded upon in Chapter 3.2.

2.2.1 Partitioning of genetic variability below the species level

Given the huge number of gene loci (of the order 10^5) in higher organisms, and the number of alleles at each locus, in sexually reproducing species the reshuffling of the genetic material during meiosis results in each individual having a unique combination of alleles. Consequently estimates of gene composition can discriminate between different individuals providing that the analysis is undertaken using a genetic system of sufficiently high resolution (see below). Patterns of genetic variation above the level of the individual reflect patterns of species sub-structuring, and the extent to which there is gene flow between the different units. For example, within breeding groups there will be a greater genetic similarity than among such groups. The level of difference between populations of a species will depend, in part, on the amount of genetic interchange (gene flow) between them.

By definition, different biological species are not expected to exchange genes and, therefore, they will start to accumulate differences (i.e. they will undergo *anagenic*

Box 2.2-2: Genetic adaptation in butterflies.

Examples of how a single species may adapt by using different genes to fit it to the varied ecological requirements of different habitats and areas are provided by tropical butterflies. In Africa, various species of *Papilio* are widespread and each is colourful, but highly variable. The species are palatable to birds, but survive partly by looking like other butterfly species that are poisonous (i.e. they are what are termed *Batesian mimics*). However, over their wide ranges *Papilio* species coexist with a number of other poisonous butterflies and so have adapted genetically to resemble different species in different areas. Also different morphs of the same *Papilio* species may coexist imitating different poisonous species in the same area (see illustration below).



The three butterflies shown on the left are different morphs of *Papilio dardanus*. On the right are three butterflies of different species unrelated to *Papilio*. Each of these species is unpalatable to bird predators. The different morphs of *Papilio* mimic the three unrelated species on the right (from Ehrlich and Holm 1963).

A similar situation exists among large colourful *Heliconius* butterflies in the American tropics. These, unlike *Papilio*, are poisonous, but nevertheless may suffer predation from birds yet to learn that the butterflies are unpalatable. *H. erato* and *H. melpomene*, for example, are widespread and vary greatly in colour pattern over their ranges, yet in any given area where they co-occur the two appear superficially identical. The reason for this is that they are *Müllerian mimics* – resembling each other enhances survival because birds learn more quickly that such butterflies are distasteful. Thus in both *Papilio* and *Heliconius* genetic variability (polymorphism) within species has resulted in widespread local adaptation, yet particular morphs are ecologically well adapted and at a selective advantage only in the particular area where they occur. Elsewhere within the range of the same species they would be at a disadvantage.

divergence) through some combination of mutation, drift and selection, from the moment they originate. Genetic variation, therefore, can be analysed at various levels, from individual differences in the presence of each allele, through population differences in gene frequencies to allele composition in each species or group. The origin

and evolutionary fate of each allele in a population can be likened to the histories of individual characters in a complex story. Much of biology relates to the study of the distribution of organisms in a three-dimensional space, their interrelations and adaptations to their current environment. The study of gene variation and its

evolution adds a fourth dimension (time) to these studies, and through the genetic analysis of populations we may have a better grasp of the origins of species and their adaptations to different environments. It is this understanding of the relationship between genetic diversity and ecological diversity that is of paramount importance for the conservation of biological diversity (see Box 2.2-2).

The patterning of genetic variability within species is rarely concordant with classical taxonomic units below the species level. Even commonly used groupings such as subspecies rarely reflect patterns of genetic variation. Also it is debatable whether the taxonomic ranks are directly comparable between different groups of organisms or even whether it is desirable for them to be so (see, for example, van Valen 1973). In practice, therefore, it will be preferable to discriminate among biological units using the methods, outlined below, that measure genetic variability either directly or indirectly. Results from genetic analyses should be treated with caution, however, if they are not concordant with observed differences in, for example, distribution, ecology or morphology.

A further potential complication in making any assessment of genetic biodiversity within a species is that, with the widespread use of molecular methods in taxonomy, it is becoming increasingly clear that in some groups much 'intraspecific' variability is in fact interspecific and results from the existence of unsuspected cryptic species. This seems to be a particular problem in certain taxa of marine invertebrates, for example, where the adult lacks many taxonomically useful morphological features and is sessile or of low mobility and the larval stage is of short duration and low dispersal capability. The taxonomic simplicity of such species has resulted in many being recorded from several areas and hence having apparent distributions that are very wide and often circumglobal. However, genetic examination often reveals that cosmopolitan species of this type include a number of distinct and sometimes not even closely related cryptic species. For example, Solé-Cava *et al.* (1991) studied genetic divergence between populations of the sponges *Clathrina clathrus* and *C. cerebrum*. Both 'species' are morphologically very distinctive and easily identified by diagnostic characters and both were considered to be of cosmopolitan distribution. In each species samples from Brazil were so genetically divergent from those from the Mediterranean that not only were the populations clearly not conspecific, but their level of divergence approximated to that expected between species from different genera. Cryptic species seem to be most common in morphologically difficult taxa such as sponges (e.g. Solé-Cava *et al.* 1990, 1992), nemerteans (e.g. Rogers 1992; Rogers *et al.* 1995) and certain bryozoans (Thorpe *et al.* 1978a, b), but occur in a wide range of organisms (for

invertebrates many examples are listed by Thorpe and Solé-Cava 1994; see also Knowlton 1993).

2.2.1.1 Analysis of karyotypic variation

The term karyotype refers to the chromosome complement of an individual or of a related group of individuals and is characterized by the number, size and shape of its chromosomes. The analysis of karyotypic variation thus entails studies on numerical and structural polymorphisms (variants) in the chromosome complements of a group of individuals belonging to a particular taxon. Numerical polymorphisms include changes of whole chromosome complements (polyploidy), or of individual (standard) chromosomes (polysomy, monosomy, nullisomy, addition, substitution). Furthermore, changes in the number of supernumerary or B-chromosomes, which are optional extras in addition to the standard diploid or polyploid basic (A) chromosome complement also occur. Structural polymorphisms originate from chromosome rearrangements involving one or more standard or supernumerary chromosomes, such as duplications, deletions, translocations, inversions, misdivisions and Robertsonian interchanges.

2.2.1.1.1 Karyotypic variation analysis techniques. Numerical polymorphisms are normally studied using conventional chromosome staining techniques (Dyer 1979; Sessions 1990). The chromosomes involved in structural rearrangements are recognizable by changed chromosome morphology or by genetic means (linkage analyses). New morphological features of chromosomes include changes of total chromosome length, modified length ratio of short and long arms, and/or positional changes of appropriate cytogenetic markers (chromosome bands, secondary constrictions, late replicating regions, asymmetric bands). The presence of structural changes may also be inferred from the observation of chromosome protuberances and rings in chromosome pairing, telophase bridges and micronuclei.

Chromosome banding is based on a differential staining of chromosomes which results in the resolution of longitudinal bands. The three most important banding methods are Q-, C- and G- banding (Caspersson *et al.* 1969; Comings 1978; Hsu *et al.* 1971; Hsu 1979; Rooney and Czepulkowsky 1986; Sessions 1990). Various specialized banding procedures have also been developed such as fluorescence banding, using various fluorochromes, and nucleolar organizer region (NOR) banding, using silver nitrate (Rooney and Czepulkowski 1986).

2.2.1.1.2 Genetic diversity studies. The analysis of karyotypic variation has often been used to assess genetic diversity within species or gene pools of plants and animals. Genetic diversity studies at infraspecific levels deal mainly with variation found in banding patterns (i.e. Noguchi 1988), in B-chromosome frequency (Hewitt and

Box 2.2-3: Levels of genetic distinction, problems and appropriate tools.

Genetic level	Problems	Tools
Species	Specific status Phylogenetic relationships Hybridization	Karyology Allozymes (fixed) mtDNA sequence Restriction site data
Subspecies/ metapopulation	Phylogenetic relationships Hybridization	Karyology Allozymes mtDNA sequence Single locus genomic sequence Microsatellites
Population	Genetic variability Genetic substructuring	Karyology (B-chromosomes, bands) Allozyme (heterozygosity) mtDNA sequence Single locus genomic sequence DNA fingerprinting Microsatellites
Individual	Reproductive success Genetic representation	Allozymes Single locus genomic sequence DNA fingerprinting Microsatellites

John 1970; Bougourd and Parker 1979; Vujosevic 1992), and in nucleolar organizer regions (Foresti *et al.* 1993; Martinez *et al.* 1993). In other cases, polymorphisms have been recognized using conventional procedures, through the detection of multiple pericentric inversions (Roy *et al.* 1988), translocations and fissions (Lambrot 1988). The analysis of karyotypic variation has been even more extensively used for the analysis of genetic diversity among closely related species (i.e. those belonging to the same genus or tribe) and to study phylogenetic relationships and chromosome changes during the evolution of particular groups of taxa. Polymorphisms detected in these studies are generally based on basic chromosome numbers, polyploidy, B-chromosome frequencies, chromosome size, banding patterns, number and location of nucleolar organizer regions, translocations and inversions (Vosa 1976; D'Emerico *et al.* 1993; Ren and Yu 1993; Svartman and Almeida 1993). In plants, Gramineae is probably the taxon most deeply analysed at the cytogenetic level (Gupta and Tsuchiya 1991). Major studies have also been carried out to characterize the genetic diversity of other taxa of agronomic importance, such as Cruciferae, Fabaceae, Liliaceae and Solanaceae

(Swaminathan *et al.* 1983; Tsuchiya and Gupta 1991). In animals, most in-depth studies have been conducted in Insecta (Orthoptera and Diptera), Amphibia and Mammalia (Rodentia).

2.2.1.1.3 Assessment. Karyotypic studies can contribute an array of information independent of the morphological, biochemical, behavioural and other characters that are used for genetic diversity analysis. An advantage of karyotypic analysis over phenotypic analyses is that the variation associated with the former is not so much influenced by environmental or physiological factors. Furthermore, it encompasses several levels of biological organization ranging from the morphological to the molecular, depending on the applicable technology.

In many cases, the main features of the karyotype within a given species are sufficiently constant to allow for the species characterization. Thus, the analysis of karyotypic variation is especially useful in the assessment of genetic diversity among closely related species that share a common gene pool. Genetic diversity studies within and among populations of a given species are, more often, characterized through biochemical and molecular techniques (Baverstock and Moritz 1990).

Box 2.2-4: DNA elements for assessing levels of genetic diversity.

The methods for detecting genetic variation at various genetic markers (described in 2.2.1.2) have provided extremely useful information for the analysis of population structure, levels of gene flow, phylogenetic relationships, patterns of historical biogeography, and analysis of parentage and relatedness. Below are listed a number of important genetic markers and their advantages for assaying genetic diversity within populations.

Mitochondrion or chloroplast DNA

Organelle (mitochondrion or chloroplast) DNA molecules have been exploited for population genetic analyses because these organelles occur in high copy numbers, yet are uniparentally inherited so that each copy is identical. Also, because they are uniparentally inherited, they can offer a unique insight into sex-biased population structure. The chloroplast genome is conserved in most respects with a generally low rate of substitution (reviewed in Palmer 1985, 1987; Wolfe *et al.* 1987; Dowling *et al.* 1990). However, some studies have found significant variation within populations (Soltis *et al.* 1989). Mitochondrial DNA, on the other hand, is highly variable and often used in population level studies (reviewed by Avise and Lansman 1983; Brown 1983; Wilson *et al.* 1985; Avise 1986; Avise *et al.* 1987; Moritz *et al.* 1987; Dowling *et al.* 1990). Typically, there is ample variation within the mitochondrial genome to detect population substructuring and estimate phylogenetic relationships using either RFLPs (e.g. Routman 1993; Georgiadis *et al.* 1994) or nucleotide sequence data (e.g. Edwards 1993).

Y-linked genes

For animals with XY sex determination systems and others (Bull *et al.* 1988), Y-chromosome-linked genes have the potential to serve as independent sex-specific markers. This allows for the partitioning of genetic contributions between the sexes. While in phylogenetic analyses substantial variation has been found among species (Tucker *et al.* 1989), Y-linked genes have not been utilized extensively for population genetic analyses. The substitution rates and independence of gene regions on the Y-chromosome vary greatly among organisms (Pamilo and Bianchi 1993), suggesting that some regions may indeed be useful for population genetic analyses (Tucker *et al.* 1992; Tucker and Lundigran 1993, 1994).

Single locus nuclear genes

Single locus nuclear genes have been used extensively in *Drosophila* genetics (see Crandall and Templeton (1993) for a survey of loci studied). These studies are particularly useful in detecting functional polymorphisms and population structure (e.g. Kreitman and Hudson 1991). The potential of these loci to answer questions relevant to conservation biology and biodiversity has not been realized to date. However, with the growing database of nuclear genes and the awareness of the need for sampling genetic variation at many loci (Wu 1991) for accurate estimates of phylogenetic relationships and overall levels of genetic diversity, these loci will play an increasingly important role in the assessment of global biodiversity.

Multiple copy nuclear genes

Multiple copy nuclear genes, especially the ribosomal DNA repeats, have been used extensively for systematic studies (Dowling *et al.* 1990; Hillis and Dixon 1991). Because they occur in multiple copies, these repeated genetic units are more easily assayed than single copy loci. Additionally, many coding gene regions are conserved, but flanked by non-conserved spacer regions allowing for reliable amplification of the gene region over a broad taxonomic range. The spacer regions often have variation at the individual and population levels offering information on population substructure and levels of gene flow (e.g. Learn and Schaal 1987; Templeton *et al.* 1990). Finally, ribosomal repeat number has been shown to correlate with life-history characteristics in *Drosophila* and has been used to detect processes of natural selection (Templeton *et al.* 1989).

2.2.1.2 Molecular methods for assessing levels of genetic diversity

There is an abundance of molecular techniques useful in surveying the amount of genetic diversity at various loci within species. Below we outline the major techniques being used by practising population geneticists today. Box

2.2-3 indicates the taxonomic levels at which these various techniques are most advantageously applied and Box 2.2-4 outlines some of the methods of analysis available for data generated by these techniques.

2.2.1.2.1 Allozymes. Allozyme electrophoresis involves identifying different protein alleles by their rate of

migration through a gel medium under the influence of an electrical field. The rate of migration of the molecules is influenced primarily by their net charge and molecular weight. Once separated, histochemical staining is used to identify the products of a single gene. The banding patterns obtained can be interpreted genetically (Richardson *et al.* 1986; Murphy *et al.* 1990; May 1992). If an amino acid substitution occurs in a protein molecule this may alter the net charge, or possibly cause conformational changes, and thus alter the rate of migration. Some of the mutations in regions of the DNA coding for one particular enzyme will, therefore, be expressed as enzyme molecules differing in their electrophoretic mobility (i.e. a new allozyme allele). This new allele will initially appear at very low frequencies in the population, so that some rare individuals analysed electrophoretically for the enzyme will be polymorphic (heterozygous) for that allele. The evolutionary fate of the new allele will depend on its relative physiological performance ('fitness', or its 'selection coefficient') and also on chance (stochastic) changes in frequency when passed on to the next generation (genetic drift). Populations evolving independently will, therefore, diverge, as new alleles appear randomly or disappear. Studying the allele differences between populations thus allows us to estimate how much they have diverged.

One of the advantages of electrophoresis is that allozymes are almost invariably co-dominant so that heterozygotes have different phenotypes from the homozygotes. Consequently the calculation of gene frequencies is simple, and these frequencies can then be used for the comparison of populations. Contrary to much of morphological, numerical or chemical systematics, molecular systematics is thus directly linked to the way genes evolve and their distribution in the species. Therefore allozyme electrophoresis not only provides new characters for the study of species, but also brings with it a whole new set of revolutionary tools for their analysis and thus is of great potential value in taxonomy and systematics. A few taxonomic studies have attempted to use electrophoretic patterns as taxonomic characters without any genetic interpretation; for example, by merely scoring bands as present or absent. Such approaches disregard the genetic information content and thus much of the value of the data and are also likely to be open to dispute on theoretical grounds. There are several earlier general or more specific reviews of the systematic uses of electrophoretic data (e.g. Gottlieb 1977; Ferguson 1980; Thorpe 1982; Buth 1984; Hartl *et al.* 1990; Hillis and Moritz 1990; Thorpe and Solé-Cava 1994; Solé-Cava and Thorpe 1995).

In taxonomic or systematic studies the genetic data produced by electrophoresis can be used by systematists to answer two types of questions:

1. Are the samples from which genes are being compared from the same freely interbreeding gene pool? or
2. How great are the differences between the gene pools being compared?

Clearly the answer to Question 1 is appropriate for distinguishing species (alpha systematics) and that to Question 2 can be used to provide data on interrelationships of taxa (beta systematics or phylogenetics). However, data on levels of difference between gene pools can also be used to give an indication of whether these are likely to be conspecific. In systematics Question 1 above would commonly become 'are these two biological entities (e.g. morphotypes, colour morphs, subspecies) from the same or different species?'. Enzyme electrophoresis is at its most powerful in answering such problems, particularly when the two entities are sympatric. From conventional definitions under the biological species concept (and also for the phylogenetic species concept; Cracraft 1983, see also Templeton 1989), two sympatric morphs should, if conspecific, be part of the same evolutionary unit. In other words, they should have (given certain assumptions and within the limits of expected and calculable sampling errors) the same gene frequencies at each locus. Clearly, samples of different morphs that are conspecific should be freely interbreeding and therefore be different only at the loci coding for their morphological difference and perhaps some closely linked loci. Even if these morphs were subject to some sort of assortative mating or strong selection pressure, the gene frequencies over all the other gene loci should, because of recombination, remain similar (Wright 1978). Main assumptions are that gene frequencies are not altered by postzygotic selection or by individuals with different gene frequencies migrating in from elsewhere. Given these assumptions significant variation at any locus, between two sympatric populations, demonstrates a barrier to gene flow and at least partial reproductive isolation. In sexually reproductive, routinely outbreeding organisms, this indicates the likelihood that two populations should be regarded as different species. Available evidence suggests that selection is unlikely to cause major problems. Although many workers over the last 20 years or more have devoted a great deal of time and effort trying to demonstrate the effects of natural selection on the frequencies of electrophoretically detectable alleles at enzyme loci, it is far from clear that these alleles are, under natural conditions, commonly influenced by selective forces. The extensive literature covering the putative effects of selection on allozyme loci (reviewed by, for example, Nei 1987) indicates that resultant

differences are rarely, if ever, marked or even unambiguously detectable. It is thus improbable that any observed level of genetic differentiation of sympatric morphs will result from selection alone.

Migration of individuals to give mixed gene pools is generally more of a theoretical problem than a practical problem. Allopatric populations if reproductively isolated may be expected to diverge genetically over a period of time and eventually to accrue clear differences in gene frequencies at various loci. However, an almost inevitable feature of any model of allopatric genetic divergence is that (except with most improbably strong selective pressure) almost any degree of migration (as low as one individual per generation, irrespective of population size; Wright 1978; Nei 1987; Maynard Smith 1989) or gene flow between populations will preclude divergence. Herein lies the problem for the idea of the possible mixing of genetically diverged populations, because, if they are close enough for individuals to coexist anywhere within their dispersive range, it would be extremely unlikely that at least a minimal amount of gene flow could not occur between them and thus genetic divergence would be most unlikely to have occurred in the first place (see Todd *et al.* 1991; but also see Palumbi 1992).

It should be remembered that allozyme data cannot show that two morphs are conspecific, only that no significant differences could be found. It is always a possibility that differences existed, but were not found.

2.2.1.2.2 Restriction fragment length polymorphism (RFLP). Restriction endonucleases are highly specific enzymes which cut a molecule of DNA wherever a particular nucleotide sequence occurs. When the DNA is digested with a restriction enzyme the DNA will be cut into fragments. Different individuals may well have differences in nucleotide sequence and may produce a different number of restriction fragments which can be separated by electrophoresis. This polymorphism in restriction sites forms the basis of the study of RFLPs. Restriction sites can be gained or lost through mutation.

The important feature of RFLPs is that gains or losses of restriction sites will behave in a Mendelian way and can be detected through the electrophoresis of the DNA fragments. If the total DNA from one organism is digested with a restriction enzyme, the number of fragments generated will be too large to be analysed. Smaller regions of the genome are generally studied.

RFLP analyses provide character data in one of two types (Swofford and Olsen 1990). The first type occurs when the RFLPs are mapped to specific locations within the gene region being examined, resulting in restriction site data. The restriction site data are a direct assay of the underlying nucleotide sequence data resulting in a genotypic assay. However, because the mapping of

restriction sites can be difficult and time-consuming (Murphy *et al.* 1990), researchers often treat the presence or absence of the restriction fragments of a given length as character states (i.e. restriction fragment data). While restriction fragment data are more easily obtained, they suffer from the potential of violating the assumption of independence among characters critical to phylogenetic analyses (Swofford and Olsen 1990). Thus, when restriction fragment data are obtained, they assay a phenotype which may or may not accurately reflect the underlying genotype or nucleotide sequence pattern.

RFLP has largely been used in three ways:

1. Using large amounts of purified organelle DNA. Organelle (mitochondrion or chloroplast) DNA molecules can be purified and, after electrophoresis, the restriction products are stained with ethidium bromide. This method usually involves working with large amounts of fresh tissue (freezing makes the separation of mitochondrial and nuclear DNA more difficult; White and Densmore 1992). The mapping of the restriction sites on the molecule is facilitated by its relatively small size; an additional advantage is the knowledge now accumulated on the organelle genome of many organisms (Gold *et al.* 1993; Smolenski *et al.* 1993). A limitation of this approach is that, at present, it is not applicable to nuclear DNA.

Since organelles are usually transmitted through the female, organelle DNA will be transmitted maternally. The organelle haplotypes will not, therefore, behave in a Mendelian way, the population being constituted of clones of female-to-female inheritance lines. This means that organelle DNA may give false information about population structuring, especially in species where dispersal is different between males and females (Avisé 1994).
2. Visualization of RFLP fragments with molecular probes. The total DNA of the organism can be digested with restriction enzymes, but then methods are needed to look at just a small proportion of the fragments. This approach is similar to that used for allozymes, where after the electrophoresis of total soluble proteins only a few are visualized (stained). With the probe technique the differential visualization of homologous regions of DNA is achieved through the electrophoresis of DNA fragments and their transfer to a membrane ('Southern blotting'), which is then hybridized with pieces of cloned DNA ('probes') for one given region of the genome. These DNA probes can be radioactively or chemically labelled for subsequent identification using autoradiography or specific stains. The probes can be stripped off the membrane, which can then be re-probed for another region

of the genome. This method is sensitive and relatively simple, but depends on the availability of suitable probes (Aquadro *et al.* 1992; Stabile *et al.* 1992; Tegelstrom 1992). It can be used for nuclear genes.

3. RFLP on DNA fragments generated by PCR. Because of the large amounts of DNA produced by PCR (polymerase chain reaction; see below), the results of the subsequent use of restriction enzymes can be visualized directly on an agarose gel stained with ethidium bromide. Primers must be designed for homologous regions of the genome (Hoelzel and Green 1992; Arnheim and Erlich 1992; Holland 1993), and these are then used to amplify fragments, which are then cut. A small number of restriction sites is likely to be found, and analysis is straightforward (see Karl *et al.* 1992; Karl and Avise 1993). This approach is the fastest and the simplest, since it does not require cumbersome procedures for organelle DNA purification, nor does it require Southern blotting or hybridization/detection processes. It does, however, require adequate primers, the production of which can be laborious. Once the primers have been designed, though, data can be acquired quickly and relatively inexpensively, so that population analysis becomes feasible. This method also is applicable to nuclear DNA.

2.2.1.2.3 Multi-locus DNA fingerprinting of minisatellite loci. The most common use of RFLP is, as outlined above, to provide genetic markers, either with maternal inheritance (as with mtDNA) or with a Mendelian segregation (with nuclear DNA). In order to be able to interpret the restriction patterns genetically, the number of bands produced has to be limited. Sometimes, however, it may be desirable to detect individual differences (e.g. in the study of family or clonal structure). In this case, emphasis is put on detecting large numbers of very highly variable loci. This technique has been called DNA fingerprinting (Jeffreys *et al.* 1985; Pemberton and Amos 1990), and usually involves the Southern blotting of RFLP fragments and their probing with non-specific probes (see Bruford *et al.* 1992). There are difficulties in interpretation due to the very large number of loci visualized and the possibility of dominance, since the smaller fragments are usually not visualized.

2.2.1.2.4 Single-locus DNA fingerprinting of minisatellite loci. This technique is similar to that above but uses single loci with variable numbers of tandem repeats (VNTR). It has been applied to both 'minisatellites' and 'microsatellites'. The main advantage is that gene frequencies can be calculated, and standard population genetic methods used to analyse the data.

2.2.1.2.5 Gene cloning and polymerase chain reaction (PCR). One of the basic needs in molecular biology is for

the production of large amounts of a small part of a DNA molecule. This DNA will then be used directly for population genetics (through RFLP analysis or sequencing) or as a probe to detect homologous regions of DNA of other individuals (e.g. Southern Blotting analysis, described above). Until recently the usual technique for DNA amplification was recombinant cloning, which is the insertion of a chosen DNA fragment into a plasmid or viral genome ('ligation'), and the insertion of this plasmid or virus into actively reproducing bacterial cells ('transformation'). During bacterial cell replication the plasmids or viruses will also reproduce, so that in a few generations the inserted DNA will have been reproduced thousands of times. The plasmid DNA is then extracted from the bacterial cells and excised with specific restriction enzymes, which cut the DNA close to the insertion point. The inserted segment can then be separated from its carrier plasmid by gel electrophoresis, or it can be used directly for sequencing. This method is unlikely to be practicable for routine screening of large numbers of organisms.

Another way of amplifying DNA is by replication *in vitro* using DNA polymerase. This occurs using several cycles of denaturing (separating the two strands) of the DNA molecule through heat (DNA polymerases use single-stranded DNA as a template), cooling it down for annealing with specific primers and the synthesis of a new DNA fragment, so that, in one cycle of some 3–5 minutes the number of copies of the region of the DNA between the two primers (one for each strand) is doubled. If the cycle is repeated many times, large numbers of copies of the DNA fragment will be produced.

This use of polymerases for *in vitro* cyclic DNA replication is known as the Polymerase Chain Reaction (PCR) (e.g. Saiki *et al.* 1985; Innis *et al.* 1990; Arnheim and Erlich 1992; Hoelzel and Green 1992). The technique of PCR is conceptually and technically simple, and the difficult aspect is designing the right primers for the genes to be studied (Holland 1993). Another difficulty is the optimization of experimental conditions (Innis *et al.* 1990; McPherson *et al.* 1993).

PCR is extremely sensitive, so that contamination can be a major problem and therefore exacting procedures to avoid contamination are required (Kwok and Higuchi 1989; Longo *et al.* 1990; Sarkar and Sommer 1993).

One of the advantages of PCR-based analysis is that the amount of DNA needed for the amplification is extremely small (Li *et al.* 1988). Thus PCR can be used to amplify DNA from preserved tissues (Shiozawa *et al.* 1992) or from small larvae (Silberman and Walsh 1992; Corte-Real *et al.* 1994a). An additional advantage is that in rare or protected species molecular analysis can be done in a non-destructive way (Whitmore *et al.* 1992).

There are several ways in which PCR can be used for population analysis (Avise 1994). The products of the PCR

can be cut with restriction enzymes for RFLPs (see above), the products of the PCR themselves may be variable in length, or PCR products can be sequenced (see below). The largest difference between applications, however, is to be found in the strategy for the development of primer systems. In this case, three main alternative approaches are available.

1. Use of homologous primers. Species-specific primers (i.e. primers with exact, homologous, matches of sequence) can be designed using laboratory sequence data derived from a genomic library (Warner *et al.* 1992; Karl and Avise 1993), from sequence data available from the literature or from gene data banks, or from the sequencing of PCR products initially produced with heterologous primers for ubiquitous genes. For conserved sites the problems of non-specific amplification are largely avoided (Hoelzel and Green 1992). Population analysis can then be carried out via RFLP or sequencing of PCR products obtained through primer systems designed for exons of protein-coding genes (McVeigh *et al.* 1991) or for conserved rDNA regions flanking a highly variable non-transcribed spacer (Martin *et al.* 1992; Wenink *et al.* 1993). Homologous primers can also be designed for conserved regions flanking microsatellites (large numbers of repeats of short nucleotide sequences, which are separated and visualized directly; Warner *et al.* 1992). They can also be designed for conserved regions of exons flanking introns, which are less affected by natural selection and therefore have more gene variation which can be useful for population genetic analysis (Corte-Real *et al.* 1994b).
2. Use of heterologous primers. Some regions of the genome are evolutionarily highly conserved (Nei 1987). This makes it possible to design primers for a population analysis in one species using sequence data published for homologous regions of the genome in other species (Hoelzel and Green 1992; Holland 1993; Karl and Avise 1993). They are termed heterologous because sequences are not generally identical.
3. Use of random primers (the RAPD technique). As a result of the tolerance of PCR to mismatches between primers and the DNA template, principally at lower temperatures (30–35 °C), short arbitrary sequences of nucleotides can be used to amplify random fragments of DNA. This technique is called the analysis of 'random amplified polymorphic DNA' (RAPD; Welsh and McClelland 1990; Williams *et al.* 1990). Usually RAPD analysis produces a large number of fragments, many of which are individual-specific. Since RAPD is a PCR-based technique, it can be used to work with very small

amounts of tissue. If inheritance is verified, RAPD patterns can also be used for population genetics (Chapco *et al.* 1992).

2.2.1.2.6 Nucleotide sequences. Nucleotide sequences of either DNA or RNA offer the greatest genotypic resolution as these methods survey the nucleotides themselves. Nucleotide sequences can be obtained either by direct sequencing of genomic DNA using specific primers to amplify (via PCR; Saiki *et al.* 1988) targeted regions of the genome or by cloning regions of interest and sequencing from the cloned fragment. The most commonly used method of sequencing is the Sanger dideoxy method (Hillis *et al.* 1990). While nucleotide sequencing allows for a direct assay of the DNA or RNA sequence, a limitation of the method is that it only surveys a small proportion of the genome relative to, for example, restriction site surveys. Nucleotide sequencing also tends to be one of the most expensive methods of surveying genetic diversity. The trade-offs between cost, amount of genetic material surveyed, and desired resolution all depend upon the questions being addressed (see Box 2.2-3).

2.2.1.2.7 Applications of PCR. As the DNA sequences of more and more genes from various species of animal and plant become known the number of loci available for PCR analysis will increase. It is very likely that over the next few years PCR population analysis will become at least as popular as allozymes for population genetic studies. RAPD is a useful technique for the identification of strains of algae or other asexually produced organisms (Patwary *et al.* 1991), and for the identification of individuals to species that are otherwise difficult to separate (Crossland *et al.* 1993).

2.2.1.2.8 Conclusions. Molecular techniques are more expensive than most ecological or morphological approaches to the study of genetic or species diversity and consequently such methods should be used only where other techniques are less powerful or not feasible, not merely because they may be considered less up-to-date. Molecular population genetics has always been a scientifically fashionable field, but the favoured techniques have changed from allozyme electrophoresis in past decades, to PCR, RFLPs, RAPDs and sequencing in the 1990s. This has, not surprisingly, been detrimental to collaboration between different fields. Nowadays there is a drive to use DNA-based techniques to approach population genetic problems, even when simpler techniques (such as allozyme electrophoresis) can give the same information, at a fraction of the price. This may have an important effect on the funding policies of scientific research particularly in Western countries, but it is simply the result of timing and historical context. The main reason is not that DNA techniques are necessarily better but rather, that they are new. As Avise (1994) has pointed out:

Imagine, for the sake of argument that DNA sequencing methods had been widely employed for the past 30 years and that only recently had protein-electrophoretic approaches been introduced. No doubt a headlong rush into allozyme techniques would ensue, on justifiable rationales that (a) the methods are cost-effective and technically simpler, (b) the variants revealed reflect independent Mendelian polymorphisms at several loci scattered around the genome (rather than as linked polymorphisms in a single stretch of DNA), and (c) the amino acid replacement substitutions uncovered by protein electrophoresis (as opposed to the silent base changes often revealed in DNA assays) might bring molecular evolutionists closer to the real stuff of adaptive evolution.

It is important to assess objectively the advantages and disadvantages of each technique before deciding which to use. Allozyme electrophoresis is a well-established technique for evolutionary or population work, and nowadays its use is simple and straightforward. An indication of how mature an experimental approach has become is the type of papers published using it: recent papers using allozyme analysis tend not to have the word allozymes in the title, and are 'problem oriented'. On the other hand, many papers using DNA technology have the words DNA, PCR or RFLP in the title and are 'technique oriented'. Not surprisingly, many of those papers are just basic descriptions of levels of gene variation with one method or another (like many early allozyme studies). It is likely that, as they become simpler and better understood, DNA methods will simply join the rank of 'good techniques for the right problems', together with allozymes. It is not unreasonable to predict that RAPDs and DNA fingerprinting will probably occupy a niche within the study of individual variation; RFLPs of PCR-amplified DNA will become well established, together with allozymes, for population genetic work, and, assuming further reductions in time and cost, DNA sequencing will be used in both population genetics and phylogenetics.

2.2.2 Patterns of differentiation under domestication

Crops and ornamental plants, livestock, pets, and the microorganisms involved in the fermentation of foods and drinks are all domesticated organisms that have arisen by evolution from wild organisms. Much research has concentrated on the origin of domesticates, benchmarks being studies by de Candolle (1882) on plants, and by Geoffroy Saint-Hilaire (1861) on animals. Darwin himself used knowledge derived from breeding domesticates, particularly domestic pigeons, for examples of genetic variation and changes that occurred in response to selection (Darwin 1859, 1868).

Domestication is the inclusion of wild species populations, wholly or in part, into human society. This is a gradual process which is coincident with and followed by genetic changes brought about by the changed selection pressures. At the beginning a wild organism is husbanded: a wild plant is cultivated, a wild animal is kept captive, or attaches itself to a human community, a wild yeast is cultured. But the continued husbandry of many generations has an impact on the organisms themselves. Whether this is occurring consciously or unconsciously on the part of the humans involved, the husbandry process exerts a selection pressure (*artificial selection* as contrasted with *natural selection*) that causes a shift in the genetic make-up of the organism. So those populations of a species husbanded by humans undergo evolution both towards more reliable husbandry (e.g. easier germination in crop plants, tamer behaviour in large mammals) and towards greater yield of the desired product, be it the seeds of cereals, the milk of livestock or the alcohol of yeast. In some cases the organisms become profoundly different from their wild forebears, and totally dependent on humans both for husbandry and reproduction. Wild and domestic populations demonstrably conspecific, as shown by breeding tests, have frequently been given different Latin binomials which confuses both nomenclature and a proper appreciation of the real biosystematic relationships. Domesticates can truly be said to be human cultural products.

The processes of domestication apply to particular populations of the species manipulated by specific populations of humans. So whilst a population is being domesticated in one area, the original wild species can persist elsewhere, at least for a while. Thus for many so-called *domesticated species*, domestication generates genetically differentiated human-controlled races within the species. For example, both garden peas as a world-wide crop, and wild pea populations, coexist in the species *Pisum sativum*. Similarly the vast range of domestic dogs are conspecific with their wild forbear the wolf, *Canis lupus*, although for convenience the former is known as *Canis familiaris*. The patterns of variation discernible between peas (petit pois, marrowfat, mange-tout, forage-peas, etc.) are consequences of genetic variations between man-made races of *Pisum sativum*; the pattern in dogs (alsatians, poodles, pekinese, etc.) is comparable: these are man-made genetic races of *Canis familiaris*. In other cases the *wild progenitors* may have become extinct so that all known examples of a species are of the domesticated races. For instance many variants of the faba bean *Vicia faba* are known (e.g. broad bean, tick bean, horse bean), but in this case the species is today unknown in the wild, as is the Arabian camel *Camelus dromedarius*. The wild ancestor of cattle, the aurochs, is known to be extinct.

Early horticulture and agriculture could have developed from gatherer cultures by a set of practices, beginning with

Box 2.2-5: The domestication syndrome in crop plants (Schwanitz 1966; Harlan 1975; Simmonds 1979; Hawkes 1983).

Character change	Significance
Gigantism	Affects the part of the plant utilized – seed, fruit, root, stem, tuber – an almost universal characteristic of domesticated crop plants.
Suppression of dispersal mechanisms	Results in retention of seed in the fruit or inflorescence; reduction of stolon length in potatoes, resulting in concentration of harvestable product and facilitation of collection. Another virtually universal character.
Suppression of sexual reproduction	Crops reproduced vegetatively by tubers, e.g. potatoes show this. In the special case of the banana its culture as an edible fruit depends on this. It serves to concentrate assimilates in the production of the harvested product.
Changed growth form	May be a consequence of gigantism – larger fruit require structural support, allometric growth changes may result. Plant growth habits become more restrained and less rampant, facilitating crop husbandry.
Changed life-form	Short-lived perennials (e.g. <i>Phaseolus</i> beans) may become biennial or annual, often in response to selection for higher yield and earlier maturity. The energy required for perennation can be diverted to production of biomass usable by humans.
Changed breeding system	Self-pollination has advantages in reducing weather-dependence for pollination, promoting yield stability in areas with unpredictable weather conditions.
Loss of seed dormancy	Promotes predictability in production of good crop stands and highly advantageous in cultivation. Short-term dormancy is useful in moist climates inhibiting sprouting in the ear of cereals and seeds in pods of legumes.
Biochemical changes	Commonly involve loss of toxic or distasteful compounds, glucosinolates in Brassicas, cucurbitacin in cucurbits, cyanogenic glycosides in Lima beans and cassava, lectins and protease inhibitors in some legume crops.
Changed ploidy level	May be auto- or allopolyploidy. Autopolyploid grasses (e.g. <i>Lolium</i> spp.) are cultivated. Allopolyploidy is more significant, has resulted in production of essentially new species such as the bread wheats and many soft fruit novelties (<i>Rubus</i> spp.).
Physiological changes	Photoperiod requirements can limit extension of the range of crops which originate in low latitudes at high elevations. A change to day neutrality can enable this to occur as in <i>Phaseolus vulgaris</i> , the common bean.

protecting individuals (e.g. wild fruit trees, baobab, oil palm), eliminating undesirable species in semi-natural habitats, allowing some roots to remain in the soil after collecting (e.g. wild yams), and deliberate planting of crops in ploughed or hoed fields. From the Neolithic period c. 10 000–1500 BP, humans have imposed both conscious

and unconscious selection for such traits as ease of harvest, storage ability, high and reliable germination rate, and enhancement of parts of the plant being consumed (including improvement of taste and texture). Many of these selection pressures have been conscious, but some are simply due to the effects of cultivation practices, such as

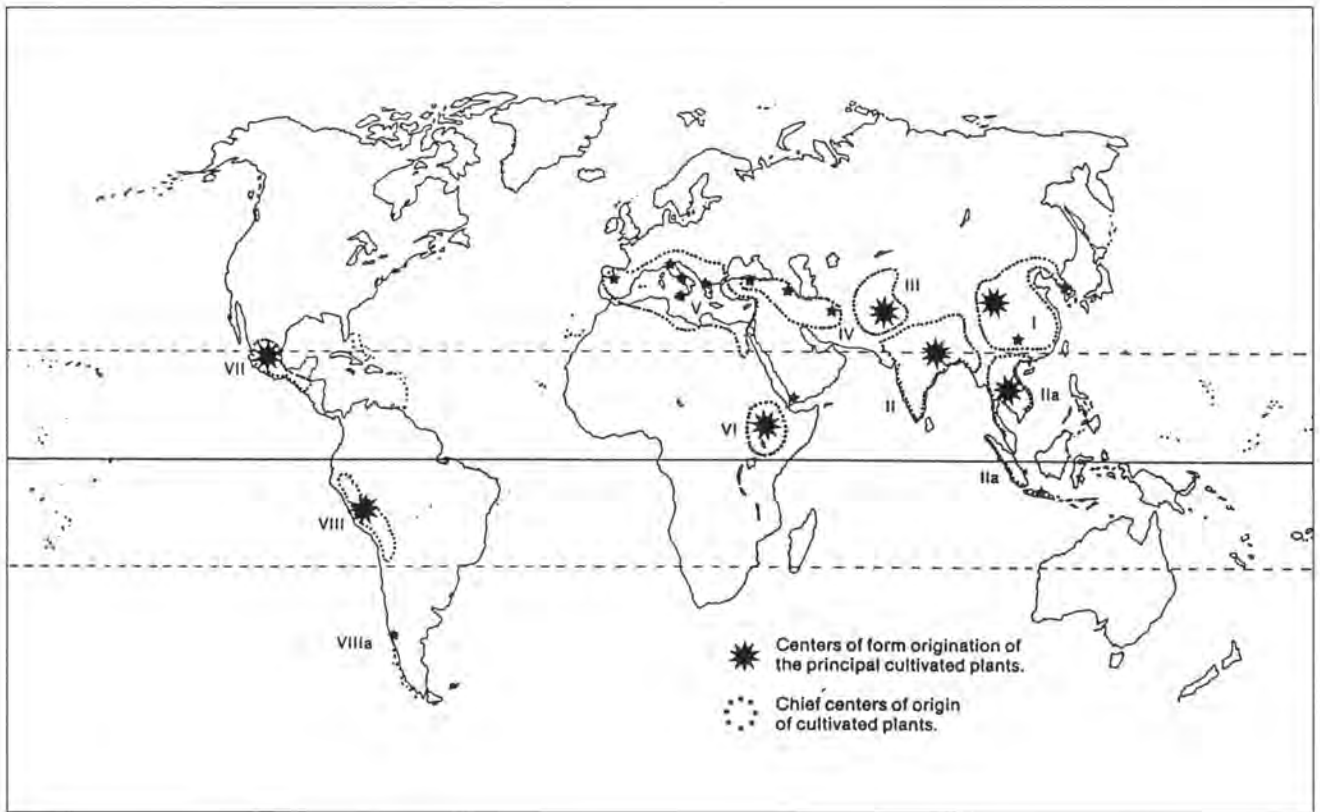

Figure 2.2-3: Vavilov's world centres of origin of cultivated plants (Vavilov 1951). Stars indicate centres of form origination of the principal cultivated plants; dotted areas indicate chief centres of origin of cultivated plants (Hawkes 1993).

non-shattering and non-dormant seeds, or adaptation to day-length. With the development of crops morphologically and physiologically distinct from their original wild progenitors, many cultivated plants have become increasingly distanced genetically from their wild relatives. In the case of cereals, the basic domestic traits are controlled by relatively few linked genes, forming a 'domestication syndrome' (Harlan 1975; Pernès 1983): in other crops it can be more complex (see Box 2.2-5).

In this century, Vavilov (1951) was the first to study extensive collections of cultivated plants, allowing him to elaborate his theory of centres of diversity which he equated with centres of origin (see Fig. 2.2-3). Subsequent research on several crops showed that in some cases, secondary centres of diversity existed, and that many crops did not fit into the original scheme. Harlan proposed a modified concept, distinguishing real centres of origin of limited area, and large 'non-centres' where crops and techniques could have spread later in history (Harlan 1975; Zeven and de Wet 1982). Whereas present researchers now see domestication as a process of biological evolution interacting with human practices and cultural traits, the popular success of the 'centres of origin' concept may lead to some misconceptions because it ignores phenomena such as transdomestication (Hymowitz 1972) and history, and

also underestimates the role of farmer societies outside the centres.

It is not easy to define a domesticated animal. Many wild animals may be tamed as babies or juveniles but generally revert as adults to the wild pattern of behaviour towards humans, often in a dangerous and unpredictable way. Domesticated animals have been selected so that such wild patterns have been suppressed to a greater or lesser degree, as in domestic cattle for example. A domestic animal is one that has been bred in captivity for purposes of economic profit to a human community that maintains complete control over its breeding, organization of territory and food supply (Clutton-Brock 1987). The first domesticated animal was the dog, followed by the major livestock species: cattle (both taurine and humped (zebu), sheep, goat, pig, horse and ass), and all these are thoroughly assimilated into human culture. Clutton-Brock (1987) distinguishes the cat, Asian elephant, camelids, reindeer, water buffalo and the Asiatic cattle other than the zebu, as 'exploited captives'. The rabbit and ferret and many rodents and carnivores including fur-bearers form another stratum, the small mammals. Finally many species, including the cheetah and many deer and antelopes, are or have been the subject of game farming or experimental domestications. The distinctions among these strata are essentially on the basis of the closeness of the human-animal relationship and also on the degree to which

Box 2.2-6: The domestication syndrome in animals (Clutton-Brock 1987).

Change	Significance
Change in body size	Reduction in body size is an initial change brought about by domestication: subsequently the trend may be reversed. At the present time many breeds of dog are smaller than wolves, but some are larger.
Polymorphism of pelage and external features	External features in wild animals, e.g. the rabbit, tend to be uniform: domesticated breeds vary in pelage, carriage of the ears, eye colour. In cattle an enormous range of size and conformation of horns is found.
Internal characters and dentition	Fat deposition subcutaneously is a feature of cattle, sheep, pigs and other domesticates. Brain size is reduced and the structure of the skull changes, resulting in shortening of the jaw and reduced size of the teeth. Muscle ridges on bones and facets for articulation of joints are reduced, due to the lower level of physical exercise they take.
Behaviour	Changes in behaviour tend to be neotenic in nature, e.g. retention of juvenile patterns: this makes domestic animals more submissive and more easily managed than their wild counterparts.

morphology and behaviour have been modified by captive breeding for human advantage, thus bringing about divergence from wild ancestors (see Box 2.2-6). The process of domestication is not fully understood and attempts in recent years to domesticate wild species have been only partly successful. Almost certainly (Clutton-Brock 1987) in prehistoric times the taking of baby animals from the wild, their rearing in human society and the retention for breeding of those that showed themselves adaptable to these conditions would have played a part in domestication.

Domesticated microbes include microbial variants or strains used to make antibiotics and vaccines, as well as those traditionally used to make bread and wine. Fermentation has been used since 5000 BC as a means of producing alcohol and various foods (Nisbet and Fox 1991). Like some domesticated animals and plants, some microbes used in the manufacture of food or other products have retained their capacity for feral return to the wild (Davis 1987).

Weeds and commensals must also be included in discussion of domesticated organisms. A weed is defined by Harlan and de Wet (1965) as 'a generally unwanted organism that thrives in habitats disturbed by man'. Commensal animals and microorganisms under a very similar definition may associate directly with humans (as parasites, diseases or domestic pests), or with domesticated plants or animals (as crop or livestock diseases or pests). They too undergo a parallel domestication process – that is, selection for success in the same human-made environments, and the only difference is that humans have had no intention of husbanding them. The important point is that in some cases there has been a subsequent reversal

of roles and a weed or pest subsequently becomes a preferred domesticate: the crop plant rye originated from a weed in this way, and a number of pests, such as pigeons, rats and mice are now used by humans in a variety of positive ways for sport (e.g. racing pigeons) and for research (laboratory rats and mice).

Lastly, feral plants and animals are domesticated forms that have escaped and maintain themselves in the wild without intervention by humans. The term is not normally applied to such species as the fox or rabbit in Australia; these are more accurately described as introductions. Feral populations may be seen as genetic resources, or as pests threatening native flora and fauna, and their value in genetic conservation remains speculative (Hall 1990). Nevertheless it would be wrong to exterminate such populations without characterizing them unless they are causing harm to endemic species populations through competition or predation. An excellent example of a problematic feral population is the wild cattle of Amsterdam Island in the South Indian Ocean. This population is genetically distinct and worthy of conservation as a rare breed but it has devastated the vegetation of the island and threatens unique seabird populations. A management plan has been devised which conserves the cattle but also protects the environment.

2.2.2.1 Characterizing biodiversity within domesticated species

The biodiversity within domesticated species is of interest for two quite different reasons. First, the process of

domestication has led not only to the evolution of new variation, but in many cases to a proliferation of new forms and a range of forms far beyond the variation in the original progenitor wild species. Examples would be the breeds of dogs (from alsatians and rottweilers to pekinese and poodles) or the botanical varieties of *Brassica oleracea* (kale, cabbages, cauliflowers, broccoli, kohlrabi and brussels sprouts). Secondly, because this variation is in already domesticated forms, it is available and more easily utilized than that in related, non-conspecific organisms elsewhere in the range of biodiversity. So, for instance, new food and industrial products are more easily developed from domesticated soya bean than from wild legumes, or, in the research world, laboratory races are more easily developed from commensals (pigeon, rat, mouse) than from wild animals. Indeed this feature is illustrated by the number of domesticated organisms already used for more than one purpose: *Linum usitatissimum* for fibre and oils; *Cannabis sativa* – fibre and drugs; Sheep – *today* wool, skins, milk and meat, but *formerly* also for fat and horn, and *tomorrow* possibly the commercial production of pharmaceuticals, hormones, etc., in the milk of transgenic animals.

The system for naming and classifying the races of domesticated organisms varies widely between plants, animals and microorganisms. The differences reflect not only different professional traditions, but also major differences in the breeding systems and thus the genetic patterns that arise.

In most cases domesticated races are within a species whose ancestors originated in the wild: exceptions are the products of interspecific and occasionally intergeneric hybridization, chimaera formation and gene transfer by biotechnology. So cultivated peas are within *Pisum sativum*, the wild pea, and the yeast used in the fermentation of beer is within the species *Saccharomyces cerevisiae*. Exceptions to this are interspecific hybrids such as the hybrid tea Roses and the mule *Equus caballus easinus*.

In plants, despite the enormous range of breeding systems, the individual precise race is always called a *cultivar*, the word originating from *cultivated variety* (Brandenburg 1986; Styles 1986). However, there are broad traditionally named groupings of cultivars within most domesticated plant species. The most widespread term for these is *cultivar group*, although in some parts of the world a more detailed hierarchy, such as *convar*, *provar*, etc. is used (Jirasek 1966; Parker 1978). A *cultivar* is any group of cultivated plants recognized as a distinct entity in production, utilization and trade. It usually bears one or more distinct common names in a popular language. The word 'cultivar' has been introduced by the International Code of Nomenclature for Cultivated Plants in order to distinguish it clearly from the botanical variety, or varieties, governed by the ICBN. A cultivated plant species may be split into several botanical varieties, but

those varieties may well include both one or more cultivar groups and a great many cultivars. Those involved in the creation and control of new cultivars tend to restrict the use of the term cultivar to a population which is 'distinct, homogeneous and stable', and use the term 'landraces' for the heterogeneous populations previously grown. It is easier to speak about modern cultivars and old or traditional ones.

Cultivated varieties have been named for a very long time, but they were given by horticulturists rather than botanists. Most breeders, especially hybridizers of horticultural plants, give appropriate or imaginative vernacular names to the many new forms of plants they create. In 1862, Alphonse de Candolle recommended that a distinction be made between the names of cultivated and wild plants, but the first Proposals for an International Code of Nomenclature for Cultivated Plants were adopted only in 1950 and published in 1952 (Stearn 1953). This shows how difficult it is to reach a consensus between groups having different traditions and needs. In later editions, the code has been extended to cover agricultural crops and forest trees. It is this code that lays down the rules for naming cultivars and cultivar groups. A series of institutions were nominated by the International Society for Horticultural Science to manage living reference collections and to compile lists of cultivar names. But in the meanwhile, industrial countries had begun establishing regulations for the seed and plant trade. Enforcement of these regulations can be effective only through the use of agreed names, and so regulatory authorities are now playing a leading role in naming cultivars. There are two sets of regulations. The first regulates the commercialization of a cultivar through registration in an official catalogue, which comes under public law. The other protects the rights of the breeder, and comes under private law; it is governed by an international convention (UPOV). In both cases, cultivars must follow technical requirements summarized under the acronym DHS or DUS (distinctiveness, homogeneity, stability or distinctiveness, uniformity, stability). A new cultivar must be distinct from existing cultivars; it must be homogeneous in the sense that differences between individuals must be limited, and stable in the sense that it remains the same through several generations. As to the names of cultivars, some countries have allowed them to be protected as trademarks, whereas others do not. As breeders wanted to have this kind of legal protection, especially in the case of vegetatively propagated plants where no technical protection is available, the practice prevailed of giving two different names to cultivars. The official cultivar name is sometimes a mere code, beginning with three letters indicating the breeder, while the name known by the public is effectively a trademark.

In history, a cultivated species could spread in different regions and continents and diverge with a very small

probability of merging again. Groups of cultivars could then develop and become sufficiently distinct to be given taxonomic status. With the globalization of our society, much initiated by Europeans, interchanges of domesticated plants have accelerated. Breeders now have access to the global gene pool of crops, former differentiation patterns are being blurred. A great number of hybrids have been produced, but information about their pedigree is often scarce. What remains is a set of ideotypes that breeders have followed to fit the needs of production and trade based largely on loosely defined cultivar groups.

Different forms of domesticated animals are known as *breeds*. For a variety of reasons these are often less precisely defined and less distinct than cultivars in plants. A breed is defined as follows (Clutton-Brock 1987): 'a group of animals that has been selected by man to possess a uniform appearance that is inheritable and distinguishes it from other groups of animals within the same species'. The numbers of breeds or breed varieties of the main livestock species in the world, as enumerated by Hall and Ruane (1993) are: ass 80, water buffalo 74, cattle 1085, goat 400, horse 515, pig 481, sheep 1196. It is not known what proportion of the present diversity of breeds has arisen in the very recent past, and what in the 10 000 years or so since domestication. Certainly, the main breed groups, at least of cattle, became distinct very early (Loftus *et al.* 1994a, b). The present-day distribution and abundance of breeds has been interpreted in terms of human geography (Hall and Ruane 1993); world-wide, the most populous countries have the most breeds, suggesting that conditions favouring the growth of human populations have also favoured the differentiation of breeds. This suggests that the more complex the requirements for livestock products and the more complex human society, the more the diversification of breeds.

2.2.2.2 *The genetic basis of cultivars and breeds*

Plant-cultivars differ greatly according to their breeding system and mode of propagation. In the case of self-fertile plants, traditional cultivars are populations consisting of a mixture of lines and their crosses; the first modern cultivars were pure lines taken out of populations, and maintained their genetic integrity substantially from one generation to the next. In the case of outbreeding plants, traditional cultivars or landraces are populations with self-incompatibility and other traits that favour outbreeding; modern cultivars may be populations where some traits have been fixed and are maintained by mass selection, or increasingly, F1 hybrids, which are the product of the first generation of crosses between two pure lines. This solution allows a high level of homogeneity of the crop, and a technical protection for the breeder, as planting the seeds of the second generation will lead to segregation of characters and the growing of a

heterogeneous crop. Other common types of cultivars are clones, which are the genetically identical descendants of one individual, and are reproduced by vegetative propagation. This propagation can be achieved by natural means, such as by production of tubers (potato, cassava, yams) and bulbs (garlic, tulip), stolons (strawberry), lateral shoots (date palm, banana), or by grafting (most fruit trees). Apomictic plants are a particular case where seeds are produced without pollination, reproducing identically the genotype of the mother. Modern clones may be obtained by *in vitro* multiplication (tissue culture). Examples include roses, poplars and orchids.

Outwardly many traditional livestock breeds are very heterogeneous. Many of the breeds listed by Mason (1988), the standard directory to the livestock of the world, are described as having diverse coat colours, horn shapes, etc. Generally in traditional husbandry, because of harsh conditions, any female that survives is used for breeding and human selection for, say, uniformity of coat colour is an unaffordable luxury. In some cases, an array of colour variants may be chosen deliberately for identification, aesthetic or religious purposes. For some livestock, natural selection may be important – Finch and Western (1977) report that in Kenya, cattle with light colour are favoured in very hot environments.

In spite of this outward heterogeneity, traditional breeds are probably relatively uniform in many other ways (conformation, physiological adaptation, etc.), and though critical studies are lacking, it is probable that within-breed variation is less than between-breed variation. Under benign conditions, such as in Britain since the eighteenth century and France since the nineteenth century, selection for uniformity could be practised, and attempts made to improve the mean performance of the breeds thus defined (Hall 1990, 1993; Audiot 1995). The result has been breeds responsive to increased inputs and better care, which were genetically uniform and when crossed with other breeds would impose their characteristics on the latter (an attribute known as prepotency). An example is how the British cattle breeds Shorthorn, Hereford and Aberdeen Angus were crossed with the range cattle of North and South America (themselves descendants of Spanish cattle imported by the followers of Columbus). Within a few generations, the hardy but unproductive range cattle had been changed, by repeated crossing, into good beef cattle, with the outward appearance of British cattle, yet retaining, it is presumed, sufficient genes from their Spanish ancestors to confer local adaptation.

The development of Western breeds was made possible by the use of pedigree registers (herd-, flock- or stud-books) to provide certification of authenticity, and by the use of breed standards whereby only animals conforming to a defined type could be registered. This might suggest the term 'breed' would have different definitions for such

'Western' livestock and for traditional livestock, yet the basic definition (Clutton-Brock 1987) is applicable to both, provided it is understood that by 'appearance' what is meant is not simply coat colour.

It is important to understand the genetic basis of breeds so that appropriate methods of conservation can be deduced. It has been suggested that rates of mutation are sufficiently high that in a numerically large breed there is an adequate supply of new genetic material (Hill 1982); also that an effective way of conserving animal genetic resources is not to concentrate on breeds but to select, from a pool of animals, for biological extremes (for instance to develop lines of extreme fatness and extreme leanness or of very high and very low prolificacies). However, resources are unlikely to be made available for such programmes. Advances in transgenics and biotechnology mean, in principle, that a gene could be transferred into any breed to improve some attribute (but see Hall 1990), but in practice success is not guaranteed because a gene may perform well in one breed but fail when transferred into another. Consequently, the general view is that the most useful unit of variation in animal genetic resources is the breed. The accepted reason for conserving breeds is that new requirements may arise in the future which cannot be met by those breeds currently popular.

Of the seven main livestock species, probably at least 350 breeds outside Europe are in danger of extinction, and about the same number within Europe (Hall and Ruane 1993). Major priorities for research are: (1) the further investigation of the world's breeds, particularly of the less well described species, to make a complete list of those in danger and of the threats facing them, and (2) to understand the genetic relationships among these breeds so that conservation efforts can be targeted effectively.

Hall (1993) suggested that a criterion of taxonomic distinctiveness should be used to determine a priority list for conservation efforts: an alternative view might be that only breeds that are likely to have commercial significance in the future should receive conservation support, but there has been a surprising lack of discussion. What is certain is that there is a very large number of locally adapted breeds, that have evolved in their own particular environments, and which possess productive and adaptive characteristics about which, in most cases, we know almost nothing.

Strains or lines are particular genetic stocks maintaining a particular gene or combination of genes. Practically, they are to be found in species of generally small body size, short generation interval and high reproductive rate, which can tolerate inbreeding depression without causing high losses. Examples include experimental animals of medical interest (such as white mice), small farm animals such as poultry and Chinese carp, and pets such as the pigeon. With advances in biotechnology, strains of genetically engineered animals (such as some new forms of rabbit) are of growing importance.

F1 hybrids, a comparatively recent development in plant breeding, have been a feature of some livestock systems for many decades. The advantageous features of two distinct breeds can be combined in a crossbreed (Hall 1990), which is used not for reproduction of its own kind but for the production of a particular marketable commodity.

2.2.2.3 *Species complexes and gene flow*

As many related plant species are able to exchange genes, the gene pool of a crop plant can be augmented by this process of introgression. Harlan and de Wet (1971) distinguished two levels at which this could occur, and recognized three distinct gene pools (see Box 2.2-7). The primary gene pool is formed by all the plants that may be crossed freely with the target crop. It is synonymous with the biological species (Mayr 1963). The secondary gene pool includes those plants which may be crossed with the cultigen and give fertile hybrids. This could include some closely related species. The tertiary gene pool is formed by plants which cannot be used in classical crosses, but only by techniques such as *in vitro* embryo rescue, protoplast fusion or genetic transformation.

The above approach is crop-centred. It has been reformulated and enlarged by Pernès (1984) with the concept of the species complex. 'Two plants belong to the same species complex if they are able, in natural conditions and with some probability, to exchange genes by hybridization, whether directly or through the use of intermediate plants'. Within a species complex, compartments (or boxes) are distinguished. 'Two plants belong to different compartments if there exist some limitations to the success of their spontaneous hybridization.'

The important scientific issue is that hybridization is no longer considered as an exception, or even a contravention of the natural order, but is understood to have an important functional role in the evolution of living beings, wild as well as domesticated. Even a very low level of hybridization is sufficient to ensure a significant gene flow between populations.

Research on the structuring of genetic diversity is important for knowledge as well as for breeding, as hybrids may be used as bridges in gene transfer. As a result, some components of a complex may be given a taxonomic status at the rank of species or subspecies. Others may not, as is the case with the sexually reproducing diploid forms of *Panicum maximum* and its apomictic tetraploid forms, which may occur in the same area and share the same morphological characters, although belonging to different compartments.

Species complexes may include crops, weeds and the wild relatives of crops. One classical example is the situation in centres of origin, where the wild relative may be found growing with the crop, at the margins of fields, or as a weed in the field itself. Gene flow is important, but

Box 2.2-7: Genetic resource profiles of crop species (Smartt 1990).

Harlan and de Wet Category	Constituents	Order of recourse and accessibility to breeders
GP1 – primary gene pool	(a) Cultigen	1st order
	(b) Weedy form	2nd order
	(c) Wild prototype	
GP2 – secondary gene pool	Cross-compatible species producing \pm fertile hybrids	3rd order
GP3 – tertiary gene pool	(a) Cross-compatible species producing viable but sterile hybrids	4th order
	(b) Cross-compatible species producing inviable hybrids.	5th order
(Quaternary gene pool)	Incompatible related species	6th order

The gene pools are ranked in terms of the accessibility of their germplasm through traditional hybridization methods: these embrace the first three gene pools. Gene transfer from 4th to 6th order gene pools would require biotechnological intervention.

Not all orders and suborders of gene pools exist in all crop species. In some legume crops there is no third order gene pool (*Phaseolus lunatus*, *Glycine max*) and in some species (*Vicia faba*) there is neither a second nor third order gene pool. The presence or absence of these gene pools and an empirical estimate of their magnitude could be useful for planning the collection, conservation and utilization of germplasm resources.

strong disruptive selection pressures maintain both populations as distinct. They have commonly been given taxonomic status as distinct subspecies or varieties. The species complex approach is of particular interest for crops, but may be applied to wild plants as well.

2.2.2.4 Future developments

In traditional agrosystems, farmers collected their own seeds or kept their own livestock, and by so doing, natural selection pressures could act. In modern systems, seeds are bought, and legal and technical regulations lead to stability and homogeneity of cultivars, which means that cultivars are not allowed to evolve naturally. Evolution takes place only through the replacement of old by new cultivars. The reservoir for evolution will lie *ex situ* in gene banks, *in agrò* in the regions of the world where traditional agrosystems are still operating, and *in situ* where populations of wild relatives are maintained: however, new methods of dynamic conservation are being investigated.

Animal breeds have generally maintained a high level of variability up to now. But with ongoing development and refinement of techniques such as artificial insemination, embryo transfer and cloning, their genetic structure may change rapidly, and make conservation measures necessary. The protection of living populations (*in situ* conservation in this context) should be backed up by *ex situ* (cryopreservation) programmes (Hall 1990).

2.2.3 Investigating genetic diversity

Diversity within and among species has traditionally been assessed using morphological, behavioural and karyotypic characters. As addressed in the previous chapter and elsewhere (Hillis 1987), these traditional characters have both advantages and disadvantages over more modern molecular techniques. Particularly in the within-species case, the levels of variation for these morphological characters are typically too low to be of great utility. Molecular data, however, use characters that evolve at typically higher rates, but with a great diversity of rates represented at different loci within the genome (Maynard Smith 1989). Consequently it is important to match the level of taxonomic resolution (or the expected amount of divergence between the groups studied) with the evolutionary substitution rate of the gene or DNA region to be studied. Several different molecular techniques exist which offer different degrees of resolution in assays of population level genetic diversity (Boxes 2.2-4 and 2.2-8). Because these techniques survey different levels of genetic variation, they have greatest utility at different levels of hierarchical relationships within species (Box 2.2-3).

Any molecule of DNA will accumulate mutations through time. The difference between regions is the rate at which the accumulation will proceed. If the region of the DNA is conservative (i.e. accumulates new mutations more slowly), there may not be enough variation in the molecule

Box 2.2-8: Analytical techniques for use with within-species molecular data.***Within-species phylogenetic reconstruction***

Intraspecific phylogenies are useful tools for testing a variety of hypotheses relating to biodiversity issues, from assessing species status to examining correlations between populations and geographic distributions. Traditional phylogeny reconstruction methods (e.g. maximum parsimony, maximum likelihood, neighbour joining, etc., see Swofford and Olsen (1990) for a review) have often been applied to within-species data sets. However, within-species data sets violate many of the assumptions of the traditional methods of phylogenetic reconstruction (Crandall *et al.* 1994). For example, in the intraspecific case, ancestral nodes tend to remain in the population. Interspecific phylogeny reconstruction techniques assume that these ancestral taxa no longer exist in the population. Recombination is more likely to pose a problem for the intraspecific case when nuclear genes are used. Most traditional methods ignore recombination. Finally, multifurcations are a common feature of intraspecific phylogenies, whereas most interspecific phylogeny reconstruction techniques assume bifurcating phylogenies. Templeton *et al.* (1992) have developed a method of phylogenetic reconstruction that takes into account these difficulties. It is based on a population genetic model of divergence which incorporates the shared characters as well as differences to establish relationships. This method is extremely powerful, even when the number of character differences between individuals is small (Crandall 1994).

Measuring population structure

The extent to which a species is subdivided into genetically differentiated subpopulations is an important component of many issues in conservation biology and population genetics. Wright (1951) first developed indices for the amount of population subdivision based on allele frequencies, *F*-statistics (reviewed in Weir 1990: Ch. 5). These indices have been expanded by a number of authors for use with restriction site or nucleotide sequence data and with microsatellites (Nei 1982; Lynch and Crease 1990; Slatkin 1995). Most recently, Hudson *et al.* (1992a) have developed a statistical test for detecting population subdivision based on the analysis of sequence data. They also provide information on the power of this statistic relative to other methods and sample sizes, amount of migration, mutation and recombination.

Rates of migration

The estimation of rates of migration is important in assessing genetic diversity of subdivided populations because it can inform the researcher of the extent to which subdivided populations will maintain that subdivision and the role of migration in the creation of genetic diversity. Migration rates can be estimated by directly monitoring gene flow among populations or by indirect measurements based on genetic divergence (Slatkin 1987). When the direct estimates of gene flow do not correspond to the indirect estimates, large-scale demographic changes can be inferred. Recently, two new techniques for estimating rates of migration have been developed; the first based on phylogeny (Slatkin and Maddison 1989) and the second based on *F*-statistics (Hudson *et al.* 1992b). The relative strengths and weaknesses of each method for different types of data are discussed in Hudson *et al.* (1992b).

Detecting natural selection

The extent to which natural selection has influenced substitutional patterns at various loci can provide valuable information to the conservation biologist. Using nucleotide sequencing data, Hudson *et al.* (1987) developed a statistical test to detect the influence of natural selection. McDonald and Kreitman (1991) later developed an alternative test which requires fewer assumptions about the underlying evolutionary process. Their model has been expanded upon by Sawyer and Hartl (1992).

for population analysis. On the other hand, if the region accumulates mutations too quickly it may become saturated (i.e. new mutations will occur in the same places as earlier ones), and the information available in the molecule will be difficult to interpret. With DNA fingerprinting analysis, for example, the number of alleles at some loci can be so large that the sample sizes that are necessary for obtaining any statistically meaningful gene frequency data are often huge and consequently impracticable for most studies (Bruford *et al.* 1992). It is very important, therefore, that the right

techniques be chosen for the degree of taxonomic resolution necessary. At the level of the individual (e.g. paternity/maternity studies, clonal structure) the emphasis will be in working with high degrees of genetic variation. Good techniques here are combinations of allozyme genotypes at polymorphic loci, DNA fingerprinting, and RAPDs. At the population level, appropriate resolution may be obtained through the analysis of allozymes, RFLPs and nucleotide sequence data. These data are also useful for interspecific comparisons and hybrid zone analyses.

2.2.3.1 Type of biological material available

The size of the organism, and how it can be collected (or how much of it) are important considerations when planning a molecular study of organisms. Work with allozymes, for example, can be used only with material that is fresh or has been frozen soon after collection. Single locus DNA analysis, on the other hand, principally if using PCR, can be done even with samples fixed in alcohol or air-dried (Shiozawa *et al.* 1992). Many organisms produce large amounts of mucus or have many allopathic secondary metabolites, and allowance must be made, in each study, for the optimization of the DNA or allozyme extraction techniques (Kumar *et al.* 1988; Lohuis *et al.* 1990). When working with small organisms (Walsh and Starkweather 1993) or larvae (Graves *et al.* 1990; Silberman and Walsh 1992; Corte-Real *et al.* 1994a) or endangered species with extremely small remaining populations, PCR-based methods are particularly powerful, since they require only minute amounts of tissue.

2.2.3.2 Research and development

There is a basic difference between allozyme and DNA methods in respect of the costs associated with the structure of the work. In the case of allozymes the whole process of the development of tools for the acquisition of data and the application of these tools is integrated. The highest running costs of allozyme electrophoresis are at the final stage of the population analysis (i.e. the biochemical stains for the different allozymes). Consequently individual allozyme laboratories are usually independent and have all means of production for their work. Development costs are generally small, since most allozyme techniques have been thoroughly tested and new enzyme stains can be incorporated more or less directly from descriptions in the literature. Work with DNA, on the other hand, often involves two distinct processes: the development of tools and their use in population analysis are quite separate, and, unlike allozyme electrophoresis, the higher costs are in the beginning of the work, not at the stage of data acquisition. High costs are usually associated with the design of species-specific primers for PCR, or with the production of homologous probes for RFLP analysis. These phases often necessitate DNA cloning and/or gene sequencing, both of which are expensive and labour intensive. Once the primers and probes have been developed, and experimental condition optimized, genetic data can be obtained quickly and at relatively little additional cost.

Ultimately, this separation between designs of primers and probes (i.e. construction of the means of production) and data acquisition (i.e. labour-intensive use of the means of production) stimulates collaboration between different research groups. Laboratories well equipped for molecular biology can be efficiently used for primer design or probe production, processes requiring only a few individuals of

the population studied. Subsequently, these primers/probes can be used to study specific problems best tackled in laboratories better equipped for fieldwork and with a strong background in ecology or population genetics. As DNA sequence data accumulate for a large number of species it will become easier to design primers directly from published sequences and the need for cloning and sequencing will be reduced. However, there will remain a need for close collaboration between molecular and other biological laboratories to identify areas of study and to correct problems.

An important consideration when choosing the best technique to be used to study a problem is time. A typical allozyme laboratory can produce gene frequency data for up to six gene loci for up to 100 individuals in one (long) day. A molecular laboratory will take much longer because of the need to extract and purify DNA, which takes about two days for up to 50 samples. Once the DNA is purified, many PCR analyses can be carried out in a day (it takes about 4 hours to run a PCR, and typically about 20–50 samples can be handled simultaneously). RFLP analysis is limited by the time required for the digestion of the DNA molecules with the specific endonucleases, usually between 2 and 14 hours, with the number of samples that can be analysed dependent on the number of buffer tanks available. In the case of the PCR/RFLP association they have to be made sequentially, so it will take about three days to produce RFLP data for one locus for 100 individuals. Because of this and the high cost, most DNA-based work to date has concentrated on approaches that require smaller sample sizes (e.g. phylogeny or specific evolutionary problems). This situation will probably change as the costs of molecular methods fall, and it is likely that eventually population molecular studies with DNA will commonly use the sort of sample sizes currently practical for allozymes.

2.2.4 Case studies of the use of genetic techniques in studies of within-species and between-species diversity

2.2.4.1 *Partula*

The land snail genus *Partula* comprises approximately 100 species distributed throughout the Marquesas, Society, Austral and Marianas archipelagos of Polynesia and Micronesia. Their variability and microgeographic genetic differentiation, insular habitat, low mobility and ease of handling have enabled the population genetics and evolutionary history of *Partula* to be studied extensively since the early 1960s (White 1978; Cowie 1992). The group is undergoing (or has recently undergone) speciation. The majority of studies, focused on analysis of detailed morphological data taken from a suite of shell characters illustrated in Figure 2.2-4, have revealed no apparent

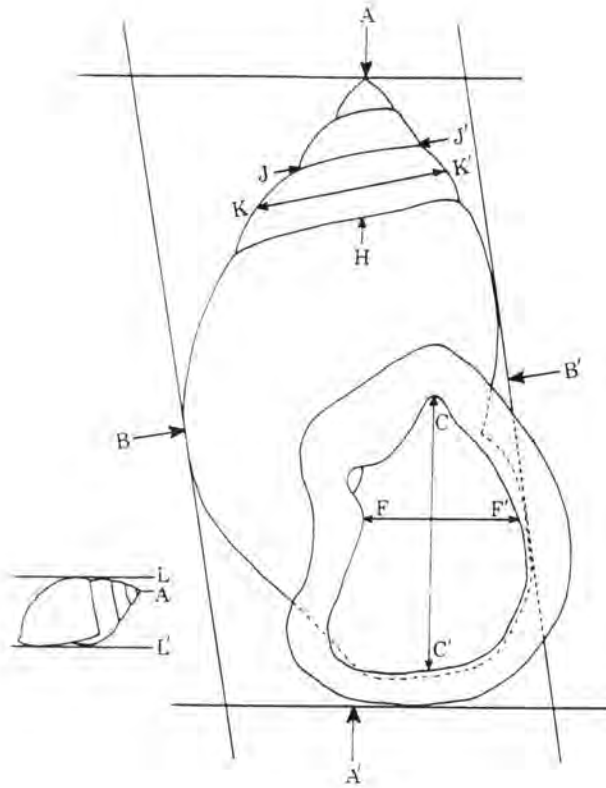

Figure 2.2-4: A shell of *Partula*, showing the points from which measurements were made. AA', length of shell; BB', width of shell; CC', length of aperture; FF', width of aperture; AH, length of spire; KK', width of spire; JJ' width of upper suture; A'C', width of lip; LL', height of shell; AL', height of spire. (Reproduced from Murray and Clarke, 1980.)

correlation of genotype to environmental variables (White 1978; Cowie 1992). Such work has been combined with reproductive data from laboratory and natural populations to place up to 11 'species' of *Partula* from the island of Moorea in the Windward group of the Society Islands into two species complexes: members of each complex show variable levels of reproductive isolation depending upon the 'interspecific' partner and the geography. Whilst clines and hybrids occur at some localities, these species coexist in other areas with no apparent introgression (Clarke and Murray 1969; Murray and Clarke 1980). Partulids represent an unusual situation amongst land snails in that some species exhibit both dextrally and sinistrally coiled shells (Cowie 1992). This has fuelled detailed discussion about the genetics of coiling and its role in isolating mechanisms (Johnson 1982; Johnson *et al.* 1990) and the possibility of single-gene speciation (Orr 1991). The enormously detailed and painstaking studies of the structuring of populations of *Partula* on Moorea provide arguably the most detailed

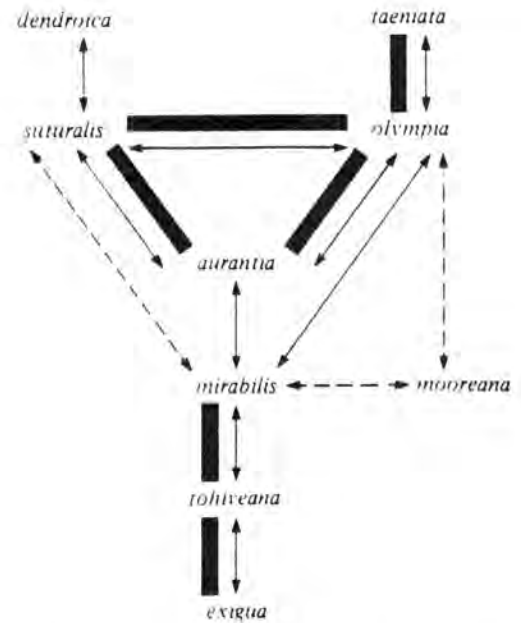

Figure 2.2-5: A phylogeny for species of *Partula*, a Wagner tree based on allozyme frequencies at 22 loci. The horizontal distances are proportional to the inferred amounts of change. (Reproduced from Johnson *et al.* 1986.)

assessment of the ways in which evolution has fitted an animal to different ecological requirements within a restricted geographical area (Murray *et al.* 1982, 1993).

In agreement with the morphological variability, allozyme data have revealed *Partula* to be highly polymorphic, the exception being *Partula gibba* which frequently self-fertilizes (Johnson *et al.* 1977). The genetic identities (I) for conspecific and congeneric comparisons are high compared to expected values from Thorpe's (1982: p. 151) compilation (Johnson *et al.* 1986). A lack of genetic differentiation is expected given that speciation is still in progress and gene flow still occurs between some species by way of hybrids (see Murray and Clarke 1980). Using allozyme data from 24 *Partula* species (including 22 from the Society Islands) and six related species (Partulidae), a phylogenetic tree (see Figure 2.2-5) was constructed and used to infer a biogeographical history for the partulids of the Society Islands (Johnson *et al.* 1986). A monophyletic origin for Moorean species is consistent with results from detailed morphological, reproductive (Murray and Clarke 1980) and karyotypic (Scvortzoff 1966, in Johnson *et al.* 1986) work. Indeed there is a consistent general pattern of speciation by radiation within islands (with the exception of *Partula turgida*, for which there was only one specimen). Whilst this provides support for models of parapatric speciation, molecular methods will undoubtedly have to be employed to confirm the exact

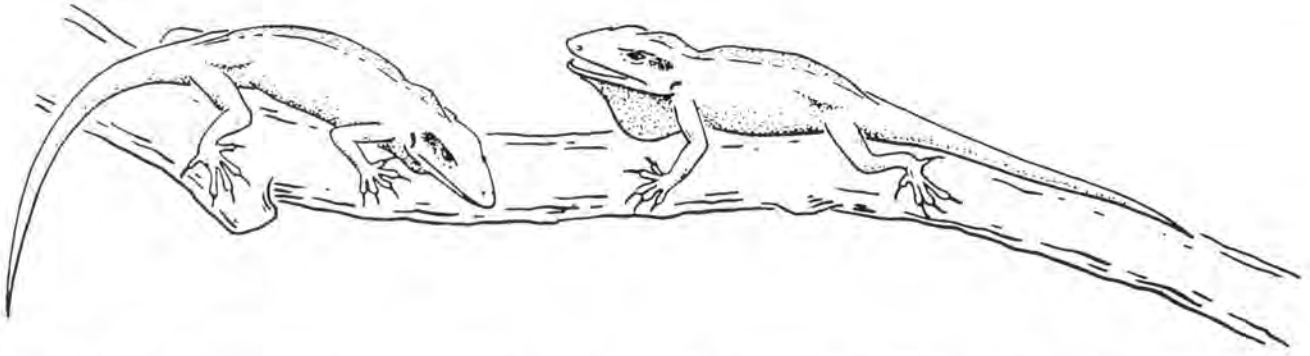

Figure 2.2-6: Aggressive posturing between males of *Anolis carolinensis*. (Reproduced from D. Crews, 1978. In: *Behaviour and Neurology of Lizards*, Greenberg, N. and MacLean, P.D. US Department of Health, Education, and Welfare, National Institutes of Mental Health, Rockville, Md.)

speciation mechanism given the high allozymic similarities of the species. It appears that the Windward partulid species arose by a single colonization from the Leeward Islands and that the Tahitian species arose by radiation after a single colonization from Moorea, a scenario compatible with the known geological history of the Society Islands. Interestingly, the allozyme data also suggest that the ancestral partulids first arrived on the youngest Leeward island, Huahine (Johnson *et al.* 1986). In this sense partulid speciation is virtually unique among well-studied island-dwelling species whose radiations appear mostly to have involved multiple colonizations (Murray *et al.* 1993).

Whilst allozyme data have been used successfully in elucidating a sequence of island colonization and phylogeny in conjunction with more traditional morphological and geological techniques, clearly some problems of speciation and biogeography will probably only be resolved by more detailed molecular studies in suggesting a monophyletic origin for Tahitian partulids (Johnson *et al.* 1986). The complex variation in mitochondrial DNA patterns, however, suggests that parallel, reversed or convergent evolution may be partly responsible for the morphological variation, implying a monophyletic origin of Tahitian partulids (Murray *et al.* 1991) and thus supporting the allozyme data.

Unfortunately, the introduction of a predatory snail, *Euglandina rosea*, has caused the extinction of all wild *Partula* species on Moorea, and other island species are under threat (Murray *et al.* 1988; Murray 1993). The only way forward for the study of partulids and their role in Pacific biogeography is to protect the few secure wild populations and to attempt DNA extraction from the extensive museum collections (Cowie 1992).

2.2.4.2 Anolis

The iguanid lizard genus *Anolis* (illustrated in Figure 2.2-6) offers an effective case study of the successful application

of a range of genetic techniques to the pattern of diversity within and between species. The genus is of considerable ecological importance, being distributed throughout tropical America and the Caribbean and comprising over 200 species, many of them restricted to particular islands. The classification of these species was based originally on osteological data (Ethridge 1960) which were later presented as a formal classification by Williams (1976). The presently accepted phylogeny (Roughgarden 1989; Roughgarden and Pascala 1989) was derived from these data combined with additional information based on the immunogenetic assay of albumins (Gorman *et al.* 1971, 1980; Shochat and Dessauer 1977, 1980), karyotypes (e.g. Gorman and Atkins 1969) and electrophoresis of proteins (e.g. Yang *et al.* 1974; Gorman *et al.* 1980).

Anolis was among the first genera for which detailed studies of population levels and allele frequency analyses were published (Webster *et al.* 1972; Wright 1978). Allele frequencies from four populations of *Anolis carolinensis* from the United States and South Bimini in the Bahamas were re-analysed by Wright to produce estimates of his fixation coefficient (Wright 1978: p. 273). Another study (Webster and Burns 1973) detected sibling species in *Anolis brevirostris* from Haiti. This was an early example of a now routine application of electrophoresis in systematics.

Soulé *et al.* (1973) compared levels of morphological variation and the average heterozygosities of protein products of 20–21 gene loci in eight *Anolis* species. In showing a significant correlation between the morphological and electrophoretic data they provided evidence that a sample of as few as 20 loci could give a reliable estimate of the genetic variation within a population. Their research group also studied the phylogenetic relationships between these eight species (Yang *et al.* 1974), which are distributed on various southern Caribbean islands. The interspecific genetic distances (D of Nei 1972) reported between these

congeneric species were highly variable, ranging from 0.013, which is unusually low for an interspecific comparison, to 0.973, a relatively high value for congeners.

The description of a hybrid between *A. grahami* and *A. lineatopus neckerri* (Jenssen 1977), included reference to unpublished allozyme data generated by T.P. Webster that added powerful support to the diagnosis of the hybrid on morphological and behavioural grounds by Jenssen himself. Gojobori (1982), incorporated heterozygosity estimates from 14 *Anolis* species into a study of the effects of enzyme function on the levels of polymorphism observed at their coding loci. These data, which are discussed by Kimura (1983), showed that heterozygosity levels were generally low at loci coding for enzymes with various functional constraints.

More recently, DNA-based molecular techniques have also proved useful to *Anolis* biologists. Hass *et al.* (1993) incorporated DNA sequence information from a mitochondrial ribosomal RNA gene into a study of the relationships between two putative genera *Chamaelieolis* and *Chamaelinorops* within *Anolis*. Their data led them to conclude that both taxa are recent derivatives within *Anolis*. *Anolis* has also been used to test the assumption of selective neutrality in the mitochondrial genome (Malhotra and Thorpe 1994). On the Lesser Antillean islands of Dominica and Guadeloupe there are morphological clines in *Anolis oculatis* and *A. marmoratus* respectively. Both islands are similar in age, orientation, topography and climate and show parallel ecological zonation. Sequencing of part of the cytochrome *b* gene by Malhotra and Thorpe showed that variation in this region of mitochondrial DNA exhibits a stepped-clinal change congruent with the morphological and environmental clines. They suggest that the logical interpretation of such data is that selection is acting at the molecular level. The authors, however, accepted that such a claim would be contentious and are continuing their research.

Thus the papers on *Anolis* by several groups of workers from the 1970s onwards have provided us with a detailed case study. Techniques ranging from conventional skeletal anatomy to various molecular methodologies have been combined to give a unique insight into the ways in which species and populations of *Anolis* have changed with evolutionary and geographical divergence.

References

- Aquadro, C.F., Noon, W.A. and Begun, D.J.** 1992. RFLP analysis using heterologous probes. In: Hoelzel, A.R. (ed.), *Molecular Genetic Analysis of Populations*. 115–158. Oxford University Press, Oxford.
- Arnheim, N. and Erlich, H.** 1992. Polymerase chain reaction strategy. *Annual Review of Biochemistry* **61**: 131–156.
- Audiot, A.** 1995. *Races d'hier pour l'élevage de demain*. Paris, INRA/BRG.
- Avise, J.C.** 1986. Mitochondrial DNA and the evolutionary genetics of higher animals. *Philosophical Transactions of the Royal Society of London, B* **312**: 325–342.
- Avise, J.C.** 1994. *Molecular Markers, Natural History and Evolution*. Chapman and Hall, London.
- Avise, J.C., Arnold, J., Ball, R.M., Bermingham, E., Lamb, T., Neigel, J.E., Reeb, C.A. and Saunders, N.C.** 1987. Intraspecific phylogeography: the mitochondrial DNA bridge between population genetics and systematics. *Annual Review of Ecology and Systematics* **18**: 489–522.
- Avise, J.C. and Lansman, R.A.** 1983. Polymorphism of mitochondrial DNA in populations of higher animals. In: Nei, M. and Koehn, R.K. (eds), *Evolution of Genes and Proteins*. 147–164. Sinauer Associates, Sunderland, Mass.
- Baverstock, P.R. and Moritz, C.** 1990. Sampling design. In: Hillis, D.M. and Moritz, C. (eds), *Molecular Systematics*. 13–24. Sinauer Associates, Sunderland, Mass.
- Blanca, G., Luceno, M. and Moreno, M.** 1987. *Centaurea avilae* Pau (Asteraceae). In: C. Gomez-Campo, C. (ed), *Libro Rojo de las Especies Vegetales Amenazadas de España Peninsular e Islas Baleares*. 51–52. ICONA, Madrid.
- Bonnell, M.L. and Selander, R.K.** 1974. Elephant seals: genetic variation and near extinction. *Science* **184**: 908–909.
- Bougourd, S.M. and Parker J.S.** 1979. The B-chromosome system of *Allium schoenoprasum* III. An abrupt change in B-frequency. *Chromosoma* **75**: 385–392.
- Brandenburg, W.A.** 1986. Objectives in classification of wild and cultivated plants. In: Styles, B.T. (ed.), *Infraspecific Classification of Wild and Cultivated Plants*. 87–98. Clarendon Press, Oxford.
- Brown, W. M.** 1983. Evolution of animal mitochondrial DNA. In: Nei, M. and Koehn, R.K. (eds), *Evolution of Genes and Proteins*. 62–88. Sinauer Associates, Sunderland, Mass.
- Bruford, M.W., Hanotte, O., Brookfield, J.F.Y. and Burke, T.** 1992. Single-locus and multilocus DNA fingerprinting. In: Hoelzel, A.R. (ed.), *Molecular Genetic Analysis of Populations*. 225–270. Oxford University Press, Oxford.
- Bull, J.J., Hillis, D.M. and O'Steen, S.** 1988. Mammalian ZFY sequences exist in reptiles regardless of sex-determining mechanism. *Science* **242**: 567–569.
- Buth, D.G.** 1984. The application of electrophoretic data in systematic studies. *Annual Review of Ecology and Systematics* **15**: 501–522.
- Caspersson, T., Zech, L., Modest, E.J., Foley, G.E., Wagh, V. and Simonsson, E.** 1969. DNA-binding fluorochromes for the study of the organization of the metaphase nucleus. *Experimental Cell Research* **58**: 141–152.
- Chapco, W., Ashton, N.W., Martel, R.K.B. and Antonishyn, N.** 1992. A feasibility study of the use of random amplified polymorphic DNA in the population genetics and systematics of grasshoppers. *Genome* **35**: 569–574.
- Clarke, B. and Murray, J.** 1969. Ecological genetics and variation in land snails of the genus *Partula*. *Biological Journal of the Linnean Society* **1**: 31–42.
- Clarke, C.A. and Sheppard, P.M.** 1966. A local survey of the distribution of industrial melanic forms in the moth *Biston betularia* and estimates of the selective values of those in an industrial environment. *Proceedings of the Royal Society of London, B* **165**: 424–439.

- Clutton-Brock, J.** 1987. *A natural history of domesticated mammals*. Cambridge University Press, Cambridge and British Museum (Natural History), London.
- Commings, D.E.** 1978. Mechanisms of chromosome banding and implications for chromosome structure. *Annual Review of Genetics* **12**: 25–46.
- Corte-Real, H.B.S.M., Dixon, D.R. and Holland, P.W.H.** 1994a. Intron-targeted PCR: a new approach to survey neutral DNA polymorphism in bivalve populations. *Marine Biology* (in press).
- Corte-Real, H.B.S.M., Holland, P.W.H. and Dixon, D.R.** 1994a. Inheritance of a nuclear DNA polymorphism assayed in single bivalve larvae. *Marine Biology* (in press).
- Cowie, R.H.** 1992. Evolution and extinction of Partulidae, endemic Pacific island land snails. *Philosophical Transactions of the Royal Society of London, B* **335**: 167–91.
- Cracraft, J.** 1983. Species concepts and speciation analysis. *Current Ornithology* **1**: 159–187.
- Cramp, S. Brooks, D.J., Dunn, E., Gillmor, K., Hall-Craggs, J. Hollom, P.A.D., Nicholson, E.M., Ogilvie, M.A., Roselaa, C.S., Sellar, R.J., Simmons, K.E.L., Voous, K.H., Wallace, D.J.M. and Wilson, M.G.** 1988. *Birds of the Western Palaearctic, Birds of Europe, the Middle East and North Africa*, Vol. V, *Tyrant Flycatchers to Thrushes*. Oxford University Press, Oxford.
- Crandall, K.A.** 1994. Intraspecific cladogram estimation: Accuracy at higher levels of divergence. *Systematic Biology* **43**: 222–235.
- Crandall, K.A. and Fitzpatrick, J.F., Jr.** 1994. The use of PCR and DNA sequencing techniques in the determination of crawfish phylogeny (Decapoda: Cambaridae and Parastacidae). *Courier Forschungsinstitut Senckenberg*. (in press).
- Crandall, K.A. and Templeton, A.R.** 1993. Empirical tests of some predictions from coalescent theory with applications to intraspecific phylogeny reconstruction. *Genetics* **134**: 959–969.
- Crandall, K.A., Templeton, A.R. and Sing, C.F.** 1994. Intraspecific phylogenetics: problems and solutions. In: Scotland, R.W., Siebert, D.J., and Williams, D.M. (eds), *Models in Phylogeny Reconstruction. Systematics Association Special Volume No. 52*. 273–297. Clarendon Press, Oxford.
- Crossland, S., Coates, D., Grahame, J. and Mill, P.J.** 1993. Use of random amplified polymorphic DNAs (RAPDs) in separating two sibling species of *Littorina*. *Marine Ecology Progress Series* **96**: 301–305.
- Darwin, C.** 1859. *On the Origin of Species by means of Natural Selection*. John Murray, London.
- Darwin, C.** 1868. *Animals and Plants under Domestication*. John Murray, London.
- Davis, B.D.** 1987. Bacterial domestication: underlying assumptions. *Science* **235**: 1329–1335.
- de Candolle, A.** (ed.) 1882. *L'origine des plantes cultivées*. Reprint J. Laffitte, Germer Baillière, Paris.
- Delamater, R. and Hodgson, W.** 1987. *Agave arizonica*: an endangered species, a hybrid or does it matter. In: Elias, T.S. (ed.), *Conservation and Management of Rare and Endangered Plants*. 305–310. California Native Plant Society, Sacramento.
- D'Emerico, S., Bianco, P. and Mdeagli, P.** 1993. Chromosome numbers and karyotypes in *Arum* (Araceae). *Caryologia* **46**: 161–170.
- Dowling, T.E., Moritz, C. and Palmer, J.D.** 1990. Nucleic acids II: Restriction site analysis. In: Hillis, D.M. and Moritz, C. (eds), *Molecular Systematics*. 250–317. Sinauer Associates, Sunderland, Mass.
- Duncan, R.A. and McDougall, I.** 1976. Linear volcanism in French Polynesia. *Journal of Volcanic and Geothermal Research* **1**: 197–227.
- Dyer, A.F.** 1979. *Investigating Chromosomes*. John Wiley, New York.
- Edwards, S.V.** 1993. Mitochondrial gene genealogy and gene flow among island and mainland populations of a sedentary songbird, the grey-crowned babbler (*Pomastostomus temporalis*). *Evolution* **47**: 1118–1137.
- Ehrlich, P.R. and Holm, R.W.** 1963 *The Process of Evolution*. McGraw-Hill, New York.
- Etheridge, R.E.** 1960. The relationships of the anoles (Reptilia: Sauria: Iguanidae): an interpretation based on skeletal morphology. PhD thesis, University of Michigan.
- Ferguson, A.** 1980. *Biochemical Systematics and Evolution*. Blackie, Glasgow.
- Finch, V.A. and Western, D.** 1977. Cattle colors in pastoral lands: natural selection or social preference? *Ecology* **58**: 1384–1392.
- Foresti, L., Foresti, F., Zambelli, M.F. and de Almeida, S.** 1993. Nucleolar chromosome variants in *Sternopygus macrurus* (Pisces, Sternopygidae) from three Brazilian river basins. *Caryologia* **46**: 53–61.
- Georgiadis, N., Bischof, L., Templeton, A., Patton, J., Karesh, W. and Western, D.** 1994. Structure and history of African elephant populations: I. Eastern and Southern Africa, *Journal of Heredity* **85**: 100–104.
- Given, D.R.** 1994. Aspirations, biodiversity and customary rights in the South Pacific – an ABC of problems and solutions for the future? *Proceedings of International Symposium on Biodiversity and Terrestrial Ecosystems, Taipei, Taiwan*. Academia Sinica, Taiwan.
- Gojobori, T.** 1982. Means and variances of heterozygosity and protein function. In: Kimura, M. (ed.), *Molecular Evolution, Protein polymorphism and the neutral theory*. 137–148. Springer-Verlag, Berlin.
- Gold, J.R., Richardson, L.R., Furman, C. and King, T.L.** 1993. Mitochondrial DNA differentiation and population structure in Red Drum (*Sciaenops ocellatus*) from the Gulf of Mexico and Atlantic Ocean. *Marine Biology* **116**: 175–185.
- Gorman, G.C. and Atkins, L.** 1969. The zoogeography of Lesser Antillean *Anolis* lizards – an analysis based upon chromosomes and lactic dehydrogenases. *Bulletin of the Museum of Comparative Zoology* **138**: 53–80.
- Gorman, G.C., Buth, D.G. and Wyles, J.S.** 1980. *Anolis* lizards of the eastern Caribbean: a case study in evolution. III. A cladistic analysis of albumin immunological data, and the definition of species groups. *Systematic Zoology* **29**: 143–58.
- Gorman, G.C., Wilson, A.C. and Nakanishi, M.** 1971. A biochemical approach towards the study of reptilian phylogeny: evolution of serum albumin and lactic dehydrogenase. *Systematic Zoology* **18**: 286–95.
- Gosse, P.H.** 1860. *A History of British Sea Anemones and Corals*. Van Voorst, London.

- Gottlieb, L.D.** 1977. Electrophoretic evidence and plant systematics. *Annals of the Missouri Botanical Garden* **64**: 161–180.
- Graves, J.E., Curtis, J.J., Oeth, P.A. and Waples, R.S.** 1990. Biochemical genetics of Southern California basses of the genus *Paralabrax*: specific identification of fresh and ethanol-preserved individual eggs and early larvae. *Fishery Bulletin* **88**: 59–66.
- Gupta, P.K. and Tsuchiya, T. (eds)** 1991. *Chromosome Engineering in Plants: Genetics, breeding, evolution*. Part A. Elsevier, Amsterdam.
- Hall, S.J.G.** 1990. Genetic conservation of domestic livestock. In: Milligan, S.R. (ed.), *Oxford Reviews of Reproductive Biology*, Vol. 12. Chapter 8. Oxford University Press, Oxford.
- Hall, S.J.G.** 1992. Conservation of livestock breeds. In: Rege, J.E.O. and Lipner, M.E. (eds), *African Animal Genetic Resources: Their characterisation, conservation and utilisation. Proceedings of the Research Planning Workshop held at ILCA, Addis Ababa, Ethiopia 19–21 February 1992*. 11–16. International Livestock Centre for Africa, Addis Ababa.
- Hall, S.J.G.** 1993. Why are there so many breeds of livestock? In: Clason, A., Payne, S. and Uerpmann, H.-P. (eds), *Skeletons in her Cupboard. Festschrift for Juliet Clutton-Brock*. Oxbow Monograph 34. 99–107. Oxbow Books, Oxford.
- Hall, S.J.G. and Ruane, J.** 1993. Livestock breeds and their conservation: a global overview. *Conservation Biology* **7**: 815–825.
- Harlan, J.R.** 1963. The compilospecies concept. *Evolution* **17**: 497–501.
- Harlan, J.R.** 1975. Crops and man. Madison (Wisconsin). *American Society of Agronomy* **12**: 295.
- Harlan, J.R. and de Wet J.M.J.** 1971. Towards a rational classification of cultivated plants. *Taxon* **20**: 509–517.
- Hartl, D.L. and Clark, A.G.** 1989. *Principles of Population Genetics*. Sinauer Associates, Sunderland, Mass.
- Hartl, G.B., Willing, R. and Suchentrunk, F.** 1990. Comparison of qualitative and quantitative approaches in the evaluation of protein electrophoretic data. *Zeitschrift für Zoologische Systematik und Evolutionsforschung* **28**: 191–216.
- Hass, C.A., Hedges, S.B. and Maxson, L.R.** 1993. Molecular insights into the relationships and biogeography of West Indian *Anolis* lizards. *Biochemical Systematics and Ecology* **21**: 97–114.
- Hawkes, J.G.** 1983. *The Diversity of Crop Plants*. Harvard University Press, Cambridge, Mass.
- Hewitt, G.M. and J. B.** 1970. The B-chromosome system of *Myrmeleotettix maculatus* (Thunb.) IV. The dynamics. *Evolution* **24**: 169–180.
- Hill, W.G.** 1982. Predictions of response to artificial selection from new mutations. *Genetical Research, Cambridge* **40**: 255–278.
- Hillis, D.M.** 1987. Molecular versus morphological approaches to systematics. *Annual Review of Ecology and Systematics* **18**: 23–42.
- Hillis, D.M. and Dixon, M.T.** 1991. Ribosomal DNA: Molecular evolution and phylogenetic inference. *Quarterly Review of Biology* **66**: 411–453.
- Hillis, D.M. and Moritz, C.** 1990. *Molecular Systematics*. Sinauer Associates, Sunderland, Mass.
- Hillis, D.M., Larson, A., Davis, S.K. and Zimmer, E.A.** 1990. Nucleic acids III: Sequencing. In: Hillis, D.M. and Moritz, C. (eds), *Molecular Systematics*. 318–370. Sinauer Associates, Sunderland, Mass.
- Hoelzel, A.R. and Green, A.** 1992. Analysis of population-level variation by sequencing PCR-amplified DNA. In: Hoelzel, A.R. (ed.), *Molecular Genetic Analysis of Populations*. 159–188. Oxford University Press, Oxford.
- Holland, P.W.H.** 1993. Cloning genes using the polymerase chain reaction. In: Stenn, C.D. and Holland, P.W.H. (eds), *Essential Development Biology*. 243–255. Oxford University Press, Oxford.
- Hsu, T.C.** 1979. *Human and Mammalian Cytogenetics*. Springer-Verlag, Berlin.
- Hsu, T.C., Cooper, J.E.K., Mace, M.L. and Brinkley, B.R.** 1971. Arrangement of centromeres in mouse cells. *Chromosoma* **34**: 73–87.
- Hubby, J.L. and Lewontin, R.C.** 1966. A molecular approach to the study of genic heterozygosity in natural populations. I. The number of alleles at different loci in *Drosophila pseudoobscura*. *Genetics* **54**: 577–594.
- Hudson, R.R., Kreitman, M. and Aguadé, M.** 1987. A test of neutral molecular evolution based on nucleotide data. *Genetics* **116**: 153–159.
- Hudson, R.R., Roos, D.D. and Kaplan, N.L.** 1992a. A statistical test for detecting geographic subdivision. *Molecular Biology and Evolution* **9**: 138–151.
- Hudson, R.R., Slatkin, M. and Maddison, W.P.** 1992b. Estimation of levels of gene flow from DNA sequence data. *Genetics* **132**: 583–589.
- Hymowitz, T.** 1972. The trans-domestication concept as applied to gaur. *Economic Botany* **26**: 49–69.
- Innis, M.A., Gelfand, D.H., Sninsky, J.J. and White, T.J.** 1990. *PCR Protocols: A guide to methods and applications*. Academic Press, New York.
- Jeffreys, A.J., Wilson, V. and Thein, S.L.** 1985. Hypervariable minisatellite regions in human DNA. *Nature* **314**: 67–73.
- Jenssen, T.A.** 1977. Morphological, behavioural and electrophoretic evidence of hybridization between the lizards, *Anolis grahami* and *Anolis lineatopus neckeri*, on Jamaica. *Copeia* 1977: 270–276.
- Jirásek, V.** 1966. The systematics of cultivated plants and their taxonomic categories. *Preslia* **38**: 267–284.
- Johnson, M.S.** 1982. Polymorphism for direction of coil in *Partula suturalis*: behavioural isolation and positive frequency dependent selection. *Heredity* **47**: 121–133.
- Johnson, M.S., Clarke, B. and Murray, J.** 1990. The coil polymorphism in *Partula suturalis* does not favor sympatric speciation. *Evolution* **44**: 459–464.
- Johnson, M.S., Clarke, B. and Murray, J.** 1977. Genetic variation and reproductive isolation in *Partula*. *Evolution* **31**: 116–126.
- Johnson, M.S., Murray, J. and Clarke, B.** 1986. An electrophoretic analysis of phylogeny and evolutionary rates in the genus *Partula* from the Society Islands. *Proceedings of the Royal Society of London, B* **227**: 161–177.
- Karl, S.A. and Avise, J.C.** 1993. PCR-based assays of Mendelian

- polymorphisms from anonymous single-copy nuclear-DNA. Techniques and applications for population genetics. *Molecular Biology and Evolution* **10**: 342–361.
- Karl, S.A., Bowen, B.W. and Avise, J.C.** 1992. Global population genetic structure and male-mediated gene flow in the green turtle (*Chelonia mydas*): RFLP analyses of anonymous nuclear loci. *Genetics* **131**: 163–173.
- Kimura, M.** 1983. *The Neutral Theory of Molecular Evolution*. Cambridge University Press, Cambridge.
- Kimura, M.** 1991. The neutral theory of molecular evolution: a review of recent evidence. *Japanese Journal of Genetics* **66**: 367–386.
- Knowlton, N.** 1993. Sibling species in the sea. *Annual Review of Ecology and Systematics* **24**: 189–216.
- Kreitman, M. and Hudson, R.R.** 1991. Inferring the evolutionary histories of the Adh and Adh-dup loci in *Drosophila melanogaster* from patterns of polymorphism and divergence. *Genetics* **127**: 565–582.
- Kumar, S., Degnan, M.M., Ross, I.L., Hawkins, C.J. and Lavin, M.F.** 1988. Isolation of DNA and RNA from ascidians. *Marine Biology* **98**: 95–100.
- Kwok, S. and Higuchi, R.** 1989. Avoiding false positives with PCR. *Nature* **339**: 237–238.
- Lambrot, M.** 1988. Chromosomes and speciation in *Liolaemus monticola* (Iguanidae). *Genome* **30**: 362.
- Learn, G.H. Jr and Schaal, B.A.** 1987. Population subdivision for ribosomal DNA repeat variants in *Clematis fremontii*. *Evolution* **41**: 433–438.
- Lewontin, R.C.** 1974. *The Genetic Basis of Evolutionary Change*. Columbia University Press, New York.
- Li, W.H., Gyllestein, U.B., Cui, X., Erlich, H.A. and Arheim, N.** 1988. Amplification and analysis of DNA sequences in single human sperm and diploid cells. *Nature* **335**: 414–417.
- Loftus, R.T., MacHugh, D.E., Ngere, L.O., Balain, D.S., Badi, A.M., Bradley, D.G. and Cunningham, E.P.** 1994a. Mitochondrial genetic variation in European, African and Indian cattle populations. *Animal Genetics* **25**: 265–271.
- Loftus, R.T., MacHugh, D.E., Bradley, D.G., Sharp, P.M. and Cunningham, E.P.** 1994b. Evidence for two separate domestications of cattle. *Proceedings of the National Academy of Sciences, USA* **91**: 2757–2761.
- Longo, M.C., Berninger, M.S. and Harley, J.L.** 1990. Use of uracil DNA glycosylase to control carry-over contamination in polymerase chain-reactions. *Gene* **93**: 125–128.
- Lynch, M. and Crease, T.J.** 1990. The analysis of population survey data on DNA sequence variation. *Molecular Biology and Evolution* **7**: 377–394.
- McDonald, J.H. and Kreitman, M.** 1991. Adaptive protein evolution at the Adh locus in *Drosophila*. *Nature* **351**: 652–654.
- McPherson, M.J., Quirke, P. and Taylor, G.R.** 1993. *PCR. A practical approach*. Oxford University Press, Oxford.
- McVeigh, H.P., Barlett, S.E. and Davidson, W.S.** 1991. Polymerase chain reaction/direct sequence analysis of the cytochrome *b* gene in *Salmo salar*. *Aquaculture* **95**: 225–233.
- Malhotra, A. and Thorpe, R.S.** 1994. Parallels between island lizards suggests selection on mitochondrial DNA and morphology. *Proceedings of the Royal Society of London, B* **257**: 37–42.
- Martin, A.P., Humphreys, R. and Palumbi, S.R.** 1992. Population genetic structure of the armorhead, *Pseudopentaceros wheeleri*, in the North Pacific Ocean: application of the polymerase chain reaction to fisheries problems. *Canadian Journal of Fisheries and Aquatic Sciences* **49**: 2386–2391.
- Martinez, P., Vigas, A., Bouza, C., Castro, J. and Sanchez, L.** 1993. Quantitative analysis of the variability of nucleolar organizer regions in *Salmo trutta*. *Genome* **36**: 1119–1123.
- Mason, I.L. (ed.)** 1984. *Evolution of Domesticated Animals*. London, Longman.
- Mason, I.L.** 1988. *A World Dictionary of Livestock Breeds, Types and Varieties*, 3rd edn. CAB International, Wallingford.
- May, B.** 1992. Starch gel electrophoresis of allozymes. In: Hoelzel, A.R. (ed.), *Molecular Genetic Analysis of Populations*. 1–18. Oxford University Press, Oxford.
- Maynard Smith, J.** 1989. *Evolutionary Genetics*. Oxford University Press, Oxford.
- Mayr, E.** 1963. *Animal Species and Evolution*. Harvard University Press, Cambridge, Mass.
- Moritz, C., Dowling, T. E. and Brown, W. M.** 1987. Evolution of animal mitochondrial DNA: Relevance for population biology and systematics. *Annual Review of Ecology and Systematics* **18**: 269–292.
- Murphy, R.W., Sites, J.W., Jr, Buth, D.G. and Haufler, C.H.** 1990. Proteins I. Isozyme electrophoresis. In: Hillis, D.M. and C. Moritz (eds), *Molecular Systematics*. 45–126. Sinauer Associates, Sunderland, Mass.
- Murray, J.** 1993. The sinister snail. *Endeavour* **17**: 78–83.
- Murray, J. and Clarke, B.** 1980. The genus *Partula* on Moorea: speciation in progress. *Proceedings of the Royal Society of London, B* **211**: 83–117.
- Murray, J., Clarke, B. and Johnson, M.** 1993. Adaptive radiation and community structure of *Partula* on Moorea. *Proceedings of the Royal Society of London, B* **254**: 205–211.
- Murray, J., Johnson, M.S. and Clarke, B.** 1982. Microhabitat differences among genetically similar species of *Partula*. *Evolution* **36**: 316–325.
- Murray, J., Murray, E., Johnson, M.S. and Clarke, B.** 1988. The extinction of *Partula* on Moorea. *Pacific Science* **42**: 150–153.
- Murray, J., Stine, O.C. and Johnson, M.S.** 1991. The evolution of mitochondrial-DNA in *Partula*. *Heredity* **66**: 93–104.
- Nei, M.** 1972. Genetic distance between populations. *American Naturalist* **106**: 283–292.
- Nei, M.** 1982. Evolution of human races at the gene level. In: Bonne-Tamir, B., Cohen, T. and Goodman, R.M. (eds), *Human Genetics, Part A: The unfolding genome*. 167–181. Alan R. Liss, New York.
- Nei, M.** 1987. *Molecular Evolutionary Genetics*. New York, Columbia University Press.
- Nevo, E., Beiles, A. and Ben-Schlomo, R.** 1984. The evolutionary significance of genetic diversity: ecological, demographic and life history correlates. In: Mani G.S. (ed.), *Evolutionary Dynamics of Genetic Diversity*. 13–212. Springer-Verlag, Heidelberg.
- Nisbet, L.J. and Fox, F.M.** 1991. The importance of microbial biodiversity to biotechnology. In: Hawksworth, D.L. (ed.), *The Biodiversity of Microorganisms and Invertebrates: Its role*

- in sustainable agriculture*. 229–244. CAB International, Wallingford.
- Noguchi, J.** 1988. Geographical and ecological variation of C-bands of *Hemerocallis middendorffii* (Liliaceae) in Japan. *Genome* **30**: 284.
- Orr, H.A.** 1991. Is single-gene speciation possible? *Evolution* **45**: 764–769.
- Palmer, J.D.** 1985. Evolution of chloroplast and mitochondrial DNA in plants and algae. In MacIntyre, R.J. (ed.), *Molecular Evolutionary Genetics*. 131–240. Plenum, New York.
- Palmer, J.D.** 1987. Chloroplast DNA evolution and the biosystematic uses of chloroplast DNA variation. *American Naturalist* **130**: 6–29.
- Palumbi, S.R.** 1992. Marine speciation on a small planet. *Trends in Ecology and Evolution* **7**: 114–118.
- Pamilo, P.** and Bianchi, N.O. 1993. Evolution of the Zfx and Zfy genes: Rates and interdependence between the genes. *Molecular Biology and Evolution* **10**: 271–281.
- Parker, P.F.** 1978. The classification of crop plants. In: Street, H.E. (ed.), *Essays in Plant Taxonomy*. 97–125. Academic Press, London.
- Patwary, M.U.**, Mackay, R.M. and Van der Meer, J.P. 1991. Genetic fingerprinting of *Gelidium vagum* strains using the PCR-based RAPD technique. *Second International Marine Biotechnology Conference*. 84.
- Pemberton, J.** and Amos, B. 1990. DNA fingerprinting: a new dimension. *Trends in Ecology and Evolution* **5**: 132–134.
- Pernès, J.** 1983. La génétique de la domestication des céréales. *La Recherche* **146**: 910–919.
- Pernès, J.** 1984. *Gestion des ressources génétiques des plantes*. Agence de Coop. Cult. et Tech./Lavoisier, Paris.
- Ren, X.** and Yu, X. 1993. Characterization of nucleolar organizer regions of twelve species of Chinese cyprinid fishes. *Caryologia* **46**: 201–207.
- Rogers, A.D.** 1992. *Aspects of the Genetics and Taxonomy of Marine Nemerteans*. PhD thesis, University of Liverpool.
- Rogers, A.D.**, Thorpe, J.P. and Gibson, R. 1995. Genetic evidence for the occurrence of a cryptic species within the littoral nemerteans *Lineus ruber* and *Lineus viridis* (Nemertea, Anopla). *Marine Biology* (in press).
- Rooney, D.E.** and Czepulkowsky, B.H. 1986. *Human Cytogenetics*. IRL Press, Oxford.
- Roughgarden, J.D.** 1989. *The Anoles of the Eastern Caribbean: Competition, coevolution and plate tectonics*. Cambridge University Press, Cambridge.
- Roughgarden, J.D.** and Pacal, S. 1989. Taxon cycle among *Anolis* lizard populations: review of evidence. In: Otte, D. and Endler, J.A. (eds), *Speciation and its Consequences*. 403–432. Sinauer Associates, Sunderland, Mass.
- Routman, E.** 1993. Population structure and genetic diversity of metamorphic and pedomorphic populations of the tiger salamander, *Ambystoma tigrinum*. *Journal of Evolutionary Biology* **6**: 329–357.
- Roy, S.**, Kaul, D. and Ansari, H.A. 1993. Intraspecific chromosomal variability in common green pigeon, *Treron phoenicoptera* (Latham) (Aves). *Genome* **30** (1): 356.
- Richardson, B.J.**, Baverstock, P.R. and Adams, M. 1986. *Allozyme Electrophoresis*. Academic Press, Sydney.
- Saiki, R.**, Gelfand, D.H., Stoffel, S., Scharf, S., Higuchi, R., Horn, G.T., Mullis, K.B. and Erlich, H.A. 1988. Primer directed enzymatic amplification of DNA with a thermostable DNA polymerase. *Science* **239**: 487–491.
- Saiki, R.**, Scharf, S., Faloona, F., Mullis, K.B., Horn, G.T., Erlich, H.A. and Arnheim, N. 1985. Enzymatic amplification of beta-globin genomic sequences and restriction site analysis for diagnosis of sickle-cell anemia. *Science* **230**: 1350–1354.
- Saint-Hilaire, G.I.** 1861. *Acclimatation et domestication des animaux utiles*. Reprint 1986, Maison rustique, Paris.
- Sarkar, G.** and Sommer, S.S. 1993. Removal of DNA contamination in polymerase chain-reaction reagents by ultraviolet irradiation. *Methods in Enzymology* **218**: 381–388.
- Sawyer, S.A.** and Hartl, D.L. 1992. Population genetics of polymorphism and divergence. *Genetics* **132**: 1161–1176.
- Schwanitz, F.** 1966. *The Origin of Cultivated Plants*. Harvard University Press, Cambridge, Mass.
- Sevortzoff, E.** 1966. Chromosome numbers of the land snails of the genus *Partula* that inhabit the island of Moorea. MA thesis, University of Virginia.
- Sessions, S.** 1990. Chromosomes: molecular cytogenetics. In: Hillis, D.M. and Moritz, C. (eds); *Molecular Systematics*. 156–203. Sinauer Associates, Sunderland, Mass.
- Shaw, P.W.**, Beardmore, J.A. and Ryland, J.S. 1987. *Sargatia troglodytes* (Anthozoa: Actiniaria) consist of two species. *Marine Ecology Progress Series* **41**: 21–28.
- Shiozawa, D.K.**, Kudo, J., Evans, R.P., Woodward, S.R. and Williams, R.N. 1992. DNA extraction from preserved trout tissues. *Great Basin Naturalist* **52**: 29–34.
- Shochat, D.** and Dessauer, H.C. 1977. Report on an immunological study of *Anolis* albumins. In: Williams, E.E. (ed.), *The Third Anolis Newsletter*. 184–191. Museum of Comparative Zoology, Harvard University, Cambridge, Mass.
- Silberman, J.D.** and Walsh, P.J. 1992. Species identification of spiny lobster phyllosome larvae via ribosomal DNA analysis. *Molecular Marine Biology and Biotechnology* **1**: 195–205.
- Simmonds, N.W.** 1979. *Principles of Crop Improvement*. Longman, London.
- Slatkin, M.** 1995. A measure of population subdivision based on microsatellite allele frequencies. *Genetics* **139**: 457–462.
- Slatkin, M.** 1987. Gene flow and the geographic structure of natural populations. *Science* **236**: 787–192.
- Slatkin, M.** and Maddison, W.P. 1989. A cladistic measure of gene flow inferred from the phylogenies of alleles. *Genetics* **123**: 603–613.
- Smartt, J.** 1990. *Grain Legumes – Evolution and genetic resources*. Cambridge University Press, Cambridge.
- Smolenki, A.J.**, Overnden, J.R. and White, R.W.G. 1993. Evidence of stock separation in southern hemisphere orange roughy (*Hoplostethus atlanticus*, Trachichthyidae) from restriction-enzyme analysis of mitochondrial DNA. *Marine Biology* **116**: 219–230.
- Solé-Cava, A.M.**, Boury-Esnault, N., Vacelet, J. and Thorpe, J.P. 1992. Biochemical genetic divergence and systematics in sponges of the genera *Corticium* and *Oscarella* (Demospongiae: Homoscleromorpha) in the Mediterranean Sea. *Marine Biology* **113**: 299–304.
- Solé-Cava, A.M.** and Thorpe, J.P. 1995. Molecular population

- genetics – a growth industry in marine biology. In: Hartnoll, R.G. and Hawkins, S.J. (eds), *Marine Biology: A Port Erin perspective*. Centenary Volume of the Port Erin Marine Laboratory. Immel Publishing, London (in press).
- Solé-Cava, A.M., Thorpe, J.P. and Manconi, R.** 1991. A new species of Mediterranean *Axinella* (Porifera – Demospongiae) detected by isozyme electrophoresis. In: Reitner, J. and Keupp, H. (ed.), *Fossil and Recent Sponges*. 313–321. Springer-Verlag, Berlin.
- Soltis, D.E., Soltis, P.S. and Ness, B.D.** 1989. Chloroplast DNA variation and multiple origins of autopolyploidy in *Heuchera microantha* (Saxifragaceae). *Evolution* **43**: 650–656.
- Soulé, M.E., Yang, S.Y. and Weiler, M.G.W.** 1973. Island lizards: the genetic–phenetic variation correlation. *Nature* **242**: 191–193.
- Stabile, J.E., Wurtzel, E.T. and Gallagher, J.C.** 1992. Comparison of chloroplast DNA and allozyme variation in winter strains of the marine diatom *Skeletonema costatum* (Bacillariophyta). *Journal of Phycology* **28**: 90–94.
- Stearn, W.** 1953. Historical introduction. In: *International Code of Nomenclature for Cultivated Plants*. London, Royal Horticulture Society.
- Styles, B.T.** (ed.) 1986. *Intraspecific Classification of Wild and Cultivated Plants*. Clarendon Press, Oxford.
- Svartman, M. and Almeida, E.J.C.** 1993. Pericentric inversion and X chromosome polymorphism in *Rhipidomys* sp. (Cricetidae, Rodentia) from Brazil. *Caryologia* **46**: 201–207.
- Swaminathan, M., Gupta, P.K. and Sinha, U.** (eds) 1983. *Cytogenetics of Crop Plants*. Macmillan India, New Delhi.
- Swofford, D.L. and Olsen, G.J.** 1990. Phylogeny reconstruction. In: Hillis, D.M. and Moritz, C. (eds), *Molecular Systematics*. 411–501. Sinauer Associates, Sunderland, Mass.
- Teglestrom, H.** 1992. Detection of mitochondrial DNA fragments. In: Hoelzel, A.R. (ed.), *Molecular Genetic Analysis of Populations*. 89–114. Oxford University Press, Oxford.
- Templeton, A.R.** 1989. The meaning of species and speciation: a genetic perspective. In: Otte, D. & Endler, J. A. (eds), *Speciation and its Consequences*. 3–27. Sinauer Associates, Sunderland, Mass.
- Templeton, A.R., Crandall, K.A. and Sing, C.F.** 1992. A cladistic analysis of phenotypic associations with haplotypes inferred from restriction endonuclease mapping and DNA sequence data. III. Cladogram estimation. *Genetics* **132**: 619–633.
- Templeton, A.R., Hollocher, H. and Lawler, S.** 1989. Natural selection and ribosomal DNA in *Drosophila*. *Genome* **31**: 296–303.
- Templeton, A.R., Shaw, K., Routman, E. and Davis, S.K.** 1990. The genetic consequences of habitat fragmentation. *Annals of the Missouri Botanical Garden* **77**: 13–27.
- ten Lohuis, M., Alderslade, P. and Miller, D.J.** 1990. Isolation and cloning of DNA from somatic tissue of soft corals (Cnidaria: Octocorallia). *Marine Biology* **104**: 489–492.
- Thorpe, J.P.** 1982. The molecular clock hypothesis: biochemical evolution, genetic differentiation and systematics. *Annual Review of Ecology and Systematics* **13**: 139–168.
- Thorpe, J.P., Beardmore, A. and Ryland, J.S.** 1978b. Genetic evidence for cryptic speciation in the marine bryozoan *Alcyonidium gelatinosum*. *Marine Biology* **49**: 27–32.
- Thorpe, J.P., Ryland, J.S. and Beardmore, J.A.** 1978a. Genetic variation and biochemical systematics in the marine bryozoan *Alcyonidium mytili*. *Marine Biology* **49**: 343–350.
- Thorpe, J.P. and Sole-Cava, A.M.** 1994. The use of enzyme electrophoresis in invertebrate systematics. *Zoologica Scripta* **23**: 3–18.
- Todd, C.D., Thorpe, J.P. and Hadfield, M.G.** 1991. Genetic structure of populations of the aplysiid opisthobranch *Stylocheilus longicaudus* (Quoy & Gaimard) around the shores of O'ahu. *Hawaiian Journal of Mollusc Studies* **57**: 153–166.
- Tsuchiya, T. and Gupta, P.K.** (eds) 1991. *Chromosome Engineering in Plants: Genetics, breeding, evolution*. Part B. Elsevier, Amsterdam.
- Tucker, P.K. and Lundrigan, B.L.** 1993. Rapid evolution of the sex determining locus in Old World mice and rats. *Nature* **364**: 715–717.
- Tucker, P.K. and Lundrigan, B.L.** 1994. The utility of paternally inherited nuclear genes in conservation genetics. In: Smith, T. and Wayne, R. (eds), *Molecular Genetic Approaches in Conservation*. Oxford University Press, Oxford (in press).
- Tucker, P.K., Lee, B.K. and Eicher, E.M.** 1989. Y chromosome evolution in the subgenus *Mus* (genus *Mus*). *Genetics* **122**: 169–179.
- Tucker, P.K., Sage, R.D., Warner, J., Wilson, A.C. and Eicher, E.M.** 1992. Abrupt cline for sex chromosomes in a hybrid zone between two species of mice. *Evolution* **46**: 1146–1163.
- Van Valen, L.** 1973. Are categories in different phyla comparable? *Taxon* **22**: 333–373
- Vavilov, N.I.** 1951. *The Origin, Variation, Immunity and Breeding of Cultivated Plants. Selected writings*. Ronald Press, New York.
- Vosa, C.G.** 1976. Heterochromatic patterns in *Allium*. I. The relationships between the species of the *Cepa* group and its allies. *Heredity* **36**: 383–392.
- Vujosevic, M.** 1992. B-chromosome polymorphism in *Apodemus flavicollis* (Rodentia, Mammalia) during five years. *Caryologia* **45**: 347–352.
- Walsh, E.J. and Starkweather, P.L.** 1993. Analysis of rotifer ribosomal gene structure using the polymerase chain reaction. *Hydrobiologia* **93**: 255–256.
- Warner, J.P., Yuille, M.A.R. and Affara, N.A.** 1992. Genomic libraries and the development of species-specific probes. In: Hoelzel, A.R. (ed.), *Molecular Genetic Analysis of Populations*. 189–224. Oxford University Press, Oxford.
- Webster, T.P. and Burns, J.M.** 1973. Dewlap color variation and electrophoretically detected sibling species in a Haitian lizard, *Anolis brevirostris*. *Evolution* **27**: 368–377.
- Webster, T.P., Selander, R.K. and Yang, S.Y.** 1972. Genetic variability and similarity in the *Anolis* lizards of Bimini. *Evolution* **26**: 523–535.
- Weir, B.S.** 1990. *Genetic Data Analysis: Methods for discrete population genetic data*. Sinauer Associates, Sunderland, Mass.
- Welsh, J. and McClelland, M.** 1990. Fingerprinting genomes using PCR with arbitrary primers. *Nucleic Acids Research* **18**: 7213–7218.
- Wenink, P.W., Baker, A.J. and Tilanus, M.G.J.** 1993. Hypervariable–control–region sequences reveal global population structuring in a long–distance migrant shorebird, the

- Dunlin (*Calidris alpina*). *Proceedings of the National Academy of Sciences, USA* **90**: 94–98.
- White, M.J.D. 1978. *Modes of Speciation*. W.H. Freeman, San Francisco.
- White, P.S. and Densmore L.D., III 1992. Mitochondrial DNA isolation. In: Hoelzel, A.R. (ed.), *Molecular Genetic Analysis of Populations*. 29–58. Oxford University Press, Oxford.
- Whitemore, D.H., Thai, T.H. and Craft, C.M. 1992. Gene amplification permits minimally invasive analysis of fish mitochondrial DNA. *Transactions of the American Fisheries Society* **121**: 170–177.
- Williams, E.E. 1976. West Indian anoles: a taxonomic and evolutionary summary. I. Introduction and a species list. *Brevoria Museum of Comparative Zoology* **440**: 1–21.
- Williams, J.K.G., Kubelik, A.R., Livak, K.J., Rafalski, J.A. and Tingey, S.V. 1990. DNA polymorphisms amplified by arbitrary primers are useful as genetic markers. *Nucleic Acids Research* **18**: 6531–6535.
- Wilson, A.C., Cann, R.L., Carr, S.M., George, M. Gyllenstein, U.B., Helm-Bychowski, K.M., Higuchi, R.G., Palumbi, S.R., Prager, E.M., Sage, R.D. and Stoneking, M. 1985. Mitochondrial DNA and two perspectives in evolutionary genetics. *Biological Journal of the Linnean Society* **26**: 375–400.
- Wolfe, K.H., Li, W.S. and Sharp, P.M. 1987. Rates of nucleotide substitution vary greatly among plant mitochondrial, chloroplast and nuclear DNAs. *Proceedings of the National Academy of Sciences, USA* **84**: 9054–9058.
- Wright, S. 1951. The genetical structure of populations. *Annals of Eugenics* **15**: 323–354.
- Wright, S. 1978. *Evolution and the Genetics of Populations*. Vol. 4. *Variability within and among natural populations*. University of Chicago Press, Chicago.
- Wu, C.-I. 1991. Inferences of species phylogeny in relation to segregation of ancient polymorphism. *Genetics* **127**: 429–435.
- Yang, S.Y., Soulé, M. and Gorman, G.C. 1974. *Anolis* lizards of the eastern Caribbean: a case study in evolution. I. Genetic relationships, phylogeny, and colonization sequence of the *Roquet* group. *Systematic Zoology* **23**: 387–399.
- Zeven, A.C. and De Wet J.M.J. (eds) 1982. *Dictionary of Cultivated Plants and their Regions of Diversity. Excluding most ornamentals, forest trees and lower plants*, 2nd edn. PUDOC, Wageningen.

2.3 Biodiversity from an ecological perspective

2.3.1 Introduction

Species of plants, animals, fungi and microorganisms are not distributed uniformly over the surface of the world but form spatial patterns of various sorts. There are three groups of reasons for this: they may occur together or apart for (1) historical reasons, (2) causal reasons and (3) functional reasons.

The historical reasons are studied mainly in historical biogeography, which is concerned with listing the effects on distribution patterns of events that happened in the past. For example, after the tectonic break up of Pangaea, many

species were unable to cross the newly originating oceans. Because of their isolation, they evolved independently on either side, enhancing the total diversity of life. The same happened when mountain ranges were thrown up, or at much finer scales of space and time when lakes, deserts, forests, glaciers, or water currents temporarily partitioned the surface of the Earth.

Temperatures, precipitation and soil conditions, for example, are not evenly distributed over space, but form intricate, ever-changing patterns. The species, responding specifically to these factors, follow the changes, and find themselves grouped together with other species preferring the same conditions and separated from those adapted to different ecological factors. Thus, Arctic and boreal species are adapted to low temperatures and often high humidities, being unable to live in Mediterranean or tropical conditions. This also holds for finer levels of adaptation, causing them to live only in certain parts of the tundra region. When climatic conditions change, they shift their distribution in order to follow the change and often increase or decrease their range of distribution, becoming either more cosmopolitan or rarer.

When species live together in a certain area, they may interact to various degrees, thus forming communities in which different species fulfil different roles within the community process. Thus, there are primary producers, producing organic materials from nutrients in the soil and the atmosphere with the help of light. Herbivores as secondary producers live on the primary ones, bacteria and plants, and are eaten by tertiary producers, i.e. predators, parasites and disease organisms. At different levels, saprophytes and their zoological counterparts enter the system to consume dead material.

Complicated patterns of species clumping may originate from the operation and interaction of these three types of factors: historical, causal and functional. Sometimes only few species are found occurring together within a certain area, whereas in other areas many are found. Thus the diversity of life, or biodiversity, is heterogeneously distributed. This chapter structures and characterizes biodiversity from an ecological perspective under two main headings – the diversity within areas of the spatial patterns, and the diversity between areas.

2.3.2 Diversity within areas

2.3.2.1 Species richness and species diversity

The central single measure of ecological diversity is species richness or α -diversity (see Box 2.3-1): we count the number of species using only their presence (and not abundance) in a given area. Ecologists from northern countries often talk with admiration of the diversity of tropical rain forests or coral reefs. The unusual richness of many tropical areas can be quantified simply by some measure of within-area species richness. Colombia and

Box 2.3-1: Definition of alpha (α), beta (β) and gamma (γ) diversity.

The division of diversity into alpha (α), beta (β) and gamma (γ) components, to characterize diversity on different scales, was first proposed by Whittaker (1960, 1972). Alpha diversity and gamma diversity pertain to the number of taxa at local and regional spatial scales respectively, and their units are number of species or other suitable measures of diversity. They are thus inventory diversities, following Whittaker (1977). Beta diversity measures the turnover of species between local areas and is usually treated as a dimensionless constant, or differentiation diversity (Whittaker 1977; see Section 3.3.2.2.3). Distinguishing these components of diversity goes hand in hand with quantifying the local distribution of species, similarity among local assemblages, and rate of change in species composition with respect to distance or ecological condition.

Alpha (α) diversity is within-area diversity, measured as the number of species occurring within an area of a given size (Huston 1994). It therefore measures the richness of a potentially interactive assemblage of species.

Gamma (γ) diversity is also a measure of within-area diversity; however, it usually refers to overall diversity within a large region (Cornell 1985a) and its comprehension has direct connotations with dealing with biodiversity at the landscape level (Noss 1983; Franklin 1993). Gamma diversity has no upper limit but most often it refers to a whole region or country, rarely to a continent. Regional species lists, often the only information available, can only be treated as lower bounds on gamma diversity. Cody (1986, 1993) has used gamma diversity as the turnover of species between different localities within the same habitat type, as with distance between sampling areas. This corresponds to beta diversity in more common usage. As yet, definitions of alpha and gamma diversity have not been settled (e.g. Latham and Ricklefs 1993) and, owing to the continuousness of ecological scale and to the different sizes and spatial distributions of different organisms, this probably is not even feasible.

Beta (β) diversity was introduced by Whittaker (1960) to designate the degree of species change along a given habitat or physiographic gradient. As such it is a measure of *between-area diversity*. It cannot be expressed in numbers of species because it is a rate or proportion: it is normally represented in terms of the similarity index or of a species turnover rate.

The simplest definition of beta diversity is the ratio of the gamma diversity of a region to the average alpha diversity of local areas within the region, hence:

$$\text{beta [dimensionless]} = \text{gamma [taxa]} / \text{alpha [taxa]}$$

Other measures of beta diversity have been proposed, and each of these responds in different ways to sample size (Wilson and Shmida 1984; Magurran 1988; Harrison *et al.* 1992); some of them require additional information (Cody 1986; Schluter and Ricklefs 1993).

Two aspects of beta measures should be considered before they are applied to field data. First, although originally intended to measure the rate of species turnover along a continuous gradient (Wilson and Shmida 1984; Cody 1986), beta diversity is generally used to estimate average changes in species among discrete sites or habitat units. In this case, beta is not really a rate measure, but instead more a measure of average sample, or community dissimilarity.

Second, interpretation of beta diversity depends on whether it is used to compare ecologically similar or distinct kinds of sites. When used to compare similar sites, possibly of different sizes, it measures the proportion of species from a wider environment actually occurring in a sample site: it may thus be used to indicate the area needed to include a certain fraction of diversity in that environment, or the effect of adding sites to a protected area. In the latter case, the beta component of diversity measures community response to habitat heterogeneity.

Kenya, for example, are home to over 1000 species of birds, while Britain and the deciduous forests of eastern North America are home to only about 200. A coral reef off northern Australia may be home to 500 species of fish, while the rocky shoreline of Japan may be home to only 100 species. These simple 'species per country' statistics are useful, but they fail to capture the full measure of biodiversity for several reasons.

First, for many groups of species, what we know for certain is only that we do not know many, perhaps even the majority, of the species present. Consequently, species richness can only be measured for some but not all the species in an area. Only in very few places on the planet are there rough estimates for the total number of species. Second, the size of the area will often be arbitrary. Species richness is related to area in a complicated way, so we must

exercise caution in comparing the diversities of areas that differ greatly in size. Third, there are issues involving the weighting of species richness according to the perceived value of the species.

Why is it, and how is it, that so little is known? Does it matter that so little is known? When good data are available for the distribution of richness, one can assess how well what we know about the diversity of one group (say butterflies) correlates with the diversity of another group (say birds). If the diversity of one group predicts the diversity of another, then a forest's diversity can be characterized from just its birds or plants, a reef's diversity from its corals, or a lake's diversity from its fish. Even within one group of species there is a choice of measures of within-area diversity.

2.3.2.1.1 Comparing diversity across species groups: coherence of patterns. How do the patterns of species richness in one group of species correlate with those in another? If the answer was always to be 'very closely', then ignorance of the species in some taxonomic groups might be less critical, for we would expect that these groups too would follow the same pattern. Certainly, there are some broad correlations across the groups we do know, reassuring us that the gaps in our knowledge might not critically alter the answers to some general questions. For instance, the tropics are generally richer than comparable temperate habitats. Tropical Lake Malawi has 245 species of fish, while Lake Windermere (England) has only nine (Barbour and Brown 1974). Indonesia ranks second, first, sixth and eighth in the number of species of endemic mammals, birds, reptiles and amphibians, respectively (World Conservation Monitoring Centre 1992). In contrast, Britain has few or no endemic species in any of these four groups. Simply, the richness of the tropics is well established for many different terrestrial groups. Tropical seas likewise hold high numbers of gastropod and bivalve mollusc species.

There are enough exceptions for us to be cautious about all specific patterns. Oceanic islands may have unique and diverse birds and plants but have very few mammals. (The obvious reason is that birds and plants can reach there more easily.)

When we have excellent data, such as the mapped distributions of many plant and animal groups in Britain, we can formalize this analysis. Prendergast *et al.* (1993) asked if the locations in Britain that are rich in flowering plants, liverworts, birds or mammals, were also rich in *all* of them. They are not. Areas rich in liverworts are not rich areas in birds, and vice versa. Areas rich in butterflies are different again. At a continental scale, Schall and Pianka (1978) compared the numbers of species of frogs, lizards, turtles, snakes, birds and mammals found in 1° latitude \times 1° longitude blocks in North America and Australia. In Australia, areas rich in frogs were also areas rich in

everything else, except for lizards. In North America, areas rich in frogs were also rich in turtles and snakes, but were poor areas for birds and mammals.

These complicated patterns emphasize that there can be no short cuts to understanding the patterns of diversity. Areas rich in one group of species need not be rich (and indeed may be unusually poor) in another group. And even when there are correlations in richness on one continent, the correlation can be reversed on another.

2.3.2.1.2 Comparing areas of different sizes. Even when we restrict our characterization of diversity to one group of species, it is not always easy to make comparisons between different places. Plant ecologists often count the number of species in 0.1 ha, and many species mapping schemes are on 10 km squares, or $1^\circ \times 1^\circ$ latitude–longitude squares (c. 100 km squares). Microorganisms may be counted on scales of square centimetres. Simply, there is no internationally agreed spatial scale over which we measure richness. It varies from one group of species to another. Even for well-known groups of species, species richness is often reported by country and countries differ very greatly in size. So how do we compare our species counts when they are undertaken at such different spatial scales?

The detection of diversity is clearly scale-dependent. Sampling over progressively larger areas will lengthen species lists: as a progressively larger area is sampled the increase in the number of individuals and habitats sampled leads to more species being recorded. However, the number of species does not increase with area in a simple way. Per unit area, Ecuador has more species of land birds (1435 species in 300 000 km²) than Canada (426 species in 10⁷ km²). Both these values are much less than 1 species per km². A hypothetical island off the coast of Canada would certainly be home to several species of birds and so more species per unit area: however, no-one would think the island intrinsically richer than Ecuador. Simply, our basic measure of diversity – richness per unit area – is not a good way of comparing areas of widely different sizes. That measure is too strongly influenced by the size of the area.

Ecologists have long known that the relationship between the number of species (S) and the size of an area (A) is often quite well described by $S = cA^z$, where $z = 1/4$ and where c depends on the group of species we choose (MacArthur and Wilson 1967). Roughly, an area 16 times as large as another one should hold twice as many species.

Ecologists know that the value of the parameter z is not always $1/4$ – it varies between 0.15 and 0.8. For example, the values of z are generally higher for real islands than for sampling areas (islands) of the same size within larger regions of similar habitat (McGuinness 1984). None the less, the simple rescaling of area using the $1/4$ power of area can often be a useful 'rule of thumb' in comparing the diversity of different countries. Ecuador's greater number of bird species compared with Canada does not properly

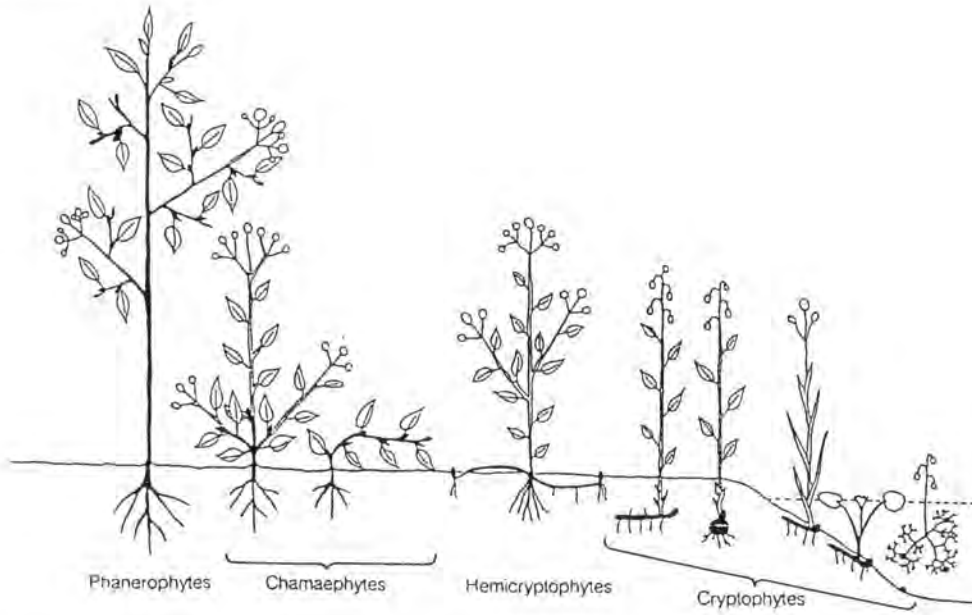

Figure 2.3-1: Raunkiaer's plant life-form spectra (from Archibold 1995).

capture the difference in diversity, as Canada is so much larger. And richness per unit area favours small areas. Species per (area)^{1/4} is rather cumbersome, but it does provide a rough means of comparison. Thus, relative to what we expect from their areas, Ecuador (61 species per (area)^{1/4}) is approximately eight times richer than Canada (7.5 species per (area)^{1/4}).

2.3.2.1.3 The relative abundance of species. One of the most striking features of ecological communities is that species vary in their abundance. For example, a few species may be extremely common, a slightly larger proportion fairly common, with the rest (the majority) occurring only infrequently. It is conventionally assumed that the diversity of a community rises (even if the species richness does not change) as the abundances of the species become more equal. Thus, if there are two hypothetical communities each containing four species and 100 individuals, community A (with each species having 25 individuals) will be deemed to be more diverse than community B (where the four species have very different abundances of 97, 1, 1 and 1 individuals). The evenness (or equitability) of a community is a measure of how equal the species abundances are.

A number of measures, such as the well-known Shannon (Shannon and Weaver 1949) and Simpson (Simpson 1949) indices, take account of the relative abundances of species. However, this type of 'combination' index can be difficult to interpret. In addition, many of these indices make assumptions about sampling that may be difficult to meet. For these reasons ecologists often prefer to report the measurements of the two components separately. Such an approach can be very powerful since parallel information on species richness and evenness can provide important insights into the ecological changes that occur over time

(such as those following eutrophication or deforestation) or the differences between ecological communities (such as tropical and temperate forests).

Data on the abundances of species can be time-consuming or impractical to collect. For this reason these diversity measures tend to be useful in only a relatively small number of well-studied areas. Magurran (1988) provides a book-length review of diversity indices and the relative weightings of the components of species richness and evenness they provide. Any diversity measure (such as the evenness measures) that de-emphasizes species richness implies that rare species are less valuable than others.

2.3.2.2 Taxic diversity

A limitation with species richness and species diversity measures is that they treat all species equally. It may sometimes be useful or interesting biologically to explore other perspectives in which species make rather different contributions: *taxic diversity* (this section) and *functional diversity* (2.3.2.3, below) are two of these.

The taxic diversity of an area is a measure of the taxonomic dispersion of the species, and the three main concepts are discussed in the previous Chapter (2.1). The simplest measure, *taxic richness*, is like species richness, but counts the higher taxa represented in an area, such as the number of families or phyla. It is on this basis that most coastal systems are markedly richer than the adjacent land area: they contain many more phyla. A traditional measure is to value highly *monotypic taxa*: the ginkgo (*Ginkgo biloba*), the coelacanth (*Latimeria chalumnae*) or the tuatara (*Sphenodon*) are thus valued highly because of their taxonomic or evolutionary isolation (IUCN 1980). A

species in a monotypic order is more isolated on the taxonomic or phylogenetic tree than a monotypic family; this more isolated than a monotypic genus, and so on. Lastly, a recent development has been *phylogenetic diversity* measures which provide a diversity measure of the biota in an area adjusted for the pattern of phylogenetic isolation of the components.

It can be agreed that these measures reflect an evolutionary rather than an ecological perspective. They do, however, approximate to measures of feature richness of importance in valuing areas for conservation (McNeely *et al.* 1990; Faith 1992). The first applications have led to important ideas on conserving complementary rather than overlapping floras and faunas (Faith 1992).

2.3.2.3 Functional diversity

This section discusses two aspects of ecological functionality. The first is concerned with the functioning of species properties for the well-being of the species itself, and is called *autecological diversity*. It treats the species in isolation, that is independently of other species with which it lives. The second aspect of ecological functionality concentrates on the interrelation of species living together. Thus, it concentrates on the different functions a species fulfils relative to other species within a community. In this way, the functions vary between species as well, also adding to the total biodiversity of a region. This aspect of biodiversity can be called *synecological species diversity*, being concerned with the interactions of species living together within communities.

One view of biodiversity in the ecological sense is, therefore, not concerned so much with the species themselves as with their autecological or synecological properties. A reduction in ecological biodiversity involves a loss of types of adaptation, or whole suites of similar adaptive traits. This loss is of a different nature and potentially far more damaging ecologically than a mere reduction in the number of species present.

2.3.2.3.1 Autecological diversity (species in isolation). Each species is unique as regards its present properties, as well as in its often long and complicated evolutionary origin. In a sense, we simply cannot compare them because of their uniqueness; quite literally, we cannot compare apples and pears, nor subtract or multiply them. Biodiversity, emphasizing these differences, is particularly concerned with this biological information, and the measures we use should express it.

An obvious way to treat the variation in one or more traits among species is to arrange species according to the various values or intensities they have relative to a particular trait. Thus, concerning their spreading capacity, they can be arranged from purely sedentary species to those that migrate annually between the two poles, as does the sandwich tern, for example. Then, the numbers of species

falling into various categories along this scale of spreading capacities can be counted. The resulting frequency distribution reflects the profile in this feature, and can be called a *diversity spectrum* (Hengeveld, unpublished data). A reduction in this particular aspect of biodiversity may reflect either a random falling away of species over the whole range of variation of the trait, or a systematic alteration of the spectrum.

Diversity spectra can be constructed for all species on Earth, or locally for those within a particular area. The latter procedure is the more informative, as it can be used to show a loss of adaptive types, but also to track where this loss occurs. Counter-measures should be taken locally as well so as to be most effective in preserving biodiversity.

Diversity spectra can be constructed for many traits, relating either to environmental factors or to the species' demography. Life history statistics come into this category. In botany, they were often known as life forms and the resulting frequency distributions as life form-spectra (Raunkiaer 1934; Fig. 2.3-1). Thus, according to Raunkiaer (1934), the floras of different parts of the world contain species the individuals of which bridge unfavourable periods either in the soil, with their buds just above it, or carrying them high above the soil surface, etc. Locally, the various types occur in certain proportions, together forming a local spectrum. The spectrum could be truncated, for example, by varying the water table affecting particularly those species hibernating as bulbs, or by increasing the turnover of cut forests, affecting the proportion of species with buds high above the ground.

Demographic spectra are known as age distributions, or distance distributions (dispersal kernels), for example. Frequent cropping affects the age distribution, keeping the local population young. This, in turn, affects the reproductive output of the population either positively or negatively. It can be positive when reproductive output is density dependent, the older established individuals with a lower fertility keeping their places. It can be negative, when, with the addition of the offspring of older individuals, the net reproductive rate can reach the minimum value of one for maintaining the population, whereas without it this rate is lower, causing the population to die out sooner or later. High turnover rates of some localities therefore affect different species with different age distributions differently and can thus upset or reduce the local diversity spectrum. This also holds for local dispersal capacities of species. Fragmentation of the environment can leave unaffected the sedentary species for which the remaining fragments are large enough. Very mobile species can also survive as they can still move between the various fragments remaining. However, species with intermediate dispersal capacities may die out as the individual fragments are too small for them to maintain a viable population but covering the

distances between them is impossible. The diversity spectrum splits up into two in this case, implying a loss in biodiversity as such, on top of the loss of a mere number of species.

2.3.2.3.2 *Synecological diversity (species in communities)*. This section discusses the consequences for our concept of biodiversity of the functional living together of sets of species. To this end, however, some other concepts have to be defined and discussed first.

Species can live together without having any interrelationships in groups called *assemblages*. These are therefore aggregations of species that are ecologically independent. When, however, species living together at some locality do relate to each other ecologically, and are interdependent to some degree, we call it a *community*. A community, therefore, is a local set of functionally interdependent species. When, moreover, we also include physical factors and processes in our considerations, the unit is called an *ecosystem* (Tansley 1935). Tansley proposed the term ecosystem to refer to the plants, animals, microorganisms and physical environment at any given place and the complex relationships linking them into a functional system. All units are defined irrespective of the spatial scale of variation with the result that they can be arranged in a hierarchically or nested order. Thus, ponds as individual ecosystems can be connected by streams into a system comprising a large catchment area. This large area therefore is considered a spatially broad-scale ecosystem. This also applies to communities. Assemblages are similarly defined without reference to particular spatial scales, but these cannot meaningfully be defined in a hierarchical or nested order.

Internally, communities can be structured according to the functions of species. First, each species occupies what is called an ecological niche, which may be depicted in terms of the range of ecological conditions that the species occupies and its functional position within the community (Colwell 1992; Griesemer 1992). Niche space is complex and multidimensional (Hutchinson 1959), and in practice it has been characterized in terms of ranges of such variables as temperature, moisture, light, salinity, acidity, depth; position within the physical structure of the habitat (resting substrate, feeding location); diurnal versus nocturnal activity; defences against enemies (adaptations for escape, hiding, or crypsis); attributes of food items and feeding substrates (size, noxious chemicals, taxonomic group); feeding behaviour (ambush, search, filter, etc.); and many other factors. Niches that are characterized irrespective of the species' functional role in the community remain unweighted.

When several species have similar niches, and also similar functions, they form functional categories called *guilds* (Root 1967; Jaksic 1981). Guilds may reflect discrete groupings (Jaksic and Medel 1990) or arbitrary but

useful subdivisions of a continuum (Simberloff and Dayan 1991). An approach that has proved successful in animal communities is to calculate the variation among taxa in morphological measurements related to functional aspects such as feeding, predator escape, and other attributes of the niche space (Karr and James 1975). Statistical methods for treating such data involve multivariate analyses, ordination, canonical correlation and discriminant analysis (Gaugh 1982; Miles and Ricklefs 1984; ter Braak 1986). Such analyses permit rapid comparisons of ecological variety among assemblages, such as for the bird faunas of island archipelagos and continental areas, but they are limited to taxa with comparable structures (that is, birds and ants cannot be included in the same analysis even though they may consume some of the same resources).

Communities can also be characterized by means of specific connections between species. One of the simplest functional characterizations is based on how organisms obtain their nutrition. Organisms that obtain their food by the same number of steps from plants are said to belong to the same *trophic level*. By using the feeding relationships of organisms the community can be broken down into a few easily recognizable groups, such as producers, decomposers, herbivores and carnivores.

The flow of energy from plants through herbivores to carnivores is termed the *food chain*. Food chains are not independent but interlinked to form *food webs* (Pimm 1982) which can be quantified by the number of trophic levels, number of links (that is, predator and prey species) per taxon, and so on (Cohen *et al.* 1990; Polis 1991; Martinez 1992; Hall and Raffaelli 1993). Paine (1992) has additionally developed an experimental approach that defines functional food webs by measuring the strength of interactions between populations.

At each transition, from one level to the next, energy and nutrients are lost. This often results in a decreasing number of species from the base towards the top, producing a characteristic trophic pyramid (Elton 1927). The structure of the trophic pyramid relates directly to the functioning and organization of a community, and changes in ecosystem function due to, for example, nutrient enrichment (Palmer *et al.* 1992) or pollution can be detected in changes in the trophic structure. The structure of food webs can also provide indications of community organization and persistence. Some webs remain stable with the addition or removal of additional species whilst others become unstable and result in further losses (Pimm 1982).

Within a community a species may have a functional role that is critical to the stability and survival of the community. Such species are termed *keystone species* (Paine 1966). The loss of a keystone species will result in widespread changes in community structure and often result in further species loss. This concept is discussed fully in Section 5.2.3.

2.3.3 Diversity between areas

2.3.3.1 The general difficulties in classifying ecological communities

Each species has a unique distribution, which is the product of its ecological and evolutionary history. It follows that no two areas are identical, and that there is a potentially infinite variety of ecological associations. We can of course see strong patterns in communities, which often reflect important differences in environmental conditions, but the apparently straightforward task of classifying this variation proves to be extremely complex. In this section we consider some of the theoretical issues associated with attempting an ecological classification. Then we go on to take a pragmatic approach to how these problems may be overcome, in order to produce effective working classifications. The latter permit us to obtain some measure of ecological diversity between areas. These are the issues.

1. There is nothing equivalent to the species concept that can provide a fundamental criterion for defining ecological units. This simple but important conclusion has had profound implications for ecology. One of the false directions taken by some early ecologists was in regarding ecological associations as having some reality, rather than as abstractions that are useful for practical purposes. Thus, Clements (1916) regarded an association as a complex organism, and this type of thinking had a profound effect on development of ecology. The contrasting philosophy was that of Gleason (1926) who proposed the individualistic concept of the plant association, which basically relates the continuously variable environment to equally continuous variation in ecological communities. Most ecologists nowadays would regard this interpretation as more realistic.
2. It follows from (1) that there is no single form of classification which we can regard as natural and which provides the ideal towards which we aim. Classifications based on very different criteria (for example floristic species composition, faunal species composition, ecosystem properties, etc.) are all equally justifiable; we should not expect that classifications based on different criteria will correspond (Hengeveld 1990).
3. The boundaries drawn between ecological units are necessarily arbitrary. In some areas environmental uniformity leads to a uniformity in the structure and composition of naturally occurring communities. However, in other areas species composition will change, sometimes markedly along environmental gradients. Such areas of transition are termed ecotones, and the decision as to whether to regard them as a

distinct type of community or merely intermediates between distinct communities is entirely arbitrary.

4. The natural patterns of variation in species composition present serious problems of scale. The different units that we may define vary in spatial extent and no simple sampling scheme can capture all the variation. A coarse classification, one for example that recognizes a distinct unit of beech woodland in Europe, completely fails to capture the great richness of variation in ecological associations which occur within this type of community. A particular problem in attempting to inventory ecological diversity is presented by very small ecological units, which may be quite distinct and in no sense part of the matrix of communities in which they occur. Examples include ecological communities associated with isolated rocks, with springs, ponds, etc. These small units may have many unique species, but a large scale classification provides no indication of their possible presence.
5. A related problem of scale is that the data that can be used for classification at one scale may be unavailable or inappropriate at another scale. For example within a protected area of rain forest, it may be useful to classify the vegetation according to species composition. However, at a much larger scale, such classification would be impossible because the data needed could not be collected. Large-scale surveys would have to be based upon some other characteristic of the vegetation than species composition, for example structural (physiognomic) features of the vegetation. At a global scale we are often more interested in the structure and functioning of an ecological system than in its composition. Tropical rain forests in different continents differ almost completely in species composition, but it is useful to recognize these different communities of species as all belonging to the same type of ecosystem.

Faced with these theoretical and practical problems of classifying ecological communities, it is not surprising that there is no generally accepted form of ecological classification. Instead there is a bewildering range of different systems of classifying communities, some of which are widely used and some of which have been developed for just one purpose. As a broad generalization, diversity of ecological systems is usually assessed at one of two levels. For large-scale purposes, ecological classifications are based on the types of ecosystem, with main attention paid to structure and organization of the community rather than species composition. On a local or regional basis, such classifications are often replaced by classifications based on the species present. For practical purposes, both types are usually derived from information about the vegetation rather than the fauna.

(a)

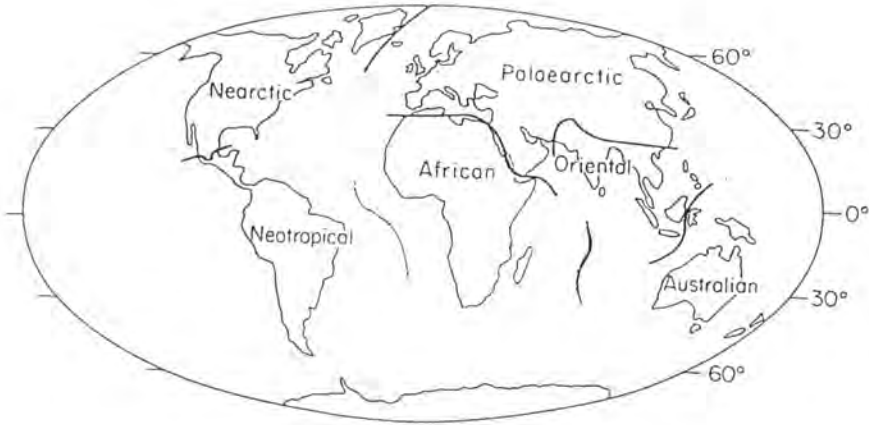

(b)

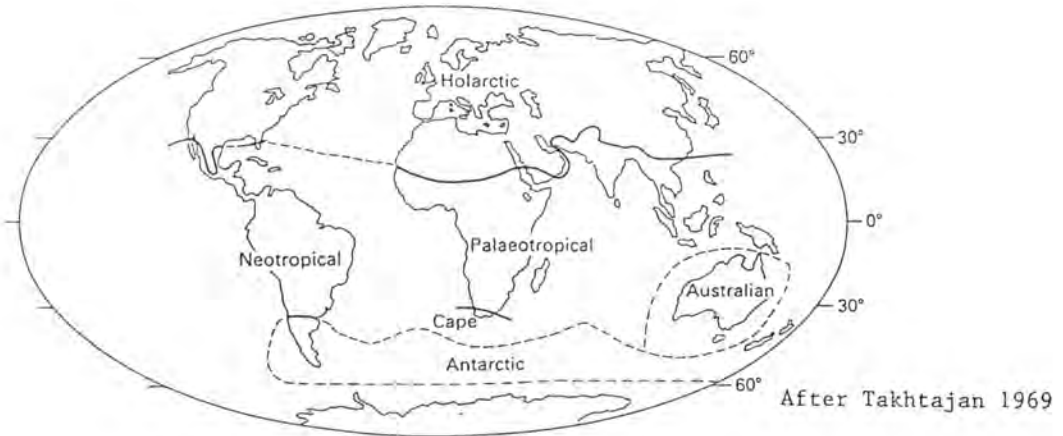

Figure 2.3-2: (a) Zoogeographic and (b) floristic regions of the world (from Cox and Moore 1993).

(a)



(b)



Figure 2.3-3: (a) Main faunal provinces of African freshwater fish (from Greenwood 1983), and (b) main phytochoria of Africa (from White 1983).

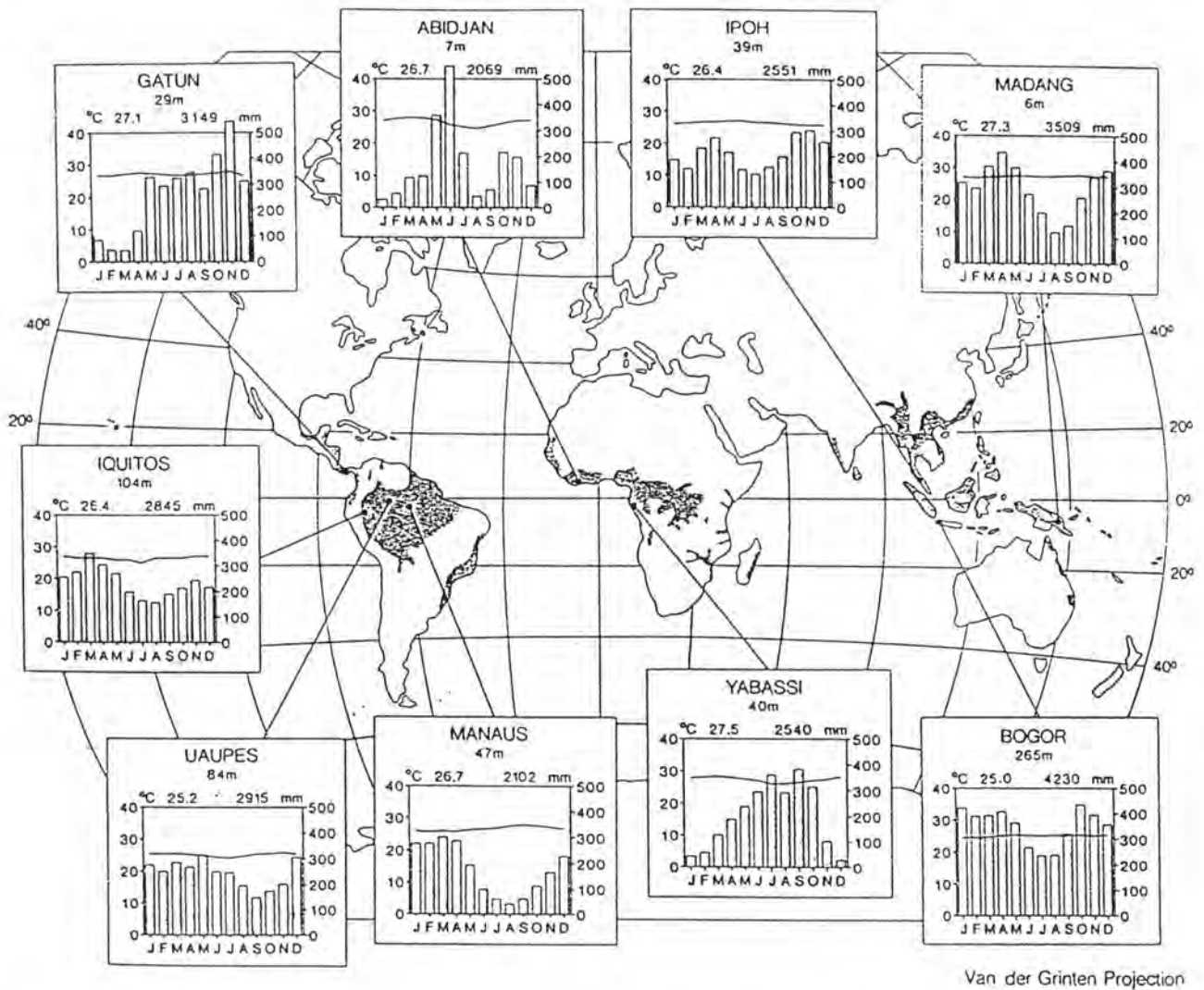

Van der Grinten Projection

Figure 2.3-4: Distribution of tropical forest and representative climatic conditions. Mean monthly temperatures are indicated by the line and mean precipitation for each month is shown by the bars (from Archibold 1995).

2.3.3.2 Classifications based on species composition

2.3.3.2.1 Phytosociology. The aim of phytosociology is a world-wide classification of plant communities, using the presence and abundance of plant species as a basis for classifying and characterizing vegetation.

On the European continent phytosociology has been extremely popular, and for many decades the approach dominated European plant ecology to the near exclusion of other approaches. The longest-established and best-known tradition in phytosociology is the so-called Zurich–Montpellier school (Grabherr and Kojima 1993). The method focuses on analysis and synthesis of floristic lists collected from relevés or stands which represent a sample of a type of vegetation. Herein lies one of the objections to this approach, since the selection on the relevé is not random, but based upon the observer's experience of the vegetation and judgement as to whether it is typical. Relevés are grouped and classified according to floristic similarities, based not only on dominant

species but also on the entire assemblage. A group of relevés which possess some species in common, and which are not found to occur in other groups, is considered to be one type of vegetation. The basic unit of classification is the association, and these are grouped into higher categories analogous to the taxonomic ranking of species into genera, families, orders and classes. Thus in the Zurich–Montpellier school of phytosociology associations are grouped into alliances, orders and classes.

Although there is nothing approaching a comprehensive global vegetation system based on floristic criteria, the phytosociological approach has been applied very widely, particularly in Europe. For some types of vegetation (for example mire and alpine steppe vegetation) there are fairly complete phytosociological descriptions of the vegetation, at least in the Northern Hemisphere.

Phytosociology has attracted a great deal of criticism, particularly from the Anglo-American school of ecology. The objections include the subjective selection of 'typical'

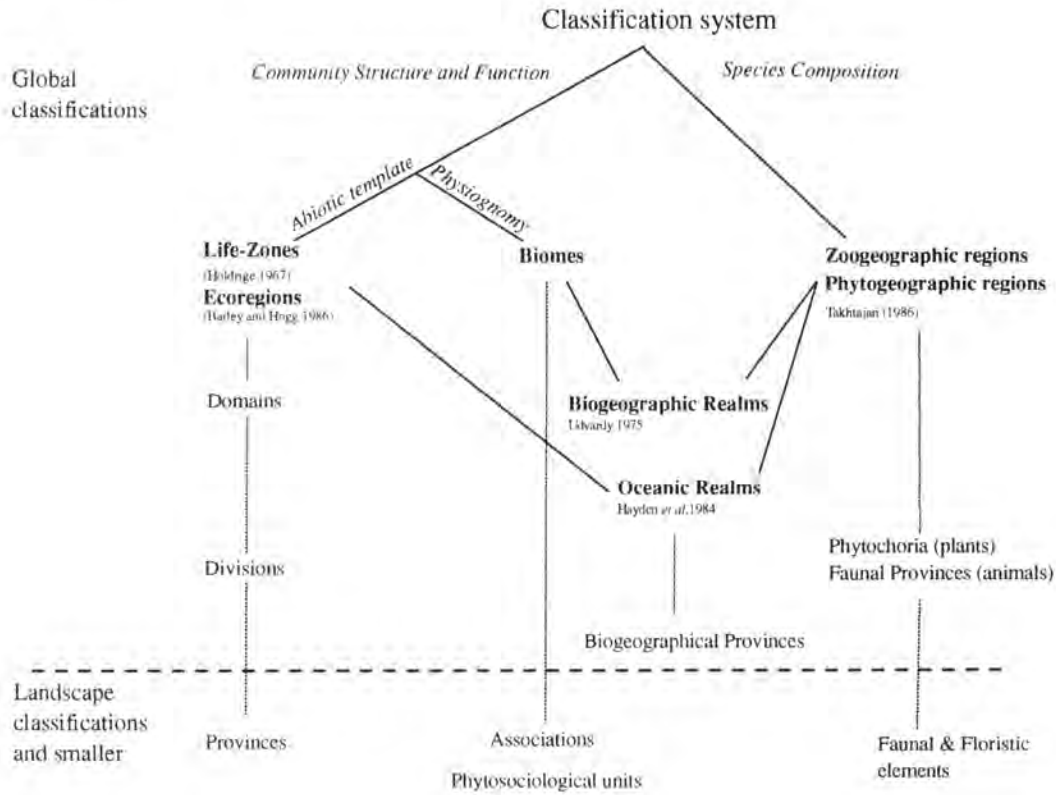

Figure 2.3-5: Global classification systems.

sites, the subjective identification of associations (though modern quantitative methods have reduced the force of this objection), and the arbitrary hierarchical classification of associations. However, despite these objections, phytosociology is practically useful. In those countries where it has been practised intensively there is a very full knowledge of the range of types of plant community and this information is increasingly important in conservation planning, resource management and monitoring of environmental change. Although based on floristic data, the classifications are also useful in predicting the distribution and richness of associated fauna.

Outside continental Europe, phytosociology has attracted less interest and as a result much less is known about the types of vegetation. For example, in Britain in the 1970s there was no comprehensive classification of British vegetation types which could be used as a basis for formulating conservation priorities. In this case, the solution was to commission a major survey known as the National Vegetation Classification (NVC) (Rodwell 1993). This was based on the phytosociological approach, but sought to avoid those aspects of the European tradition that were regarded as unsatisfactory. Thus although the NVC approach was based on systematic recording of floristic information from stands of vegetation, these were chosen solely on the basis of their relative homogeneity in composition and structure. No prior judgements were made

about the identity of the vegetation type; nor were sites selected because of the presence of species thought characteristic for one reason or another. The classification also employed reputable methods of statistical analysis, and in particular the classification technique known as TWINSPLAN.

2.3.3.2.2 *Global classifications of species distribution.* At a large scale, species information can be used to determine global patterns of diversity. For example, direct comparison of the species composition of the flora and fauna in different parts of the world can be used to identify distinct *biogeographic* areas (*phytogeographic* – flora, *zoogeographic* – fauna). These have traditionally been distinguished by high levels of endemism in their component species, with regions classified by the presence or absence of particular taxa. Recent techniques, however, tend to use characteristic combinations of taxa, and use statistical procedures such as cluster analysis and ordination techniques to compare the similarity/dissimilarity of the species composition of areas (Hengeveld 1990).

At the largest scale, *biogeographic regions* are identified (Figure 2.3-2). Boundaries between biogeographic regions or provinces are called *biogeographic lines*, the most famous of which is Wallace's Line between Southeast Asia and Australasia. In a classic study, Wallace (1879) noticed that the similarity of species in the Old World tropics was

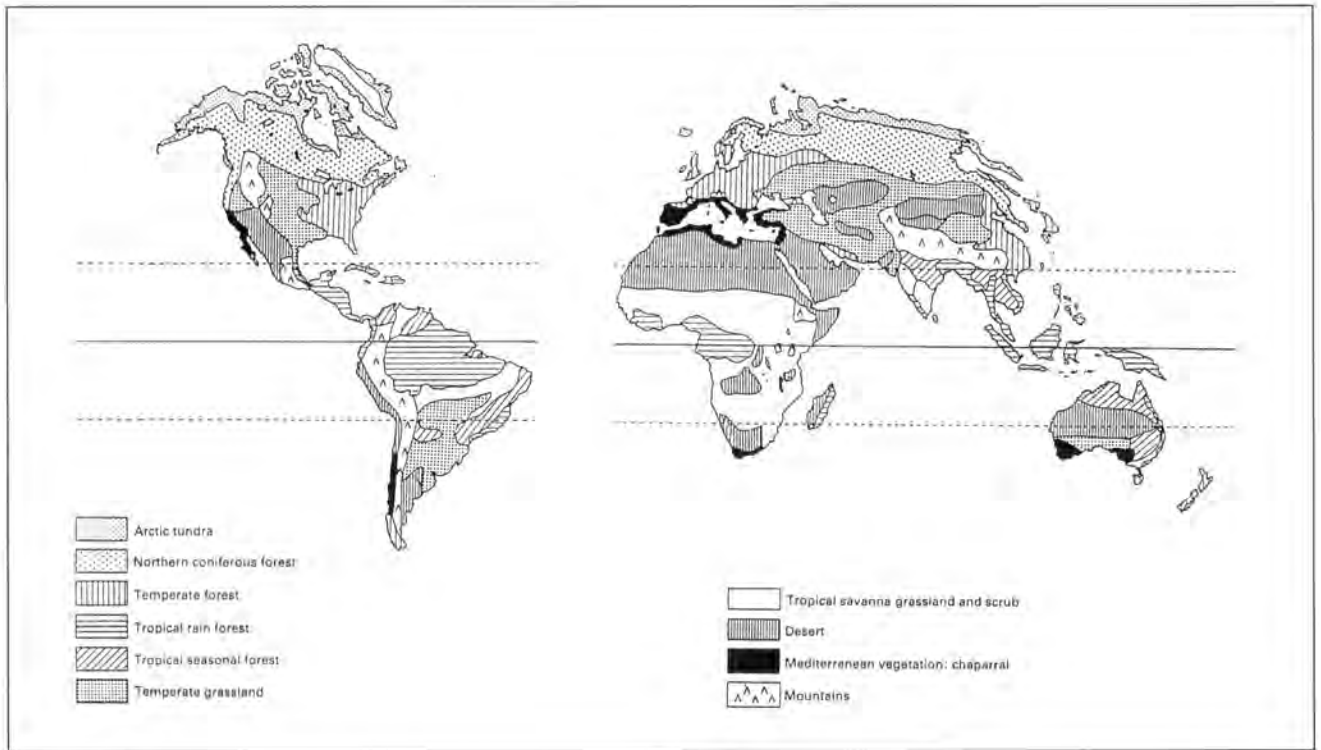

Figure 2.3-6: Distribution of the major terrestrial biomes of the world From (Cox and Moore 1993).

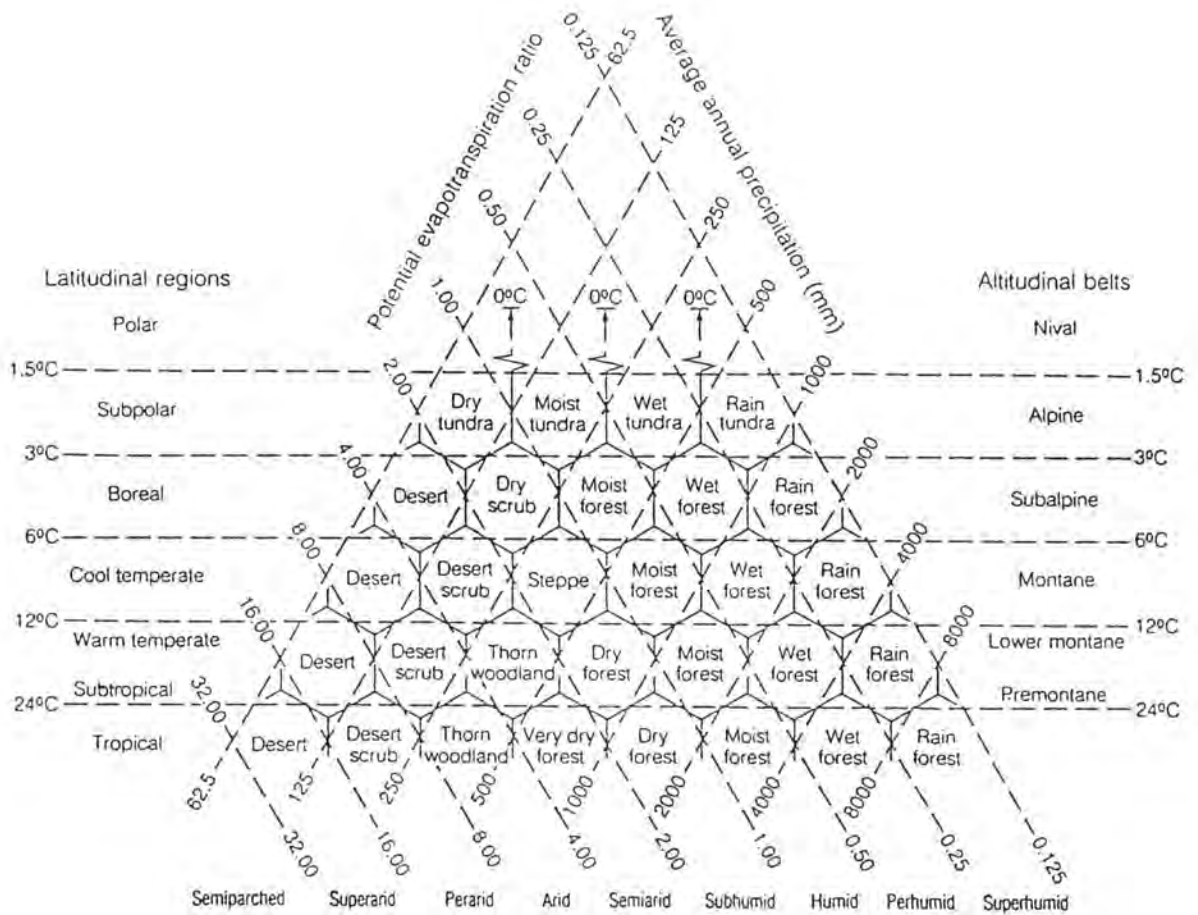

Figure 2.3-7: Holdridge's life zones (after Holdridge 1967).

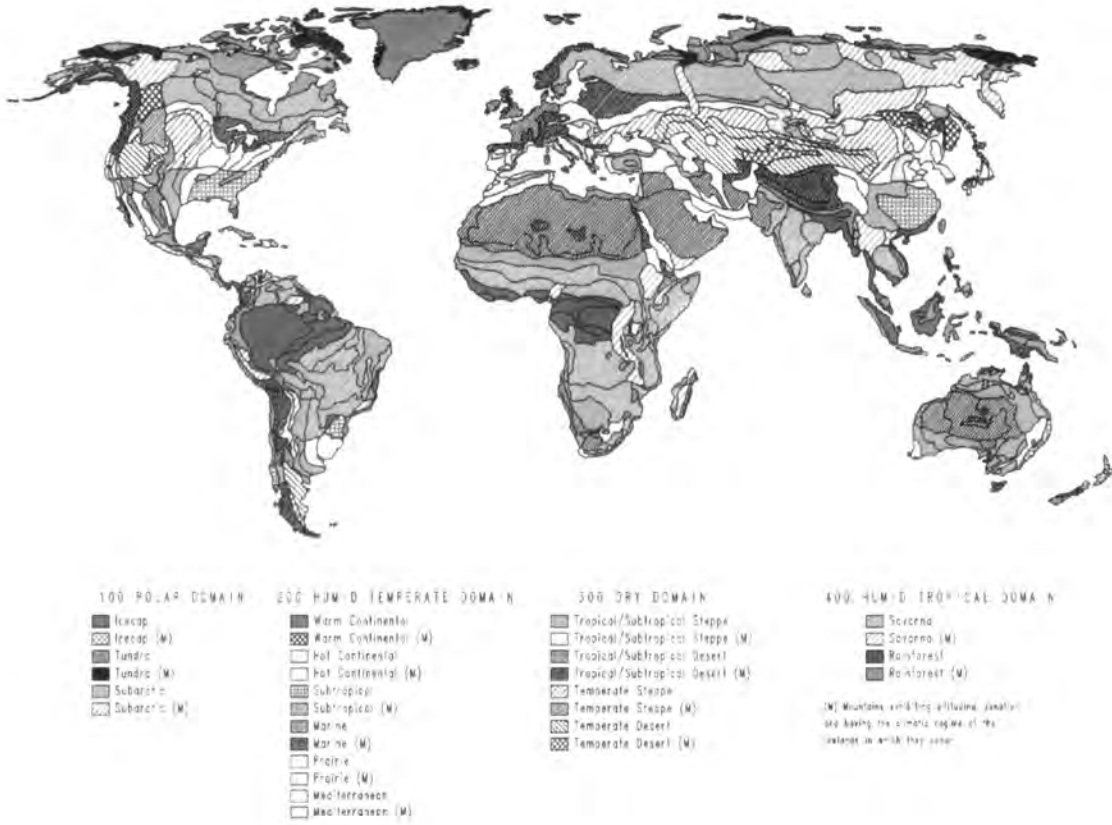

Figure 2.3-8: The world's ecoregions (after Bailey and Hogg 1986).

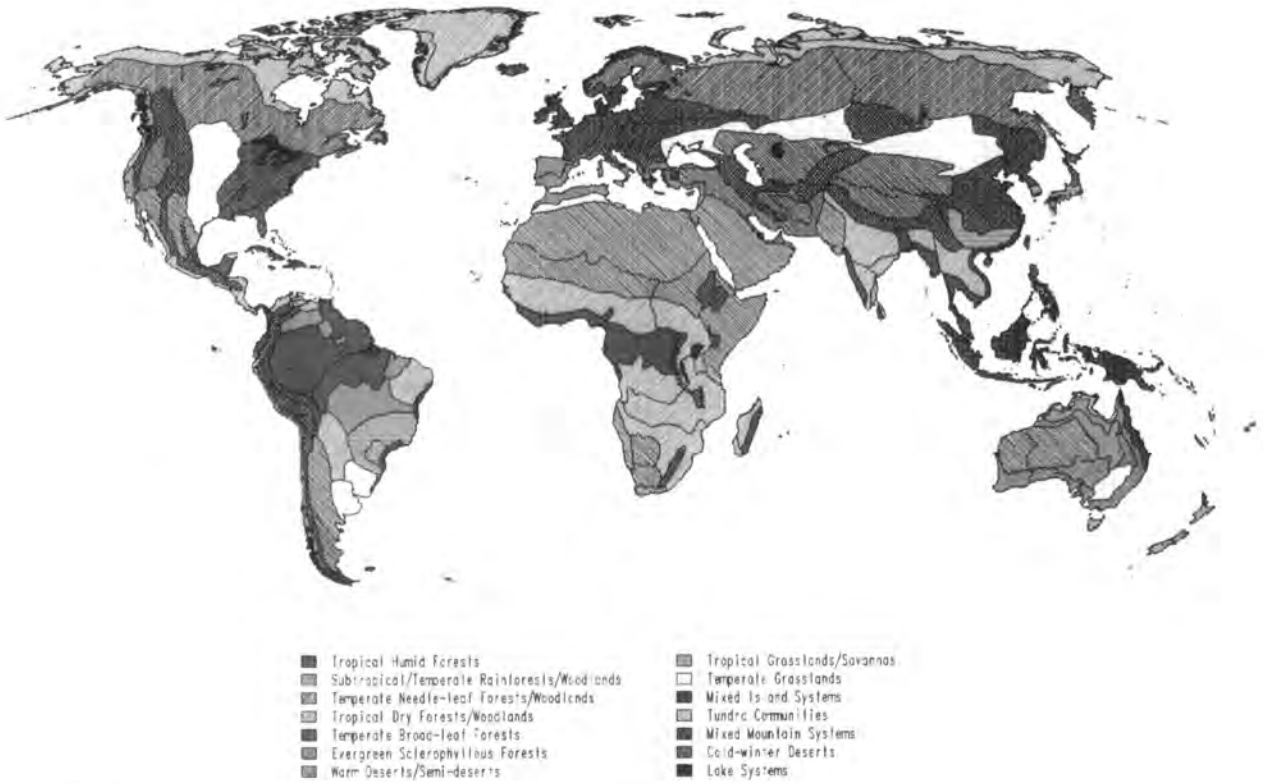

Figure 2.3-9: The world's biogeographic realms and provinces (after Udvardy 1975).

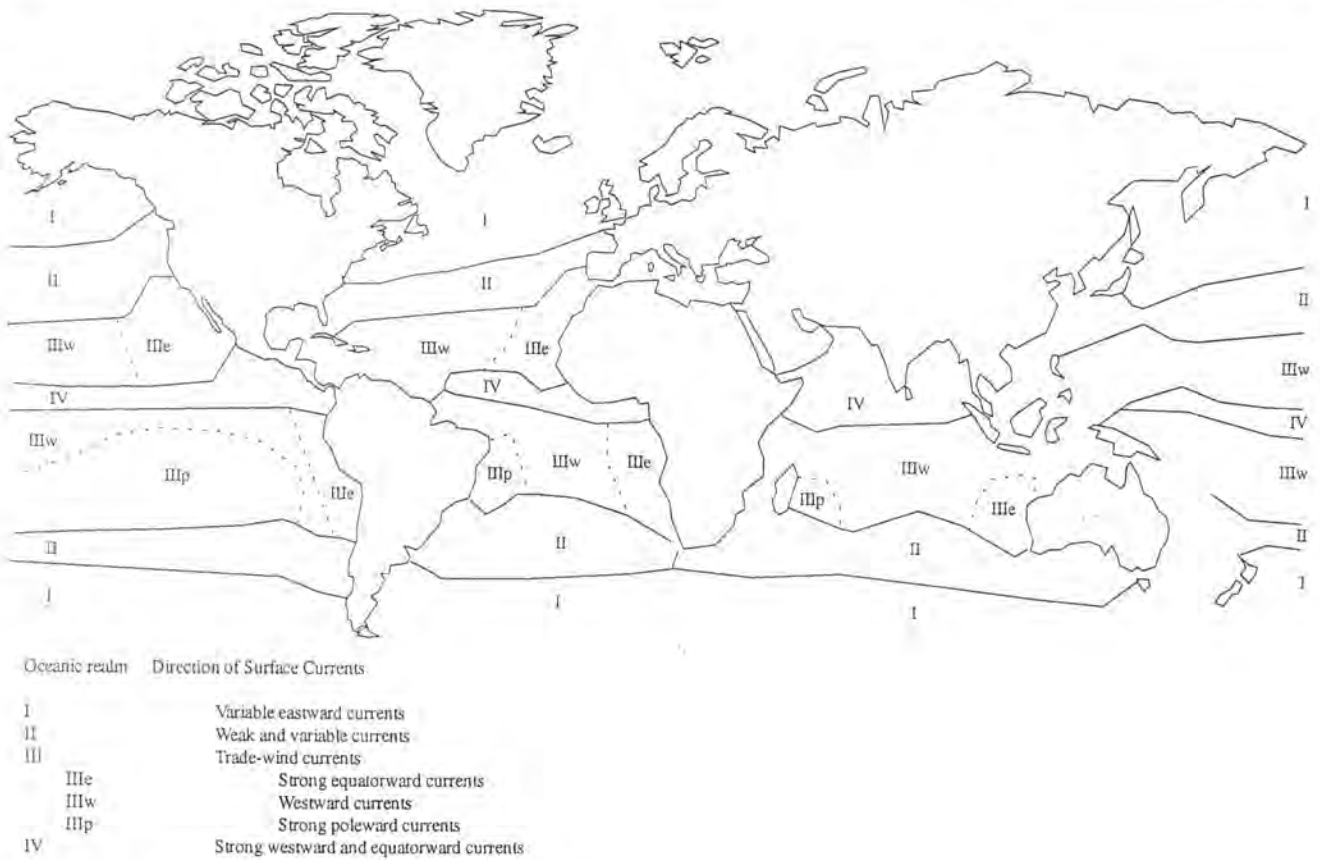

Figure 2.3-10: Oceanic realms (after Hayden *et al.* 1984).

high when comparing areas on one side of a hypothetical boundary but very low when comparing areas across that boundary. That boundary we now call Wallace's line and it divides species that evolved to the north (the Oriental Region) from those that evolved to the south (the Australian Region). Whatever its causes, Wallace's Line separates two very large regions by marking a boundary of high between-area diversity. Boundaries, however, are rarely as clear-cut as Wallace's Line, and often are vague and consist of broad transition zones, with component taxa declining gradually from their centre and merging into surrounding units. Furthermore, while the boundaries of the largest biogeographical regions tend to hold true for many groups, at the smaller, regional scale the boundaries are often taxon-specific: for example, the floristic regions of Africa differ from those of freshwater fish (Figure 2.3-3). Boundaries are also often dependent on the taxonomic level that is used: for example in a study of echinoderms around the Isthmus of Panama, the distribution of genera was found to be different from that of species (Raup and Crick 1979).

Zoogeographic regions have also been identified in the marine environment (Briggs 1974). However, the marine environment is more complex and dynamic than the terrestrial environment, and there are no universally agreed classification systems. The marine environment is three-

dimensional with distinct vertical zonation and endemism (Vinogradova 1962): for example, some genera and families are found only at oceanic depths over 3000 m. Within a particular ocean basin, the distributions of intertidal species, species of the upper layer of the open ocean, and deep sea species are very different (Norse 1993).

2.3.3.3 Global classifications of ecosystems

Ecosystems are essentially dimensionless, and the boundaries of the system in question can be defined according to the convenience of the researcher. Because the ecosystem approach to ecology is concerned with processes, such as the flow of nutrients and energy, much less emphasis is placed on species composition. We can recognize ecosystems that are physiognomically the same (that is in terms of their structure) and which function in much the same way, even though in terms of species they are different. Thus tropical rain forests in South America, Africa and Asia are clearly all the same type of ecosystem (Figure 2.3-4). Indeed, one of the great advantages of the ecosystem approach is that very different ecosystems, with totally different species compositions, can be compared.

At a large scale, variation in ecosystem structure is closely related to controlling environmental variables and particularly the climate. Approaches to ecosystem classification therefore use a wide range of parameters,

including aspects of the structure or physiognomy of the vegetation, as well as of climatic conditions (Figure 2.3-5). Because there is no need to identify particular species, it is also possible to make inferences about ecosystem type on the basis of remote sensing information. Indeed, it is increasingly recognized that the most versatile approach to ecosystem classification is to use satellite imagery for data on structure and phenology.

The link between vegetation and climate was recognized in the earliest attempts to classify world vegetation. De Candolle (1874) proposed that the distribution of the major plant formations was related to their drought and heat tolerances, and Koppen (1884) used annual and monthly rainfall and temperature to identify five major climatic zones which were intended to correspond to the major vegetation zones. These early approaches led to the development of more formalized classification techniques, which classify the terrestrial environment according to the structure and function of naturally occurring communities. The problem has been approached from two angles. The first has been to classify systems according to the physical structure of the dominant vegetation type, and such an approach is termed *physiognomy*. The alternative approach has been to use environmental variables to describe the *abiotic template* on which the distinctive communities are found.

The largest ecological unit recognized by physiognomy is the *biome* (flora and fauna) or *formation* (flora only), of which the tropical forests illustrated in Figure 2.2-4 are an example. Other biomes include the tundra, boreal forest and the savannah (Figure 2.3-6). Physiognomy is used predominantly in terrestrial systems. In freshwater and marine environments the vegetation has neither the structural diversity nor the regional uniformity to enable such classifications to be made.

Some more recent classification systems which describe the terrestrial abiotic environment have also been based on climatic variables. Holdridge (1947, 1967) devised a Life Zone Classification (Figure 2.3-7), which uses climatic variables to predict the naturally occurring climax community. This system has been incorporated recently into models of global change. A restriction of this system was that each locality was assigned only one unique ecosystem type. Box (1981) extended this system to a more complex concept related to species growth forms and the possibility of their coexistence. He found that using climatic data he could predict with a high degree of accuracy the mix of plant growth forms and the dominant types that would occur in a locality.

Climate, however, is only one component of the abiotic environment, and can be used only to predict the potential ecosystem type. While this may be of theoretical interest, there is an increasing need – for purposes such as climatic modelling and resource management – for classification

systems that take account of other factors such as soil conditions and land use. Such schemes tend to use a more or less elaborate combination of variables including habitat type, climate, land use, etc. For example, Bailey and Hogg (1986) incorporated aspects of the physical environment into a classification system to delimit a series of global ecoregions (Figure 2.3-8). This system uses a detailed bioclimatic classification and several features of the landscape, such as landform (soil type, drainage patterns) and altitude to describe a physical template on which similar communities would develop. By increasing the number of variables used to describe areas more detailed regional classifications can be constructed (Bailey 1989). The Bailey Classification includes four domains, further subdivided into 30 divisions and 96 provinces, and is intended to demarcate ecologically similar areas in order to predict the effects of management or global change. The EC CORINE Biotopes System is conceptually similar, but focused at present at the European level: it is founded on detailed data from a large number of sites.

Olson *et al.* (1983, 1985) developed a global ecosystem map based on data about pre-agricultural and potential vegetation, on contemporary land survey, and biomass data from research sites. They defined seven broad groups subdivided into a mosaic of 44 ecosystem units resolved at the level of a $0.5^\circ \times 0.5^\circ$ grid. Even at this relatively fine resolution, one grid cell at the Equator will include 3 000 km² (equivalent to a square of about 55 km \times 55 km), which will limit applications at the national level. One value of this particular system is the attempt to deal with transitional and disturbed systems. A primary reason for development of the Olson *et al.* data set was to enhance research into carbon storage and the global carbon cycle. The vegetation data were used by Prentice *et al.* (1992) as elements in their global biome model.

A system that combines the physiognomic and biogeographic approaches to the characterization of global biodiversity is the *Biogeographical Realms and Provinces* of Udvardy (1975). In this system the structure of the climax community is the first step in identifying a biogeographical province: however, the presence of distinctive flora and fauna is then used to delineate boundaries (Figure 2.3-9). The system covers terrestrial systems only, and divides these into eight biogeographical realms which are further divided into 193 provinces. The system has been widely used, by IUCN for example, as a basis for assessing the representativeness of global protected areas. A similar integrated approach has been adopted for marine environments (Hayden *et al.* 1984; Figure 2.3-10), combining the geophysical template based on variables such as salinity, surface currents and temperature (from Dietrich 1993), and the zoogeographic realms of Briggs (1974), to produce a global classification of the marine environment. Another system has described 49 large

marine ecosystems (LMEs) encompassing coastal areas from river basins and estuaries out to the continental shelf or the seaward margins of the coastal current systems (Sherman 1994). Ninety-five per cent of the annual biomass yields of fish and other marine resource are produced in these LMEs.

The characterization of global biodiversity patterns using environmental variables relies on the assumption that environmental uniformity will lead to uniformity in the structure and function of the community that develops. This is valid for naturally occurring climax vegetation (such as tropical forests; Figure 2.3-4), but the relevance of such classifications for animals is less clear. The most obvious examples of functional convergence amongst animals come from the Australian fauna, where the functional equivalents of eutherians can be identified amongst marsupials. Cody (1974, 1975) demonstrated that sets of insectivorous birds exploiting the Mediterranean vegetation of the Californian *chaparral*, Chilean *matorral* and South African *macchia* showed morphological convergence in their adaptations to apparently parallel niches. Such conformity in community structure has also been indicated in montane lizards in Chile and California (Fuentes 1976) and finches (Schluter 1986). However, other workers have failed to identify such fixity of community design (Lawton 1982), and the generality of the relationship amongst animal communities is open to question (Lawton *et al.* 1994; Putman 1994). Such systems are also less relevant in areas dominated by anthropogenic environments.

2.3.3.4 Characterizing and classifying landscapes

At a local or regional scale, more detailed ecological classifications are usually required than those provided by global systems. To some extent, the ecosystem units described above (2.3.3.3) can be broken down into smaller units to produce a hierarchical classification. For example, biomes are subdivided into associations, biogeographic realms into provinces, etc. This is achieved by the addition of new variables to the classification. For example, Klijn and Udo de Haes (1994) demonstrated how the use of additional environmental variables could increase the resolution of an ecosystem classification in the Netherlands.

At this regional scale (10–100 km) *landscapes* are identified. The increased detail required by landscape classifications means that there are no globally accepted terms or definitions, and one can provide only regional examples (Bailey 1981; Orians 1993; Klijn and Udo de Haes 1994). Opportunities for large-scale comparisons are therefore limited. In Britain, for example, four main classes of landscape are commonly recognised: *uplands*, *marginal uplands*, *pastoral* and *arable* (Stott *et al.* 1993). Within the 'upland' landscape division, the Countryside Survey has five lesser categories (managed grasslands, rough grasslands, heaths and bogs, broad-leaved woodlands and coniferous

woodland). Not surprisingly, an entirely different classification is needed in Mexico. Miranda and Hernandez (1963) recognize different zones, of which say *selva alta perennifolia* is a statement of the likelihood that the plant species found there will typically be found in many places in this zone and typically be different from those in other zones.

The functional importance of studying biodiversity at the level of the ecosystem or landscape is discussed in Sections 3.5 and 6.2.4.

2.3.3.5 Diversity in ecological systems

Although we have seen a wide diversity of approaches to classifying ecological systems, in each case the aim is to map every point in space in terms of a limited set of classes. However, another aspect of biodiversity is the *range* of ecological systems that occur within an area. For example, a landscape is usually a mosaic of different elements such as forest, agricultural land, wetland and so on. Once we have identified the basic types of ecological unit within a region, whether at the biome, landscape or habitat scale, we can make descriptive comparisons between different areas on the basis of the number of ecological systems they contain. For example a mountain range, due to the effects of altitudinal zonation, would contain a greater number of biomes than a tropical rain forest, although the number of species contained in the rain forest may be greater. To permit such comparisons accurate classifications of the systems are essential (Box 2.3-2).

Another important aspect of the diversity of the systems may be their spatial arrangement. For example, the way the various elements that make up a landscape are arranged in space is itself an aspect of diversity and may be important in determining which species can live in an area. Particular species may require patches of a certain habitat about a certain size, or they may require a particular mix of habitats. Thus the range and absolute areas of each habitat within an area provide an imperfect description of the ecological diversity. We may also need to consider various aspects of the arrangement of these habitats and the heterogeneity of the landscape they produce. These spatial aspects are difficult to describe, but is increasingly recognized that landscape analysis of this type is important in understanding species diversity.

2.3.3.6 The importance of better ecological classifications

This brief review of approaches to describing ecological diversity has done little more than illustrate the diversity of approaches and the complexity of the issues. There can be no single classification of ecological systems, since they are highly multivariate. The diversity of approaches reflects both the different objectives of different classifications, and also theoretical differences about the nature and organization of ecosystems. There are strong tensions

Box 2.3-2: Comparing the diversity of systems – classification prior to comparison.

The analytical procedures developed for the Countryside Survey of Great Britain (Barr *et al.* 1993) have been developed into a formalized procedure using the principle of classification prior to comparison.

Biodiversity is compared only between classes of vegetation that are relatively homogenous, in order that changes in species number and composition are not confounded by comparing vegetation classes that are inherently different. For example, a significant reduction in species number could be recorded in systems of low diversity such as cropland due to the loss of only one or two species. By contrast, a loss of far more species could occur in a high-diversity system such as unimproved grassland before a significant reduction was detected.

It is therefore necessary in observing ecological change to consider the inherent within-area diversity of the systems. Whilst in an ideal situation these classes would be determined by objective procedures, usually these will be determined by expert judgement.

When considering the three main levels of vegetational classification (biomes, landscapes, associations) it is fundamental that collections of associations combine to form landscapes, which in turn combine to form biomes. For example, within the Lusitanian biome there will be coastal, lowland, mountain valley and montane landscapes. Within each of those landscapes there will be different associations, for example the biotopes as defined by the EC CORINE system. Thus the montane landscapes will contain associations of alpine species, grasslands, heaths, scrub and forests.

A similar procedure involving a variety of measures including biodiversity is being proposed for the preparation of a Red Data Book for threatened landscapes by the CESP commission of IUCN. The principle is that a variety of measures are used to compare different landscapes within the same class.

patterns: in natural communities the boundaries are often more vague.

Multivariate statistical techniques (Jones and Bunce 1985) are increasingly important in providing the method for classification and work well for some data sets (such as, for example, species composition). However, much classification, for example of landscapes and biomes, is based on judgement and experience rather than on objective methods. The subjectivity does not necessarily diminish the utility of the result. A historical example makes the point. C.H. Merriam worked in Arizona, USA in the 1880s. He characterized the biodiversity into seven 'life zones' on the basis of the appearance of the vegetation. Providing maps and elevational transects, he mapped these zones across the northern part of the state. Merriam's classification preceded formal vegetational surveys and the array of sophisticated computer-intensive statistical analyses now available. None the less, a century later his classification retains its utility as a broad guide to where species of plants and animals will be found and where the boundaries between their distributions lie. Similarly, despite all the criticisms of phytosociology, the method has provided a practically useful inventory of the types of vegetation in many areas.

All of the existing global classifications of ecological systems are to some extent inadequate, either in their methodology or in their spatial coverage, or in both. We urgently need a robust classification of the world's ecosystems which can be used to map the distribution of ecological resources. This need is partly to provide a basis for assessing biological diversity and for setting priorities for conservation, and also for many other purposes associated with environmental change. The urgency and magnitude of this task means that compromises must be found between theoretical rigour and practical feasibility. The task will inevitably require information of many kinds including remote sensed data, field assessment, and documentary information.

2.3.4 Conclusions

1. Organisms are not evenly distributed: they occur in an intricate spatial mosaic, classified on a world scale into *biogeographic zones, biomes, ecoregions* and *oceanic realms*, and at a variety of smaller scales within *landscapes* into *ecosystems, communities* and *assemblages*.
2. In terrestrial systems the community found at any one point can be characterized by the physical environment (ecoregion), the physiognomic type (biome), and the floristic/faunistic (biogeographic) zone in which it occurs. In marine systems communities are characterized in terms

between the theoretician and the practitioner. The theoretician seeks an objective basis for classifying ecosystems, and rigorous methods both for sampling ecological systems and for establishing the distinct units.

How does one recognize a biome, landscape, habitat, or biotype? Certainly, when sufficient data are available, there are formal statistical procedures that group smaller areas into larger divisions according to the principle that the diversity is low within and higher between those divisions (Hengeveld 1990). In anthropogenic landscapes boundaries are often easily identified as simple differences in land-use

- of the physical environment and the faunistic (biogeographic) zone.
3. The units of classification used on a global scale differ in how they are recognized and consequently in the distinctions between their subdivisions. Biogeographic zones differ taxonomically in the flora and fauna present, even between areas of similar physical environment (e.g. within the same ecoregion) or similar physiognomy (e.g. within the same biome). Conversely, the physiognomic differences between biomes within one biogeographic zone are paralleled by those within another.
 4. The biodiversity within an area can be characterized by measures of *species richness*, *species diversity*, *taxic diversity* and *functional diversity* – each highlighting different perspectives.
 - (a) Species richness (also called α -diversity) measures the number of species within an area, giving equal weight to each species.
 - (b) Species diversity measures the species in an area adjusting for both sampling effects and species abundance.
 - (c) Taxic diversity measures the taxonomic dispersion of species, thus emphasizing evolutionarily isolated species that contribute highly to the assemblage of features or options.
 - (d) Functional diversity assesses the richness of functional features and interrelations in an area, identifying *food webs* along with *keystone species* and *guilds*, characterized by a variety of measures, strategies and spectra.
 5. At the smaller scale landscapes are composed of areas characterized as ecosystems or communities. The diversity between areas is measured as β -diversity, the change in species present.
 6. *Systems diversity* is assessed as the richness of ecological systems in a region or landscape.

References

- Archibald**, O.W. 1995. *Ecology of World Vegetation*. Chapman and Hall, London.
- Bailey**, R.G. 1981. Integrated approaches to classifying land as ecosystems. In: Laban, P. (ed.), *Proceedings of the Workshop on Land Evaluation for Forestry*. 95–109. ILRI, Wageningen.
- Bailey**, R.G. 1989. Ecoregions of the continents. *Environmental Conservation* **16**: 307–309.
- Bailey**, R.G. and Hogg, H.C. 1986. A world ecoregions map for resource partitioning. *Environmental Conservation* **13**: 195–202.
- Barbour**, C.D. and Brown, J.H. 1974. Fish species diversity in lakes. *American Naturalist* **108**: 473–489.
- Barr**, C.J., Bunce, R.G.H., Clarke, R.T., Fuller, R.M., Furse, M.T., Gillespie, M.K., Groom, G.B., Hallam, C.J., Hornung, M.J., Howard, D.C. and Ness, M.J. 1993. *Countryside Survey 1990. Main Report*. Countryside Series; Vol. 2. Department of the Environment, London.
- Box**, E.O. 1981. *Macroclimate and Plant Forms: An introduction to predictive modelling in phytogeography*. Dr W. Junk, The Hague.
- Briggs**, 1974. *Marine Zoogeography*. McGraw-Hill, New York.
- Clements**, F.E. 1916. *Plant Succession. An analysis of the development of vegetation*. No. 242. Carnegie Institute, Washington, DC.
- Cody**, M.L. 1974. *Competition and the Structure of Bird Communities*, Princeton University Press, Princeton, NJ.
- Cody**, M.L. 1975. Towards a theory of continental species diversities. In: Cody, M.L. and Diamond, J.M. (eds), *Ecology and Evolution of Communities*. 214–257. Belknap Press, Harvard, Cambridge, Mass.
- Cody**, M.L. 1986. Diversity, rarity, and conservation in Mediterranean-climate regions. In: Soulé, M.E. (ed.), *Conservation Biology: The science of scarcity and diversity*. 123–152. Sinauer Associates, Sunderland, Mass.
- Cody**, M.L. 1993. Bird diversity components within and between habitats in Australia. In: Ricklefs, R.E. and Schluter, D. (eds), *Species Diversity in Ecological Communities: Historical and Geographical Perspectives*. 147–158. University of Chicago Press, Chicago.
- Cohen**, J.E., Briand, F. and Newman, C.M. (eds) 1990. *Community Food Webs: Data and theory*. Springer-Verlag, New York.
- Colwell**, R.K. 1992. Niche: a bifurcation in the conceptual lineage of the term. In: Keller, E.F. and Lloyd, E.A. (eds), *Keywords in Evolutionary Biology*. 241–248. Harvard University Press, Cambridge, Mass.
- Cornell**, H.V. 1985. Local and regional richness of cynipine gall wasps on California oaks. *Ecology* **66**: 1247–1260.
- Cox**, C.B. and Moore, P.D. 1993. *Biogeography: An ecological and evolutionary approach*. Blackwell Scientific Publications, London.
- Curtis**, J.T. 1959. *The vegetation of Wisconsin*. University of Wisconsin Press, Madison.
- De Candolle**, A.P.A. 1874. Constitution dans le règne végétal de groupes physiologiques applicables à la géographie ancienne et moderne. *Archives des Sciences Physiques et Naturelles*. Geneva, Switzerland.
- Dietrich**, D. 1963. *General Oceanography: An introduction*. Interscience Publishers, New York.
- Elton**, C.S. 1927. *Animal Ecology*. Methuen, London.
- Faith**, D.P. 1992. Conservation evaluation and phylogenetic diversity. *Biology and Conservation* **61**: 11–15.
- Forman**, R.T.T. and Godron, M. 1986. *Landscape Ecology*. John Wiley, New York.
- Franklin**, J.F. 1993. Preserving biodiversity: species, ecosystems or landscapes. *Ecological Applications* **3**: 202–205.

- Fuentes, E.R.** 1976. Ecological convergence of lizard communities in Chile and California. *Ecology* **57**: 3–17.
- Gaugh, H.G.** 1982. *Multivariate Analysis in Community Ecology*. Cambridge University Press, Cambridge.
- Gleason, H.A.** 1926. The individualistic concept of the plant association. *Bulletin of the Torrey Botanical Club* **47**: 21–33.
- Grabherr, G.** and Kojima, S. 1993. Vegetation diversity and classification systems. In: Solomon, A.M. and Shugart, H.H. (eds), *Vegetation Dynamics and Global Change*. 218–232. Chapman and Hall, New York.
- Greenwood, P.H.** 1983. The zoogeography of African freshwater fishes; bioaccountancy or biogeography?. In: Sims, R.W., Price J.H. and Whalley P.E.S. (eds), *Evolution, Time and Space: The emergence of the Biosphere*. 179–199. Academic Press, London.
- Griesemer, J.** 1992. Niche: historical perspectives. In: Keller, E.F. and Lloyd, E.A. (eds), *Keywords in Evolutionary Biology*. 231–240. Harvard University Press, Cambridge, Mass.
- Hall, S.J.** and Raffaelli, D.G. 1993. Food webs: theory and reality. *Advances in Ecological Research* **24**: 187–239.
- Harrison, S., Ross, S.J.** and Lawton, J.H. 1992. Beta diversity on geographic gradients in Britain. *Journal of Animal Ecology* **61**: 151–158.
- Hayden, B.P., Ray, C.G.** and Dolan, R. 1984. Classification of coastal and marine environments. *Environmental Conservation* **11**: 199–207.
- Hengeveld, R.** 1990. *Dynamic Biogeography*. Cambridge University Press, Cambridge.
- Holdridge, L.R.** 1947. Determination of world plant formations from simple climatic data. *Science* **105**: 367–368.
- Holdridge, L.** 1967. *Life Zone Ecology*. Tropical Science Centre, San José, Costa Rica.
- Huston, M.A.** 1994. *Biological Diversity – The coexistence of species on changing landscapes*. Cambridge University Press, Cambridge.
- Hutchinson, G.E.** 1959. Homage to Santa Rosalia, or why are there so many kinds of animals. *American Naturalist* **937**: 117–125.
- International Union for the Conservation of Nature (IUCN)** 1980. *World Conservation Strategy: Living resource conservation for sustainable development*. IUCN, UNEP and WWF, Gland, Switzerland.
- Jaksic, F.M.** 1981. Abuse and misuse of the term 'guild' in ecological studies. *Oikos* **37**: 397–400.
- Jaksic, F.M.** and Medel, R.G. 1990. Objective recognition of guilds: testing for statistically significant species clusters. *Oecologia* **82**: 87–92.
- Jones, H.E.** and Bunce, R.G.H. 1985. A preliminary classification of the climate of Europe from temperature and precipitation records. *Journal of Environmental Management* **20**: 17–29.
- Karr, J.R.** and James, F.C. 1975. Ecomorphological configurations and convergent evolution in species and communities. In: Cody, M.L. and Diamond, J.M. (eds), *Ecology and Evolution of Communities*. 258–291. Harvard University Press, Cambridge, Mass.
- Klijn, F.** and Udo de Haes, H.A. 1994. A hierarchical approach to ecosystems and its implications for ecological land classification. *Landscape Ecology* **9**: 89–104.
- Köppen, W.** 1884. Die Wärmezonen der Erde, nach der Wirkung der Wärme auf die organische Welt betrachtet. *Meteorologische Zeitschrift* **1**: 215–226.
- Latham, R.E.** and Ricklefs, R.E. 1993. Global patterns of tree species richness in moist forests: energy–diversity theory does not account for variation in species richness. *Oikos* **67**: 325–333.
- Lawton, J.H.** 1982. Vacant niches and unsaturated communities: a comparison of bracken herbivores in two continents. *Journal of Applied Ecology* **51**: 573–596.
- Lawton, J.H., Lewinsohn, T.M.,** and Compton, S.G. 1993. Patterns of diversity for the insect herbivores on bracken. In: Ricklefs, R.E. and Schluter, D. (eds), *Species Diversity in Ecological Communities: Historical and geographical perspectives*. 178–184. University of Chicago Press, Chicago.
- MacArthur, R.H.** and Wilson, E.O. 1967. *Theory of Island Biogeography*. Princeton University Press, Princeton, NJ.
- McNeely, J.A., Miller, K.R., Reid, W.V., Mittermeier, R.A.** and Werner, T.B. 1990. *Conserving the World's Biological Diversity*. IUCN, WRI, CI, WWF and World Bank, Washington, DC.
- Magurran, A.E.** 1988. *Ecological diversity and its measurement*. Princeton University Press, Princeton, NJ.
- Martinez, N.D.** 1992. Constant connectance in community food webs. *American Naturalist* **139**: 1208–1218.
- Miles, D.B.** and Ricklefs, R.E. 1984. The correlation between ecology and morphology in deciduous forest passerine birds. *Ecology* **65**: 1629–1640.
- Miranda, F.** and Hernandez, E. 1963. Los tipos de vegetacion de Mexico y su clasificacion. *Bol. Soc. Bot. Mexico* **28**: 29–179.
- Noss, R.F.** 1983. A regional landscape approach to maintain diversity. *BioScience* **33**: 700–706.
- Norse, E.A.** (ed.) 1993. *Global Marine Biological Diversity: A strategy for building conservation into decision making*. Island Press, Washington, DC.
- Olsen, J.S., Watts, J.A.** and Allison, L.J. 1983. *Carbon in Live Vegetation of Major World Ecosystems*. Oak Ridge National Laboratory, Oak Ridge, Tenn.
- Olson, J.S., Watts, J.A.** and Allison, L.J. 1985. *Major World Ecosystem Complexes Ranked by Carbon in Live Vegetation: A database*. Oak Ridge National Laboratory, Oak Ridge, Tenn.
- Orians, G.H.** 1993. Endangered at what level? *Ecological Applications* **31**: 206–208.
- Paine, R.T.** 1966. Food web complexity and species diversity. *American Naturalist* **100**: 65–75.
- Paine, R.T.** 1992. Food web analysis through field measurement of per capita interaction strength. *Nature* **335**: 73–75.
- Palmer, M.A., Bell, S.L.** and Butterfield, I. 1992. A botanical classification of standing waters in Britain: applications for conservation and monitoring. *Aquatic Conservation: Marine and Freshwater Ecosystems* **2**: 125–143.
- Pimm, S.L.** 1982. *Food Webs*. Chapman and Hall, London.
- Polis, G.A.** 1991. Complex desert food webs: an empirical critique of food web theory. *American Naturalist* **138**: 123–155.
- Prendergast, J.R., Quinn, R.M., Lawton, J.H., Eversham, B.C.** and Gibbons, D.W. 1993. Rare species, the coincidence of hotspots and conservation strategies. *Nature* **365**: 335–337.

- Putman, R.J.** 1994. *Community Ecology*. Chapman and Hall, London.
- Raunkiaer, C.** 1934. *The Life Forms of Plants and Statistical Plant Geography*. Clarendon Press, Oxford.
- Raup, D.M and Crick, R.E** 1979. Measurement of faunal similarity in Palaeontology. *Journal of Palaeontology* **53**: 1213–1227.
- Rodwell, J.S. (ed.)** 1991. *British Plant Communities*, Vol. 1. *Woodlands and Scrub*. Cambridge University Press, Cambridge.
- Root, R.B.** 1967. The niche exploitation pattern of the blue-gray gnatcatcher. *Ecological Monographs* **37**: 317–350.
- Schall, J.J. and Pianka, E.R.** 1978. Geographical trends in the numbers of species. *Science* **201**: 679–686.
- Schluter, D.** 1986. Tests for similarity and convergence in finch communities. *Ecology* **67**: 1073–1085.
- Shannon, C.E. and Weaver, W.** 1949. *The Mathematical Theory of Communication*. University of Illinois Press, Urbana.
- Sherman, K.** 1994. Sustainability, biomass yields, and health of coastal ecosystems: an ecological perspective. *Marine Ecology Progress Series* **112**: 277–301.
- Simberloff, D. and Dayan, T.** 1991. The guild concept and the structure of ecological communities. *Annual Review of Ecology and Systematics* **22**: 115–143.
- Simpson, E.H.** 1949. Measurement of diversity. *Nature* **163**: 688.
- Solomon, A.M.** 1992. A global biome model based on plant physiology and dominance, soil properties and climate. *Journal of Biogeography* **19**: 117–134.
- Stott, A.P., Parr, T.W., Barr, C.J., Bunce, R.G.H., Fuller, R.M. and Furse, M.** 1993. *Countryside Survey 1990*. Department of the Environment, London.
- Takhtajan, A.** 1969. *Flowering Plants, Origins and Dispersal*. Oliver and Boyd, Edinburgh.
- Tansley, A.G.** 1935. The use and abuse of vegetational concepts. *Ecology* **16**: 284–307.
- ter Braak, C.J.F.** 1986. Canonical correspondence analysis: a new eigenvector technique for multivariate direct gradient analysis. *Ecology* **67**: 1167–1179.
- Udvardy, M.D.F.** 1975. *A classification of the biogeographical provinces of the world*. IUCN Occasional Paper No. 18. IUCN, Morges, Switzerland.
- Vinogradova, N.G.** 1962. Vertical zonation in the distribution of deep-sea benthic fauna in the ocean. *Deep-Sea Research* **8**: 245–250.
- Wallace, A.R.** 1876. *The Geographic Distribution of Animals*. Harper, New York.
- Wardle, P.** 1974. Alpine timber lines. In : Ives J.D. and Barry, R.G. (eds), *Arctic and Alpine Environments*. 371–402. Methuen, London.
- Whittaker, R.H.** 1960. Vegetation of the Siskiyou Mountains, Oregon and California. *Ecological Monographs* **30**: 279–338.
- Whittaker, R.H.** 1972. Evolution and measurement of species diversity. *Taxon* **21**: 213–251.
- Whittaker, R.H.** 1977. Evolution of species diversity in land communities. *Evolutionary Biology* **10**: 1–67.
- Wilson, M. and Shmida, A.** 1984. Measuring beta diversity with presence-absence data. *Journal of Ecology* **72**: 1055–1064.
- World Conservation Monitoring Centre** 1992. *Global Biodiversity: Status of the Earth's living resources*. Chapman and Hall, London.

3

Magnitude and Distribution of Biodiversity

D.L. HAWKSWORTH, M.T. KALIN-ARROYO

Lead Authors:

P.M. Hammond (Chapter 3.1); R.E. Ricklefs (Chapter 3.2); R.M. Cowling, M.J. Samways (Chapter 3.3)

Contributors:

B. Aguirre-Hudson, M. Dadd, B. Groombridge, J. Hodges, M. Jenkins, M.H. Mengesha, W. Stewart Grant (Chapter 3.1); M.T. Kalin-Arroyo, R.E. Latham, T.M. Lewinsohn, D.J. Lodge, N.I. Platnick, D. Wright (Chapter 3.2); T.M. Crowe, D.R. Given, A. Machado, G.T. Prance, S.S. Renner, J.A. Simonetti, C.A. Stace (Chapter 3.3)

CONTENTS

Executive Summary	111	3.2 The distribution of biodiversity	139
3.0 Introduction	113	3.2.0 Introduction	139
3.1 The current magnitude of biodiversity	113	3.2.1 Geographical patterns of biodiversity	139
3.1.0 Introduction	113	3.2.1.1 Gradients	139
3.1.1 Ecosystems and habitats	113	3.2.1.1.1 Terrestrial environments	140
3.1.1.1 Ecosystem diversity	114	3.2.1.1.2 Marine environments	141
3.1.1.2 Habitat diversity	114	3.2.1.2 Centres of diversity	142
3.1.1.3 Assessment of global ecosystem diversity	114	3.2.1.2.1 What is a centre of diversity?	142
3.1.1.4 Assessment of local biological diversity	114	3.2.1.2.2 Do centres of diversity share general features?	144
3.1.1.5 Comparisons of different areas	115	3.2.1.2.3 Are centres of diversity for different taxa congruent?	144
3.1.2 Organism inventory	115	3.2.1.2.4 Do centres of diversity correspond to areas of endemism?	144
3.1.2.1 Inventorying life: the pivotal role of species	115	3.2.1.3 Introduced species	145
3.1.2.2 The record to date: described species	116	3.2.1.4 Domesticated species	145
3.1.2.3 The true richness of life	119	3.2.1.5 Rarity	145
3.1.2.4 Sources of undisclosed species richness	121	3.2.1.6 Diversity and scale	153
3.1.2.4.1 Benthic species richness	121	3.2.2 Biodiversity patterns: correlates and explanations	153
3.1.2.4.2 Terrestrial arthropods	122	3.2.2.1 Environmental factors and biodiversity	153
3.1.2.4.3 Tropical tree crowns	122	3.2.2.1.1 Climate and productivity	153
3.1.2.4.4 Fungi and other microorganisms	122	3.2.2.1.2 Environmental chemistry	154
3.1.2.4.5 Other groups	123	3.2.2.1.3 Stress	154
3.1.2.4.6 Mutualists and parasites	123	3.2.2.1.4 Heterogeneity	154
3.1.2.5 Problems and prospects	123	3.2.2.1.5 Biological interactions	155
3.1.2.5.1 Well-known groups are poor reference points	123	3.2.2.2 Speciation and extinction	155
3.1.2.5.2 Undisclosed sources of species richness	123	3.2.2.2.1 Species production	155
3.1.2.5.3 The scale of uncertainty	123	3.2.2.2.2 Extinction	155
3.1.2.5.4 Conceptual and operational issues	124	3.2.2.3 Ecological theories of species diversity	155
3.1.2.6 The tools for the job	124	3.2.2.3.1 Processes that add and remove species	155
3.1.3 Genetic diversity	124	3.2.2.3.2 Equilibrium versus non-equilibrium explanations	156
3.1.3.1 Animal genetic diversity	125	3.2.2.3.3 Theories of local coexistence	156
3.1.3.2 Plant genetic diversity	125	3.2.2.3.4 Terrestrial landscape, marine environment and freshwater diversity	157
3.1.3.3 Other organisms	126	3.2.2.4 Tests of theories of local coexistence	157
3.1.4 Domesticated diversity	126	3.2.2.4.1 Community saturation	157
3.1.4.1 Sources and centres of domesticated biodiversity	126	3.2.2.4.2 Regional enrichment	157
3.1.4.2 Domesticated plant diversity	128	3.2.2.4.3 Community convergence in species diversity	158
3.1.4.3 Domesticated animal diversity	129	3.2.2.5 The relationship between local and regional diversity	159
3.1.4.4 Domesticated aquatic diversity	129	3.2.2.5.1 Empirical evaluation of the relationship between local and regional diversity	159
3.1.4.5 Domesticated microbial and invertebrate diversity	131		
3.1.4.6 Domesticated diversity at risk	133		
References	135		

3.2.2.6 Taxon-specific patterns of diversity: dispersal	160	3.3.1.4 Biases	175
3.2.2.6.1 Passive dispersal	160	3.3.2 Evaluating endemism	175
3.2.2.6.2 Active dispersal	161	3.3.2.1 Units of measurement	176
3.2.2.6.3 Vectors	161	3.3.2.2 Percentages versus counts	177
3.2.2.6.4 Interactions of dispersal with breeding system	161	3.3.3 Patterns	177
3.2.2.7 History, biogeography and diversity	162	3.3.3.1 Centres of endemism	177
3.2.2.7.1 Non-convergence and the roles of history and biogeography	162	3.3.3.2 Other patterns	177
3.2.2.7.2 Diversity anomalies and geographic and historical circumstances	162	3.3.3.3 Congruence	178
3.2.2.7.3 Congruence and independence of histories	163	3.3.4 Endemism: correlates and causes	179
3.2.2.7.4 Differential extinction	164	3.3.4.1 Regional species richness	180
3.2.2.7.5 History and ecological diversity patterns	165	3.3.4.2 Area	180
3.2.3 Concluding comments	166	3.3.4.3 Environmental factors	180
References	166	3.3.4.4 Biotope	180
3.3 Endemism and biodiversity	174	3.3.4.5 Biological factors	180
3.3.1 Endemism: concepts and perspectives	174	3.3.4.6 Taxonomic correlates	183
3.3.1.1 Background	174	3.3.4.7 Modelling	183
3.3.1.2 Categories of endemics	174	3.3.4.8 Endemism and reserve selection	183
3.3.1.3 A phylogenetic perspective	175	3.3.5 Special conservation considerations	183
		3.3.5.1 Endemic taxa as tools in conservation	183
		3.3.5.2 Pointers in the conservation of endemic taxa	184
		References	185
		Acknowledgements	191

EXECUTIVE SUMMARY

The current magnitude of biodiversity

- An understanding of the magnitude of biodiversity at all levels is crucial to its conservation, management and utilization. The scale of biodiversity is immense, and while estimates of its magnitude are being improved, investment is required to bridge crucial knowledge gaps and synthesize existing information.
- The magnitude of biodiversity can be examined at scales ranging from the ecosystem and habitat, through the organismal, down to the genetic levels, including domesticated diversity.
- Ecosystem classifications are largely based on vegetation, but need to take into account changes brought about by humans, and also climatic and biogeographic variables.
- Systems designed for use at the global level are of limited value at scales important for conservation purposes.
- As total site inventories are not available, ecological classifications are an important component in the assessment of sites for conservation purposes.
- Organismal biodiversity can be assessed at different levels of the classification hierarchy from kingdoms and phyla, through orders, families, genera, and species, right down to the infraspecific and genetic levels.
- Different uses of the category 'species', and the importance of phylogenetic divergence, mean that organism diversity cannot be measured objectively solely by differences in species number: the 'species', although the most commonly used unit of biodiversity, is not a standard unit of biodiversity measurement.
- The working figure of 1.75 million species is the current best estimate for the number of living (non-fossil) species currently known to science.

- An estimated 90% of the described species have never been included in regional accounts of biotas, or in identification manuals or modern monographs.
- The described species represent only a small proportion of species on Earth, and a working estimate of 13.6 million is adopted here as the overall total that exists; this suggests that only 13% of the species on Earth have yet been described.
- Molecular and genetic studies demonstrate that there is enormous diversity at the infraspecific level in almost every species examined.
- A high amount of genetic variability is found in most species. For animals, variability is on average greater within invertebrate than vertebrate species, which have more subdivided populations. For molluscs, amphibians, reptiles and mammals, about 25–30% of this variation is due to genetic difference between populations, whereas for birds and insects, which have higher gene flow between populations, this figure is only 8–10%.
- In plant species, there is a wider range of variability between different species. Breeding system is the main determinant of the pattern of genetic variability in plants.
- An indication of the extent of genetic diversity present within a species can be obtained from domesticated organisms; for example, seven separate vegetables are derived from the single species *Brassica oleracea*, and more than 800 breeds of sheep derive from *Ovis aries*.

The distribution of biodiversity

- Diversity and its distribution are the product of a long history of evolution, diversification and extinction in a complex and changing geographical/ecological setting.
- Patterns of biodiversity are the product of evolutionary diversification interacting with local ecological processes, which are influenced by the

intrinsic characteristics of organisms, and how the landscape and seascape are structured. The maintenance of diversity in natural and managed ecosystems depends upon our understanding of these local processes, while setting up regional conservation priorities must be underpinned by an understanding of the mechanisms that produce diversity and allow it to accumulate over evolutionary time.

- Within regions, certain features such as habitat productivity, structural complexity and topographic heterogeneity allow prediction of diversity *per se*, but not phylogenetic uniqueness, which may be associated with habitat uniqueness or stress, and historical accident.
- Long-term prospects for biodiversity are completely altered by changes in geographical distributions, at all scales, of biotas and their member species.
- Local diversity is maintained over ecological time periods by landscape-scale processes.
- Most studies on distribution have concentrated on macro-organisms, and in the case of fungi and other microorganisms in particular, the current level of ignorance precludes generalizations on distribution.

Endemism and biodiversity

- Endemism is a term applied to taxa that are restricted to a particular geographical area or ecological unit: definitions are tailored to particular needs. Endemism therefore signifies unique biodiversity.
 - Endemic taxa may be restricted to certain sites, biotopes, regions, political areas, map units or an arbitrary upper limit for range size. Endemics play a major role in reserve selection, based primarily on the complementarity of endemic taxa.
 - Although major centres of endemism have been detected, more work is needed to refine centres with regard to the phylogenetic uniqueness of species and their relative range sizes. Detection of further centres of endemism requires increased survey work.
 - Basic biodiversity inventory work is crucial to a clearer understanding of what species are endemic to which region.
 - In many groups of organisms, endemism is most pronounced in the tropics and south-temperate areas. It is largely a function of historical factors, but these interact strongly with others such as environmental heterogeneity, taxon mobility and degree of isolation.
 - Endemics are often highly vulnerable to anthropogenic disturbance and other forms of environmental change, and are often indicators of biodiversity-rich locations. Detailed phylogenetic analyses and geographic distributions of a small number of groups may facilitate our understanding of the development of particular biotas.
 - There is a need to identify centres of endemism using rigorous methods, and to develop predictive models of the abiotic and biotic correlates of endemism. Data suitable for testing hypotheses of community convergence and ecological saturation are almost wholly lacking.
-

3.0 Introduction

The objective of this Section is to examine what is known of the magnitude of biodiversity and its distribution in ecological, organismal, and genetic terms (see Section 1.2.0). An assessment of the current magnitude of biodiversity (Section 3.1) is fundamental to all discussion about its conservation or sustainable use, and here it is vital to distinguish truly informative data from those which provide an inadequate or inappropriate basis for extrapolation. The extent and location of the resource base required for biodiversity assessments is a key aspect in the refining of estimates at all levels, and it is therefore given special attention elsewhere (see Section 8)

Section 3.2 considers the distribution of biodiversity, the identification of centres of diversity and endemism, and their relevance to the selection and prioritization of sites for conservation purposes. Endemism often assumes a high profile in discussions of conservation priorities, but the use of the concept and its evaluation require careful scrutiny (Section 3.3).

3.1 The current magnitude of biodiversity

3.1.0 Introduction

For many aspects of biodiversity there are no generally accepted ways of characterizing or quantifying the constituent elements. For others, the task is straightforward enough but can only be performed within a given context or at a given scale, and the information cannot simply be summed to give an assessment of the magnitude of this aspect of biodiversity in a broader context or at a larger scale. For yet others, although a summing of data is feasible, the results obtained may have little scientific or practical significance. For most aspects of biodiversity the questions of how 'special' a given definable unit is (e.g. see Section 2.1.6), as well as how rich or diverse it is will be of interest, and in many instances the former is of paramount significance. For these reasons, this section focuses primarily on taxonomic units, and on species in particular, not because these are of greater significance in biodiversity terms than ecological systems or genes but because these taxonomic units can be counted and, if identified securely, summed across ecological hierarchies and across geographical scales.

3.1.1 Ecosystems and habitats

As already noted, it is now customary to consider biodiversity in ecological, organismal (taxonomic) and genetic terms, and at a variety of levels for each of these (Box 1.2-1; and see May (1994a, b) and Section 1.2.0 for a fuller discussion). The key units in the ecological hierarchy, as in the taxonomic hierarchy, are populations, rather than the individuals of which they are composed or the species to which the populations belong. However, in

practice species provide the main point of reference in most attempts to quantify and assess the magnitude of ecological systems at other levels (see Sections 2.3.2, 2.3.3), as well as occupying a central role in biodiversity studies in general (3.1.2.1).

Both genes and species can be regarded, simplistically, as identifiable units that define themselves through replication or reproduction. The ecological systems in which genes and species are found, such as habitats and ecosystems, have no such identity: they are more conceptual entities than genes or species; they do not exist as discrete units, but represent different parts of a highly variable natural continuum; they interdigitate and intergrade in complex ways, the perception of which is heavily scale-dependent; they change through processes of succession and degradation; and they do not perpetuate themselves, but are kept in existence or recreated by the species of which they are comprised and the abiotic factors that affect them.

Thus, while terms such as biome, ecosystem, biocoenosis, habitat and community are widely used, their classification, their precise delimitation, and any assessment of their global diversity are beset with difficulties. These difficulties are compounded by issues of scale, and by biotic differences between continents. There is no internationally accepted standard classification of ecosystems and related phenomena for global application; although there are many options, depending on the purpose to which the classification is to be put, and the scale at which it is to be used. Some of these options are discussed in Section 2.3.3. Questions about the global magnitude of ecosystem or habitat diversity will receive as many answers as there are systems for classifying the phenomena whose diversity is being assessed. In fact, any such global assessment may be open to challenge on theoretical grounds. The key issues are related: to what extent can the natural world be described as a mosaic as well as the continuum that observation suggests; and if at progressively larger scales each part of the world is seen increasingly to be unique, at what scale are spatial generalizations valid?

Geographic boundaries between ecosystems (or units of other types) will be easier to draw the more fully their contents can be defined, for example in terms of structure and species composition, but the system of classification used will at the same time thereby become more site-specific and therefore less useful for global analysis. However, the use of satellite imagery to furnish data on vegetation structure and phenology, in conjunction with a Geographical Information System (GIS) has introduced a new versatility (UNEP/GEMS 1993). In a GIS the satellite data can be managed with minimum classification; different factors can be represented in different GIS layers, and can be aggregated as appropriate to the scope of the task in hand (see Section 7.2.10).

In practice, ecosystem diversity has been assessed most usefully at two principal levels: first, at a very generalized global level (see Section 2.3.3.3), with emphasis on climatic determinants of ecosystem type; secondly, on a local or regional basis, and largely in terms of vegetation or diversity of species present (see Section 2.3.3.2).

3.1.1.1 Ecosystem diversity

The term ecosystem, as noted earlier (see Section 2.3.3), is in a sense non-dimensional and its boundaries are defined according to the convenience of the researcher. In its original usage, therefore, ecosystem diversity could be assessed primarily on a local basis, and in terms of diversity among some set of system components (e.g. the number of trophic levels or the biomass of primary producers). But if explicit reference to ecosystem dynamics is omitted, the concept of diversity within ecosystems becomes closely equivalent to species diversity. Also, statements about ecosystem and habitat diversity, or trends therein, often use the terms ecosystem and habitat more or less interchangeably, and tend to converge on what, in practice, is a statement about elements of landscape.

3.1.1.2 Habitat diversity

A **habitat** may be defined as the space used by an organism, together with the other organisms with which it co-exists, and the landscape and climate elements that affect it. The terms in which a species' habitat may be defined will differ greatly at different scales and for different kinds of organism (consider a bacterium, a badger and a blue whale). Habitat change that one species might find intolerable could be imperceptible to another, and beneficial to a third. Habitat diversity, narrowly applied, should refer to diversity in the habitat of some given species: loosely applied, it tends to refer to gross structural or compositional differences in the local environment of some community of species. However, if in any given landscape there are as many habitat dimensions as there are species present, general statements about global habitat diversity or about the status of habitats can have little meaning without specific reference to those living entities for which some given place is a habitat.

3.1.1.3 Assessment of global ecosystem diversity

For use at the global level, there is no universally accepted classification of ecological systems (see Section 2.3.3). Many classifications, however, are based on vegetation type. Robust but necessarily simplified schemes of this type have been adopted for the purpose of modelling global climate change. These tend to use a more or less elaborate combination of a general definition of habitat type with a climatic descriptor (e.g. 'tropical moist forest'). Some also take into account the effects of human activity and/or

incorporate a biogeographical element (see Section 2.3.3.3).

To the extent that their units of classification can be equated with ecosystems (*sensu lato*) classifications of such as those of Bailey, Udvardy and Holdridge (see Section 2.3.3.3) can yield a general view of the global diversity of kinds of ecosystem. However, precisely because of their global focus, they are able to furnish relatively little information about comparative diversity within and between ecosystems or habitats, and little that is applicable to site or national planning issues (this was rarely or never the original purpose).

3.1.1.4 Assessment of local biological diversity

This incorporates two related issues. The first concerns the intrinsic diversity of an area; an area with higher diversity may be deemed more important than one with lower diversity. The second concerns assessment of the contribution any given area makes to the overall diversity of a larger geographic region, such as a country, continent or, ultimately, the world overall. From this perspective, some areas with lower intrinsic diversity may be more important than others with higher diversity.

Biological diversity measures for particular areas, habitats or ecosystems are often largely reduced to a count of species richness. Ideally this would consist of a complete inventory of the species occurring in the area under consideration. In practice, this is unrealistic even for small areas, as smaller invertebrates and micro-organisms can rarely be enumerated comprehensively. Species richness measures will therefore in practice be based on samples, especially of macro-organisms. It must, however, be stressed that species richness itself is an inherently flawed measure of biodiversity as all 'species' are not equal either conceptually (see Section 2.1.4) or with respect to the extent of diversity they represent (see Sections 2.3.2.2 and 2.3.2.3) (Harper and Hawksworth 1994). The following discussion has to be seen in this context.

Although simple measures of species richness contain little ecologically important information, in the case of macro-organisms they are in practice the most easily obtainable, and are thus often the only available general index for comparisons of biological diversity. More sophisticated measures of diversity (see Section 2.3.2.1.3) take into account the relative abundance of the species concerned. These tend to assume that an area is more diverse the more equally abundant are the species present, but different models often generate different diversity measures from the same sets of data (Magurran 1988). In addition, weight can also be given to the relative abundance of species in various categories, for example different size classes, different trophic levels, different taxonomic groups, or different growth forms (see Section 2.3.2.3). Thus a hypothetical ecosystem which consisted only of several species of primary producers, such as

photosynthesizing plants, may be considered less diverse than one with the same number of species but which included herbivores and predators. Similarly, an ecosystem with representatives from four different phyla would be phylogenetically more diverse than one with representatives of only two. A number of diversity indices have been developed which variously give higher weight to basal or relict groups (Sections 2.1.6 and 2.3.2.2), or to particularly species-rich higher taxa (see review by Faith 1994).

3.1.1.5 Comparisons of different areas

Given a satisfactory measure of diversity, it should theoretically be possible to compare the diversity of different areas. However, such comparisons are not entirely straightforward. Diversity measures for ecological entities such as communities or ecosystems make the assumption that these entities are not site-specific, that is, that they occur in essentially the same form over a wide area or in a number of different places. While this may be essentially true of physical and functional characteristics, species composition and species abundance are very rarely constant either in space or in time; thus the existence of communities or ecosystems definable by species composition is seriously questioned by many ecologists. This undermines the extent to which diversity measures derived from particular sites can be used as a basis for generalization. Nevertheless, these ecological concepts still retain considerable force, even if they cannot be rigorously defined, and much discussion of biological diversity is couched in terms of comparisons between different habitats and ecosystems (see 3.2).

The overall diversity of any given area will be a reflection both of the range of sites or kinds of habitat it includes, and the organismal diversity of these components. The differences between habitats in terms of species composition are referred to as beta (β) diversity, while the diversity within a site or habitat is alpha (α) diversity (see Section 2.3.2.1 for fuller definitions). Thus an area with a wide range of dissimilar habitats will have a high-diversity, even if each of its constituent habitats may have low diversity. An area with relatively low species diversity will make an important contribution to the overall diversity of the larger region it is found in if it contains a significant number of species that do not occur elsewhere (endemics). Mountain ranges and oceanic islands are familiar examples of areas that often have comparatively low species diversity but high rates of endemism.

3.1.2 Organism inventory

3.1.2.1 Inventorying life: the pivotal role of species

With few exceptions, inventories of the living world involve named taxa, from the level of Domain or Kingdom down to the various infraspecific (below species level)

categories. For any comprehensive assessment of the richness of life on Earth, diversity at higher classification levels (see Section 2.3.2.2) and of infraspecific entities (see 3.1.3) form essential parts of the picture, but the traditional focus of local, regional and global inventory efforts for most groups of organisms has been at the level of species. Lists of species (see Section 8.4.4, Box 8.1-1) are the common threads that link formal catalogues of life's diversity to all studies of natural assemblages. Species remain pivotal to the practical task of documenting biological diversity, as exemplified in such recent initiatives as *Systematics Agenda 2000* (1994) with the mission '*to discover, describe and classify the world's species*' (our italics). This pivotal role is occupied for arguably sound theoretical as well as operational reasons (Stanton and Lattin 1989).

The advantages of employing a 'biological' species concept wherever practicable in quantification of biological diversity at the species level have been detailed by Wilson (1992) and further discussed by Hammond (1995), who stressed the feasibility and value of establishing rough equivalence of the units used to quantify diversity in clonal organisms and micro-organisms in general to the biological species recognized in those organisms where interbreeding criteria apply. However, it is increasingly suggested, mostly by microbiologists themselves (e.g. Embley *et al.* 1994; O'Donnell *et al.* 1994), that quite different approaches to the quantification of microbial diversity are needed. None that is compatible with macro-organism approaches has so far been proposed but, given the existing conceptual impasse, a serious search for an alternative basis for measuring diversity is clearly desirable. Whether any alternative, once established, might then properly replace the use of species counts remains an open question. There are, of course, entirely different ways of assessing biological diversity as a whole that do not involve taxonomic hierarchies as such, but span the sweep from intrapopulation genetic diversity to ecosystem diversity (Solbrig 1991; May 1994a). There are also ways involving species that place emphasis on various aspects of diversity, such as the equitability of samples drawn from an assemblage, other than richness *per se*. However this may be, the question of how many kinds of organism there are (in this case 'kinds' being biological species or their rough equivalents) is still the logical focus of any attempt to assess the progress that has been achieved to date in compiling a working inventory of living organisms.

The aim of this subchapter is to assess how accurate a picture of the richness of life on Earth in terms of species is provided by the existing formal but very incomplete inventory. Two separate but often intertwined questions are involved: how good is the existing inventory in its own terms as an avowedly partial account, and how accurate a perception do we have of the size of the remaining

descriptive task? Consideration of the second of these questions is largely deferred to 3.1.1.3, while the first is discussed in 3.1.1.2, with reference to a series of other questions:

- How sound are the taxonomic hypotheses, especially those concerning species limits, on which the existing partial inventory is based?
- How well organized into catalogues and monographs are the results of the descriptive effort to date and how accessible are they?
- Which parts of the formal record are relatively complete? In what manner and at what rate is the record improving?

3.1.2.2 *The record to date: described species*

The existing species record is deficient in several respects (Hammond 1992): it is partial (many species have not been described), inaccurate (it contains errors of taxonomic judgement and of many other kinds), and biased (it is clearly more complete and more accurate for some groups of organisms and for some biomes, for example, than for others). It is therefore prone to mislead, not least when used directly or indirectly as a basis for any estimate of overall species richness, including species that are as yet undiscovered and/or undescribed (see 3.1.2.3).

In addition to being incomplete and in parts unsound, the record to date is deficient in its own terms. For many groups, data on described species are so poorly organized that the number of currently recognized species is often only very approximately known. Not surprisingly the figures for described species given, even in high profile reports and ostensibly authoritative works, vary considerably (for examples see Hammond 1992, 1995; Gaston 1991a, b), and are almost always, and notably with respect to some of the larger invertebrate animal groups, out-of-date, due to delays in cataloguing. However, even where reasonably reliable figures are available, channels for communicating these data function poorly. Furthermore, the common use of figures seemingly plucked from the air, including sometimes even figures from the same work (e.g. Brusca and Brusca 1990) that are mutually contradictory, fosters the impression that the accuracy of described species totals is not generally a matter of great concern to many who make use of them. In most recent instances the figures provided for the overall number of species currently recognized as valid tend to be put at around the 1.4 million mark (e.g. Arroyo *et al.* 1992; Wilson 1992). On investigation, however, this number is seen to be based on catalogues and estimates that are in many cases well out of date. Using the most up-to-date catalogues available and other literature sources to make

fresh individual counts or estimates of all major groups, and benefiting from advice from a range of relevant specialists, Hammond (1992) settled on a figure of approximately 1.7 million currently recognized species. With piecemeal revision of the figures for some of the larger but poorly catalogued groups, and with allowance for growth in the interim, the total arrived at and used here is approximately 1.75 million (see Table 3.1-1). This, however, remains conservative, as several of the tallies used for individual groups, including the already large one of 400 000 species for the Coleoptera (beetles), may well be underestimates (Hammond 1992).

The precision of species counts for the larger groups of organisms remains extremely variable (Hammond 1995, and see Table 3.1-2), with those for chordates, bacteria (Dworkin 1992; Trüper 1992) and viruses, for example, very high. As a result of recent attention, estimates for fungi (Hawksworth 1991a, b), although still bedevilled by imprecision due to the separate naming of the asexual stages, and those for land plants, are now both much improved. Precise counts are not available for the Protoctista, but the approximate number of recognized species is tabulated for each of the major groups of eukaryotic algae by Andersen (1992) and for major 'protozoan' groups by Vickerman (1992). Figures that may be moderately reliable for many of the marine or largely marine 'invertebrate' animal groups may be arrived at by using standard sources (e.g. Barnes and Hughes 1982; Barnes 1989) and recent reviews (Minelli 1993; Winston 1992) as a starting point, up-dating and revising the figures provided as appropriate and where feasible. However, some of the most striking remaining uncertainties involve the largest groups of invertebrates.

For the Mollusca, for example, the number of described species currently accepted is particularly problematic, with quoted figures ranging from some 45 000 to 150 000 (Minelli 1993). Winston (1992) gives 75 000 as the figure for the marine species of Mollusca alone. The problems in assessing whether the true figure lies even within the wide range of these estimates stem from the large number of mollusc names that are synonyms or refer to categories below the species level, a paucity of modern catalogues or monographs, and the lack of systematic reporting of newly established synonymy in the *Zoological Record* or elsewhere. The relatively large number of recent fossil taxa of molluscs complicates the issue further.

For nematodes also, in the absence of complete catalogues, the number of described species currently regarded as valid cannot be determined at all reliably. However, based on the figures provided by Gerlach (1980) and Poinar (1975, 1983) with the addition of subsequently described species (see *Zoological Record*) a figure of around 25 000 is reached. As with the Mollusca, new synonymies are not systematically recorded for Nematoda by the *Zoological Record* but these are assumed to be relatively few.

Table 3.1-1: Partial classification of living organisms, largely following a recent version of Whittaker's five kingdom system (Margulis & Schwarz, 1988), except that the prokaryotes are divided into two domains of equal rank – the Archaea (Archaeobacteria) and Eubacteria or 'true' bacteria. To this classification are added the viruses: minute and generally parasitic sub-organisms apparently derived from the nuclear materials of other life forms. The Margulis and Schwarz system is only partially phylogenetic: the Protoctista, for example, comprises all those eukaryotes that are not plants, fungi or animals, and the group is clearly not monophyletic. All groups equivalent to Phylum level or above with more than 5000 described species are included in the list and are marked with an asterisk (*). The approximate number of currently accepted described species is indicated for each of these groups. † Total includes Archaea.

EUBACTERIA	[c. 4 000]†	ANIMALIA*	1 320 000
(bacteria, cyanobacteria 'blue-green algae', etc.)		MESOZOA	
ARCHAEA		METAZOA* 1 320 000	
(halobacterians, methanogens, eocytes, etc.)		Porifera* (sponges)	10 000
EUKARYA*		Cnidaria*	10 000
PROTOCTISTA*	80 000	(hydras, jellyfish, corals, etc.)	
('protozoa', 'algae', etc.)		Platyhelminthes*	20 000
Actinopoda*	6 000	(flatworms)	
Foraminifera*	10 000	Nematoda* (roundworms)	25 000
Ciliophora*	8 000	Echinodermata*	6 000
Sporozoa*	5 000	(sea urchins etc.)	
Rhodophyta* (red algae)	5 000	Chordata*	45 000
Gamophyta* (green algae)	10 000	(fish, birds, mammals, etc.)	
Bacillariophyta* (diatoms)	12 000	Arthropoda*	1 085 000
PLANTAE*	270 000	(crabs, spiders, insects, etc.)	
(land plants)		Mollusca*	70 000
Mosses and liverworts*	16 000	(snails, squids, etc.)	
Pteridophytes* (ferns)	10 000	Annelida*	12 000
Spermatophyta* (seed plants)	240 000	(segmented worms)	
FUNGI*	72 000	VIRUSES	[c. 4 000]
(moulds, lichen-forming, yeasts, mushrooms, etc.)			

With few totals for major groups (see Hammond 1992) likely to be astray by more than about 20%, the degree of uncertainty with respect to the number of currently recognized species of arthropods is substantially lower than for some other invertebrate groups. Nevertheless, with more than one million described species currently recognized, inaccuracies in tallies for major arthropod groups may have a profound effect on the total arrived at for the biota as a whole. Unfortunately, although the means to perform the task are available (relatively good and numerous catalogues, recording of new synonymy and other changes in the status of names in the *Zoological Record*, and a formidable body of expert input to call upon), accurate and up-to-date counts for most large arthropod groups are lacking. Of the four largest insect Orders, the figures for Diptera (c. 120 000) and Hymenoptera (c. 130 000) (see Gaston 1993) provided by

Hammond (1992) are probably more reliably based than those for Lepidoptera (c. 150 000) and Coleoptera (c. 400 000). Many of the uncertainties with respect to the Lepidoptera stem from the much greater number of available names (including synonyms) than of recognized species, and continuing confusion between totals for the two in some of the largest groups such as the Noctuoidea. Uncertainties as to the true figure for Coleoptera arise because the intimidating yet essentially straightforward task of making new direct counts has been done for only a small number of families, coupled with the finding that there are large discrepancies between 'accepted' figures based on catalogues of various dates and those arrived at by making direct counts in the instances where these have been made (see Hammond 1992).

In those groups of organisms where an evidently low priority has been accorded, even by the taxonomists

Table 3.1-2: Approximate numbers of described species (in thousands) currently recognized, and estimates of possible species richness for groups of organisms with more than 20 000 described species and/or estimated to include in excess of 100 000 species. Low and high estimates are given from a variety of sources (see text), along with conservative 'working figures', updated from Hammond (1992). Numbers are rounded to the nearest thousand, five thousand, etc. Higher figures than the highest included here have been proposed for some groups (*) by extrapolating from the contents of small samples of soil/mud from deep ocean sediment samples (e.g. Grassle 1991; Grassle and Maciolek 1992), or by extrapolating from certain assumptions that have been made with respect to the specificity and loads of parasites in invertebrate hosts. The somewhat arbitrary working figures for bacteria and fungi are those widely accepted by specialists in these groups. The reliability of all estimates, including the working figures provided here, is likely to vary greatly. Their probable accuracy is indicated in the column to the right of the table. Working figures are categorized as either almost certainly accurate within a factor of 2 (Good), within a factor of 5 (Moderate), within a factor of 10 (Poor), or not certainly within an order of magnitude (Very poor).

	Described species	Number of estimated species		Working figure	Accuracy
		High	Low		
Viruses	4	**1 000	50	400	V. poor
Bacteria	4	**3 000	50	1 000	V. poor
Fungi	72	**2 700	200	1 500	Moderate
'Protozoa'	40	**200	60	200	V. poor
'Algae'	40	*1 000	150	400	V. poor
Plants	270	500	300	320	Good
Nematodes	25	**1 000	100	400	Poor
Arthropods					
Crustaceans	40	*200	75	150	Moderate
Arachnids	75	1 000	300	750	Moderate
Insects	950	100 000	2 000	8 000	Moderate
Molluscs	770	*200	100	200	Moderate
Chordates	45	55	50	50	Good
[others	115	800	200	250	Moderate]
Totals	1 750	111 655	3 635	13 620	V. poor

involved, to keeping track of how many species have been described, the reasons are generally clear (Hammond 1995). Foremost among these is that already described species represent an uncertain but generally relatively insignificant portion of the total that actually exist. In many instances also, described species have little more than a notional presence in the accumulating catalogue of life. Their names may appear in catalogues or lists but they are not immediately recognizable entities even to taxonomists (LaSalle and Gauld 1992). Leaving to one side the best-known groups such as vertebrates and plants, it is reasonable to estimate that perhaps 90% of described species have never been included in a regional fauna or flora, an identification manual or a thoroughgoing modern monograph of a well-defined taxonomic group. Not surprisingly, the existing inventory of described species

contains relatively large amounts of 'hidden synonymy' (Hammond 1992; Gaston and Mound 1993).

The absolute rate at which the existing species inventory is growing may be assessed very roughly by considering the rate at which new species are being described, currently in the region of 13 000 or so per annum. The most striking feature of the description rate, even for individual groups (see Figure 3.1-1) is its constancy over time-scales of one or two decades. For example, the mean figure for newly described animal species (including 'Protozoa') for the years 1979–1988 (data from the *Zoological Record*) is 11 599, with the highest figure for any of those years 12 365 and the lowest 10 912. Crude 'growth' rates (the number of new species described in relation to the number already described) also vary relatively little from group to group, but provide some measure of how existing inventories are

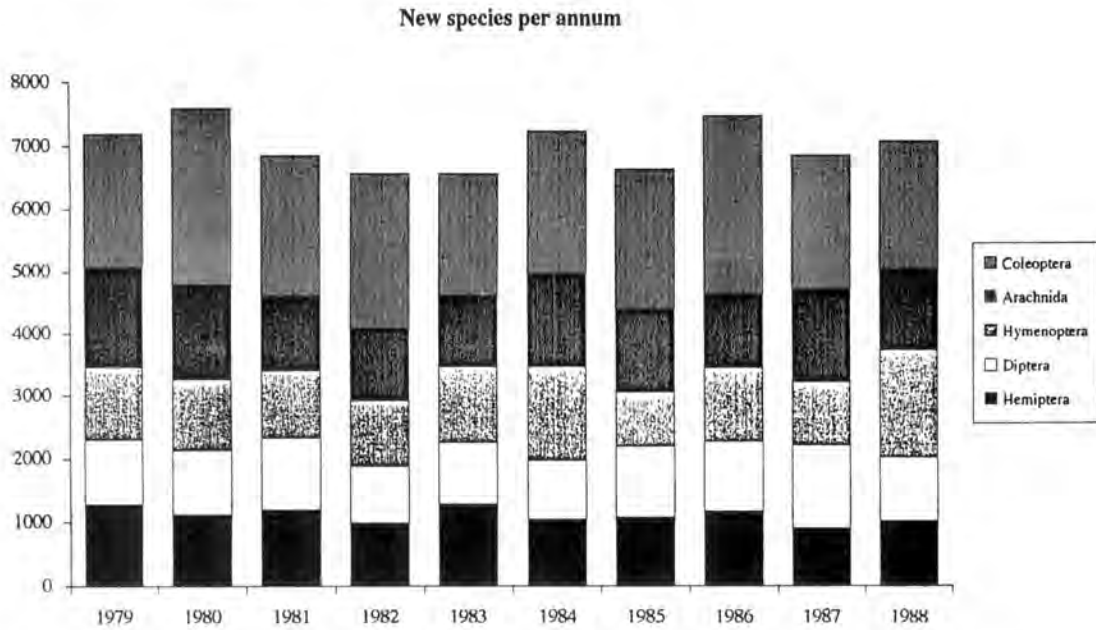

Figure 3.1-1: Description rates over a ten-year period 1979–88 for the groups of organisms with the highest rates, illustrating how invariant these are. The differently shaded areas represent (from top to bottom): Coleoptera (beetles), Arachnida (spiders, mites, etc.), Hymenoptera (wasps, ants, etc.), Diptera (two-winged flies) and Hemiptera (bugs). (Based on data in the *Zoological Record*.)

improving. Hammond (1992, 1995) provides further discussion of these rates and their possible significance for the remaining descriptive task, while more detailed analyses of past and present patterns of description have been made for several individual taxonomic groups (e.g. Gaston 1991b, 1993).

However, despite the high rates of description, increments in the numbers of species recognized as valid, especially in some of the more poorly known groups, may be much lower. This is largely due to the recognition, on critical study, that some previously described species are in fact the same as other described species, and their subsequent relegation to synonymy (Gaston and Mound 1993). For the insects the *Zoological Record* routinely lists newly established synonymies and other changes in the status of names so that, with some effort, the actual increment in species recognized per annum may be ascertained. Synonymy rates may be quite high. For example, in 1979, 2116 beetle species were newly described, but in the same year some 426 beetle species were referred to synonymy. Taking into account also additional small numbers of species resurrected from synonymy, subspecies raised to specific rank and species downgraded to subspecies, the net gain of Coleoptera species for the year was 1689, i.e. some 80% of the new species total. Gaston (1991a) quotes synonymy rates for the four major insect Orders for the years 1986–87 and 1988–89 which are variable but on average around one-third of the number newly described in those years. The relationship between numbers of species newly described and the number synonymized clearly depends very heavily

on how taxonomic efforts are deployed and, ultimately, on what in publication terms is fashionable.

3.1.2.3 The true richness of life

Detailed discussion of this topic has centred mainly on the world of animals and plants, frequently ignoring micro-organisms or relegating them to footnote status. Although the question of micro-organismal diversity is now emerging from this neglect, very few pertinent data are available on which serious discussion of the topic might be based. In addition, some authorities have questioned the applicability, in this context, of concepts such as the biological species, which are well suited to assessing the diversity of animals, plants, but rather less so to many fungi and microorganisms (see 3.1.2.1).

Given the uncertainties that persist with respect to bacteria and other clonal microorganisms in particular, but also other groups such as nematodes and mites, and whole biomes such as the deep ocean benthos (see below), current understanding of the overall dimensions of global species richness is understandably imprecise. Nevertheless, the question has been reviewed extensively and critically examined at some length (Hammond 1992, 1995).

Working figures for the number of existing species in the groups likely to make the greatest contribution to the total are illustrated in Figure 3.1-2 (after Hammond 1992, with some small revisions), and some idea of the range of existing opinion on the number of existing species in the more significant groups is provided in Table 3.1-2. To evaluate the contrasting estimates and views on the topic it

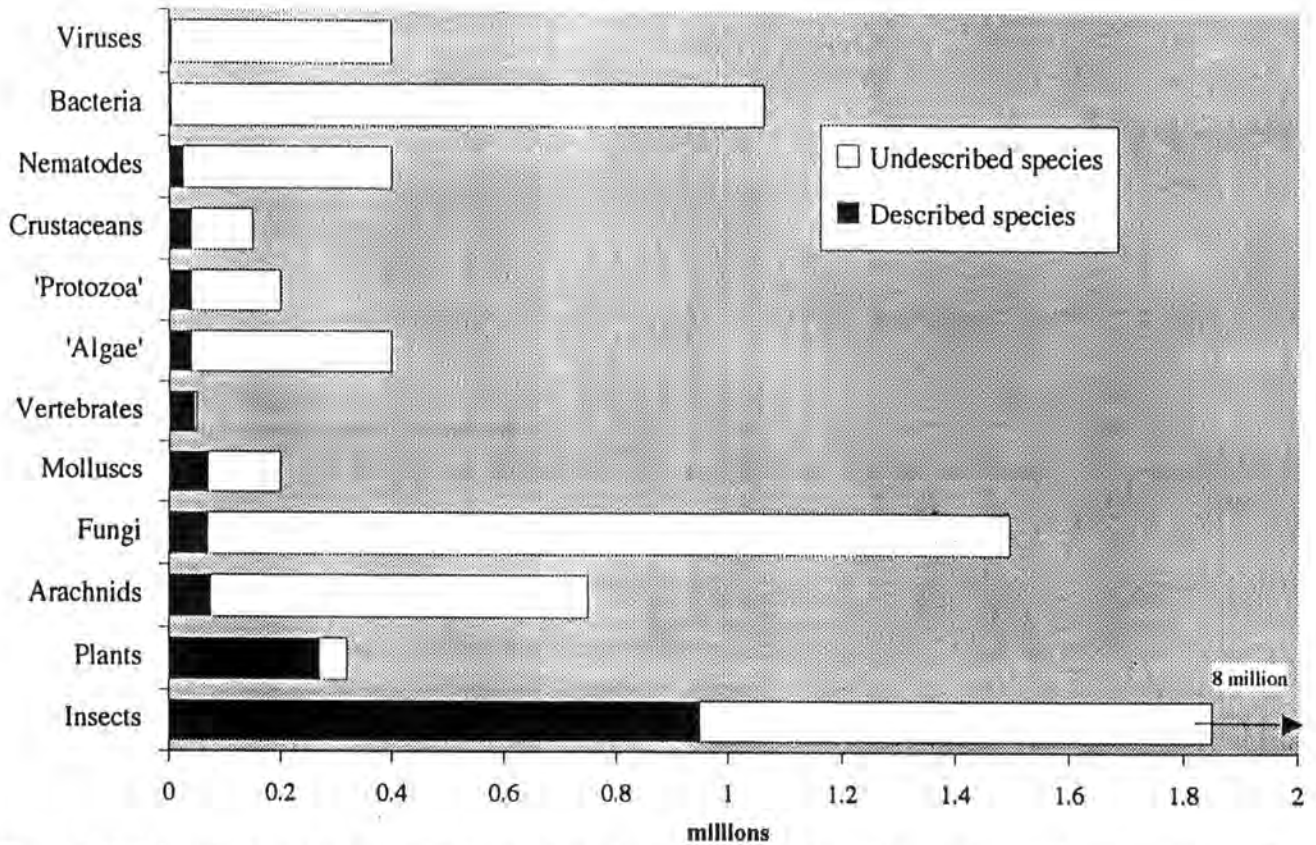

Figure 3.1-2: Numbers of described species and conservatively estimated existing species for major groups of organisms expected to contain in excess of 100 000 species (see Table 3.1.2-2 and Hammond 1992). Vertebrates are included for comparison. Note that the white portion of the bar for insects is truncated so as not to unbalance the diagram, and the length of the undescribed species portion is particularly speculative for the various groups of microorganisms.

is necessary to examine the types of evidence that have been used or might be used in arriving at them.

First, the question of the number of existing species may be approached by examining the record to date. Unfortunately, the biases in this record mean that the pattern of description is likely to be uninformative. Trend lines with respect to the rate of accumulation of new species are misleading at best (Frank and Curtis 1979; Simon 1992; Hammond 1992). The important data are those for the most species-rich groups, although species richness patterns in some of the less rich groups are of interest in themselves where these groups are of significance for conservation. It is unreasonable, however, to expect these latter data (on groups such as mammals and plants) to fulfil an 'indicator' role for species richness patterns in general.

Secondly, hints and indications (not reliable estimates) may be derived by extrapolation from what we know of body size relationships, biogeography, range sizes, the nature of mutualisms and other obligatory associations between species, latitudinal and other gradients, the influence of biotic and abiotic variables, community structure, and a range of other factors.

The question of the extent to which the well-established relationship between body size and species richness that

obtains for at least the better-known animal groups (Van Valen 1973; Dial and Marzluff 1988; Marzluff and Dial 1991) may legitimately be extrapolated to the less well known groups which predominate in the smallest size classes, has been posed and discussed particularly by May (1978, 1988, 1994b). While it is clear that for each major group of organisms there is an optimum size range and that within this range more species are generally found at the smaller end, it is also clear that there is a minimum size for each of these groups and for organisms overall (Hammond 1995). It remains questionable whether the very smallest size classes (those characteristic for many micro-organismal groups) include very many species. In part, the answer to this question depends on the kind of 'species' we recognize in such groups, but there are a number of sound biological reasons why the smallest size classes may be expected to contain fewer species than the not quite so small, notably the probably large average geographical ranges of very small organisms (supported by numerous observations) (Fenchel 1993).

Thirdly, data with respect to samples taken from appropriate natural assemblages have been employed in a variety of ways to estimate the species richness of various groups by extrapolation. For example, attempts have been made to use ratios of described to undescribed species in large

Box 3.1-1: Using simple ratios as a basis for extrapolating species richness in poorly-known but species-rich groups (data abridged from Hammond 1994).

The use of ratios involves the assumption that what holds in one instance also holds in another. It cannot be taken for granted, when dealing with species-richness ratios, that this assumption is always well grounded. It follows that essential features of this approach are the calibration of ratios, ensuring that like is compared with like, and the fullest use of 'hands on' knowledge of the groups in question and the settings in which they are found. Appropriate selection and use of focal groups for extrapolation to larger groups, the choice and use of sampling methods to obtain reliable sample data from which to extrapolate, and rigour in assembling the species data sets that form the basis of estimates, are also vital.

Species-richness ratios involve groups and contexts or settings in various ways. The ratios of greatest utility fall into six general categories:

- Group A to group B (e.g. butterflies to beetles).
- Subgroup to group (e.g. butterflies to insects).
- Sample to inventory (e.g. of a site).
- Area A to area B (e.g. site A to site B).
- Smaller scale to larger scale (e.g. site to country).
- Habitat/stratum to inventory (e.g. of a site).

samples from a defined area (Hodkinson and Casson 1991; Hodkinson 1992; Hodkinson and Hodkinson 1993). Ratios of the species richness known to obtain at different spatial scales in 'well-known' groups, especially birds, mammals, land plants or butterflies, have also been used as a basis for extrapolation to less well-known but species-rich groups, for which at least one or more data points are available (Hawksworth 1991a; Gaston 1992; Hammond 1992). In some instances, sample data for poorly-known groups have been used on their own to extrapolate across spatial scales (e.g. Grassle and Maciolek 1992). The value of these and other methods of estimating species richness of poorly explored but diverse groups of organisms has been reviewed critically by Hammond (1994, 1995), who concluded that the use of appropriate samples calibrated against inventories, and simple ratios of species richness between the group under investigation and a carefully selected, and generally less inclusive, 'reference' taxon or group provided the most practical and reliable approach (see Box 3.1-1).

How useful in making species richness estimates are the new sample data that have been pressed into service? Some are clearly more valuable than others, with the value depending very much on how they are gathered as well as on how they are then used. Interpreting the possible significance of some is not easy (e.g. data on parasite or parasitoid loads or specificities, on food-web structure, or uncalibrated data from canopy insect samples). Unfortunately, very often the patterns revealed appear to say more about how the data are gathered than they do about general patterns in nature.

3.1.2.4 Sources of undisclosed species richness

Despite widely differing views on the scale of overall global species richness, there is probably general

agreement as to the taxonomic groups and biomes that might contribute very extensively to the global species total. It is the relative contributions of these 'uncharted realms' that are in contention.

3.1.2.4.1 Benthic species richness. Suggestions that the marine benthos harbours vast numbers of undescribed species have emerged from relatively recent findings that high local species richness is characteristic of the macrofauna from deep ocean sediments (Grassle and Maciolek 1992), as well as from the indications of possible great species richness of microorganisms revealed by recent studies of little or previously unknown groups (Giovannoni *et al.* 1990, Fuhrman *et al.* 1992). On the basis of extrapolations made from sample data from such sediments, it has been argued that the marine macrofauna might number 10 million or more species, but there have been a number of critical responses to these suggestions (e.g. May 1992). The accumulation of species with increased sampling effort observed by Grassle and Maciolek (1992), although involving a geographical transect, has a very uncertain relationship to area (Hammond 1994). Rex *et al.* (1993) conclude simply that the sample data available are inadequate for any estimate of benthic species richness at larger spatial scales.

If the extrapolations made by Grassle and Maciolek (1992) with respect to the benthic macrofauna are indeed reasonable, the species richness of certain benthic meiofaunal groups and microorganisms might reasonably be assumed to be even greater. For example, Lamshead (1993) has noted that samples of macrofauna and meiofauna from marine sediments have similar rarefaction curves, and that nematodes (the major component of the meiofauna) are generally around two orders of magnitude

more abundant in such samples than polychaetes (a major component of the macrofauna). With an increase in abundance of two orders of magnitude representing an increase in diversity of approximately one order of magnitude, it might be expected that the deep ocean benthos contains around one order of magnitude more meiofaunal than macrofaunal species. Lambshhead (1993) concludes that extrapolations of the Grassle and Maciolek type point therefore to the existence of around 10 million marine nematode species.

Although patchy distributions at small scales have been well demonstrated for organisms inhabiting deep ocean sediments, typical range sizes for these, as well as for pelagic species, appear to be large, as compared with terrestrial organisms. Extensive geographical ranges are exhibited even by some of the very specialized species associated with the deep hydrothermal vents which are scattered in occurrence through the oceans. If many marine species, especially those of the deep ocean benthos, are indeed broadly distributed, high species richness at small and very small scales is not to be expected to translate to exceptionally high regional or global marine diversity.

3.1.2.4.2 Terrestrial arthropods. With well over one million species already recognized (Table 3.1-1, Figure 3.1-2), the firmest evidence for great richness of existing species is provided by the terrestrial arthropods. Conjectures as to the number of terrestrial arthropod species remaining to be described range from around one million to more than 100 million, but the more securely based of these point to a narrower range of between 2–3 and 20 million. The main focus of the more serious studies has been the insects and in particular the large orders of endopterygotes. As in other areas, several sources and types of evidence have been adduced to provide varying estimates and these have formed the basis for a lively if relatively low-profile debate. The approach adopted by Gaston (1991a), of simply consulting a range of specialist opinion, although branded as unscientific by Erwin (1991) (see Gaston 1992 for a reply), has the merit of avoiding reliance on a single set of sample data (e.g. Erwin and Scott 1980; Erwin 1982; Hodkinson and Casson 1991) of questionable utility for any attempt to directly assay the scale of global insect species richness (Hammond 1992, 1995). Arguing from additional evidence as well as a selection of specialist opinion, Gaston (1991a) presents a convincing case that evidence for the existence of 'several tens of millions' of insect species is lacking. While wisely refraining from any precise suggestion, he concludes that a figure of less than 10 million for global insect species richness 'seems more tenable, and one of around five million feasible'. Note, however, that this conclusion is based on underestimates, some by as much as a third, for the numbers of species already described in many of the more significant insect groups (Hammond 1992, 1995). Gaston himself (1991a) notes that minimum estimates are more

readily constructed than are upper limits to species numbers and accepts as plausible that figures proposed by specialists for some groups are indeed conservative. This argument is more vigorously pursued by Hammond (1992, 1995) in discussing the track record of 'taxonomists's opinions' in assessing the true richness of as yet poorly-known groups with which they work. The record is clearly one of over-cautiousness.

Overall, in contrast to the situation with microorganisms, fungi and deep ocean nematodes, the more acceptable of recent estimates of the number of existing terrestrial arthropod species are, in fact, remarkably precise. Although a value judgement that has not been fully or coherently justified in print, a figure of around 10 million existing terrestrial arthropod species appears likely to be correct, not only within an order of magnitude but within a factor of two or three. In addition, the agenda for further improving our understanding of the richness of very species-rich groups that has now been clearly articulated (Hammond 1994; Colwell and Coddington 1994) is most immediately applicable to terrestrial arthropods (Hammond 1990; Hammond and Owen 1995; Longino 1994).

The question of just how terrestrial arthropods contribute to the planet's overall species richness remains, of course, a separate issue, and one that is more dependent on improvements in the understanding of other groups, especially microorganisms, than on better documentation of the richness of the arthropods themselves.

3.1.2.4.3 Tropical tree crowns. Despite much hyperbole, clear evidence is lacking that the contribution of the undoubtedly rich assemblages found in tree crowns is critical to estimates of overall richness of insects or other hyper-diverse terrestrial groups.

3.1.2.4.4 Fungi and other microorganisms. Despite considerable recent discussion, there are still very few hard data to go on for most groups. For fungi the topic has been widely explored by Hawksworth (1991a), who tentatively suggested a conservative figure of 1.5 million for this group. Higher figures have been suggested, as discussed in Hawksworth (1993), but doubts concerning the way in which fungal species richness scales up have led some non-mycologists to suggest that the undoubtedly high local species richness of fungi may not translate to such a high overall figure (May 1994b). However, figures of this order are now generally accepted by mycologists (e.g. Rossmann 1995), and no allowance was made in Hawksworth's calculations for fungi associated with estimated undescribed insect numbers, nor for the increasing realization that fungal morphospecies not uncommonly include more than one biological species (e.g. Brasier 1986).

In the case of bacteria, the perception of how many species might exist has been changed dramatically between 1991 and 1995 as a result of the increased use of molecular technologies on environmental samples. While there may

be only up to 30 000 culturable bacteria, studies on sediments in Norway, especially those by Torsvik *et al.* (1990a, b) have been taken to indicate that unculturable bacteria may be two orders of magnitude higher (Trüper 1992).

Some of the problems and needs for the future exploration of microbial diversity are discussed below. Empirical relationships between size and species richness, which are of particular relevance to microorganisms, are discussed above.

3.1.2.4.5 Other groups. The nematodes, especially those in marine sediments (see 3.1.2.4.1) and soils, are clearly grossly under-recorded, and in addition the extent of specificity in the estimated myriads of undescribed insects is obscure. The estimates that numbers may exceed 400 000 are, however, speculative rather than based on calculations using stated assumptions.

3.1.2.4.6 Mutualists and parasites. Whereas evidence is lacking that free-living freshwater and terrestrial microorganisms (see 3.1.2.4.4) and nematodes (3.1.2.4.5), as well as their marine counterparts (3.1.2.4.1) are as species-rich as terrestrial arthropods (3.1.2.4.2), those that are symbionts or parasites of these same arthropods and other relatively large groups such as the plants could outnumber their hosts in terms of species richness. Views similar to those of Fenchel (1993) that 'symbionts and parasites probably represent the largest pool of undescribed species' are common. Indeed, if, as suggested by May (1994b), it may reasonably be argued that there is at least one specialized species of parasitic nematode, protozoan, bacterium or virus for each metazoan or vascular plant, the numbers of undescribed mutualists and parasites are likely to outnumber greatly undescribed metazoans. This is implicit in contentions such as those of Trüper (1992) that 'we can be sure that the intestinal microbial floras ... contain at least one new species of bacteria in every species of insect' or Embley *et al.* (1994) that 'all arthropods harbour microorganisms and experience suggests that in each case at least some of these will be unrecorded'. However, like other broad generalizations, the existence of a truly vast number of undescribed endosymbionts of the most species-rich free-living metazoan groups, notably the arthropods, remains very uncertain (Brooks and McLennan 1993) and for at least some other parasite groups very doubtful (Hammond 1995).

3.1.2.5 Problems and prospects

Explanations for observed patterns (see Sections 3.2 and 4) should go hand in hand with documentation and test (reciprocal illumination), but there is a tendency for the grand explanation to leap too far ahead of gathering appropriate and pertinent data. Most of the available data with respect to species-richness patterns (see Section 2.3) concern taxonomic groups, habitats and parts of the world

that are likely to be unrepresentative. The problems and prospects for more reliable estimates therefore merit review.

3.1.2.5.1 Well-known groups are poor reference points. There is a general lack of concordance between patterns for the well-known (and species-poor) groups and the hyper-diverse groups. This is true in terms of where peak richnesses occur, and also in terms of the nature – and more importantly the slope – of gradients. In view of the many differences between well- and poorly-known groups, especially the smaller average body size and greater general reliance on water among terrestrial species of the latter, these differences in species-richness patterns are not surprising. Differences in patterns of complementarity, and consequently how species richness scales as the area considered is increased are also likely between well-known and many poorly-known groups. In sum, any concordance in species-richness patterns between groups of very different biologies cannot safely be assumed, especially when these patterns extend across spatial scales.

3.1.2.5.2 Undisclosed sources of species richness. Few newly revealed sources of previously unknown organisms are especially rich in species. However, there is a tendency for any new situation that is found to harbour at least a modest number of species to be seen as a potential source of great richness. Data with respect to poorly-known groups or habitats almost always derive from a limited number of samples, often from only one or a few sites and it is important to recognize that these can provide no more than what Hammond (1995) referred to as 'indications of possible species richness'. Beyond this, their significance is difficult to gauge. Because they generally furnish no basis for assessing how the richness observed at some small scale translates to larger spatial scales, such data rarely enable even minimum species richness that might occur regionally or globally to be predicted with confidence.

3.1.2.5.3 The scale of uncertainty. The scale of uncertainty is a particular problem with microorganisms (see 3.1.2.4.4), clonal organisms in general, mutualists (3.1.2.4.6), and the deep-sea benthos (3.1.2.4.1). Assemblages of microorganisms and some other small organisms such as nematodes remain essentially remote from those who study them, as these organisms tend to demand special techniques for their extraction from their environments and often also to make them recognizable or available for convenient study. Unfortunately but understandably this means that microbiologists not only still face the difficult task of developing appropriate methods and protocols for sampling the organisms they study in a manner that will shed direct light on their local species richness, and that at successively larger scales, but also inevitably lack the day-to-day familiarity with natural assemblages of these organisms which, for example, may be obtained by those who have this familiarity through

direct observation in the field and/or through frequent handling of quantitative samples from these same settings, be it with lichenized fungi, insects, flowering plants, molluscs or filamentous algae. It is to be expected that this remoteness from the organisms they study and the minute landscapes that these organisms occupy will provide little in the way of guidance to most microbiologists in interpreting the significance of any sample data that are available. Lacking any substantial points of reference (e.g. complete site lists) and untrammelled by direct experience of natural assemblages that might act as a check and guide, the interpretation of fragmentary sample data will be subject to preconception (e.g. all metazoans contain species-specific microorganismal mutualists) and whim (e.g. the assumption that species-richness relationships across spatial scales are similar to those found in better-known groups). To a varying degree, the same difficulties obtain with respect to relatively inaccessible but rich natural assemblages, such as those found in deep ocean sediments and in the crowns of high tropical forest trees, although for both of these, especially the first, the problem is substantially one of cost and, with respect to the second, as pertinent data are steadily being obtained, interpretation of their significance is becoming less equivocal.

3.1.2.5.4 Conceptual and operational issues. Many of the conceptual issues germane to assessments of the magnitude of biodiversity have been raised by Harper and Hawksworth (1994) and are considered elsewhere in this volume. One problem unlikely to be entirely overcome is the lack of uniformity in just what is meant by a 'species'. In addition to difficulties with respect to this basic unit of measurement, there are also a number of confusions that tend to arise from the different aims of various types of research in the biodiversity arena. 'Assessments' and 'appraisals' of various types usually have objectives that make them unsuitable sources of data appropriate for use as building blocks with respect to broad-scale species-richness patterns.

3.1.2.6 The tools for the job

The tools required to inventory the Earth's biota are currently grossly inadequate. This issue has been addressed by many authors (e.g. May 1994b; Gaston and May 1992; Hawksworth and Ritchie 1993) and is discussed in the GBA in Sections 7.4 and 8.10. The inadequacy of the taxonomic resource base currently devoted to discovering, describing and understanding the species of organisms found on Earth, is especially noteworthy (*Systematics Agenda 2000* 1994). Removing this 'taxonomic impediment' is a clear imperative.

We are on the brink of substantially increasing our real understanding of the globe's major species-richness patterns but the overall scale of global species richness and how this richness is broadly distributed, taxonomically and geographically, continue to be regarded as questions of

minor significance by some. And yet, a sound appreciation of these patterns is essential if ideas about the way in which they originated and are maintained (see Section 4) are to be put to any serious test. Nevertheless, even now the number of species of organisms inhabiting the Earth can probably be estimated with some confidence to within about an order of magnitude, the principal centres of richness and endemism (see 3.2 and 3.3) are probably already known, and there are good prospects of this position rapidly improving. As well as obtaining the resources needed to expedite this task, the scientific community now needs to focus on distinguishing the irrelevant and the unsubstantiated from the pertinent and the sound with respect to opinion and data on patterns of biological diversity. Their organizational abilities too need to be directed to communicating the results of good science in this area as promptly and widely as possible.

3.1.3 Genetic diversity

In its broadest sense, genetic diversity embraces the diversity found at all levels of the taxonomic or ecological hierarchies. Species diversity, for example, may be assessed with greater resolution in genetic terms. In practice, however, in the absence of detailed information on the genetic make-up of most species and populations, there is unlikely to be any useful way of quantifying or summing the genetic diversity of large units such as, for example, ecosystems. The main focus of attempts to quantify genetic diversity is thus at the levels of species, populations and individuals. The various ways in which genetic diversity can be characterized or quantified, and the techniques for doing so, are described in Section 2.2, while the role of genetic variability in generating and maintaining the diversity of life is the subject of Section 4.2.

Each species contains an enormous quantity of genetic information. The number of genes ranges from around 1000 in bacteria and 10 000 in some fungi to 400 000 or more in many flowering plants and some animals. The full information contained in the genes of a typical mammal, if translated into ordinary sized letters of printed text, would just about fill all 15 editions of the *Encyclopaedia Britannica* published since 1768 (Wilson 1988).

Genetic diversity can be viewed and compared at three levels:

1. genetic variability between individuals within populations,
2. genetic variability among populations within species, and
3. diversity among species.

The relative proportions of the diversity that are contained at these three levels depend on the evolutionary

Table 3.1-3: Average total expected heterozygosity (H) and the portion of the total heterozygosity due to differences among populations (G_{ST}) in major taxonomic groups (after Ward *et al.* 1992).

	$H \pm SE$	No. of species	$G_{ST}^2 \pm SE$	No. of species
Vertebrates				
Mammals	0.067 ± 0.005	172	0.242 ± 0.030	57
Birds	0.068 ± 0.005	80	0.076 ± 0.020	16
Reptiles	0.078 ± 0.007	85	0.258 ± 0.050	22
Amphibians	0.109 ± 0.006	116	0.315 ± 0.040	33
Fishes	0.051 ± 0.003	195	0.135 ± 0.021	79
Invertebrates				
Insects	0.137 ± 0.004	170	0.097 ± 0.015	46
Crustaceans	0.052 ± 0.005	80	0.169 ± 0.061	19
Molluscs	0.145 ± 0.010	105	0.263 ± 0.036	44
Others	0.160 ± 0.016	15	0.060 ± 0.021	5

Table 3.1-4: Allozyme variability in plant groups with various life history attributes (from Brown and Schoen 1992; Hamrick and Godt 1990).

Life history category	No. of species	H_T	H_S	$G_{ST} (F_{ST})$
Mating system (pollination)				
Selfing	78	0.12	0.07	0.51
Mixed				
Animal	60	0.12	0.09	0.22
Wind	9	0.19	0.20	0.10
Outcrossing				
Animal	124	0.17	0.12	0.20
Wind	102	0.16	0.15	0.10
Geographic range				
Endemic	52	0.10	0.06	0.25
Narrow	82	0.14	0.11	0.24
Regional	180	0.15	0.12	0.22
Widespread	85	0.20	0.16	0.21

1. Total expected heterozygosity calculated from alleles pooled over samples within species.
2. Proportion of the total expected heterozygosity due to allele-frequency differences among populations.

rates of the proteins or DNA used to measure the variability, on the breeding system, and on the degree of connectivity between populations. The relative proportions of variation between and within populations hold important implications for conservation programmes, as discussed in Section 13. Molecular studies show that most species harbour a wealth of genetic variability (see Section 2.2.0) that may be assessed at the level of individual genetic loci or the genome as a whole (see Section 4.2.2).

3.1.3.1 Animal genetic diversity

For allozyme data, the average expected heterozygosity (H , the proportion of loci that carry two different alleles) in invertebrate species ($= 0.122 \pm 0.004$) is greater than in vertebrates (0.071 ± 0.002 , Table 3.1-3). The chief reason is that more complex organisms tend to have more subdivided populations than less complex ones, and larger populations harbour more genetic variability than small populations at drift-mutation equilibrium. Generally, mammals, birds and reptiles have similar overall levels of genetic variability, whereas amphibians have higher levels and fishes lower levels (Ward *et al.* 1992). Within each group, however, levels of genetic diversity vary considerably because different life-history patterns produce

different amounts of gene flow and different population sizes.

Total heterozygosity in a species comprises two components: genetic variability among individuals within populations and variability among populations. A commonly used measure of among-population variability is F_{ST} (or G_{ST}), the proportion of the total expected heterozygosity due to allele-frequency differences between populations (see Section 4.2.2). The mean value of F_{ST} is largest for some molluscs, amphibians, reptiles and mammals; that is, populations of most species in these groups show considerable amounts of population subdivision. About 25–30% of the total variability in the average species is due to genetic differences among populations. However, values of F_{ST} are highly variable, ranging from 0.0 (no variability among populations) to near 1.0 (fixed allele-frequency differences). Birds and insects, on the other hand, tend to show less variability among populations, presumably because of high levels of gene flow between them (Avisé and Aquadro 1982). On average, only 1–10% of the total variability in a bird or insect species is characteristically due to differences among populations. Thus, an understanding of the geographic distribution of genetic diversity is vital to managers faced with decisions about which subpopulations of a threatened species most warrant protection (Waples 1991). Unfortunately, the required genetic information is often lacking.

3.1.3.2 Plant genetic diversity

A larger number of mating systems produces a richer variety of population genetic structures in plants than in

animal species (Hamrick and Godt 1990). For example, wind-pollinated species have higher levels of heterozygosity ($H_S = 0.15$ to 0.20) within populations, on average, than do animal-pollinated plants ($H_S = 0.09$ to 0.12), and both of these groups have higher levels than self-pollinated plants ($H_S = 0.07$) (Table 3.1-4). Because of restricted gene flow between populations, selfing plants show a greater degree of genetic differences amongst populations ($F_{ST} = 0.51$) than species with mixed breeding systems ($F_{ST} = 0.10$ to 0.22) or outcrossing species ($F_{ST} = 0.10$ to 0.20). The geographic range of a plant species is also an important parameter controlling the amount of genetic diversity within and between populations. Plant species with small geographic ranges harbour less genetic variability within populations on average ($H_S = 0.06$) than those with 'narrow' ($H_S = 0.11$), regional ($H_S = 0.12$) or widespread ($H_S = 0.16$) distributions. The importance of allozyme variability in influencing adaptive traits is largely unknown. Experimental studies suggest that there are larger differences among populations in genes that influence adaptively important traits (Bradshaw 1984).

Cultivated species that have been selected for specific traits often have reduced levels of genetic variability, which can make them vulnerable to diseases and inbreeding depression. For example, resistance to downy mildew (*Sclerospora graminicola*) in pearl millet is absent in most cultivars, but was found in related wild strains in Nigeria, the crop's centre of origin. Similarly, resistance to potato viruses, bacteria, fungi and nematodes has been found in wild species of potatoes (*Solanum*) in the Andes Mountains of South America. Genetic diversity in wild species related to domesticated plants must be maintained so that it can be used to improve the characteristics of domesticated plant species (see 3.1.4.6).

3.1.3.3 Other organisms

The extent of genetic diversity in groups other than certain well-studied plant and animal species cannot be assessed accurately at this time. However, it is clear that the extent of such diversity in the fungi and bacteria particularly is considerable, and that it might even exceed that in macro-organisms. Examples of the genetic variation already documented within single microbial species are *Chlamydomonas reinhardtii* with at least 159 mutant lines, *Neurospora crassa* with over 3000, and over 3500 serological types of *Salmonella* (Board on Agriculture 1994). The extent to which such phenomena are widespread in nature is uncertain, but the variation in secondary metabolites of fungal strains isolated from nature is sufficient to have acted as a spur to the isolation of strains for screening programmes.

3.1.4 Domesticated diversity

Domesticated species represent a small fraction of the Earth's biota, but these relatively few organisms provide

well over 90% of human food supplies, as well as meeting many other human needs (see Sections 2.2 and 8.8). Domestication is the process (see Section 2.2.2 for a fuller discussion) by which plants, animals or microbes selected from the wild, adapt to special habitats, created for them by humans. These organisms, or domesticates, breed in captivity for human profit and under at least a degree of human control (Clutton-Brock 1987; Balain 1991; Hemmer 1990). Since the dawn of agriculture, at least 10 000 years ago, plants have been taken into cultivation by humans, many of them chosen for their cooking qualities, tastes or aromas (food plants). Others have been selected for their healing properties, as ornamentals, or in order to use their fibres or woody parts for a variety of purposes. While the first animal domesticate was the dog, other early animal domesticates were kept in flocks and herds so that they could be used as a source of food. Sheep and goats were probably the first of these, followed by cattle and pigs, and finally the horse (Clutton-Brock 1987). Domesticated microbes (see Section 2.2) include microbial variants or strains used to make antibiotics and vaccines, as well as those traditionally used to make bread, cheese and wine.

3.1.4.1 Sources and centres of domesticated biodiversity

Domesticated biodiversity may be characterized (see Section 2.2.2.1) as the genetic variation existing among the species, breeds, cultivars and individuals of animal, plant and microbial species that have been domesticated, often including their immediate wild relatives. The term may be extended to include ecosystem diversity where this is dominated by domesticates (Hammond in press).

Although the first genetic changes may have occurred by natural selection, leading in animal domesticates, for example, to adaptation to confinement, increase in tameness, and ease of breeding in captivity, domestication has traditionally been accomplished by selective breeding. Continued artificial selection (see Section 2.2.2) has resulted in an enormous number of different animal breeds, each characterized by its unique adaptive traits and useful properties, but without excessive loss of fitness or adaptability (Mace 1990; Balain 1991).

As with animal species, the diversification of crop plants has been dependent upon the existence of genetically different forms on which selection could act, and in addition to the automatic selection pressures, humans have intervened by applying deliberate and intentional processes of selection. In most crop plants, diversity is generated through hybridization and recombination processes between different forms, wild or cultivated. Although in a particular genotype mutations may add to diversity, these are comparatively rare, and in most cases disadvantageous (Bunting 1990). Most fruit and nut trees were brought into domestication by changing the reproductive biology of the plants involved, by

Table 3.1-5: Areas where plants and animals were domesticated. The names in parentheses show that the same species was probably domesticated independently in different areas (from Harlan 1976).

North America	Highland South America	African rice	Goat	Soybean
<i>Plants</i>	<i>Plants</i>	Sorghum	Dromedary	Cabbage
Sunflower	Potato	Pearl millet	(Cattle)	Onion
Tepary bean	Peanut	Yam	(Pig)	Peach
<i>Animals</i>	Lima bean	Watermelon		(Foxtail millet)
Turkey	(Cotton bean)	Cowpea	Central Asia	<i>Animals</i>
	(Cotton)	Coffee	<i>Plants</i>	(Cattle)
Mesoamerica	<i>Animals</i>	(Cotton?)	Common millet	(Pig)
<i>Plants</i>	Llama	(Sesame?)	Buckwheat	(Duck)
Maize	Alpaca	<i>Animals</i>	Alfalfa	
Tomato	Guinea pig	Donkey	Hemp	Southeast Asia
Sieva bean		Guinea fowl	(Foxtail millet)	<i>Plants</i>
Scarlet runner bean	Northern Europe	(Duck)	(Grapes)	Oriental rice
Cotton	<i>Animals</i>	(Goose)	Broad bean?	Banana
Avocado	Reindeer	Near East	<i>Animals</i>	Citrus
Papaya		<i>Plants</i>	Horse	Yam
Cacao	Europe	Wheat	Bactrian camel	Mango
(Cassava)	<i>Plants</i>	Barley	Yak	Thin sugarcane
(Sweet potato)	Oats	Onion	India	Taro
(Common bean)	Sugarbeet	Pea	<i>Plants</i>	Tea
<i>Animals</i>	Rye	Lentil	Pigeonpea	<i>Animals</i>
Muscovy duck	Cabbage	Chickpea	Egg plant	Mithan
(Turkey)	(Grapes)	Fig	Cucumber	Banteng
	(Olive)	Date	(Cotton?)	(Chicken)
Lowland South America	<i>Animals</i>	Flax	(Sesame?)	(Buffalo)
<i>Plants</i>	(Cattle)	Pear	<i>Animals</i>	(Pig)
Yam	(Pig)	Pomegranate	(Cattle)	
Pineapple	(Duck)	(Grapes)	(Buffalo)	South Pacific
(Cassava)	(Goose)	(Olive)	(Chicken)	<i>Plants</i>
(Sweet potato)		Apple?		Noble sugarcane
(Cotton)	Africa	<i>Animals</i>	China	Coconut
	<i>Plants</i>	Sheep	<i>Plants</i>	Breadfruit

shifting from sexual reproduction in the wild to vegetative propagation under cultivation. As a rule, cultivated varieties of fruit trees are maintained vegetatively by cuttings, rooting of twigs, suckers, or grafting, and are seldom raised from seed. This is because wild populations and cultivated varieties maintain high levels of heterozygosity, so that seedlings raised from any mother tree segregate widely in numerous traits. Consequently, and in order to prevent genetic segregation, growers have used vegetative propagation to 'fix' desired types (Zohary and Hopf 1993).

Recent advances in molecular biology have enhanced the opportunities for genetic modification of organisms, and speeded up the process of production and selection of new varieties, particularly of microorganisms. New technologies allow the directed production of specific genotypes, sometimes producing specific combinations of genes from organisms that cannot otherwise recombine sexually, e.g. recombinant bacteria (Lenski 1993).

Many plant species now important as crops were first domesticated in (a relatively few) parts of the world often

described as 'Vavilov centres' (see Section 2.2.2). These putative centres of origin are often coincident with centres of diversity within crop species. However, it is now recognized that diversity in a field population or in a region does not necessarily prove that the crop was originally domesticated from wild progenitors that occurred nearby (Harris 1990). For example, there are highly diverse populations of *Phaseolus vulgaris* in Malawi, but there is no doubt that the species was domesticated in the Americas (Bunting 1990).

Centres of origin for animal domesticates, many of them the same as for plants, are also now well established (see Table 3.1-5; 3.2.1.4). Recent studies using archaeological, linguistic and molecular evidence have further documented how plants and animals were domesticated, and how agriculture was developed earlier in some regions of the world than in others (Harris and Hillman 1989). The question of the extent to which agriculture evolved in discrete centres or more or less simultaneously over large areas is considered by Harlan (1971, 1976), Zeven and de Wet (1982), Hawkes (1983), and Harris (1990).

3.1.4.2 Domesticated plant diversity

Of the 511 plant families currently recognized (Brummitt 1992), only 173 have domesticated representatives. Of these, the Gramineae has the largest number of domesticated species with 379 (15.2% of all plant domesticates), mostly originating from the Near East or Africa. The family Leguminosae follows with 337 species (13.5%) of varied origin, including the Indochina–Indonesia region, the Mediterranean coast and adjacent regions, and Central America. Rosaceae ranks third with 158 species, mainly from China and Europe–Siberia; and Solanaceae fourth with 115 species (4.6%), mostly from Central America and Bolivia–Peru–Chile. A notable contribution of domesticates has also been made by the Compositae (with 86 species), Cucurbitaceae (53 species), Labiatae (52 species), Rutaceae (44 species), Cruciferae (43 species), Umbelliferae (41 species), Chenopodiaceae (34 species), Zingiberaceae (31 species), and Palmae (30 species). However, many (about 48) plant families include only one domesticated species (for further information see Zeven and de Wet 1982).

Despite this relatively large number of plant domesticates, 90% of national per capita supplies of food plants come from only 103 species (Prescott-Allen and Prescott-Allen 1990). The most significant of these are domesticated Gramineae (cereals), annual grasses cultivated for their grains. These, together with Leguminosae (legumes), have been the principal crops of most civilizations, and represent the main source of calories. Wheat (*Triticum* spp.) and barley (*Hordeum vulgare*) have been the traditional staples of Europe and western Asia, with the first signs of cultivation appearing in the Near East region in the second half of the 10th

millennium BP. Two more early domesticates were rye (*Secale cereale*) and common millet (*Panicum milliaceum*), followed later by oats (*Avena sativa*). Sorghum (*Sorghum bicolor*) was first domesticated in the African savannah belt, and rice (*Oryza sativa*) in South Asia. The earliest archaeological evidence for the cultivation of these plants is not until the 5th–4th millennium BP and 7th millennium BP, respectively (Zohary and Hopf 1993). Potatoes, maize, *Phaseolus* beans and other New World crops were domesticated by about 7000 BP, and probably earlier.

If we look at biodiversity in terms of species numbers, of the estimated total of 320 000 vascular plants (Fig. 3.1-2), about 3000 are regularly exploited for food. Most of these, some 2500, are domesticated, but only 15–20 are the crops of major economic importance (see Table 2.3 in Ford-Lloyd and Jackson 1986). The distribution ranges of these crops extend across continents, oceans and hemispheres, and show the great diversity of habitats to which migrating crops have adapted over the last 10 000 years.

Within individual species, the extent of selection pressure which humans have applied is illustrated well by *Brassica oleracea*, from which at least seven distinct types of vegetable have been produced. Selection for enlarged terminal buds produced the cabbage; for inflorescences, the cauliflower and broccoli; for the stem, narrow stem kale; for stem tubers, kohlrabi; for lateral buds, Brussels sprouts; for the stem and flowers, calabrese; and for the leaves, kale. Of these, kale most closely resembles the wild plant (Harlan 1976; see also box in Heywood and Chant 1982).

Although the majority of domesticated plants are used as sources of food, some were taken into cultivation for their fibres. In the Old World, two species of cotton (*Gossypium arboreum* and *G. herbaceum*) were the most commonly cultivated plants used for weaving cloth, together with hemp (*Cannabis sativa*) (Zohary and Hopf 1993), although flax (*Linum usitatissimum*) was probably the first to be cultivated. Today jute (*Corchorus* spp.) is perhaps the most important textile fibre after cotton and was domesticated relatively recently to replace hemp. In the New World two species in the family Agavaceae (*Furcraea foetida* and *F. macrophylla*), several species of Malvaceae (*Abutilon oxycarpum*, *Wissadula contracta* and *W. periplocifolia*) and up to six different species of cotton (*Gossypium* spp.) are sources of fibre, and are now cultivated for this purpose elsewhere (Zeven and de Wet 1982).

At least 25 000 plant species in all are thought to be used or have been used for medicinal purposes, but only a few of these are grown as crops. Two examples from the Rubiaceae are *Cephaelis ipecacuanha*, used as a source of ipecac or ipecacuanha to treat amoebic dysentery, and *Cinchona ledgeriana* – with numerous cultivars – a source of quinine for treating malaria (Akerle *et al.* 1991). Others such as thyme, lavender and sage are cultivated as aromatic plants or for culinary purposes, as are numerous spice plants.

Ornamentals, mostly of wild origin but many extensively bred and modified, are also an important and numerous group. For example *The European Garden Flora* project plans to include about 12 000 species, mainly found in cultivation in botanic gardens and specialists collections in Europe. However, at present no complete global inventory of these species exists (Heywood 1992).

Although conventional agriculture and forestry has traditionally concentrated on major crops, tens of thousands of other plants are known to have edible properties. Most of these and many additional species with other useful properties remain undomesticated. Apart from this reservoir of potential future crops, wild plants retain an exceptional importance for agriculture, as wild genetic resources are the key to future production of existing crops. With the help of genetic manipulation and similar new technologies, many crop plants are able to acquire genes from wild species, and develop resistance to pests and diseases (de Groot 1992). Scoones *et al.* (1992) and Wickens *et al.* (1989) cover much of the literature relating to the role of wild foods in agricultural systems, and other under-exploited species respectively and a series of volumes on promising plant species of the Andean sub-region is being published (Correa and Bernal 1990).

3.1.4.3 Domesticated animal diversity

Of the 50 000 vertebrate species, some 30–40 species of mammals and birds comprise a core group of animal domesticates. In addition to dogs and cats, four of the domesticates used as food are found almost everywhere humans have set foot, except for the Antarctic. They are cattle (*Bos indicus* and *B. taurus*), sheep (*Ovis aries*), pigs (*Sus domesticus*) and chickens (*Gallus domesticus*). The global populations of the three dominant mammals are exceptionally large: cattle 1300 million; sheep 1200 million; pigs 850 million. These numbers are exceeded only by chickens, of which there are more than 10 billion world-wide. These wide distributions and vast numbers indicate the unique contribution of these four species to the quality of life in almost all human cultures. Two of the dominant species, one larger (cattle) and one smaller (sheep) are ruminants, whereas pigs and chickens have simple digestive tracts. Two other numerically important ruminants are the domestic buffalo (*Bos bubalus* with its two subspecies, riverine and swamp), and the goat (*Capra hircus*), both of which are also very important in their more specialized locations. Most of the other species in the group of 30–40 are found only in restricted locations. They include species such as the Arabian camel (*Camelus dromedarius*), bactrian camel (*Camelus bactrianus*), Andean camelid species (*Llama* and *Vicuna* spp.), reindeer (*Rangifer tarandus*), yak (*Peophagus grunniens*), mithun (*Bos/Bibos frontalis*) and Bali cattle (*Bos javanicus*) and, of course, a number of bird species. Even with the inclusion

of the species regarded as 'exploited captives' rather than true domesticates (Clutton-Brock 1987) such as the Asian elephant, small mammals reared for their fur or kept for other purposes (e.g. the ferret and laboratory rats/mice), various pets and cage birds such as canaries, the number of domesticated species of animals is still small when contrasted with the large number of crop plant species.

These facts may suggest at first sight that the biodiversity of livestock and avian species is somewhat limited. However, over thousands of years an enormous number of different breeds have been developed within each of the major livestock species, each characterized by its unique adaptive and productive traits. For example, Loftus and Scherf (1993) list nearly 800 distinct breeds of cattle and more than 800 different breeds of sheep (and the number recognized by Hall and Ruane (1993) is still higher – see Section 2.2.2.1). Many of these breeds are specially adapted to one of the many environments, differing in climate, topography and vegetation, in which humans live. In addition, a large number of breeds are also recognized in dogs, cats and other species not reared for food, such as pigeons.

Today, in the developed world the livestock sector is responsible for over half the economic output of agriculture. Furthermore, domestic animals in advanced societies also contribute to quality clothing, speciality foods, and to recreation and sport. In developing countries, which generally consume less animal produce per capita (though this is increasing rapidly in many advancing societies, for example in Asia), domestic animals still serve billions of people with important benefits in addition to food. The most important of these is undoubtedly draught animal power. Others include wool, leather, tallow, bone and manure for fuel and for increasing the fertility of cropland. Without the biodiversity and adaptive qualities of domestic animals the majority of humankind in the developing world would still be subject to hard physical labour for crop cultivation and for other traction needs. The large domestic ruminant species, of which the cow and the buffalo are the most numerous, demonstrate particularly well the integration of animal biodiversity with human culture. In addition to provision of labour and milk products and meat for the adult population, the cow and buffalo provide some key benefits such as milk for infants and a backup food reserve in times of leanness and poor crop harvests.

3.1.4.4 Domesticated aquatic biodiversity

Aquaculture is another important aspect of domesticated diversity, with nearly 200 species reared in 136 countries. Species included are freshwater, diadromous and marine fish, molluscs, crustaceans, frogs, turtles and aquatic plants. Aquaculture, with particularly significant contributions from China and Japan, yields over 12 million tonnes

Table 3.1-6: Status of crop germplasm collections (Adapted from Lyman 1984 and Plucknett et al. 1987).

Crop	Number of accessions	Number of distinct samples	Number of collections of 200+ accessions	Number of landraces	Coverage (%) ¹ wild species	Proportion of collected types endangered
Cereals						
Wheat	410 000	125 000	37	95	60	High
Barley	280 000	55 000	51	85	20	Low
Rice	215 000	90 000	29	75	10	2-3
Maize	100 000	50 000	34	95	15	<1
Sorghum	95 000	30 000	28	80	10	100
Oats	37 000	15 000	22	90	50	
Pearl millet	31 500	15 500	10	80	10	High
Finger millet	9 000	3 000	8	60	10	High
Other millets	16 500	5 000	8	45	2	
Rye	18 000	8 000	17	80	30	
Pulses						
Phaseolus	105 000	40 000	22	50	10	Mod-high
Soybean	100 000	18 000	28	60	30	Moderate
Groundnut	34 000	11 000	7	70	50	Mod-high
Chickpea	25 000	13 500	15	80	10	High
Pigeonpea	22 000	11 000	10	85	10	Moderate
Pea	20 500	6 500	11	70	10	
Cowpea	20 000	12 000	12	75	1	High
Mungbean	16 000	7 500	10	60	5	High
Lentil	13 500	5 500	11	70	10	Moderate
Faba bean	10 000	5 000	10	75	15	Moderate
Lupin	3 500	2 000	8	50	5	Mod-high
Root crops						
Potato	42 000	30 000	28	95	40	90
Cassava	14 000	6 000	14	35	5	Moderate
Yam	10 000	5 000	12	40	5	Moderate
Sweet potato	8 000	5 000	27	50	1	Moderate
Vegetables						
Tomato	32 000	10 000	28	90	70	n.a.
Cucurbits	30 000	15 000	23	50	30	n.a.
Cruciferae	30 000	15 000	32	60	25	n.a.
Capsicum	23 000	10 000	20	80	40	n.a.
Allium	10 500	5 000	14	70	20	n.a.
Amaranth	5 000	3 000	8	95	10	n.a.
Okra	3 600	2 000	4	60	10	n.a.
Eggplant	3 500	2 000	10	50	30	n.a.

Industrial crops

Cotton	30 000	8 000	12	75	20	n.a.
Sugar cane	23 000	8 000	12	70	5	n.a.
Cacao	5 000	1 500	12	*	*	n.a.
Beet	5 000	3 000	8	50	10	n.a.

Forages

Legumes	130 000	n.a.	47	n.a.	n.a.	n.a.
Grasses	85 000	n.a.	44	n.a.	n.a.	n.a.

1. Coverage percentages are estimates derived from scientific consensus. For wild gene pools coverage relates primarily to those species in the primary gene pool, i.e. species that were either progenitors of crops, have coevolved with cultivated species, continuously exchanging genes, or are otherwise closely related.

n.a. Data not available.

* Coverage difficult to estimate because many selections are from the wild.

globally per annum (de Groot 1992). However, although some aquatic species have been exploited continuously from early historic times, few of them truly qualify as domesticates.

3.1.4.5 Domesticated microbial and invertebrate diversity

Interest in microbial and invertebrate diversity in recent years, fuelled by the increasing recognition that vast numbers of insects, bacteria and fungi remain unknown (see 3.1.2.4), has focused on the known and potential value of these organisms to humans, particularly as sources of food and drugs. Their role in sustainable agriculture, for example as biological control agents, and in the detoxification of industrial waste, has also been highlighted (Hawksworth 1991a, b; Jones 1993).

To date, only a tiny proportion of the 72 000 or so described species of fungi and an even smaller proportion of the possible one and a half million or so that exist (see Fig. 3.1-2) have been traditionally used by humans. Of these the most important are yeasts, moulds and mushrooms. Mushrooms were regarded as a delicacy by the Greeks and the Romans, and the first detailed records of their cultivation occurred in the beginning of the eighteenth century, when the French scientist Tournefort described a successful method for growing mushrooms in stable manure (Smith 1993). Their exploitation has now spread to most industrialized countries, with a total annual production now in excess of 1.42 million tonnes (Smith 1993). In addition to *Agaricus bisporus* (the white button mushroom), several other species have been commercially exploited, e.g. *Lentinus edodes* and several species of *Pleurotus*, *Volvariella*, *Auricularia*, *Flammulina* and *Tremella*.

Microorganisms are also used in the processing of dairy products, such as cheese, yoghurt and other fermented

milks and butter. Of these, species of the bacterial genera *Lactobacillus*, *Lactococcus*, *Leuconostoc* and *Streptococcus* are most important, together with yeasts such as *Kluyveromyces marxianus* and *Candida kefir*, and moulds such as *Penicillium camembertii* and *P. roquefortii* (Varnam 1993a).

Other fungal groups are involved in the beneficial fermentation of non-dairy food products. Several zygomycetous species of the genus *Rhizopus* are traditionally used in Indonesia for the fermentation of yellow-seeded soya beans to produce 'tempe', which serves as a protein complement to starchy staples. Natural pigments produced by species of the ascomycete genus *Monascus* are also beginning to be widely used as food additives, in place of synthetic compounds (Samson 1993).

Fungi as well as bacteria have been used traditionally in the manufacture of alcoholic beverages, another very highly profitable industry. The most important of these include: *Saccharomyces cerevisiae*, *S. carlsbergensis* and *Schizosaccharomyces pombe*, used in the fermentation of ale-type beer and wine, lager-type beer, and heavy rum respectively; *Aspergillus oryzae* used in the fermentation of sake; and lactic acid bacteria, *Clostridium* spp. and *Enterobacteriaceae* also in the fermentation of beer, wine and rum (Varnam 1993b).

An additional role for microorganisms – in the production of pharmaceuticals – burgeoned following the discovery in the late 1920s of the metabolites produced by the fungus *Penicillium chrysogenum*, and was further encouraged by the discovery in 1949 of cephalosporin produced by another fungus, *Acremonium chrysogenum*. Such metabolites are now known to be produced by about 5000 (c. 7%) of described fungi species, but the search for new drugs and new microbes of use in biotechnology now extends to as yet uncharacterized species. The maintenance

Table 3.1-7: Biodiversity at risk for major food crops (based on Oldfield 1992 with additional data).

Family	Species	Conservation status
GRAMINEAE	<i>Avena sativa</i> (oats)	Unknown
	<i>Hordeum vulgare</i> (barley)	Concern about genetic erosion
	<i>Oryza glaberrima</i>	Many wild relatives lost, especially of <i>O. glaberrima</i>
	<i>O. sativa</i> (rice)	
	<i>Panicum miliaceum</i> (common millet)	Unknown in the wild
	<i>Saccharum officinarum</i> (sugarcane)	Wild relatives lost due to habitat destruction
	<i>Secale cereale</i> (rye)	Unknown
	<i>Sorghum bicolor</i> (sorghum)	Unknown
	<i>Triticum aestivum</i>	Wild relatives restricted to small area
	<i>T. turgidum</i> (wheat)	(need <i>ex situ</i> conservation)
	<i>Zea mays</i> (maize)	Rediscovery of wild relatives; under protection
LEGUMINOSAE	<i>Arachis hypogaea</i> (groundnut)	Unknown; conservation priority
	<i>Cajanus cajan</i> (pigeonpea)	Unknown
	<i>Cicer arietinum</i> (chickpea)	Threatened or rare
	<i>Glycine max</i> (soybean)	Traditional landraces destroyed by modern cultivars; conservation priority
	<i>Lens culinaris</i> (lentil)	Unknown
	<i>Phaseolus vulgaris</i> (haricot bean)	Wild relatives widespread, but some forms need conservation
	<i>Pisum sativum</i> (pea)	Conservation measures limited
	<i>Vicia faba</i> (broad bean)	Unknown
ROSACEAE	<i>Fragaria × ananassa</i> (strawberry)	Unknown
	<i>Malus pumila</i> (apple)	High conservation priority (IPGRI)
	<i>Prunus amygdalus</i> (almond)	Protected
	<i>Prunus armeniaca</i> (apricot)	Protected
	<i>Prunus avium</i> (cherry)	Unknown
	<i>Prunus domestica</i> (plum)	Unknown
	<i>Prunus persica</i> (peach)	Unknown
	<i>Pyrus communis</i> (pear)	Conservation priority (IPGRI)
SOLANACEAE	<i>Capsicum annuum</i> (chili and sweet pepper)	More collection for seed banks needed
	<i>Lycopersicon esculentum</i> (tomato)	Gene pool eroded due to habitat destruction
	<i>Solanum melongena</i> (eggplant)	Unknown
	<i>Solanum tuberosum</i> (potato)	150 wild species; 3000–5000 varieties recognized; conservation priority (CIP)
COMPOSITAE	<i>Carthamus tinctorius</i> (safflowerseed)	The wild relative <i>C. rhiphaeus</i> is rare
	<i>Cynara scolymus</i> (artichoke)	Unknown
	<i>Helianthus annuus</i> (sunflower)	Some preserved; but many still threatened by habitat destruction
	<i>Lactuca sativa</i> (lettuce)	Unknown

CUCURBITACEAE	<i>Cucumis melo</i> (melon/watermelon)	Unknown
	<i>Cucumis sativus</i> (cucumber)	Unknown
	<i>Cucurbita maxima</i> (pumpkin); <i>C. moschata</i> (squash); <i>C. pepo</i> (gourd)	Restricted ranges
LABIATAE	<i>Coleus</i> spp. (Kaffir & Hausa potato)	Unknown
	<i>Ocimum kilimandscharicum</i> (camphor)	Unknown
RUTACEAE	<i>Citrus</i> spp.: <i>C. aurantifolia</i> (lime); <i>C. grandis</i> (pomelo); <i>C. limon</i> (lemon); <i>C. sinensis</i> (orange)	High priority
CRUCIFERAE	<i>Brassica oleracea</i> (cabbage)	Threatened; high priority
	<i>B. napus</i> / <i>B. rapa</i> (rapeseed)	Unknown
	<i>B. juncea</i> (mustardseed)	Large collections available
UMBELLIFERAE	<i>Daucus carota</i> (carrot)	Unknown
CHENOPODIACEAE	<i>Beta vulgaris</i> (sugarbeet)	Threatened
	<i>Spinacea oleracea</i> (spinach)	Unknown
	<i>Chenopodium quinoa</i> (quinoa)	Unknown
ZINGIBERACEAE	<i>Anomum cardamomum</i> (cardamon)	Unknown
	<i>Curcuma heyneana</i> (arrowroot)	Unknown
	<i>Zingiber zerumbet</i> (ginger)	Unknown
PALMAE	<i>Cocos nucifera</i> (coconut)	Genetic erosion in cultivated hybrids
	<i>Phoenix dactylifera</i> (date)	Vulnerable
	<i>Elaeis guineensis</i> (oil palm)	High priority

of microorganismal diversity in the wild (and thereby the array of chemicals they produce) is thus vital for future prospecting (Hawksworth 1991a; Nisbet and Fox 1991).

The part played by microorganisms and invertebrates in sustainable agriculture has also grown in recent years. Some are employed as biological control agents, some as biopesticides, and others for increasing soil fertility (see Hawksworth (1991c) and Jones (1993) for examples). Used for some 50 years as a biopesticide, *Bacillus thuringensis* now accounts for 2.5% of total insecticide production (Dent 1993). However, sales of biological control agents still represent only 1% of the total world market of crop protection products. Enormous scope exists for the development of new beneficial products in this area.

3.1.4.6 Domesticated biodiversity at risk

The diversity of cultivars in many crop plants reached its peak at around the end of the nineteenth century; perhaps somewhat later for some tropical crops. However, this

diversity is now at risk, and the genetic variation (or gene pool) of many crops is eroding. This is due mainly to the development during this century of very uniform cultivars, grown in very uniform environments, created by using the same sophisticated agricultural practices throughout. This would not be much of a problem if the uniformity of crops were not an important factor in the interactions between crops and their pathogens, leading to epidemic outbreaks of disease, and the need for development of new disease-resistant varieties. In the search for new varieties plant breeders are obliged to look outside the narrow gene pool of modern varieties, and rescue forgotten genes from older varieties, or even from wild relatives of the crop. Holden *et al.* (1993) provide various examples of how genetic resources have provided the solution to disease epidemics in major crops such as potato, rice, sweet potato, wheat, maize, sugar beet and rubber.

The total number of cultivated varieties of crops or breeds of livestock is not fully known. Some indication of

Table 3.1-8: World-wide numbers of breeds of the common domestic species of mammals. Figures derived from Loftus and Scherf (1993).

Species	Breeds	At risk
Cattle	783	112
Sheep	863	101
Goat	313	32
Pig	263	53
Buffalo	62	1
Horse	357	81
Ass	78	11
Total	2719	391

the diversity present in crops, however, is provided in Table 3.1-6, which lists the number of distinct samples of germplasm collected for major crops, ranging as high as 50 000 to 125 000 for maize, rice, barley and wheat. The magnitude of genetic diversity is also reflected in the substantial numbers of varieties grown in local regions. For example, Andean farmers cultivate thousands of different clones of potatoes, more than 1000 of which have different names. Table 3.1-7, adapted from Oldfield (1992), provides some information on the conservation status of wild relatives of major food crops, and their potential in breeding programmes. Little is known of their vulnerability, but in most cases habitat destruction is likely to be the principal threat. The organizations belonging to the Consultative Group on International Agricultural

Table 3.1-9: World-wide numbers of breeds of the common domestic species of mammals in each region. Figures derived from Loftus and Scherf (1993).

Region	Breeds	At risk
Western Europe	731	218
Former USSR	327	57
Asia	746	51
Africa	297	9
North and Central America	169	30
Latin America	165	23
Near East	284	3
Total	2719	391

Research (CGIAR) have active programmes to preserve at least some of this biodiversity (see Section 8.8.5 and Box .8-1).

The number of breeds at risk by species and by region is given in Tables 3.1-8 and 3.1-9, following Loftus and Scherf (1993), although different and generally rather higher figures are given by Hall and Ruane (1993; and see Section 2.2.2.1). In most instances breeds have not been tabulated exhaustively and the true totals are expected to be larger. The numbers of breeds 'At risk' in these tables are determined mainly by breed population size. 'At risk' includes two subcategories, which are broadly defined as 'Critical' if there are fewer than 100 animals and 'Endangered' if there are more than 100 but fewer than 1000. In the absence of population size data (these are currently available for only about one-third of the breeds in regions other than Western Europe and the former USSR) no breed is recorded as being 'At risk'. Figures for many regions are therefore likely to be considerable under-estimates.

Breeds within a species can, of course, be used for crossbreeding. This ability is a potential source both of economic benefit and of genetic erosion. Using an economically superior breed to cross with a less productive indigenous breed can lead to relatively rapid increases in productivity by additive gene effects and also, in certain traits, by heterosis. Compared with trying to introduce a different species for improved livestock production, this crossing option is a tremendous advantage. The down-side is the increasing likelihood that the genetic variation as defined in the genotype of the indigenous breed may disappear quite rapidly.

This process of breed replacement by crossbreeding has occurred on a large scale in Western Europe during the three decades from 1960, with a resultant loss of domesticated biodiversity. Economically important breeds such as the Holstein-Friesian for milk, and the crossbred strains produced by specialist breeding companies for pigs and poultry for both egg and meat production, now dominate the animal production scene in Western Europe and North America. The same trend is slowly taking place in developing countries wherever environmental and management infrastructures permit the change. Thus, many of the original indigenous breeds of domestic livestock in Western Europe are now reduced to small populations. Mason and Crawford (1993) name 97 breeds of cattle, goats, horses, pigs and sheep in Europe which are extinct, and comparable serious losses of genetic diversity are indicated for other regions. The FAO Animal Genetic Resources Data Bank contains information on 198 extinct breeds in regions other than Western Europe, 106 of them in the former USSR (Loftus and Scherf 1993) (see Table 3.1-10).

A very large number of breeds were lost in the former USSR during the period of the command economy. In the

current transitional period 57 breeds remain at risk in the Russian Federation. These are in immediate need of conservation, even though this is unlikely to be easily funded or given high priority in a period of such economic stress. On the other hand, although a large number of breeds (97) have been lost in Western Europe in the thirty-year period 1950–1980, when the conservation of traditional breeds was not given serious attention, the relatively large number of breeds now classified as being at risk in Western Europe because of their small population sizes are nearly all the subject of some form of conservation programme, with live animals held in secured herds and/or semen or embryos stored in deep-freeze facilities.

All of the arguments about loss of biological diversity that are applied to wild species apply also to the loss of genetic diversity in domesticates, plus strong economic and social considerations. There is an obligation to conserve for future generations as much as possible of the biological diversity which has been inherited. The threat to domestic animal biodiversity results from unsustainable practices which, if continued without restriction, regulation or planned sustainability, will inevitably lead to increased depletion and loss of the natural resource base needed for future production. The transfer of unsustainable practices of animal production from the developed to the developing regions and to the countries of the former command economies will inevitably cause even further loss of domestic animal biodiversity unless conservation programmes are instituted and development becomes sustainable.

References

American Association for the Advancement of Science 1993. *Large Marine Ecosystem Stress, Mitigation, and Sustainability*. AAAS Press, Washington, DC.

Akerele, O., Heywood, V.H. and Synge, H. (eds) 1991. *Conservation of Medicinal Plants*. Cambridge University Press, Cambridge.

Andersen, R.A. 1992. Diversity of eukaryotic algae. *Biodiversity and Conservation* **1**: 267–292.

Arroyo, M.T., Kalin, Raven, P.H. and Sarukhan, J. 1992. Biodiversity. In: Dooge, J.C.L., Goodman, G.T., la Rivière, J.W.M., Marton-Lefevre, J., O’Riordan, T. and Praderie, F. (eds), *An Agenda of Science for Environment and Development into the 21st Century*, 204–219. Cambridge University Press, Cambridge.

Avise, J.C. and Aquadro, C.F. 1982. A comparative summary of genetic distances in vertebrates. *Evolutionary Biology* **15**: 151–185.

Bailey, R.G. 1989a. *Ecoregions of the Continents*. U.S. Department of Agriculture, Forest Service, Washington, DC.

Bailey, R.G. 1989b. Explanatory supplement to ecoregions map of the continents. *Environmental Conservation* **16** (4): 307–309.

Balain, D.S. 1991. Biodiversity and animal husbandry. *Biology Education* January-March: 34–46.

Table 3.1-10: Estimates of breeds of domestic mammalian species that are already extinct. Western Europe figures from Mason and Crawford, (1993); other regions from Loftus and Scherf (1993).

Region	Extinct breeds
Western Europe	97
Cattle	9
Goats	4
Pigs	54
Sheep	30
Former USSR	106
Asia	25
Africa	27
North and Central America	18
Latin America	20
Near East	2
Total	295

Barnes, R.D. 1989. Diversity of organisms: how much do we know. *American Zoologist* **29**: 1075–1084.

Barnes, R.S.K. and Hughes, R.N. 1982. *An Introduction to Marine Ecology*. Blackwell, London.

Board on Agriculture 1994 [1993]. *Managing Global Genetic Resources. Agricultural Crop Issues and Policies*. National Academy Press, Washington, DC.

Bradshaw, A.D. 1984. Ecological significance of genetic variation between populations. In: Dirzo, R. and Sarukahn, J. (eds), *Perspectives on Plant Population Ecology*, 213–228. Sinauer Associates, Sunderland, Mass.

Brasier, C.M. 1986. The dynamics of fungal speciation. In: Rayner, A.D.M., Brasier, C.M. and Moore, D. (eds), *Evolutionary Biology of the Fungi*, 231–260. Cambridge University Press, Cambridge.

Brooks, D.R. and McLennan, D.A. 1993. *Parascript: Parasites and the Language of Evolution*. Smithsonian Institution Press, Washington, DC.

Brown, A.H.D. and Schoen, D.J. 1992. Plant population genetic structure and biological conservation. In: Sandlund, O.T., Hindar, K. and Brown, A.H.D. (eds), *Conservation of Biodiversity and Sustainable Development*, 88–104. Scandinavian University Press, Oslo.

Brummitt, R.K. 1992. *Vascular Plant Families and Genera*. Royal Botanic Gardens, Kew.

Brusca, R.C. and Brusca, G.J. 1990. *Invertebrates*. Sinauer Associates, Sunderland, Mass.

Bunting, A.H. 1990. The pleasures of diversity. *Biological Journal of the Linnean Society* **39**: 79–87.

Clutton-Brock, J. 1987. *A Natural History of Domesticated Mammals*. Cambridge University Press, Cambridge and British Museum (Natural History), London.

- Coddington, J.A.** and Levi, H.W. 1991. Systematics and evolution of spiders (Araneae). *Annual Review of Ecology and Systematics* **22**: 565–592.
- Colwell, R.K.** and Coddington, J. 1994. Estimating the extent of terrestrial biodiversity through extrapolation. *Philosophical Transactions of the Royal Society of London, B* **345**: 101–118.
- Correa, Q.J.E.** and Bernal, H.Y. 1990. *Especies Vegetales Promisorias de los Países del Convenio Andrés Bello*. SECAB, Bogotá.
- Dent, D.R.** 1993. The use of *Bacillus thuringiensis* as an insecticide. In: Jones, D.G. (ed.), *Exploitation of Microorganisms*. 19–44. Chapman and Hall, London.
- Dial, K.P.** and Marzluff, J.M. 1988. Are the smallest organisms the most diverse? *Ecology* **69**: 1620–1624.
- Dworkin, M.** 1992. Prokaryote diversity. In: Balows, A., Truper, H.G., Dworkin, M., Harder, W. and Schleifer, K.H. (eds), *The Prokaryotes*, 2nd edn. 48–74. Springer-Verlag, New York.
- Embley, T.M., Hirt, R.P.** and Williams, D.H. 1994. Biodiversity at the molecular level: the domains, kingdoms and phyla of life. *Philosophical Transactions of the Royal Society, B* **345**: 21–33.
- Erwin, T.L.** 1982. Tropical forests: their richness in Coleoptera and other arthropod species. *Coleopterists Bulletin* **36**: 74–75.
- Erwin, T.L.** 1991. How many species are there? Revisited. *Conservation Biology* **5**: 330–333.
- Erwin, T.L.** and Scott, J.C. 1980. Seasonal patterns, trophic structure and richness of Coleoptera in the tropical arboreal ecosystem: the fauna of the tree *Luehea seemanni* Triana and Planch. in the Canal Zone in Panama. *Coleopterists Bulletin* **34**: 305–322.
- Faith, D.** 1994. Phylogenetic pattern and the quantification of organismal biodiversity. *Philosophical Transactions of the Royal Society of London, B* **345**: 45–58.
- Fenchel, T.** 1993. There are more small than large species? *Oikos* **68**: 375–378.
- Ford-Lloyd, B.** and Jackson, M. 1986. *Plant Genetic Resources: An introduction to their conservation and use*. Edward Arnold, London.
- Frank, J.H.** and Curtis, G.A. 1979. Trend lines and the number of species of Staphylinidae. *Coleopterists Bulletin* **33**: 133–149.
- Fuhrman, J.A., McCalum, K.** and Davies, A.A. 1992. Novel major Archaeobacterial groups from marine plankton. *Nature* **356**: 148–149.
- Gaston, K.J.** 1991a. The magnitude of global insect species richness. *Conservation Biology* **5**: 283–296.
- Gaston, K.J.** 1991b. Body size and the probability of description: the beetle fauna of Britain. *Ecological Entomology* **16**: 505–508.
- Gaston, K.J.** 1992. Regional numbers of insect and plant species. *Functional Ecology* **6**: 243–247.
- Gaston, K.J.** 1993. Spatial patterns in the description and richness of the Hymenoptera. In: Lasalle, J. and Gauld, I.D. (eds), *Hymenoptera and Biodiversity*. 277–293. CAB International, Wallingford.
- Gaston, K.J.** and May, R.M. 1992. The taxonomy of taxonomists. *Nature* **356**: 281–282.
- Gaston, K.J.** and Mound, L.A. 1993. Taxonomy hypothesis testing and the biodiversity crisis. *Proceedings of the Royal Society of London, B* **251**: 139–142.
- Gerlach, S.** 1980. Development of marine nematode taxonomy up to 1979. *Veröffentlichungen des Instituts für Meeresforschung in Bremerhaven* **18**: 249–255.
- Gilpin, M.E.** and Soulé, M.E. 1986. Minimum viable populations: processes of species extinction. In: Soulé, M.E. (ed.), *Conservation Biology: The science of scarcity and diversity*. 19–34. Sinauer Associates, Sunderland, Mass.
- Giovannoni, S.J., Britschgi, T.B., Moyer, C.L.** and Field, K.G. 1990. Genetic diversity in Sargasso Sea bacterioplankton. *Nature* **345**: 60–63.
- Grant, W.S.** and Leslie, R.W. 1993. Effect of metapopulation structure on nuclear and organellar DNA variability in semiarid environments of southern Africa. *South African Journal of Science* **89**: 288–293.
- Grassle, J.F.** 1991. Deep-sea benthic biodiversity. *BioScience* **41**: (7): 464–469.
- Grassle, J.F.** and Maciolek, N.J. 1992. Deep-sea species richness: regional and local diversity estimates from quantitative bottom samples. *American Naturalist* **139**: 313–341.
- Groot, R.S. de** 1992. *Functions of Nature: Evaluation of Nature in environmental planning, management and decision making*. Wolters-Noordhoff, Groningen, The Netherlands.
- Hall, S.J.G.** and Ruane, J. 1993. Livestock breeds and their conservation: a global overview. *Conservation Biology* **7**: 815–825.
- Hammond, K.** 1995. *FAO Global Programme for the Conservation of Domestic Animal Diversity: The rationale, working definitions, the needs and the programme*. FAO, Rome (in press).
- Hammond, P.M.** 1990. Insect abundance and diversity in the Dumoga-Bone National Park, N. Sulawesi, with special reference to the beetle fauna of lowland rain forests in Toraut region. In: Knight, W.J. and Holloway, J.D. (eds), *Insects and the Rain Forests of South East Asia (Wallacea)*. 197–254. Royal Entomological Society of London, London.
- Hammond, P.M.** 1992. Species inventory. In: Groombridge, B. (ed.), *Global biodiversity, status of the Earth's living resources*. 17–39. Chapman and Hall, London.
- Hammond, P.M.** 1994. Practical approaches to the estimation of the extent of biodiversity of speciose groups. *Philosophical Transactions of the Royal Society of London, B* **345**: 119–136.
- Hammond, P.M.** 1995. Described and estimated species numbers: an objective assessment of current knowledge. In: Allsopp, D., Colwell, R.R., and Hawksworth, D.L. (eds), *Microbial Diversity and Ecosystem Function*. 29–71. CAB International, Wallingford.
- Hammond, P.M.** and Owen, J.A. 1995. The beetles of Richmond Park SSSI – a case study. *English Nature Science* **17**: 1–180.
- Hamrick, J.L.** and Goat, M.J. 1990. Allozyme diversity in plant species. In: Brown, A.H.D., Clegg, M.T., Kahler, A.L. and Weir, B.S. (eds), *Plant Population Genetics, Breeding and Genetic Resources*. 43–63. Sinauer Associates, Sunderland, Mass.
- Harlan, J.R.** 1971. Agricultural origins: centers and noncenters. *Science* **174**: 468–474.
- Harlan, J.R.** 1976. The plants and animals that nourished man. *Scientific American* **235**: 89–97.

- Harper, J.L.** and **Hawksworth, D.L.** 1994. Biodiversity: measurement and estimation. Preface. *Philosophical Transactions of the Royal Society of London, B* **345**: 5–12.
- Harris, D.R.** 1990. Vavilov's concept of centres of origin of cultivated plants: its genesis and its influence on the study of agricultural origins. *Biological Journal of the Linnean Society* **39**: 7–16.
- Harris, D.R.** and **Hillman, G.C.** (eds) 1989. *Foraging and Farming: The evolution of plant exploitation*. Unwin Hyman Ltd, London.
- Hawkes, J.G.** 1983. *The Diversity of Crop Plants*. Harvard University Press, Cambridge, Mass.
- Hawksworth, D.L.** 1991a. The fungal dimension of biodiversity: magnitude, significance, and conservation. *Mycological Research* **95**: 641–655.
- Hawksworth, D.L.** 1991b. Biological diversity in fungi, bacteria and viruses. *Biology Education* **8**: 57–62.
- Hawksworth, D.L.** (ed.) 1991c. *The Biodiversity of Microorganisms and Invertebrates: Its role in sustainable agriculture*. CAB International, Wallingford.
- Hawksworth, D.L.** 1993. The tropical fungal biota: census, pertinence, prophylaxis, and prognosis. In: Isaac, S., Frankland, J.C., Watling, R. and Whalley, A.J.S. (eds), *Aspects of Tropical Mycology*. 265–293. Cambridge University Press, Cambridge.
- Hawksworth, D.L.** and **Ritchie, J.M.** (eds) 1993. *Biodiversity and Biosystematic Priorities: Microorganisms and invertebrates*. CAB International, Wallingford.
- Hayden, B.P.**, **Ray, C.G.** and **Dolan, R.** 1984. Classification of coastal and marine environments. *Environmental Conservation* **11**: 199–207.
- Hemmer, H.** 1990. *Domestication: The decline of environmental appreciation*, 2nd edn. Cambridge University Press, Cambridge.
- Heywood, V.H.** 1992. Conservation of germplasm of wild plant species. In: Sandlung, O.T., Hindar, K. and Brown, A.H.D. (eds), *Conservation of Biodiversity for Sustainable Development*. 189–203. Scandinavian University Press, Oslo.
- Heywood, V.H.** and **Chant, S.R.** (eds) 1982. *Popular Encyclopaedia of Plants*. Cambridge University Press, Cambridge.
- Hodkinson, I.D.** 1992. Global insect diversity revisited. *Journal of Tropical Ecology* **8**: 505–508.
- Hodkinson, I.D.** and **Casson, D.** 1991. A lesser predilection for bugs: Hemiptera (Insecta) diversity in tropical rain forests. *Biological Journal of the Linnean Society* **43**: 101–109.
- Hodkinson, I.D.** and **Hodkinson, E.** 1993. Pondering the imponderable: a probability-based approach to estimating insect diversity from repeat faunal samples. *Ecological Entomology* **18**: 91–92.
- Holden, J.**, **Peacock, J.** and **Williams, T.** 1993. *Genes, Crops and the Environment*. Cambridge University Press, Cambridge.
- Holdridge, L.R.** 1967. *Life Zone Ecology*. Tropical Science Center, San José.
- Jones, D.G.** (ed.) 1993. *Exploitation of Microorganisms*. Chapman and Hall, London.
- Lambshead, P.J.D.** 1993. Recent developments in marine benthic biodiversity research. *Oceanis* **19**: 5–24.
- Lasalle, J.** and **Gauld, I.D.** 1992 [1991]. Parasitic Hymenoptera and the biodiversity crisis. *Redia* **74**: [Appendix] 315–334.
- Lenski, R.E.** 1993. Evaluating the fate of genetically modified microorganisms in the environment: are they inherently less fit? *Experientia* **49**: 201–209.
- Loftus, R.** and **Scherf, B.** (eds) 1993. *World Watch List for Domestic Animal Diversity*. 1st edn. Food and Agriculture Organization of the United Nations, Rome. Italy.
- Longino, J.T.** 1994. How to measure arthropod diversity in a tropical rainforest. *Biology International* **28**: 3–13.
- Lyman, J.M.** 1984. Progress and planning for germplasm conservation of major food crops. *Plant Genetic Resources Newsletter* **60**: 3–21.
- Mace, G.M.** 1990. The relevance of conservation programmes for wild species to the conservation of domestic livestock. In: Alderson, L. (ed.), *Genetic Conservation of Domestic Livestock*. 146–153. CAB International on behalf of the Rare Breeds Survival Trust, Wallingford.
- Magurran, A.E.** 1988. *Ecological Diversity and its Measurement*. Croom Helm Ltd, London.
- Margulis, L.** and **Schwartz, K.V.** 1988. *Five Kingdoms: An illustrated guide to the Phyla of life on Earth*. W.H. Freeman and Co., San Francisco.
- Marzluff, J.M.** and **Dial, K.P.** 1991. Life history correlates of taxonomic diversity. *Ecology* **72**: 428–439.
- Mason, I.L.** and **Crawford, R.D.** 1993. Global status of livestock and poultry species. Appendix A. In: Rice, B.J. and Overton, J.L. (eds), *Managing Global Livestock Genetic Resources*. 141–169. National Research Council, National Academy Press, Washington, DC.
- May, R.M.** 1978. The dynamics and diversity of insect faunas. In: Mound, L.A. and Waloff, N. (eds), *The Diversity of Insect Faunas*. 188–204. Blackwell, London.
- May, R.M.** 1988. How many species are there on earth? *Science* **241**: 1441–1449.
- May, R.M.** 1992. Bottoms up for the oceans. *Nature* **357**: 278–279.
- May, R.M.** 1994a. Biological diversity: differences between land and sea. *Philosophical Transactions of the Royal Society of London, B* **343**: 105–111.
- May, R.M.** 1994b. Conceptual aspects of the quantification of the extent of biodiversity. *Philosophical Transactions of the Royal Society of London, B* **345**: 13–20.
- Minelli, A.** 1993. *Biological Systematics, the state of the art*. Chapman and Hall, London.
- Nisbet, L.J.** and **Fox, F.M.** 1991. The importance of microbial biodiversity to biotechnology. In: Hawksworth, D.L. (ed.), *The biodiversity of microorganisms and invertebrates: its role in sustainable agriculture. Proceedings of the First Workshop on the Ecological Foundations of Sustainable Agriculture (WEFSA 1)*, 26–27 July 1990, London. UK. 229–244. CAB International, Wallingford.
- O'Donnell, A.G.**, **Goodfellow, M.** and **Hawksworth, D.L.** 1994. Theoretical and practical aspects of the quantification of biodiversity amongst microorganisms. *Philosophical Transactions of the Royal Society of London, B* **345**: 65–73.
- Oldfield, S.** 1992. Plant use. In: WCMC 1992. *Global Biodiversity: Status of the Earth's Living Resources*. Chapman and Hall, London.

- Plucknett, D.L., Smith, N.J.H., Williams, J.T. and Anishetty, M.N.** 1987. *Gene Banks and the World's Food*. Princeton University Press, Princeton, NJ.
- Poinar, G.O.** 1975. *Entomogenous Nematodes. A manual and host list of insect-nematode associations*. Brill, Leiden.
- Poinar, G.O.** 1983. *The Natural History of Nematodes*. Prentice Hall, Englewood Cliffs, NJ.
- Prescott-Allen, R. and Prescott-Allen, C.** 1990. How many plants feed the world. *Conservation Biology* **4**: 365–374.
- Rex, M.A. Stuart, C.T., Hessler, R.R., Allen, J.A., Sanders, H.L. and Wilson, G.D.F.** 1993. Global-scale latitudinal patterns of species diversity in the deep-sea benthos. *Nature* **365**: 636–639.
- Rossman, A.Y.** 1995. A strategy for all-taxa inventory of fungal biodiversity. In: Peng, C. and Chou, C.H. (ed.), *Biodiversity and Terrestrial Ecosystems. Academia Sinica Monograph Series No. 14*. Institute of Botany, Taipei, Republic of China (in press).
- Samson, R.A.** 1993. The exploitation of moulds in fermented foods. In: Jones, D.G. (ed.), *Exploitation of Microorganisms*. 321–341. Chapman and Hall, London.
- Scoones, I., Melnyk, M. and Pretty, J.N.** 1992. *The Hidden Harvest: Wild foods and agricultural systems. A literature review and annotated bibliography*. International Institute for Environment and Development, London.
- Simon, H.R.** 1992. *Research and publication trends in zoology*. PhD thesis, The City University, London.
- Smith, J.F.** 1993. The mushroom industry. In: Jones, D.G. (ed.), *Exploitation of Microorganisms*. 249–271, Chapman and Hall, London.
- Solbrig, O. (ed.)** 1991. *From Genes to Ecosystems: A research agenda for biodiversity*. Report of a IUBS-SCOPE-UNESCO Workshop, Harvard Forest, Petersham, Ma. 27 June–1 July, 1991. IUBS, Cambridge, Mass.
- Stanton, N.L. and Lattin, J.D.** 1989. In defence of species. *BioScience* **36**: 368–373.
- Systematics Agenda 2000** 1994. *Systematics Agenda 2000: Charting the Biosphere. A global initiative to discover, describe, and classify the world's biodiversity*. SA2000: A consortium of the American Society of Plant Taxonomists, the Society of Systematic Biologists, and the Willi Hennig Society, in cooperation with the Association of Systematics Collections.
- Tansley, A.G.** 1935. The use and abuse of vegetational concepts and terms. *Ecology* **16**: 284–307.
- Torsvik, V., Salte, K., Sorheim, R. and Goksoyr, J.** 1990a. Comparison of phenotypic diversity and DNA heterogeneity in a population of soil bacteria. *Applied and Environmental Microbiology* **56**: 776–781.
- Torsvik, V., Goksoyr, J. and Daae, F.I.** 1990b. High diversity in DNA of soil bacteria. *Applied and Environmental Microbiology* **56**: 782–787.
- Trüper, H.G.** 1992. Prokaryotes: an overview with respect to biodiversity and environmental importance. *Biodiversity and Conservation* **1**: 227–236.
- Udvardy, M.D.F.** 1975. A classification of the biogeographical Provinces of the World. *IUCN Occasional Paper No. 18*. IUCN, Morges, Switzerland.
- UNEP/GEMS.** 1993. *Vegetation Classification*. Report of the UNEP-HEM/WCMC/GCTE Preparatory Meeting, Charlottesville, Virginia, USA. GEMS Report Series No.10. UNEP, Nairobi.
- Van Valen, L.** 1973. Body size and numbers of plants and animals. *Evolution* **27**: 27–35.
- Varnam, A.H.** 1993a. The exploitation of microorganisms in the processing of dairy products. In: Jones, D.G. (ed.), *Exploitation of Microorganisms*. 273–296. Chapman and Hall, London.
- Varnam, A.H.** 1993b. The exploitation of microorganisms in the manufacture of alcoholic beverages. In: Jones, D.G. (ed.), *Exploitation of Microorganisms*. 297–320. Chapman and Hall, London.
- Vickerman, K.** 1992. The diversity and ecological significance of Protozoa. *Biodiversity and Conservation* **1**: 334–341.
- Waples, R.S.** 1991. Pacific salmon, *Oncorhynchus* spp., and the definition of 'species' under the Endangered Species Act. *Marine Fisheries Review* **53**: 11–22.
- Ward, R.D., Skibinski, D.O.F. and Woodmark, M.** 1992. Protein heterozygosity, protein structure, and taxonomic differentiation. *Evolutionary Biology* **26**: 73–159.
- WCMC** 1992. *Global Biodiversity: Status of the Earth's Living Resources*. Chapman and Hall, London.
- Wickens, G.E., Haq, N. and Day, P. (eds)** 1989. *New Crops for Food and Industry*. Chapman and Hall, London.
- Wilson, E.O.** 1988. The current state of biological diversity. In: Wilson, E.O. (ed.), *Biodiversity*. 3–18. National Academy Press, Washington, DC.
- Wilson, E.O.** 1992. *The Diversity of Life*. Belknap Press; Cambridge, Massachusetts.
- Winston, J.E.** 1992. Systematics and marine conservation. In: Eldredge, N. (ed.), *Systematics, Ecology and the Biodiversity Crisis*. 144–168. Columbia University Press, New York.
- Woese, C.R., Kandler, O. and Wheelis, M.L.** 1990. Towards a natural system of organisms: Proposal for the domains Archaea, Bacteria, and Eucarya. *Proceedings of the National Academy of Sciences, USA* **87**: 4576–4579.
- Zeven, A.C. and de Wet, J.M.J.** 1982. *Dictionary of Cultivated Plants and their Regions of Diversity, excluding most ornamentals, forest trees and lower plants*. 2nd edn. PUDOC, Wageningen.
- Zohary, D. and Hopf, M.** 1993. *Domestication of Plants in the Old World: The origin and spread of cultivated plants in West Asia, Europe, and the Nile Valley*, 2nd edn. Clarendon Press, Oxford.

CENTRAL CHILE—SPECIES COLLECTED

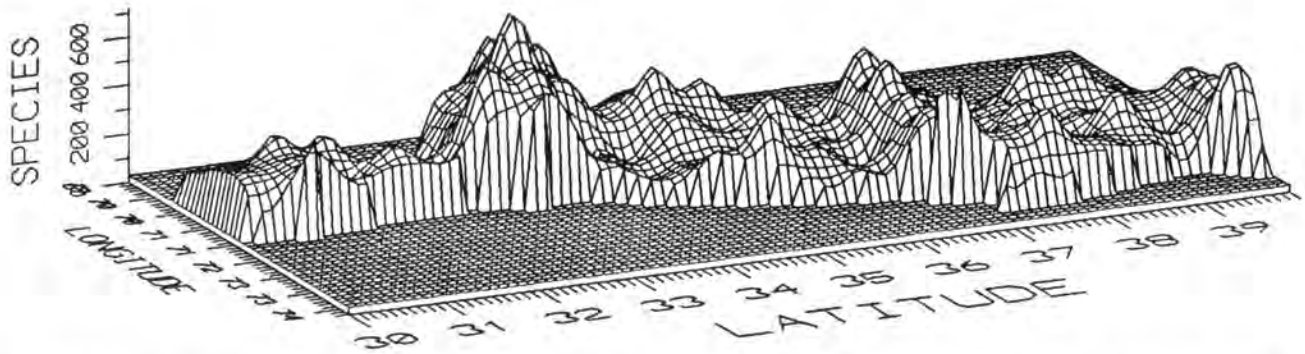

Figure 3.2-1: Species richness surface for vascular plants interpolated from numbers of species occurring in 0.5×0.5 latitude grids in central Chile, based on herbarium records in the Chilean flora database. The foreground is the Pacific coast of Chile. The unevenness of the surface is partially a reflection of variation in the sampling intensity, with many areas undersampled to reveal their true species richness (Arroyo *et al.* unpublished data).

3.2 The distribution of biodiversity

3.2.0 Introduction

Discerning pattern is a fundamental aspect of research in the biological sciences. Knowledge of pattern leads to prediction, and prediction provides a basis for testing theory, and for taking action. This chapter assesses the current state of knowledge of patterns of biodiversity at the global, regional and local scales, and their correlates, and reviews current explanations for such patterns.

3.2.1 Geographical patterns of biodiversity

For reasons that are easily understood, most efforts to assess geographical patterns in diversity have considered species as the currency of biodiversity. Assessments of large-scale geographical patterns of diversity, in which phylogenetic distances between all species of an area are given weight, are wanting.

Total organismal biodiversity – that is, the sum of all species (or of any higher taxa below the level of phylum) of all organisms – has not been tabulated for any area of land or water at any scale. That is, we currently have no assessment of the total accumulated product of organic evolution and of the ecological processes that maintain diversity, for any single area of the planet, let alone the total accumulated phylogenetic diversity. This implies that we are a long way from being able to provide an objective assessment of the role of biodiversity in maintaining ecosystem processes, of being able to understand the total consequences of loss of biodiversity on atmospheric properties (see Section 6), and of being able to assess the total potential economic value of biodiversity for different regions (see Section 12).

While there are good estimates of total richness for some of the better-known taxonomic groups (e.g. birds, butterflies, vascular plants), little is known about large-scale spatial biodiversity patterns for many of the most diverse groups of organisms on Earth, for example eubacteria, nematodes, microfungi, and various groups of protozoa, algae and arthropods. Many species, as much as 40% in beetles (Stork 1995), are still known from only a single collection and/or locality. Even in better-known groups such as vascular plants, perceived variation in diversity at the spatial scales that are most useful for determining conservation priorities sometimes reflects sampling effort rather than true pattern (Figure 3.2-1). These many biases reflect the fact that we are still at the stage of learning about what species are present on the Earth, a stage that necessarily implies a taxonomic approach, and many short-cuts when it comes to exploration, rather than an eco-biogeographical one. Clearly, however, without access to sound taxonomy, it will be very difficult to reach this second stage.

Ecologically, sampling is often concentrated in the more 'typical' part of a community. This means that ecotones and key local environmental gradients are often neglected.

3.2.1.1 Gradients

The existence of gradients in diversity implies that diversity has accumulated differentially over evolutionary and ecological time from one location to another. For predictive purposes, a key question is whether such gradients are congruent, when all groups of organisms are considered together.

Natural historians have pondered large-scale gradients in species richness for nearly two centuries, since Humboldt

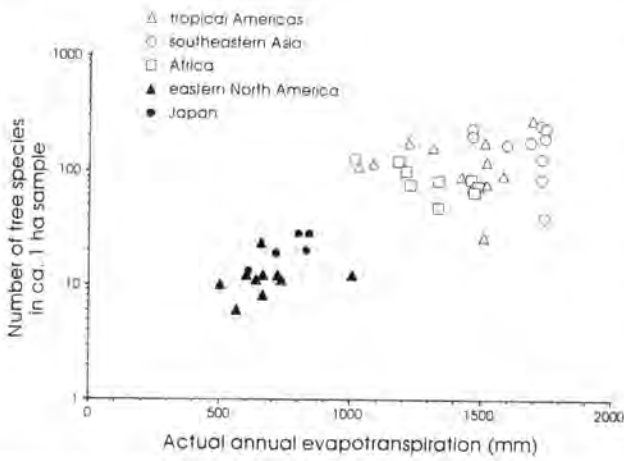

Figure 3.2-2: Relationship between tree species diversity in small forest plots and the actual annual evapotranspiration, which is proportional to ecosystem productivity (from Latham and Ricklefs 1993b).

commented on the temperate–tropical disparity in tree species richness (Humboldt and Bonpland 1807; cf. Carlquist 1974; MacArthur and Wilson 1967; May 1975b). Then, as now, most accounts have focused primarily on particular taxonomic groups (e.g. birds, beetles) or functionally or morphologically similar organisms (e.g. trees, marine and freshwater plankton).

3.2.1.1.1 Terrestrial environments. A trend of increasing biodiversity with decreasing latitude applies across many groups of organisms (Fischer 1960; Stevens 1989) on land. Stated simply, more species (or higher taxa) in these groups live in a given area in the tropics than in similar-sized areas at higher latitudes. This pattern has been attributed to such groups as trees (Latham and Ricklefs 1993a), mammals (Simpson 1964), birds (Cook 1969), reptiles and amphibians (Kiestler 1971) and insects (Stork 1988), among others.

No one seriously suggests that latitude *per se* drives biodiversity gradients but several factors that might influence biodiversity at various scales co-vary with latitude. Total land area decreases with increasing latitude (Terborgh 1973; Osman and Whitlatch 1978; Rosenzweig and Abramsky 1993), although patterns differ between the hemispheres. Other potentially important factors include temperature, total precipitation, seasonal variation in precipitation, and ecosystem energy flux.

In some major groups, however, the distribution of biodiversity exhibits no strong relationship with latitude, or even increases to a maximum in temperate zones. For example, only slightly more species of polypore fungi have been recorded in the entire continent of Africa (360) than in the much smaller and ecologically less diverse area of Europe (330), in contrast to a plant species ratio of about 10:1 (Ryvarden 1993). For well-sampled freshwater zooplankton, Cladocera show no trend with latitude while Rotifers increase in diversity towards the tropics (Dumont

1994, Segers *et al.* 1992). A ‘humped’ pattern, with highest diversity at mid-temperate latitudes, is exhibited by ichneumonid wasps (Janzen 1981; Hawkins 1990), psyllids or jumping plant lice (Eastop 1978), and aphids (Dixon *et al.* 1987; Price 1991).

Vascular plants in Africa show a major increase in diversity southwards from tropical to temperate latitudes (Gibbs Russell 1987). Local species diversities of herbaceous plants are as high in the temperate prairies of central North America as in tropical grasslands (Ricklefs 1977a). A striking example, although of a different nature, is provided by the 28 species of vascular plant epiphytes documented as occurring on a single tree in New Zealand, exceeding anything reported for the tropics to date (Dickinson *et al.* 1993).

Where latitudinal gradients have been examined closely, the relationship with biodiversity has often turned out to be complex, as discussed by Holloway (1987) for butterflies in the Indo-Australian tropics. In a compilation of tree species richness data from broad-leaved forests from 106 tropical and 22 temperate sample areas of 0.5–10 ha, representing 30 and 16 locations respectively (Latham and Ricklefs 1993a), species richness varied with latitude, but not linearly (Figure 3.2-2). Tropical samples had higher species richness than temperate samples, but species richness was independent of latitude within the temperate and tropical groups of samples. In some groups that reportedly show no pattern in diversity with respect to latitude, it is not always clear to what degree this might be an artefact of sampling effort.

In some groups of organisms, latitudinal patterns are expressed differently north and south of the Equator. For example, total tree species diversity falls off much more steeply from equatorial regions into the southern temperate zone than it does to the north. This is attributed to the far smaller extent of the southern temperate forested areas in South Africa, Australia and southern South America, compared with their northern counterparts in Europe, eastern Asia and North America (Currie 1991). However, a recent and perhaps more meaningful comparison of plant diversity in the rain forests of the Pacific Northwest of North America and southern South America, two climatically similar areas, showed that while there is a steeper latitudinal gradient in species richness in southern South America, overall the forests in southern South America are richer (Arroyo *et al.* 1995b).

Biodiversity differences among continents and hemispheres can sometimes easily be explained by reference to corresponding differences in such factors as climate and landscape heterogeneity. More often than not, however, they cannot be explained in this way. Greater climatic equitability in southern South America in comparison with the west coast of North America, allowing retention of more older Tertiary groups, is cited as a

potential factor contributing to hemispheric differences in plant diversity in rain forest floras (Arroyo *et al.* 1995b) and bird diversity at the species, genus and family levels (Jaksic and Feinsinger 1991). However, it is not immediately obvious why New Zealand, with a land area of only around 3% that of the continental United States, may have as many species of spiders (estimated 3600 species): predominantly temperate Australia has more than twice that number (estimated 9300 species; Platnick 1992). Mangrove species, genera and families are several times more diverse in the Indo–West Pacific region than in the Atlantic–Caribbean–East Pacific (Ricklefs and Latham 1993). The three large temperate forest areas – east-central Asia, eastern North America, and Europe – have an overall tree species richness ratio of 6:2:1, with parallel differences at the genus, family and order levels (Latham and Ricklefs 1993b).

For several groups of terrestrial organisms, diversity has been found to decrease with increasing altitude (Stevens 1992). Examples include bird species in New Guinea (Kikkawa and Williams 1971, cited in Brown 1988) and on the eastern slope of the Andes in Peru (Terborgh 1977), woody plant species in tropical forests (Gentry 1988), and amphibians in the Western Ghats in India (Daniels 1992).

Humped patterns of diversity on elevational gradients, with diversity lower near the foot and the summit and higher at mid-slope are known in particular groups and in some geographical areas. Examples span a wide range of taxa including flowering plants on the western slopes of the Andes in northern Chile (Arroyo *et al.* 1988), birds in the Mediterranean climate zone of California (Cody 1975), and large moths in northern Sulawesi and the Moluccas (Holloway and Stork 1991). In Chile, the diversity of vertebrates increases with altitude from the Pacific coastal desert up to the high Andean plateau, indicating the influence of local environmental conditions on diversity–altitude relationships (Pearson and Ralph 1978).

Several factors parallel to those seen with latitude might impinge directly on the processes influencing diversity on elevational gradients. Land area decreases with increasing elevation. Temperature and energy flux also are inversely correlated with elevation. In addition, stresses such as wind, ultraviolet radiation from the Sun, and daily temperature variation co-vary positively with elevation.

Diversity of many taxa decreases along the length of peninsulas, such as the Florida Peninsula and Baja California (Simpson 1964; Cook 1969; Seib 1980; Brown 1987; Case and Cody 1987). Diversity at many taxonomic levels also tends to decrease from continents to islands or within continental areas with increasing distance from potential sources of colonists (cf. MacArthur and Wilson 1967). Among large continental areas, the Mediterranean-type climate area of Chile is strongly isolated by the Pacific Ocean to the west, the Atacama Desert to the north, the

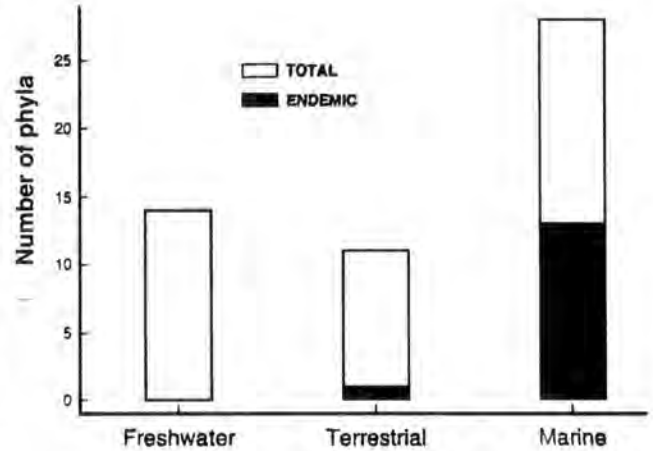

Figure 3.2-3: Diversity of animal phyla in different habitats.

Marine habitats harbour both more phyla and a larger proportion of endemic phyla than other habitats (after Ray and Grassle 1991).

Andes mountains to the east, and austral rain forest to the south, and thus is biogeographically similar to an island. Compared to the California region, which has a very similar climate, Chile supports fewer species of birds (Cody 1975) and fewer species and genera of vascular plants (Arroyo *et al.* 1995a). The diversity of lizards in Chile is comparable to that in California, but comprises the radiation of a single genus *Liolaemus* (Fuentes 1976). Another area where isolation has been important, in this case for birds, is the Western Ghats in India (Daniels *et al.* 1992).

In summary, for terrestrial environments, although there are general trends for increasing species diversity towards the tropics in many large taxa, and also along elevational gradients, the numerous exceptions and incongruities among groups should caution us against generalizing and focusing the attention of conservation efforts predominantly in the tropics (e.g. Mares 1992; Baskin 1994) and at lower elevations. The examples quoted above show that general trends with latitude or elevation are unlikely to be strongly predictive, and that local knowledge of biodiversity will always be necessary. Better knowledge of soil-dwelling organisms is particularly critical for providing a better assessment of latitudinal and altitudinal gradients.

3.2.1.1.2 Marine environments. Although the oceans cover 71% of the Earth's surface, named terrestrial species outnumber those in marine environments by seven to one (Lasserre 1992; May 1994). It is unknown to what degree this proportion is influenced by sampling bias. Quite simply, we know the land better than we know the sea. At a local scale, the richest marine ecosystems, such as coral reefs, may have levels of species diversity roughly similar to the richest terrestrial ecosystems (for example, lowland tropical rain forests), if the small fraction of taxa thoroughly inventoried to date in these systems reliably indicates the species totals.

At the phylum level, marine diversity is close to twice that of the land (Figure 3.2-3). Of the 33 extant phyla of animals (Margulis and Schwartz 1988), 32 occur in the sea, 15 are exclusively marine, and five are nearly so. In contrast, only one phylum is endemic to the land (Figure 3.2-3). The functional role played by this phylogenetic diversity is virtually ignored (Grassle *et al.* 1991; Lasserre 1992). Of course, the groups that are recognized as phyla in our existing classifications are not necessarily equivalent in age. Comparisons at this higher taxonomic level should be viewed with caution until better knowledge of the relationships among marine non-vertebrates becomes available. Further research is clearly needed to assess the relative amount of phylogenetic diversity in the oceans in relation to the land.

Large-scale pattern in diversity is probably even less clear in the sea than on land. A latitudinal gradient is evident in some fossil groups, for example, Cretaceous foraminifera and Permian brachiopods (Stehli *et al.* 1969). For present-day groups, an increase in diversity with decreasing latitude has been described for marine molluscs (Stehli *et al.* 1967). Studies of deep-water benthic invertebrates have shown consistently high species diversities across latitudes (Grassle 1989, 1991; Grassle and Maciolek 1992), although a recent study has described a latitudinal gradient of increasing diversity toward the tropics (Rex *et al.* 1993). Counts of pelagic marine plankton species in five-degree squares throughout the world's oceans (Reid *et al.* 1978; McGowan and Walker 1993) attest to the complexity of the sea. These studies show lowest diversity at high latitudes, highest diversity at middle latitudes, and intermediate diversity within 15° of the Equator, with a sharp discontinuity between highest and lowest levels at 40° to 42° latitude in the northern hemisphere and a smoother, more gradual transition in the southern hemisphere.

A humped latitudinal diversity pattern is evident in macro-algae (seaweed) communities, the most diverse of which are found in temperate nearshore areas (Lasserre 1992). A parallel and probably closely related pattern is displayed by the nearshore shallow bottom fauna (Thorson 1957), although a study of macro-invertebrates in nearshore soft-bottom marine communities in Java and Great Britain (Warwick and Ruswahyuni 1987) revealed no difference in species diversity between sites. Marine algae show an increase in diversity along the coast of Chile from 17° S southward (Santelices 1989).

Marine biodiversity generally decreases with increasing depth. Some shallow-water marine invertebrate communities are among the most biologically diverse assemblages known. However, gastropods exhibit a humped diversity curve with depth, peaking in moderately shallow waters (Rex 1981). Recent inventory work on the deep-sea floor in the North Atlantic (Grassle 1991) and southwest Australia (Poore 1993) has considerably

complicated the interpretation of the depth–diversity relationship. Using relatively new technology, this work indicates a previously unimagined richness of species and higher taxa, rivalling that of coral reefs.

No strong evidence has yet emerged in the marine realm for differences in biodiversity patterns between the northern and southern hemispheres. Less evidence of concentration of richness in the tropics in the marine realm compared to the land, coupled with clear incongruence among groups, emphasizes that future research efforts in the sea must span all latitudes.

Such research is particularly needed as coastal marine environments, ecotones stretching from the land to the sea, are especially affected by human activities, and conservation measures are urgently required (e.g. McNeill and Fairweather 1993; Sherman 1994), as discussed in Section 13.

3.2.1.2 Centres of diversity

Broad geographical gradients in diversity can be overlain with specific centres of diversity. For example, within tropical forest Myers (1988) identified ten areas, comprising 3.5% of the remaining primary forest, that harbor an estimated 34 400 endemic plant species and 27% of all tropical forest species of plants (but see Myers 1990 for a broader analysis). Vane-Wright *et al.* (1991) mapped diversity for a number of groups in an attempt to identify prime areas of conservation concern. In practice, the definition of centres of diversity is not easy, due to scale problems and choice of taxonomic group (Mares 1992).

Knowledge of where such centres are located becomes very important in selecting options between preservation and the sustainable use of biodiversity. The probability of sustainably managing species-rich areas for a given resource, and of adaptive management, should be lower than for species-poor areas, given the lesser complexity of the latter, and the greater speed with which relevant ecological knowledge on all species present can be obtained and incorporated into harvesting and management plans. Again, a key question is whether centres of diversity are congruent across different taxonomic groups. The relationship between centres of diversity and centres of endemism is discussed in 3.2.1.2.4 and 3.3.4.1.

3.2.1.2.1 What is a centre of diversity? In its simplest definition, this is merely an area with a high number of species. Centres of diversity may be recognized on global, regional and local scales. Each scale has a particular relevance on its own, and information at the finer levels of resolution is clearly essential for completing the broader global surveys. The choice of recognizing centres of diversity on a habitat versus area basis will depend on the particular purpose (e.g. conservation of a particular taxon, versus detection of the most appropriate area to optimize a general conservation effort). In identifying global and regional centres of diversity for any one habitat type, a

centre of diversity constitutes a positive deviation from the relationship of diversity to various environmental predictor variables, within that habitat type. That is, centres contain more species, or more of some other measure of biodiversity (e.g. number of phylogenetic lineages), than would be expected on average from their physical characteristics (such as temperature, precipitation regimes and soil qualities).

Within a given country, by contrast, a centre of diversity will often represent an area of high species richness that may or may not be of great significance regionally or globally. Usage of the centre of diversity concept in this last context should not be discouraged, as the detection of local centres of richness is essential for the elucidation of regional and global patterns.

The circumscription of a true centre of diversity requires, above all, adequate exploration and sampling. Without the latter, the risk is run of confounding an area of more intensive collecting with a true centre of diversity (see Figure 3.2-1). This will be particularly true when dealing with generally species-rich, or inconspicuous, groups of organisms (e.g. fungi). When the scale is global or regional the task is less daunting, due to the fact that the probability of picking up individual species will increase as the area considered increases.

Reliable analyses of centres of diversity at all three scales are effectively just beginning (Williams and Humphries 1994). On a global scale, the IUCN Plant Conservation Office (IUCN 1987; Davis *et al.* 1994–5) has identified 234 areas of especially high plant species diversity, concentrated in northwestern South America, Central America, tropical Africa, the eastern Mediterranean region and Southeast Asia/Malesia. The sites selected had to meet one or both of the following criteria:

- the area is evidently rich in species, even though the number of species present may not be accurately known;
- the area is known to contain a large number of endemics.

In addition, the following characteristics were also considered when making the selection:

- the site contains an important gene pool of plants that are of value to humans or that are potentially useful;
- the site contains a diverse range of habitat types;
- the site contains a significant proportion of species adapted to special edaphic conditions;
- the site is threatened or under imminent threat of large-scale devastation.

Sites of importance for the maintenance of avian biodiversity are being detected and described on a regional basis by BirdLife International [formerly International Council for Bird Preservation, ICBP] (Bibby *et al.* 1992). Most of these analyses are based on the numbers of restricted taxa recorded within latitude–longitude blocks and therefore do not control for within-block habitat heterogeneity or distinguish within- and between-habitat components of diversity. Thus, while global surveys have been identified for some areas of potential conservation interest, further spatial and ecological resolution within these areas is badly needed (e.g. Crowe and Brooke 1993). At a regional level, Maldonado *et al.* (1995) have used species-accumulation curves to determine whether floristic knowledge is sufficiently reliable to detect overall richness in the Compositae in central Chile at different scales, and this kind of analysis is now being extended to the entire Mediterranean flora, and for progressively smaller geographical areas, in order to detect local areas of diversity.

On a regional scale, centres of diversity are likely to be related to particular habitat types, typically the most productive or structurally complex. For example, the subtropical *pantanal* marshes of the Paraguay River in South America support an enormous diversity of mammals. These marshes are seasonally flooded, and because the prevailing soils are sandy, a complex mosaic of xerophytic and mesophytic vegetation occurs there. Although none of the mammal species is endemic to the *pantanal*, the interdigitation of xeric and mesic vegetation and of terrestrial and aquatic habitats results in a rich mammalian fauna, even richer than that of more typical tropical areas (Alho and Lacher 1991).

In some cases, regional centres of high species richness have been shown to contain large numbers of closely related species. For example, the *fybos* habitat of the Cape Floristic Region of southern Africa has 526 species of *Erica* (Cowling 1992), at least some of which have probably proliferated fairly recently owing to special conditions (fire) that promote occasional isolation of subpopulations of plants having certain non-fire-tolerant characteristics in their life–history (Cowling and Holmes 1992). Cyclic creation and rejoining of forest refugia within Australia has similarly resulted in many speciose genera of birds (Keast 1961; Cracraft 1985b) and plants (600 species of *Eucalyptus*; Groves 1994).

On a local scale, within a particular habitat type, variation in species diversity will likely reflect factors such as history of land use or natural disturbance. Frequently, areas protected from natural disturbance cycles, such as those associated with fire, will experience a decline in diversity owing to the loss of species typical of the early successional stages (Connell 1978). Diversity may also be locally sensitive to exposure or vulnerability to natural

disturbances, creating differences between windward and leeward sides of mountains (Smith 1972), and between sites with different slopes or exposure to wave action (Lewis 1964).

The value of the centre of diversity concept could be greatly strengthened by ranking the functional roles of the species concerned, and assessing their phylogenetic status (see Section 2.1). For example, the relative diversity content of the temperate rain forest of southern South America, with many monotypic, endemic genera, one endemic family and a wide spectrum of woody life forms (Arroyo *et al.* 1995b) could turn out to be much higher than that of adjacent more speciose areas of Mediterranean-climate area to its north in Chile.

3.2.1.2.2 Do centres of diversity share general features?

On a global scale, centres of diversity often appear to occupy areas of rapid habitat transition and therefore high ecological heterogeneity. For terrestrial plants, these tend to be mountainous regions, such as the Andes; areas dominated by coastlines (Central America, the Mediterranean, Malesia), as mapped in Davis *et al.* (1994) and/or regions of high tectonic activity. A similar pattern appears with regard to centres of diversity identified by the International Council for Bird Preservation (Bibby *et al.* 1992) among endemic birds – those having restricted ranges (< 50 000 km²). These tend to cluster in mountainous regions, including the Andes, and on islands, especially those of Malesia and Polynesia.

Locally, species numbers can be augmented by the mixing of previously isolated biotas, as occurred following the completion of the land bridge between North and South America (Darlington 1957; Webb 1991), and the opening of the Suez Canal between the Red Sea and Mediterranean Sea (e.g. Vermeij 1991). Some authors have argued that some areas of high species diversity, including the diverse marine communities of the western Indo-Pacific (reef-building corals and fish assemblages, for example), represent the accumulation of taxa produced peripherally, and which persist owing to low extinction rates within the area (McCoy and Heck 1976; Jokiel and Martinelli 1992; Pandolfi 1992). This scenario has been inferred from the occurrence of many young taxa within centres of diversity, with older (more basal) taxa at the periphery. In most cases, however, centres of diversity also include basal taxa and most likely represent the initial centres of diversification.

3.2.1.2.3 Are centres of diversity for different taxa congruent? The majority of vascular plant species are tropical in distribution (Ricklefs and Renner 1994). However, a good number of plant families are found only in temperate latitudes. For these, centres of diversity clearly are not congruent with the majority of other plant families. Other large taxa, such as ichneumonid wasps and scolopacine shorebirds (during the breeding season),

have their centres of diversity beyond the tropics, and in the case of the scolopacines, at high latitude. Thus on a global scale, centres of diversity across taxa are not necessarily congruent. At a regional scale, congruence characterizes some groups, but not others (e.g. Bibby *et al.* 1992). On a finer geographical scale, centres of diversity have generally failed to find show close congruence across all groups owing to the variation in the habitat requirements and mechanisms of species production in different groups (Bibby *et al.* 1992; Prendergast *et al.* 1993). Schall and Pianka (1978) and Pianka and Schall (1981) tabulated numbers of species in several groups of vertebrates in 240 × 240 km grid squares in Australia. Most pairs of these groups exhibited negative correlations in diversity, suggesting the groups had different responses to environmental variables. Similar absence of correspondence between the diversities of different groups has been noted in South American plants (Gentry 1992).

Within a given habitat type, mangrove forests of Southeast Asia support six times the number of species of mangroves regionally, and two to three times the number of mangrove species locally, as mangrove forests in the Caribbean Basin (Tomlinson 1986; Duke 1993; Ricklefs and Latham 1993). Furthermore, the Caribbean mangroves contain only two genera of trees, both monotypic (*Laguncularia* and *Pelliciera*), not found in the Indo-Pacific region. Thus finding high species richness in a particular habitat type will not necessarily mean that all areas of that habitat type are equally rich.

3.2.1.2.4 Do centres of diversity correspond to areas of endemism? The degree of endemism (see 3.3) in local biotas is arguably as important as their overall diversity. It is therefore relevant to determine whether centres of diversity and endemism correspond. Diversity *per se* and endemism are produced by somewhat different processes such that correspondence between centres of diversity and endemism will not always be expected. While endemism is the product of isolation, build-up of local biotas requires both isolation to allow genetic differentiation between populations and exchange of populations between semi-isolated areas to bring newly allopatrically formed species back into sympatry (see Section 4.3; Patton and Smith 1992; Arctander and Fjeldsa 1994). Thus, remote islands may frequently harbour distinctive endemics, but rarely large numbers of species. By contrast, individual islands within archipelagos frequently accumulate larger numbers of species through exchange and further differentiation. When areas of suitable habitat are close, the migration of individuals among them prevents differentiation and thus fosters neither endemism nor the build-up of species.

On continents, isolation can be effected as new biomes or vegetation types appear over time, as occurs in the case of the highly endemic southern South American rain forest,

which is now completely isolated from other neotropical wet forest areas by arid vegetation types in the interior of the continent (Arroyo *et al.* 1992, 1995b). Very striking cases of combined high species richness and endemism are the Mediterranean-type climate floras (e.g. Raven and Axelrod 1978; Cowling *et al.* 1992; Arroyo *et al.* 1995a). More locally, in Lake Baikal, for the benthos and littoral, ancient endemics in some groups coexist with speciose groups in others (Brooks 1950; Martens *et al.* 1994).

3.2.1.3 Introduced species

An organism that has colonized an area outside its normal range with human assistance, intentional or unintentional, is said to be introduced (alien, exotic). Invading species of plants are generally fast-growing, and compete aggressively for local resources. High reproductive output and adaptations for long-distance dispersal (Baker and Stebbins 1965; MacArthur 1972; O'Connor 1986; Drake *et al.* 1989; Groves and di Castri 1991) are features that are typically correlated in such species.

The diversity of introduced organisms is especially high in some areas with long histories of overseas human interchange and commerce (Long 1981; Crosby 1986; Drake *et al.* 1989; Fox 1990, 1995; Beardsley 1991; Lodge 1993). An additional predictable characteristic of invaded places is a lack of appropriate 'natural enemies' – predators, parasites and diseases – to control the introduced organism. For example, the Mesoamerican legume *Mimosa pigra* is attacked by five species of pathogenic fungi in Mexico, but has become an invasive weed in Australia and Southeast Asia where the pathogens are absent (Evans *et al.* 1993). Areas with a history of isolation, such as islands in general (Elton 1958; Diamond 1984; van Riper *et al.* 1986; Webb *et al.* 1988; Wagner *et al.* 1990) and the South American continent (Groves and di Castri 1991; Vermeij 1991), seem to be more vulnerable to invasion. The large introduced floras of biogeographically isolated Chile (Marticorena 1990) and California (Hickman 1993), with long histories of overseas exchange and severe vegetation degradation (e.g. Fuentes and Muñoz 1995), situated on the relatively easily invaded South American continent in the case of Chile (Groves and di Castri 1991), provide striking examples of the interaction of key factors promoting susceptibility to invasion.

Regionally, introduced biodiversity tends to lead to increases in overall biodiversity. However, locally the effect can be just the opposite. Many introduced species tend to be restricted to disturbed habitats or habitats created by humans (Herbold and Moyle 1986). While adding to overall species diversity, their presence signifies commensurate reductions in population size in other native species, through habitat preemption. Examples include the European starling, *Sturnus vulgaris* (Elton 1958), many herbaceous plants in the *fynbos* of southern Africa

(Richardson *et al.* 1992) and in the steppe zone of Tierra del Fuego (Moore 1983), and cichlid fish in Lake Gatun (Zaret and Paine 1973). Others are capable of invading relatively undisturbed ecosystems. Examples include *Myrica* in Hawaii (Vitousek *et al.* 1993; Ludyanskiy *et al.* 1993), the brown tree snake in Guam (Savidge 1987; McCoid 1991) and *Poa* spp. in the remote deciduous *Nothofagus* forests of southern South America (Moore 1983). In these cases, reductions in the local population size of native species can be expected to be even more severe. A pattern that can be expected to become more common in the future is for alien species to find their way further into undisturbed habitats, with resultant local population differentiation and eventual speciation. Introduced species or cultivated varieties pose threats not only to natural communities, but also to the ecological sustainability of harvesting and cropping systems, by competing for nutrients or ousting key native species (Diamond and Veitch 1981; Kitching and Jones 1981; Courtenay and Stauffer 1984; Mooney and Drake 1986; Culotta 1991; Jaksic and Fuentes 1991; Kaufman 1992).

3.2.1.4 Domesticated species

Nearly every human culture has domesticated animals and plants (see Section 4.1.4) and the distribution of domestic organisms broadly follows patterns of present human settlement (Crosby 1986).

Centres of origin of domestic biodiversity can be correlated with ancient centres of human culture in Africa, Asia and South and Central America (Heiser 1973; Hawkes 1983; Clark and Brandt 1984; Pursglove 1972; Hemmer 1990). Herbaceous crop species are often descended from weeds, and like many weeds may be less dependent than other plants on mycorrhizal fungi and more responsive to inorganic fertilizer inputs (Chapin 1980; Chapin *et al.* 1986; Safir 1987), in some cases because they have been selected for responsiveness to fertilizer (Jasper *et al.* 1979). Crops of the future are likely to come from the warm tropics and from arid environments, areas where there are needs and the most glaring gaps in our current crop repertoire.

Most ornamental plants do not present threats to biodiversity, except in that they occupy space that might otherwise support natives (Simberloff 1981; but see Herbold and Moyle 1986) but a number of them have escaped from cultivation and become weeds or invasives.

3.2.1.5 Rarity

Rarity is a topic of both scientific and popular concern and the subject of considerable confusion in the literature. Rabinowitz (1981) categorized plant species according to geographical range (large or small), local population size (large or small) and habitat specificity (wide or narrow). Of the eight possible combinations of these states, she

recognized seven as constituting different forms of rarity. The eighth group (common species) have large populations and ranges, and wide specificities (see also discussion in Gaston 1994). It goes without saying that the detection of rarity depends upon adequate sampling, and that sampling gaps can lead to the overestimation of rarity. Several surveys have described the general spectrum of distribution of species in these forms of rarity – for example, plants of the British Isles (Rabinowitz *et al.* 1986), birds of Central America (Karr 1977) and plants of Australia (McIntyre 1992). Typically, all possibilities are represented. Fiedler (1986; Fiedler and Ahouse 1992) proposed a list of factors as necessary and sufficient to the understanding of the causes of rarity in vascular plant species. Very valuable basic surveys of rare species have been conducted by IUCN and WCMC (see WCMC 1992). Greuter (1991) estimated rarity for the flora of the entire Mediterranean basin based on collection data and frequency of occurrence in Med-Checklist areas, and found that 48% of all species occur in a single Med-Checklist area. Here we focus on geographical and ecological correlates of the three rarity components.

There have been few attempts to discern pattern in the size of geographical range (but see Rapoport 1982). Based on the latitudinal distributions of several taxa in North America, Stevens (1989) proposed that latitudinal extent of distribution decreased on average towards the Equator (Rapoport's rule). In South America, a similar trend has been documented for tree species in the temperate rain forest zone (Arroyo *et al.* 1995b). Stevens (1989) developed a model based on high habitat specialization in the tropics, combined with movement of individuals between habitats (mass effect), to explain part of the high biodiversity of the tropics. Unfortunately, Stevens's data set did not extend into the tropics, where geographical distributions of many taxa are poorly known, or for which data are not readily accessible. However, Rohde *et al.* (1993), in a global analysis of the distribution of marine teleosts, found that latitudinal ranges were greater in the tropics compared to higher latitudes, although diversity is highest within the tropics. Although it is clear that taxa with both broad and narrow distributions occur in both the tropics and high latitudes, it is premature to draw general conclusions concerning this issue (Rex *et al.* 1993; Colwell and Hurr 1994). Clearly, range size should be investigated systematically among a variety of key taxa, controlling carefully for confounding factors, such as variation in elevation which can provide extended habitats for the distribution of cold-loving taxa (Arroyo *et al.* 1995b).

With respect to habitat specialization, the information is inadequate. The few comparative studies available show increasing habitat or host-plant specialization with increasing diversity of species (e.g. Scriber 1973; Cox and Ricklefs 1977). Janzen (1967) proposed that high-latitude

terrestrial taxa have broad habitat distributions because they must be capable of tolerating seasonal variation in the environment, which in turn enables them to live in a variety of habitats (see also Stevens 1989). Effectively, the less seasonal environments of the tropics, particularly with regard to temperature, allow for specialization and greater zonation with respect to elevation. Thus, as Janzen points out, mountain passes appear to be 'higher' in the tropics, imposing greater barriers to dispersal and increased opportunity for allopatric speciation.

With respect to local abundance, given similar total numbers of individuals in two areas, species in the area of higher diversity will tend to be less abundant on average (Coddington *et al.* 1991). Forest tree species, which can be counted individually on a per-hectare basis, are locally less abundant on average on more diverse sites. It is undoubtedly true that diverse assemblages, as in the tropics, will tend to have more locally rare species than depauperate assemblages; however, this does not mean to say that depauperate assemblages do not harbour any rare species.

Small islands constitute another habitat in which total population rareness can be expected as a result of the limited area of suitable habitat. Analyses of the distributions of birds in the West Indies (Ricklefs and Cox 1972; Cox and Ricklefs 1977) indicated that rare and endemic species frequently occupied habitats of small geographical extent (e.g. cloud forest, marshes) which differed ecologically from the more common habitats.

In view of the diversity of organisms and their biologies, it would be hazardous at this stage to draw general conclusions as to whether rare species share life history or other biological attributes. However, it is clear that widely distributed plants and cosmopolitan mould fungi produce relatively great numbers of seeds and conidia respectively. In the case of widely distributed plants, genetic self-compatibility and autogamy can be common, whereas in animals parthenogenesis is a correlate of widely distributed species (Cuellar 1994). As a corollary, species with the most limited capabilities of dispersal can be expected to colonize new habitats less easily and only recolonize ones from which they have been eliminated. Some such organisms have potential as bioindicators of habitat disturbance (Bates and Farmer 1992; Hawksworth 1993).

Rarity can signify vulnerability, although it is not a prerequisite: witness the great auk, passenger pigeon and Carolina parakeet (WCMC 1992). The extinct populations of Caribbean birds are drawn primarily from the old single-island endemics that tended to be more narrowly distributed ecologically and occurred at low densities within habitats (Ricklefs and Cox 1972, 1978). When either relic species or newly evolving neo-endemics are involved, rarity can also be related to endemism (see 3.3), one of seven rarity categories recognized in plants in the British Isles by Rabinowitz *et*

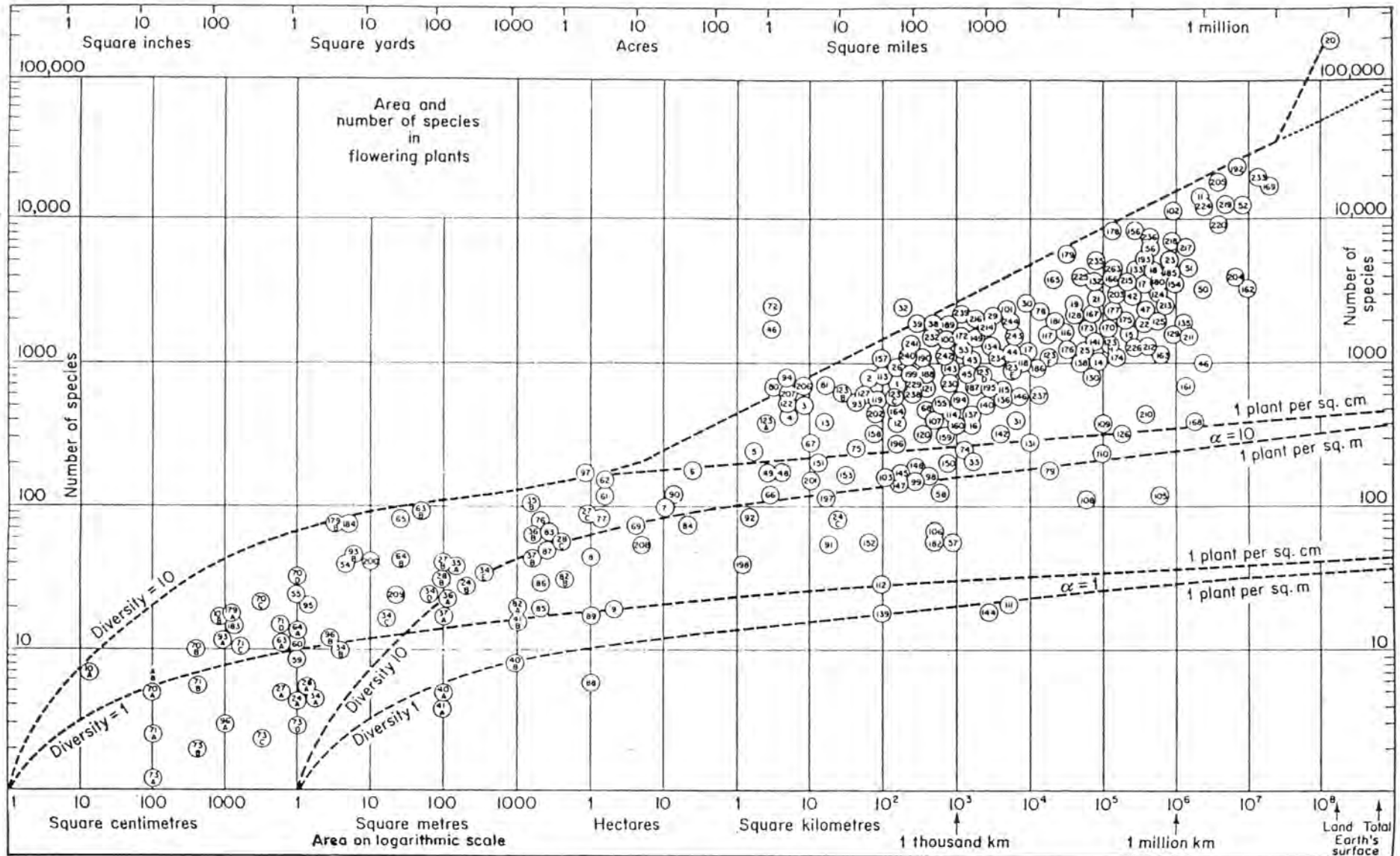

Figure 3.2-4: The number of species of flowering plants recorded in floras of areas of different sizes from all parts of the world. The horizontal ordinate shows the area concerned on a log scale ranging from 1 cm² on the left to the total area of the world on the right. The vertical scale, also on a log scale, is the number of species recorded in each particular area (from Williams, C.B. 1964. Figure 38, p. 94). For key, see overleaf.

(Figure 3.2-4 cont.)

Contractions

Column 2.

in = square inch = 6.45 sq cm

ft = square foot = 144 sq in = 929 sq cm

yd = square yard = 9 sq ft = 0.84 sq m

ac = acre = 4840 sq yds = 0.41 hectares

mi = square mile = 640 ac = 2.59 sq kilometres

cm = sq centimetre me = sq metre km = sq kilometre mill = million

Column 3.

If decimal points are given, the values are averages of several plots

Column 4.

References given at the end of this Appendix

"W." = Wallace, 1910, followed by page reference

"B." = Blake and Atwood, 1942, followed by page reference.

	<i>Locality</i>	<i>Area</i>	<i>No. of species</i>	<i>Reference</i>
1	Channel Is., Jersey	45 mi	766	Marquand, 1901
2	Channel Is., Guernsey	24.5 mi	804	Marquand, 1901
3	Channel Is., Alderney	3.1 mi	519	Marquand, 1901
4	Channel Is., Sark	2 mi	425	Marquand, 1901
5	Channel Is., Herm	320 ac	255	Marquand, 1901
6	Channel Is., Jathou	44 ac	186	Marquand, 1901
7	Channel Is., Lithou	38 ac	99	Marquand, 1901
8	Channel Is., Crevichou	3 ac	45	Marquand, 1901
9	Channel Is., Burhou	74 ac	18	Marquand, 1901
10	A England, Jealotts Hill, Grass	2 in	6.9	Blackman, 1935
	B England, Jealotts Hill, Grass	128 in	18.2	Blackman, 1935
11	C. America and Mexico	910,000 mi	12,000	Hemsley, W.42
12	Ireland, Achill Is.	57 mi	414	Praeger
13	Ireland, Clare Is.	6.2	393	Praeger
14	Ireland, Whole Island	32,524 mi	c. 1000	Praeger
15	Great Britain	88,226 mi	c. 1400	
16	Faroe Islands	480 mi	227	Druce
17	Cyprus	68 mi	1289	Helmbee
18	France	207,000 mi	4620	Costa, 1906
19	Switzerland	16,000 mi	2454	Schinz, 1908
20	Whole World	50 mill mi	170,000	Rendle
21	Ceylon	25,000	2809	Hooker
22	New Zealand	104,000	1763	Cheeseman, 1925
23	Madagascar	288,000 mi	5000	Palacky, 1906
24	A U.S.A., Michigan, Aspen Ass.	1 me	4.38	Gleason, 1922
	B U.S.A., Michigan, Aspen Ass.	240 me	27	Gleason, 1922
	C U.S.A., Michigan, Aspen Ass.	56 km	80	Gleason, 1922
25	Denmark	29,500 mi	1084	Raunkaier
26	West Indies, St Thomas and St John Is.	32 + 21 mi	904	Raunkaier
27	A U.S.A., Michigan, Aspen No. 4	1 me	4.2	Gleason, 1925
	B U.S.A., Michigan, Aspen No. 4	100 me	44	Gleason, 1925
	C U.S.A., Michigan, Aspen No. 4	8492 me	84	Gleason, 1925
28	A U.S.A., Michigan, Aspen No. 5	1 me	4.6	Gleason, 1925
	B U.S.A., Michigan, Aspen No. 5	1 me	4.6	Gleason, 1925
	C U.S.A., Michigan, Aspen No. 5	4350 me	59	Gleason, 1925
29	Trinidad	1750 mi	2000+	Hart, W.42
30	Jamaica	4200 mi	2702	Brittain, W.42
31	Galapagos	2400 mi	445	Wallace, 63
32	Brasil, Lagao Santé	66 mi	2490	Warming, W.63
33	Malacca	660 mi	200	Gamble, W.71
34	A U.S.A., Michigan, Aspen No. 1	1 me	4.8	Gleason, 1925
	B U.S.A., Michigan, Aspen No. 1	4 me	10.7	Gleason, 1925
	C U.S.A., Michigan, Aspen No. 1	16 me	17.4	Gleason, 1925
	D U.S.A., Michigan, Aspen No. 1	64 me	25	Gleason, 1925
	E U.S.A., Michigan, Aspen No. 1	256 me	32	Gleason, 1925
35	A Java, Tectona Forest	100 me	40	Arrhenius, 1923
	B Java, Tectona Forest	1200 me	104	Arrhenius, 1923

	Locality	Area	No. of species	Reference
36	A Java, Tectona Forest	100 me	23	Arrhenius, 1923
	B Java, Tectona Forest	1200 me	164	Arrhenius, 1923
37	A Java, Tectona Forest	100 me	18.6	Arrhenius, 1923
	B Java, Tectona Forest	1200 me	47	Arrhenius, 1923
38	Singapore	206 mi	1740	Ridley, W.71
39	Penang	107 mi	1813	Curtis, W.71
40	A Java, Tectona Forest	100 me	5.7	Arrhenius, 1923
	B Java, Tectona Forest	1000 me	8.2	Arrhenius, 1923
41	A Java, Tectona Forest	100 me	4.5	Arrhenius, 1923
	B Java, Tectona Forest	1000 me	16.7	Arrhenius, 1923
42	U.S.A., Colorado	104,000 mi	2912	Rydberg, 1906
43	England, Buckinghamshire	750 mi	1027	Druce, 1926
44	England, Norfolk	2000 mi	1029	Nicholson, 1914
45	England, Hertfordshire	633 mi	889	Pryor, 1887
46	Java, Panerango (very rich!)	3 km	1750	Koorders, W.74
47	India, Bombay State	111,500 mi	2650	Cooke, 1903
48	England, Scolt Head Is.	1.5 mi	185	Peal, 1934
49	England, Wicken, Cambridge	500 ac	185	Evans, 1923
50	C. and N.E. U.S.A. and adjacent Canada	1 mill mi	3300	Gray, 1908
51	Australia, Queensland	670,500 mi	4700	Bailey, 1909
52	Europe	3.75 mill mi	11,500	Nyman, 1878
53	England, Surrey	700 mi	1081	Beeby, 1902
54	England, Northampton, quarry	50 ft	40	Hepburn, 1942
55	S. Africa, Frankenveldt, purple veldt	1 me	25	West, 1938
56	Balkan Peninsula	187,800 km	6530	Turrill, 1929
57	Arctic, Jan Meynan Is.	304 mi	58	Russell, 1940
58	Arctic, Akpatok Is.	213 mi	123	Polunin, 1934
59	England, Chiltern beechwood	1 me	9	Watt, 1934
60	England, Chiltern beechwood	1 me	10	Watt, 1934
61	British Guiana, Mora forest	3.7 ac	104+	Davis, 1934
62	British Guiana, Mora forest	3.7 ac	143+	Davis, 1934
63	A S. Africa, Table Mt., sandstone	1 me	11	Adamson, 1931
	B S. Africa, Table Mt., sandstone	50 me	96	Adamson, 1931
64	A S. Africa, Table Mt., plateau	1 me	14	Adamson, 1931
	B S. Africa, Table Mt., plateau	25 me	44	Adamson, 1931
65	S. Africa, Table Mt., plateau	25 me	86	Adamson, 1931
66	England, Hampshire woodland	680 ac	121	Adamson, 1921
67	England, Hertford woodland	2-3000 ac	269	Salisbury, 1918
68	Seychelle Is.	150 mi	580	Summerhays, B.100
69	England, fox-covert	10 ac	75	Woodruffe-Peacock, 1918
70	A Sweden, Stockholm, Herb. Pinus wood	100 cm	4.8	Arrhenius, 1921
	B Sweden, Stockholm, Herb. Pinus wood	400 cm	9.8	Arrhenius, 1921
	C Sweden, Stockholm, Herb. Pinus wood	3200 cm	23	Arrhenius, 1921
	D Sweden, Stockholm, Herb. Pinus wood	1 me	33	Arrhenius, 1921
71	A Sweden, Stockholm, Herb. Picea wood	100 cm	2.5	Arrhenius, 1921
	B Sweden, Stockholm, Herb. Picea wood	400 cm	5.4	Arrhenius, 1921
	C Sweden, Stockholm, Herb. Picea wood	1600 cm	10.2	Arrhenius, 1921
	D Sweden, Stockholm, Herb. Picea wood	6400 cm	16.5	Arrhenius, 1921
72	Java, Kambangan Is. (very rich)	3 km	2400	Koorders, W.71
73	A Sweden, Stockholm, Vaccinium Vitis, Pinus assoc.	100 cm	1.4	Arrhenius, 1921
	B Sweden, Stockholm, Vaccinium Vitis, Pinus Assoc.	400 cm	2.0	Arrhenius, 1921
	C Sweden, Stockholm, Vaccinium Vitis, Pinus Assoc.	3200 cm	2.3	Arrhenius, 1921
	D Sweden, Stockholm, Vaccinium Vitis, Pinus Assoc.	1 me	3.0	Arrhenius, 1921
74	Australia, Victoria, desert	c. 500 mi	225	D'Alton, 1913, B.74
75	Aden	15 mi	250	Blatter, 1914
76	England, Herts, "Broadbalk Wilderness"	0.5 ac	79	Brenchley, 1915
77	England, Herts, "Geeseroft"	2.3 ac	88	Brenchley, 1915
78	U.S.A., Connecticut	4965 mi	2228	Graves, B.171
79	Falkland Is., S. Atlantic	6500 mi	162	Skottsberg, 1913
80	England, Wye Gorge (very rich)	3.2 km	700	Armitage, 1914
81	Panama, Barra Colorado Is.	14.6 km	715	Kenoyer, 1929
82	A U.S.A., Florida, scrub	10,000 ft	20	Mulviana, 1931

(Figure 3.2-4 cont.)

	Locality	Area	No. of species	Reference
	B U.S.A., Florida, scrub	45,000 ft	32	Mulviana, 1931
83	U.S.A., Michigan, hardwood forest	2500 me	79	Cain, 1935
84	U.S.A., Pennsylvania, forest	53.1 ac	73	Hough, 1936
85	England, Herts, wheatfield weeds, plot 8	0.5 ac	20	Warington, 1924
86	England, Herts, wheatfield weeds, plot 3	0.5 ac	30	Warington, 1924
87	U.S.A., Wisconsin, maple-basswood	2100 me	58	Eggler, 1938
88	U.S.A., Arizona, Tucson, desert	10,000 me	6	Shreve, 1937
89	U.S.A., Arizona, Tucson, desert	10,000 me	18	Shreve, 1937
90	U.S.A., Minnesota, sand-bar	29.7 ac	119	Laleka, 1939
91	U.S.A., Missouri, Horn Is.	6-7 mi	51	Pessin, 1941
92	West Indies, St Croix, Sandy Point	1-2 km	80	Raunkaier
93	Australia, Sydney, Parametta river	20 mi	618	Deane, W.38
94	Italy, Capri	4 mi	719	Beguinot, W.71
95	England, Kent	12 ft	20	Darin, W.27
96	A Denmark, Oakwood	0.1 me	3	Raunkaier
	B Denmark, Oakwood	2.5 m	12	Raunkaier
97	England, Cheshire, old quarry	2 ac	170	in litt.
98	Maldiva Is.	115 mi	156	Bond, in litt.
99	Bahrain Is. (Persian Gulf)	c. 150 mi	150+	Good, in litt.
100	West Indies, Martinique	400 mi	1798	Stehle, B.229
101	West Indies, Trinidad	1750 mi	2200	Beard
102	Venezuela	942,000 km	12,000	Pittier, B.260
103	Juan Fernández, Pacific, off Chile	141 km	143	Skottsberg, B.114
104	France, South, sand-dunes	5 me	10	Raunkaier
105	Baffins Land, Arctic Canada	236,000 mi	129	Raunkaier
106	Canada, Labrador, Chidley Penin.	c. 200 mi	64	Raunkaier
107	Samos Is., Mediterranean	190 mi	400	Raunkaier
108	Arctic, Spitzbergen	24,000 mi	110	Raunkaier
109	Iceland	40,500 mi	329	Raunkaier
110	Arctic, Novaya Zembla	35,000 mi	192	Raunkaier
111	Kerguelen Is., S. Indian Ocean	2500 mi	21	Raunkaier
112	Tristan Da Cunha, S. Atlantic	45 mi	29	Raunkaier
113	Italy, Argentario	(40 mi)	866	Raunkaier
114	Madeira Is., Atlantic	315 mi	427	Raunkaier
115	Balearic Is., Mediterranean	1860 mi	1100	Jaccard, 1939
116	Formosa	13,000 mi	1613	Raunkaier
117	Sardinia	9200 mi	1793	Raunkaier
118	Greece, Attica	2481 mi	1092	Raunkaier
119	Aegean Is., Mediterranean	32 mi	566	Raunkaier
120	Karpathos Is., Mediterranean	150 mi	375	Raunkaier
121	Zante Is., Mediterranean	165 mi	626	Raunkaier
122	Tremitic and Pelagos Is., Mediterranean	2 mi	448	Raunkaier
123	A England, Surrey	1 mi	400	Watson, 1859
	B England, Surrey	10 mi	600	Watson, 1859
	C England, Surrey	60 mi	660	Watson, 1859
	D England, Surrey, whole county	760 mi	840	Watson, 1859
	E England, South Thames area	2316 mi	972	Watson, 1859
	F England, Thames area	7007 mi	1051	Watson, 1859
	G England, Southern area	38,474	1280	Watson, 1859
	H England, whole country	87,417	1425	Watson, 1859
124	Algeria	222,000 mi	3316	Battandier, 1904, B.17
125	Congo, Katanga	180,000 mi	2230	Wildeman, 1927, B.26
126	Somaliland, British	68,000	318	Drake-Brockerman, 1912, B.17
127	S. Africa, White Hill District	40 mi	700	Compton, 1931, B.27
128	S. Africa, Kaffraria	16,000 mi	2449	Sim, 1894, B.29
129	Egypt	363,000 mi	1800	Simpson, 1930, B.30
130	Sinai Peninsula	30,000 mi	942	Zohary, 1935, B.32
131	Gambia, W. Africa	4000 mi	285	Williams, 1907, B.38
132	Natal, S. Africa	35,284 mi	3786	Bews, 1421, B.48
133	S. Africa, Transvaal and Swaziland	117,000 mi	c. 4500	Burt-Davey, 1926, B.64

	Locality	Area	No. of species	Reference
134	Australia, Brisbane	c. 1300	1228	Bailey, 1879, B.69
135	Australia, extra tropical	c. 500,000 mi	1935	Tate, 1890, B.70
136	Australia, Kangaroo Is.	1679 mi	653	Cleland, 1927, B.71
137	New Zealand, Stewart Is.	6-700 mi	450	Kirk, 1885, B.83
138	Tasmania	26,215 mi	1096	Spicer, 1878, B.86
139	Ascension Is., Atlantic	38 mi	21	Hemsley, 1884, B.86
140	Azores, Atlantic	922 mi	478	Watson, 1870, B.87
141	Canary Is., Atlantic	2807 mi	1353	Pitard, 1908, B.87
142	Cape Verde Is., Atlantic	1516 mi	300	Chevalier, 1935, B.88
143	Madeira Is., Atlantic	314 mi	951	Menezes, 1914, B.90
144	South Georgia, S. Atlantic	1094 mi	19	Schenk, 1905, B.91
145	Aldabra Is., Indian Ocean	60 mi	171	Hemsley, 1919, B.93
146	Andaman Is., Indian Ocean	2508 mi	540	Parkinson, 1923, B.93
147	Christmas Is., Indian Ocean	60 mi	151	Ridley, 1906, B.94
148	Laccadive Is., Indian Ocean	c. 80 mi	194	Prain, 1893, B.96
149	Mauritius and Seychelles	876 mi	1327	Baker, 1877, B.98
150	Chatham Is., S. Pacific	372 mi	209	Olivier, 1917, B.98
151	Lord Howe Is.	5 mi	217	Maiden, B.102
152	Antipodes Is., S. Pacific	24 mi	55	Kirk, B.102
153	Norfolk Is.	13 mi	175	Laing, B.102
154	Borneo	307,000 mi	4924+	Merrill, B.103
155	Guam Is., Pacific	225 mi	545	Merrill, B.117
156	Philippine Is.	114,000 mi	8120	Merrill, B.122
157	Philippine Is., Manila	100 km	1007	Merrill, B.123
158	Rorotonga, Cook Is., Pacific	31 mi	334	Cheeseman, B.125
159	Tonga and Friendly Is., Pacific	250 mi	290	Hemsley, B.126
160	Tahiti, Pacific	400 mi	417	Nadeau, B.129
161	Alaska	586,000 mi	684	Porsild, B.130
162	Canada	3.7 mill mi	3209	Macoun, B.133
163	Canada, Manitoba Province	246,000 mi	1029	Jackson, B.139
164	Canada, St Pierre and Miguelon Is.	81 mi	538	Waghorn, B.140
165	Brit. Honduras	8500 mi	3000	Lundell
166	Guatemala	52,500 mi	(3736)	Smith, B.147
167	Salvador	23,180 mi	2070	Standley, B.154
168	Greenland	830,000	390	Ostenfeld, B.155
169	North America, north of Mexico	7.5 mill mi	16,673	Hellar, B.158
170	U.S.A., Arkansas State	53,336 mi	1610+	Branner, B.164
171	U.S.A., California	158,297 mi	3727	Jepson, B.165
172	U.S.A., Dist. Columbia (15 mi radius)	700 mi	1343	Hitchcock, B.172
173	U.S.A., Indiana	36,354 mi	2109	McDonald, B.176
174	U.S.A., Iowa	56,147 mi	1263	Cratty, B.178
175	U.S.A., Kansas	82,158 mi	1933	Smyth, B.181
176	U.S.A., Maryland	12,327	1400	Shrove, B.186
177	U.S.A., Michigan	58,000 mi	2365	Beal, B.189
178	Cuba	44,000 mi	8000	Carabia
179	A Denmark, sedge meadow	0.1 me	17.6	Raunkaier
	B Denmark, sedge meadow	5.0 me	78	Raunkaier
180	U.S.A., Utah and Nevada	205,000 mi	3700	Tidestrom, B.196
181	U.S.A., New Jersey	8224 mi	1999	Britton, B.197
182	U.S.A., New Mexico, desert	270 mi	62	Emerson, B.199
183	Denmark, field boundaries	0.1 me	12	Raunkaier
184	Denmark, field boundaries	5.0 me	78	Raunkaier
185	U.S.A., Texas	266,000 mi	5099	Cory, B.215
186	Bahamas Is., W. Indies	4400 mi	1021	Britton, B.224
187	Cuba, Isle of Pines	840 mi	731	Jennings, B.226
188	Haiti, Tortue Is.	116 mi	889	Ekman, B.227
189	Jamaica	4207 mi	2412+	Faucet, B.227
190	W. Indies, St Thomas, St Juan and St Croix	130	1052	Britten, B.229
192	Brasil	3.3 mill mi	22,757	Martius, B.239
193	Chile	290,000 mi	5358	Philippi, B.245
194	San Thomé	c. 1000 km	556	Exell, 1946

(Figure 3.2-4 cont.)

	Locality		Area	No. of species	Reference
195	Fernado Po	} Atlantic off W. African Coast	c.2000 km	842	Exell, 1946
196	Principe		c. 126 km	276	Exell, 1946
197	Annobon		c. 14 km	115	Exell, 1946
198	Scotland, N. Rona Is.		300 ac	43	Darling, 1947
199	Switzerland, Joux Valley		260 km	827	Aubert (Raunkaier, 1934)
200	Switzerland, Val d'Anniviers		10 me	46	Jaccard, 1939
201	Scotland, St Kilda Is.		2100 ac	140	Darling, 1947
202	Scotland, Raasay and other Is.		44 mi	500	Harrison, 1937
203	British Guiana		90,000 mi	3254	Schomberg, W.21
204	Australia and Tasmania		3 mill mi	4200	Brown, W.21
206	England, Cadney, Lincolnshire		just over 3 mi	720	Wallace, 1910, p. 26
207	England, Edmondsham, Dorset		under 3 mi	640	Wallace, 1910, p. 26
208	England, Lincoln and Leicester		10-15 ac	50-60	Woodruffe-Peacock, W.26
209	England, Lincoln and Leicester		273 ft	20-30	Woodruffe-Peacock, W.26
210	Lapland		150,000 mi	500	de Candolle, W.29
211	Scandinavia and Denmark		315,000 mi	1677	de Candolle, W.29
212	Sweden		173,000 mi	1165	de Candolle, W.29
213	Germany		208,000 mi	2547	Garche, W.29
214	Sardinia		9300 mi	1770	Beccari, W.29
215	Italy		91,400 mi	4350	Beccari, W.29
216	Sicily		9940 mi	2070	Beccari, W.29
217	U.S.A., S.E. States		630,000 mi	6321	Cockerell, W.30
218	Mediterranean		550,000 mi	7000	Tchikatcheff, W.31
219	E. Europe and S.W. Asia		2 mill mi	11,876	Boissier, W.31
220	China and Korea		1.5 mill mi	8200+	Hemsley, W.33
221	Japan		150,000 mi	4000	Hayati, W.32
222	New South Wales		310,700 mi	3105	Muller, W.32
223	Western Australia		90,000 mi	3242	Muller, W.33
			excl. desert		
224	South Africa		1 mill mi	13,000+	Thomer, W.33
225	South Africa, Cape Region		30,000 mi	4500	Bolus, W.33
226	New Zealand		103,650 mi	1474	Cheeseman, W.33
229	U.S.A., District of Columbia		108 mi	922	Ward, W.33
230	Japan, Mount Nikko		360 mi	800	Hayati, W.36
232	South Africa, Cape Peninsula		197 mi	1750	Bolus, W.33
233	Africa, South of Sahara		6.5 mill mi	18,000	Thomas, W.42
234	Australia, N.S.W., Cumberland Co		1400 mi	1213	Woolfs, W.32
235	Malay Peninsula		35,000 mi	5100	Gamble, W.42
236	Burma		172,000 mi	6000	Hooker, W.42
237	Sweden, Härjedal		5375 mi	606	Birger, W.34
238	England, Malvern Hills		120 mi	802	de Candolle, W.34
239	Italy, Susa, Piedmont		540 mi	2203	Beccari, W.34
240	Switzerland, Poschiavo		92 mi	1200	Field, W.34
241	Switzerland, Schaffhauser		114 mi	1220	Field, W.34
242	Switzerland, Thurgau		381 mi	1006	Field, W.34
243	Switzerland, Grisons		2773 mi	1550	Field, W.34
244	Switzerland, Valais		2027 mi	1752	Field, W.34

REFERENCES

- Adamson, R.S. (1921). *J. Ecol.* **9**, 114. Adamson, R.S. (1931). *J. Ecol.* **19**, 304. Armitage, E. (1914). *J. Ecol.* **2**, 98. Arrhenius, O. (1921). *J. Ecol.* **9**, 95. Arrhenius, O. (1923). *Ecology* **4**, 68.
- Bailey, A.M. (1909). "Catalogue of Queensland Plants", Brisbane. Beeby (1902). "Victoria County Histories", Surrey. Blackman, G.E. (1935). *Ann. Bot.* **49**, 749. Blake, S.F., and Atwood, A.C. (1942). *U.S. Dept Agr. Misc. Pub.* 401. Blatter, E. (1926). *Rec. Bot. Survey India* **7**, 1. Brenchley, W.E., and Adam, K. (1915). *J. Ecol.* **8**, 193.
- Cain, S.A. (1935). *Ecology* **16**, 500. Cooke, T. (1903). "Flora of Bombay State", London.
- D'Alton (1913). *Vict. Nat.* **30**, 65. Darling, F.F. (1947). "Natural History of the Highlands and Islands", London. Davis, T.W.A., and Richards, P.W. (1934). *J. Ecol.* **22**, 134. Druce, G.C. (1926). "Flora of Buckinghamshire".
- Eggler, W.A. (1938). *Ecology* **19**, 252. Evans, A.H. (1923). *In Steer's "Natural History of Wicken Fen"*, Cambridge University Press, London. Exell, A.W. (1944). "Catalogue. Vascular Plants of s. Tomé", London.

- Gleason, H.A. (1922). *Ecology* **3**, 158. Gleason, H.A. (1925). *Ecology* **6**, 66. Gray, A. (ed.) (1908). "Manual of Botany", 7th Edition, New York.
- Harrison, J.W.H. (1937). *Proc. Univ. Durham Phil. Soc.* **9**, 260. Hepburn, J. (1942). *J. Ecol.* **30**, 61. Hough, A.F. (1936). *Ecology* **17**, 9.
- Jaccard, P. (1939) *Bull. Soc. Vaud. Sc. Nat.* **60**, 249.
- Kenoyer, L.A. (1929). *Ecology* **10**, 201.
- Lakela, O. (1939). *Ecology* **20**, 544. Lundell, C.L. (1937). *Carnegie Inst. Washington Pub.* 478.
- Marquand, E.D. (1901). "Flora of Guernsey and the Lesser Channel Islands", London. Mulviana, M. (1931). *Ecology* **12**, 531.
- Nicholson, W.A. (1914). "A Flora of Norfolk", Nyman, C.F. (1878–87). "Conspectus Florae Europae".
- Peal (1934). In Steer's "Scott Head Island".
- Pessin and Burleigh (1941). *Ecology* **22**, 70.
- Polunin, N. (1934). *J. Ecol.* **22**, 345. Praeger, R.L. (1934). "A Botanist in Ireland". Pryor (1887). "Flora of Hertfordshire".
- Raunkaier, C. (1934). "Life Forms". Russell, R.S., and Wellington, P.S. (1940). *J. Ecol.* **28**, 159. Rydberg, P.A. (1906). "Flora of Colorado" (Fort Collins, Col.).
- Salisbury, E.J. (1918). *J. Ecol.* **6**, 14. Shreve, R., and Hinchley, A.L. (1937). *Ecology* **18**, 463. Skottsberg, C. (1913). *Sven. Vet. Akad.* **50**. Simpson, N. D. (1930). *Tech. Bull. Min. Agr. Egypt*, no. 93.
- Turrill, W.B. (1929). "Plant Life of the Balkan Peninsula", Oxford University Press, London.
- Wallace, A.R. (1910). "The World of Life", London. Watson, H.C. (1859). *Cybele Britannica* **4**, 379–81. Watt, A.S. (1934). *J. Ecol.* **22**, 246. West, O. (1938). *J. Ecol.* **26**, 212. Woodruffe-Peacock, E.A. (1918). *J. Ecol.* **6**, 110.

al. (1986). In the case of mutualists, pests and pathogens, vulnerability will inevitably be linked to that of the host species. The richest localities within the range of a host plant, for fungi and arthropods restricted to them, are where that species is native and longest established, a phenomenon well known to seeking potential biocontrol agents (Waage 1991).

3.2.1.6 Diversity and scale

The effect on pattern of measuring diversity at different scales (see Section 2.3) should not be overlooked and can be illustrated by examples. Until fairly recently, the debate on the original causes and mechanisms maintaining diversity has been complicated because patterns manifested on different spatial scales have been mixed (e.g. Rice and Westoby 1983). Williams (1964) compiled a large set of data on local and regional floras from all continents from plots ranging in size from 10 cm² to the total terrestrial surface of the Earth (Figure 3.2-4). Some of the data sets, particularly the tropical ones, need to be revised (cf. WCMC 1992), but the general trends shown in this figure nonetheless hold.

The species–area continuum can be divided roughly into three parts. The first ranges from about 1 cm² to 1 ha (10 000 m²). Diversity on this scale is set by the sizes of the organisms (whether herbs or adult trees, for instance) and their spacing. Increases in diversity up to one hectare mainly reflect sample size (in addition to some degree of environmental heterogeneity).

From 10 ha (0.1 km²) up to 10 million km², plant richness increases steadily with area. At this scale, a greater variety of ecological conditions is included and therefore more sets of differently adapted species are added with increasing area. At the third – global – scale, continental floras are combined to make up the total terrestrial diversity. The latter is higher than that obtained from extrapolating from intracontinental diversity, showing the effect of distinct evolutionary histories among continents.

The generally higher diversity in tropical communities than in temperate communities needs to be examined at

different spatial scales. Gentry (1988) shows the species richness of plants in 0.1 ha (1000 m²) plots from 74 sites on different continents and at different latitudes. Local (alpha) diversity (Section 2.3.2, Box 2.3-1) is much higher in most tropical sites than in subtropical and temperate sites. Equatorial plots show a fivefold range in richness, from about 50 species to more than 250 in response to local climate and soil conditions. However, dissimilarity among nearby samples can also be very high in the tropics: beta diversity (Section 2.3.2, Box 2.3-1) is as important as alpha diversity in establishing the higher overall diversity of tropical plant communities.

3.2.2 Biodiversity patterns: correlates and explanations

3.2.2.1 Environmental factors and biodiversity

3.2.2.1.1 Climate and productivity. Terrestrial biodiversity can correlate with measures of precipitation and temperature (Richerson and Lum 1980; Brown and Gibson 1983; Turner *et al.* 1988; Wright *et al.* 1993). Exactly how it is correlated depends on the taxa and ecosystem concerned. For example, lizard richness declines with increasing mean annual precipitation in arid and semi-arid areas of North America north of Mexico (Scheibe 1987), while rodent diversity increases with precipitation in the same region and in Chile (Brown 1973; Meserve and Glanz 1978; Brown and Gibson 1983). In less arid areas, as in Texas, rodent diversities decline with increasing precipitation (Owen 1988). Hump-shaped patterns are sometimes seen when diversity is graphed against climatic variables (Begon *et al.* 1990; Rosenzweig and Abramsky 1993), when diversity is maximal at some intermediate point along the environmental gradient.

Integrated climate variables, such as potential evapotranspiration (PE or PET) and actual evapotranspiration (AET), have recently gained attention as correlates of terrestrial biodiversity. PE is essentially a measure of total heat flux, and AET is an estimate of how much of the existing precipitation would be evaporated or transpired from a standard 'sward' of grass on a standard soil (Major

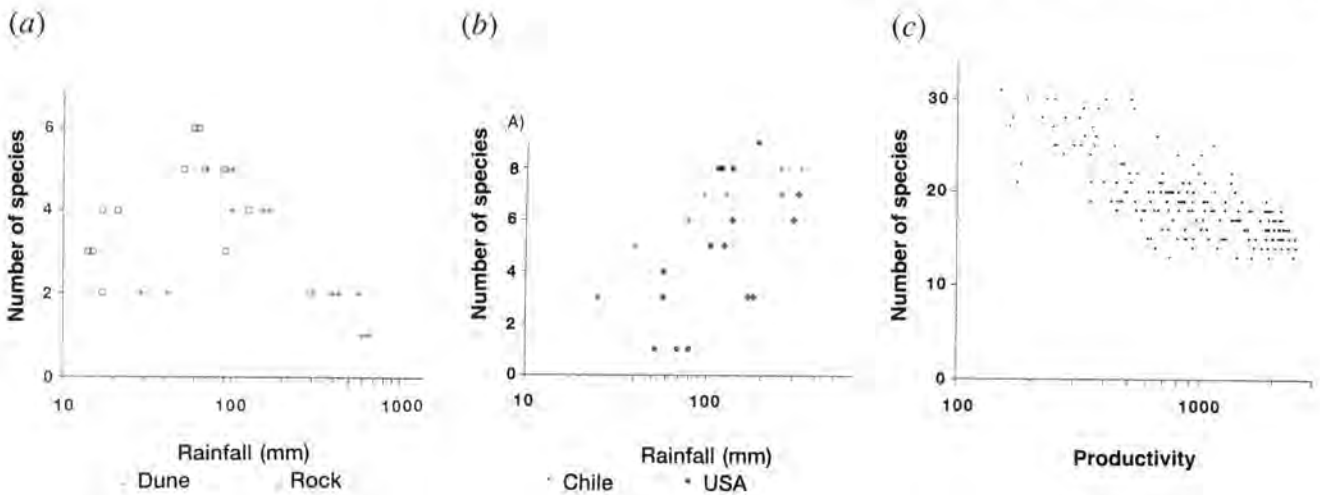

Figure 3.2-5: Relationships between number of species of rodents and productivity or precipitation, which provides an index to productivity in dry areas. (a) the Middle East; (b) Chile and the southwestern United States; (c) Texas (from Rosenzweig and Abramsky 1993; figures from Ricklefs and Schluter 1993, Fig. 5.2, p.53, and Fig. 5.6, p. 54).

1963; Stephenson 1990). AET is not measured directly but is calculated from precipitation and temperature data using a complex formula. It correlates with primary productivity in terrestrial ecosystems (Rosenzweig 1968; Lieth 1975; Box 1978).

The relationship of diversity to PE or AET depends on the group studied, and may be increasing, decreasing or humped (Wright 1983, 1990; Currie and Paquin 1987; Owen 1988; Adams and Woodward 1989; Currie 1991; Rosenzweig and Abramsky 1993) (Figure 3.2-5). Studies of these factors and biodiversity has mostly been limited to terrestrial vertebrates and higher plants. In some cases trends are similar on different continents (Adams and Woodward 1989); in others a difference in diversity persists among continents after the effect of PE or AET is estimated (Latham and Ricklefs 1993a). The relationship appears to vary with the scale examined, with a tendency for diversity to increase monotonically with increasing PE and AET at larger spatial scales and when larger taxonomic groupings are considered (Currie 1991; Wright *et al.* 1993).

3.2.2.1.2 Environmental chemistry. Chemical characteristics of waters, soils and air are known to affect diversity. The effects of certain air pollutants, especially sulphur dioxide, on the reduction in diversity of lichenized fungi, bryophytes, associated invertebrates, leaf-dwelling yeasts and certain plant pathogens have been well documented (e.g. Ferry *et al.* 1973; Bates and Farmer 1992; Richardson 1992). Acid or nitrogen from polluted air has been linked to reduced diversity of mycorrhizal mushrooms in European forests (Jaenike 1991; Arnolds and Jansen 1992), and may have particular effects on cyanobacteria-containing lichens (Gilbert 1986). In aquatic habitats, such variables as pH, salinity, oxygen and nutrient concentrations are important. Nutrient concentrations, pH and cation exchange capacity are factors in soils. In both water and soil, experimental evidence shows declines in

diversity in artificially fertilized ecosystems (Tilman 1982; Goldberg and Miller 1990; Schindler 1990), but data from naturally fertile waters and soils are not so clear.

Fertility and productivity should not be confused: for example, rapid, efficient nutrient cycling greatly enhances the productivity of tropical rain forests even on soils of apparently low fertility. Nevertheless, some workers suggest richness within the tropics is highest on the more fertile soils (Gentry 1988; Wright 1992). Species-rich plant communities have been reported from soils with low nutrient concentrations (e.g. Huston 1980; Tilman 1982; but see Janos 1983).

3.2.2.1.3 Stress. Stressful habitats are those that are extreme in their environmental conditions, although what is 'extreme' may be relative to surrounding habitats (Brown 1981). Factors often considered stressful are high temperature, salinity, heavy metal concentrations, extremes of pH, and low oxygen and nutrient concentrations. In some 'stressful environments', diversities of organisms can be lower, for example in marshes and swamps, intertidal zones, hot springs, salt lakes, high arctic and alpine habitats (Williams 1981a; Brown and Gibson 1983). In others they can be higher (e.g. Keddy 1990). A very good example is the *fynbos* of South Africa, which has low nutrient status, but very high diversity (Cowling 1992). Some of the most hostile environments for macro-organisms, such as dried salt lakes, sulphur hot springs, inside rock under ice, hot deserts and deep ocean hydrothermal vents, are the habitats of unique microorganisms (Edwards 1990; Tunnicliffe 1991; Trüper 1992). At the same time, high plant diversity has been reported on serpentine or ultrabasic soils, which contain substances toxic to most plants (Whittaker 1954, 1975; Proctor *et al.* 1988; Jaffr 1992).

3.2.2.1.4 Heterogeneity. Structural complexity and food-resource heterogeneity within habitats commonly enhances

species diversity (Bell *et al.* 1991; Kolasa and Pickett 1991; Maeem and Colwell 1991). Examples include positive correlations between bird species diversity and foliage height diversity or vegetation structural complexity (MacArthur and MacArthur 1961; MacArthur *et al.* 1972), lizard species diversity and foliage volume diversity (Pianka 1967), fish diversity and sunken structures, and estimated average food chain length and vertical structure of the environment (Briand and Cohen 1987, but see Moore *et al.* 1989).

Within larger areas, diversity generally increases when a greater variety of habitat types is present (e.g. Johnson and Simberloff 1974; Cowling 1983). Analyses of large-scale patterns have found higher diversities of mammals, birds and flowering plants in areas with greater heterogeneity in elevation (Simpson 1964; Cook 1969; Johnson *et al.* 1968, Richerson and Lum 1980), although reptiles and amphibians may show some exceptions to this rule (Kiestler 1971; Currie 1991). Habitat heterogeneity created by low to moderate levels of natural disturbance (wave action, treefall gaps, landslides, fires) may also enhance biodiversity on a spatial scale larger than the disturbances themselves (Denslow 1980). Within the Amazonian rain forest intense fluvial action tends to lead to a greater degree of habitat heterogeneity than in other tropical areas, and helps to maintain the high species richness of that area (Tuomisto 1994). Recovery from disturbance creates successional habitats absent from undisturbed or universally disturbed regions.

Environments that vary through time are also heterogeneous, but unpredictable temporal heterogeneity (on scales from years to centuries) does not seem to enhance diversity (MacArthur 1975).

3.2.2.1.5 Biological interactions. Interactions and feedbacks among the species and non-living components of ecosystems also affect biodiversity. For example, accumulation of organic matter in soils results from complex interactions among climate, vegetation, parent rock material and soil organisms (Jenny 1980). In turn, soil organic matter affects soil structure and fertility and the diversity of plants (Janos 1983) and soil-dwelling organisms (Stanton 1979; Hendrix *et al.* 1986; Ewel *et al.* 1991). Because of the complexity of such feedbacks, little is known about the possible effect on biodiversity of spatial variation in biological interactions (see also Section 6).

3.2.2.2 Speciation and extinction

The processes that result in global patterns of species diversity have both geographical and historical dimensions and involve both speciation and extinction of taxa (Ricklefs and Schluter 1993). An understanding of these processes provides an insight into the natural persistence of taxa within areas (see Sections 4.3 and 4.4).

3.2.2.2.1 Species production. Speciation requires the accumulation of genetic differences between populations,

which is thought in most cases to depend on barriers to dispersal (Otte and Endler 1989). For this reason, the rate of speciation in many groups of organisms depends on both the geographical distribution of suitable habitat within a region and the dispersal abilities of individuals, as well as on genetic and other factors that influence the rate of differentiation between isolated populations. The importance of geographical isolation on species production is illustrated by the build-up of species groups on island archipelagos where opportunities for isolation exist between islands. For example, the many species of Darwin finches (Geospizinae) on the Galápagos Archipelago differentiated from an inferred single ancestral species (Lack 1947). The same lineage is also present on Cocos, an isolated island off the Pacific Coast of Costa Rica, but only as a single species.

Isolating barriers for one taxon may be crossed easily by others. One of the smallest islands with geographically isolated and genetically differentiated populations of a bird species is Jamaica, on which the streamer-tailed hummingbird (*Trochilus polytmus*) has distinct eastern and western subspecies. On the same island, however, and on many much smaller land masses, other taxa readily form new species. Lava flows and mountain ridges and valleys are effective isolating barriers for snails, crickets and fruit flies, and also many plants on the Hawaiian islands (Carlquist 1974; Carson and Kaneshiro 1976). The hundreds of species of cichlid fish in Lake Victoria possibly arose through the alternate isolation and rejoining of subpopulations in embayments as the level of the lake rose and fell with climate variation during the past million or so years (Greenwood 1984; Meyer *et al.* 1990).

3.2.2.2.2 Extinction. Two types of extinction require consideration. The first is the more or less constant background rate of extinction that biologists presume to occur within most taxa and regions. To the extent that this rate differs between taxa or regions, it may influence patterns of diversity. This type of extinction is poorly understood except that it is presumed to increase with decreasing size of island or habitat fragment (MacArthur and Wilson 1967). The second involves high rates of extinction within particular taxa or areas due to catastrophic events such as glaciations, volcanism, rapid climate change and novel pathogens (see Section 4.4).

3.2.2.3 Ecological theories of species diversity

3.2.2.3.1 Processes that add and remove species. Species diversity is a product of the histories of species accumulation and disappearance. In general, species are added to biotas either by the production of new species within regions or by migration from outside (Figure 3.2-6). Under natural circumstances, they can be eliminated due to total extinction or be removed by one of three processes. The first is by changes in physical conditions that make the

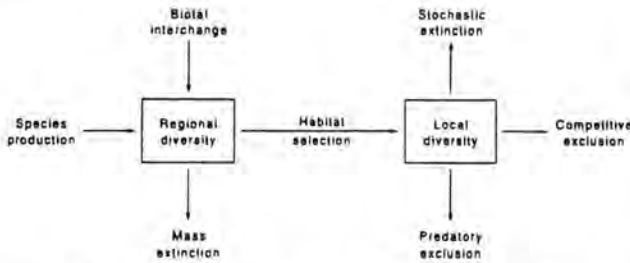

Figure 3.2-6: A schematic representation of the influence of regional and local processes on regional and local diversity. Arrows pointing towards a box increase diversity; those leading away reduce diversity. Habitat selection (the inverse of beta diversity) adjusts the relationship between regional and local diversity (from Ricklefs and Schluter 1993, Fig. 30.1, p. 351).

environment unsuitable. These may be very dramatic and extend over large areas as in the case of catastrophic disturbances. The second is by random fluctuations or chance (stochastic) events that affect birth and death rates in populations. The third is through exclusion by key biological factors, including competitors, predators, pathogens, pollinators and dispersal agents. These processes exert their population influences through local interactions between individuals.

The time scale and processes of species accumulation depend very much upon the spatial scale involved (see Section 4.1.3.4). For large regions, numbers of species build up primarily by evolutionary processes over extremely long periods. The life spans of vascular plant species are in the order of one to 5 million years (Niklas *et al.* 1983). After the end of the Cretaceous, many millions of years were required for large mammals to become as diverse as the dinosaurs they replaced. Similarly, the reconstitution of marine reefs following mass extinctions has often taken up to 10 million years, involving different groups of organisms – corals instead of rudist bivalves, for example (Kauffman and Fagerstrom 1993).

Within local areas, the build-up of diversity involves evolutionary processes to a lesser degree, with a significant component of diversity resulting from the colonization of the area in ecological time by propagules from nearby intact habitat and/or soil seed banks, hastened by the processes of succession when disturbance is involved. For example, over 1000 species were re-established on the Krakatau island group, Indonesia, within a century of its total destruction by volcanic explosion in 1883 (Simkin and Fiske 1983). Tiny islands of mangrove vegetation in Florida Bay, USA, experimentally defaunated by fumigation, regained their natural diversity within a couple of years (Simberloff and Wilson 1969; but see Simberloff 1976; Rey 1981).

3.2.2.3.2 Equilibrium versus non-equilibrium explanations. Equilibrium theories suggest that under 'natural' circumstances, species addition and loss are

balanced and, furthermore, that displacement from the 'equilibrium' value results in changes in speciation or extinction rate that tend to restore the system to its equilibrium state. In the extreme, local equilibrium theories presume that habitats become saturated with species and reach limits determined by the outcomes of local interactions between species. If equilibrium theories are correct, human-induced removal of species should eventually be compensated for by the appearance of new species.

Non-equilibrium theories suggest that diversity is not at equilibrium, and that the number of species increases or decreases depending on how the environment influences species production, exchange and extinction at any particular time. Drastic reductions in diversity during mass extinctions followed by slower recovery, and the gradual global increase in the diversity of many taxa such as flowering plants (Knoll 1986) and bony fish (Sepkoski 1992) illustrate non-equilibrium processes. At the regional scale, diversity represents the balance between extinction and species proliferation, and differences between regions are likely to reflect differences in either or both of these. At the local scale, diversity represents the balance between local extinction and movement of individuals between areas or habitats.

Human activities tend to exacerbate some of these natural causes of species removal. Regionally, the rate of human-mediated removal by extinction is probably often in excess of the natural evolutionary capacity for response (cf. Arroyo *et al.* 1992), although there is much variation from one region to another. Locally, removal clearly often exceeds the natural rate of migration and re-establishment. Studies are badly needed to compare the rates of local species addition, as a result of natural succession and local removal of species due to human activity.

Under non-equilibrium theories, given the slow rate of species production, maintenance of contemporary biodiversity within large regions depends primarily on preventing extinction. Preventing wholesale local erosion requires respect for the processes that maintain diversity. However, because of the nature of the ecological processes affecting species diversity, there will often be a good chance that species lost locally can be recuperated. While total extinction of a species affects both regional and local diversity, the long-term effects on ecological diversity of local extinction are uncertain (see Sections 4.5.3 and 5.2.2).

3.2.2.3.3 Theories of local coexistence. The number of coexisting species has been thought of as being determined by processes of species interaction (Wiens 1983). This general idea was inspired initially by competitive exclusion or elimination by predators seen in laboratory microcosms and by theoretical explorations of simple model systems (MacArthur 1972; May 1975a; Kingsland 1985). Alternatively, fugitive species may coexist with superior competitors by continually colonizing areas of unoccupied

space, as demonstrated by a variety of 'neutral' or 'lottery' models (Caswell 1977; Shmida and Ellner 1984; Chesson 1986, 1991; Tilman 1994) based on the ideas of Grubb (1977) and Sale (1977). In contrast to models of competitive coexistence, several versions of these lottery models do not require niche segregation (Hubbell 1979) and thus seem capable of explaining the coexistence of hundreds of species of tropical forest trees on a single hectare (Gentry 1988; Valencia *et al.* 1994).

3.2.2.3.4 Terrestrial landscape, marine environment and freshwater diversity. Strategies for species preservation will depend on knowledge of the temporal and spatial scale of the processes that naturally maintain species within particular areas and habitats (Ricklefs *et al.* 1984). Unfortunately, these processes have not been well resolved by biologists and there has been a bias towards terrestrial ecosystems.

Local diversity may be enhanced by the exchange of individuals between habitats. In relation to terrestrial ecosystems, this has been called the 'mass effect' by Shmida and Wilson (1985), and such effects, although less studied, should also be relevant to marine and freshwater systems. Some species may not be able to persist in a particular habitat because offspring production is insufficient to replace deaths. However, the deficits of these so-called sink populations (Pulliam 1988) may be compensated by the movement of individuals from habitats in which the species is more productive (source populations). Thus, species persistence in natural habitats strongly depends on the dynamics of the regional population (metapopulation) and the persistence of suitable habitats (see Section 4.5).

Differences in species diversity between localities may depend in part upon habitat heterogeneity within the region. For example, Cowling (1983) showed that within both *fynbos* and forest biomes in South Africa, increasing species richness in 100 m² plots is correlated with increasing phytochorological diversity (habitat complexity). In freshwater habitats such as lakes, habitat conservation (*cf.* Cooke and Welsh 1993) is clearly essential for the maintenance of these kinds of processes. As Sherman (1994) points out, the sustainability of coastal ecosystems could be greatly enhanced by implementation of a more holistic and ecologically based strategy for assessing, monitoring and managing coastal ecosystems. During the past decade considerable effort has been made by coastal countries in conducting surveys of marine populations as part of their resource assessment. Although most of the studies have been directed to economically important species, recent efforts have been initiated that include multispecies communities at different trophic levels for several large marine ecosystems (AAAS 1990; Sherman 1994). Similar efforts are under way for freshwater ecosystems including lakes, reservoirs and river basins (Magnuson *et al.* 1995).

3.2.2.4 Tests of theories of local coexistence

Theories of local coexistence of species are difficult to test because communities develop over evolutionary periods and experimental approaches are therefore difficult to interpret. Two approaches have been taken. One is to examine the primary assumption of local coexistence theory, namely that populations influence one another through competition, predation, parasitism, mutualism, and so on (see Section 4.5). The second examines several predictions of local coexistence theory, including those of community saturation and convergence.

3.2.2.4.1 Community saturation. Saturation refers to an upper limit to local richness, imposed by local interactions, that is independent of the size of the regional colonization pool (Terborgh and Faaborg 1980; Cornell and Lawton 1992; Cornell 1993). If interspecific competition and other interactions acted as major organizing forces in ecological communities, then these interactions would limit the number of species that can coexist locally in a stable community. According to this model one could expect local communities to show an upper threshold, or saturation level of diversity, regardless of the regional species pool, so that alpha and gamma diversities are uncorrelated.

Testing for saturation involves comparing species richness data in small-scale samples of uniform area among comparable habitats in different regions. The regions must differ in the size of the regional species pool. If local richness increases with regional richness at sites with smaller regional pools but levels off at a 'ceiling' value in more diverse regions, the data are taken to support saturation. If local richness increases steadily with regional richness, with no sign of levelling off, the data do not support saturation. This null result is termed 'proportional sampling', that is, local richness increases proportionately with the size of the regional species pool when sample area is held constant.

Cornell (1993), reviewing the literature available, found contrasting results and only weak support for competitive saturation (Table 3.2-1). He pointed out that whether a particular model of local coexistence predicts saturation depends on its assumptions. Models predicting saturation are based on the assumption that coexisting species evade competition by occupying diversified ecological niches. Models of local coexistence that do not require niche differentiation do not predict saturation. Thus, both the data and the current body of theory are ambivalent regarding saturation.

3.2.2.4.2 Regional enrichment. The alternative to saturation is referred to as 'proportional sampling' or 'regional enrichment'. In this model, species are independently distributed according to habitat tolerances and historical constraints. Within their region of occurrence, species will assort more or less independently from each other into local assemblages. Therefore, the local assemblage is drawn from

Table 3.2-1: The results of comparisons of local to regional diversity are mixed, but generally support regional enrichment rather than saturation (from Cornell 1993). Examples are of tests of the competitive saturation/proportional sampling predictions.

Birds on West Indian Islands: Terborgh and Faaborg (1980), saturation; Ricklefs (1987) and Wiens (1989), no saturation.
Cynipine gall wasps on oaks in California: Cornell (1985a, b), no saturation.
Wood-boring scolytid beetles: Stevens (1986), no saturation.
Herbivores on bracken: Lawton (1990a, b), Lawton, Lewinsohn and Compton (1993), no saturation.
Fig wasps in South Africa: Hawkins and Compton (1992), no saturation.
Inflorescence-utilizing insects on Asteraceae: Zwölfer (1987), Lewinsohn (1991), no saturation.
Parasites on amphibians: Aho (1990), suggests saturation.
Parasites on fishes: Aho and Bush (1993), suggests saturation.
Freshwater ciliates: Taylor (1979), no saturation.
Leaf miners on oaks: Opler (1974), no saturation.
Coral reef fishes: Westoby (1985), no saturation.
Ants in sclerophyllous vegetation: Westoby (1985), suggests saturation.
Invertebrates in seagrasses: Heck (1979), suggests saturation.
Crustaceans on corals: Abele (1984), suggests saturation.
Fishes on corals: Bohnsack and Talbot (1980), suggests saturation.

Data sets through Aho and Bush (1993) are large; the rest are small.

the regional pool and is little affected by internal community dynamics (Cornell 1985a). When ecological saturation does not apply, comparisons among communities in similar habitats in different regions should reveal a proportional relationship between local and regional taxic richness. Saturation is indicated by a plateau of local diversity with increasing regional taxic richness (Figure 3.2-7).

The results of the above kinds of comparisons (Table 3.2-1) are mixed, but generally support regional enrichment rather than saturation (Cornell 1993). Support for the regional enrichment model suggests that regional processes are important to the maintenance of local species diversity. Unfortunately, how these processes work and how they interact to influence the outcomes of local species interactions are very poorly understood (Hawkins 1993). It is worth noting that except for Aho and Bush's (1993) work on parasites, studies on saturation are from 1985 or earlier, while those on regional enrichment are later. This indicates a shift in the attitude of ecologists away from local effects and towards regional process hypotheses. Whether this represents new insight or fashion remains to be seen.

3.2.2.4.3 Community convergence in species diversity. If species diversity is regulated by local interactions among individuals, then communities occupying similar environments in geographically isolated regions (e.g. different continents) should converge around a similar number of species. Tests of convergence are powerful for evaluating the assertion that species richness is determined by local processes.

The biogeographical literature offers as many cases of nearly equal species diversities as of highly dissimilar diversities in similar habitats in different parts of the world (Schluter and Ricklefs 1993). For example, lizard species richness is similar in Mediterranean scrub in California (9 species) and Chile (8 species, Fuentes 1976) but dissimilar in deserts in Australia (27) and North America (7, Pianka 1986). Ant species richness is identical in deserts of Arizona (25) and Argentina (25, Orians and Solbrig 1977), but bee diversity varies in Mediterranean scrub between California (177) and Chile (116, Mooney 1977). Although total plant species and generic richness is lower in central Chile than in California, richness is modally similar when other temperate areas are considered (Arroyo *et al.* 1995a).

Schluter and Ricklefs (1993) divided local species diversity into two components, one attributable to the local habitat and the other to the region in which local habitats are embedded. They defined convergence as the habitat-related component, and estimated the relative magnitudes of the two components as the fraction of the overall variance in diversity that each accounted for in an analysis of variance. They found cases in which convergence predominated, other cases governed by the regional effect, and some in which the two effects were equal. In most of the data sets analysed, local species richness varied between regions within closely similar habitat types by a factor of 1.4 to 1.7, indicating a pattern of strong convergence together with a consistently important regional effect on local diversity.

3.2.2.5 The relationship between local and regional diversity

Until recently, local and regional diversity were treated as separate issues and were addressed by different specialists. The number of co-occurring species was a problem to be tackled by community ecologists concerned with models of interspecific interactions. They treated the local community as a self-contained arena in which population interactions determine how many, and which, combinations of species can coexist (Drake 1990, 1991). Regional diversity, on the other hand, was a question for biogeographers who concerned themselves with rates of speciation, continental drift and other large-scale questions, without specifying how these would relate to population and community processes.

From the standpoint of the conservation of biodiversity, understanding the relationship between local and regional diversity is essential. The link between local and regional species richness indicates the degree to which regional processes leave their imprint on the local community. This link also emphasizes the intimate connection between the maintenance of local diversity and the preservation of the landscape and regional settings (Noss 1983; Franklin 1993). The tighter the link between levels, the more dependent is the local community on surrounding habitats and the total landscape.

Recent theory has begun to explore the linkage between diversity patterns and processes at different spatial levels, recognizing that there are reciprocal influences (Brown and Maurer 1989). Community dynamics are seen as being affected by regional and historical processes: regional diversity, in turn, integrates population and community processes at the local level.

3.2.2.5.1 Empirical evaluation of the relationship between local and regional diversity. Beta diversity can be used to ascertain to what degree local and regional diversity are functionally linked, although the actual analytical procedures are still nascent and open to discussion.

Empirical studies of this relationship are still scarce. There are two difficulties. First, existing data are mostly inadequate because both local and regional diversity estimates are required and, for historical reasons, few cases offer this possibility (see Table 3.2-1). Second, if estimates of regional diversity are derived from summing species across actual local samples, as will be the case for most empirical studies, gamma and alpha diversity will tend to be correlated when few local estimates are available. Estimates of gamma diversity will become progressively independent of individual alpha estimates as the number of studied sites increases.

To examine the local–regional relationship several distinct kinds of communities or habitats with strong contrasts in overall diversity must be considered. Such comparisons may be found among communities occupying

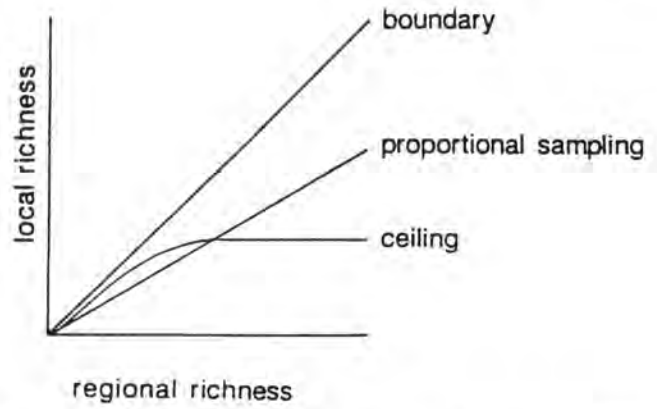

Figure 3.2-7: Theoretical relationship between local and regional richness in communities exhibiting proportional sampling and those exhibiting richness ceilings (saturation). The relationship labelled 'boundary' represents local richness equal to the regional pool and is an upper boundary on local richness (from Ricklefs and Schluter 1993, Fig. 16.5, p. 181, Fig. 22.1, p. 245).

habitat areas of different sizes. Assemblages of phytophagous insects on various host plants differing in geographical ranges provide examples of such analyses, and offer mixed support for local and regional process models (Table 3.2-1). One must also remember that these studies compare the faunas of different host plants within the same region, treating each host plant as a different region. Thus, the results of such comparisons may depend on the particular interactions of herbivores with their host plants.

Cynipine wasps on oaks. Cornell (1985a, b) examined the numbers of species of gall-making cynipid wasps on various oak species with different geographical ranges in the western USA. He found the expected relationship of regional diversity to geographical range of the oaks: species with larger ranges harboured more species of gall-forming wasps. Moreover, local diversity was also related to both geographical range and total (gamma) diversity, with no evidence for an upper limit to local community size. Thus, this system conforms to a regional enrichment model.

Additional support for such a model is provided by the comparison of assemblages of insects feeding on bracken in different parts of the world, which show a clear relationship of alpha to gamma diversity, again with no evidence for saturation (Lawton *et al.* 1993). Likewise, in a study of beetles in rotting tree branches, Stevens (1986) obtained results essentially similar to those of Cornell and Lawton (1992).

Insects on flowerheads. Different results were obtained in two studies of flowerhead-feeding insects associated with Compositae. Both in Europe (Zwölfer 1987) and in Brazil (Lewinsohn 1991), alpha and gamma diversity are seen to be correlated, but this is partly due to the sampling problem referred to earlier. Contrary to Cornell's and

Lawton's results, gamma diversity, but not alpha diversity, correlates with host plant area, once sampling effort is factored out (through path analysis, Lewinsohn 1991). These results show that, for these assemblages, beta diversity is largely responsible for the greater species richness of insects feeding on more widespread plants. However, local and regional diversity are still correlated although more weakly than in the foregoing cases, which indicates that they are to some extent linked.

West Indian land birds. Censuses of nine matched habitats, ranging from arid scrub to cloud forest, on five islands of different area and distance from continental coastlines (Cox and Ricklefs 1977; Wunderle 1985), showed that increasing regional diversity (total number of species per island) is accompanied by continuous increases in both alpha and beta diversity. Indeed, both components increase in direct proportion to the square root of gamma diversity. There is some evidence that a similar relationship holds for the diversity components of mangrove forests (Ricklefs and Latham 1993).

The flora of the Mediterranean-type climate region of central Chile. Although total plant species and generic richness (gamma diversity) is lower in central Chile than in California (Arroyo *et al.* 1995a), regional woody species richness, alpha diversity and the woody component of alpha diversity are higher in central Chile (Mooney 1977). Higher alpha diversity in Chile has been attributed to a greater degree of disturbance (Mooney 1977). However, regional enrichment, expressed through the richer woody flora, offers an alternative partial explanation at least for higher alpha diversity (Arroyo *et al.* 1995a).

Although these results are a useful starting point for discerning the major patterns, they do not distinguish unequivocally between local- and regional-process models. The lack of evidence for upper thresholds need not imply that local dynamics are inconsequential to both local and regional diversity. Both alpha and beta diversity tend to increase with gamma diversity, indicating a balance between regional and local processes. The important point is that patterns of diversity represent a continuum of scale. Additional work to address these questions with a wider variety of organisms and habitats is badly needed.

3.2.2.6 Taxon-specific patterns of diversity: dispersal

The limited dispersal and colonization abilities of some taxa and lineages contribute to natural differences in biodiversity at local and regional scales. Limited dispersal capacity will also hinder recuperation of biodiversity in naturally disturbed or managed ecosystems where the extraction of a resource has exaggerated initial effects on the remaining biota. Knowledge of dispersal capacity is therefore fundamental to any understanding of diversity patterns *per se* and for predicting how biodiversity will respond to management.

Biodiversity often decreases with distance from source populations, and is most constrained by dispersal in areas that are surrounded by dissimilar habitat, such as oceanic continents and archipelagos, temperate ecosystems isolated on tropical mountain tops, moist ecosystems in arid regions, and isolated lakes (Carlquist 1965; Colinvaux 1993). For example, there are fewer species of algae in lakes on the remote Galapagos Islands and remote Easter Island than lakes of the same size on the continent (Colinvaux and Steinitz-Kannan 1980; Colinvaux 1993). Except for bats, terrestrial mammals have limited dispersal abilities, and their diversity decreases with increasing isolation on Canadian, British and Danish islands (Grant 1970; Table 3.2-2). Poor dispersal can also result in decreasing diversity of birds, rodents and lizards with distance along peninsulas (Taylor and Regal 1978), and may contribute to loss of diversity from fragmented habitats (Harris 1984; Lovejoy *et al.* 1986). However, regional diversity in lineages with good dispersal is sometimes lower than in lineages with poorer dispersal because lack of reproductive isolation among populations can reduce speciation (Ricklefs and Cox 1972). Different taxonomic groups, moreover, exhibit different degrees of reduced diversity (disharmony) with isolation because of their particular dispersal means, sensitivity to environmental stress, reproductive biology, minimum population sizes, and the particular behaviour patterns of animal dispersers and pollination vectors themselves (Carlquist 1965; Bush and Whittaker 1991; Whittaker and Jones 1994). For example, the diversity of amphibian families in the Philippine archipelago decreases with distance from mainland Borneo more steeply than the diversity of lizard families (Darlington 1957; Carlquist 1965). Bermuda has the northernmost coral reefs because the Gulf Stream deposits coral larvae from the tropics, but reef fish cannot survive the long journey (Ray and Ciampi 1956). Williamson (1981) compared oceanic islands of equal area where the climates of the mainland and islands were similar and suggested that differences in dispersal resulted in the nearshore Channel Islands (UK) having more than twice as many vascular plant species, four times as many breeding bird species, but the same number of fern species as the more distant Azores. Some lineages of birds are apparently absent from Caribbean islands because of limited dispersal abilities (Ricklefs 1987).

3.2.2.6.1 Passive dispersal. Many organisms use wind or water currents to effect their dispersal. Rakata was first colonized by wind-blown and water-borne seeds following the volcanic explosion of Krakatau (Bush and Whittaker 1991). Gametes of many marine invertebrates and fish are released into currents which disseminate their pelagic larvae (Scheltema and Williams 1983; Vermeij *et al.* 1985; Underwood and Fairweather 1989; Leal and Bouchet 1991). Passive dispersal may be more efficient than

expected because dispersers are concentrated by prevailing winds or currents, as in coral larvae deposited in Bermuda by the Gulf Stream (Ray and Ciampi 1956), or their distribution may be otherwise non-random. For example, in a study in Panama, Augspurger and Franson (1988) found that more wind-dispersed tree seeds fell into forest light gaps than expected. Furthermore, spores, mites, small insects and seeds are thought to be deposited disproportionately in orographic rain on high islands and mountain tops because such minute biota act as nuclei for raindrops (Gressitt 1961; Carlquist 1965; Ehrendorfer 1979).

3.2.2.6.2 Active dispersal. Many animals disperse under their own power, but they differ in their ability or inclination to do so. Although most birds can fly, their diversity is reduced with distance from the mainland in the Lesser Antilles (Table 3.2-3; Ricklefs 1977b) and on islands off California (Power 1972; Williamson 1981). Some animals that evolved in ecosystems with large areas of contiguous habitat will not cross rivers or forest gaps (Willis 1969, 1979; Diamond 1971; Terborgh 1975; Karr 1982; Cracraft 1985a; Newmark 1991), and are more likely to become locally or regionally extinct through forest fragmentation (Newmark 1991; Lovejoy *et al.* 1986; see also Section 4.5). In contrast, species that utilize widely dispersed or patchy resources may regularly cross large areas of unsuitable habitat (Lack 1976; Karr 1982; Lovejoy *et al.* 1986).

3.2.2.6.3 Vectors. Many plants (Carlquist 1965; Bush and Whittaker 1991), fungi (McIlveen and Cole 1976) and invertebrates (Kuschel 1962) depend on animal vectors for dispersal and, where applicable, pollination. Capacity to colonize new areas successfully and to recolonize previously occupied areas is highly dependent on the behavioural characteristics and geographical distribution of such vectors. For example, truffle fungi are obligate mycorrhizal symbionts of trees and are normally dispersed within forest boundaries by small mammals that consume

Table 3.2-2: Rank correlations for the number of species of mammals on islands (from Grant 1970).

Variable	Canadian Is.	British Is.	Danish Is.
Area	+ 0.16	+ 0.04	+ 0.67*
Isolation	+ 0.43**	+ 0.68***	+ 0.63*

* $p < 0.05$; ** $p < 0.01$; *** $p < 0.001$.

them (Maser *et al.* 1978; Malajczuk *et al.* 1987; Blaschke and Baumler 1989). Although rodent dispersal is efficient, it limits movement of truffles between (and diversity in) forests on isolated mountain ranges in the Great Basin of North America (Fogel 1992). The reluctance of pollinators and avian seed dispersers of certain plants to move across gaps raises concern for the effects of logging and fragmentation on plant diversity in tropical forests and particularly southern temperate forests where, in contrast to the northern temperate forests, animal dispersal and pollination is commonplace (Lovejoy *et al.* 1986; Armesto *et al.* 1987; Newmark 1991; Riveros *et al.* 1991; Thiollay 1992). Some birds and bats are known to fly long distances bearing propagules of plants (Carlquist 1965; Bush and Whittaker 1991; Whittaker and Jones 1994) and fungi (McIlveen and Cole 1976). Dispersal of fruits by bats and birds is often delayed, however, until other trees serve to attract them (Bush and Whittaker 1991; Parrotta 1993).

3.2.2.6.4 Interaction of dispersal with breeding system. The probability of successfully colonizing an isolated island or widely separated habitat patch on a continent is greater for self-fertile and asexually reproducing species of invertebrates and fungi (Baker 1955; Carlquist 1974; Ehrendorfer 1979; Barrett 1985) than for outcrossing species. Likewise, the probability of colonization in a

Table 3.2-3: Multiple regression—partial correlation analysis of factors influencing species diversity on West Indian Islands (from Ricklefs 1977).

Islands	Size	Sample area	Altitude	Distance to mainland	Distance to nearest island	Multiple R ²
West Indies	33	0.75 ¹	0.31	-0.27	-0.10	0.88
Greater Antilles	12	0.91*	0.07	0.30	0.02	0.96
Lesser Antilles	21	0.61*	0.56*	-0.78*	-0.46*	0.87

1. The five Virgin Islands were not included in either the Greater or Lesser Antilles.

* $p < 0.01$.

species adapted to generalist pollinators will be higher than when highly specific pollinators are required. These same principles apply to recolonization following large disturbances, such as glaciation, in continental areas, and to smaller disturbances such as those occurring following the harvesting of a key resource. This may explain the prevalence of self-fertility among colonizing and ancestral island plant species (Carlquist 1965, 1974; Barrett 1985; McMullen 1987; Taylor 1993). Obligate outcrossing may increase the likelihood of maintaining viable populations through time (Carlquist 1965, 1974; Sakai *et al.* 1989; Webb and Kelly 1993) but the over-abundance of obligately outcrossing dioecious species in island floras may have other causes (Carlquist 1965; Baker 1967; Ehrendorfer 1979; Baker and Cox 1984; Webb and Kelly 1993).

Many plants on distant islands are pollinated by a few generalists due to poor dispersal of pollinators (Carlquist 1965, 1974; Ehrendorfer 1979; McMullen 1987; Webb and Kelly 1993). Large or dense source populations provide more dispersers (Williamson 1981), which may be critical for the establishment of sexual animals such as birds and mammals. In other phyla, however, self-fertility and asexuality in source populations can favour their establishment on islands, and these traits are more common in sparse populations that are often at the limit of their range (Barrett 1985). It is not known if this amplifies founder effects (see Section 4.2) and results in increased diversity among populations on different islands.

For continental floras, the breeding system information now available suggests that obligate outcrossing via self-incompatibility and dioecism increases strongly with longevity (Bullock 1985; Arroyo and Squeo 1990; Arroyo and Uslar 1993). Within any given life-form it has been demonstrated recently that dependence on external pollination vectors can be as high, if not higher, in temperate plant communities than in the tropics (Arroyo and Squeo 1990; Arroyo and Uslar 1993). Because few rigorous community surveys of pollination have been carried out to date, it is not clear whether or not tropical species always show a greater degree of pollinator specificity than their tropical counterparts. In a world of rapidly changing landscapes, subject to the effect of global climatic change, more detailed knowledge of the reproductive biology of species is required in order to determine the overall capacity of species to respond, and thereby to be able to make informed predictions about future change (Arroyo *et al.* 1993).

3.2.2.7 History, biogeography and diversity

3.2.2.7.1 Non-convergence and the roles of history and biogeography. Patterns of biodiversity follow general patterns in physical conditions of the environment, such as insolation, temperature, precipitation and salinity. Striking deviations from ecologically 'predictable' levels of

diversity suggest, however, that the histories and biogeographical positions of different areas have also left their imprint on both regional and local diversity (Brooks and McLennan 1991). The examples presented in some detail above concerning variation in the diversity of mangroves and temperate forests indicate that the numbers of species in diverse and depauperate assemblages in matched habitats or biomes may vary by factors of five or ten, and average about 1.5 (Schluter and Ricklefs 1993). Such diversity anomalies have presumably resulted from differences in region-scale processes of species production, exchange and extinction.

3.2.2.7.2 Diversity anomalies and geographic and historical circumstances. Two case studies illustrate how special historical and geographical circumstances can influence diversity patterns. As we have seen, the temperate broad-leaved forests of eastern Asia contain about three times as many tree species as those of eastern North America and six times as many as those of Europe. Furthermore, the Asian forests contain a marked proportion of taxa derived from tropical, rather than strictly temperate, groups. Finally, the fossil record shows that during the middle Tertiary, the European tree flora equalled that of Asia in diversity, both of these being far more diverse than the flora of eastern North America (Latham and Ricklefs 1993b; Table 3.2-4). The simplest interpretation of these data is that the high Tertiary diversity of Eurasia resulted from a direct connection through continuous forest habitat between temperate east Asia and tropical Southeast Asia, and that North America was relatively isolated from both Eurasia and tropical South America. More recently, cooling trends and eventually glaciations had their greatest impact on the flora of Europe, with the east-west barriers of both the Alps and the Mediterranean basin blocking the southward displacement of warm-temperate species to southern refuges.

The greater tree species diversity of mangroves in the Indo-West Pacific region compared to the Atlantic-Caribbean region appears to be related to two processes that have occurred more readily in Southeast Asia than elsewhere, namely the invasion of mangrove habitat (i.e. salt water) by elements of the terrestrial flora, and the proliferation of taxa by speciation within the mangrove flora (Ricklefs and Latham 1993). The first presumably requires evolutionary modification for tolerance of salt and anoxic sediments, and probably occurs most readily in regions of high precipitation in which the transition between freshwater and salt water is gradual and continuous. The second undoubtedly requires the geographical isolation of subpopulations afforded by complex geography and ocean currents. The particular way in which these factors have influenced mangrove diversity in different areas has not yet been determined, but the numerous islands and complex currents in the

Malesian region might produce ideal conditions for reproductive isolation.

3.2.2.7.3 Congruence and independence of histories. Congruence of geographical patterns of distribution may occur among taxa when they utilize similar paths of dispersal or when several taxa are subdivided by the same tectonically and climatically produced barriers to dispersal (Nelson and Platnick 1981). The latter produces what are known as vicariant patterns of dispersal. Such barriers can be as geographically extensive as sea-floor spreading separating formerly united continents, or as local as a change in drainage pattern (Cracraft 1973). Typically, vicariant patterns are identified by the high degree of congruence among the relationships of the taxa in each area, but vicariant processes do not lead to the increase of diversity within each fragment, unless the pieces of area re-coalesce. High diversity is more likely to accumulate through moderate levels of dispersal between suitable islands of environment, but the tectonic histories of some parts of the Earth, particularly the Caribbean, and the region from the Mediterranean through Southeast Asia to New Zealand, have been so complex that vicariant processes may have been responsible for considerable build-up of diversity.

3.2.2.7.4 Differential extinction. It is well known that extinction has moulded biodiversity patterns in temperate biota, but its more general influence is poorly understood. Minimum ages of taxa may be estimated from fossil data where these are sufficiently detailed. An example for families of mammals is given in Figure 3.2-8, in which it can be seen that the West African taxa are generally younger, indicating more active evolution and speciation in the African fauna, but that the oldest taxa are also from Africa (Ricklefs and Schluter 1993). A comparison of local forest bird faunas from temperate North America (Illinois) and tropical Central America (Panama) showed that the tropical fauna had twice as many species as the temperate fauna, and that the taxa comprising the tropical fauna were, on average roughly twice the age of the temperate taxa (Ricklefs and Schluter 1993). Thus, the difference in diversity may have resulted from the difference in the ages of lineages in each area (Farrell and Mitter 1993).

The relative roles of speciation and extinction in producing global patterns of species diversity, particularly the general increase in species number from high latitudes towards the Equator, is a matter of considerable debate. If species accumulate in the tropics due to low extinction rates, one would expect to find the average age of tropical taxa to be higher than that of the temperate taxa. If, on the other hand, tropical diversity were driven by high speciation rates, taxa should be relatively younger there.

Another approach to estimating the relative ages of biotas has been to calculate the ratio of species to genera, with the assumption that the higher ratios indicate

Table 3.2-4: Contemporary and fossil diversity of trees from three temperate areas. The fossil record shows that during the middle Tertiary, the European tree flora equalled that of Asia in diversity, both of these being far more diverse than the flora of eastern North America (from Latham and Ricklefs, 1993b, Table 26.8, p. 304).

	Europe	Asia	North America	
			Western	Eastern
Total extant genera	53	185	42	99
Total fossil genera	130	122	75	60

relatively high rates of speciation and more recent derivation of a biota on the species level. Sampling and different taxonomic concepts become problematic in such comparative studies. One example shows that species to genus ratios in tropical trees from a small area in Costa Rica are slightly less than those in the temperate tree flora of North America (Ricklefs 1989). Ricklefs and Renner (1994) developed a non-linear mathematical relationship between number of families and genera for flowering plants. In fact, in general, diversity at different taxic levels often varies in parallel, indicating that global patterns of species diversity are, on the whole, very old (Arroyo *et al.* 1995a; Williams and Gaston 1994; Williams *et al.* 1994). As always, however, such generalizations are tempered by exceptions. In the Cape Flora of South African the number of species per genus is unusually high (> 8 per genus, on average) even for Mediterranean-type climate floras (cf. Raven and Axelrod 1978), indicating recent, rapid speciation (Goldblatt 1978).

3.2.2.7.5 History and ecological diversity patterns. As a stronger theoretical framework emerges, it is becoming evident that patterns of biodiversity in natural settings showing strong ecological correlations may reflect history rather than the product of ecological equilibria of species diversity determined by the outcome of species interactions. The decrease in diversity with increasing distance from the Equator may in part reflect the relative age, geographical extent, and different historical patterns of barrier formation and consequent biotic disruptions of tropical, temperate and boreal environments. During most of the early Tertiary period, global climates were less stratified than they are at present and extended to high latitudes in both the northern and southern hemispheres (Axelrod *et al.* 1991). Possibly, the greater area and antiquity of modern tropical environments has been a major factor in their present-day diversity. In particular, the extension of tropical groups to temperate climates required the evolution of frost resistance. This may have been so strong a climate barrier, as it is at present (and just as salt

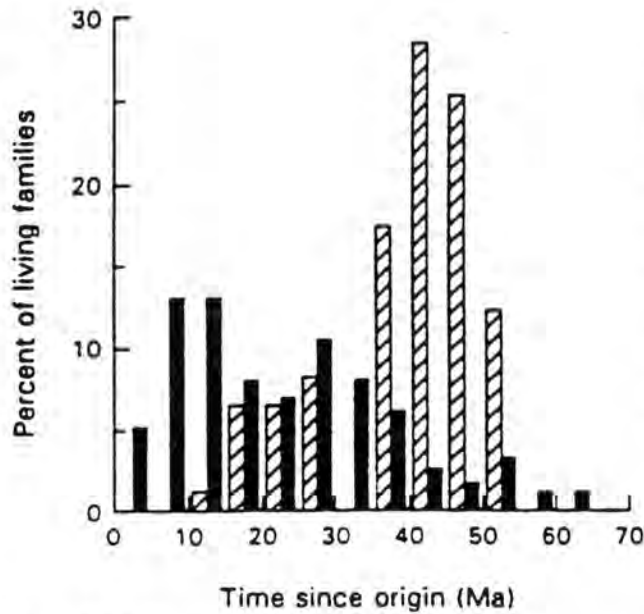

Figure 3.2-8: Distribution of ages of taxa in temperature (northern Eurasia: hatched bars) and tropical (central-western Africa: solid bars) mammalian faunas (from Ricklefs and Schluter 1993, Fig. 30.6, p. 362, after Stehli *et al.* 1969).

tolerance is for mangrove plants), as to restrict the invasion of temperate environments from the tropics. Given enough time, diversity at high latitudes might increase to levels now seen in the tropics (e.g. Wilson and Taylor 1967), but the present disparity would then have arisen from historical, non-equilibrium causes (Farrell *et al.* 1992; Farrell and Mitter 1993; Latham and Ricklefs 1993b).

3.2.3 Concluding comments

Distributional studies of biodiversity patterns show that each region has had a unique phylogenetic, geographic and ecological history that has shaped contemporary biodiversity. While there are broad geographical patterns, the complexity of regional and local situations diminishes the predictive value of these patterns and emphasizes that much more attention must be given to understanding local processes and past history. A more geographically balanced and integrative effort among taxonomists and ecologists, at both the research and conservation levels, is essential in order to safeguard all ecological systems and their component species. This perspective emphasizes the intrinsic value of each area irrespective of its richness, and the need for careful assessment of the relationship of any given biota to others nearby, before arriving at conservation and management plans.

Human activity tends to modify the balance of present-day ecological factors resulting in shifts in the equilibrium between contemporary ecological and evolutionary forces as they affect the production and extinction of biodiversity. More than anything else, there is an urgent need for humans to moderate their activities to bring them into line

with natural ecological processes. The sustainable management of biodiversity will depend upon our ability to predict the capacity of ecosystems to respond to alterations in specific biodiversity components, and to incorporate these findings into adaptive management plans before it is too late. This requires prior knowledge of total biodiversity, of the strength of species links, and above all of the ecological processes that maintain biodiversity.

This assessment shows that much past work on patterns of diversity has been documentary, and concentrated at the global and regional scales. In order to solve many of the problems that lie ahead, careful assessment of local diversity and its relationship to the landscape scale is called for. With regard to the sustainable use of biodiversity components, one way of moving ahead quickly will be to assess the response of biodiversity across different groups of organisms in well-planned, experimental interventions of various intensities, and at spatial scales that are commensurate with the alterations caused by humans.

References

- American Association for the Advancement of Science 1990. *Large Marine Ecosystems: Patterns, processes and yields*. AAAS Press, Washington, D.C.
- Abele, L.G. 1984. Biogeography, colonization and experimental community structure of coral-associated crustaceans. In: Strong, D.R., Simberloff, D., Abele, L.G. and Thistle, A.B. (eds), *Ecological Communities: Conceptual issues and the evidence*. 123–137. Princeton University Press, Princeton, NJ.
- Adams, J.M. and Woodward, F.I. 1989. Patterns in tree species richness as a test of the glacial extinction hypothesis. *Nature* **339**: 699–701.
- Aho, J.M. 1990. Helminth communities of amphibians and reptiles: comparative approaches to understanding patterns and processes. In: Esch, G.W., Bush, A.O. and Aho, J.M. (eds), *Parasite Communities: Patterns and Processes*. 157–195. Chapman and Hall, London.
- Aho, J.M., and Bush, A.O. 1993. Community richness in parasites of some freshwater fishes from North America. In: Ricklefs, R.E. and Schluter, D. (eds), *Species Diversity in Ecological Communities: Historical and geographical perspectives*. 185–193. University of Chicago Press, Chicago.
- Alho, C. and Lacher, T. 1991. Mammalian conservation in the Pantanal of Brazil. In: Mares M. A. and Schmidly, D.J. (eds), *Latin American Mammalogy: History, biodiversity, and conservation*. 280–294. University of Oklahoma Press, Norman, Oklahoma.
- Arctander, P. and Fjeldsa, J. 1994. Avian tissue collections for DNA analysis. *Ibis* **136**: 359–360.
- Armesto, J.J., Rozzi, R., Miranda, P. and Sabag, C. 1987. Plant/frugivore interaction in South American temperate forest. *Revista Chilena de Historia Natural* **60**: 321–336.
- Armstrong, R.A., and McGehee, R. 1980. Competitive exclusion. *American Naturalist* **106**: 220–236.
- Arnolds, E., and Jansen, E. 1992. New evidence for changes in the macromycete flora of the Netherlands. *Nova Hedwigia* **55**: 325–351.

- Arroyo, M.T.K.** and Squeo, F. 1990. Relationship between plant breeding systems and pollination. In: Kawano, S. (ed.), *Biological Approaches and Evolutionary Trends in Plants*. 205–227. Academic Press, London.
- Arroyo, M.T.K.** and Uslar, P. 1993. Breeding systems in a temperate mediterranean-type climate montane sclerophyllous forest in Chile central. *Botanical Journal of the Linnean Society* **111**: 83–102.
- Arroyo, M.T.K.**, Sarukhan, J. and Raven, P. H. 1992. Biodiversity. In: Dooge, J.C.I., Goodman, G.T., la Rivière, J.W.M., Marton- Lefèvre, J., O'Riordan, T. and Praderie, F. (eds), *An Agenda of Science for Environment into the 21st Century*. 205–219. Cambridge University Press, Cambridge.
- Arroyo, M.T.K.**, Armesto, J.J., Squeo, F., and Gutiérrez, J. 1993. Global change: the flora and vegetation of Chile. In: Mooney, H.A., Fuentes, E., and Kronberg, B. (eds), *Earth System Response to Global Change: Contrasts between North and South America*. 239–264. Academic Press, New York.
- Arroyo, M.T.K.**, Cavieres, L., Marticorena, C. and Muñoz-Schick, M. 1995a. Convergence in the Mediterranean floras in central Chile and California: insights from comparative biogeography. In: Arroyo, M.T.K., Fox, M.D. and Zedler, P.H. (eds), *Ecology and Biogeography of Mediterranean Ecosystems in Chile, California and Australia*. 43–88. Springer-Verlag, New York.
- Arroyo, M.T.K.**, Riveros, M., Peñaloza, A., Cavieres, L. and Faggi, A.M. 1995b. Phytogeographic relationships and regional richness patterns of the cool temperate rainforest flora of southern South America. In: Lawford, R., Alaback, P. and Fuentes, E.R. (eds), *Forest and Riverine Systems of the West Coast of North and South America*. Springer-Verlag, Heidelberg (in press).
- Arroyo, M.T. K.**, Squeo, F. Armesto, J. and Villagrán, C. 1988. Effects of aridity on plant diversity in the northern Chile Andes. *Annals of the Missouri Botanical Garden* **75**: 55–78.
- Augsburger, C.K.** and Franson, S.E. 1988. Input of wind-dispersed seeds into light-gaps and forest sites in a Neotropical forest. *Journal of Tropical Ecology* **4**: 239–252.
- Axelrod, D.**, Arroyo, M.T. Kalin and Raven, P. 1991. Historical development of temperate vegetation in the Americas. *Revista Chilena de Historia Natural* **64**: 413–446.
- Baker, H.G.** 1955. Dimorphisms and monomorphism in the Plumbaginaceae. III. Correlation of geographical distribution patterns with dimorphism and monomorphism in *Limonium*. *Annals of Botany, New Series* **17**: 615–627.
- Baker, H.G.** 1967. Support for Baker's law – as a rule. *Evolution* **20**: 394–368.
- Baker, H.G.** and Cox, P.A. 1984. Further thoughts on dioecism and islands. *Annals of the Missouri Botanical Garden* **71**: 244–253.
- Baker, H.G.** and Stebbins, G.L. (eds) 1965. *The Genetics of Colonizing Species*. Academic Press, New York.
- Barrett, C.H.** 1985. Floral trimorphism and monomorphism in continental and island populations of *Eichhornia paniculata* (Spreng.) Solms. (Pontederiaceae). *Ecological Journal of the Linnean Society* **25**: 41–60.
- Baskin, Y.** 1994. California's ephemeral vernal pools may be a good model for speciation. *BioScience* **44**: 384–388.
- Bates, J.W.** and Farmer, A.M. (eds) 1992. *Bryophytes and Lichens in a Changing Environment*. Clarendon Press, Oxford.
- Beardsley, J.W.** 1991. Introduction of arthropod pests into the Hawaiian Islands. In: Muniappan, R., Marutani, M. and Denton, G.R.W. (eds), *Exotic Pests in the Pacific – Problems and Solutions. Micronesia, Suppl. 3*, 1–4. University of Guam Press, Mangilao.
- Begon, M.**, Harper, J.L. and Townsend, C.R. 1990. *Ecology. Individuals, populations, and Communities*. 2nd edn. Blackwell, Oxford.
- Bell, S.S.**, McCoy, E.D. and Mushinsky, H.R. (eds) 1991. *Habitat Structure: The physical arrangement of objects in space*. Chapman and Hall, London.
- Bibby, C.J.**, Crosby, M.J., Heath, M.F., Johnson, T.H., Long, A.J., Stattersfield, A.J. and Thirgood, S.J. 1992. *Putting Biodiversity on the Map: Global priorities for conservation*. ICBP, Cambridge.
- Blaschke, H.**, and Baumler, W. 1989. Mycophagy and spore dispersal by small mammals in Bavarian forests. *Forest Ecology and Management* **26**: 237–245.
- Box, E.O.** 1978. Geographical dimensions of terrestrial net and gross primary productivity. *Radiation and Environmental Biophysics* **15**: 305–322.
- Briand, F.** and Cohen J.E. 1987. Environmental correlates of food chain length. *Science* **238**: 956–960.
- Brooks, J.L.** (1950). Speciation in ancient lakes. *Quarterly Review Biology* **25**: 30–60, 131–171.
- Brooks, D.R.** and McLennan, D.A. 1991. *Phylogeny, Ecology and Behavior*. University of Chicago Press, Chicago.
- Brown, J.H.** 1973. Species diversity of seed-eating desert rodents in sand dune habitats. *Ecology* **54**: 775–787.
- Brown, J.H.** 1981. Two decades of homage to Santa Rosalia: Toward a general theory of diversity. *American Zoologist* **21**: 877–888.
- Brown, J.H.** 1987. The peninsular effect in Baja California: an entomological assessment. *Journal of Biogeography* **14**: 359–365.
- Brown, J.H.** 1988. Species diversity. In: Myers, A.A. and Gillet, P.S. (eds), *Analytical Biogeography*. 57–89. Chapman and Hall, London.
- Brown, J.H.** and Gibson, A.C. 1983. *Biogeography*. Mosby, St Louis, Missouri.
- Brown, J.H.** and Maurer, B.A. 1989. Macroecology: the division of food and space among species on continents. *Science* **243**: 1145–1150.
- Bullock, S.H.** 1985. Breeding systems in the flora of a tropical deciduous forest in Mexico. *Biotropica* **17**: 287–301.
- Bush, M.B.** and Whittaker, R.J. 1991. Krakatau: colonization patterns and hierarchies. *Journal of Biogeography* **18**: 341–356.
- Carlquist, S.** 1965. *Island life. A natural history of the islands of the world*. American Museum of Natural History, New York.
- Carlquist, S.** 1974. *Island Biology*. Columbia University Press, New York.
- Carson, H.L.** and Kaneshiro, K.Y. 1976. *Drosophila* of Hawaii: systematics and ecological genetics. *Annual Review of Ecology and Systematics* **7**: 311–345.
- Case, T.J.** and Cody, M.L. 1987. Testing theories of island biogeography. *American Scientist* **75**: 402–411.

- Caswell, H. 1977. Community structure: a neutral model analysis. *Ecological Monographs* **46**: 327–354.
- Chapin, F.S. 1980. The mineral nutrition of wild plants. *Annual Review of Ecology and Systematics* **11**: 233–260.
- Chapin, F.S., Vitousek, P.M. and Van Cleve, K. 1986. The nature of nutrient limitation in plant communities. *American Naturalist* **127**: 48–58.
- Chesson, P.L. 1986. Environmental variation and the coexistence of species. In: Diamond, J. and Case, T.J. (eds), *Community Ecology*. 240–256. Harper and Row, New York.
- Chesson, P.L. 1991. A need for niches. *Trends in Ecology and Evolution* **4**: 293–298.
- Clark, J.D. and Brandt S.A. (eds) 1984. *From Hunters to Farmers: The causes and consequences of food production in Africa*. University of California Press, Berkeley.
- Coddington, J.A., Griswold, C.E., Silva, D., Peñaranda, E. and Larcher, S.F. 1991. Designing and testing sampling protocols to estimate biodiversity in tropical ecosystems. In: Dudley, E.C. (ed.), *The Unity of Evolutionary Biology: Proceedings of the Fourth International Congress of Systematic and Evolutionary Biology*. 44–60. Dioscorides Press, Portland, Oregon.
- Cody, M.L. 1975. Towards a theory of continental species diversities: Bird distributions over Mediterranean habitat gradients. In: Cody, M.L. and Diamond, J.M. (eds), *Ecology and Evolution of Communities*. 214–257. Harvard University Press, Cambridge, Massachusetts.
- Colinvaux, P. 1993. *Ecology*, 2nd edn. John Wiley, New York.
- Colinvaux, P. and Steinitz-Kannan, M. 1980. Species richness and area in Galapagos and Andean lakes: equilibrium phytoplankton communities and a paradox of the zooplankton communities. In: Kerfoot, W.C. (ed.), *Evolution and Ecology of Zooplankton*. 697–712. University Press of New England, Hanover, NH.
- Colwell, R.K. and Hurr, G.C. 1994. Non-biological gradients in species richness and a spurious Rapoport effect. *American Naturalist* **144**: 570–595.
- Connell, J.H. 1978. Diversity in tropical rain forests and coral reefs. *Science* **199**: 1302–1310.
- Cook R.E. 1969. Variation in species density in North American birds. *Systematic Zoology* **18**: 63–84.
- Cooke, G.D. and Welsh, E.B. 1993. *Restoration and Management of Lakes and Reservoirs*, 2nd edn. Lewis Publishers, Boca Raton, Fla.
- Cornell, H.V. 1985a. Local and regional richness of cynipine gall wasps on California oaks. *Ecology* **66**: 1247–1260.
- Cornell, H.V. 1985b. Species assemblages of cynipid gall wasps are not saturated. *American Naturalist* **126**: 565–569.
- Cornell, H.V. 1993. Unsaturated patterns in species assemblages: the role of regional processes in setting local species richness. In: Ricklefs, R.E. and Schluter, D. (eds), *Species Diversity in Ecological Communities: Historical and geographical perspectives*. 243–252. University of Chicago Press, Chicago.
- Cornell, H.V. and Lawton, J.H. 1992. Species interactions, local and regional processes, and limits to the richness of ecological communities. *Journal of Animal Ecology* **61**: 1–12.
- Courtenay, W.R. and Stauffer, J.R. (eds) 1984. *Distribution, Biology, and Management of Exotic Fishes*. Johns Hopkins University Press, Baltimore, Md.
- Cowling, R.M. 1983. Diversity relations in Cape shrublands and other vegetation in the south eastern Cape, South Africa. *Vegetatio* **45**: 103–127.
- Cowling, R.M. (ed.) 1992. *The Ecology of Fynbos. Nutrients, fire and diversity*. Oxford University Press, Cape Town.
- Cowling, R.M. and Holmes, P.M. 1992. Endemism and speciation in a lowland flora from the Cape Floristic Region. *Biological Journal of the Linnean Society* **47**: 367–383.
- Cowling, R.M., Holmes, P.M. and Rebelo, A.G. 1992. Plant diversity and endemism. In: Cowling, R.M. (ed.), *The ecology of Fynbos. Nutrients, fire and diversity*. 62–112. Oxford University Press, Cape Town.
- Cox, G.W. and Ricklefs, R.E. 1977. Species diversity and ecological release in Caribbean land bird faunas. *Oikos* **28**: 113–122.
- Cracraft, J. 1973. Continental drift, paleoclimatology, and the evolution and biogeography of birds. *Journal of Zoological Research, London* **169**: 455–545.
- Cracraft, J. 1985a. Historical biogeography and patterns of differentiation within the South American avifauna: areas of endemism. *Ornithological Monographs* **36**: 49–84.
- Cracraft, J. 1985b. Biological diversification and its causes. *Annals of the Missouri Botanical Garden* **72**: 794–822.
- Crosby, A.W. 1986. *Ecological Imperialism: The biological expansion of Europe, 900–1900*. Cambridge University Press, Cambridge.
- Crowe, T.M. and Brooke, R.K. 1993. Review of Bibby *et al.* 1992. *Putting Biodiversity on the Map. Priority areas for global conservation*. ICBP, Cambridge. *Ostrich* **64**: 12.
- Cuellar, O. 1994. Biogeography of parthenogenetic animals. *Biogeographical* **70**: 1–13.
- Culotta, E. 1991. Biological immigrants under fire. *Science* **254**: 1444–1447.
- Currie, D.J. 1991. Energy and large-scale patterns of animal- and plant-species richness. *American Naturalist* **137**: 27–49.
- Currie, D.J. and Paquin, V. 1987. Large-scale biogeographical patterns of species richness of trees. *Nature* **329**: 326–327.
- Daniels, R.J.R. 1992. Geographical distribution patterns of amphibians in the Western Ghats, India. *Journal of Biogeography* **19**: 521–529.
- Daniels, R.J.R., Joshi, N.V. and Gadgil, M. 1992. On the effect of isolation on birds of the western Ghats, India. *PNAS* **89**: 5311–5315.
- Darlington, P.J. 1957. *Zoogeography*, John Wiley, New York.
- Davis, S.D., Heywood, V.H. and Hamilton, A.C. (eds), 1994–5. *Centres of Plant Diversity: A strategy for their conservation*. Vol. 1. Europe, Africa, South West Asia and the Middle East; Vol. 2. Asia, Australia and the Pacific; Vol. 3. The Americas. WWF and IUCN, IUCN Publications Unit, Cambridge.
- Denslow, J.S. 1980. Gap partitioning among tropical rainforest trees. *Biotropica*, Suppl. **12**: 47–55.
- Diamond, J.M. 1971. Comparison of faunal equilibrium turnover rates on a tropical island and temperate island. *Proceedings of the National Academy of Sciences USA* **68**: 2742–2745.
- Diamond, J.M. 1984. Historic extinctions: a Rosetta Stone for understanding prehistoric extinctions. In: Martin, P.S. and Klein, R.G. (eds), *Quaternary Extinctions: A prehistoric revolution*. 824–862. University of Arizona Press, Tucson.

- Diamond, J.M.** and Veitch, C.R. 1981. Extinctions and introductions in the New Zealand avifauna: cause and effect? *Science* **211**: 499–501.
- Dickinson, K.J.M., Mark, A.F.** and Dawkins, B. 1993. Ecology of lianoid and epiphytic communities in Podocarp rainforest, Haast Ecological District, New Zealand. *Journal of Biogeography* **20**: 687–705.
- Dixon, A.F.G., Kindlmann, P., Leps, J.** and Holman, J. 1987. Why are there so few species of aphids, especially in the tropics? *American Naturalist* **129**: 580–592.
- Drake, J.A.** 1990. Communities as assembled structures: do rules govern pattern? *Trends in Ecology and Evolution* **5**: 159–164.
- Drake, J.A.** 1991. Community assembly mechanics and the structure of an experimental species ensemble. *American Naturalist* **137**: 1–26.
- Drake, J.A., Mooney, H.A., di Castri, F., Groves, R.H., Kruger, F.J., Rejmanek, M.** and Williamson, M. (eds) 1989. *Biological Invasions: A global perspective*. SCOPE 37. John Wiley, Chichester.
- Duke, N.C.** 1993. Mangrove Floristics and Biogeography. In: *Tropical Mangrove Ecosystems*. Springer-Verlag, New York.
- Dumont, H.J.** 1994. On the diversity of Cladocera in the tropics. *Hydrobiologia* **272**: 27–38.
- Eastop, V.F.** 1978. Diversity of the *Sternorrhyncha* within major climatic zones. *Symposium of the Royal Entomological Society of London* **6**: 157–178.
- Edwards, C.** (ed.) 1990. *Microbiology of Extreme Environments*. Open University Press, Milton Keynes, UK.
- Ehrendorfer, F.** 1979. Reproductive biology in island plants. In: Bramwell, D. (ed.), *Plants and Islands*. 293–307. Academic Press, New York.
- Elton, C.S.** 1958. *The Ecology of Invasions by Animals and Plants*. Methuen, London, and Wiley, New York.
- Evans, H.C., Carrion, G.,** and Guzman, G.A. 1993. A new species of *Sphaerulina* and its *Ploeospora* anamorph with potential for biological control for *Mimosa pigra*. *Mycological Research* **97**: 59–67.
- Ewel, J.J., Mazzarino, M.J.** and Berish, C.W. 1991. Tropical soil fertility changes under monocultures and successional communities of different structure. *Ecological Applications* **1**: 289–301.
- Farrell, B.D.** and Mitter, C. 1993. Phylogenetic determinants of insect/plant community diversity. In: Ricklefs, R.E. and Schluter, D. (eds), *Species Diversity in Ecological Communities: Historical and geographical perspectives*. 253–266. University of Chicago Press, Chicago.
- Farrell, B.D., Mitter, C.** and Futuyma, D.J. 1992. Diversification at the insect–plant interface. *BioScience* **42**: 34–42.
- Ferry, B.W., Baddeley, M.S.** and Hawksworth, D.L. (eds) 1973. *Air Pollution and Lichens*. The Athlone Press, University of London, London.
- Fiedler, P.L.** 1986. Concepts of rarity in vascular plant species, with special reference to the genus *Calochortus* (Liliaceae). *Taxon* **35**: 502–518.
- Fiedler, P.L.** and Ahouse, J.J. 1992. Hierarchies of cause: towards an understanding of rarity in vascular plant species. In Fiedler, P.L. and Jain, S.K. (eds), *Conservation Biology. The theory and practice of nature conservation, preservation and management*. 23–47. Chapman and Hall, New York.
- Fischer, A.G.** 1960. Latitudinal variations in organic diversity. *Evolution* **14**: 64–81.
- Fogel, R.** 1992. Utility of spore length/width ratio in separating *Geopora cooperi* form *cooperi* and *G. cooperi* f. *gilkeyae*. *Mycologia* **84**: 124–127.
- Fox, M.D.** 1990. Mediterranean weeds: exchanges of invasive plants between the five Mediterranean regions of the world. In: di Castri, F., Hansen, A.J. and Deussche, M. (eds), *Biological Invasions in Europe and the Mediterranean Basin*. 179–200. Kluwer Academic Publishers, Dordrecht.
- Fox, M.D.** 1995. Australian mediterranean vegetation: intra and intercontinental comparisons. In: Arroyo, M.T.K., Zedler, P.H. and Fox, M.D. (eds), *Ecology and Biogeography of Mediterranean Ecosystems in Chile, California and Australia*. 137–159. Springer-Verlag, New York.
- Franklin, J.F.** 1993. Preserving biodiversity: species, ecosystems or landscapes? *Ecological Applications* **2**: 202–205.
- Fuentes, E.R.** 1976. Ecological convergence of lizard communities in Chile and California. *Ecology* **57**: 3–17.
- Fuentes, E.R.** and Muñoz, M.R. 1995. The human role in changing landscapes in central Chile: implications for intercontinental comparisons. In: Arroyo, M.T.K., Zedler, P.H. and Fox, M.D. (eds), *Ecology and Biogeography of Mediterranean Ecosystems in Chile, California and Australia*. 401–417. Springer-Verlag, New York.
- Gaston, K.** 1994. *Rarity*. Chapman and Hall, London.
- Gentry, A.H.** 1988. Changes in plant community diversity and floristic composition on environmental and geographical gradients. *Annals of the Missouri Botanical Garden* **75**: 1–34.
- Gentry, A.H.** 1992. Tropical forest biodiversity: distribution patterns and their conservational significance. *Oikos* **63**: 19–28.
- Gibbs Russell, G.E.** 1987. Preliminary floristic analysis of the major biomes in southern Africa. *Bothalia* **17**: 213–227.
- Gilbert, O.L.** 1986. Field evidence for an acid rain effect on lichens. *Environmental Pollution, A* **40**: 227–231.
- Goldberg, D.E.** and Miller T.E. 1990. Effects of different resource additions on species diversity in an annual plant community. *Ecology* **71**: 213–225.
- Goldblatt, P.** 1978. An analysis of the flora of Southern Africa: its characteristics, relationships and origins. *Annals of the Missouri Botanical Garden* **65**: 369–436.
- Grant, P.R.** 1970. Colonization of islands by ecologically dissimilar species of mammals. *Canadian Journal of Zoology* **48**: 545–555.
- Grassle, J.F.** 1989. Species diversity in deep-sea communities. *Trends in Ecology and Evolution* **4**: 464–469.
- Grassle, J.F.** 1991. Deep-sea benthic biodiversity. *BioScience* **51**: 464–469.
- Grassle, J.F.** and Maciolek, N.J. 1992. Deep-sea species richness: regional and local diversity estimates from quantitative bottom samples. *American Naturalist* **139**: 313–341.
- Grassle, J.F., Lasserre, P., McIntyre, A.D.** and Ray, G.C. 1991. Marine biodiversity and ecosystem function. *Biology International, Special Issue* **23**: i–iv, 1–19. IUBS, Paris.
- Greenwood, P.H.** 1984. African cichlids and evolutionary theories. In: Echelle, A.A. and Kornfield, I. (eds), *Evolution of Fish Species Flocks*. 141–154. University of Maine Press, Orono, Maine.

- Gressitt, J.L.** 1961. Problems in the zoogeography of Pacific and Antarctic Insects. *Pacific Insects Monograph* 2. Bishop Museum Press, Honolulu.
- Greuter, W.** 1991. Botanical diversity, endemism, rarity and extinction in the Mediterranean area: an analysis based on the published volumes of the Med-Checklist. *Botanika. Chronika* 10: 63–79.
- Groves, R.H. (ed.)** 1994. *Australian Vegetation*, 2nd edn. Cambridge University Press, Melbourne.
- Groves, R.H. and di Castri, F. (eds)** 1991. *Biogeography of Mediterranean Invasions*. Cambridge University Press, Cambridge.
- Grubb, P.J.** 1977. The maintenance of species richness in plant communities: the importance of the regeneration niche. *Botanical Review* 52: 107–145.
- Harris, G.C.** 1984. *The Fragmented Forest. Island Biogeography Theory and the Preservation of Biotic Diversity*. University of Chicago Press, Chicago.
- Hawkes, J.G.** 1983. *The Diversity of Crop Plants*. Harvard University Press, Cambridge, Mass.
- Hawkins, B.A.** 1990. Global patterns of parasitoid assemblage size. *Journal of Animal Ecology* 59: 57–72.
- Hawkins, B.A.** 1993. Refugia, host population dynamics and the genesis of parasitoid diversity. In: LaSalle, J. and Gauld, I.D. (eds), *Hymenoptera and Biodiversity*. 235–256. CAB International, Wallingford.
- Hawkins, B.A. and Compton, S.G.** 1992. African fig wasp communities: vacant niches and latitudinal gradients in species richness. *Journal of Animal Ecology* 61: 361–372.
- Hawksworth, D.L.** 1993 [1992]. Litmus test for ecosystem health: the potential of bioindicators in the monitoring of biodiversity. In: Swaminathan, M.S. and Jana, S. (eds), *Biodiversity, Implications for global food security*. 184–204. MacMillan India Ltd, Madras.
- Heck, K.L.** 1979. Some determination of the composition and abundance of motile macroinvertebrate species in tropical and temperate turtle grass (*Thalassia testudinum*) meadows. *Journal of Biogeography* 6: 183–197.
- Heiser, C.B.** 1973. *Seed to Civilization*. W.H. Freeman, San Francisco.
- Hemmer, H.** 1990. *Domestication*. Cambridge University Press, Cambridge.
- Hendrix, P.F., Parmelee, R.W., Crossley, D.A., Coleman, D.C., Odum, E.P. and Groffman, P.M.** 1986. Detritus food webs in conventional and no-tillage agroecosystems. *BioScience* 36: 374–380.
- Herbold, B. and Moyle, P.B.** 1986. Introduced species and vacant niches. *American Naturalist* 128: 751–760.
- Hickman, J.C. (ed.)** 1993. *The Jepson Manual. Higher plants of California*. University of California Press, Berkeley.
- Holloway, J.D.** 1987. Macrolepidoptera diversity in the Indo-Australian tropics: geographic, biotopic and taxonomic variation. *Biological Journal of the Linnean Society* 43: 101–109.
- Holloway, J.D. and Stork, N.E.** 1991. The dimensions of biodiversity: the use of invertebrates as indicators of human impact. In: Hawksworth, D.L. (ed.), *The Biodiversity of Microorganisms and Invertebrates: Its role in sustainable agriculture*. 37–62. CAB International, Wallingford.
- Hubble, S.P.** 1979. Tree dispersion, abundance, and diversity in a tropical dry forest. *Science* 203: 1299–1309.
- Humboldt, A. and Bonpland, A.** 1807. *Essai sur la géographie des plantes accompagné d'un tableau physique des régions équinoxiales*. Shoell, Paris; reprinted by Arno Press, New York (1977).
- Huston, M.** 1980. Soil nutrients and tree species richness in Costa Rican forests. *Journal of Biogeography* 7: 147–157.
- IUCN** 1987. *Centres of Plant Diversity. A guide and strategy for their conservation*. International Union for Conservation of Nature and Natural Resources, Richmond.
- Jaenike, J.** 1991. Mass extinction of European fungi. *Trends in Ecology and Evolution* 6: 174–175.
- Jaffr, T.** 1992. Floristic and ecological diversity of the vegetation on ultramafic rocks in New Caledonia. In: Baker, A.I.M., Prador, J. and Reeves, R. (eds), *The Vegetation of Ultramafic (Serpentine) Soils*. Intercept Ltd, Andover, UK.
- Jaksic, F.M. and Feinsinger, P.** 1991. Bird assemblages in temperate forests of North and South America: a comparison of diversity, dynamics, guild structure, and resource use. *Revista Chilena de Historia Natural* 64: 491–510.
- Jaksic, F.M. and Fuentes, E.R.** 1991. Ecology of a successful invader: the European rabbit in central Chile. In: Groves, R.H. and di Castri, F. (eds), *Biogeography of Mediterranean Invasions*. 273–283. Cambridge University Press, Cambridge.
- Janos, D.P.** 1983. Tropical mycorrhizas, nutrient cycles and plant growth. In: Sutton, S.L., Whitmore, T.C. and Chadwick, A.C. (eds), *Tropical Rainforest Ecology and Management*. 327–345. Special Publication 2, British Ecological Society. Blackwell Scientific Publishers, Oxford.
- Janzen, D.H.** 1967. Why mountain passes are higher in the tropics. *American Naturalist* 101: 233–249.
- Janzen, D.H.** 1981. The peak of North American ichneumonid species richness lies between 38° and 41° N. *Ecology* 62: 532–537.
- Jasper, D., Robson, A. and Abbott, L.** 1979. Phosphorus and formation of vesicular-arbuscular mycorrhizas. *Soil Biology and Biochemistry* 11: 501–505.
- Jenny, H.** 1980. *The Soil Resource: Origin and Behavior*. Springer-Verlag, New York.
- Johnson, M.P. and Simberloff, D.** 1974. Environmental determinants of island species numbers in the British Isles. *Journal of Biogeography* 1: 149–154.
- Johnson, M.P., Mason, L.G. and Raven, P.H.** 1968. Ecological parameters and plant species diversity. *American Naturalist* 102: 297–306.
- Jokiel, P. and Martinelli, F.J.** 1992. The vortex model of coral reef biogeography. *Journal of Biogeography* 19: 449–458.
- Karr, J.R.** 1977. Ecological correlates of rarity in a tropical forest bird community. *Auk* 94: 240–247.
- Karr, J.R.** 1982. Avian extinctions on Barro Colorado Island, Panama: a reassessment. *American Naturalist* 119: 220–239.
- Kaufman, L.** 1992. Catastrophic change in species-rich freshwater ecosystems: the lessons of Lake Victoria. *BioScience* 42: 846–858.
- Kauffman, E.G. and Fagerstrom, J.A.** 1993. The Phanerozoic evolution of reef diversity. In: Ricklefs, R.E. and Schluter, D. (eds), *Species Diversity in Ecological Communities: Historical and geographical perspectives*. 315–329. University of Chicago Press, Chicago.

- Keast, A.** 1961. Bird speciation on the Australian continent. *Bulletin of the Museum of Comparative Zoology, Harvard College* **123**: 305–495.
- Keddy, P.A.** 1990. Competitive hierarchies and radial organization in plant communities. In: Grace, J. and Tilman D. (eds), *Perspectives on Plant Competition*. Academic Press, San Diego.
- Kiester, A.R.** 1971. Species density of North American amphibians and reptiles. *Systematic Zoology* **20**: 127–137.
- Kikkawa, J. and Williams, E.E.** 1971. Altitudinal distributions of land birds in New Guinea. *Search* **2**: 24–69.
- Kingsland, S.** 1985. *Modeling Nature*. University of Chicago Press, Chicago.
- Kitching, R.L. and Jones, R.E.** (eds) 1981. *The Ecology of Pests: Some Australian case histories*. CSIRO Australia, Melbourne.
- Knoll, A.H.** 1986. Patterns of change in plant communities through geological time. In: Diamond, J. and Case, T.J. (eds), *Community Ecology*. 126–144. Harper and Row, New York.
- Kolasa, J. and Pickett, S.T.A.** 1991 (eds), *Ecological Heterogeneity*. Springer-Verlag, New York.
- Kuschel, G.** 1962. The Curculionidae of Gough Island and the relationships with the weevil fauna of the Tristan da Cunha group. *Proceedings of the Linnean Society, London* **173**: 69–78.
- Lack, D.** 1947. *Darwin's Finches*. Cambridge University Press, Cambridge.
- Lack, D.** 1976. *Island Biology Illustrated by the Land Birds of Jamaica*. University of California Press, Berkeley.
- Lasserre, P.** 1992. The role of biodiversity in marine ecosystems. In: Solbrig, O.T., van Emden, H.M. and van Oordt, P.G.W.J. (eds), *Biodiversity and Global Change*. 105–130. International Union of Biological Sciences, Paris.
- Latham, R.E. and Ricklefs, R.E.** 1993a. Global patterns of tree species richness in moist forests: energy–diversity theory does not account for variation in species richness. *Oikos* **67**: 325–333.
- Latham, R.E. and Ricklefs, R.E.** 1993b. Continental comparisons of temperate-zone tree species diversity. In: Ricklefs, R.E. and Schluter, D. (eds), *Species Diversity: Historical and Geographical Perspectives*. 294–314. University of Chicago Press, Chicago.
- Lawton, J.H., Lewinsohn, T.M., and Compton, S.G.** 1993. Patterns of diversity for the insect herbivores on bracken. In: R. E. Ricklefs and D. Schluter (eds), *Species Diversity in Ecological Communities: Historical and geographical perspectives*. 178–184. University of Chicago Press, Chicago.
- Lawton, J.H.** 1990a. Species richness and population dynamics of animal assemblages – patterns in body size-abundance space. *Philosophical Transaction of the Royal Society of London, B* **330**: 283–291.
- Lawton, J.H.** 1990b. Local and regional species-richness of bracken-feeding insects. In: Thomson, J.A. and Smith, R.T. (eds), *Bracken Biology and Management*. 197–202. Australian Institute of Agricultural Science, Sydney.
- Leal, J. and P. Bochet.** 1991. Distribution patterns and dispersal of prosobranch gastropods along a seamount chain in the Atlantic Ocean. *Journal of the Marine Biological Association of the United Kingdom* **71**: 11–25.
- Lewinsohn, T.W.** 1991. Insects in flower heads of Asteraceae in Southeast Brazil: a case study on tropical species richness. In: Price, P.W., Lewinsohn, T.M., Fernandes, G.W. and Benson, W.W. (eds), *Plant–animal Interactions: Evolutionary ecology in tropical and temperate regions*. 525–559. John Wiley, New York.
- Lewis, J.R.** 1964. *The Ecology of Rocky Shores*. English Universities Press, London.
- Lieth, H.** 1975. Modeling the primary productivity of the world. In: Lieth, H. and Whittaker, R.H. (eds), *Primary Productivity of the Biosphere*. Springer-Verlag, New York.
- Lodge, D.M.** 1993. Biological invasions: lessons for ecology. *Trends in Ecology and Evolution* **8**: 133–137.
- Long, J.L.** 1981. *Introduced Birds of the World*. Universe Books, New York.
- Lovejoy, T.E., Bierregaard, R.O., Jr., Rylands, A.B., Malcolm, J.R., Quintela, C.E., Harper, L.H., Brown, K.S., Jr., Powell, A.H., Powell, B.V.N., Schubart, H.O.R. and Hays, M.B.** 1986. Edge and other effects of isolation on Amazon forest fragments. In: Soulé, M.E. (ed.), *Conservation Biology: The science of scarcity and diversity*. 257–285. Sinauer Associates, Sunderland, Mass.
- Ludyanskiy, M.L., McDonald, D. and MacNeill, D.** 1993. Impact of the zebra Mussel, a bivalve invader. *BioScience* **43**: 533–544.
- MacArthur, J.W.** 1975. Environmental fluctuations and species diversity. In: Cody, M.L. and Diamond, J.M. (eds), *Ecology and Evolution of Communities*. 74–80. Harvard University Press, Cambridge, Mass.
- MacArthur, R.H.** 1972. *Geographical Ecology: Patterns in the distribution of species*. Harper and Row, New York.
- MacArthur, R.H., and MacArthur, J.** 1961. On bird species diversity. *Ecology* **42**: 594–598.
- MacArthur, R.H. and Wilson, E.O.** 1967. *The Theory of Island Biogeography*. Princeton University Press, Princeton, NJ.
- MacArthur, R.H., Diamond, J.M., and Karr, J.R.** 1972. Density compensation in island faunas. *Ecology* **53**: 330–342.
- Maem, S. and Colwell, R.K.** 1991. Ecological consequences of heterogeneity of consumable resources. In: Kolasa, J. and Pickett, S.T.A. (eds), *Ecological Heterogeneity*. 224–255. Springer-Verlag, New York.
- Magnuson, J.J., Benson, B.J. and McLain, A.S.** 1995. Insights on species richness and turnover from long-term ecological research: Fishes in north temperate lakes. *American Zoologist* (in press).
- Major, J.** 1963. A climatic index to vascular plant activity. *Ecology* **44**: 485–498.
- Malajczuk, N., Trappe, J.M., and Molina, R.** 1987. Interrelationships among some ectomycorrhizal trees, hypogeous fungi and small mammals: western Australian and northwestern American parallels. *Australian Journal of Ecology* **12**: 53–55.
- Maldonado, S., Arroyo, M.T.K., Marticorena, C., Muñoz, M. and León, P.** 1995. Utilidad de las bases de datos para estudios en biodiversidad: Evaluación preliminar de algunos parametros en las Asteráceas de Chile central (30–40 S). In: Linares, E. (ed.) (in press).
- Mares, M.A.** 1992. Neotropical mammals and the myth of Amazonian biodiversity. *Science* **255**: 976–979.
- Margulis, L. and Schwartz, K.V.** 1988. *Five Kingdoms: An illustrated guide to the phyla of life on Earth*. W.H. Freeman, New York.

- Martens, K., Goddeeris, B. and Coulter, G. (eds).** 1994. Speciation in ancient lakes. *Advances in Limnology* **44**: 1-508.
- Marticorena, C.** 1990. Contribución a la estadística de la flora vascular de Chile. *Gayana, Botánica* **47**: 85-113.
- Maser, C.M., Trappe, J.M., and Nussbaum, R.A.** 1978. Fungal-small mammal interrelationships with emphasis on Oregon coniferous forests. *Ecology* **59**: 799-809.
- May, R.M.** 1975a. *Stability and Complexity in Model Ecosystems*, 2nd edn. Princeton University Press, Princeton, NJ.
- May, R.M.** 1975b. Patterns of species abundance and diversity. In: Cody, M.L. and Diamond, J.M. (eds), *Ecology and Evolution of Communities*. 81-120. Harvard University Press, Cambridge, Mass.
- May, R.M.** 1994. Biological diversity: differences between land and sea. *Philosophical Transactions of the Royal Society, B* **343**: 105-111.
- McCoid, M.J.** 1991. Brown tree snake (*Bioga irregularis*) on Guam: a worst case scenario of an introduced predator. In: Muniappan, R., Marutani, M. and Denton, G.R.W. (eds), *Exotic Pests in the Pacific - Problems and solutions. Micronesia, Suppl. 3*. 63-69. University of Guam Press, Mangilao.
- McCoy, E.D. and Heck, K.L., Jr** 1976. Biogeography of corals, seagrasses and mangroves: An alternative to the center of origin concept. *Systematic Zoology* **25**: 201-210.
- McGowan, J.A. and Walker, P.W.** 1993. Pelagic diversity patterns. In: Ricklefs, R.E. and Schluter, D. (eds), *Species Diversity in Ecological Communities: Historical and geographical perspectives*. 203-214. University of Chicago Press, Chicago.
- McIlveen, W.D. and Cole, H.** 1976. Spore dispersal of Endogonaceae by worms, ants wasps and birds. *Canadian Journal of Botany* **54**: 1486-1489.
- McIntyre, S.** 1992. Risks associated with the setting of conservation priorities from rare plant species lists. *Biological Conservation* **60**: 31-37.
- McMullen, C.K.** 1987. Breeding systems of selected Galapagos Islands angiosperms. *American Journal of Botany* **74**: 1694-1705.
- McNeill, S.E. and Fairweather P.G.** 1993. Single large or several small marine reserves? An experimental approach with seagrass fauna. *Journal of Biogeography* **20**: 429-440.
- Meserve, P.L. and Glanz, W.E.** 1978. Geographical ecology of small mammals in the northern Chilean arid zone. *Journal of Biogeography* **5**: 135-148.
- Meyer, A., Kocher, T.D., Basasibwaki, P. and Wilson, A.C.** 1990. Monophyletic origin of Lake Victoria cichlid fishes suggested by mitochondrial DNA sequences. *Nature*, **347**: 550-553.
- Mooney, H.A. (ed.)** 1977. *Convergent Evolution in Chile and California: Mediterranean climate ecosystems*. Dowden, Hutchinson, and Ross, Stroudsburg, Pennsylvania.
- Mooney, H.A. and Drake, J. (eds)** 1986. *Ecology of Biological Invasions of North America and Hawaii*. Springer-Verlag, New York.
- Moore, D.** 1983. *Flora of Tierra del Fuego*. Anthony Nelson, England.
- Moore, J.C., Walter, D.E. and Hunt, H.W.** 1989. Habitat compartmentation and environmental correlates of food chain length. *Science* **243**: 238-239.
- Myers, N.** 1988. Threatened biotas: 'hot spots' in tropical forests. *The Environmentalist* **8**: 187-208.
- Myers, N.** 1990. The biological challenge: extended hot-spots analysis. *The Environmentalist* **10**: 243-256.
- Nelson, G. and Platnick, N.** 1981. *Systematics and Biogeography: cladistics and vicariance*. Columbia University Press, New York.
- Newmark, W.D.** 1991. Tropical forest fragmentation and local extinction of understory birds in the Eastern Usambara Mountains, Tanzania. *Conservation Biology* **5**: 67-78.
- Niklas, K.J., Tiffney, B.H. and Knoll, A.H.** 1983. Patterns in vascular plant land diversification. *Nature* **303**: 614-616.
- Noss, R.F.** 1983. A regional landscape approach to maintain diversity. *BioScience* **33**: 700-706.
- O'Connor, R.J.** 1986. Biological characteristics of invaders among bird species in Britain. *Philosophical Transactions of the Royal Society of London, B* **314**: 583-598.
- Opler, P.A.** 1974. Oaks as evolutionary islands for leaf-mining insects. *American Scientist* **62**: 67-73.
- Orians, G.H. and Solbrig, O.T. (eds)** 1977. *Convergent Evolution in Warm Deserts*. Dowden, Hutchinson and Ross, Stroudsburg, Pennsylvania.
- Osman, R.W. and Whitlatch, R.B.** 1978. Patterns of species diversity: fact or artifact? *Paleobiology* **4**: 41-54.
- Otte, D. and Endler, J.A. (eds)** 1989. *Speciation and its consequences*. Sinauer Associates, Sunderland, Mass.
- Owen, J.G.** 1988. On productivity as a predictor of rodent and carnivore diversity. *Ecology* **69**: 1161-1165.
- Pandolfi, J.M.** 1992. Successive isolation rather than evolutionary centres for the origination of Indo-Pacific reef corals. *Journal of Biogeography* **19**: 593-609.
- Parrotta, J.A.** 1993. Secondary forest regeneration on degraded tropical lands. The role of plantations as foster ecosystems. In: Lieth, H. and Lohmann, M. (eds), *Restoration of Tropical Forest Ecosystems*. 63-73. Kluwer Academic Publishers, Dordrecht.
- Patton, J.L. and Smith, M.F.** 1992. mtDNA phylogeny of Andean mice: A test of diversification across ecological gradients. *Evolution* **46**: 174-183.
- Pearson, O.P., and Ralph, C.J.** 1978. The diversity and abundance of vertebrates along an altitudinal gradient in Peru. *Memorias del Museo de Historia Natural 'Javier Prado' (Perú)* **18**: 1-97.
- Pianka, E.R.** 1967. On lizard species diversity: North American flatland deserts. *Ecology* **48**: 333-351.
- Pianka, E.R.** 1986. *Ecology and Natural History of Desert Lizards*. Princeton University Press, Princeton, NJ.
- Pianka, E.R. and Schall, J.J.** 1981. Species densities of Australian vertebrates. In: Keast, A. (ed.), *Ecological Biogeography of Australia*. 1675-1694. Junk, The Hague.
- Platnick, N.I.** 1992. On the spider subfamily Zavatticinae (Araneae, Gnaphosidae). *Journal of the New York Entomological Society* **100**: 178-179.
- Poore, G.** 1993. Marine species richness. *Nature* **361**: 597-598.
- Power, D.M.** 1972. Numbers of bird species on the California islands. *Evolution* **26**: 451-463.
- Prendergast, J.R., Quinn, R.M., Lawton, J.H., Eversham, B.C. and Gibbons, D.W.** 1993. Rare species, the coincidence of diversity of hotspots and conservation strategies. *Nature* **365**: 335-337.

- Price, P.W.** 1991. Patterns in communities along latitudinal gradients. In: Price, P.W., Lewinsohn, T.M., Fernandes, G.W. and Benson, W.W. (eds), *Plant-animal Interactions: Evolutionary Ecology in tropical and temperate regions*, 51–69. John Wiley, New York.
- Proctor, J., Lee, Y.F., Langley, A.M., Munro, W.R.C. and Nelson, T.N.** 1988. Ecological studies on Gunung Silam, a small ultrabasic mountain in Sabah. I. Environment, forest structure and floristics. *Journal of Ecology* **76**: 320–340.
- Pulliam, H.R.** 1988. Sources, sinks, and population regulation. *American Naturalist* **132**: 652–661.
- Purseglove, J.W.** 1968. *Tropical Crops. Dicotyledons*. Longman Group Ltd, London.
- Purseglove, J.W.** 1972. *Tropical crops. Monocotyledons*. Longman Group Ltd, London.
- Rabinowitz, D.** 1981. Seven forms of rarity. In: Singe, H. (ed.), *The Biological Aspects of Rare Plant Conservation*, 205–207. John Wiley, Chichester.
- Rabinowitz, D., Cairn, S. and Dillon, T.** 1986. Seven forms of rarity and their frequency in the flora of the British Isles. In: Soulé, M.E. (ed.), *Conservation Biology*, 182–209. Sinauer Associates, Sunderland, Mass.
- Rapoport, E.H.** 1982. *Aerography: Geographical strategies of species*, Vol. 1. Pergamon, New York.
- Raven, P.H. and Axelrod, D.I.** 1978. Origin and relationships of the California flora. *University of California Publications in Botany* **72**: 1–143.
- Ray, C. and Ciampi, E.** 1956. *The Underwater Guide to Marine Life*. A.S. Barnes and Co.
- Reid, J.L., Brinton, E., Fleminger, A., Venrick, E.L. and McGowan, J.A.** 1978. Ocean circulation and marine life. In: Carnock, H. and Deacon, G. (eds), *Advances in Oceanography: Proceedings of the General Symposium of the Joint Oceanographic Assembly (13–24 September, 1976, Edinburgh, Scotland)*, 66–130. Plenum Press, New York.
- Rex, M.A.** 1981. Community structure in the deep-sea benthos. *Annual Review of Ecology and Systematics* **12**: 331–353.
- Rex, M.A., Stuart, C.T., Hessler, R.R., Allen, J.A., Sanders, H.L. and Wilson, G.D.F.** 1993. Global-scale latitudinal patterns of species diversity in the deep-sea benthos. *Nature* **365**: 636–639.
- Rey, J.R.** 1981. Ecological biogeography of arthropods on *Spartina* islands in northwest Florida. *Ecological Monographs* **51**: 237–265.
- Rice, B. and Westoby, M.** 1983. Plant species richness at the 0.1 ha scale in Australian vegetation compared to other continents. *Vegetatio* **52**: 129–140.
- Richardson, D.H.S.** 1992. *Polution Monitoring with Lichens. Naturalist's Handbook 19*. Richmond Publishing Company, Slough, UK.
- Richardson, D.M., Macdonald, I.A.W., Holmes, P.M. and Cowling, R.M.** 1992. Plant and animal invasions. In: Cowling, R.M. (ed.), *The Ecology of Fynbos*, 271–308. Oxford University Press, Cape Town.
- Richerson, P.J. and Lum, K.** 1980. Patterns of plant species diversity in California: relation to weather and topography. *American Naturalist* **116**: 504–536.
- Ricklefs, R.E.** 1977a. Environmental heterogeneity and plant species diversity: a hypothesis. *American Naturalist* **111**: 376–381.
- Ricklefs, R.E.** 1977b. Review of David Lack, *Island Biogeography Illustrated by the Land Birds of Jamaica*. *Auk* **94**: 794–797.
- Ricklefs, R.E.** 1987. Community diversity: relative roles of local and regional processes. *Science* **235**: 167–171.
- Ricklefs, R.E.** 1989. Speciation and diversity: integration of local and regional processes. In: Otte, D. and Endler, J. (eds), *Speciation and its Consequences*, 599–622. Sinauer Associates, Sunderland, Mass.
- Ricklefs, R.E. and Cox, G.W.** 1972. Taxon cycles and the West Indian avifauna. *American Naturalist* **106**: 195–219.
- Ricklefs, R.E. and Cox, G.W.** 1978. Stage of taxon cycle, habitat distribution, and population density in the avifauna of the West Indies. *American Naturalist* **112**: 875–895.
- Ricklefs, R.E. and Latham, R.E.** 1993. Global patterns of diversity in mangrove floras. In: Ricklefs, R.E. and Schluter, D. (eds), *Species Diversity: Historical and geographical perspectives*, 215–229. University of Chicago Press, Chicago.
- Ricklefs, R.E., Naveh, Z. and Turner, R.E.** 1984. Conservation of ecological processes. *Environmentalist* **4**, Supplement 8: 1–16.
- Ricklefs, R.E. and Renner, S.S.** 1994. Species richness within families of flowering plants. *Evolution* **48**: 1619–1636.
- Ricklefs, R.E. and Schluter, D.** 1993. Species diversity: regional and historical influences. In: Ricklefs, R.E. and Schluter, D. (eds), *Species Diversity in Ecological Communities: Historical and geographical perspectives*, 350–363. University of Chicago Press, Chicago.
- Riveros, M., Humaña, A.M. and Lanfranco, D.** 1991. Actividad de los polinizadores en el Parque Nacional Puyehue, X. Región, Chile. *Medio Ambiente* **11**: 5–12.
- Rohde, K., Heap, M. and Heap, D.** 1993. Rapoport's rule does not apply to marine teleosts and cannot explain latitudinal gradients in species richness. *American Naturalist* **142**: 1–16.
- Rosenzweig, M.L.** 1968. Net primary productivity of terrestrial environments: predictions from climatological data. *American Naturalist* **102**: 67–84.
- Rosenzweig, M.L. and Abramsky, Z.** 1993. How are diversity and productivity related? In: Ricklefs, R.E. and Schluter, D. (eds), *Species Diversity in Ecological Communities: Historical and geographical perspectives*, 52–65. University of Chicago Press, Chicago.
- Ryvarden, L.** 1993. Tropical polypores. In: Isaac, S., Frankland, J.C., Watling, R. and Whalley, A.J.S. (eds), *Aspects of Tropical Mycology*, 149–170. Cambridge University Press, Cambridge.
- Safir, G.R. (ed.)**, 1987. *Ecophysiology of VA Mycorrhizal Plants*. CRC Press, Boca Raton, Fla.
- Sakai, A.K., Karoly, K. and Weller, S.** 1989. Inbreeding depression in *Schiedea globosa* and *S. salicaria* (Caryophyllaceae), subdioecious and gynodioecious Hawaiian species. *American Journal of Botany* **76**: 437–444.
- Sale, P.F.** 1977. Maintenance of high diversity in coral reef fish communities. *American Naturalist* **111**: 337–359.
- Santelices, B.** 1989. *Algas Marinas de Chile*. Ediciones Universidad Católica de Chile, Santiago.
- Savidge, J.A.** 1987. Extinction of an island forest avifauna by an introduced snake. *Ecology* **68**: 660–668.
- Schall, J.J. and Pianka, E.R.** 1978. Geographical trends in number of species. *Science* **201**: 679–686.

- Scheibe, J.S.** 1987. Climate, competition, and the structure of temperate zone lizard communities. *Ecology* **68**: 1424–1436.
- Scheltema, R.** and Williams, I. 1983. Long-distance dispersal of planktonic larvae and the biogeography and evolution of some Polynesian and western Pacific mollusks. *Bulletin of Marine Science* **33**: 545–565.
- Schindler, D. W.** 1990. Experimental perturbations of whole lakes as test of hypotheses concerning ecosystem structure and function. *Oikos* **57**: 25–41.
- Schluter, D.** and Ricklefs, R.E. 1993. Convergence and the regional component of species diversity. In: Ricklefs, R.E. and Schluter, D. (eds), *Species Diversity: Historical and geographical perspectives*. 230–240. University of Chicago Press, Chicago.
- Scriber, J.M.** 1973. Latitudinal gradients in larval feeding specialization of the World Papilionidae (Lepidoptera). *Psyche* **80**: 355–373.
- Segers, H.**, Nwadiaro, C.S. and Dumont, H.J. 1992. Rotifera of some lakes in the floodplain of the River Niger (Imo State, Nigeria). II. Faunal composition and diversity. *Hydrobiologia* **250**: 63–71.
- Seib, R.L.** 1980. Baja California; a peninsula for rodents but not for reptiles. *American Naturalist* **115**: 613–620.
- Sepkoski, J.J.** 1992. Phylogenetic and ecological patterns in the Phanerozoic history of marine biodiversity. In: Eldredge, N. (ed.), *Systematics, Ecology and the Biodiversity Crisis*. 77–100. Columbia University Press, New York.
- Sherman, K.** 1994. Sustainability, biomass yields, and health of coastal ecosystems: an ecological perspective. *Marine Ecology Progress Series* **112**: 277–301.
- Shmida, A.** and Ellner, S. 1984. Coexistence of plant species with similar niches. *Vegetatio* **58**: 29–55.
- Shmida, A.** and Wilson, M.V. 1985. Biological determinants of species diversity. *Journal of Biogeography* **12**: 1–20.
- Simberloff, D.** 1976. Trophic structure determination and equilibrium in an arthropod community. *Ecology* **57**: 395–398.
- Simberloff, D.** 1981. Community effects of introduced species. In: Nitecki, M.H. (ed.), *Biotic Crises in Ecological and Evolutionary Time*. 53–81. Academic Press, New York.
- Simberloff, D.S.** and Wilson, E.O. 1969. Experimental zoogeography of islands: the colonization of empty islands. *Ecology* **50**: 278–296.
- Simkin, T.** and Fiske, R.S. 1983. *Krakatau 1883: The volcanic eruption and its effects*. Smithsonian Institution Press, Washington, DC.
- Simpson, G.G.** 1964. Species density of North American recent mammals. *Systematic Zoology* **13**: 57–73.
- Smith, A.P.** 1972. Buttressing of tropical trees: a descriptive model and new hypotheses. *American Naturalist* **106**: 32–46.
- Stanton, N.L.** 1979. Patterns of species diversity in temperate and tropical litter mites. *Ecology* **60**: 295–304.
- Stehli, F.G.**, Douglas, R.G. and Newell, N.D. 1969. Generation and maintenance of gradients in taxonomic diversity. *Science* **164**: 947–949.
- Stehli, F.G.**, McAlester, A.L. and Helsley, C.E. 1967. Taxonomic diversity of recent bivalves and some implications for geology. *Geological Society of America Bulletin* **78**: 455–466.
- Stephenson, N.L.** 1990. Climatic control of vegetation distribution: the role of the water balance. *American Naturalist* **135**: 649–670.
- Stevens, G.C.** 1986. Dissection of the species-area relationship among wood-boring insects and their host plants. *American Naturalist* **128**: 35–46.
- Stevens, G.C.** 1989. The latitudinal gradient in geographical range: how so many species coexist in the tropics. *American Naturalist* **133**: 240–256.
- Stevens, G.C.** 1992. The elevational gradient in altitudinal range: an extension of Rapoport's latitudinal rule to altitude. *American Naturalist* **140**: 893–911.
- Stork, N.E.** 1988. Insect diversity: facts, fiction and speculation. *Biological Journal of the Linnean Society* **35**: 321–337.
- Stork, N.E.** 1995. Measuring global biodiversity and its decline. In: Reaka-Kudla, M.L., Wilson, D.E. and Wilson, E.O. (eds), *Biodiversity II: Understanding and protecting our natural resources* (in press).
- Taylor, C.M.** 1993. Revision of *Palaicurea* (Rubiaceae: Psychotriaceae) in the West Indies. *Moscovia* **7**: 201–241.
- Taylor, L.R.** and Regal, P.J. 1978. The peninsular effect on species diversity and the biogeography of Baja California. *American Naturalist* **112**: 583–593.
- Taylor, W.D.** 1979. Sampling data on the bacterivorous ciliates of a small pond compared to neutral models of the community structure. *Ecology* **60**: 876–883.
- Terborgh, J.** 1973. On the notion of favorableness in plant ecology. *American Naturalist* **112**: 583–593.
- Terborgh, J.** 1975. Faunal equilibria and the design of wildlife preserves. In: Golley, F.B. and Medina, E. (eds), *Tropical Ecological Systems: Trends in terrestrial and aquatic research*. 369–380. Springer-Verlag, New York.
- Terborgh, J.** 1977. Bird species diversity on an Andean elevational gradient. *Ecology* **50**: 1007–1019.
- Terborgh, J.W.** and Faaborg, J. 1980. Saturation of bird communities in the West Indies. *American Naturalist* **116**: 178–195.
- Thiollay, J.M.** 1992. Influence of selective logging on bird species diversity in a Guianan rain forest. *Conservation Biology* **6**: 477–63.
- Thorson, G.** 1957. Bottom communities (sublittoral and shallow shelf). In: Ladd, H. (ed.), *Treatise on Marine Ecology and Paleocology*. Geological Society of America Memoir 67.
- Tilman, D.** 1982. *Resource Competition and Community Structure*. Princeton University Press, Princeton, NJ.
- Tilman, D.** 1994. Competition and biodiversity in spatially structured habitats. *Ecology* **75**: 2–16.
- Tomlinson, P.B.** 1986. *The Botany of Mangroves*. Cambridge University Press, Cambridge.
- Trüper, H.G.** 1992. Prokaryotes: an overview with respect to biodiversity and environmental importance. *Biodiversity and Conservation* **1**: 227–236.
- Tunnicliffe, V.** 1991. The biology of hydrothermal vents: ecology and evolution. *Oceanography and Marine Biology Annual Review* **29**: 319–407.
- Turner, J.R.G.**, Lennon, J.J. and Lawrenson, J.A. 1988. British bird distributions and the energy theory. *Nature* **335**: 539–541.
- Tuomisto, H.** 1994. *Ecological Variation in the Rain Forest of Peruvian Amazonia: Integrating fern distribution patterns with satellite imagery*. Rep. Dept. Biol. Univ. Turku.

- Underwood**, A.J. and Fairweather, P.G. 1989. Supply-side ecology and benthic marine assemblages. *Trends in Ecology and Evolution* **4**: 16–20.
- Valencia**, R., Balslev, H. and Paz y Mio, G. 1994. High tree alpha-diversity in Amazonian Ecuador. *Biodiversity Conservation* **3**: 21–28.
- Vane-Wright**, R.I., Humphries, C.J. and Williams, P.H. 1991. What to protect? Systematics and the agony of choice. *Biology and Conservation* **55**: 235–254.
- Van Riper**, C., Van Riper, S.G., Goff, M.L. and Laird, M. 1986. The epizootiology and ecological significance of malaria in Hawaiian land birds. *Ecological Monographs* **56**: 327–344.
- Vermeij**, G.J. 1991. When biotas meet: understanding biotic interchange. *Science* **182**: 449–455.
- Vermeij**, G., Kay, E.A., and Eldredge, L. 1985. Molluscs of the northern Mariana Islands, with special reference to the selectivity of ocean dispersal barriers. *Micronesica* **19**: 27–55.
- Vitousek**, P.M., Waller, L.R., Whiteaker, L.D. and Matson P.A. 1993. Nutrient limitation to plant growth during primary succession in Hawaii Volcanoes National Park. *Biogeochemistry* **23**: 197–215.
- Waage**, J.K. 1991. Biodiversity as a resource for biological control. In: Hawksworth, D.L. (ed.), *The Biodiversity of Microorganisms and Invertebrates: Its role in sustainable agriculture*. 149–163. CAB International, Wallingford.
- Wagner**, W.L., Herbst, D.R. and Sohmer, S.H. 1990. *Manual of Flowering Plants of Hawaii*. Vol. 2. University of Hawaii Press, Honolulu.
- Warwick**, R.M. and Ruswahyuni. 1987. Comparative study of the structure of some tropical and temperate marine soft-bottom macrobenthic communities. *Marine Biology* **95**: 641–649.
- WCMC** 1992. *Global Biodiversity: Status of the Earth's living resources*. WCMC, Cambridge.
- Webb**, S.D. 1991. Ecogeography and the Great American interchange. *Paleobiology* **17**: 266–280.
- Webb**, C.J. and Kelly, D. 1993. The reproductive biology of the New Zealand flora. *Trends in Ecology and Evolution* **8**: 442–447.
- Webb**, C.J., Sykes, W.R., and Garnock-Jones, P. J. 1988. *Flora of New Zealand*, Vol IV. *Naturalised Pteridophytes, Gymnosperms, Dicotyledons*. Botany Division, DSIR., Christchurch.
- Westoby**, M. 1985. Two main relationships among the components of species richness. *Proceedings of the Ecological Society of Australia* **14**: 103–107.
- Whittaker**, R.H. 1954. The ecology of serpentine soils. IV. The vegetational response to serpentine soils. *Ecology* **35**: 275–288.
- Whittaker**, R.H. 1975. *Communities and Ecosystems*. 2nd edn. Macmillan, New York.
- Whittaker**, R.J. and Jones, S.H. 1994. Structure in re-building insular ecosystems: an empirically derived model. *Oikos* **64**: 524–530.
- Wiens**, J.A. 1983. Avian community ecology: an iconoclastic view. In: Brush, A.H. and Clark, G.A. (eds), *Perspectives in Avian Ornithology*. Cambridge University Press, Cambridge.
- Wiens**, J.A. 1989. *The ecology of bird communities*. Vols. 1 and 2. Cambridge University Press, Cambridge, UK.
- Williams**, C.B. 1964. *Patterns in the Balance of Nature*. Academic Press, London.
- Williams**, W.D. 1981. Inland salt lakes. *Hydrobiologia* **81**: 1–14.
- Williams**, P.H. and Gaston, K.J. 1994. Measuring more of biodiversity: can higher-taxon richness predict wholesale species richness? *Biological Conservation* **67**: 211–217.
- Williams**, P.H. and Humphries, C.J. 1994. Biodiversity, taxonomic relatedness, and endemism in conservation. In: Forey, P.L., Humphries, C.J. and Vane-Wright, R.I. (eds), *Systematics and Conservation Evaluation*. 269–287. Clarendon Press, Oxford.
- Williams**, P.H., Humphries, C.J. and Gaston, K.J. 1994. Centre of seed-plant diversity the family way. *Proceedings of the Royal Society of London, B* **256**: 67–70.
- Williamson**, M. 1981. *Island Populations*. Oxford University Press, Oxford.
- Willis**, E.O. 1969. On the behavior of five species of *Rhegmatorhina*, ant-following antbirds of the Amazon basin. *Wilson Bulletin* **81**: 363–395.
- Willis**, E.O. 1979. The composition of avian communities in luminescent woodlots in southern Brazil. *Papéis Avulsos de Zoologia, São Paulo* **33**: 1–25.
- Wilson**, E.O. and Taylor, R.W. 1967. An estimate of the potential evolutionary increase in species density in the Polynesian ant fauna. *Evolution* **21**: 1–10.
- Wright**, D.H. 1983. Species–energy theory: an extension of species–area theory. *Oikos* **41**: 496–506.
- Wright**, D.H. 1990 Human impacts on energy flow through natural ecosystems, and implications for species endangerment. *Ambio* **19**: 189–194.
- Wright**, D.H. 1992. Seasonal drought, soil fertility, and the species diversity of tropical forest communities. *Trends in Ecology and Evolution* **7**: 260–263.
- Wright**, D.H., Currie, D.J. and Maurer, B.A. 1993. Energy supply and patterns of species richness on local and regional scales. In: Ricklefs, R.E. and Schluter, D. (eds), *Species Diversity: Historical and geographical perspectives*. 66–74. University of Chicago Press, Chicago.
- Wunderle**, J.M. 1985. An ecological comparison of the avifaunas of Grenada and Tobago, West Indies. *Wilson Bulletin* **97**: 356–365.
- Zaret**, T.M. and Paine, R.T. 1973. Species introduction in a tropical lake. *Science* **182**: 449–455.
- Zwölfer**, H. 1987. Species richness, species packing, and evolution in insect–plant systems. *Ecological Studies* **61**: 301–319.

3.3 Endemism and biodiversity

3.3.1 Endemism: concepts and perspectives

This chapter outlines the conceptual and empirical issues relating to endemism and how patterns of endemism are influenced by spatial scale, taxon age and relationships, population abundance and different human perceptions and biases.

3.3.1.1 Background

Endemic taxa are those restricted to a specified geographical area. Thus, the concept of endemism, as presently conceived, is a relative one, and the endemic status can have varying biological significance depending on the size and location of the geographical area under consideration. Endemism as a concept has a long history in biology, dating back to De Candolle (1820). As a research topic, however, endemism has attracted little attention in the field of modern biogeography. Much early research on endemism pertained to vascular plants in temperate areas, for which several reviews have appeared over the past two decades (Prentice 1976; Kruckeberg and Rabinowitz 1985; Gentry 1986; Major 1988). In the tropics, where surveys of endemism began somewhat later, vascular plants, birds and butterflies have been studied. Reviews on endemism for animal groups have focused on island endemics (e.g. Briggs 1966; McDowall 1968; Johnson and Stattersfield 1990; Groombridge 1993), Australasian vertebrates (Cracraft 1991) and global bird faunas (ICBP 1992). Few studies to date have considered fossil information. For example, the perception of endemism in New Caledonian birds changed after it was discovered that rats introduced by humans induced extinction in the fragile sclerophyllous ecosystems of the west coast of the island (Balouet and Olson 1989; Chazeau 1993).

3.3.1.2 Categories of endemics

Endemics may be categorized according to their spatial distribution, inferred evolutionary age and affinities, and abundance. In terms of spatial distribution, endemics may occupy limited geographical ranges – i.e. have a limited ‘extent of occurrence’ – and also have a limited ‘area of occupation’ within their geographical range (Gaston 1991). At the other extreme, they may have relatively large absolute geographical ranges when the circumscribed geographical area is extensive (e.g. the continent of Australia), and often be abundant within those large ranges. To a degree, recognition of endemic status relies on the relative size of the geographical range of the species, genus or other higher taxon under consideration, in relation to the total range of the genus, family, etc. to which that taxon belongs (cf. Bykov 1983; Williams *et al.* 1993).

In practice, endemics are loosely and commonly categorized in four contexts:

1. Site or restricted area (e.g. arthropod groups on individual summits in the crystalline mountains of Tanzania; Lovett and Wasser 1993).

2. Biotope (e.g. as with *Quercus durata* confined to serpentine outcrops).
3. Biogeographical region (e.g. as for turkeys, Meleagridinae, confined to the Neartic Biogeographical Region).
4. Political area (e.g. as with the maned sloth *Bradypus torquatus*, endemic to Brazil).

Engler (1882) provided one of the first classifications of endemics according to their evolutionary age. He recognized:

1. Neoendemics, comprising clusters of closely related species and subspecies that have evolved relatively recently (e.g. the hundreds of species of cichlid fishes in Lake Malawi; Ribbink *et al.* 1983).
2. Palaeoendemics, comprising phylogenetically high-ranking taxa, usually monotypic sections, subgenera or genera that may be regarded as evolutionary relicts (e.g. *Welwitschia mirabilis* of the Namib Desert).

This classification has been greatly extended and widely used by botanists (e.g. Willis 1922; Cain 1944; Favarger and Constandriopoulos 1961; Stebbins and Major 1965; Hopper 1979), but rarely by zoologists (e.g. Machado 1992).

Cytological data, as indicated by a more comprehensive treatment of European mountain flora endemics (Favarger and Constandriopoulos 1961), can provide a more rigorous basis for assessing the relative age and affinities of plant endemics. In this study, four categories were recognized according to taxonomic rank and ploidy level:

1. Palaeoendemics — ancient isolated taxa with a high ploidy level, whose diploid ancestors are extinct or unknown.
2. Schizoendemics – vicariant species of equal ploidy level, resulting from either gradual or rapid divergence.
3. Patroendemics – restricted, diploid species that have spawned younger, widespread polyploid species.
4. Apoendemics – polyploid endemics that are derived from widespread species of a lower ploidy level.

Schizo-, patro- and apoendemics are further subdivisions of neoendemics.

Some problems associated with this classification are that (1) age is regarded as a categorical, rather than a continuous, variable (cf. Cronk 1987); (2) the establishment of relationships between taxa lacks rigour

(cf. Nelson and Platnick 1981); and (3) many paleoendemism are diploid (indeed, ancient relictual status is the most consistent attribute of this category; Stebbins and Major 1965).

Phylogenetic methods, which consider the distribution of characters among taxa in a cladistic context (Nelson and Platnick 1981; see Section 2.1), can be used to characterize endemics in terms of hypotheses of relative age and propinquity of descent. In this context, low-ranking taxa correspond to neoendemism and high-ranking taxa to palaeoendemism (e.g. Linder and Vlok 1991; Stiassny and di Pinna 1994). An absolute estimate of the age of endemics can be given when congruent phylogenetic relationships correlate with identifiable historical events (e.g. Rosen 1979; Cracraft 1986).

In contrast with treatment of the concept of rarity (3.2.1.5), the categorization of endemics according to their population abundance has received little attention. Geographic range as a categorical variable (wide/narrow) has been used as one of the factors in defining seven forms of rarity recognized for plants (Rabinowitz *et al.* 1986). Endemics (narrow range) may belong to any of four categories of rarity according to biotope specificity (broad or eurytopic/restricted or stenotopic) and local population size (somewhere large/everywhere small) (see also Gaston 1991, 1994). Most treatments of endemism emphasize biotope specificity, but few consider population size (but see Given and Norton 1992). There is an urgent need to categorize endemics more carefully in relation to their population abundance, since population size has important conservation implications (Mace *et al.* 1992; Mace 1993; IUCN 1995), and will be especially relevant when an endemic species is also a rare species. In South Africa, some highly localized endemic damselflies are by far the dominant species in their specialized habitats (Samways 1994b) and the discovery of these habitats and hence the species has meant that the status of the latter on the *Red List* has been altered from 'Endangered' to 'Rare'. This is not a general rule, however, because other South African damselflies are not only highly localized but also extremely rare.

3.3.1.3 A phylogenetic perspective

Patterns of endemism are central to vicariance or cladistic biogeography, a method that seeks to correlate phylogenetic patterns of monophyletic lineages with historical events (Nelson and Platnick 1981; Humphries and Parenti 1986). Many studies have focused on global patterns, and relationships have been sought among continent-wide areas of endemism (e.g. Crowe and Crowe 1982; Cracraft 1991). Increasingly, research is being carried out at a smaller spatial scale, with the areas of endemism defined by cladistic analyses corresponding to centres of local endemism, which are of much interest to conservation biologists (Platnick 1991; Samways 1992b).

Endemism is a topic around which historical biogeographers, conservation biologists and ecologists can interact meaningfully. Phylogenetic biogeographers can contribute significantly by determining sequences of speciation events, while ecologists and conservation biologists can supply the detailed ecological and palaeoecological information required to interpret the processes involved and the role of particular ecological scenarios in provoking endemism *per se*.

3.3.1.4 Biases

Endemism is influenced by taxonomic interpretation, sampling error and human perceptions of rarity. Of particular importance is the fact that limited geographical exploration, as well as variation in the application of taxonomic concepts, introduces biases in the identification of endemics and in the significance of their status (Kruckeberg and Rabinowitz 1985). Inadequate or uneven surveys may lead to the recognition of 'pseudoendemism', simply because the full geographic range of the taxon has not been sampled (Nelson *et al.* 1990). Pseudoendemism can be artefacts of excessive taxonomic splitting, and are 'lost' if taxa are aggregated into polytypic forms (Crowe *et al.* 1994). Pseudoendemism can also result when a large tract of a species' habitat is removed, thereby reducing its present geographical range. Habitat loss, on the other hand, may also result in the extinction of local endemics before they have been collected (Gentry 1992).

Different value systems and socioeconomic conditions introduce obvious biases into how endemic taxa are perceived in society. For example, in the biodiversity-depauperate but wealthy United Kingdom, extinction of the endemic subspecies of the large copper butterfly (*Lycaena dispar dispar*) stimulated a major re-establishment programme of the Netherlands subspecies (*L. dispar batava*; Duffey 1977). Such attention would be most unusual in many poorer but biologically richer countries in the tropics and in temperate areas of the southern hemisphere, unless the subject taxon was unusually charismatic or of national, regional or international importance.

3.3.2 Evaluating endemism

In quantifying patterns of endemism, the units of measurement (spatial scale and taxonomic entity) and the mode of reporting of the data (percentages or counts) influence the interpretation of results. Many studies on levels of endemism are insufficiently explicit about the evaluation methods employed. It is important to be unambiguous about defining and categorizing endemism, especially since it is often used as a criterion for identifying and prioritizing protected taxa and areas. Here, a clarification of the problems and approaches in the evaluation of endemism is proposed.

3.3.2.1 Units of measurement

Determining whether a species is endemic depends on the spatial scale of the host area (point locality, region, state, province, country, subcontinent, island, etc.) (Major 1988). Almost inevitably, larger centres of endemism have within them smaller centres, for example those for plants in New Caledonia (Gentry 1992). Range sizes for defining local endemism of species endemic to a given geographical area are often arbitrarily set. For example, Terborgh and Winter (1982), Gentry (1986) and ICBP (1992) define local endemics (birds and plants) to be those with geographical ranges of less than 50 000 km². In contrast, Cowling and Holmes (1992) set the geographical range limit for locally endemic plants in the Cape Floristic Region of South Africa as 2 000 km², a size that is appropriate for a region with a high concentration of both plant and insect (Samways 1994a) point endemics.

Bykov (1983) developed a quantitative index of higher plant endemism based on the linear relationship between percentage endemism (on a log scale) and the logarithm of land area (Figure 3.3-1). The line is defined at its upper end by 100% endemism for the Earth, and at its lower end by 1% endemism in 625 km². The latter value is arbitrary (considerably higher and lower values have been reported in the literature), although the precise slope of the line is little influenced by changes in endemism values over the range of 300 km² to a few thousand km². A quantitative index is $le = Ef/En$ where le is the index of endemism, Ef is the factual percentage of endemism, and En is the normal percentage of endemism, read off the line in Figure 3.3-1. A value of $le = 1$ indicates normal levels of endemism (e.g. Austria, Guinea, Libya and the United States in Figure 3.3-1); a value of below 1 (above the line) indicates less than average endemism (Burkina Faso, Denmark, Ireland and Niger); and a value of above 1 (below the line) indicates greater than average endemism (e.g. Australia, New Caledonia, New Zealand and South Africa). Bykov's index is the only quantitative measure of endemism available, although Major (1988) warns against its exclusive use as there may be a dearth of appropriate knowledge on taxonomy or ranges.

The endemic taxa of different regions can be evaluated on a continuous scale of range size when calculated as the sum of the inverse range sizes of all taxa in each quadrat (cell grid or map unit). There are several applications of this measure in the recent literature (e.g. Howard 1991; Williams 1993; Williams *et al.* 1994), although such analyses are not exclusive of endemism.

Evaluation of endemics must also consider the mobility of the taxa under consideration (Samways 1993a). Crowe and Brooke (1993), for example, point out that the 50 000 km² criterion employed by ICBP (1992) for identifying endemic birds disqualifies endemic species from arid areas because they are often, of necessity, highly mobile and

may, at any given time, occupy ranges of less than 50 000 km². This example is a good illustration of the need to distinguish between extent of occurrence and area of occupancy (Gaston 1991).

From all perspectives – ecological, biogeographical and conservation – patterns of endemism are best studied in relation to ecologically homogeneous, biogeographic areas (Major 1988). However, it will often be expedient to use a political unit such as country, state, municipality or reserve, as the geographic unit of reference, as this may be the most effective decision-making unit for the preservation of endemics. Ultimately, the unit used will be influenced by the questions posed for a particular investigation.

Patterns of endemism can also be influenced by the taxonomic or phylogenetic scale employed. For example, if the units of endemism are low-ranking taxa (subspecies or closely related species), centres with many such taxa, such as Lake Malawi with its array of recently evolved and genetically similar cichlid fish species (Ribbink *et al.* 1983; Meyer 1993), will feature prominently. However, if the units of endemism are high-ranking taxa, which

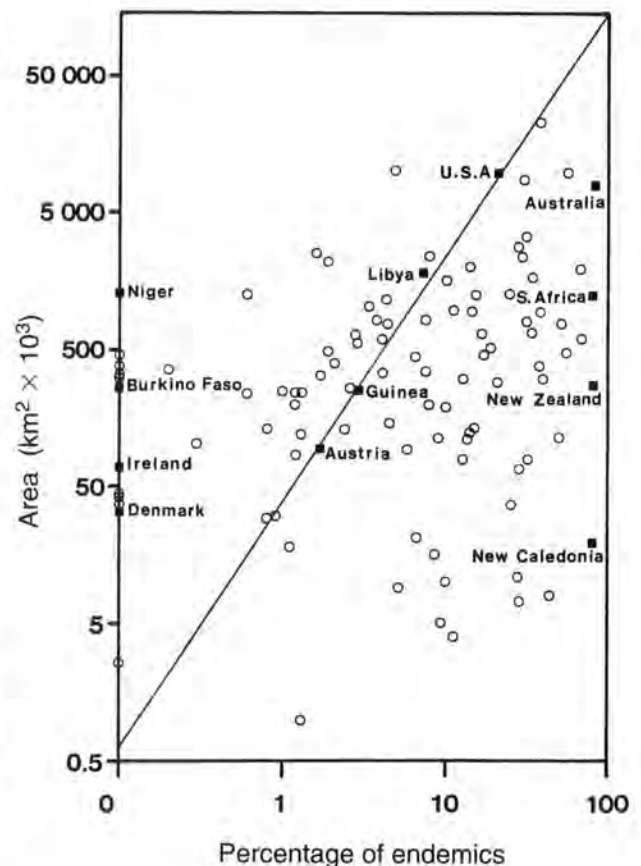

Figure 3.3-1: Bykov's (1983) nomogram for determining average endemism. Points above the diagonal line have lower than average endemism, points below have more (see text for details). Data are percentage plant endemism in the countries of the world (from WCMC 1992). Some countries have been labelled to highlight patterns.

tend to be less speciose but more distinct genetically, key areas may shift quite markedly, e.g. from Malawi to eastern Madagascar for cichlids (Stiassny and de Pinna 1994; see also Vane-Wright *et al.* 1991; Nixon and Wheeler 1992).

There are no hard-and-fast rules relating to selection of spatial and taxonomic units. Appropriate scales will be determined by the available and potential databases, the nature of the study areas, and the research question posed. Ideally, data should be collected (and presented) at several scales, thus enabling comparisons to be made among taxa for congruence in patterns of endemism (see 3.3.3.3).

3.3.2.2 Percentages versus counts

Endemism may be expressed as a percentage of all extant taxa present (excluding exotics), or as the absolute number of endemics in the area. Depicting plant endemics in biogeographic regions as percentages or counts, using area and latitude as explanatory variables, results in very different patterns (Figure 3.3-2) with different significance. Ideally, both measures of endemism should be given. The percentage approach has powerful imagery in that it emphasizes the generality of endemism in a biota, regardless of the total number of endemics. Counts of endemics become most significant when total richness and propensity for endemism are high. Geographically old islands, such as Madagascar for example, may have high proportionate endemism, even for relatively mobile animals. Acridoid grasshoppers are about 94% endemic in Madagascar, but in mainland South Africa they are only about 47% endemic at the species level (Samways 1994b). Some areas, such as oceanic islands and arid regions, although low in actual number of endemics, may support a high percentage of endemic taxa (Briggs 1966; Bramwell 1979; Clancey 1986; Gentry 1992; WCMC 1992; Cowling and Hilton-Taylor 1994). For example, the entire indigenous flora of 46 species, including many interesting high-ranking taxa (Cronk 1987), is endemic to the tiny oceanic island of St Helena. Such an island is a 'flagship area' for endemic plant species conservation, and the St Helena flora is currently subject to a concerted conservation effort. Continental 'flagship areas' are also evident in some parts of the world – e.g. the Tepuis of Venezuela, the Itombwe–Kahuzie area of upper Zaire and the Udzungwa Scarp in Tanzania (Dinesen *et al.* 1993), and the Cape Peninsula of South Africa (Picker and Samways 1995).

3.3.3 Patterns

Many different approaches are used for identifying patterns of endemism, but all require accurate distributional data or maps of uniformly identified taxa as the basic units in the analysis. Good distributional and well-resolved taxonomic data are lacking for most taxa, particularly in the tropics.

Nonetheless, many centres of endemism have been identified for a wide range of organisms at different spatial scales (e.g. Crowe and Crowe 1982; Terborgh and Winter 1982; Gentry 1986; ICBP 1992; WCMC 1992; Cowling and Hilton-Taylor 1994).

3.3.3.1 Centres of endemism

Endemics are not randomly distributed across the Earth but tend to be clustered. This section outlines some of the problems in identifying these centres and indicates some misconceptions about their location. It does not discuss the delimitation and distribution of the many centres that have been identified. Also discussed are the problems of identification, and also the opportunities for conservation, of congruent patterns of endemism.

Regarding the size and distribution of centres of endemism, the view is widely held that high latitude regions support fewer and larger geographical centres than the lower latitudes (e.g. Rapoport 1982; Gentry 1986; Major 1988; Stevens 1989; WCMC 1992). There are, however, numerous exceptions to this pattern, particularly in the temperate and subantarctic zones of the southern hemisphere (Hopper 1979; Santelices 1989; Given 1990; Cowling *et al.* 1992; Platnick 1992; Samways 1992a; Arroyo *et al.* 1995b). Furthermore, most centres have been identified on the basis of endemic flowering plant floras and large-bodied terrestrial vertebrate faunas. These biases (taxonomic, tropical vs temperate, and terrestrial vs marine) have the potential to distort patterns of endemism, with significant consequences for conservation interventions (Given 1990; Redford *et al.* 1990; Platnick 1991; Samways 1993b).

3.3.3.2 Other patterns

At a global scale, the degree of endemism in many groups of organisms increases with decreasing latitude (Gentry 1986; Major 1988; Stevens 1989; Figure 3.3-2). However, very high endemism of terrestrial taxa is recorded in the mid-latitudes of the southern hemisphere, particularly in, and adjacent to, areas with Mediterranean-type climates (Hopper 1979; Cody 1986; Cowling *et al.* 1992; Platnick 1992; Cowling and Hilton-Taylor 1994). The lowest levels are recorded in high latitude, Northern Hemisphere areas which were glaciated during the Pleistocene (Major 1988; WCMC 1992; Samways 1994a).

Range sizes of freshwater fish in North America and Europe increase only above a latitude of 40° N, and marine teleost fishes have smaller range sizes at higher latitudes than at lower latitudes (Rohde *et al.* 1993).

Centres of endemism for marine algae are concentrated in mid-latitude areas with the highest percentage of endemics recorded along the temperate southern Australian coast (Lunig 1990; Groombridge 1993). Briggs (1966, 1969) demonstrated that the percentage of endemic nearshore invertebrates is low around northern temperate

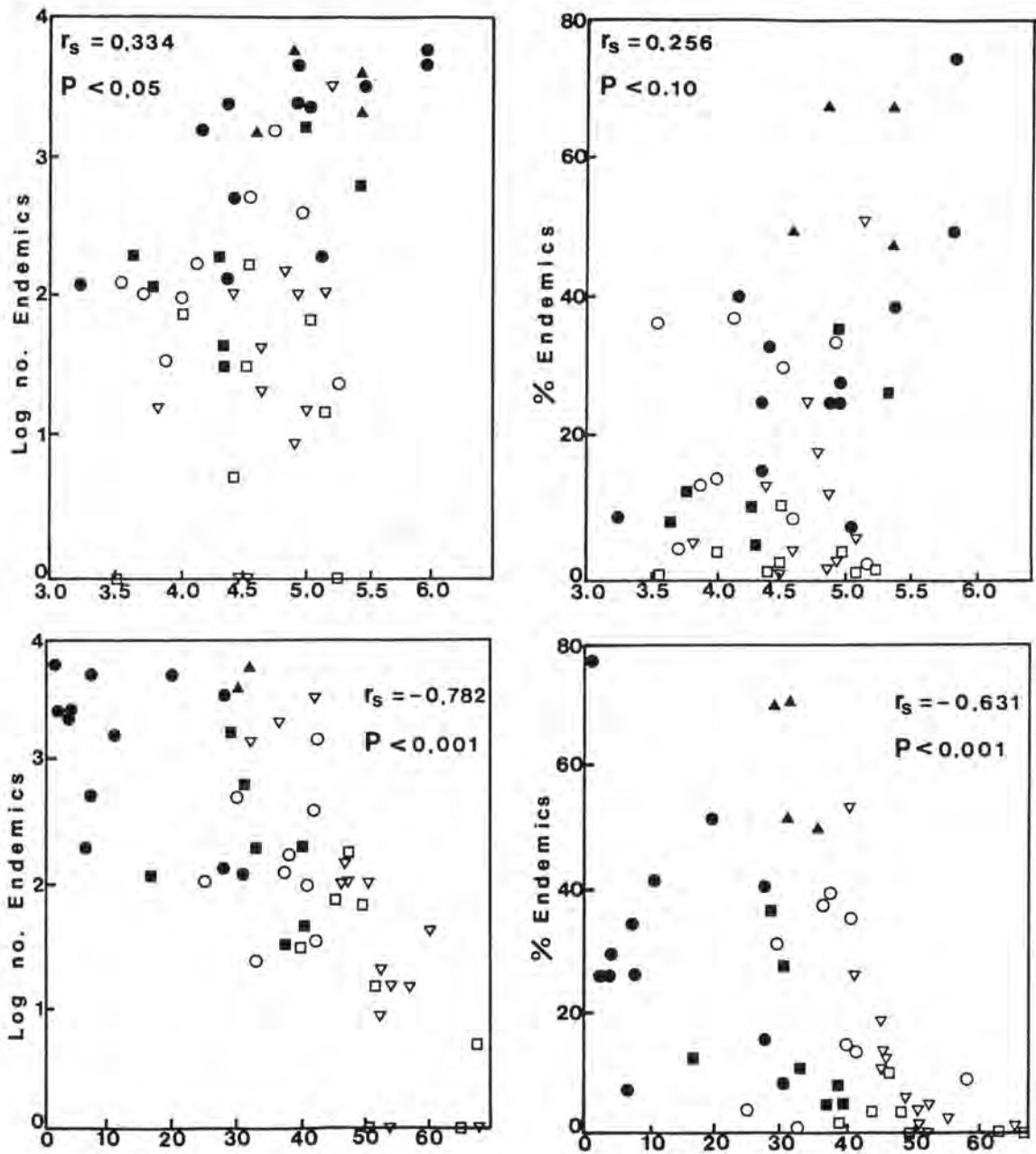

Figure 3.3-2: Relationships between two measures of endemism (percentages and counts) and area and latitude for plant in 52 biogeographic units in tropical and subtropical forest and savanna (●), temperate forest and woodland (○), mediterranean-climate shrubland and woodland (▲), warm desert and steppe (■), cold desert and steppe (□), and boreal and forest and tundra (▽) on continental land masses across the globe. Data from Major (1988), Myers (1988, 1990) and Cowling and Hilton-Taylor (1994).

islands and increases steadily southwards, peaking in the subantarctic. He attributes the low endemism in the northern islands to higher levels of extinction during the Quaternary.

3.3.3.3 Congruence

Overlapping or congruent distribution patterns for different taxa have been used extensively by biogeographers to reconstruct historical events (e.g. Nelson and Platnick 1981; Prance 1982; Cracraft and Prum 1988; Cracraft 1991). Patterns of congruence of endemism play a crucial role in identifying conservation areas that will maximize

the preservation of different biotas (Vane-Wright *et al.* 1991; Table 3.3-1). Congruence may be related to fundamental ecological requirements of, say, mutualists, rather than coincidences of occurrence. For example, there is tight coupling between mutualist endemic orchids of Madagascar (*Angraecum* spp.) with their long nectary spurs and the pollinator hawkmoths with their equally long proboscices (Nilsson 1988).

Critical faunas analysis applied to swallowtail butterflies (Collins and Morris 1985) and to tiger beetles (Pearson and Cassola 1992) indicates distinct patterns of congruence of endemic species among these taxa in seven countries

Table 3.3-1: Critical swallowtail faunas (CSFs) (after Collins and Morris 1985) and critical tiger beetle faunas (CTBFs) (after Pearson and Cassola 1992) for the first 10 countries for each insect assemblage. (From Samways 1994a.)

A	CSF				A	CTBF			
	B	C	D	E		B	C	D	E
1. Indonesia (121)	53	68	121	121	1. Madagascar (176)	174	2	176	176
2. Phillipines (49)	21	4	25	146	2. Indonesia (217)	103	114	217	393
3. China (104)	15	61	76	222	3. Brazil (184)	97	87	184	577
4. Brazil (74)	11	63	74	296	4. India (193)	82	88	170	747
5. Madagascar (13)	10	3	13	309	5. Phillipines (94)	74	2	76	823
6. India (77)	6	8	14	323	6. Australia (81)	72	4	76	899
7. Mexico (52)	5	37	42	365	7. Mexico (116)	57	58	115	1014
8. Taiwan (32)	5	0	5	370	8. USA (111)	45	24	69	1083
9. Malaysia (56)	4	1	5	375	9. PNG (72)	45	1	46	1129
10. PNG (37)	4	8	12	387	10. RSA (94)	40	52	92	1221

A = Country (total number of species); B = number of endemic species; C = non-endemic species not occurring in previous countries; D = newly acceptable species; E = cumulative species total.

PNG = Papua New Guinea; RSA = Republic of South Africa.

(Samways 1994a; Table 3.3-1). These countries are clear flagships for unique biotas. There is also considerable congruence at a global scale between centres of endemism for birds, mammals and amphibians (Cracraft 1991; ICBP 1992). However, only 61 of the 221 Endemic Bird Areas recognized by ICBP (1992) overlap with the 246 Centres of Plant Diversity recognized by Davis *et al.* (1994–5), although it must be pointed out that different criteria were used to identify these areas. For birds, a standardized set of criteria was used, whereas the centres defined for plants were based on a combination of criteria and were the consensus of experts.

At a regional scale, patterns are highly variable among different taxa and in different regions (e.g. Rodgers and Homewood 1982; Crowe 1990; Thomas 1991; Groombridge 1993; Prendergast *et al.* 1993) and no generalizations have emerged. In isolated biotopes such as certain oceanic islands, caves and tropical mountain peaks, patterns of endemism are often congruent across many taxa (Schafer 1990; Groombridge 1993) but no such patterns exist on some islands (WCMC 1992; Holloway 1993) and on serpentine outcrops in California (Kruckeberg 1992).

The identification of patterns of congruence is extremely sensitive to spatial scale and taxonomic hierarchy (Samways 1993b). Congruence is likely to be most elusive in small quadrats because of small differences in biotope preference and mobilities from one species to another, and even from one life-history stage to another (Prendergast *et al.* 1993; Samways 1993b). There should be some attempt to standardize research protocols for analysing patterns of

endemism in different taxa, particularly within the same biogeographic zone or political entity. Lack of strong congruence in patterns underlines the fact that endemism is an expression of many different causes, of which geographical isolation is but one. However, until methods are more standardized it will be difficult to evaluate the true contribution of causal factors to these different patterns.

3.3.4 Endemism: correlates and causes

The causes of endemism are complex and numerous, and include historical processes, contemporary ecological factors, inherent biological properties of taxa and their combinations. In many cases, historical factors may be more important than the ecological determinants, resulting in poor relationships between measures of endemism and explanatory variables reflecting the contemporary environment (e.g. Endrody-Younga 1988; Machado 1992). Establishing correlates is a useful step towards understanding the causes and patterns of endemism. In other words, when compared to more widespread taxa, are narrow endemics a random subset of the biota with regard to abiotic and biotic factors? Despite the importance of identifying the correlates and causes of endemism for biodiversity conservation (Lawton 1993; McDonald and Cowling 1994; Samways 1994a) very few data exist, and these are largely confined to higher plants, although information does also exist for southern African insects (Samways 1994a). Relevant data for plants are reviewed in Kruckeberg and Rabinowitz (1985) and Major (1988).

3.3.4.1 Regional species richness

Regional or landscape-level species richness is a product of three independent diversity components: alpha diversity (the numbers of species in a homogeneous community), beta diversity (the degree of compositional change along biotopes gradients), and gamma diversity (the degree of compositional change between similar biotopes along geographical gradients) (see Section 2.3.2.1, Box 2.3-1). Landscapes with high numbers of biotope-specific or stenotopic endemics (high beta diversity), and many ecologically equivalent species restricted to geographically disjunct portions of the same ecosystem (high gamma diversity), are often species-rich (Cody 1986; Cowling *et al.* 1992). Thus, a correlation between species (and generic or family level) richness and degree of endemism may be evident in some cases (Figure 3.3-3; Major 1988; Stevens 1989; Williams *et al.* 1994). Where centres of endemism are also centres of diversity, then potential conflict between the goals of protecting richness versus restricted range species (Margules *et al.* 1982) may be lessened. Gentry (1992), however, has stated that for neotropical plants, patterns of endemism and diversity are largely non-coincident, suggesting that major centres of diversity (e.g. Mittermeier and Werner 1990) give an inadequate representation of neotropical plant diversity (see also Platnick 1991). For southern African dragonflies and terrestrial vertebrates, the most species-rich area is the warm and sub-humid eastern region, yet most endemics (and threatened taxa) occur in the temperate southwestern Cape region (Samways 1992b; 1994b; Siegfried and Brown 1992). Similarly, in the tropical Andes, areas with high concentrations of both low- and high-ranking bird endemics do not necessarily have the highest species richness (Fjeldsa 1994). For further discussion of this topic see also 3.2.1.2.4.

3.3.4.2 Area

Proportionate levels of endemism increase with increasing geographical area (Major 1988). For flowering plants, there is a positive relationship between endemism (expressed both as counts and as percentages) and the size of large ecologically homogeneous areas (Major 1988, Figure 3.3-2). Inevitably, endemics also decline per unit area with increasing taxonomic level. Studies must, therefore, be explicit about their location and taxonomic level (e.g. Vane-Wright and Pegg 1995) and the sampling intensity. On a small scale, the number of edaphic endemics confined to limestone and serpentine outcrops declines with decreasing areas of these biotopes (Cowling and Bond 1991; Kruckeberg 1992, respectively). Because of the importance of area size in determining levels of endemism in different taxa, it should always be included as an explanatory variable when patterns of diversity are being modelled (cf. Wright 1983).

3.3.4.3 Environmental factors

Levels of endemism may vary in a predictable way along gradients of primary environmental variables such as rainfall, temperature and productivity. Theoretically, models that accurately predict levels of endemism on the basis of easily measurable environmental variables should be useful for the rapid identification of endemic-rich areas (e.g. Hill and Keddy 1992). However, few such models exist, and tests on them show mixed results (e.g. Santelices and Abbott 1987; Santelices 1992).

There are indications that at a global scale, plant endemism is positively correlated with productivity (Major 1988), although high levels of endemism have been recorded in many warm and cold desert areas (Stebbins and Major 1965; Quezel 1978; Major 1988; Cowling and Hilton-Taylor 1994; Squeo *et al.* 1994). Levels of higher plant endemism tend to increase with increasing average elevation (reflecting increased habitat diversity and isolation of mountain tops in most cases) and with higher rainfall in low- and mid-latitude regions including tropical rain forest areas (Ashton and Gunatilleke 1987; Gentry 1986, 1992), middle Asia (Major 1988), the Mediterranean Basin (Strid 1986) and the Cape Floristic Region (Cowling 1983; McDonald and Cowling 1994). In the Cape and southwestern Australia there is evidence of a negative correlation between soil fertility and endemism (Cowling *et al.* 1992, 1995). In the California Floristic Province, high-ranking (and presumably ancient) endemics are clustered in the driest and wettest (refugial) sites, whereas low-ranking, and presumably younger, endemics occur in ecotones where rates of speciation are high (Stebbins and Major 1965). Preliminary data for African birds (e.g. Clancey 1986; Crowe *et al.* 1992) indicate a similar pattern, as do those for certain butterflies in the neotropics (Brown 1991). In the Mediterranean area of central Chile, endemic

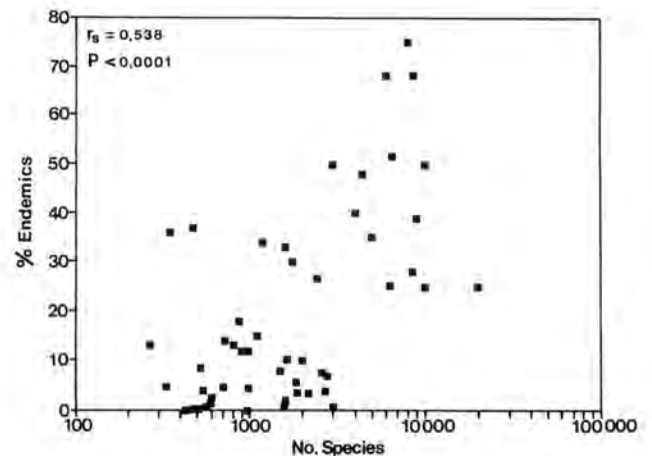

Figure 3.3-3: Relationship between species richness and percentage endemism for 52 biogeographic units on continental land masses across the globe. Data and sources are the same as those in Figure 3.3-2.

genera tend to cluster in the equitable coastal areas (Arroyo *et al.* 1995a).

The incidence of endemism for a wide range of marine organisms tends to be more pronounced in exposed and variable nearshore environments than in distant-shore environments. Taxa showing this pattern include littoral gastropods in Hawaii (Kay 1967), Brazil and Ghana (Vermeij 1972); cephalaspid opisthobranch gastropods in the northwest Atlantic (Franz 1970); deep-sea chaetognaths and fishes (David 1963); and Brazilian scleractinian corals and gorgonians (Vermeij 1972).

3.3.4.4 Biotope

Geographically isolated areas and biotopes (*sensu van Tol and Verdonk 1988*) such as certain islands, mountain peaks, ancient lakes, caves, thermal vents, hot springs, vernal pools, the abyssal zone and chemically imbalanced substrates support a disproportionately high number of stenotopic endemics. Patterns and causes of endemism are well studied for some taxa in certain biotopes (e.g. higher plants and vertebrates on islands and mountain tops) but for others such as thermal vents and the abyssal zone, only preliminary species lists are available (Grassle *et al.* 1985; Grassle and Maciolek 1992). Although the costs and time to survey many of these unusual and inaccessible biotopes are often prohibitive, there is an urgent need for predictive models of levels of endemism in these areas, so as to ascertain appropriate protection of these biotope types. Likewise, understanding the causes of endemism in these unusual habitats could shed much light on evolutionary processes in general.

Plant endemism on islands has been much studied (e.g. Hooker 1867; Valentine 1972; Carlquist 1974; Bramwell 1979) and is well documented (WCMC 1992). Generally, larger continental islands such as Madagascar, New Caledonia and New Zealand, along with those islands whose geological history has provided the conditions conducive to the evolution of high beta and gamma diversities (e.g. Hawaii and the Juan Fernández Islands), support the greatest number of endemic plant taxa (Carlquist 1974; Bramwell 1979; WCMC 1992). However, there are few empirical models that predict the number of endemic taxa on islands in terms of variables such as area, latitude, elevational range, productivity, isolation and age. There are positive correlations between elevational range and endemism for plants in the Canary Islands (Cain 1944; Humphries 1979), and for birds in Indian Ocean archipelagos (Adler 1994), suggesting the importance of topographical diversity in promoting endemism on islands. Because of their requirement for long-distance dispersal on younger, oceanic islands and an ability to persist on older, continental islands, island endemics are likely to differ from continental endemics in their biological attributes (Carlquist 1974; Ehrendorfer 1979). Carabid beetles, for

example, tend to show wing atrophy on islands and mountains (Kavanaugh 1985). Some plant groups have undergone extensive and unusual adaptive radiation on oceanic islands such as the Canaries (Humphries 1979) and Hawaii (Robichaux *et al.* 1990), while continental islands such as Crete, Madagascar and New Caledonia are typically rich in ancient, high-ranking taxa endemics (Greuter 1972; Gibby 1979; Guédès 1979; Davis *et al.* 1994; Williams *et al.* 1994).

Mountains are also often rich in endemics, in both tropical and temperate countries (Hedberg 1969; Maguire 1970; Valentine 1972; Crowe and Crowe 1982; Rodgers and Homewood 1982; Gentry 1986; Kruckeberg and Rabinowitz 1985; Strid 1986; Lovett 1988; Major 1988; Samways 1992a; Matthews *et al.* 1993; Williams 1993; McDonald and Cowling 1994). Many desert inselbergs act as mesic refugia that support endemics: this is particularly pronounced for plants in middle Asia (Major 1988) and the Sahara (Quézel 1978). Similarly, southern African mountain peaks are refugia for grasshoppers avoiding winter cold-air drainage (Samways 1990). In high latitude montane areas of the northern hemisphere, which were once heavily glaciated, levels of plant endemism are low (Major 1988).

The restriction of endemic plant species to nutritionally imbalanced substrates (e.g. serpentine, limestone, quartzite) is a widespread phenomenon in endemic-rich areas such as New Caledonia and the Mediterranean Basin (Papanicolaou *et al.* 1983), California (Kruckeberg 1969, 1992; Raven and Axelrod 1978), southwestern Australia (Hopper 1979; Cowling *et al.* 1995), southwestern Cape of South Africa (Cowling *et al.* 1992), New Zealand (Given 1981), and neotropical rain forest regions (Gentry 1986, 1992; Brown and Prance 1987). There is much evidence to suggest that these nutritionally unusual substrates provide a strong selective force for the evolution of plant endemics (Raven 1964; Bradshaw and McNeilly 1981; Kruckeberg 1986; MacNair 1987). These sites also provide a refuge from competition for ancient, high-ranking endemics (Zedler *et al.* 1984; Major 1988). The restriction of animal taxa to unusual substrates has not been studied in any detail (Kruckeberg 1992). However, the checkerspot butterfly *Euphydrya editha*, which is restricted to ultramafic outcrops in the San Francisco area, is attracted by the microclimate afforded by the more open, serpentine vegetation rather than the nutritional peculiarities of the plants that grow there (Johnson *et al.* 1968).

3.3.4.5 Biological factors

Are biological factors such as body size, growth form, life history traits, population size, relative age, absolute age, genetic architecture, etc. reflected in range size or area of occupation, or are these factors random with respect to spatial variation? There are few explicit studies on the biological aspects of endemism involving more than a few

species and some of these studies strictly pertain more to rarity (Fiedler 1986; Howden 1985; Cowling *et al.* 1992; Cowling and Hilton-Taylor 1994; McDonald and Cowling 1994; Cowling *et al.* 1995; see also Kruckeberg and Rabinowitz 1985; Major 1988).

In the nutrient-poor and Mediterranean-climate environments of South Africa and southwestern Australia, endemics in fire-prone shrublands are significantly over-represented among low to medium-height shrubs (Cowling *et al.* 1992, 1995; McDonald and Cowling 1994). Non-graminoid herbs are over-represented in the endemic floras of California (Raven and Axelrod 1978), the uplands of southeastern Africa (Cowling and Hilton-Taylor 1994), serpentine outcrops of western North America (Kruckeberg 1992), and the granite outcrops of southwestern Australia (Ordnuuff 1987 in Kruckeberg 1992). Gigantism is a common feature among certain plant groups endemic to alpine habitats at low latitudes (e.g. Hedberg 1969). Among neotropical forest plants, endemic taxa tend to be herbs, shrubs or epiphytes rather than forest trees (Gentry 1992), whereas in the rain forests of Sri Lanka, endemics are mainly long-lived, late successional trees (Gunatilleke and Ashton 1987). In southern African semi-arid shrublands, dwarf succulent shrubs and geophytes are significantly over-represented among endemics (Cowling and Hilton-Taylor 1994).

Among animals, gigantism, dwarfism and flightlessness are widespread among island endemics (Thaler 1973; Lawlor 1982), as well as among continental narrow-range endemics, especially when these are confined to historically insular biotopes. For example, dung beetles (Scarabaeinae) endemic to the Chiriqui area of Panama and to the Caribbean islands are significantly smaller than the average for Central and South America (Howden 1985). Beetles endemic to the Florida sand hills do not show a reduction in size but many are flightless, as is the case with true island forms. With very few exceptions, the narrow-range endemic damselflies of South Africa are larger and less vagile than wider-ranging species (Samways 1994b).

The reproductive correlates of endemism have been more extensively studied than other biological characteristics. Kunin and Gaston (1993) review studies which have shown that endemic *Paramecium* species, plants, carabids and rodents (*Peromyscus* spp.) have lower levels of self-incompatibility, a greater tendency toward asexual reproduction, lower overall reproductive effort and poorer dispersal abilities than widespread species in the same groups (see also Kruckeberg and Rabinowitz 1985). Relative to widespread species, the odds are significantly in favour of local plant endemics in the Cape Floristic Region of South Africa being fire-sensitive, having low reproductive output, having myrmecochorous seeds with short dispersal distances, and maintaining small and weakly persistent seed banks, thus rendering them prone to fire-

induced population reduction (Cowling *et al.* 1992; McDonald and Cowling 1994). The Californian chaparral shrub genera *Arctostaphylos* and *Ceanothus*, which comprise the bulk of the narrow endemic shrubs in this vegetation (Cody 1986), are also predominantly fire-sensitive (Wells 1969). Included among the predominantly herbaceous endemic flora of the Californian Floristic Province are many species of *Clarkia*. These have transient seed banks, and are vulnerable to local extinction or severe population reduction as a result of environmentally extreme events (Lewis 1962). In the neotropics, Gentry (1988, 1992) found that wind-dispersed species of Bignoniaceae have broad geographical ranges while animal-dispersed species tend to be more narrowly distributed. Renner (1990) found a similar pattern for neotropical Melastomataceae.

Few studies have addressed whether plant endemics are a non-random assemblage with regard to pollination vectors. Cowling *et al.* (1992) found that insect-pollinated species were over-represented (but not significantly so) relative to wind- and bird-pollinated species among local endemics in a flora from the Cape Floristic Region. Endemic plant species with deep corolla tubes may have either specialist endemic (Nilsson 1988) or widespread (Johnson and Bond 1994) insect pollinators.

The generalization exists that range size and population size are positively (albeit weakly, $R = 0.41$) correlated (Lawton 1993; see also Willis 1922; Gaston and Lawton 1990). Point or local endemics best fit the notion of rarity, but not all endemics, particularly those confined to larger areas, are rare (Kruckeberg and Rabinowitz 1985). It is important to categorize endemics on the basis of population size, since locally endemic stenotopes with small population sizes are extinction-prone (Terborgh 1974; Gentry 1991; Rebelo 1992; Samways 1994b). No generalizations can be made at this stage with regard to other demographic correlates of endemism, at least for higher plants (Kruckeberg and Rabinowitz 1985; Major 1988).

Many studies indicate that plant and animal endemics have lower levels of genetic variation in comparison with widespread species (Stebbins 1942; Babbal and Selander 1974; Moran and Hopper 1983; Loveless and Hamrick 1984; Prentice 1984; Kruckeberg and Rabinowitz 1985; Grant and Little 1992; Sherman-Broyles *et al.* 1992). This may be due to several factors including adaptation to narrow ecological conditions (Van Valen 1965), low population size (Gottlieb 1974), genetic bottlenecks (Gottlieb 1979) and self-compatibility in plants (Jain 1976; Kruckeberg and Rabinowitz 1985; Karron 1989). However, there are cases of little difference in genetic diversity between endemic and widespread plant species (e.g. Babbal and Selander 1974; Ledig and Cronkle 1983). Although genetic studies can be useful in illuminating the nature and origin of endemics (Major 1988, Hamrick *et al.* 1991), as

well as providing guidelines for their preservation (Moran and Hopper 1983), more research is required, particularly in endemic-rich tropical rain forests, for valid generalizations to emerge.

There are very few studies on the physiological attributes of endemic species (Baskauf and Eickmeir 1994; Synder *et al.* 1994). Other than the propensity of plant edaphic endemics to tolerate extraordinary accumulations of heavy metals, and to cope with extreme levels of certain soil nutrients (e.g. Wild and Bradshaw 1977; Papanicolaou *et al.* 1983), no generalizations regarding plants are possible at this stage.

3.3.4.6 Taxonomic correlates

At a regional level, there is evidence that endemic biotas are not a random assemblage phylogenetically. Some plant families are over-represented and others under-represented in centres of endemism in southern Africa (Cowling *et al.* 1992; Cowling and Hilton-Taylor 1994; McDonald and Cowling 1994), southwestern Australia (Cowling *et al.* 1995), western North America (Raven and Axelrod 1978; Kruckeberg 1992), northern Europe (Major 1988), Eurasia (Major 1988) and the neotropics (Gentry 1986). The same applies to dragonfly families in southern Africa (Samways 1992b). Global-scale generalizations are not particularly relevant, since patterns depend on the available genetic stock, which varies regionally. Nonetheless, there appears to be a trend for graminoid lineages such as the Poaceae and Cyperaceae to be under-represented as endemics in many floras across the globe. In both southwestern Australia and the Cape Floristic Region of South Africa, the Proteaceae and the closely-related Epacridaceae/ Ericaceae lineages are disproportionately rich in endemics (Cowling *et al.* 1995).

The existence of discernible phylogenetic correlates of endemism implies that range size may be an evolutionarily stable character of a lineage (Ricklefs and Latham 1992; Lawton 1993). Thus, the characteristics of a species may be the cause rather than the consequence of restricted geographical range (Vrba 1980; Cowling and Holmes 1992; Kunin and Gaston 1993). Species belonging to these lineages may be 'pre-adapted' to cope in small population sizes and might well persist in the face of habitat fragmentation (Lawton 1993). This seems to be the case for fire-sensitive shrubs with poor dispersal and low reproductive output, which are significantly over-represented among point endemics in South Africa's Cape Floristic Region (Cowling and Bond 1991).

3.3.4.7 Modelling

Because of the high costs of carrying out biological inventories (Raven and Wilson 1992), it is important that the correlates of endemism are modelled so that surveys of taxa whose systematics are well understood can be taken to

the level of hypothesis testing. Consideration should be given to the use of explanatory variables which are quickly and inexpensively quantified or qualified, thus enabling the rapid development and testing of model predictions (Peters 1992). The correlates of endemism are numerous and complex, resulting in many co-linearities and higher order interactions. Simple correlations and two-way contingency tables will seldom prove adequate. Since the response variable is likely to have an error distribution that is either binomial (e.g. proportion of endemics) or Poisson (e.g. counts of endemics with many zero values) and the explanatory variables are often factors (e.g. growth form, habitat type), traditional multiple regression analyses will seldom be appropriate. Logistic regression (Crawley 1993; Trexler and Travis 1993) and other generalized linear models hold much promise for these kinds of data sets.

3.3.4.8 Endemism and reserve selection

The distributions of endemic taxa are often used to identify areas for protection (e.g. Terborgh and Winter 1983; Ackery and Vane-Wright 1984; Collins and Morris 1985; Conservation International 1991; ICBP 1992; Saetersdal *et al.* 1993). Quantitative approaches to reserve selection are now well developed, and a selection of iterative algorithms using the principle of complementarity is in use (Pressey *et al.* 1993; Forey *et al.* 1994). The 'critical faunas' approach of Ackery and Vane-Wright (1984; see also Collins and Morris 1985, Pearson and Cassola 1992), is based on counts of endemic species in political entities. However, Vane-Wright *et al.* (1991) point out that critical faunas analysis, which is based solely on endemics, does not offer a sufficiently flexible conservation strategy at the global level. In addition to numbers of endemics, scoring systems for sites should include a factual evaluation of threats, appropriate measures of site viability, species richness, and consideration of cladograms which provide hypotheses on the genetic diversity of the taxa to be conserved (e.g. Williams *et al.* 1993; Williams and Humphries 1994).

3.3.5 Special conservation considerations

This subchapter summarizes the scientific generalizations and questions that have emerged from this review of endemism and which are relevant to the conservation and preservation of biodiversity. The first question examined is that of how endemic taxa can be used as tools for conservation, and this is followed by consideration of some of the special conservation needs of endemic taxa.

3.3.5.1 Endemic taxa as tools in conservation

As endemics, by definition, are organisms with restricted geographical ranges, they are useful for developing conservation priorities. Several applications are pertinent.

1. Endemic taxa have been excellent for identifying genetically rich areas for biodiversity conservation (Myers 1988, 1990; New and Collins 1991; Bibby *et al.* 1992; Rebelo and Siegfried 1992), particularly when used alongside taxonomic measures and also in conjunction with complementarity of biotas (Williams and Humphries 1994). Endemic-rich areas can correspond with centres that are generally rich in species, particularly at the larger spatial scale, and for ecosystems such as Mediterranean-climate shrublands, tropical forests and coral reefs. However, at the smaller scale of localities, sites or biotopes, and in arid ecosystems, there may be a high percentage of endemism but low species richness. More research is required to elucidate these patterns. Endemic taxa and levels of endemism have played an important role in the debate on world species richness (e.g. Erwin 1988; Grassle and Maciolek 1992; Stork 1993).
 2. Location and conservation of centres of high levels of endemism apparently may, in some regions, become an umbrella for the conservation of more common, widespread and eurytopic species. This point requires research, and must not ignore other approaches such as conservation for 'typicalness' or 'representativeness', and for organisms whose appearance and abundance is a function of the stage of plant succession (Usher 1986; Usher and Jefferson 1991).
 3. Abrupt changes in the spatial distribution of endemic taxa indicate steep ecological gradients and a diversity of biotopes (Cowling *et al.* 1992), features that are often desirable in a protected area (Graham 1988; Hunter *et al.* 1988).
 4. Endemic taxa may indicate past Tertiary or Quaternary refugia. This is seen in Amazonia where endemic centres for heliconiine and ithomiine butterflies correlate strongly with geological evidence for persistence of tropical forests (Brown 1991). African (Crowe and Crowe 1982) and South American (Haffer 1969; Cracraft and Prum 1988) narrowly endemic birds also indicate past refugia.
 5. Endemics can sometimes be sensitive indicators of anthropogenic disturbance (Moolman and Cowling 1994; Samways 1994b). The early settlers of the Hawaiian islands appear to have been responsible for the loss of 50 of the 100 endemic bird species up to the late eighteenth century, while at least another 13, especially within the Meliphagidae, have become extinct since then (Groombridge 1993). Indeed, across the Pacific islands in general as many as two-thirds of the birds may have been exterminated by humans (Pimm 1995). Although less than 20% of the Earth's avifauna is restricted to islands, more than 90% of the extinctions during historic times have occurred on islands and all have been direct or indirect consequences of human activity (Olsen 1989; Johnson and Stattersfield 1990). However, relating endemics to type and degree of disturbance is a complex matter, and relates to the particular taxon under consideration.
 6. Certain charismatic endemic organisms have considerable ecotourism value. They may also be national symbols, as with the New Caledonian Kagu (*Rhynochetos jubatus*), the New Zealand Kiwi (*Apteryx australis*) and the Chilean copihue (*Lapageria rosea*).
- 3.3.5.2 *Pointers in the conservation of endemic taxa*
- Certain facets are especially relevant to the conservation of endemics.
1. Areas with unusually high numbers of endemics need to be identified. These areas may not only be large-scale (biogeographical regions, political entities, countries, etc.), but may also be more localized (certain landscapes, biotopes, etc.). The value of these areas may not necessarily be only in the high number of low-ranking taxa, but also in the value of unusual high-ranking taxa (e.g. Fjeldsa 1994). Habitat destruction in such areas is a critical issue because, unlike more widespread species, these taxa are not replaceable from elsewhere.
 2. There is an urgent need to model the abiotic and biotic correlates of endemism in many areas and for many taxa. The models can be used to predict the location of endemic-rich areas and to identify the biological characteristics of endemics requiring special management procedures (Gilfedder and Kirkpatrick 1993; McDonald and Cowling 1994). Certain endemic taxa may not be able to survive on their own, and may depend on endemic mutualists. Conditions, therefore, must suit the interaction as well as the taxon *per se*.
 3. As the centres of endemism for different taxa often do not coincide, one taxon may not be an exact umbrella for other taxa. This may be the case within higher taxa as well as among them. Nevertheless, certain geographical centres may embrace a wide range of endemic taxa and these should be identified as a matter of priority. Much more research is required on taxic congruence at the regional and higher levels (e.g. Williams and Humphries 1994) and sub-regional levels (Samways 1993c).

4. Although there is generally a strong argument to preserve large tracts of land or sea, small reserves may be highly significant for certain taxa, especially where anthropogenic pressures are strong and the endemic component includes many naturally rare taxa (Terborgh 1974; Cowling and Bond 1991; Gentry 1992). The Cape Peninsula of South Africa is a prime example: more than 200 plant species, most of them rare habitat specialists (Hall and Veldhuis 1985) and 112 species of invertebrates (Picker and Samways 1995) are endemic to a rapidly urbanizing area of less than 500 km² (Rebelo 1992). As endemics are often stenotopic and susceptible to disturbance, it may be necessary to buffer these small reserves with multiple-use zones.
5. Endemic species are often highly sensitive to the impact of exotic invasives, both plant and animal. In the Cape Floristic Region of South Africa, alien invasive species are the largest threat to the 1326 *Red Data Book* plant taxa that are endemic there (Rebelo 1992). The Nile perch *Lates niloticus* and the Nile tilapia *Oreochromis niloticus* have been responsible for the decline and total disappearance of numerous endemic cichlids from Lake Victoria and Lake Kyoga in East Africa (Barel *et al.* 1985; Ogutu-Ohwayo 1990). In New Zealand, the stilbocarpa weevil *Hadramphus stilbocarpace* survives only on rat-free islands (Howarth and Ramsay 1991). In South Africa, the minute remaining single population of the butterfly *Orachrysops ariadne* is threatened not only by populations of alien trees but also by the exclusion of megaherbivores which formerly maintained this butterfly's habitat (Samways 1994a). The introduced land snail *Euglandia rosea* has been directly responsible for the extinction of several dozens of species of *Partula* and *Achatinella* in Hawaii and the Society Islands (Cowie 1992).
6. Endemics are also recognized as being particularly susceptible to possible adverse effects of biological control programmes (Samways 1994a). There must therefore be a continual awareness and vigilance of the impact of alien invasives on endemics. This not only requires research, but also practical considerations such as stricter quarantine.
7. Endemics may have special management requirements, especially if they are highly stenotopic (McDonald and Cowling 1994). Where many endemics occur in one area and conservation funds are limited, the best umbrella management option is to conserve the whole landscape in its perceived pristine state (Hunter *et al.* 1988). Such a state may not be static. Highly localized disturbances such as tree falls, or larger-scale processes such as browsing by elephants (*Loxodonta africana*),

occasional flooding, landslips etc., should also be recognized or even introduced. This would maintain short- and long-term plant successional processes which may be crucial for the conservation of endemics.

8. The *Red List* is an important flagship for the conservation of endemic taxa that are known to be threatened by humans (Groombridge 1993). Of the current 5925 listed animal species, 71% are confined to only one country. The *Red List* is therefore an important document for the conservation of endemics. Research should aim to update this publication continually.
9. Following from point (8), the ongoing development of new criteria for listing species on the IUCN *Red List* (Mace *et al.* 1992; Mace 1993) is especially relevant to endemics, and research should aim at establishing the validity of these test criteria for the preservation of endemics.

References

- Ackery, P.R. and Vane-Wright, R.I. 1984. *Milkweed Butterflies*. British Museum (Natural History), London.
- Adler, G.H. 1994. Avifaunal diversity and endemism on tropical Indian Ocean islands. *Journal of Biogeography* **21**: 85–94.
- Arroyo, M.T.K., Cavieres, L., Marticorena, C. and Muñoz-Schick, M. 1995a. Convergence in the Mediterranean floras in central Chile and California: Insights from comparative biogeography. In: Arroyo, M.T.K., Fox, M.D. and Zedler, P. (eds), *Ecology and Biogeography of Mediterranean Ecosystems in Chile, California and Australia*. 43–48. Springer-Verlag, New York.
- Arroyo, M.T.K., Riveros, M., Peñaloza, A., Cavieres, L. and Faggi, A.M. 1995b. Phylogeographic relationships and regional richness patterns of the cool temperate rainforest flora of southern South America. In: Lawford, R. (ed.), *Forest and Riverine Systems of the West Coast of North and South America*. Springer-Verlag, Heidelberg (in press).
- Ashton, P.S. and Gunatilleke, C.V.S. 1987. New light on the plant geography of Ceylon. I. Historical plant geography. *Journal of Biogeography* **14**: 249–286.
- Babbel, G.R. and Selander, R.K. 1974. Genetic variability in edaphically restricted and widespread plant species. *Evolution* **28**: 619–630.
- Balouet, J.C. and Olson, S.L. 1989. Fossil birds from late quaternary deposits in New Caledonia. *Smithsonian Contributions to Zoology* **469**: 1–38.
- Barel, C.D.N., Dorit, R., Greenwood, P.H., Fryer, G., Hughes, N., Jackson, P.B.N., Kawanabe, H., Lowe-McConnell, A., Nagoshi, M., Ribbink, A.J., Trewavas, E., Witte, F. and Yamoka, K. 1985. Destruction of fisheries in Africa's lakes. *Nature* **315**: 19–20.
- Baskauf, C. and Eickmeier, W. 1994. Comparative ecophysiology of a rare and a widespread *Echinacea* (Asteraceae). *American Journal of Botany* **81**: 958–964.
- Bibby, C.J., Crosby, M.J., Heath, M.F., Johnson, T.H., Long, A.J., Stattersfield, A.J. and Thirgood, S.J. 1992. *Putting*

- Biodiversity on the Map: Global priorities for conservation*. ICBP, Cambridge.
- Bradshaw, A.D.** and McNeilly, T. 1981. *Evolution and Pollution*. Edward Arnold, London.
- Bramwell, D.** (ed.) 1979. *Plants and Islands*. Academic Press, London.
- Briggs, J.C.** 1966. Oceanic islands, endemism, and marine paleotemperatures. *Systematic Zoology* **15**: 153–163.
- Briggs, J.C.** 1969. Oceanic islands and endemism: a reply. *Systematic Zoology* **17**: 145–148.
- Brown, K.S.** 1991. Conservation of neotropical environments: insects as indicators. In: Collins, N.M. and Thomas, J.A. (eds), *The Conservation of Insects and their Habitats*, 350–404. Academic Press, London.
- Brown, K.S. Jr** and Prance, G.T. 1987. Soils and vegetation. In: Whitmore, T.C. and Prance, G.T. (eds), *Biogeography and Quaternary History in Tropical America*, 19–45. Clarendon Press, Oxford.
- Brown, V.K.** 1991. The effects of changes in habitat structure during succession in terrestrial communities. In: Bell, S.S., McCoy, E.D. and Mushinsky, H.R. (eds), *Habitat Structure: The physical arrangement of objects in space*, 141–168. Chapman and Hall, London.
- Bykov, B.A.** 1983. *Ecological Dictionary*. Nauka, Kazakhskoi, Alma Ata.
- Cain, S.A.** 1944. *Foundations of Plant Geography*. Harper, New York.
- Carlquist, S.** 1974. *Island Biology*. Columbia University Press, New York.
- Castilla, J.C.** 1994. *Islas Oceánicas Chilenas*. Ediciones Universidad Católica de Chile, Santiago.
- Chazeau, J.** 1993. Research on New Caledonian terrestrial fauna: achievements and prospects. *Biodiversity Letters* **1** (3–4): 123–129.
- Clancey, P.A.** 1986. Endemicity in the southern African avifauna. *Durban Museum Novitates* **13**: 245–284.
- Cody, M.L.** 1986. Diversity, rarity and conservation in mediterranean-climate regions. In: Soulé, M. (ed.), *Conservation Biology: The science of scarcity and diversity*, 122–152. Sinauer Associates, Sunderland, Mass.
- Collins, N.M.** and Morris M.G. 1985. *Threatened Swallowtail Butterflies of the World*. IUCN, Gland.
- Conservation International** 1991. *Biological Priorities for Conservation in Amazonia*. Washington, DC.
- Cowie, R.** 1992. Evolution and extinction of Parulidae, endemic Pacific island snails. *Philosophical Transactions of the Royal Society of London, B* **335**: 167–191.
- Cowling, R.M.** 1983. Phytocoology and vegetation history in the south eastern Cape, South Africa. *Journal of Biogeography* **10**: 393–419.
- Cowling, R.M.** and Bond, W.J. 1991. How small can reserves be? An empirical approach in Cape fynbos. *Biological Conservation* **55**: 243–256.
- Cowling, R.M.** and Hilton-Taylor, C. 1994. Patterns of plant diversity and endemism in southern Africa: an overview. In: Huntley, B.J. (ed.), *Botanical Diversity in Southern Africa* 31–52. National Botanical Institute, Kirstenbosch.
- Cowling, R.M.** and Holmes P.M. 1992. Endemism and speciation in a lowland flora from the Cape Floristic Region. *Biological Journal of the Linnean Society* **47**: 367–383.
- Cowling, R.M., Holmes, P.M.** and Rebelo, A.G. 1992. Plant diversity and endemism. In: Cowling, R.M. (ed.), *The Ecology of Fynbos. Nutrients, fire and diversity*, 67–112. Oxford University Press, Cape Town.
- Cowling, R.M., Witkowski, E.T.F., Milewski, A.V.** and Newbey, K.R. 1995. Taxonomic, edaphic and biological aspects of plant endemism on matched sites in mediterranean Australia and South Africa. *Journal of Biogeography* (in press).
- Cracraft, J.** 1986. Origin and evolution of continental biotas: speciation and historical congruence within the Australian avifauna. *Evolution* **40**: 977–996.
- Cracraft, J.** 1991. Patterns of diversification within continental biotas: hierarchical congruence among areas of endemism of Australian vertebrates. *Australian Systematic Botany* **4**: 211–227.
- Cracraft, J.** and Prum, R.O. 1988. Patterns and processes of diversification: speciation and historical congruence in some neotropical birds. *Evolution* **42**: 603–620.
- Crawley, M.J.** 1993. *GLIM for Ecologists*. Blackwell Scientific Publications, Oxford.
- Cronk, Q.C.B.** 1987. The history of the endemic flora of St Helena: a relictual series. *New Phytologist* **105**: 509–520.
- Crowe, T.M.** 1990. A quantitative analysis of patterns of distribution, species richness and endemism in southern African vertebrates. In: Peters, G. and Hutterer, R. (eds), *Vertebrates in the Tropics*, 145–160. Museum Alexander Koenig, Bonn.
- Crowe, T.M.** and Brooke, R.K. 1993. Review of: *Putting Biodiversity on the Map: Priority areas for conservation*. *Ostrich* **64**: 12.
- Crowe, T.M.** and Crowe, A.A. 1982. Patterns of distribution, diversity and endemism in Afrotropical birds. *Journal of Zoology, London* **198**: 417–442.
- Crowe, T.M., Harley, E.H., Jakutowicz, M.B., Komen, J.** and Crowe, A.A. 1992. Phylogenetic, taxonomic and biogeographical implications of genetic, morphological and behavioural variation in francolins (Phasianidae: *Francolinus*). *Auk* **109**: 24–42.
- Crowe, T.M., Ryan, P.G., Essop, M.F., Brooke, R.K., Hockey, P.A.R.** and Siegfried, W.R. 1994. Species as the 'currency' of conservation: the Karoo/Dune/Red Lark complex of southwestern Africa. In: Forey, P.I., Humphries, C.J. and Vane-Wright, R.I. (eds), *Systematics and Conservation Evaluation*, 229–234. Clarendon Press, Oxford.
- David, P.M.** 1963. Some aspects of speciation in the Chaetognatha. In: Harding, J.P. and Tebble, N. (eds), *Speciation in the Sea*, 129–143. Systematics Association, London.
- Davis, S.D., Heywood, V.H.** and Hamilton, A.C. (eds) 1994–5. *Centres of Plant Diversity: A strategy for their conservation*. Vol. 1. Europe, Africa, South West Asia and the Middle East; Vol. 2. Asia, Australia and the Pacific; Vol. 3. The Americas. WWF and IUCN, IUCN Publications Unit, Cambridge.
- De Candolle, A.P.** 1820. Essai élémentaire de géographie botanique. In: *Dictionnaire de Sciences Naturelles*. Vol. 18. Flevault, Strasbourg and Paris.
- Dinensen, L., Lehmborg, T., Svendsen, J.O., Hansen, L.A.** and Fjeldsa, J. 1993. A new genus and species of perdicine birds

- (Phasianidae, Perdicipini) from Tanzania; a relict form with Indo-Malayan affinities. *Ibis* **136**: 2–11.
- Duffey, E.** 1977. The re-establishment of the large copper butterfly *Lycaena dispar dispar* Obth. on Woodwalton Fen National Nature Reserve, Cambridgeshire, England, 1969–1973. *Biological Conservation* **12**: 143–158.
- Ehrendorfer, F.** 1979. Reproductive biology of island plants. In: Bramwell, D. (ed.), *Plants and Islands*. 293–306. Academic Press, London.
- Endrody-Younga, S.** 1988. Evidence for the low altitude origin of the Cape mountain biome derived from the systematic revision of the genus *Colophon* Gray (Coleoptera, Lucanidae). *Annals of the South African Museum* **96**: 359–424.
- Engler, A.** 1882. *Versuch einer Entwicklungsgeschichte der Pflanzenwelt*. Engelmann, Leipzig.
- Erwin, T.L.** 1988. The tropical forest canopy: the heart of biotic diversity. In: Wilson, E.O. (ed.), *Biodiversity*. 123–129. National Academy Press, Washington, DC.
- Favarger, R.C.** and Contandriopoulos, J. 1961. Essai sur l'endemisme. *Bulletin de la Société Botanique Suisse* **71**: 384–408.
- Fiedler, P.L.** 1986. Concepts of rarity in vascular plants with special reference to the genus *Calochortus* Pursh (*Liliaceae*). *Taxon* **35**: 502–518.
- Fjeldsa, J.** 1994. Geographical patterns for relict and young species of birds in Africa and South America and implications for conservation priorities. *Biodiversity and Conservation* **3**: 207–226.
- Forey, P.L., Humphries, C.J.** and Vane-Wright, R.J. (eds) 1994. *Systematics and Conservation Evaluation*. The Systematics Association, Special Volume. Clarendon Press, Oxford.
- Franz, D.R.** 1970. Zoogeography of northwest Atlantic opisthobranch molluscs. *Marine Biology* **7**: 171–180.
- Gaston, K.J.** 1991. How large is a species' geographic range. *Oikos* **61**: 434–438.
- Gaston, K.J.** 1994. *Rarity*. Chapman and Hall, London.
- Gaston, K.J.** and Lawton, J.H. 1990. Effects of scale and habitat on the relationship between regional distribution and local abundance *Oikos* **58**: 329–335.
- Gentry, A.H.** 1986. Endemism in tropical vs temperate plant communities. In: Soulé, M. (ed.), *Conservation Biology: The science of scarcity and diversity*, 153–181. Sinauer Associates, Sunderland, Mass.
- Gentry, A.H.** 1988. Change in plant community diversity and floristic composition on environmental and geographic gradients. *Annals of the Missouri Botanical Garden* **75**: 1–34.
- Gentry, A.H.** 1991. Biological extinction in western Ecuador. *Annals of the Missouri Botanical Garden* **78**: 273–295.
- Gentry, A.H.** 1992. Tropical forest biodiversity: distributional patterns and their conservation significance. *Oikos* **63**: 19–28.
- Gibby, M.** 1979. Palaeoendemism and evolution in Macaronesian *Dryopteris*. In: Bramwell, D. (ed.), *Plants and Islands*. 347–358. Academic Press, London.
- Gilfedder, L.** and Kirkpatrick, J.B. 1993. Germinable soil seed and competitive relationships between a rare native species and exotics in a semi-natural pasture in the midlands, Tasmania. *Biological Conservation* **64**: 113–119.
- Given, D.R.** 1981. *Rare and Endangered Plants of New Zealand*. Reed, Wellington.
- Given, D.R.** 1990. Conserving botanical diversity on a global scale. *Annals of the Missouri Botanical Garden* **77**: 48–62.
- Given, D.R.** and Norton, D. 1992. A multivariate approach to assessing threat and for priority setting in threatened species conservation. *Biological Conservation* **64**: 57–66.
- Gottlieb, L.D.** 1975. Genetic confirmation of the origin of *Clarkia lingulata*. *Evolution* **28**: 244–250.
- Gottlieb, L.D.** 1979. The origin of phenotype in recently evolved plants. In: Solbrig, O.T., Jain, S., Johnson, G.B. and Raven, P.H. (eds), *Topics in Plant Population Biology*. 264–286. Columbia University Press, New York.
- Graham, R.W.** 1988. The role of climatic change in the design of biological reserves: the paleoecological perspective in conservation biology. *Conservation Biology* **2**: 391–394.
- Grant, W.S.** and Little, R.M. 1992. How sedentary are greywing francolin *Francolinus africanus*? *Evolution* **46**: 1477–1491.
- Grassle, J.F.** and Maciolek, N.J. 1992. Deep-sea species richness: regional and local diversity estimates from quantitative bottom samples. *American Naturalist* **139**: 313–341.
- Grassle, J.F., Brown-Leger, L.S., Morse-Porteous, L., Petrecca, R.** and Williams, I. 1985. Deep-sea fauna of sediments in the vicinity of hydrothermal vents. *Bulletin of the Biological Society of Washington* **6**: 443–452.
- Groombridge, B.** 1993. *1994 IUCN Red List of Threatened Animals*. IUCN, Gland.
- Greuter, W.** 1972. The relict element of the flora of Crete and its evolutionary significance. In: Valentine, D.H. (ed.), *Taxonomy, phytogeography and ecology*. 161–177. Academic Press, London.
- Guédès, M.** (1979). Magnolioid island plants and Angiosperm evolution. In: Bramwell, D. (ed.), *Plants and Islands*. 307–328. Academic Press, London.
- Gunatilleke, C.V.S.** and Ashton, P.S. 1987. New light on the plant geography of Ceylon II. The ecological biogeography of the lowland endemic tree flora. *Journal of Biogeography* **14**: 295–327.
- Haffer, J.** 1969. Speciation in Amazonian birds. *Science* **165**: 131–137.
- Hall, A.V.** and Veldhuis, H.A. 1985. *South African Red Data Book: Plants – Fynbos and Karoo biomes*. Council for Scientific and Industrial Research, Pretoria.
- Hamrick, J.L., Godt, M.J.W., Murawski, D.A.** and Loveless, M.D. 1991. Correlations between species traits and allozyme diversity: implications for conservation biology. In: Falk, D. and Holsinger, K. (eds), *Genetics and Conservation of Rare Plants*. 75–86. Oxford University Press, Oxford.
- Hedberg, O.** 1969. Evolution and speciation in a tropical high mountain flora. *Biological Journal of the Linnean Society* **1**: 135–148.
- Hill, N.M.** and Keddy, P.A. 1992. Prediction of rarities from habitat variables: coastal plain plants on Nova Scotian lakeshores. *Ecology* **73**: 1852–1859.
- Holloway, J.D.** 1993. Lepidoptera in New Caledonia: diversity and endemism in a plant feeding insect group. *Biodiversity Letters* **1**: 92–101.
- Hooker, J.D.** 1867. Insular floras. *Gardeners' Chronicle*, 1867: 6–7, 27, 50–51, 75–76.
- Hopper, S.D.** 1979. Biogeographical aspects of speciation in the south-west Australian flora. *Annual Review of Ecology and Systematics* **10**: 399–422.

- Howard, P.C.** 1991. *Nature Conservation in Uganda's Forest Reserves*. IUCN, Gland.
- Howarth, F.G.** and Ramsay, G. 1991. The conservation of island insects and their habitats. In: Collins, N.M. and Thomas, J.A. (eds), *The Conservation of Insects and their Habitats*. 71–119. Academic Press, London.
- Howden, H.F.** 1985. Expansion and contraction cycles, endemism and area: the taxon cycle brought full circle. In: Ball, G.E. (ed.), *Taxonomy, Phylogeny and Zoogeography of Beetles and Ants*. 473–487. Junk, Dordrecht.
- Humphries, C.J.** 1979. Endemism and evolution in Macaronesia. In: Bramwell, D. (ed.), *Plants and Islands*. 171–199. Academic Press, London.
- Humphries, C.J.** and Parenti, L. 1986. *Cladistic Biogeography*. Clarendon Press, Oxford.
- Hunter M.L.**, Jacobson, G.L. and Webb, T. III. 1988. Paleocology and the coarse-filter approach to maintaining biological diversity. *Conservation Biology* 2: 375–385.
- International Council for Bird Preservation.** 1992. *Putting Biodiversity on the Map: Priority areas for global conservation*. ICBP, Cambridge.
- International Union for the Conservation of Nature and Natural Resources** 1995. *IUCN Red List Categories*. IUCN, Gland, Switzerland.
- Jain, S.K.** 1976. The evolution of inbreeding in plants. *Annual Review of Ecology and Systematics* 7: 469–495.
- Johnson, M.P.**, Keith, A.D. and Ehrlich, P.R. 1968. The population biology of the butterfly, *Euphydryas editha*. VII. Has *Editha* evolved a serpentine race? *Evolution* 22: 422–423.
- Johnson, S.D.** and Bond, W.J. 1994. Red flowers and butterfly pollination in the fynbos of South Africa. In: Arianoutsou, M. and Groves, R.M. (eds), *Plant–animal Interactions in Mediterranean-type Ecosystems*. 156–168. Kluwer, Dordrecht.
- Johnson, T.H.** and Stattersfield, A.J. 1990. A global review of island endemic birds. *Ibis* 132: 167–180.
- Karron, J.D.** 1989. Breeding systems and levels of inbreeding depression in geographically restricted and widespread species of *Astragalus* (Fabaceae). *American Journal of Botany* 76: 331–340.
- Kavanaugh, D.H.** 1985. On wing atrophy in carabid beetles (Coleoptera: Carabidae), with special reference to Nearctic *Nebria*. In: Ball, G.E. (ed.), *Taxonomy, Phylogeny and Zoogeography of Beetles and Ants*. 408–431. Junk, Dordrecht.
- Kay, E.A.** 1967. The composition and relationships of the marine molluscan fauna of the Hawaiian Islands. *Journal of Malacology* 25: 94–104.
- Krückeberg, A.R.** 1969. Soil diversity and the distribution of plants with examples from western North America. *Madroño* 20: 129–154.
- Krückeberg, A.R.** 1986. An essay: the stimulus of unusual geologies in plant speciation. *Systematic Botany* 11: 455–463.
- Krückeberg, A.R.** 1992. Plant life of western North American ultramafics. In: Roberts, B.A and Proctor, J. (eds), *The Ecology of Areas with Serpentinized Rocks: A world view*. 31–73. Kluwer, Dordrecht.
- Krückeberg A.R.** and Rabinowitz D. 1985. Biological aspects of endemism in higher plants. *Annual Review Ecology and Systematics* 16: 447–479.
- Kunin, W.E.** and Gaston K.J. 1993. The biology of rarity: patterns, causes and consequences. *Trends in Ecology and Evolution* 8: 298–301.
- Lawlor, T.E.** 1982. The evolution of body size in mammals: evidence from insular populations in Mexico. *American Naturalist* 119: 54–77.
- Lawton, J.H.** 1993. Range, population abundance and conservation. *Trends in Ecology and Evolution* 8: 409–413.
- Ledig, F.T.** and Cronkle, M.T. 1983. Gene diversity and genetic structure in a narrow endemic, Torrey pine (*Pinus torreyana* Parry ex Carr). *Evolution* 37: 79–85.
- Lewis, H.** 1962. Catastrophic selection as a factor in speciation. *Evolution* 16: 257–271.
- Linder, H.P.** and Vlok, J. 1991. The morphology, taxonomy and evolution of *Rhodocoma* (Restionaceae). *Plant Systematics and Evolution* 175: 139–160.
- Loveless, M.D.** and Hamrick, J.L. 1984. Ecological determinants of genetic structure in plant populations. *Annual Review of Ecology and Systematics* 15: 65–95.
- Lovett, J.C.** 1988. Endemism and affinities of the Tanzanian montane forest flora. *Monographs in Systematic Botany of the Missouri Botanical Garden* 25: 591–598.
- Lovett, J.C.** and Wasser, S.K. 1993. *Biogeography and Ecology of the Rain Forests of Eastern Africa*. Cambridge University Press, Cambridge.
- Lunig, K.** 1990. *Seaweeds: Their environment, biogeography, and ecophysiology*. John Wiley, New York.
- Mace, G.M.** 1993. The status and proposals to redefine the IUCN threatened species categories. In: Groombridge, B. (ed.), *The 1994 IUCN Red List of Threatened Animals*. xlvii–lv. IUCN, Gland.
- Mace, G.M.**, Collar, N., Cooke, K., Gaston, K., Ginsberg, J., Leader-Williams, M., Maunder, M. and Milner-Gulland, E.J. 1992. The development of new criteria for listing species on the IUCN Red List. *Species* 19: 16–22.
- Machado, A.** 1992. *Monografía de los Carabidos de las Islas Canarias (Insecta, Coleoptera)*. Instituto de Estudios Canarios, La Laguna, Tenerife.
- McDonald, D.J.** and Cowling, R.M. 1994. Towards a profile of an endemic mountain fynbos flora: implications for conservation. *Biological Conservation* 72: 1–12.
- McDowall, R.M.** 1968. Oceanic islands and endemism. *Systematic Zoology* 17: 346–350.
- MacNair, M.R.** 1987. Heavy metal tolerance in plants: a model evolutionary system. *Trends in Ecology and Evolution* 2: 354–359.
- Maguire, B.** 1970. On the flora of the Guayana Highland. *Biotropica* 2: 85–100.
- Major, J.** 1988. Endemism: a botanical perspective. In: Myers, A.A. and Giller, P.S. (eds), *Analytical Biogeography. An integrated approach to the study of animal and plant distributions*. 117–146. Chapman and Hall, New York.
- Margules, C.**, Higgs, A.J. and Rafe, R.W. 1982. Modern biogeographic theory: are there any lessons for nature reserve design? *Biological Conservation* 24: 115–128.
- Matthews, W.S.**, van Wyk, A.E. and Bredenkamp, G.J. 1993. Endemic flora of the north-eastern Transvaal Escarpment, South Africa. *Biological Conservation* 63: 83–94.

- Meyer, A.** 1993. Phylogenetic relationships and evolutionary processes in east African cichlids. *Trends in Ecology and Evolution* **8**: 279–284.
- Mittermeier, R.A.** and Werner, T.B. 1990. Wealth of plants and animals unites megadiversity countries. *Tropicos* **4**: 4–5.
- Moolman, H.J.** and Cowling, R.M. 1994. The impact of elephant and goat grazing on the endemic flora of South African succulent thicket. *Biological Conservation* **68**: 53–61.
- Moran, G.F.** and Hopper, S.D. 1983. Genetic diversity and the insular population structure of the rare granite rock species *Eucalyptus caesia* Benth. *Australian Journal of Botany* **31**: 161–172.
- Myers, N.** 1988. Threatened biotas: 'hot spots' in tropical forests. *The Environmentalist* **8**: 187–208.
- Myers, N.** 1990. The biodiversity challenge: expanded hot-spots analysis. *The Environmentalist* **10**: 243–256.
- Nelson, B.W.,** Ferreira, C.A.C., da Silva, M.F. and Kawasaki, M.L. 1990. Endemism centres: refugia and botanical collection intensity in Brazilian Amazonia. *Nature* **345**: 714–716.
- Nelson, G.** and Platnick, N. 1981. *Systematics and Biogeography: Cladistics and vicariance*. Columbia University Press, New York.
- New, T.R.** and Collins, N.M. 1991. *Swallowtail Butterflies: An action plan for their conservation*. IUCN, Gland.
- Nilsson, L.A.** 1988. The evolution of flowers with deep corolla tubes. *Nature* **334**: 147–149.
- Nixon, K.C.** and Wheeler, Q.D. 1992. Measures of phylogenetic diversity. In: Novacek, M.J. and Wheeler, Q.D. (eds), *Evolution and Phylogeny*. 216–234. Columbia University Press, New York.
- Ogutu-Ohwayo, R.** 1990. The decline of the native fishes of Lakes Victoria and Kyogo (East Africa) and the impact of introduced species, especially the Nile perch, *Lates niloticus*, and the Nile tilapia, *Oreochromis niloticus*. *Environmental Biology of Fishes* **27**: 81–96.
- Olsen, S.L.** 1989. Extinction on islands: man as catastrophe. In: Western, D. and Pearl, M. (eds), *Conservation for the Twenty-first Century*. 50–53. Oxford University Press, New York.
- Papanicolaou, K.,** Babalonas, D. and Kokkini, S. 1983. Distribution patterns of some Greek mountain endemic plants in relation to geological substrate. *Flora* **174**: 405–437.
- Pearson, D.L.** and Cassola, F. 1992. World-wide species richness patterns of tiger beetles (Coleoptera: Cicindelidae): indicator taxon for biodiversity and conservation studies. *Conservation Biology* **6**: 376–391.
- Peters, R.H.** 1992. *A Critique of Ecology*. Cambridge University Press, Cambridge.
- Picker, M.P.** and Samways, M.J. 1995. Faunal diversity and endemism of the Cape Peninsula – a first assessment. *Biodiversity and Conservation* (in press).
- Pimm, S.L.** 1995. Seeds of our own destruction. *New Scientist* **146**: 31–35.
- Platnick, N.** 1991. Patterns of biodiversity: tropical vs temperate. *Journal of Natural History* **25**: 1083–1088.
- Platnick, N.** 1992. Patterns of biodiversity. In: Eldredge, N. (ed.), *Systematics, Ecology, and the Biotic Crisis*. 15–24. Columbia University Press, New York.
- Prance, G.T.** (ed.) 1982. *Biological Diversification in the Tropics*. Columbia University Press, New York.
- Prendergast, J.R.,** Quinn, R.M., Lawton, J.H., Eversham, B.C. and Gibbons, D.W. 1993. Rare species, the coincidence of diversity hotspots and conservation strategies. *Nature* **365**: 335–337.
- Prentice, H.C.** 1976. A study of endemism: *Silene diclinis*. *Biological Conservation* **10**: 15–30.
- Prentice, H.C.** 1984. Enzyme polymorphism, morphometric variation and population structure in a restricted endemic, *Silene diclinis* (Caryophyllaceae). *Biological Journal of the Linnean Society* **22**: 125–144.
- Pressey, R.L.,** Humphries, C.J., Margules, C.R., Vane-Wright, R.I., and Williams, P.H. 1993. Beyond opportunism: key principles for systematic reserve selection. *Trends in Ecology and Evolution* **8**: 124–128.
- Quézel, P.** 1978. Analysis of the flora of Mediterranean and Saharan Africa. *Annals of the Missouri Botanical Garden* **65**: 479–534.
- Rabinowitz, D.,** Cairns, S. and Dillin, T. 1986. Seven forms of rarity and their frequency in the flora of the British Isles. In: Soulé, M. (ed.), *Conservation Biology: The science of scarcity and diversity*. 182–204. Sinauer Associates, Sunderland, Mass.
- Rapoport, E.H.** 1982. *Areography: Geographical strategies of species*. Pergamon Press, Oxford.
- Raven, P.H.** 1964. Catastrophic selection and edaphic endemism. *Evolution* **18**: 336–338.
- Raven, P.H.** and Axelrod, D.I. 1978. Origin and relationships of the California flora. *University of California Publications in Botany* **72**: 1–134.
- Raven, P.H.** and Wilson, E.O. 1992. A fifty-year plan for biodiversity surveys. *Science* **258**: 1099–1100.
- Rebello, A.G.** 1992. Preservation of biotic diversity. In: Cowling, R.M. (ed.), *The Ecology of Fynbos. Nutrients, fire and diversity*. 309–344. Oxford University Press, Cape Town.
- Rebello, A.G.** and Siegfried, W.R. 1992. Where should reserves be located in the Cape Floristic Region, South Africa? Models for spatial configuration of a reserve network aimed at maximizing the protection of floral diversity. *Conservation Biology* **6**: 243–252.
- Redford, K.H.,** Taber, A., Simonetti, J.A. 1990. There is more to biodiversity than tropical rain forests. *Conservation Biology* **4**: 328–330.
- Renner, S.S.** 1990. Reproduction and evolution in some genera of neotropical Melastomataceae. *Memoirs of the New York Botanical Garden* **55**: 143–152.
- Ribbink, A.J.,** Marsh, B.A., Marsh, A.C., Ribbink, A.C. and Sharp, B.J. 1983. A preliminary survey of the cichlid fishes in rocky habitats in Lake Malawi. *South African Journal of Zoology* **18**: 149–310.
- Ricklefs, R.E.** and Latham, R.E. 1992. Intercontinental correlation of geographic ranges suggests stasis in ecological traits of relict genera of temperate perennial herbs. *American Naturalist* **139**: 1305–1321.
- Robichaux, R.H.,** Carr, G.D., Liebman, M. and Pearcy, R.W. 1990. Adaptive radiation of the Hawaiian silversword alliance (Compositae–Madiinae): ecological, morphological, and physiological diversity. *Annals of the Missouri Botanical Garden* **77**: 64–72.
- Rodgers, W.A.** and Homewood, K.M. 1982. Species richness and endemism in the Usambara mountain forests, Tanzania. *Biological Journal of the Linnean Society* **18**: 197–242.

- Rohde, K., Heap, M. and Heap, D. 1993. Rapoport's rule does not apply to marine teleosts and cannot explain latitudinal gradients in species richness. *American Naturalist* **142**: 1–16.
- Rosen, D.E. 1979. Fishes from the uplands and intermontane basins of Guatemala: revisionary studies and comparative geography. *Bulletin of the American Museum of Natural History* **162**: 267–376.
- Saetersdal, M., Line, J.M. and Birks, H.J.B. 1993. How to maximize biological diversity in nature reserve selection: vascular plants and breeding birds in deciduous woodlands, western Norway. *Biological Conservation* **66**: 131–138.
- Samways, M.J. 1990. Landforms and winter habitat refugia in the conservation of montane grasshoppers in southern Africa. *Conservation Biology* **4**: 375–382.
- Samways, M.J. 1992a. Some comparative insect conservation issues of north temperate, tropical, and south temperate landscapes. *Agriculture, Ecosystems and Environment* **40**: 137–154.
- Samways, M.J. 1992b. Dragonfly conservation in South Africa: a biogeographical perspective. *Odonatologia* **21**: 165–180.
- Samways, M.J. 1993a. A spatial and process sub-regional framework for insect and biodiversity conservation research and management. In: Gaston, K.J., New, T.R. and Samways, M.J. (eds), *Perspectives on Insect Conservation*. 1–27. Intercept Press, Andover.
- Samways, M.J. 1993b. Insects in biodiversity conservation: some perspectives and directives. *Biodiversity and Conservation*, **2**: 258–282.
- Samways, M.J. 1993c. Dragonflies (Odonata) in taxic overlays and biodiversity conservation. In: Gaston, K.J., New, T.R. and Samways, M.J. (eds), *Perspectives on Insect Conservation*. 111–123. Intercept Press, Andover.
- Samways, M.J. 1994a. *Insect Conservation Biology*. Chapman and Hall, London.
- Samways, M.J. 1994b. Conservation of the threatened, endemic dragonflies of South Africa. In: Corbet, P.S., Dunkle, S.W. and Ubukata, H. (eds), *The Conservation of Dragonflies and their Habitats*. 8–15. Japanese Society for the Preservation of Birds, Kushiro.
- Santelices, B. 1989. *Algas Marinas de Chile. Distribución, Ecología, Utilización, Diversidad*. Ediciones Universidad Católica de Chile.
- Santelices, B. 1992. Marine fitogeography of the Juan Fernández Archipelago: a new assessment. *Pacific Science* **46**: 438–452.
- Santelices, B. and Abbott, A. 1987. Geographic and marine isolation: an assessment of the marine algae of Easter Island. *Pacific Science* **41**: 1–20.
- Schafer, C.L. 1990. *Nature Reserves. Island theory and conservation practice*. Smithsonian Institution Press, Washington, DC.
- Sherman-Broyles, S.L., Gibson, J.P., Hamrick, J.L., Bucher, M.A. and Gibson, M.J. 1992. Comparisons of allozyme diversity among rare and widespread *Rhus* species. *Systematic Botany* **17**: 551–559.
- Siegfried, W.R. and Brown, C.A. 1992. The distribution and protection of mammals endemic to southern Africa. *South African Journal of Wild Life Research* **22**: 11–16.
- Squeo, F.A., Arancio, G., Osorio, R., Arroyo, M.T.K. and Veit, H. 1994. Flora y vegetación de los andes desérticos de Chile. In: Squeo, F.A., Osorio, R. and Arancio, G. (eds), *Flora de Los Andes de Coquimbo: Cordillera de Doña Ana*. 1–17. Ediciones Universidad de La Serena.
- Stebbins, G.L. 1942. The genetic approach to the problem of rare and endemic plants. *Madroño* **6**: 241–258.
- Stebbins, G.L. and Major, G.L. 1965. Endemism and speciation in the Californian flora. *Ecological Monographs* **35**: 1–35.
- Stevens, G.C. 1989. The latitudinal gradient in geographical range: how so many species coexist in the tropics. *American Naturalist* **133**: 240–256.
- Stiassny, M.L.J. and di Pinna, M.C.C. 1994. Basal taxa and the role of cladistic patterns in the evaluation of conservation priorities: a view from freshwater. In: Forey, P.L., Humphries, C.J. and Vane-Wright, R.I. (eds), *Systematics and Conservation Evaluation*. 235–249. Clarendon Press, Oxford.
- Stork, N.E. 1993. How many species are there? *Biodiversity and Conservation* **2**: 215–232.
- Strid, A. 1986. The mountain flora of Greece with special reference to the Anatolian element. *Proceedings of the Royal Society of Edinburgh, B* **89**: 59–68.
- Synder, K., Baskin, J. and Baskin, C. 1994. Comparative ecology of the narrow endemic *Echinacea tenneesseensis* and two geographically widespread congeners: relative competitive ability and growth characteristics. *International Journal of Plant Science* **155**: 57–65.
- Terborgh, J. 1974. Preservation of natural diversity: the problem of extinction prone species. *BioScience* **24**: 715–722.
- Terborgh, J. and Winter, B. (1982). Evolutionary circumstances of species with small ranges. In: Prance, G.T. (ed.), *Biological Diversification in the Tropics*. 587–600. Columbia University Press, New York.
- Terborgh, J. and Winter, B. (1983). A method for siting parks and reserves with special reference to Colombia and Ecuador. *Biological Conservation* **27**: 45–58.
- Thaler, L. 1973. Nanisme et gigantisme insulaires. *La Recherche* **37**: 741–750.
- Thomas, C.D. 1991. Habitat use and geographic ranges of butterflies from wet lowlands of Costa Rica. *Biological Conservation* **55**: 269–281.
- Trexler, J.C. and Travis, J. 1993. Nontraditional regression analyses. *Ecology* **74**: 1629–1637.
- Usher, M.B. 1986. Wildlife conservation evaluation: attributes, criteria and values. In: Usher, M.B. (ed.), *Wildlife Conservation Evaluation*. 3–44. Chapman and Hall, London.
- Usher, M.B. and Jefferson, R.G. 1991. Creating new and successional habitats for arthropods. In: Collins, N.M. and Thomas, J.A. (eds), *The Conservation of Insects and their Habitats*. 263–291. Academic Press, London.
- Valentine, D.H. (ed.) 1972. *Taxonomy, Phytogeography and Ecology*. Academic Press, London.
- van Tol, J. and Verdonk, M.J. 1988. *The Protection of Dragonflies (Odonata) and their Biotopes*. European Committee for the Conservation on Nature and Natural Resources, Strasbourg.
- Van Valen, L. 1965. Morphological variation and width of ecological niche. *American Naturalist* **99**: 377–390.
- Vane-Wright, R.I. and Peggie, D. 1995. The butterflies of northern and central Maluku: diversity, endemism,

- biogeography, and conservation priorities. *Tropical Biodiversity* (in press).
- Vane-Wright, R.I., Humphries, C.J. and Williams, P.H.** 1991. What to protect? – Systematics and the agony of choice. *Biological Conservation* **55**: 235–254.
- Vermeij, G.J.** 1972. Endemism and environment: some shore molluscs of the tropical Atlantic. *American Naturalist* **106**: 89–101.
- Vrba, E.S.** 1980. Evolution, species and fossils: how does life evolve? *South African Journal of Science* **76**: 61–84.
- WCMC (World Conservation Monitoring Centre).** 1992. *Global Biodiversity: Status of the Earth's living resources*. Chapman and Hall, London.
- Wells, P.V.** 1969. The relation between mode of reproduction and extent of speciation in woody genera of the California chaparral. *Evolution* **23**: 264–267.
- Wild, H. and Bradshaw, A.D.** 1977. The evolutionary effects of metalliferous and other anomalous soils in south central Africa. *Evolution* **31**: 282–293.
- Williams, P.H.** 1993. Measuring more of biodiversity for choosing conservation areas, using taxonomic relatedness. In: Moon, T.-Y. (ed.), *International Symposium on Biodiversity and Conservation*, 194–227. Korean Entomological Institute, Seoul.
- Williams, P.H. and Humphries, C.J.** 1994. Biodiversity, taxonomic relatedness, and endemism in conservation. In: Forey, P.I., Humphries, C.J., and Vane-Wright, R.I. (eds), *Systematics and Conservation Evaluation*. 269–287. Clarendon Press, Oxford.
- Williams, P.H., Humphries, C.J. and Gastón, K.J.** 1994. Centres of seed plant diversity: the family way. *Proceedings of the Royal Society of London, B* **256**: 67–70.
- Williams, P.H., Vane-Wright, R.I. and Humphries, C.J.** 1993. Measuring biodiversity for choosing conservation areas. In: LaSalle, J. and Gauld, I.D. (eds), *Hymenoptera and Biodiversity*. 309–328. CAB International, Wallingford.
- Willis, J.C.** 1922. *Age and Area: A study of geographical distribution and origin of species*. Cambridge University Press, London.
- Wright, D.H.** 1983. Species–energy theory: an extension of species–area theory. *Oikos* **41**: 496–506.
- Zedler, P.H., Gautier, C.R. and Jacks, P.** 1984. Edaphic restriction of *Cupressus forbesii* (tecate cypress) in southern California, U.S.A. – a hypothesis. In: Magaris, N.S., Arianoustou-Farragitaki, M. and Oechel, W.C. (eds), *Being Alive on Land*. 237–243. Junk, The Hague.

Acknowledgements

The authors of Section 3.3 are grateful to Drs C.J. Humphries, N. Platnick, R.I. Vane-Wright and P.H. Williams for their suggestions to the manuscript and to Mr J.K. Hudson for assistance with the references.

4

Generation, Maintenance and Loss of Biodiversity

R. BARBAULT AND S. SASTRAPRADJA

Lead Authors:

R. Barbault, K. Hindar (Chapter 4.0); J.J. Sepkoski (Chapter 4.1); M. Slatkin, K. Hindar, Y. Michalakis (Chapter 4.2); B. Schaal, W.J. Leverich (Chapter 4.3); I. Hanski, J. Clobert, W. Reid (Chapter 4.4); M. Loreau, R. Barbault, H. Kawanabe, M. Higashi, E. Alvarez-Buylla, F. Renaud (Chapter 4.5)

Contributors:

R. García Barrios, R. Dirzo, P.H. Gouyon, P. Janvier, G.A. Olsson, R.S. Rana, A. Sarr, G. Vida, J.D. Vigne, S.J. Wright

CONTENTS

Executive Summary	197		
4.0 Introduction	201		
4.1 Large-scale history of biodiversity	202		
4.1.1 Introduction	202		
4.1.2 The nature of the fossil record	202		
4.1.2.1 General considerations	202		
4.1.2.2 Estimating fossil biodiversity with higher taxa	202		
4.1.3 History of biodiversity	203		
4.1.3.1 Animal diversity in the oceans	203		
4.1.3.2 Pre-animal biodiversity in the oceans	205		
4.1.3.3 Plant diversity on land	205		
4.1.3.4 Terrestrial arthropods	206		
4.1.3.5 Terrestrial tetrapod vertebrates	207		
4.1.4 Extinction through time	208		
4.1.4.1 Background extinction	208		
4.1.4.2 Mass extinction	208		
4.1.4.3 Recoveries from mass extinctions	210		
4.1.5 Late Cenozoic biodiversity	210		
4.1.5.1 Global diversity over the last 15 million years	210		
4.1.5.2 End-Pleistocene extinctions	211		
4.1.5.3 Biotic invasions	211		
4.1.5.4 Holocene community disequilibrium	212		
4.1.6 Conclusions	212		
4.2 Processes of genetic diversification	213		
4.2.1 Introduction	213		
4.2.2 Measures of genetic diversity	213		
4.2.2.1 Measures for single loci	213		
4.2.2.2 Multiple populations	214		
4.2.2.3 Multiple loci	215		
4.2.2.4 Quantitative characters	215		
4.2.2.5 Genomic variation	215		
4.2.3 Processes governing genetic evolution	215		
4.2.3.1 Mutation	216		
4.2.3.2 Genetic drift	216		
4.2.3.3 Natural and artificial selection	217		
4.2.2.3.1 Selection on phenotypic characters	218		
4.2.2.3.2 Selection on individual loci	218		
4.2.2.3.3 Spatial and temporal variation in selection	218		
4.2.2.3.4 Selection on multiple characters	220		
4.2.2.3.5 Response to selection	220		
4.2.3.4 Dispersal and gene flow	221		
4.2.3.5 Recombination	221		
4.2.4 Maintenance of genetic diversity	221		
4.2.4.1 Mutation and selection	222		
4.2.4.2 Inbreeding depression and heterosis	223		
4.2.4.3 Selection opposed by gene flow	223		
4.2.4.4 Outbreeding depression	224		
4.2.4.5 Gene flow opposed by genetic drift	224		
4.2.5 Summary	225		
4.3 Diversification of species	225		
4.3.1 Population differentiation	226		
4.3.2 Speciation	229		
4.3.2.1 Allopatric speciation	229		
4.3.2.2 Parapatric speciation	230		
4.3.2.3 Sympatric speciation	230		
4.3.2.4 Other modes of speciation	230		
4.3.3 Multiplication of species	231		
4.3.4 Summary	232		
4.4 Ecology of extinctions	232		
4.4.1 Current rate of extinctions	232		
4.4.1.1 Past extinctions	232		
4.4.1.2 Recent extinctions	233		
4.4.1.3 Current status and rate of extinctions	234		
4.4.2 Mechanisms of extinction	236		
4.4.2.1 Single populations	236		
4.4.2.1.1 Low population density: Allee effects	236		
4.4.2.1.2 Demographic stochasticity	236		
4.4.2.1.3 Environmental stochasticity	237		
4.4.2.1.4 Genetic factors in extinction	237		
4.4.2.1.5 Summary	238		
4.4.2.2 Metapopulations: assemblages of several local populations	238		
4.4.2.2.1 Colonization–extinction stochasticity	240		
4.4.2.2.2 Regional stochasticity	240		
4.4.3 Causes of extinction	240		
4.4.3.1 Loss of habitat	240		
4.4.3.2 Changes in habitat quality	241		
4.4.3.3 Habitat fragmentation	241		
4.4.3.4 Persecution and exploitation of populations	241		
4.4.3.5 Change in the biotic environment	242		

4.4.3.6 Summary	242	4.5.3 Predation and mutualism as diversity-maintaining processes	248
4.4.4 Predicting extinction rates	242	4.5.4 How species are interdependent through manifold indirect interactions	251
4.4.4.1 Single populations	242	4.5.5 The role of spatial and temporal variability of the environment in the maintenance of biodiversity	252
4.4.4.2 Metapopulations	243	4.5.6 From ecosystems to genes: the role of coevolution in the generation of biodiversity	255
4.4.4.3 Population viability analysis	244	4.5.7 Towards an integrated approach	255
4.4.5 Summary	244	4.5.8 Summary	258
4.5 Dynamics of biodiversity at the community and ecosystem level	245	References	258
4.5.1 Introduction	245		
4.5.2 Competition and community organization	245		

EXECUTIVE SUMMARY

Section 4 addresses all of the questions related to the basic dynamics of biodiversity: that is, the mechanisms of its creation, its maintenance and its alteration, including loss. The main findings of this assessment, and the major knowledge gaps identified, are as follows.

History of biodiversity

- The fossil record provides rich data on biodiversity through the history of life.
- The fossil record reveals that most species are rather ephemeral and that more than 95% of species that ever existed are now extinct.
- Mean life-span of fossil species, based on mammals and marine invertebrates, varies by an order of magnitude, from one million years to 10 million years.
- Rebounds from mass extinctions are geologically rapid but ecologically slow, and the recovery of biodiversity and re-establishment of some communities typically require 5–10 million years.
- Background extinction patterns, as deduced from the fossil record, are potential sources of insight regarding present-day losses of biodiversity.
- Evidence from the most recent part of the fossil record will be the best for understanding how biodiversity responds to changing environmental and biotic conditions.

Genetic diversification

- Genetic diversity within a species is important for understanding biodiversity for two reasons: (1) the potential of a species to respond to environmental change depends on the extent of diversity and the kind of diversity that is present, and (2) current patterns of genetic diversity can provide important clues to the history of a species and to its current population structure.
- Commonly used measures of genetic diversity are based on a small sample of loci, usually fewer than 100 loci out of the tens of thousands that are thought to be important in higher organisms. It is as yet unknown to what extent this sample is representative of the genome as a whole.
- A knowledge gap exists in identifying genetic variation in loci that are important for adaptive evolution.

- The processes that govern the evolution of allele frequencies are well known, but we know little about how these processes act together in maintaining diversity in each species.
- Small population size increases the rate of loss of genetic diversity. Strong reduction in population size can result in significant reduction in viability or fertility (inbreeding depression), especially in outcrossing species.
- It is not possible to predict the response of natural populations to a major change in the environment. Although artificial selection experiments have shown a potential for rapid genetic response in most traits of most species, a species can react to environmental change in ways that do not require genetic evolution, for example by changing its habitat or geographic range, or by going extinct.
- Different populations of the same species may be adapted to different ecological conditions. Ignoring those differences, some of which drastically inhibit interbreeding, can have undesirable and immediate consequences.
- New genetic tools are discovered on a regular basis and hold promise for increased understanding and improved management of present and future diversity at the genetic and population level.

Speciation

- The formation of new species occurs by a number of different mechanisms whose importance varies between taxonomic groups. Whatever the mechanism, three points about speciation are generally applicable: (1) it begins with an existing species, (2) it is associated with genetic change, and (3) it has a strong ecological context.
- Speciation occurs along two possible paths: (1) a gradual change of an entire lineage, or (2) the branching of a lineage into two separate lineages.
- Allopatric (geographic) speciation, where populations diverge while spatially separated, is regarded as the most common mode of speciation in animals.
- Parapatric speciation, where adjacent populations diverge, and sympatric speciation, where divergence occurs without spatial separation, are possible modes of speciation but their importance is controversial.

- Speciation by polyploidization is common among plants, where many species are the result of chromosome duplication in hybrids between two other species.
- Rapid multiplication of species has occurred several times in the history of life, and in widely different taxa. Rapid speciation may be associated with the evolution of key structures (key innovations), or with the occupation of vacant niches, but these explanations must still be regarded as tentative.
- The phenomenon of speciation teaches us that conservation of biodiversity must include conservation of the evolutionary processes that generate and maintain diversity.
- Small populations have a high risk of extinction, whatever the cause of their small size, and whatever the relative importance of the various mechanisms of extinction.
- Factors important to single populations apply to groups of populations (metapopulations) as well. In addition, metapopulation extinction depends on stochasticity in local colonization and extinction rates, and on the degree of spatial correlation of environmental conditions.
- Causes of extinction, i.e. those factors that make populations vulnerable to extinction in the first place, include habitat degradation (loss, change in quality and fragmentation), over-exploitation and persecution, and introductions of alien species. All of these factors may have been important in the extinction of 2000 species of birds (20% of the total number of bird species) on oceanic islands, following the arrival of humans on those islands.

Ecology of extinctions

- Documented extinctions since 1600 amount to 484 animal species and 654 plant species. These numbers are certainly underestimates of the actual number of extinctions.
- Current and past extinction rates can best be compared by estimating the life-span of an average species in well-known taxa; for mammals, it is (of the order of) 1 million years based on the fossil record, 10 000 years based on documented extinctions during the last century, and 100 to 1000 years based on recent species-by-species assessments of extinction risk.
- Current and future extinction rates have been estimated indirectly from the relationship between the size of an area and how many species it holds. Recent rates of deforestation of 1% per annum translate into rates of extinction of about 0.25% per annum (this should be interpreted as the fraction of species eventually going extinct according to the species–area relationship).
- It is clear that even if the above-mentioned numbers should be regarded as only crude estimates, current extinction rates are dramatically higher than background extinction rates.
- For every species that goes extinct, many populations have become extinct (termed local extinction or extirpation). Particularly well documented cases of local extinction come from the British Isles and the Netherlands. In the latter, 2–24% of the species in well-known taxa such as butterflies, birds and mammals are now nationally extinct.
- Mechanisms of extinction, i.e. those factors that explain why populations go extinct under prevailing environmental conditions, include negative (population) growth rate, demographic stochasticity due to randomness in births and deaths, environmental stochasticity due to climatic and other external variability, and genetic factors.

Dynamics at the community and ecosystem level

- Biodiversity cannot be properly understood without due consideration of its dynamics in communities and ecosystems. Interactions among species play an essential role in the generation and maintenance of biodiversity.
- No single factor can account for the whole structure and species diversity of communities. Abiotic factors, biological interactions such as competition, predation, parasitism and mutualism, and their various indirect effects, ecosystem processes, temporal and spatial variability of the environment, regional processes and historical contingency, and evolutionary processes, all have to be taken into account to varying degrees to explain the diversity of species in any local community or region.
- Interspecific competition tends to limit the number of coexisting species on an ecological time-scale, but also to increase niche differentiation among species, and thus to diversify species' traits on an evolutionary time-scale. Although predation has direct negative effects on the prey consumed, it can also be a powerful factor enhancing prey species diversity.
- Many species are important to others not because they feed upon them or are fed upon by them, but because they provide their physical habitat, modify their physical habitat or provide them with diverse benefits such as protection or dispersal (various mutualists).

- The continued interactions among organisms are not only responsible to a significant extent for the maintenance of biodiversity, but also for its evolutionary generation. The coevolution of species tends to produce novel biological traits. It is likely to be particularly important in host–associate systems, where it can take the form of co-speciation.
 - Spatial heterogeneity and temporal variability of the environment are also major factors determining the maintenance of biodiversity in communities and ecosystems. Environmental heterogeneity allows potentially more species to coexist, and may be especially important in the maintenance of the diversity of plants and other sessile organisms. Temporal fluctuations of the environment also increases the potential for coexistence of species.
 - Our ability to predict the long-term consequences of species losses or introductions on existing communities is still limited due to the manifold potential indirect interactions among species. This commands caution in attempts to manage biodiversity.
 - The rich complexity of both the physical environment and the interactions among organisms and species appears to be crucial for the maintenance and generation of biodiversity. Thus, the ecosystem and its component communities appear to be very appropriate targets for conservation, because they take into account explicitly the many ecological interactions between organisms and their biotic and abiotic natural environment. A space-orientated approach up to the landscape scale may be the most appropriate tool with which to conserve the vast majority of biological diversity.
-

4.0 Introduction

Understanding the natural dynamics of biodiversity at all levels from genes to ecosystems is essential for evaluating the impact of humans on this diversity. This Section outlines the processes and mechanisms that govern the generation, maintenance and loss of biodiversity. Our perspective is a broad one: over 3.5 billion years of life, millions of species, the genetic uniqueness of virtually every individual, and the ecological interactions between individuals within and among species. Yet, this multitude of life-forms can be understood in the light of a single unifying concept – the theory of evolution. This theory holds that organisms now living have descended with modification from common ancestors, and that the mechanisms (if not always the underlying causes) that brought about changes in the past, operate today and therefore can be studied experimentally (e.g. Dobzhansky 1970; Futuyma 1986).

It is not our purpose to review here the theory of evolution. Rather, we present those aspects of it that are relevant for understanding the current biodiversity crisis. In Section 4, we focus on living beings (biota) whereas Sections 5 and 6 include the abiotic environment in their focus on ecosystems. Collectively, Sections 4, 5 and 6 provide a framework for understanding the magnitude, patterns and trends in biodiversity as they are outlined in Sections 2 and 3. Moreover, they lay a foundation for evaluating how human action influences biodiversity, both by threatening it (Section 11) and by conserving it or sustainably using its components (Sections 10 and 13).

Section 4 was initially planned as part of the DIVERSITAS programme of IUBS, UNESCO and SCOPE (Solbrig 1991). In its current form it is a joint contribution of GBA and DIVERSITAS. The section is divided into five chapters, each addressing one of the following questions relevant to the dynamics of biodiversity: (1) What does the history of life on Earth teach us about future biodiversity? (2) What are the mechanisms of genetic change and what is the role of genetic diversity in determining the ecological and evolutionary potential of species? (3) What processes lead to the formation of new species? (4) What do we know about extinction rates and about the mechanisms and underlying causes that bring about extinction? (5) How far do the dynamics and future of biodiversity depend on the community and ecosystem structure in which it exists?

Chapter 4.1 reviews some of what is known about ancient biodiversity, from the recesses of deep time in the Precambrian microbial world to the rapid ecological shifts witnessed by pre-literate humans. It begins with a general consideration of the quality of the fossil record. Then, it briefly summarizes current knowledge of the historical development of taxonomic richness among various components of the Earth's biota. This is followed by a very

brief review of ancient pulses of extinction and their consequences for victims and survivors. Finally, it ends with considerations of the most recent and best-resolved portion of the fossil record, which illustrates how the biota reacted to important geological and climatic changes.

Chapter 4.2 focuses on the contribution of population genetics to understanding biodiversity. The chapter describes measures of genetic diversity for different levels of genetic variation, and outlines the processes that govern this diversity within and between populations. The point is made that although our knowledge of basic population genetic processes is good, we know little about how these processes interact to maintain genetic diversity, especially as it relates to adaptive evolution. This limits the possibility of predicting the response of a species to environmental change.

Chapter 4.3 outlines the processes that lead to the formation of new species, and examines the evolutionary diversification of species. Building on the various species concepts described in Section 2, and on the processes of genetic diversification described in Chapter 4.2, this chapter discusses why different modes of speciation prevail in different taxa, and why some modes of speciation are still controversial. The chapter concludes by highlighting the role of evolutionary processes in conservation thinking.

Chapter 4.4 compares extinction rates in the past with estimates for the present and predictions for the future. Whatever the method used, the projected rates for the near future are extremely high compared with the natural background. The chapter outlines the reasons why small populations are more vulnerable to extinction than large ones, and presents a summary of the causes that make populations small in the first place. Finally, the chapter describes how theoretical and empirical knowledge about target species can be combined to assess their future risk of extinction.

Chapter 4.5 highlights the community and ecosystem framework that forms the basis of the origin, maintenance and loss of diversity at lower levels. The dynamics and future of biodiversity rely (in a similar manner to the traits of species) on selective pressures applied by elements of the ecosystem, including habitat structure, food species, predators, parasites, mutualist species and diseases. The chapter introduces some of the processes that are further discussed in Sections 5 and 6 and examines the role of interspecific biological interactions in the origin and maintenance of biodiversity, including evolutionary aspects. It outlines the reasons why spatial heterogeneity and temporal variability of the environment are also major factors determining biodiversity in communities and ecosystems. Finally, the chapter emphasizes how crucial for the dynamics of biodiversity are the rich complexity of the physical environment and the interactions among organisms and species. It concludes that ecosystems and

their component communities are very appropriate targets for biodiversity conservation.

4.1 Large-scale history of biodiversity

4.1.1 Introduction

The fossil record is the principal archive of ancient biodiversity. Together with morphological and genetic relationships among living species, molecular clocks, and modern biogeographic distributions, the fossil record permits historical reconstruction of the origins of modern biodiversity. The record also reveals biotic events that could never be deduced from the living biota alone, such as vast evolutionary radiations and mass extinctions.

The fossil record also reveals that most species are rather ephemeral and that more than 95% of species that ever existed are now extinct (Raup 1991a). The average animal species in the oceans has a duration of approximately 4 million years (Ma) (Raup 1991b). This is an incredibly long time by human cultural standards but remarkably short in comparison to the nearly 4000 Ma history of life on Earth. A 4 Ma duration means that roughly 25% of marine species become extinct each million years. If it is assumed that this figure is general to all ecosystems, and that the Earth harbours over 107 species, then, on average, two to three species world-wide should become extinct each year from natural processes. The fossil record shows, however, that there is a huge variance about this simple average, with long quiet intervals, when the net amount of biodiversity accumulated, and pulses of extinction, when the net amount of biodiversity declined.

4.1.2 The nature of the fossil record

4.1.2.1 General considerations

The usual fossil is a bit of shell, an impression of a leaf, or an isolated tooth weathered from some geological stratum. Each provides evidence as to the identity and distribution of some ancient organism. The evidence is fragmentary, lacking details of the complete anatomy, behaviour, physiology, genetics or abundance of the species. The usual fossil is not a soft-bodied annelid, a lightly skeletalized copepod, or a mountain-dwelling herb. These kinds of organisms, with comparatively few exceptions, are lost to biological and physical processes of decay and rock formation. Thus, the fossil record is very incomplete in its capture of ancient biodiversity, a fact recognized by Darwin (1859) in two of his longest chapters in *On the Origin of Species*.

In recent decades there have been interesting efforts to measure the incompleteness of the fossil record, for both global biotas and specific taxa, and to develop numerical methods to accommodate this incompleteness. Estimates of incompleteness of global biotas involve counts of the number of described fossil species and educated guesses as

to how many species must have existed over geological time. For the marine fauna, Raup (1976) counted 190 000 fossil invertebrate species listed in the *Zoological Record* up to 1970. The actual number of described fossil marine animal species is now probably somewhere between 250 000 and 300 000, accommodating newly described species (especially from Asia), marine vertebrates, and older species overlooked by the *Zoological Record*.

Estimating how many animal species ever lived in the oceans involves four kinds of numbers: (1) how many species are alive today; (2) the age of the oldest fossil animal; (3) the average geological duration of species; and (4) the trajectory of diversity increase over time. All of these numbers presently have considerable uncertainty, but some rough figures are available. Recent estimates of modern animal diversity in the oceans place the figure at about 245 000+ (Winston 1992; see also Briggs 1994). Redating of the Proterozoic–Cambrian boundary at 545 Ma (Bowring *et al.* 1993) and discovery of primitive Ediacaran-type fossils associated with late Varangerian glacial tillites (Narbonne and Hofmann 1987) leads to an estimate of roughly 600 Ma for the age of the oldest animal species. As discussed above, the estimated average duration of a species is about 4 Ma. The fourth estimate needed, the history of marine species diversity, is the most uncertain (e.g. Signor 1990), but it has been suggested that despite the ups and downs of marine biodiversity through the Phanerozoic (see 4.1.3.1), a straight-line interpolation between 600 and 0 Ma might not accumulate too much error (Sepkoski 1992a). Thus, the rough estimate of the total number of animal species that ever lived becomes the area of a triangle measured in units of 4 Ma:

$$1/2 \times 245000 \text{ species} \times 600 \text{ Ma}/4 \text{ Ma} = 18\,375\,000 \pm \text{species.}$$

4.1.2.2 Estimating fossil biodiversity with higher taxa

The sample of species from most of the fossil record may be small and biased, but palaeontologists have recognized that higher taxa in the traditional Linnaean hierarchy might provide better reflections of the history of taxonomic biodiversity (e.g. Simpson 1953; Newell 1967; Valentine 1969; Raup 1979a; Sepkoski 1992a). The reasoning is simple: there are fewer genera, families and so on than species and therefore the sampling of one species documents the occurrence of a genus, family and so on. Thus, the known record of supraspecific taxa must be more complete and less biased than the 2% sample for fossil species. This approach has recently been embraced by some conservation biologists (e.g. Gaston and Williams 1993; Prance 1994; Williams and Gaston 1994; Gaston *et al.* 1995) who are advocating use of higher taxa to identify 'hotspots' of modern local biodiversity.

The use of higher taxa begs the question of whether the diversity of genera, families, etc. erected by systematists

co-varies with the richness of species. The problem is that Linnaean supraspecific taxa have often been delineated arbitrarily, vary greatly in size, and frequently differ from modern phylogenetic concepts of holophyletic clades.

Palaeontologists have offered three arguments in support of using traditional Linnaean taxa to study underlying species richness. The first is that in the modern world the diversity of supraspecific taxa frequently parallels that of species, among islands, continents and latitudinal zones (e.g. Stehli *et al.* 1967; Flessa 1975; Jablonski and Flessa 1986). The second is that measures of taxonomic richness in the oceans are co-parallel, no matter how they are measured: local taxonomic richness of recognized species (alpha diversity) correlates highly with global species, genus and family diversity (Sepkoski *et al.* 1981).

The final argument for why traditional higher taxa might adequately reflect underlying species patterns of diversification has involved computer modelling. Some palaeontologists have developed virtual phylogenies governed by reasonable rates of evolution and plausible modes of sampling. Sepkoski and Kendrick (1993) did this in response to arguments by Patterson and Smith (1987, 1989) that arbitrarily defined taxa (i.e. non-holophyletic) could not accurately reflect geological patterns of extinction and, by supposition, taxonomic diversity among species (Smith 1994). Sepkoski and Kendrick's models suggested that arbitrary, paraphyletic groups of highly variable membership can indeed adequately reflect underlying patterns of species richness under many patterns of diversification and sampling. Thus, the published consensus seems to be that patterns of taxonomic diversity compiled from local fossil sites and from compilations of taxa from the palaeontological literature reflect something of the true large-scale history of biodiversity.

4.1.3 History of biodiversity

The best-documented history of change and maintenance of biodiversity is for marine animals. This is because the marine fossil record is more complete (seas accumulate sediment whereas land tends to erode); temporal correlation and therefore macro-evolutionary pattern are better controlled; and more marine fossil species have been studied than fossil terrestrial species (Raup 1976; although see Benton and Simms 1995).

4.1.3.1 Animal diversity in the oceans

Figure 4.1-1 illustrates the known diversity history of marine animal families counted at the geological standard of international stratigraphic stages. Three phases of diversification are evident. The first is the Cambrian phase, which actually encompasses two phenomena: an explosive radiation in the Early Cambrian (during which most animal phyla appeared; e.g. Conway Morris 1993) and then a stabilization of familial diversity through the Middle and

Late Cambrian. The ensuing Palaeozoic phase of diversification encompasses a larger, tripling of familial richness during the Ordovician and then a stabilization of marine diversity for nearly a quarter of a billion years (except for several events of mass extinction and subsequent rebound). This phase in the history of marine diversity is ended by the end-Permian mass extinction and is followed by an almost steady increase in familial diversity through the Mesozoic and Cenozoic Eras except, again, for several mass extinctions. This increase is not constant, however, but seems to be tapering through time (Sepkoski 1984; see also Benton 1995), suggesting an approach toward a plateau similar to the short-lived stabilization of the Cambrian and the longer plateau of the later Palaeozoic (see 4.1.5.1).

It is interesting to note that the three phases of marine diversification were not contributed to equally by all animal groups that arose in the great Cambrian explosion. Rather, the Cambrian phase of radiation was contributed by taxonomic groups often viewed as archaic, such as trilobite arthropods, inarticulate brachiopods, hyoliths (possibly related to sipunculids and/or molluscs; see Runnegar *et al.* 1975), and primitive echinoderms (Guensburg and Sprinkle 1992). Most of these animals played little role in the Ordovician radiations. The Palaeozoic interval of diversification was a function of radiation of the sessile benthos: articulate brachiopods, crinoids, tabulate and rugose corals, and the stenolomate bryozoans. These groups (other than the last) appeared during the Cambrian but did not expand appreciably until the Ordovician; they underwent massive radiation and then dominated most marine ecological communities until the end of the Permian Period. The modern animals that live on present-day oceanic continental shelves, such as bivalves, gastropods, shrimps and crabs, sea urchins, and marine vertebrates, are responsible for the final phase of Phanerozoic marine diversification. This final diversification more than doubled taxonomic richness in the Cenozoic oceans over levels experienced during the Palaeozoic.

The Cambrian marine fauna consisted largely of generalized detritus-feeders and low suspension-feeders; they had low alpha (community-level) diversity (Bambach 1977) and evidently low beta (between-community) diversity, suggesting rather low levels of ecological specialization. The Cambrian fauna was replaced during the Ordovician Period by more diverse epifaunal suspension-feeders that seem to have been more ecologically specialized; Sepkoski (1988) measured beta diversity for Palaeozoic benthic animals and found a major increase in habitat specialization associated specifically with the Ordovician radiation, and not repeated with later Palaeozoic changes. The rise of the Modern evolutionary fauna is associated with the 'Mesozoic Marine Revolution', which involves the evolutionary expansion of shell-

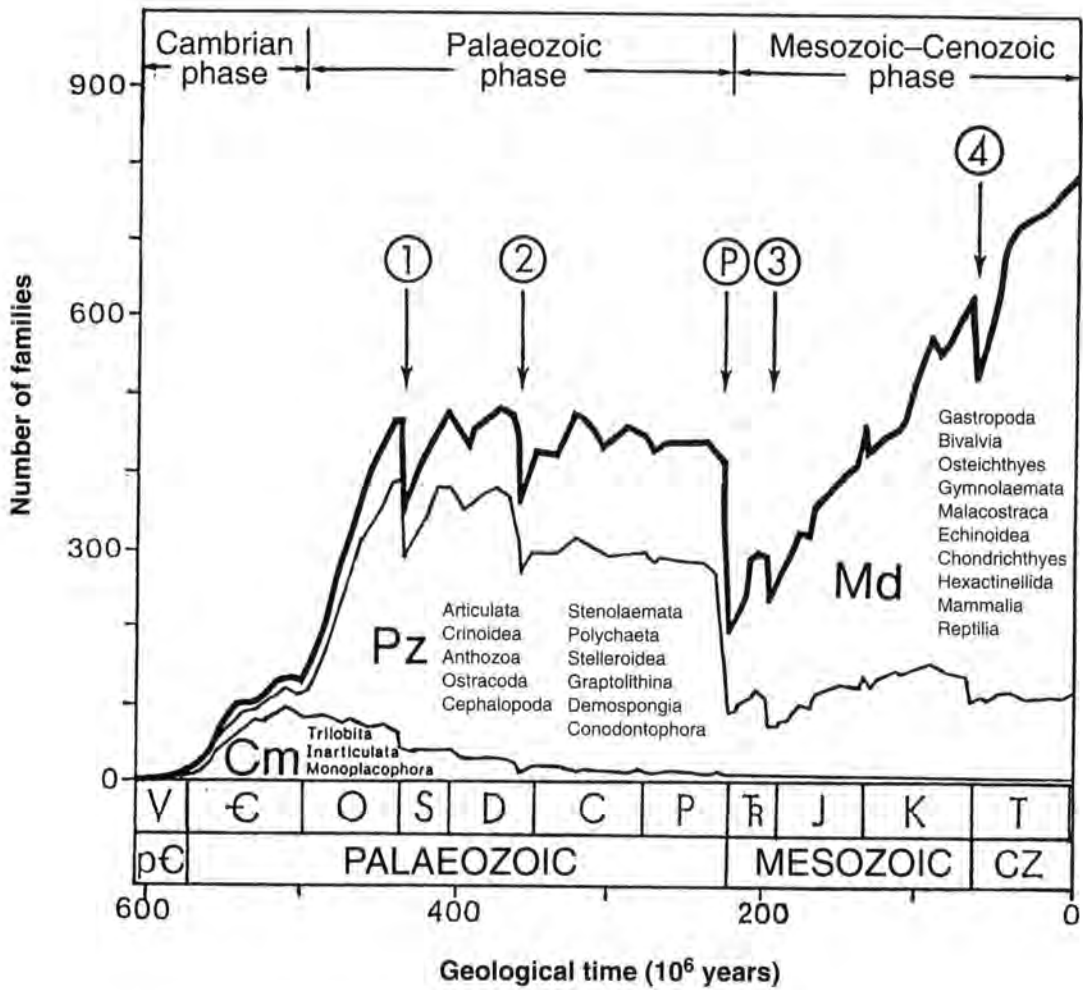

Figure 4.1-1: Diversity of marine animal families through 77 time intervals of the Phanerozoic. The heavy upper curve shows the total number of families with skeletalized species known from the fossil record, with the principal phases of diversification indicated at the top. The fields below the upper curve show the contributions of the three great evolutionary faunas (Cm = Cambrian Fauna; Pz = Palaeozoic fauna; Md = Modern fauna). Some of the major classes are listed for each fauna. Arrows mark the five major mass extinctions of the marine realm: P = end-Permian (the largest); 1 = end-Ordovician; 2 = Late Devonian; 3 = end-Triassic; 4 = end-Cretaceous. (From Sepkoski 1992.)

breaking predators (Vermeij 1977, 1987) and disruptive sediment movers (Thayer 1983), which could have destroyed the stable bottom environment of the Palaeozoic sessile benthos.

There are two modes of explanation for the 'stair-step' pattern of increase in taxonomic richness and replacement of evolutionary faunas. One is that it is a response to various extrinsic factors that might enhance marine biodiversity, and the other that it is an intrinsic response of the biota itself. Extrinsic explanations vary. For example, Valentine (1971) argued that the Mesozoic–Cenozoic increase in marine biodiversity reflects the break-up of the supercontinent Pangaea and increasing climatic differentiation during the Cenozoic. These factors would enhance longitudinal and latitudinal endemism respectively, leading to greater global diversity (see also Cracraft 1985, 1992). More recently, Bambach (1993) has argued that the

expanding diversity from the early Palaeozoic to the Cenozoic is a marine response to increased nutrient runoff from land: early colonization by land plants in the Ordovician and Silurian led to enhanced transport of nutrient-rich organic material down rivers to the oceans, allowing more marine species to coexist, and then rapid radiation of angiosperms into far more terrestrial habitats during the Cretaceous further enhanced the food supply for marine animals. Vermeij (1995) speculates further that geological intervals of major volcanism, associated with continental break-up and oceanic spreading, injected higher than usual levels of inorganic nutrients into ocean waters, which again permitted more species of animals to coexist.

Intrinsic explanations of the historical pattern of diversity increase in the oceans examine the evolutionary potential of the succeeding evolutionary faunas. Sepkoski (1984, 1991) has argued that different groups of major taxa

(i.e. taxonomic classes) have different characteristic rates of diversification and levels of 'equilibrium' (see also Kitchell and Carr 1985). These rates and 'equilibrium' relate to how finely the species subdivide environmental resources, with clades comprising characteristically very generalized species having high rates of evolution but low species-level carrying capacities, and clades of ecologically specialized species having lower rates of evolution (it is more difficult to find a specialized resource) but higher species-level carrying capacities (more species can inhabit a finely subdivided habitat). Evidence for this view is that (1) taxa among the successive marine evolutionary faunas seem to exploit more and more ecological means of making a living (Bambach 1983); (2) taxa seem to live in more parts of the benthic environment, both above and below the sediment-water interface, through the Phanerozoic (Bottjer and Ausich 1986); and (3) the empirical differences in rates of evolution and levels of diversity can be used as parameters in rather simple models that lead to parsimonious quantitative descriptions of faunal and diversity change through the marine Phanerozoic (Sepkoski 1984, 1991; Kitchell and Carr 1985).

4.1.3.2 Pre-animal biodiversity in the oceans

Animals appear in the fossil record nearly 85% of the way down the recorded history of life on this planet. The oldest fossils are currently dated at about 3550 Ma (Awramik *et al.* 1983). These fossils represent bacteria and perhaps even aerobic photosynthesizers (J.W. Schopf and Packer 1987). However, this earliest fossil record is sparse and still very poorly understood (J.W. Schopf 1992a). It is not until the Middle Proterozoic, beginning about 1800 Ma, that adequate fossils occur so that a record of global biodiversity can be assembled.

The occurrence of 'acritarchs' at about 1800 Ma provides a benchmark for the initial diversification of eukaryotic organisms. Acritarchs are refractory sporopollenin fossils larger in diameter than most prokaryotes and are interpreted as life-cycle stages of unknown groups of eukaryotic organisms (e.g. Knoll 1994). Knoll (1994) has summarized the known record of pre-Phanerozoic acritarch diversity and has shown that there was little diversification of these eukaryotes prior to 1000 Ma at either the local or global ecological scales. This date corresponds approximately to both an increase in the complexity of fossils found in the record, such as brown, green and chromophytic algae, and a growth in the taxonomic diversity of complexly ornamented, and thus differentiated, acritarchs. Knoll (1992) argues that this explosion in the fossil record is not inconsistent with current estimates from molecular phylogenies (Sogin *et al.* 1989) of a rapid divergence of eukaryotes with haplo-diploid sexuality late in the Proterozoic.

Thus, like the Phanerozoic fossil record, the Proterozoic record exhibits a pattern of jumps and bounds in taxonomic

diversity, perhaps related more to evolutionary innovation than to physical change. Once eukaryotic organisms became diverse, mass extinctions become empirically obvious in the fossil record (although J.W. Schopf (1992b) argues for a long-term decrease in microbial diversity starting around 1000 Ma and lasting until the Cambrian). There appear to be two mass extinctions among acritarchs in the Late Proterozoic, after about 700 Ma (Knoll 1994). The first is a decline associated with the widespread Varangerian glaciations, predating most metazoan fossils (see also Vidal and Knoll 1982). This was evidently followed by a rapid evolutionary rebound to even higher levels of planktonic diversity just below the widespread Ediacaran animals (Knoll 1994). A second crash ensued, followed by possible extinction of the Ediacaran animals (Seilacher 1989). In the earliest Cambrian, planktonic acritarchs again rebounded to much higher levels of diversity and with much higher rates of evolutionary turnover. Sepkoski (1992b) and Knoll (1994) rationalize this change as a response to ecological linkage of planktonic photosynthesizers with newly evolved benthic animal consumers.

4.1.3.3 Plant diversity on land

The terrestrial ecosystem seems to have lagged behind the oceans in colonization by complex organisms, despite a long history of eukaryotic photosynthesizers in the oceans. There is scant evidence of terrestrial photosynthesizers at perhaps 1000 Ma (Horodyski and Knauth 1994), but evidence of true land plants dates only from the mid-Ordovician at about 460 Ma (Gray 1985), more than 100 Ma after the emergence of metazoan animals in the oceans. This earliest history is represented by trilete spores of the kind produced by terrestrial plants. It is not for another 50 Ma, in the Late Silurian, that the fossil record yields plant tissues that can be definitively attributed to vascular plants (e.g. Niklas *et al.* 1985; Behrensmeier *et al.* 1992).

The first important diversification of land plants began in the Early Devonian, with rapid evolution from ground-hugging rhizomatous plants to forest canopy forms. With mature ecosystem structure, land plants thereafter diversified in leaps and bounds, much like animals in the oceans, with different 'evolutionary floras' becoming successively dominant (Niklas *et al.* 1983; Knoll 1986; Figure 4.1-2a). There was increased taxonomic diversity in the Carboniferous with the expansion of arborescent lycopods and pteridosperms; a small, but perceptible, increase in global diversity in the early Mesozoic ('Mesophytic') with ascendancy of the gymnosperms; and then a substantial and rapid increase in global plant diversity with the appearance and radiation of the angiosperms during the Early and Middle Cretaceous (Niklas *et al.* 1985; Lidgard and Crane 1988). These global

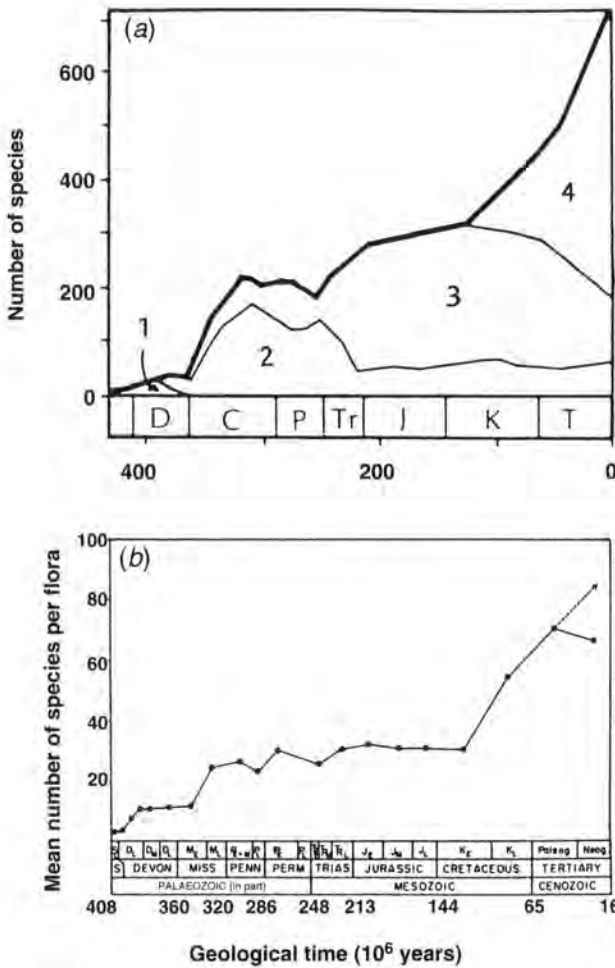

Figure 4.1-2: Land plant diversity through the Phanerozoic (Silurian to Tertiary). (a) Global species diversity (compiled mostly from Europe and North America). The upper heavy curve indicates total diversity, with fields below showing contributions of four evolutionary floras: 1 = primitive vascular plants; 2 = pteridophytes and lycopsids; 3 = gymnosperms; 4 = angiosperms. (b) Average alpha diversity of land plants (mean number of species per fossil flora). The local pattern is similar to the global pattern except that there is no increase in local diversity in the transition from evolutionary flora 2 to 3. The dashed line indicates the expected pattern had subtropical fossil flora been sampled, as in preceding intervals. (a) after Niklas *et al.* 1985; (b) from Knoll 1986.

changes are largely reflected in community-level increases in diversity (Figure 4.1-2b; Knoll 1986). Local fossil assemblages become much more diverse as pteridosperms radiate in the Early Carboniferous and especially as angiosperms expand in the mid-Cretaceous. Most data suggest that angiosperms are continuing their expansion toward the present day (Figure 4.1-2), although taxonomic precision and geographical sampling do not yet offer precise assessment.

Most explanations for this stepwise increase in the diversity of tracheophytes involve intrinsic evolutionary

breakthroughs. Niklas *et al.* (1985), for example, stress the reproductive differences among the various evolutionary floras and how reproductive innovations could have enhanced global floral diversity.

4.1.3.4 Terrestrial arthropods

Arthropods are now the most diverse group of animals on Earth (May 1988), and their major terrestrial components are insects and arachnids. Mites (Arachnida) may have moved on to land very early, virtually contemporaneously with the earliest land plants (Retallack 1985). However, the fossil record of arachnids is sparse, and little is known about the evolution of their terrestrial biodiversity (see Behrensmeier *et al.* 1992).

Insects appear in the fossil record in the Early Devonian (Labandeira *et al.* 1988) during the time of the initial diversification of land plants. The early record of insects is sparse, but by the Late Carboniferous numerous taxa of winged insects existed. Labandeira and Sepkoski (1993) and Jarzembowski and Ross (1993) have summarized the fossil record of insect families and have noted two major trends. First, insects of the Palaeozoic, including cockroaches and dragonflies, seem to have attained roughly stable diversities (Fig. 4.1-3) with much higher rates of turnover (i.e. extinction) than later insect groups. The Palaeozoic cohort appears to have suffered greatly at the end-Permian mass extinction, with approximately two-thirds of insect families becoming extinct. If the same calculations made by Raup (1979b) for the marine fauna apply, then much more than his 96% extinction of marine animals would apply to insects. This appears to be the only great extinction in the history of insects.

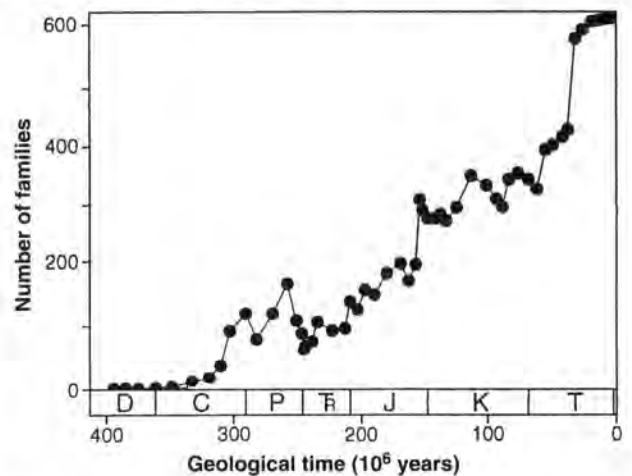

Figure 4.1-3: Diversity of insect families through the Phanerozoic (Devonian to Pleistocene). Although familial diversity appears to rise almost steadily, there is a major turnover, and probably a mass extinction, between the Permian (P) and Triassic (Tr). Sporadic, extremely rapid increases in diversity thereafter are artifacts of extremely good preservation, including the Jurassic lake deposits of Karatau and mid-Tertiary Baltic ambers. (Modified from Labandeira and Sepkoski 1993.)

Following the end-Palaeozoic, insects expanded greatly, probably up to the present day. This long-term expansion involved surviving groups from the Palaeozoic, such as the beetles and true bugs, as well as newly appearing clades, such as the moths and butterflies and the wasps, ants and bees (which include social insects). Interestingly, global insect diversity in the fossil record exhibits no response to the rapid expansion of angiosperms in the mid-Cretaceous and, if anything, exhibits a slowdown (but not cessation) of radiation. Reasons for this are not clear, but Labandeira and Sepkoski (1993) speculate that insects might have been approaching ecological saturation even before angiosperms spread, not unlike what is seen among Palaeozoic marine animals. Vermeij (1995) and others, however, question whether diversity counted at the level of insect families could resolve such a question.

4.1.3.5 Terrestrial tetrapod vertebrates

Tetrapod vertebrates – boned animals with four limbs – appear in the fossil record in the Upper Devonian, after the first phase of land plant and terrestrial arthropod diversification. The earliest tetrapods evidently were largely aquatic animals (Coates and Clack 1991), and many continued to be so through the succeeding Carboniferous Period (Ahlberg and Milner 1994). However, the Carboniferous witnessed the evolution of various solely terrestrial insectivorous tetrapods, including the first amniotes – those vertebrates capable of reproducing independently of water (Behrensmeyer *et al.* 1992). At an early time in this evolution, the synapsid line (eventually giving rise to mammals) separated from other tetrapods.

The evolution of taxonomic diversity among tetrapods is inadequately known. Terrestrial fossil deposits are unevenly preserved in time, with the Middle Jurassic especially poorly preserved (Benton 1987, 1988), and also in geographical distribution, with, for example, the very latest Cretaceous dinosaurs known definitely only from western North America (Dodson and Tatarinov 1990) and, perhaps, China. Thus, current diversity curves could represent as much barometers of current knowledge as measures of evolutionary diversity.

Benton (1985, 1989) has provided the best recent assessment of current knowledge of tetrapod taxonomic diversity (Figure 4.1-4a). His family-level data exhibit three ‘assemblages’ of tetrapods through time, not unlike the evolutionary faunas in the oceans. There is (1) low diversity in the mid- to Late Palaeozoic, involving mostly non-amniotic tetrapods; (2) probably higher diversity (but poorly preserved) in the Mesozoic, involving amniotic dinosaurs, pterosaurs and other diapsids; and (3) nearly an order of magnitude higher global diversity during the Cenozoic, contributed by mammals and birds. Benton (1990) has also collected numbers of fossilized species in well-preserved local faunas throughout the tetrapod fossil

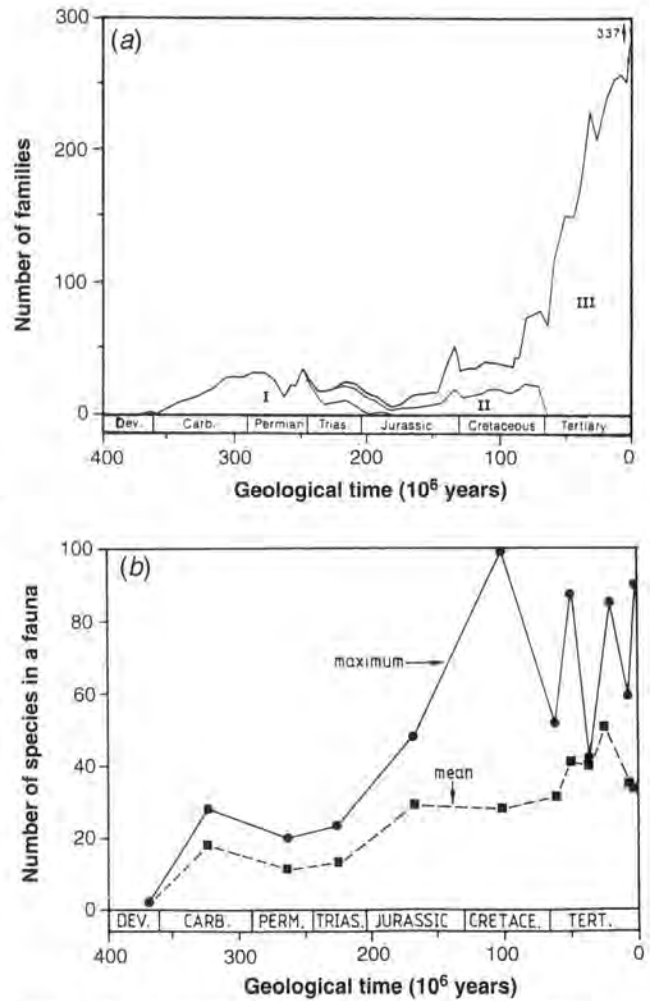

Figure 4.1-4: Diversity of tetrapod vertebrates through the Phanerozoic (Devonian to Pleistocene). (a) Global numbers of families. The upper curve shows the total number of families recognized throughout the world. Fields below indicate contributions from three, somewhat arbitrary ‘evolutionary assemblages’: I = labyrinthodont amphibians, non-turtle anapsids and mammal-like reptiles; II = early diapsids, pterosaurs and dinosaurs; III = lissamphibians, lizards, snakes, crocodiles, birds and mammals. The minimum in diversity over the Jurassic is an artefact of poor global preservation. (b) Mean and maximum local diversities, based on 100 well-sampled fossil tetrapod faunas. Local richness avoids some of the biases of global taxonomic diversity and exhibits increase in the Jurassic with the ascendancy of evolutionary assemblage II. It also exhibits a far smaller increase in the Tertiary with the expansion of assemblage III, perhaps because local richness is largely independent of provinciality and vicariance. (a) from Benton 1985; (b) from Benton 1990.

record (Figure 4.1-4b). These numbers exhibit a far smaller increase in tetrapod diversity between the Mesozoic and Cenozoic Eras. Maximum local species diversity in the Jurassic was as high as at any time, and average local diversity preserved in Cenozoic faunas was less than twice that of the middle and late Mesozoic. This suggests that the great increase in global tetrapod diversity during the

Cenozoic may have been a result of (1) the dispersal of continents with the break-up of Pangaea (consider the distinctiveness of the Australian marsupial fauna); and/or (2) enhancement of the equator-to-pole climatic gradient (consider the distinctiveness of modern tropical and temperate faunas).

4.1.4 Extinction through time

4.1.4.1 Background extinction

There is no significant geological interval in which some taxon below the ordinal level has not become extinct (Raup and Sepkoski 1982). Indeed, the calculations offered in 4.1.1 would suggest that as much as a quarter of Earth's species become extinct each million years. The reasons for this are unknown. Explanations range from Darwin's (1859) ideas concerning interspecific competition, to more recent attribution to climate change (e.g. Stanley 1988; Vermeij 1989), and to accumulation of deleterious genes as a result of inbreeding (e.g. Jimenez *et al.* 1994). No good protocol has yet been offered to distinguish between these different possibilities, largely because detailed observations in the fossil record are few, and time scales are long by human standards.

Some descriptive aspects of the history of background extinction have been documented, however. It seems that background rates have decreased over time among many higher eukaryotes (Figure 4.1-5). Marine animals seem to be less vulnerable to extinction now than during the Palaeozoic (Raup and Sepkoski 1982) as do some terrestrial tetrapods (Valentine *et al.* 1991). However, extinction rates among eukaryotic plankton (Knoll 1994) and land plants (Niklas *et al.* 1985) seem to have increased over time. Explanations for declines in specific systems have been of two kinds. One is that individuals within species have become progressively more fit over the geological eons so that species as a whole today are more resistant to extinction (e.g. Raup and Sepkoski 1982). The other, which has more empirical evidence, is that extinction resistance is a shared quality among species in a clade (Jablonski 1987) and that clades with extinction-prone species tend to disappear more rapidly than clades whose species are resistant to extinction (for whatever reason, such as wider geographical distribution; cf. Jablonski 1986a, b, 1991). Thus, a general decline in background extinction is an epiphenomenon of disappearance of clades with extinction-prone species and residual accumulation of clades with extinction-resistant species (Sepkoski 1984; Van Valen 1985).

4.1.4.2 Mass extinction

Superimposed on secular trends in background extinction are geological intervals in which vast numbers of species and higher taxa have disappeared, as illustrated in Figure 4.1-5. These intervals contain mass extinctions of the biota

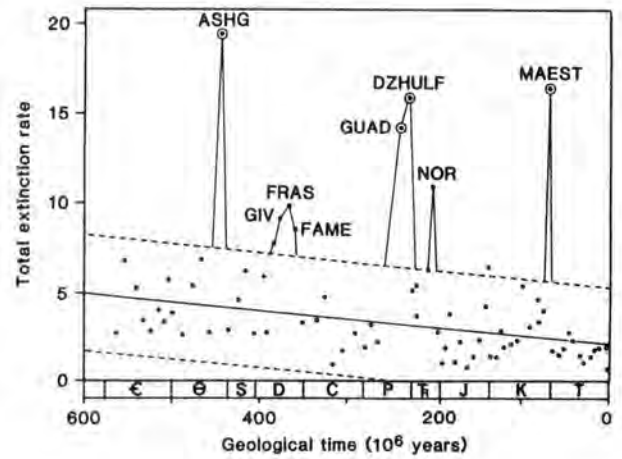

Figure 4.1-5: Background and mass extinction for marine animal families through the Phanerozoic. Total extinction rates are given by the numbers of extinctions per million years over 76 time intervals. Points are separated into two classes; background extinction, within the dashed envelope, and mass extinction, represented by spikes above. The solid line is a linear regression fitted to the background points and exhibits a secular decline such that normal familial extinction in the Tertiary is about half the magnitude of that in the Cambrian. The spikes are the five major mass extinctions: ASHG = Ashgillian (end-Ordovician); GIV = Givetian, FRAS = Frasnian, FAME = Famennian (Late Devonian); GUAD = Guadalupian, DZHULF = Dzhulfian (end-Permian); NOR = Norian (end-Triassic); MAEST = Maastrichtian (end-Cretaceous). (Modified from Raup and Sepkoski 1982.)

– phenomena observed only in the fossil record but now being inferred to be impacting the living biota (e.g. Wilson 1992). There are problems, however, in comparing modern biotic crises to fossil events: many past mass extinctions are resolved only to coarse geological intervals, involving millions of years; most are measured at taxonomic levels above the species; and data come from habitats not necessarily relevant to present-day problems. The exception is the late Quaternary extinctions, discussed in 4.1.5.2.

The most severe mass extinction seen in the Phanerozoic fossil record of complex organisms is in the latest Permian (Palaeozoic–Mesozoic boundary), approximately 245 Ma ago (Figures 4.1-1 and 4.1-5). In the oceans, approximately 50% of animal families (Raup and Sepkoski 1982) and 80% of animal genera (Sepkoski 1989) disappeared. Raup (1979b) used similar figures in an exercise employing taxonomic rarefaction to calculate that 96% of marine animal species disappeared. The record for the terrestrial biota is less precise, but there is recent evidence of severe disruption among land plants (Retallack 1995). Data for terrestrial animals are even less secure, but Benton (1985, 1989) measured a 49% extinction of vertebrate tetrapod families and Labandeira and Sepkoski (1993) document a two-thirds extinction among insect families, as discussed in 4.1.3.4.

A major problem in the understanding of this most severe of Phanerozoic crises is that it is not known over what duration these massive extinctions occurred. Several decades ago, when geological knowledge was less detailed, it was assumed that the extinctions were spread over several tens of millions of years (e.g. Newell 1967; Hussner 1983). Recent explorations of the fossil record, especially in China, have narrowed the time span. Some marine data indicate that the end-Permian mass extinction was very abrupt, occurring over less than 10 000 years (Xu 1991) and catastrophic, leading to an unprecedented fungal bloom in the oceans (Visscher and Brugman 1988). However, Jin *et al.* (1994) and Stanley and Yang (1994) have argued that this was not a singular event but rather that there were two mass extinctions during the Late Permian, the first approximately 5 Ma before the Triassic, eliminating large numbers of foraminifera, brachiopods and echinoderms, and the second nearer to the Triassic, eliminating perhaps 80% of remaining species. Their hypothesis needs further scrutiny.

Despite the virtually unimaginable magnitude of the end-Permian events, the causes remain uncertain. Explanatory hypotheses have ranged from lowering of sea level (and reduction of habitat space; Newell 1967, T.J.M. Schopf 1974), to climatic change and reduction of endemism (Valentine 1971), widespread oceanic anoxia (Wignall and Hallam 1992), and supernova explosion (Schindewolf 1963). Erwin (1993) provides a detailed review of these hypotheses as well as geological evidence for environmental changes that were occurring near the end of the Permian. Of particular interest are major shifts in ratios of stable isotopes of carbon and oxygen in marine sediments (e.g. Baud *et al.* 1989), which suggest severe alterations of ecosystem functioning; the interpretation of causes, however, remains controversial.

Four other mass extinctions eliminated 15% or more of marine animal families (Figures 4.1-3 and 4.1-5) and there were perhaps another 15 lesser events of extinction (Sepkoski 1992a). The best-studied of the major mass extinctions is the most recent, at the end of the Cretaceous about 65 Ma ago. This event is best known for the extinction of dinosaurs and other Mesozoic 'reptilian' groups, such as the aerial pterosaurs and oceanic mosasaurs. Among marine invertebrates, ammonite cephalopods and reef-building rudistid bivalves became extinct, as did nearly all planktonic foraminifera.

Special attention has been directed to this event ever since L.W. Alvarez *et al.* (1980) proposed the controversial hypothesis that the extinctions were caused by the impact of a 10 km asteroid and the ensuing blanketing of the Earth by an opaque dust cloud that shut down primary productivity and caused herbivores, carnivores and suspension feeders to starve. This hypothesis was inferred from the discovery of positive iridium anomalies in a thin

clay layer at the Cretaceous–Tertiary ('K/T') boundary. Iridium is extremely rare in the Earth's crustal rocks as a result of geochemical differentiation, but is several orders of magnitude more concentrated in undifferentiated meteorites, especially chondrites (see W. Alvarez *et al.* 1982). Subsequent evidence for a major impact includes discovery of iridium anomalies in terrestrial as well as marine K/T layers (Orth *et al.* 1981); measurement of osmium isotope ratios characteristic of non-terrestrial small bodies; analyses of quartz grains in the clay layer, which show multiple shock lamellae characteristic of impact sites (Bohor *et al.* 1984); discovery of microspherules, interpreted as splash droplets of molten rock blasted from the impact sites (Montanari *et al.* 1983); and identification of K/T sandstone beds at various sites around the Gulf of Mexico and Caribbean that can be interpreted as tsunami deposits (e.g. Bourgeois *et al.* 1988). Finally, a subsurface, circular structure, 150–300 km in diameter, has been identified in Yucatán, Mexico, which can be interpreted as the K/T impact crater (Hildebrand *et al.* 1991; Sharpton *et al.* 1992).

This evidence is certainly not without controversy. A number of workers have interpreted the data as equally indicative of widespread explosive volcanism at K/T times (e.g. Officer and Drake 1983; Hallam 1987). Such volcanism could also have severely perturbed the biotic environment through climate change caused by the injection of sulphates and aerosols into the upper atmosphere. Glen (1994) provides a scholarly account of this highly charged issue.

The Alvarez hypothesis has been especially controversial among palaeontologists because fossils do not show the predicted catastrophic disappearance exactly at the K/T boundary. Some extirpated clades, such as the ammonites, display dwindling of biodiversity over tens of millions of years through the Late Cretaceous (e.g. Teichert 1986), whereas other groups perished more rapidly near the end of the Cretaceous but still exhibit graded extinction (e.g. Keller 1989). There have been three basic explanations for this empirical pattern. (1) The pattern is real, indicating that the K/T mass extinction must have been protracted over hundreds of thousands to millions of years, induced by accumulated climate change and not by catastrophic asteroid impact. Recoveries of Cretaceous species in earliest Tertiary sediments (e.g. N. MacLeod and Keller 1994) are used to reinforce this argument, as has the apparent selectivity of the extinctions (i.e. nearly whole-scale survival of some clades and complete disappearance of others). (2) The pattern is real but actually segregated into pulses of extinction ('stepwise extinction'; see Hut *et al.* 1987; Kauffman 1988). This hypothesis is bolstered by very good evidence that the widespread inoceramid bivalves and, perhaps, the reef-building rudistid bivalves became extinct approximately one half million years before

the end of the Cretaceous (Johnson and Kauffman 1990; K.G. MacLeod and Orr 1993). (3) The pattern is an artefact of fossil preservation and palaeontological collecting, so that the fossil patterns do not in fact contradict a catastrophic K/T event. Signor and Lipps (1982) demonstrated that incomplete preservation and sampling of the fossil record means that the last sampled specimen of a species will usually be older than the time of actual extinction. This will push observed extinctions downward from any catastrophic event horizon, making it appear gradual (or stepwise if sampling is uneven) if data are interpreted at face value. More recently, Springer (1990) used the techniques of Strauss and Sadler (1989) to test a case of putative gradual extinction toward the K/T boundary and found it lacking merit: the density of sampling was not sufficient to distinguish between protracted extinction in the latest Cretaceous and abrupt extinction at the K/T boundary (see 4.1.2.2).

These three points of view continue to be debated among palaeontologists, not only for the K/T mass extinction but also for the older events for which there are less perfect data: the end-Ordovician (439 Ma), Late Devonian (367 Ma) and end-Triassic (208 Ma). All of these are of approximately the same magnitude as the K/T event, but none has yielded strong evidence of extraterrestrial impact. The more numerous smaller extinction events of the Phanerozoic have attracted yet less scientific attention, and hypotheses offered for their causes are commensurately more poorly tested.

4.1.4.3 Recoveries from mass extinctions

Although few conclusions have yet been drawn about the causes of ancient mass extinction, one generalization can be made about the subsequent biotic response: global diversity in most settings recovers quickly on geological time scales (which, unfortunately, are long by human time spans). A possible exception to rapid recovery is marine reef communities (Cooper 1988; Kauffman and Fagerstrom 1993). Figure 4.1-1 shows that the five big mass extinctions of Phanerozoic marine animals were all followed by rapid rediversifications. After the end-Ordovician and Late Devonian events, marine diversity rebounded to previous levels of taxonomic richness; after the end-Triassic and end-Cretaceous events, marine taxonomic diversity rebounded to the general trend of increase established after the end-Permian. Interestingly, rates of rebound appear quite similar to rates of radiation early in the Phanerozoic. For example, the Silurian recovery from the end-Ordovician mass extinction occurred at about the same rate of diversification as the preceding Ordovician radiation of the Palaeozoic evolutionary fauna (Figure 4.1-1).

At finer scales of resolution, recoveries in the fossil record are more complicated. The best-documented

sequence of biotic events is that following the K/T boundary; the more poorly known sequences after older mass extinctions seem to be largely consistent in general pattern (Jablonski 1991; Sepkoski 1992a). The K/T recovery begins with nearly monospecific blooms of species. In the plankton this involves a surviving foraminifer from the epicontinental seas and continental margins, which has been interpreted as 'weedy' (D'Hondt and Keller 1991); in the benthos, it involves several surviving species of deposit-feeding bivalves that form very widespread, low-diversity communities in the earliest Tertiary of North America (Hansen *et al.* 1993). Both planktonic and benthic species then undergo 'boom-and-bust' cycles, with one or several 'opportunistic' species being very common for a short interval, only to be replaced by another widespread, low-diversity community (Kauffman and Erwin 1995). The cycles have durations of tens of thousands of years. Only after several such cycles does the evolutionary system settle down to more steady diversification and differentiation of biotic communities, often accompanied by the reappearance of 'Lazarus' taxa (Kauffman and Erwin 1995). Again, the time scales are short by geological standards but immense in relation to human experience.

4.1.5 Late Cenozoic biodiversity

The fossil diversity of the late Cenozoic, and especially of the Holocene (0–10 000 years), is the best-documented in all of life's history (see 4.1.2.2). The basic reasons for this are: (1) the taxonomy and phylogenetic relationships among species are best known by comparisons and phyletic connections to living organisms, which have far better known anatomy, behaviour, and geographic distributions; (2) the younger geological deposits holding fossils are not so eroded as the older fossil record, providing far greater sampling coverage of habitats and biogeographic provinces; and (3) there are many more means to date young fossils, ranging from short-lived radioisotopes (e.g. C-14, U-Th), to orbitally-induced Milankovitch cycles in stable isotopes and sediments, to much more precise biostratigraphies within ocean basins and on continental platforms. Thus, more has been determined about short-term biotic response to climate change, tectonic evolution and organic evolution.

4.1.5.1 Global diversity over the last 15 million years

There is accumulating evidence that global diversity today is lower than the levels attained 5 to 15 My ago. For the marine system, the most recent taxonomic data on animal families exhibit small reductions in the Pleistocene relative to the preceding Pliocene and Late Miocene (Sepkoski 1993; Benton 1995). Since higher taxa mute fluctuations in diversity of species and genera (Raup 1979b), the reductions at the latter levels were probably higher. These

reductions may reflect extinctions among temperate marine animals during the Pliocene and, perhaps, Middle Miocene. These extinctions are best documented for Pliocene bivalves and gastropods in the North Atlantic Ocean, North Sea and Mediterranean Sea, where indeed they may have been most severe (Stanley 1986; Vermeij 1989). These authors argue that the cause was probably decreasing temperature and increasing climatic gradient around the time of onset of northern glaciation, which particularly reduced habitable latitudinal ranges of north-temperate marine species. Since that incident there have been migrations of northern marine animals between the Pacific and Atlantic Oceans (see 4.1.5.3), but little rediversification of the fauna (Vermeij 1991a, b).

Among terrestrial animals, there also appears to have been a reduction in taxonomic diversity since the Miocene (Janis 1993). The best data are for large mammals of North America, where diversity seems to have been at a maximum about 15 Ma ago in the Middle Miocene (S.D. Webb 1989; Van Valkenburgh and Janis 1993; but see Stucky 1990). After that time, there were pulses of extinction in the early Late Miocene, end-Miocene and end-Pleistocene that reduced North American large mammal diversity from at least 120 species to 25 today (Van Valkenburgh and Janis 1993). This reduction occurred despite the arrival of various immigrant taxa from Asia and South America. It has been hypothesized that this reduction in biodiversity was caused by habitat change induced by general cooling: Miocene woodlands and open woodlands became largely replaced by savannah-like grasslands and eventually by steppe and desert habitats (Janis and Damuth 1990; S.D. Webb 1989; Janis 1993), with concomitant reduction in the diversity of mammalian woodland browsers. There was some diversification of smaller, more arid-adapted mammals (Van Valkenburgh and Janis 1993), but this was insufficient to reverse the general decline in mammalian diversity (S.D. Webb 1989).

4.1.5.2 End-Pleistocene extinctions

The most dramatic events in the reduction of late Cenozoic land animal diversity were the end-Pleistocene extinctions within and at the end of the last cycle of northern glaciation. In North America, where this event is best documented (Martin and Klein 1984a), the extinctions appear to be concentrated in the interval from 9000 to 18 000 years BP (Mead and Meltzer 1984). Some 43 genera of mammals became extinct, 91% of which were large (>5 kg; Barnosky 1989). This radically changed the faunal landscape from a biodiversity somewhat analogous to present-day Africa to the impoverished fauna of modern North America. Extinction struck the South American mammal fauna at approximately the same time (Marshall *et al.* 1982), eliminating 46 genera, mostly large (Barnosky 1989). In Eurasia, the extinctions may have been more protracted but

similarly eliminated most of the larger mammals (although dwarfed mammoths evidently survived on Arctic islands north of Siberia until 4000 years BP; Vartanyan *et al.* 1993). Extinctions struck Australia somewhat earlier, around 40 000 years BP (Martin and Klein 1984), and eliminated 21 mammalian genera, again mostly large (Barnosky 1989). Africa alone seems to have suffered only normal, background extinction, and it retains a comparatively diverse fauna of large mammals in savannah and forest habitats.

Despite the recency of this event, the cause(s) remain controversial. There are two hypotheses in contention: either human predation drove the animals to extinction (e.g. Martin 1984) or rapid climatic change at the end of the last glaciation caused the extinctions (e.g. Graham and Lundelius 1984). The human predation (or 'overkill') hypothesis finds support from (1) extinctions in Australia and the Americas, which are not contemporaneous but coincide with colonization by humans (see Martin and Klein 1984); and (2) archaeological sites, which demonstrate that the extinct large mammals were being hunted (e.g. Fisher 1984). In support of the climate change hypothesis, (1) earlier Cenozoic episodes of extinction were associated with climate change; (2) some animals that became extinct were actually rather small and unlikely to be affected by human predation (Graham 1986a, b); and (3) vast changes in the composition and structure of terrestrial communities were occurring with the retreat of glaciers at the end of the Pleistocene (see 4.1.5.3), which could have stressed animal populations. The problem with the last argument, however, is that similar community-level reorganizations must have occurred repeatedly during the past million years with the cyclic waxing and waning of glaciers, but no massive extinctions are evident; furthermore, similar community changes in the oceans at the end of the Pleistocene induced no extinctions (Vermeij 1991a, b). It is possible, however, that human predation was a co-factor with community-level stress during the last glacial retreat in inducing the extinctions, at least in the Americas.

4.1.5.3 Biotic invasions

Biotic invasions, or interminglings of species from different biogeographic provinces, has probably been occurring episodically throughout the Phanerozoic (Vermeij 1991b). However, with good sampling, dating and taxonomy, these can be documented most accurately over the last several million years in the fossil record. Perhaps the best known case of invasion is the 'Great American Interchange' of terrestrial mammals. Approximately 2.5 Ma ago, the Panamanian Isthmus formed, and land animals of South and North America began to disperse freely between the two continents (Marshall *et al.* 1982). The result was a huge change in the South American mammalian fauna, with extinction of many endemic species and addition of

many species of North American descent, but comparatively little change in the North American fauna.

Older overviews of this event argued that North American invaders actively displaced many southern mammals because of competitive superiority (e.g. Simpson 1950). More recent analyses have questioned this argument (e.g. Marshall *et al.* 1982; S.D. Webb 1991; Vrba 1992). Two patterns have been noted in the fossil record: (1) the documented number of genera that actually crossed the Panamanian landbridge is proportionally equal for each fauna, with the same percentage of South American mammals moving north as North American genera dispersing south (although the North American fauna was more diverse at the time) (however, S.D. Webb (1991), on the basis of cladistic arguments, suggests that a greater percentage of North American genera may have actually dispersed southward); and (2) the great accumulation of 'immigrant' taxa in South America was actually the result of radiation of new taxa of North American descent within that continent, whereas South American immigrants to the north did not diversify (Marshall *et al.* 1982). S.D. Webb (1991) and Vrba (1992) hypothesize that the radiation of North American descendants was permitted by prior extinction of South American endemics resulting from habitat change related to late Cenozoic cooling. The final extinction of many South American endemics appears related not to competition but to the end-Pleistocene extinctions which equally affected the descendants of North American immigrants (Marshall *et al.* 1982).

Invasions contemporaneous with the Great American Interchange have also been documented in the marine realm. Vermeij (1991a), in particular, has documented an impressive invasion of northern Pacific molluscan taxa into the Arctic Ocean and boreal to temperate regions of the North Atlantic Ocean following tectonic subsidence of the Bering Strait. Interestingly, this invasion followed (and did not coincide with) the Pliocene extinction of Atlantic temperate molluscs (see 4.1.5.1). Indeed, the northwestern Atlantic, which suffered the greatest extinction, received the largest proportion of invading species (Vermeij 1991a).

4.1.5.4 Holocene community disequilibrium

Biotic adjustments during the period from the Holocene to the end of the last glacial cycle were traditionally assumed to involve simple northward migration of intact communities as temperate and boreal latitudes warmed. Work over the last two decades on accurately dated tree pollen, beetle carcasses, small mammal bones, and marine foraminifera and molluscs has demonstrated this not to be true. The best-documented case is the response of trees in eastern North America over the last 18 000 years. Pollen records from long-standing lakes and bogs indicate that tree

species moved northward individually, rather than in highly integrated units (Davies 1986, 1989; T. Webb 1992). For example, the spruce-sedge association of the late glacial age broke up, and spruces are now associated with birches in modern forests (e.g. T. Webb 1992). Insect fossils illustrate similar changes in community structure and geographic distribution. Some beetles co-occurring in glacial lakes in Britain are now scattered across boreal Eurasia (Coope 1987, 1994). In North America, small mammals show similar patterns, although to a lesser degree (Graham 1986a, b, 1992). In the oceans, Buzas and Culver (1994) have demonstrated that communities of planktic foraminifera break up and reassemble with glacial-interglacial cycles, and Valentine and Jablonski (1993) have shown that Pleistocene molluscs shifted their geographic ranges individually throughout these climatic cycles, sometimes assembling into communities with no modern counterparts (see also Bennett 1990; Jackson 1994).

This widespread evidence, in the best-resolved part of the fossil record, of change in community composition with climate indicates that species respond to their own requirements for temperature, seasonality, nutrients and so on (e.g. Gleason 1926), more so than to the changing distributions and abundances of organisms with which they interact. In fact, the entire history of late Cenozoic marine and terrestrial animals, as presently understood, suggests a dominant role of environmental change in governing biodiversity. Only the longest-term changes seem to be controlled largely by evolutionary innovation and fundamental changes in community structure.

4.1.6 Conclusions

The fossil record provides rich data on biodiversity through the history of life. Geological occurrences of taxa, combined with geographical data, phylogenetic patterns, and anatomical, behavioural and ecological information for living organisms, can provide important information about how organisms have evolved, what kinds of adaptations have afforded success, and what kinds of environmental changes have promoted or subtracted from local and global biodiversity.

Evidence from the most recent parts of the fossil record will be best for understanding how biodiversity responds to changing environmental and biotic conditions. This part of the fossil record is best resolved in terms of time, geography and identity of organisms, and it records immense climatic changes during glacial-interglacial cycles and resultant habitat constriction and alteration. However, late Cenozoic changes still need to be placed within a broader evolutionary context in order to identify any possible unexpected biotic changes and to measure rates of biotic response and recovery, even at time spans longer than human scales.

4.2 Processes of genetic diversification

4.2.1 Introduction

Genetic differences among individuals within a species provide the foundation for the diversity among species and ultimately among ecosystems. In this chapter, we will describe the basic population genetic processes governing genetic diversity, focusing particularly on the role of genetic diversity in determining the ecological and evolutionary potential of species. As in most areas of biology today, our current knowledge of basic processes in population genetics is far from complete but progress is being made rapidly. Genetic diversity within a species is important for understanding biodiversity for two reasons. First, the potential for a species to respond to novel environments and to disturbances caused by human activities depends on the extent of diversity and the kind of diversity that is present. Second, current patterns of genetic diversity are the result of past events and can sometimes provide important clues to the history of a species and details of its current population structure.

We will begin by discussing different ways of describing genetic diversity, then we will review the basic mechanisms of genetic evolution, and finally describe what is known about how these mechanisms determine the extent of genetic diversity in natural populations. In each area, we will be able to touch on only the major points and not present many details. The reader will find more information in one of the standard texts on population genetics (e.g. Hartl and Clark 1989) or quantitative genetics (e.g. Falconer 1981). We emphasize in advance that there is no single definition of genetic diversity that can be used for all purposes, nor can we identify a single goal for the maintenance or management of genetic diversity. We will emphasize that genetic diversity, however defined, is not necessarily at an equilibrium even in species apparently undisturbed by humans. Fluctuations induced by climatic and ecological changes play an important and, for some species, a dominant role.

4.2.2 Measures of genetic diversity

Individuals of virtually all species are genetically unique. Even with clonal or asexual reproduction, mutation usually prevents perfect duplication of genomes. The question of interest is how to define genetic diversity in a way that will help us relate genetic processes to the ecological and evolutionary processes that govern biodiversity. There is a continuum of possible ways to describe genetic diversity but it will be convenient to consider diversity at the levels of single genetic loci, of quantitative characters and of the genome as a whole. A guide to the variety of techniques used to characterize genetic diversity is presented in Section 2.2.

4.2.2.1 Measures for single loci

In the light of modern molecular biology, it is no longer simple to define a genetic locus. Each nucleotide is

governed by Mendel's laws and for some purposes a detailed description of DNA sequences from different individuals is necessary to characterize variation in a region of the genome. For many purposes, however, a single locus can be defined in classical terms as possessing alleles that are inherited in a Mendelian manner and that can be recognized either because they produce visible differences among individuals (visible polymorphisms), or because they produce proteins that can be distinguished by electrophoresis or other biochemical methods (biochemical polymorphisms). In some cases, such as the Alcohol dehydrogenase locus in *Drosophila melanogaster* and the beta-haemoglobin locus in humans, alleles that have been defined by classical Mendelian analysis are distinguished by a single change in the amino acid sequence of a protein. In other cases, such as in several of the histocompatibility (HLA) loci in humans, alleles usually differ at several amino acid sites (Hartl and Clark 1989).

Mendel's laws were developed to describe inheritance in diploid species (those species, including humans and most higher plants and animals, that carry two copies of each chromosome) but they have been extended to haploid species (including bacteria) and polyploid species (many fungi, plants and a few animals). For simplicity, we will concentrate on diploid species in this chapter, but with the knowledge that the same principles apply with some minor modifications to other species.

When alleles can be distinguished, a complete description of a population at that locus is a list of the numbers of individuals with different genotypes. From the list of genotype numbers, the first step is to obtain genotype and then allele frequencies. For many purposes these lists themselves are of interest and often warrant careful examination before any summary statistics are computed. Unfortunately, readily available computer programs for the analysis of population genetic data sometimes discourage and even prevent a direct examination of the data themselves. This opportunity to compute summary statistics, without examining the genotype and allele frequencies they are based on, should be resisted by workers in the field.

From the genotype and allele frequencies, it is possible to compute one of several summary statistics that reflect different aspects of the patterns in allele frequencies. One summary statistic is the proportion of loci at which more than one allele is detected, that is, the proportion of polymorphic loci. Using electrophoretic methods, the proportion of polymorphic loci in animals is found to be between 10% and 40%, with vertebrates typically having lower values than invertebrates and outcrossing plants (Nevo 1978). Another statistic is the proportion of loci in an individual that are heterozygous, meaning that at these loci the individual carries two different alleles. Typical average values of the heterozygosity in animals fall

between 4% and 15% and the heterozygosity in a species tends to be positively correlated with the degree of polymorphism (Nevo 1978; see Section 3.1.3). Typically, vertebrates are less heterozygous than are invertebrates. In plants, heterozygosities vary from less than 1% in selfing herbs to 1–20% in herbs with a mixed mating system to 10–20% for outcrossing trees (Brown and Schoen 1992; see Section 3.1.3).

In quoting these or similar summary statistics or in using them to compare different species, it is important to keep in mind that they describe only the sample of loci used in a particular study, usually fewer than 100 loci out of the tens of thousands that are thought to be important to higher organisms. We do not yet know whether the loci that can be examined using electrophoretic methods, which tend to be soluble proteins that are relatively abundant in adult organisms, are representative of the rest of the genome, which contains many loci that are active for only short times during development. In fact there is usually found to be little correlation between these measures of genetic diversity and the genetic variance of quantitative characters, as discussed below, suggesting that loci that can be surveyed with electrophoretic methods are not typical of loci that underlie adaptive evolution.

For diploid species, another type of summary statistic tells us whether the data represent a population that is randomly mating. The Hardy–Weinberg formula relates the allele frequencies to the genotype frequencies in a randomly mating population – genotypes are in proportion $p^2:2pq:q^2$, where p and q are the allele frequencies. The ‘inbreeding coefficient’ measures the difference between the Hardy–Weinberg expectation and the observed genotypic frequencies. The inbreeding coefficient for an allele is positive if there are more homozygotes than expected and negative if there are fewer. For some purposes, it is convenient to compute a single statistic, often denoted by F or by F_{IS} , as an average inbreeding coefficient at a locus or as an inbreeding coefficient averaged across loci. The inbreeding coefficient does not describe the extent of genetic diversity but provides important information about the kind of diversity that is present. Non-random mating, including the interbreeding of close relatives, self-fertilization, and various forms of clonal reproduction, all act to create positive inbreeding coefficients. Some kinds of selection and migration act to reduce inbreeding coefficients and can make them negative. The average level of inbreeding in a species is intimately related to the potential for ‘inbreeding depression’ caused by some kinds of interactions among alleles, a topic discussed later (Wright 1931, 1978).

4.2.2.2 Multiple populations

When more than one population of a species is examined, measures of variation among populations as well as within

populations are needed. Many measures of genetic similarity or genetic distance have been proposed. They can be used either to quantify the differences between each pair of populations or to quantify the overall extent of genetic differentiation in a set of populations (see, for example, Nei 1987). Although many different measures have been proposed, they fall into two broad categories, depending on whether the extent of differentiation depends on the role of genetic drift or on the role of mutation. The measure of genetic distance proposed by Cavalli-Sforza and Edwards (1967) is in the first category and the one proposed by Nei (1972) is in the second category.

In considering the overall level of differentiation among populations, Wright’s F_{ST} is by far the most commonly used measure and is a natural extension of his coefficient of inbreeding within populations (Wright 1978). The S indicates that a subpopulation is being compared with the total population, denoted by T . For a locus with two alleles, the F_{ST} is the variance in allele frequency normalized by the average frequency. In a group of populations, the overall inbreeding coefficient F_{IT} (the individual I compared to the total) can be attributed either to differences in allele frequency among populations (F_{ST}) or to deviations from Hardy–Weinberg genotype frequencies within each population (F_{IS}). The value of F_{ST} is necessarily between 0 and 1, with 0 indicating the same allele frequencies in each population and 1 indicating fixed allelic differences between populations. There is a rich statistical theory, reviewed by Weir (1990), for estimating these parameters. Similar statistics can be defined for hierarchically structured populations, for example, populations grouped into neighbourhoods. Estimates of F_{ST} for natural populations vary widely, with some species (many birds, for example) exhibiting very little differentiation (low F_{ST} values) even over very large geographical areas, while other species (many salamander species) are highly differentiated (high F_{ST} values) even among nearby populations (Slatkin 1985).

All of the methods for describing variation at single loci can be applied directly to DNA sequence data, by treating each site as if it were a locus (Nei 1987). Levels of variation per nucleotide site found so far, primarily in *Drosophila*, are low, with the heterozygosities in the order of 0.1% and percentages of polymorphic sites in the order of 1%, although at the present time too few other species have been sampled to know whether these values are typical. Electrophoretically detectable variation in *Drosophila* species tends to be higher than in many other species so it would not be surprising if the same thing were true for variation at the DNA sequence level as well.

Levels of DNA sequence variation in mitochondrial DNA (mtDNA) have been studied extensively and been found to be much greater than for nuclear DNA in the same species because of the apparently higher mutation rate in

mtDNA. Most variation within species in mtDNA sequences makes no difference in amino acid sequence and hence makes no difference to the organism, but differences in sequence can be used to infer some features of the history of a species and as genetic markers that can distinguish subspecies and local populations. For that reason, they can be extremely useful in many applications (Awise 1993). There is no recombination in mtDNA in higher animals and there appears to be strictly maternal inheritance or nearly so, and hence the entire mitochondrial genome can be regarded as a single locus in a haploid organism.

4.2.2.3 Multiple loci

When two or more loci are considered together, one question of interest is whether the presence of an allele at one locus is, in a statistical sense, independent of the allelic or genotypic state of other loci. The most commonly used measure is the coefficient of 'linkage disequilibrium', defined as the difference between the frequency of a gamete and the frequency of that gamete under the assumption of independence (Weir 1990). Like the inbreeding coefficient, linkage disequilibrium is not itself a measure of the genetic diversity but an indication of the kind of diversity that is present, which in turn can provide important information about the principal forces affecting genetic diversity. For example, if high levels of linkage disequilibrium are found in a species, as is the case in some bacterial species, then in effect very few gametic types are present, suggesting that essentially independent clonally reproducing strains have been mixed in the same sample, while low levels of linkage disequilibrium imply frequent exchange among different strains (Maynard Smith *et al.* 1993).

4.2.2.4 Quantitative characters

A quantitative character is any measurable characteristic of the phenotype, but typically the term is used for characters that are affected by numerous loci of sufficiently small effect that it is either not useful or not possible to analyse them at the level of individual allele or genotype frequencies (Falconer 1981). A quantitative character may be a morphological character such as body or limb length, a physiological character such as respiration rate or metabolic efficiency, or a behavioural character such as running speed or learning ability. The classical methods of the analysis of variance were developed partly to analyse quantitative characters, and it is still useful to begin with a description in terms of phenotypic means, variances and co-variances of characters. Such studies of variation within a species form the basis for classical natural history and biogeography.

If breeding studies can be performed, it is possible to infer something about the genetic basis of quantitative characters, including genetic variances, co-variances and the extent of interactions between the genotype and the

phenotype. Although the application of these statistical methods is straightforward, it is still difficult to draw strong inferences about the relationship between variability at the genetic and phenotypic levels. There does not appear to be a correlation between levels of genetic variation in a species measured by the single gene measures described earlier and levels of genetic variance affecting quantitative characters (Hartl and Clark 1989). In some cases, characters exhibit roughly the same degree of variation in different species. For example, Yablakov (1974) found in a survey of mammals that skeletal characters typically had coefficients of variation of about 5% while physiological characters had coefficients of variation of about 15%.

An important measure of the genetic diversity affecting a quantitative character is the heritability (often denoted by h^2), which is the ratio of the additive genetic variance to the total phenotypic variance. Heritability provides a measure of the rate of response to selection on a quantitative character and thus provides an indication of the potential evolutionary response of a character to environmental changes (Falconer 1981). In a similar way, the additive genetic correlation between two characters provides a measure of the evolutionary interdependence of two characters, as discussed later.

4.2.2.5 Genomic variation

In some species there is abundant variation at the level of the entire genome. There may be variation in chromosome number, in the presence or absence of a wide variety of chromosomal rearrangements, in the presence or absence of auxiliary chromosomes and, in bacteria, the presence or absence of plasmids (White 1978). Differences in chromosome number or chromosomal rearrangements often lead to at least partial reproductive isolation (the inability to hybridize freely) and hence most of the variation of this type is found between rather than within populations. Variation in karyotype (the number and shape of chromosomes) is difficult to detect without careful analysis and is not necessarily associated with variation in obvious phenotypic differences. Differences leading to even partial reproductive isolation can be important for the management of populations, because of the consequences of inadvertently mixing karyotypes that lead to reproductive isolation in the same population (see Section 2.2.1).

4.2.3 Processes governing genetic evolution

We will describe separately the different processes that govern the evolution of allele frequencies and the distributions of quantitative characters, but it will be important to keep in mind the fact that all of these processes are acting at the same time. Their interactions are discussed in the next section, but it should be noted here that there are cases in which one or two of these processes dominate and the others can be ignored.

4.2.3.1 Mutation

A mutation is defined broadly as any change in a genome, from a change in a single nucleotide to a modification of the karyotype. The mutation process is still poorly understood, even though it is well established that some kinds of environmental stresses, such as X-rays, increase the mutation rate, possibly dramatically. There is general agreement that the kinds of mutations that occur (as opposed to the rate at which they occur) are independent of the environmental conditions experienced. The possibility of some directed mutations in bacteria is controversial, but even the proponents of that hypothesis say that there is no reason to extrapolate their results to eukaryotes, in which gamete formation is much more isolated from environmental influences (Lenski and Mittler 1993). In general, mutations do not arise to fill an environmentally imposed need. Mutation is ultimately the source of all genetic variation, but it is an unpredictable and so far uncontrollable source.

Changes, insertions and deletions of individual nucleotides occur at a very low rate which appears to be roughly the same in different parts of the genome and in different eukaryote species, approximately 4×10^{-9} per base pair per generation (Kimura 1983). This rate is very low but still high enough to ensure that, with genomes with sizes in the order of billions of base pairs, each individual carries several new mutants. Classical experiments in *Drosophila* genetics have estimated mutation rates to electrophoretically distinguishable alleles to be in the order of 10^{-5} per locus per generation at most (Hartl and Clark 1989).

These very low rates of mutation might suggest that mutation has very little effect on allele frequencies in each generation. Mutation provides new alleles, whose frequencies are then governed by other forces. For quantitative characters, however, mutation can be important for increasing the level of genetic variation. Several studies show that roughly 0.1% of the genetic variance of a quantitative character is introduced by mutation in each generation, presumably because those characters are affected by numerous loci each of which experiences mutations. In tens or hundreds of generations, it is possible for mutation to re-establish significant heritabilities in a species that has lost all variation because of an extreme reduction in population size (Hill and Caballero 1992).

There are some genetic loci that have relatively high mutation rates. As a result, these loci, often called VNTR (for 'variable numbers of tandem repeats'), are often quite variable and hence are quite sensitive indicators of population genetic processes (see also Section 2.2.1.2). VNTR loci have alleles that are distinguished by the numbers of repeated sequences of DNA. In some such loci, called microsatellites, the repeated motif contains only a few base pairs, while in others, called minisatellites, the

repeated motif contains 30 or more base pairs. Microsatellite loci are extremely abundant in the human and mouse genomes, which have been the most closely examined, and the genotypes are relatively easy to assess (Valdes *et al.* 1993). Heterozygosities at many VNTR loci are typically 70% or more. As a result they have become the mainstay of efforts to map the human and other genomes. Minisatellites have been used extensively in forensic studies attempting to define genetic fingerprints of individuals. Mutation rates at microsatellite loci are as high as 1/100 per generation (Weber and Wong 1993). The processes of mutation at VNTR loci seem to be different from those at other loci and to depend on errors in DNA replication caused by the presence of repeated sequences (Jeffreys *et al.* 1991). A vast majority of these loci apparently have no phenotypic effects, although a few microsatellite loci have been implicated in human genetic diseases (Kunke 1993).

A quite different class of mutations occur because of the insertion of transposable elements, which are relatively small segments of DNA (in the order of a few thousand base pairs) that can insert themselves at most and possibly all places in the genome (Berg and Howe 1989). The insertion of a transposable element in a coding sequence can result in a drastic change in the gene product or the complete elimination of the product. Transposable elements have been found in all species that have been examined, including bacteria. Transposable elements transpose at apparently relatively low rates under most conditions (in the order of 10^{-5} per generation), but in two cases in *Drosophila melanogaster*, transposition rates are much higher under some conditions (the phenomenon of 'hybrid dysgenesis') (Engels 1983). Under those conditions, transposition results in measurably higher rates of accumulation of additive genetic variance of quantitative characters in addition to a rich abundance of deleterious, lethal mutants and chromosomal rearrangements. Such cases have not been found in other species but there seems in principle no reason why they could not occur. Mutations generated by such cases could become an important and powerful force for generating genetic diversity (Mackay 1985).

Rates of appearance of chromosomal rearrangements are low but occur frequently enough to be estimated reliably. Spontaneous mutation rates of chromosomal rearrangements, such as reciprocal translocations, centromeric fusions or inversions, are of the order of 10^{-4} to 10^{-3} per gamete and generation in taxa as different as grasshoppers, fruit flies, mice and humans (Lande 1979).

4.2.3.2 Genetic drift

Genetic drift is a process of change in allele frequencies caused by the unpredictable consequences of Mendelian inheritance. Even though alleles at a locus in a diploid

species appear in gametes with equal probability (which is equivalent to Mendel's first law), a particular gamete contains one allele or the other. As a consequence, allele frequencies can change from generation to generation because only a sample of gametes will be represented in each generation. Population size is the most important determinant of genetic drift, with small populations being much more strongly affected than large ones. There is currently great concern about the small sizes of many natural populations. Small size leads to higher risk of extinction through demographic effects and also poses genetic problems. Heritabilities can be reduced because of the loss of alleles and the genetic correlations among characters can be altered because only a few pleiotropic alleles, alleles that affect two or more phenotypic characters, might remain. Both effects would tend to restrict the response to new environmental conditions which might well accompany a reduction in population size. Furthermore, small population sizes may lead to increased homozygosity and consequently inbreeding depression.

Genetic drift depends on a variety of factors, whose net effect can be summarized by a single quantity, the 'effective population size' (Wright 1938). The effective size is generally less than the total number of individuals present, the 'census size'. The effective size depends on the breeding system, the age structure, the sex-ratio and other factors. For most species, only a fraction of the individuals present are actually involved in reproduction; individuals may be sexually immature, unable to compete for mates or simply be unlucky and not find a mate. Individuals that do find a mate may leave no offspring anyway because of high juvenile mortality. The effective population size, N_e , corresponds to the size of an ideal randomly mating population which would offer the same opportunity for genetic drift as the real population.

The effective population size may in fact be much less than the census size. For example, in a population that is changing in size from generation to generation, the effective size is the harmonic mean of the population sizes, that is $1/N_e$ is the average of $1/N$. In general, the harmonic mean depends most strongly on the smaller population sizes. If there are N_m males and N_f females in the population, the effective population size will be equal to $4N_mN_f/(N_m + N_f)$. For example, a population consisting of one male and 100 females will have an effective size of roughly 4. In an age-structured population, in which individuals of different ages are present at the same time, the effective size depends in a complex way on the birth and death rates for each age class, but the effective size is always smaller than the census size (Hill 1972). For humans, for example, the effective size is approximately one-third of the census size (Charlesworth 1980). If there is extensive clonal reproduction as well as overlapping

generations, the effective size can be quite small. Orive (1993) has shown that the effective sizes of two species of corals are only about 3% of the census size.

In general, genetic drift reduces genetic diversity in a population at a rate determined by the effective population size. If H is the proportion of heterozygous loci in a randomly mating population, then H is reduced by a factor of $[1 - 1/(2N_e)]$ each generation by genetic drift (Crow and Kimura 1970). The additive component of the genetic variance of a quantitative character is reduced by the same fraction. Even when N_e is relatively large, there can be a substantial reduction in heterozygosity on a time scale of N_e generations (Figure 4.2-1). In a population reduced to a very small number of individuals, heterozygosity can be lost almost completely, as has apparently happened with cheetahs (*Acinonyx jubatus*), in which only 2 of 49 loci were found to be polymorphic, many of which are polymorphic in other mammals (O'Brien *et al.* 1983; but see May 1995). The 'founder effect', in which genetic variability is greatly reduced when a population is founded by a small number of individuals, is an example of genetic drift that may play an important role in the formation of species.

4.2.3.3 Natural and artificial selection

The diversification of species and their adaptation to environmental conditions are governed largely by natural selection, as first described by Darwin. Darwin's theory of natural selection was integrated with the Mendelian theory of inheritance in the early 1900s, leading to the neodarwinian or synthetic theory of evolution in which selection within species still plays the dominant role (Huxley 1942). More recently, Gould, Eldredge and other proponents of the punctuated equilibrium theory of evolution have emphasized that the synthetic theory alone does not account for general patterns observed in the fossil record or for large-scale patterns in species diversity, and that selection among species must also be considered (Stanley 1979).

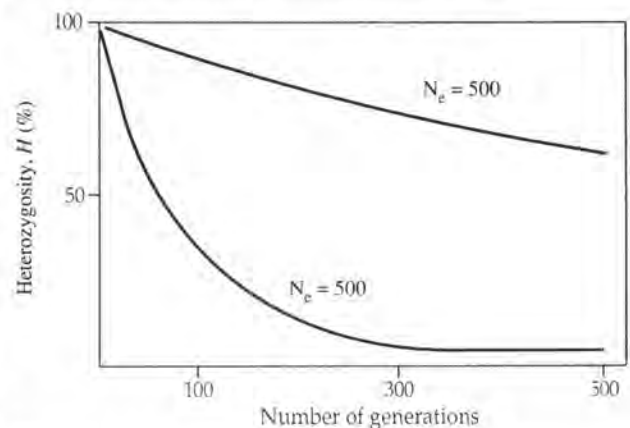

Figure 4.2-1: Loss of heterozygosity by genetic drift in two populations having effective population sizes of 50 and 500, respectively. Heterozygosity has been set at 100% in the starting generation.

Selection within a population occurs whenever inherited characteristics of individuals affect an individual's ability to survive and reproduce. We can distinguish natural selection, which is caused by naturally occurring environmental conditions affecting survival and reproduction (Darwin's 'struggle for existence'), from artificial selection, which is imposed by humans for altering and improving domesticated species. The same principles apply to both but there are several important differences between them. First, natural selection is typically relatively weak, with only small differences between individuals affecting their survival and reproduction, while artificial selection is almost always quite strong, with only a few of a large number of individuals being chosen as parents of the succeeding generation. There can be very strong episodes of natural selection caused by rapid changes in environmental conditions, including changes caused by humans, but that is not thought to be typical of most characters in most species (Endler 1986). Second, natural selection acts for the entire lifetimes of species, possibly millions of years, while artificial selection acts over a few and at most tens of generations. Finally, the way in which artificial selection is performed can be adjusted to ensure that continued progress will be made, because there is a definite goal and because progress can be monitored. In contrast, there is no goal under natural selection and environmental conditions may change in such a way that a population or species will go extinct, at least in one geographical area and possibly over the entire species range, rather than evolve in response. We will discuss later the importance of these differences.

4.2.3.3.1 Selection on phenotypic characters. Selection depends on differences among individuals in phenotypic characters, and depends on the genotypes only as far as phenotypic differences can be traced to differences in genotype. It is often useful to speak of a phenotype – a particular character or combination of characters – as conferring 'fitness' on an individual and then to predict the effects of selection under different conditions by computing differences in fitness among individuals. In using this terminology, we make some important assumptions that are often not stated explicitly. In saying that an individual with, for example, a body length of 6 cm is twice as fit as an individual with a body length of 8 cm, we are saying that, all else being equal, individuals of length 6 cm will have twice as many offspring as individuals of length 8 cm. The phrase, 'all else being equal', means in this case that we imagine a very large number of individuals in which their genomes are made up of random combinations of genes but subject to the constraint that they all are 6 cm long.

Selection can result in a change in the genetic and phenotypic composition of a species but it can also result in a change in numbers, sometimes a dramatic change that

results in a different ecological role. For example, a pest species without insecticide resistance may be rare and found only in microhabitats that provide refuges from the insecticide. But once resistance evolves, that pest could occupy a much larger range and have a significant effect on many other species. The history of pesticide application shows many examples of this phenomenon.

Consider a single character of measure x . There is 'directional selection' if individuals with larger (or smaller) values of x have higher fitness. If $w(x)$ is the relative fitness of an individual with phenotype x , then there is directional selection if $w(x)$ is an increasing (or decreasing) function of x (Figure 4.2-2). Virtually all artificial selection is based on performing directional selection on one or more characters. There is abundant evidence for directional selection occurring in natural populations as well (Endler 1986). An alternative to directional selection is 'stabilizing selection' in which extreme values of a character have a lower fitness and an intermediate value, the optimum value, has the highest fitness. Stabilizing selection is performed on domesticated species to maintain the ideal types of varieties or species. There is some evidence for stabilizing selection in natural populations as well, but at present it is not possible to know the relative importance of stabilizing and directional selection in nature. 'Disruptive selection', in which extreme values of the character have the highest fitness, is also found in nature but is thought to be less common. Disruptive selection is probably not practised intentionally on a single population of a domesticated species because directional selection in different directions on isolated populations would be much more effective.

4.2.3.3.2 Selection on individual loci. The relationship between selection practised on phenotypic characters and selection that is affecting allele and genotype frequencies is far from clear. Much of the existing theory depends on assumptions that cannot currently be tested in most cases but that are at least consistent with what is known about development and with extensive experimental studies in quantitative genetics. Nevertheless, we are aware that as more is understood about development, existing theory will have to be augmented or replaced by more realistic theory.

If each allele carries with it a 'dosage' that it contributes to a quantitative character, as illustrated in Figure 4.2-3, then the relative fitnesses of genotypes at a locus can easily be related to selection on the character. Directional selection on a character always favours one genotype and thus always acts to fix one allele and thus eliminate genetic variation at a locus. Intuition might suggest that stabilizing selection would tend to preserve variability at each locus affecting a character but that is not true in general. It is true that intermediate genotypes will have intermediate values of the character but well-established theory shows that in almost all cases stabilizing selection will result in the

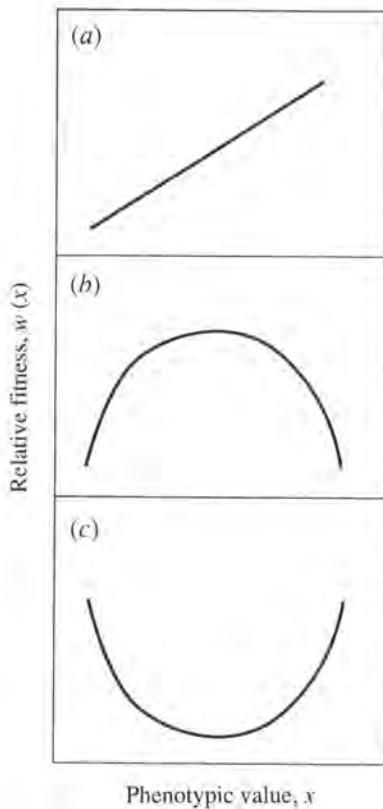

Figure 4.2-2: Fitness of individual phenotypes under (a) directional selection, (b) stabilizing selection, and (c) disruptive selection.

optimal phenotype being achieved by fixing different combinations of alleles at different loci rather than by preserving variability at each. It is also true, however, that stabilizing selection is much less efficient than directional selection in eliminating genetic variability (Lewontin 1964). Disruptive selection in natural populations results in the maintenance of genetic variation but usually at only one or two loci which ‘switch’ the phenotype from one extreme phenotype to another (Ford 1964).

It is also possible that genotypes of diploids are not neatly ordered in their effects on a character, as illustrated in Figure 4.2-3, a situation described as ‘overdominance’ of the alleles. In such cases, both directional selection and stabilizing selection can maintain genetic variation. One example of overdominance maintaining genetic variability is that of the allele of beta-haemoglobin causing sickle-cell anaemia in some human groups in malarial regions in Africa. Individuals heterozygous for this allele are more resistant to malaria, so that the allele is maintained in relatively high frequency despite having very severe effects on individuals homozygous for the allele. It is not currently known how common this situation is, and there are very few other examples in which it can be demonstrated that selection alone is maintaining variation at a locus or set of loci. It is currently controversial as to whether overdominance is present at most or even many loci and hence whether selection alone generally acts to maintain or

eliminate genetic diversity. It is important to note that if overdominance is maintaining genetic diversity at a locus, allele frequencies will tend to be relatively high. For example, alleles causing sickle-cell anaemia are found at frequencies of 10% or more (Cavalli-Sforza and Bodmer 1971).

4.2.3.3.3 Spatial and temporal variation in selection. Spatial and temporal variation in conditions experienced by a population also affects selection. The effects of such variation depend on the scale of variation relative to the organism. Variation over very large distances can result in geographical clines in one or more phenotypic characters, something observed in many species that have large geographical ranges (Endler 1977). Changes that occur slowly can result in long-term trends that can be reversed if conditions change. Variation over smaller geographical scales can result in what is equivalent to disruptive selection, with some phenotypes being favoured in some parts of the range and others favoured in other parts. Directional selection may change direction, resulting in what is effectively stabilizing selection, a phenomenon that

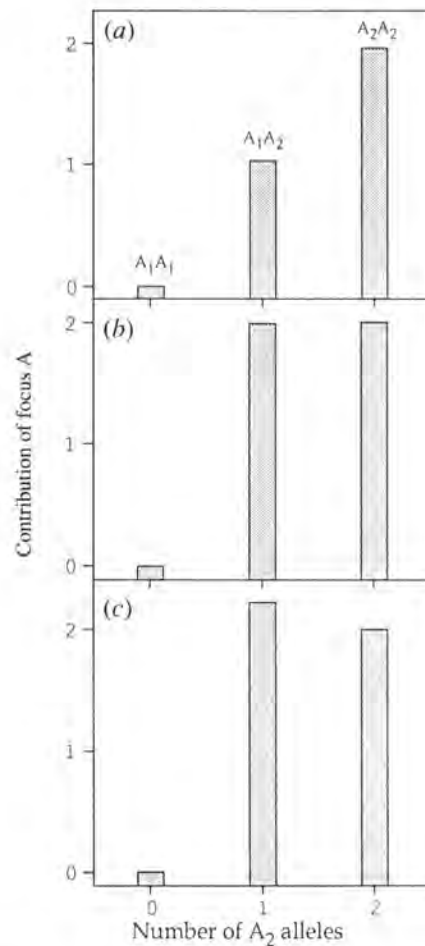

Figure 4.2-3: Contribution of one locus to a quantitative character. The genotypic values of three genotypes, A_1A_1 , A_1A_2 and A_2A_2 are compared under conditions of (a) co-dominance, (b) dominance of A_2 , and (c) overdominance.

has been demonstrated in some bird species. At the level of individual loci, spatial and temporal variation in selection usually result in the maintenance of more genetic variation than would be found in the absence of such fluctuations, and some authors, Gillespie (1991) in particular, have argued that fluctuations in selection play a dominant role in the maintenance of genetic variability.

4.2.3.3.4 Selection on multiple characters. Considering each character in isolation is a reasonable starting point but in reality an individual's survival and reproduction depend on several characters. In natural populations, it is currently impossible to know whether only a few characters strongly influence relative fitness or whether a large number of characters are important simultaneously. It is clear that combinations of characters are selected together because of their functional integration. For example, natural selection favours high running speed in many animals, either to make them more efficient predators or to make them more likely to escape predators. A wide variety of morphological and physiological characters contribute to running speed, including, in vertebrates, limb dimensions, the detailed structure of various muscles, and features of the respiratory and circulatory systems.

This example illustrates a common problem in discussing the evolution of quantitative characters: namely, what is a character? We can treat running speed as a single character, as has been done for centuries by breeders of racing animals, or we could treat all characters affecting running speed separately. At the genetic level this distinction is more apparent than real. With both ways of looking at the problem, the same loci will be involved in the response to selection on running speed and ultimately it is the variation at the genetic level that determines the potential response of running speed to selection. Selection on several characters at once will reduce genetic diversity in general unless there is extensive overdominance of the loci affecting those characters.

4.2.3.3.5 Response to selection. For a single quantitative character, the short-term response (R) to selection can be predicted from the heritability (h^2) of a character and the selection differential (S), which is the difference between the mean of the character in the selected parents and that of all potential parents: $R = h^2S$, which is called the 'breeders' equation'. This theory provides adequate if not perfect predictions over five to ten generations (Falconer 1981). On this very short time-scale, heritabilities do not tend to change by much. Over a longer time-scale, tens to hundreds of generations, the simple theory is no longer adequate especially when very strong directional selection is applied. The average value of a character often stops at a 'plateau' after which further response to selection does not occur. The location of this plateau differs from character to character and also depends on the strength of selection applied. Generally, weaker selection results in longer continued

response and ultimately a greater response, suggesting that mutations occurring during the selection experiment are permitting further response (Hill and Caballero 1992).

One important generalization can be made in spite of the lack of ability to predict the long-term response to artificial selection. In domesticated species and those studied in laboratories, virtually all characters that have been subject to directional selection respond sufficiently that their mean values lie outside the initial range of variation. The mean value of a character can almost always be changed by five or ten times the initial standard deviation (Falconer 1981), which implies that abundant variation is present at loci affecting virtually all quantitative characters. As a consequence there is the potential for rapid genetic response of natural populations to most kinds of selection. This generalization does not, however, imply that rapid evolution will occur in natural populations in response to all environmental changes. As we have emphasized, natural selection cannot generally target a particular character. A drastic change in environmental conditions may result in a demographic rather than an evolutionary response. A species could change the part of the habitat it uses by choosing microhabitats to which it is already adapted; it could change its geographical range, or it could simply go extinct. Polar bears, musk oxen and representatives of other classes of mammals have evolved adaptations to Arctic conditions, but there are no examples of similarly adapted perissodactyls (horses and their relatives) or of primates (other than humans). Which types of species can evolve adaptations in a particular situation is unpredictable and depends on both genetic and ecological factors that differ among species. Furthermore, the fact that a suite of adaptive characters has evolved once, does not mean that it will necessarily evolve a second time in a different lineage. Penguins evolved in the Antarctic but no birds have evolved a similar set of characteristics in the Arctic. Cacti evolved in New World deserts but not in the Old World. The success of introduced *Opuntia* in deserts throughout the world shows that their adaptations would be useful in the Old World deserts had they evolved there.

When two or more characters are considered together, the response to selection becomes more complicated. A genetic correlation between two characters implies that they are affected to some extent by the same pleiotropic loci. As a consequence, selection on one of the characters results in a response of the other. It is often useful to distinguish between the direct response of selection, which is the response to selection affecting that character, from the indirect or correlated response of other characters affected by pleiotropic loci. The correlated response to selection can provide a powerful constraint on evolution. It is often found, for example, that fertility and other characters directly affecting reproductive success decrease when strong selection is applied to other characters. In

some cases, the response to artificial selection is limited by the fertility of the selected lines (Falconer 1981). The correlated response can play a role in determining how a species will respond to environmental change. As Stebbins (1950) has emphasized, evolution seems to follow a 'path of least resistance', which means that the genetic changes that occur under different conditions will be those that are the easiest to achieve. The patterns of genetic correlations among characters are the main determinants of paths of least resistance. Unfortunately, genetic correlations among characters are difficult to estimate even for domesticated species and they can change in response to selection. Hence, it is nearly impossible to predict the path of least evolutionary resistance for a species subject to new conditions. The best guide is probably the response of similar species to similar changes.

4.2.3.4 Dispersal and gene flow

Species often occupy large geographic ranges, which creates the opportunity for genetic and phenotypic diversity within as well as between species. According to the theory of 'allopatric speciation' (Mayr 1963), geographic variation within a species provides the raw material for the formation of different species. Furthermore, patterns of geographic variation can provide important clues to the working of other population genetic processes. The movement of individuals from one location to another, the process of dispersal or gene flow, tends to homogenize populations and eliminate local differences.

The extent of gene flow can be radically altered by humans. It has for long been a common practice in forestry and fisheries deliberately to release organisms into areas inhabited by conspecific populations, and inadvertent releases caused by the recent world-wide acceleration in human transportation by road, air and sea may dramatically alter the frequency and distances over which long-distance dispersal occurs in other organisms (see Section 11). For example, many coastal marine taxa are now spreading world-wide in the ballast water of ships (Carlton and Geller 1993). Another example is the rapid spread of the amplified esterase B2 alleles which confer insecticide resistance to *Culex pipiens* (Raymond *et al.* 1991).

Gene flow can occur because of the movement of individuals between established populations or because of the establishment of entire populations. Some species, including most weeds and many parasitic species, have a structure that can be best described as a metapopulation (a population of populations – see Sections 4.3.1 and 4.4.2), in which each population is transient, but in which a collection of populations persists through continued extinctions and recolonizations (Olivieri *et al.* 1990). Under some circumstances, the recolonization process can be the dominant cause of gene flow (Wade and McCauley 1988; Gilpin 1991). Extinctions and recolonizations also effect

the heterozygosity of metapopulations. Without extinction, a subdivided population with little gene flow among subpopulations loses genetic variation at a slower rate than a panmictic population of the same total size, because different alleles tend to be fixed in different subpopulations. With extinctions and recolonizations, however, the metapopulation may lose genetic variation at an unexpectedly high rate (Gilpin 1991).

4.2.3.5 Recombination

Genetic loci are arranged on one or more chromosomes and hence sets of alleles tend to be inherited together. Recombination in eukaryotic organisms and various other methods for exchanging genetic material in prokaryotes (transformation, for example) rearrange alleles among chromosomes. Recombination does not itself create genetic diversity at each locus but it can create new combinations of alleles at different loci by mixing alleles from different individuals. Without recombination of any type each individual is genetically independent of all others and behaves effectively as a separate species.

Species differ enormously in the extent to which their genomes are affected by recombination. The mode of reproduction and the breeding system largely determine the opportunities for recombination. Outcrossing, as opposed to self-fertilization, makes recombination more important. Most higher animals (including all mammals and birds) cannot self-fertilize; nor can many plants: but many plants and some lower animals can. Self-fertilization is common in plants, and in some animal groups such as snails. It does not prevent recombination, but highly self-fertilizing species tend to be very homozygous and in that case recombination has little effect. There is no recombination when organisms reproduce asexually, either by direct budding of individuals or by the production of young from unfertilized eggs. Many species, such as aphids, have the capacity for long periods of asexual reproduction, punctuated by occasional episodes of sexual reproduction, thus ensuring that some genetic exchange among individuals will take place. Prokaryotes do not have sexual modes of reproduction but have a variety of methods for exchanging genetic material between individuals. There appear to be substantial differences among bacterial species in the extent of genetic exchange. For example, *E. coli* seems to be essentially clonal while *Salmonella* appears to be essentially randomly mating (Maynard Smith *et al.* 1993).

4.2.4 Maintenance of genetic diversity

As we have discussed, there is abundant genetic variability at all levels, from nucleotides to quantitative characters, in most species that have been studied. It is currently not known how the various population genetic forces together determine levels of genetic variation. This problem is of interest in its own right, but it is also of great importance

for our understanding of the relationship between genetic and species diversity, and between genetic diversity and the persistence of natural populations. The potential for adaptive responses to changes in environmental conditions depends on the genetic diversity present and how that diversity is maintained. Here, we will try to summarize what is known and make clear what remains to be learned.

Obviously mutation creates variability and genetic drift tends to remove it. For many parts of the genome, it appears that these two forces are sufficient to account for both standing levels of variation and rates of evolution. That is particularly true for the non-coding DNA, intron sequences, and silent DNA variations (i.e. those that do not change a codon and hence do not change the protein coded for). These observations, which form part of the foundation of the 'neutral theory' of molecular evolution (Kimura 1983), do not help us understand the maintenance of genetic variation that is the basis for adaptive evolution.

4.2.4.1 Mutation and selection

Selection that tends to decrease diversity will be opposed by mutation that tends to restore it. For individual loci, theoretical predictions are clear and simple. If μ is the mutation rate to an allele that reduces fitness by an amount s (i.e. the fitness is $1-s$ relative to an individual without the allele), then the equilibrium frequency of the deleterious allele will be approximately $(\mu/s)^{1/2}$ if the allele is recessive and approximately μ/s otherwise (Hartl and Clark 1989). The difference between alleles that are recessive and those that are not seems minor, but in fact for realistic parameter values there is a qualitative difference between the two cases. For example, if $\mu = 10^{-5}$ and $s = 0.9$, indicating that the allele causes a severe genetic condition, the equilibrium frequency if the allele is recessive is about 3/1000 and about 1/10 000 if it is not recessive. Thus selection is much less effective in removing recessive deleterious alleles than it is in removing those that are not recessive. This simple result explains why individuals of many species carry recessive deleterious alleles, a fact that has important consequences for inbreeding depression and outbreeding depression, discussed below.

The theory describing the balance between mutation and selection for quantitative characters is more difficult to understand and its empirical basis is much more controversial. Turelli and Barton (1989) review the literature in this area. There is extensive genetic variation for almost all quantitative characters and it is generally agreed that selection of some kind is important for many quantitative characters, but there are still important unanswered questions about what role selection plays. In particular, we do not know whether most variation in quantitative characters is attributable to a few loci, each of which has a significant effect, or to a large number of loci each of which has a smaller effect. In the first case, each

locus would be relatively strongly affected by selection on the character and in the second case each locus would be affected only slightly. At present, breeding studies suggest that quantitative characters are affected by several loci (four or more) but the methods do not have the resolving power to distinguish with confidence between five loci and 100, because too many untestable assumptions are needed to make such estimates (Lande 1981). New methods for finding loci with strong effects on quantitative characters (e.g. Lander and Botstein 1989) hold great promise to resolve this problem but at present their power depends on having a very detailed linkage map which is unavailable for most species.

It is clear that the short-term response to selection of most kinds is possible and not limited by lack of genetic variation of the right type. It does not appear to be necessary to wait for a mutation of the right type to occur before most species can respond to most types of selection. Over longer time-scales we know much less, and it may well be that certain kinds of change under selection do not occur because of the lack of mutations. We can illustrate the problem by considering the loss of bilateral symmetry. In laboratory studies of insects and vertebrates, mutations that produce a consistent difference between the right and left sides seem to be very rare. In *Drosophila*, for example, it was impossible to select for consistent difference in wing size (Maynard Smith 1956). (This is one of the rare cases in which response to strong artificial selection on a character – the difference in wing size on the right and left sides – was not obtained). It is clear, however, that bilateral symmetry has been lost in some fishes, such as sole. Presumably mutations breaking down bilateral symmetry were favoured in the ancestors of such species because asymmetric individuals were favoured by natural selection. There are no species of mammals with a comparable extent of asymmetry.

We do not know whether no such strongly asymmetric mammals have evolved because sufficient mutations of the right type have not occurred, or whether natural selection has never favoured such mutations because highly asymmetric mammals were always at a disadvantage. In the former case, we would say that evolution was limited by the lack of mutation, or that evolution was limited by a 'developmental' constraint. That is, the system of mammalian development does not permit the expression of mutants that drastically modify bilateral symmetry. If, on the other hand, such mutations can readily occur but, for unknown reasons, bilateral symmetry in mammals has always been favoured by natural selection, then evolution is not limited by mutation or by developmental constraints. At present, there is considerable controversy over the relative importance of developmental constraints and selection, especially in large-scale evolutionary transitions. Developmental constraints could also play an important

role in the capacity of a species to adapt to novel environmental conditions. Even if suitable mutations would ultimately occur and permit the response to selection created by new conditions, a species could go extinct before such mutations could occur.

4.2.4.2 Inbreeding depression and heterosis

When closely related individuals interbreed, their offspring are often less fit, and sometimes much less fit, than either of the parents. This is the phenomenon of inbreeding depression. Heterosis is the opposite: offspring of unrelated parents tend to be more fit than those of related parents. Both heterosis and inbreeding depression are explained by the same two genetic mechanisms: the presence of deleterious recessive alleles and of alleles that are overdominant (i.e. with higher heterozygote fitness). For both kinds of alleles, the increased homozygosity of inbred individuals would be expressed as lower fitness. Similarly, outbred individuals would tend to be heterozygous at more loci and hence exhibit heterosis. The relative importance of recessive and overdominant alleles in accounting for inbreeding depression is currently unknown and is very controversial. Many genetic studies show that individuals carry numerous recessive deleterious alleles while examples of overdominance are rare. Nevertheless, a few strongly selected overdominant alleles could far outweigh the effects of recessive alleles because each recessive deleterious allele would be expected to be in low frequency while overdominant alleles would tend to be maintained in relatively high frequency.

Inbreeding depression is potentially important for natural populations that have been substantially reduced in size, as is the case for many endangered species. If the average fitness is lowered because many individuals become inbred, the resulting inbreeding depression could further lower the reproductive capacity of the species and further reduce the population size, a phenomenon that has been described as 'genetic meltdown' (Lynch *et al.* 1993). Whether inbreeding depression is a potential problem for a species depends on its history and breeding system. Many species are commonly inbred because populations are typically founded by one or a few individuals – many parasitic populations are founded by a single fertilized female, implying that the next generation is produced exclusively by brother–sister matings – or because individuals are self-fertilizing. In such species, there may be little potential for inbreeding depression because individuals are already homozygous and deleterious recessive alleles would have been largely eliminated by selection (Shields 1982).

4.2.4.3 Selection opposed by gene flow

The study of geographic variation has a central position in evolutionary biology because differences among different

populations of a species often provide important clues to processes affecting those populations. Geographic differences among populations can result from genetic drift alone, as discussed above, but in many cases the level of variation in one or a few characteristics is much greater than for other characteristics, suggesting that local differences in selection are responsible. In fact, geographic variation in selection has been demonstrated in many studies of natural selection (Endler 1986).

Geographic differences caused by selection are particularly important for understanding biodiversity. Different populations of the same species may be adapted to rather different local conditions. In some cases, those differences are evident to humans: for example, populations of many species have colours or patterns adapted to substrates they typically occupy. In the classic studies of industrial melanism, for example, moths of several species have been shown to be adapted to trees that either are or are not blackened by soot from factories (Ford 1964). The agent of selection, predation by birds, has been shown to be sufficiently powerful to lead to the adaptation of moths to local conditions in a matter of tens of generations.

The selection leading to industrial melanism was obvious to human observers because we have roughly the same visual capacities as the predatory birds involved. In other cases, that is not necessarily true. There are local differences in the mineral content of soils but it is usually impossible to predict whether those differences lead to local adaptations or not. Numerous studies of the evolution of tolerance of plants to heavy metals in soils near mines (Ford 1964) show us that adaptation to local conditions can occur quickly in plants but it is not yet clear whether such examples are typical or just the consequence of the extremely strong selection created by human activities.

Selection pressures may vary on very different geographical scales, from global to local. Consider climate as an example. Differences in climate can cause large-scale differences in selection, such as those leading to the general trend towards larger body size of many organisms from the Equator to higher latitudes, a trend known as Bergmann's rule (Mayr 1963). On a much smaller scale, microclimatic differences between exposed and shaded localities may lead to genetic differences between local populations of organisms with limited dispersal capabilities. Thus, climatic selection can vary geographically in a large-scale, clinal fashion as well as in a small-scale, mosaic one. Both of these patterns may affect the same morphological trait, such as shell colouration of the snail *Cepaea* (Ford 1964). Physiological and behavioural traits can also respond to geographic variation, although much less is currently known about that area (Garland and Adolph 1991).

The potential for the establishment of local differences depends on the balance achieved between gene flow and selection. The theory for the balance between selection and

gene flow shows that there is a 'critical length scale' (l_c) below which selection cannot overcome gene flow. For a single locus with selection of intensity s against one genotype, $l_c = l/(s)^{1/2}$, and for a quantitative character in which the strength of stabilizing selection is w , $l_c = l/(w)^{1/2}$ (Slatkin 1985), where l is roughly the average distance between the place of birth of an individual and where it mates. If selection varies on a scale less than l_c , the allele or phenotype frequencies will not respond and the population will be unable to adapt to those conditions, while adaptation will be possible to variation on a geographical scale greater than l_c , as illustrated in Figure 4.2-4.

Hybrid zones between species or subspecies present a somewhat different situation because individuals on the two sides of the zone often differ in numerous characters and because there is generally selection acting against hybrid individuals. The theory of hybrid zones shows that such conditions often lead to very steep gradients in several characters in the same location even if that location does not correspond to the location of change in the selective conditions (Barton and Hewitt 1989). In effect, selection against hybrid individuals, which can often be strong, overwhelms selection from environmental factors. An important consequence of this theory is that, although geographical variation in selection can lead to substantial differences between nearby populations, it is not necessary that observed differences between populations imply strong selection.

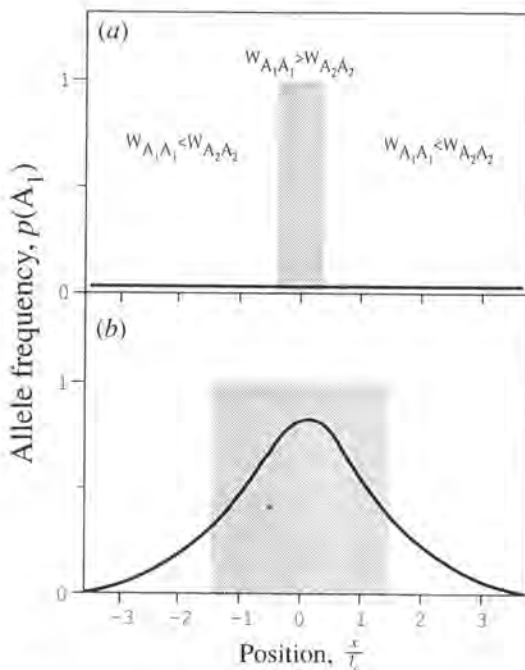

Figure 4.2-4: Frequency of a selectively favoured allele in an environmental pocket (hatched area) which is (a) shorter than the critical length, or (b) longer than the critical length. Position is measured relative to the critical length, l_c .

4.2.4.4 Outbreeding depression

One of the consequences of geographical variation in adaptive characters is that immigrants to an area may not be adapted to the local conditions. When a reduction in fitness follows the interbreeding of distantly related parents, it is usually referred to as 'outbreeding depression', regardless of the mechanism causing the fitness loss. Templeton (1986) emphasizes that outbreeding depression can also result from the adaptation of alleles to other alleles that may be missing from other populations. This process of 'genomic coadaptation' could produce outbreeding depression even in the absence of geographic variation in selection.

Outbreeding depression has been quantified in several plant species. In *Ipomopsis aggregata*, the offspring fitness of crosses between plants 100 m apart was significantly less than the offspring fitness of 10m outcrossers (Waser and Price 1989). Interestingly, this study indicated an optimal outcrossing distance, as inbreeding depression was found in crosses between plants 1 m apart. Our knowledge of outbreeding depression in animals is more tentative, partly because of the difficulty of doing transplantation experiments with natural populations of animals, and partly because of the need to follow the study animals for more than one offspring generation. One widely known case indicates that outbreeding depression can have dramatic consequences for the viability of animal populations. When Tatra Mountain ibex (*Capra ibex ibex*) in Czechoslovakia became extinct through overhunting, ibex were successfully transplanted from nearby Austria (Templeton 1986). But later additions to the Tatra herd of bezoars (*C. ibex aegagrus*) from Turkey and of Nubian ibex (*C. ibex nubiana*) from Sinai, resulted in hybrids which gave birth to young during the middle of the winter when no young could survive, and the population went extinct.

4.2.4.5 Gene flow opposed by genetic drift

Geographic variation in neutral alleles does not lead to adaptive differences but neutral alleles can serve as markers for the overall force of gene flow. Gene flow largely affects all loci in the same way and hence information can be combined across alleles and loci to provide an overall estimate of the extent of gene flow. The methods cannot be reviewed in detail here. They are largely based on the theories of Wright (1931, 1978), who showed that the variance in frequency of a neutral allele is proportional to $1/(1 + 4Nm)$ where N is the population size and m is the dispersal rate. Hence Nm is the number of immigrants to a population and Wright's results show that if Nm is much greater than 1, the variance among populations will be small, while if Nm is much less than 1, the variance will be large. Thus the variance in allele frequency or other statistics that depend on it can be used to estimate Nm and hence the importance of immigration for a species (Slatkin 1985).

Applying Wright's method to a variety of allele frequency data from natural populations has led to the conclusion that levels of gene flow differ greatly among species (Wright 1978; Slatkin 1985). As discussed above, many species, including many birds and other highly mobile species show little differentiation at apparently neutral loci, indicating that gene flow is an important force for them, while other species, including several species of salamanders and other sedentary species, show high levels of differentiation, suggesting that gene flow is relatively unimportant for them. Still other species, including such well-studied species as *Drosophila pseudoobscura*, a fruit fly found in the western United States, and *Euphydryas editha*, the checkerspot butterfly also found in the western US, are somewhat paradoxical. They exhibit little geographic differentiation over large geographical areas. Yet direct observations of their behaviour indicate that dispersal occurs over relatively short distances. Slatkin (1987) has used these and other examples to suggest that such species have only relatively recently colonized their current geographical ranges. The currently observed level of similarity among populations is not the product of ongoing gene flow but the result of the historical association of those populations before the expansion of their ranges. If this conclusion is true, then it points to an important problem in interpreting observations of natural populations, namely that they may not be at an equilibrium. What we see is the product of past events rather than ongoing processes. While it would be difficult to prove such a hypothesis in each particular case, it is important to bear that possibility in mind.

There is at present little empirical information available that allows us to test predictions about the genetic dynamics of metapopulations, and the widely publicized debate about whether cheetahs are devoid of genetic variation because of repeated bottlenecks in the total population (O'Brien and Evermann 1988), or because of a metapopulation structure (Pimm 1991), has been carried out in the absence of relevant data (see May 1995). Gilpin (1991) notes, however, that even if most species do not have a natural metapopulation structure, they may well behave in that way in the future if current rates of habitat destruction and fragmentation continue.

4.2.5 Summary

Genetic diversity within each species is the foundation of evolution and hence the foundation of the diversity of species. At the present time, there is extensive knowledge about the processes that affect genetic diversity but there is less knowledge about how diversity is maintained in each species. Based on the current knowledge in population genetics, we can draw a few conclusions that are relevant to the understanding of biodiversity. First, and probably most important, it is not possible to predict the response of

natural populations to a major change in the environment. Although there is abundant genetic diversity in most species for most characters, and hence the potential for a short-term response to selection, a species may respond to a change in conditions in a variety of ways that do not require genetic evolution. Furthermore, the longer-term response to selection is unpredictable even in laboratory populations. Second, in a widespread species there is the potential for substantial differences to evolve among local populations even if there is some dispersal of individuals among populations. To ignore those differences, some of which may drastically inhibit interbreeding, in attempts to manage populations might have undesirable consequences. Third, small population size increases the rate of loss of genetic diversity; and can lead to a substantial reduction in fitness, especially in outcrossing species. Finally, there are many genetic tools that can aid in the understanding and management of natural populations. New genetic markers are being discovered on a regular basis and they will be increasingly useful for understanding the history of natural populations and for understanding the forces that currently govern different parts of their genomes.

4.3 Diversification of species

The number of species, the distribution of species, and species extinction are at the centre of much of the global biodiversity crisis. Most often, appropriately or inappropriately, species diversity is the level at which biodiversity is assessed. Loss of biodiversity for many people means the loss of species, even though genetic and ecosystem diversity are, in fact, of equal or possibly even greater importance. This chapter examines the processes that lead to the formation of new species, discusses various concepts of species, and examines the evolutionary diversification of species.

New species can result from the gradual accumulation of genetic differences between lineages over long periods of time in response to selection for adaptation to different environments. Alternatively, new species can be formed by the precipitous and/or stochastic accumulation of genetic differences. Between these extremes lie many other possible modes of speciation. If one surveys a taxonomic diversity of organisms, it is clear that the formation of species occurs by many different mechanisms. Many groups of organisms have biological features that are either unique or singularly influential in their evolutionary biology. Thus, a mechanism of species formation may be rare in one group of organisms and be the most common mode of speciation in another group. A classic is that of polyploidy (the multiplication of chromosome number; see Section 2.2). Speciation due to polyploidy plays a minor role in animal evolution. In contrast, it is thought to be possibly the most important mode of speciation in higher

plants. This diversity of mechanisms, processes and patterns of speciation has led to a corresponding diversity of species definitions. Often what one researcher considers a species is influenced by the group of organisms being studied. The definition of what constitutes a species remains controversial (see Section 2.1.4).

4.3.1 Population differentiation

The process of speciation must begin within an existing species. Two possible paths may lead to a new species. First, a gradual change of an entire lineage or metapopulation may occur in response to a changing environment. Such gradual change in an entire lineage is termed anagenesis (Figure 4.3-1a). Another possible mode of genetic change is cladogenesis, the branching of a lineage into two separate lineages (Figure 4.3-1b). Cladogenesis results in an increase in the number of species. Regardless of which course of species formation occurs, with rare exceptions the formation of new species begins with genetic change within the populations of a single species. Such population differentiation is often thought to occur by the gradual accumulation of genetic differences in response to natural selection. In nature each population within a species is confronted with a unique set of environmental conditions. Natural environments are a complex assemblage of physical and biological components such as temperature, moisture, light, competitors and predators. Natural selection works to adapt a population to the myriad components of its environment. Over the course of time, each population accumulates genes that confer adaptation to that population's own unique combination of environmental parameters. The range for a single

environmental variable that a species encounters may be great and selection may adapt different populations to contrasting environments.

There are numerous studies in the evolutionary literature on adaptation to environmental variation. A classic case is the chromosomal inversions of *Drosophila pseudoobscura*. *Drosophila pseudoobscura* populations contain many different chromosomal inversions which occur in geographically localized regions. Intensive study of these inversions suggests that they contain a suite of genes which adapt the animals to multiple components of their specific environment. *Drosophila* populations show clear differentiation for these inversions, both on a geographical scale across the western United States, and along altitudinal gradients (Dobzhansky *et al.* 1977). A frequently cited example from plants is tolerance to heavy metal pollution. Plants of *Agrostis tenuis* in the British Isles occur both on mine tailings and in non-polluted pastures. Often these populations are contiguous, yet they show genetically based differences in tolerance to heavy metals (Bradshaw 1971). In *Agrostis* selection is only on one genetic locus, yet many other characteristics, such as plant size and flowering time, have also become differentiated as a correlated response to selection. Selection often results in a suite of genetic changes.

There are also numerous examples of selection producing functional diversity in many types of genes. The phosphoglucose isomerase genotypes of *Colias* butterflies differ dramatically in their biochemical properties and adapt the butterflies to varying temperatures (Feder and Watt 1992). In *Drosophila mercatorum*, an insertion in the 28S coding region of ribosomal DNA shows adaptive

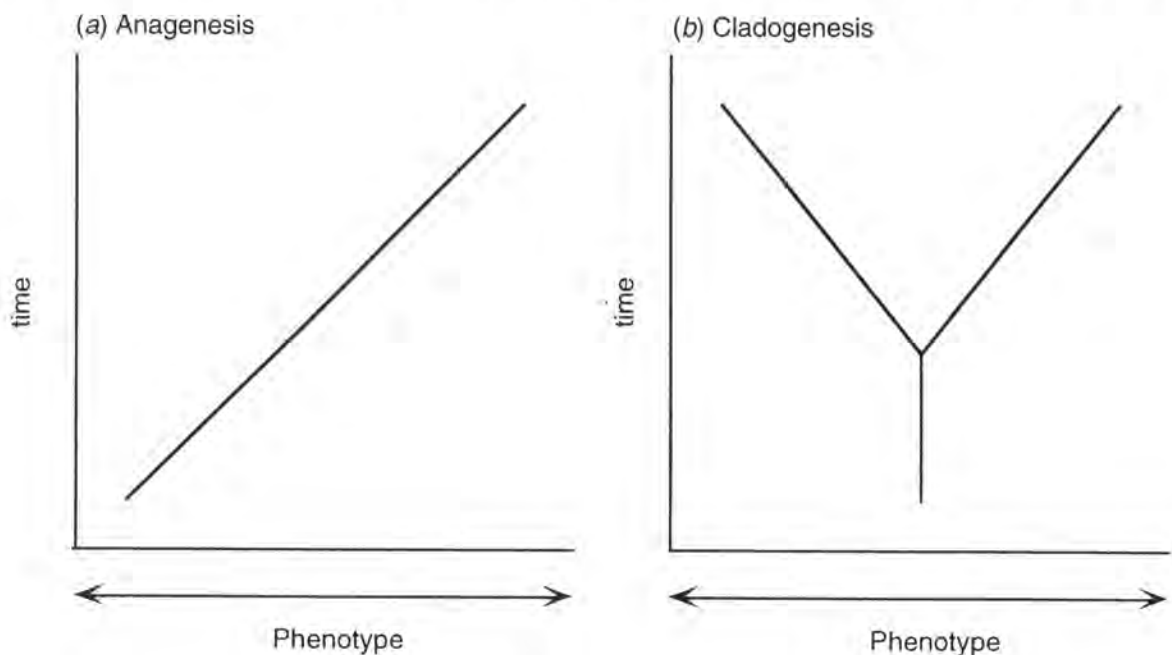

Figure 4.3-1: Anagenesis versus cladogenesis. (a) Gradual change of an entire lineage. Such phyletic change is termed anagenesis. (b) The splitting of a lineage into two lineages. Such branching is termed cladogenesis.

divergence between populations along a moisture gradient. The insertion in rDNA results in a life-history change of increased pupal time which conveys resistance to desiccation (Hollocher *et al.* 1992). A well-documented example of geographical variation is the haemoglobin S allele in human populations of Africa and Asia which is based on adaptive resistance to malaria.

The preceding presents a traditional view of population differentiation. There are other modes of population differentiation and their general importance in genetic differentiation and subsequent speciation is debated. A powerful evolutionary force in small populations is random genetic drift. In small populations gene frequencies can be altered statistically due to small sample size (population size). If a species consists of small populations, one expects genetic differentiation among populations simply by random drift. A related process occurs when population size is drastically reduced in a bottleneck. Again, the episode of small population size may result in random genetic changes. Founder events are often affected by genetic drift. In many instances populations are founded by a small sample of individuals from another population. All genes in the new population stem from the founders of that population and often are not an accurate representation of the alleles or frequencies of the source population. Thus the source and derived populations may have significant but random differences in gene frequency. Experimental work with small populations of *Drosophila* has documented the role of drift in altering gene frequencies. Founder events have played an important role in human genetic diseases such as Tay-Sachs and Huntington's chorea. Finally, studies of genetic variation in nature suggest that in some cases drift shapes population structure. In many species of both plants and animals with small population sizes, allozyme data show statistically significant but apparently random variations between populations with little variation within populations. Such apportionment of variation is consistent with genetic drift, which decreases variation within populations while increasing variation between populations.

Populations are not influenced only by single evolutionary forces. Most species will have within their geographical ranges, or in their history, populations of small size. Likewise, the environment is always placing selective constraints on the genetic variation within populations. Wright (1970) proposed the shifting balance theory of evolution which considers the interaction of multiple evolutionary processes. Populations are thought to exist in an 'adaptive landscape', in which peaks of high fitness are separated by valleys of low fitness. In the shifting balance theory Wright considered the deterministic processes of migration, gene flow and selection and how they interact with the stochastic process of genetic drift. If a population is on an adaptive peak, genetic drift may carry

gene frequencies in the population downhill, against selection, into a valley of low fitness. Selection for increased fitness may then bring the population back uphill along the slope of a different and potentially higher adaptive peak with greater fitness. Genetic drift and selection act in concert to reach a high fitness, beyond what selection can do by itself. In the shifting balance theory, the genetic composition of a population moves from adaptive peak to adaptive peak. This process continues until an optimal genetic composition for many loci is reached within the population.

The biogeographical history of a species can also have a strong influence on genetic differentiation among populations. Glacial refugia and subsequent postglacial migration have influenced the pattern of genetic variation of temperate taxa. Many plant and animal species of Europe show a genetic discontinuity between Eastern and Western Europe. In a recent study of oak trees, variation in a chloroplast *tRNA^{leu}* intron which is highly conserved shows the same geographical discontinuity across Europe as is seen for other species and for other genes (Ferris *et al.* 1993). These data strongly suggest that oaks in Europe were colonized from two different glacial refugia and that the genetic discontinuity in a conserved DNA sequence is due to historical biogeography.

So far, we have considered populations as isolated, independent units, yet few species contain populations that are always clearly demarcated from each other. All species and populations are patchy in distribution at some scale. Populations in the same geographical area interact with each other by migration of individuals and by gene flow (Chapter 4.2). Consequently, genetic differentiation in many species occurs at a higher level – that of the metapopulation. A metapopulation is defined as a population of populations (see also 4.4.2). Metapopulations are in many cases the relevant biological unit for both population genetic processes and ecological processes. Both demographic and genetic attributes are affected by the metapopulation. In an ecological sense population size is determined by birth and death rates of individuals which can be affected by migration from the components of the metapopulation. Metapopulations are determined by the rates of establishment and extinction of component populations which are affected in turn by migration by individuals. At a genetic level, gene flow among the components of a metapopulation works to reduce genetic differentiation. In populations of oak trees discussed above, metapopulations are united by migration and little genetic differentiation occurs except at the margin of metapopulations derived from different glacial refugia.

When systems of metapopulations become differentiated, they often take on a separate biological status such as subspecies or races. In some cases these genetic differences can be profound and the subspecies or

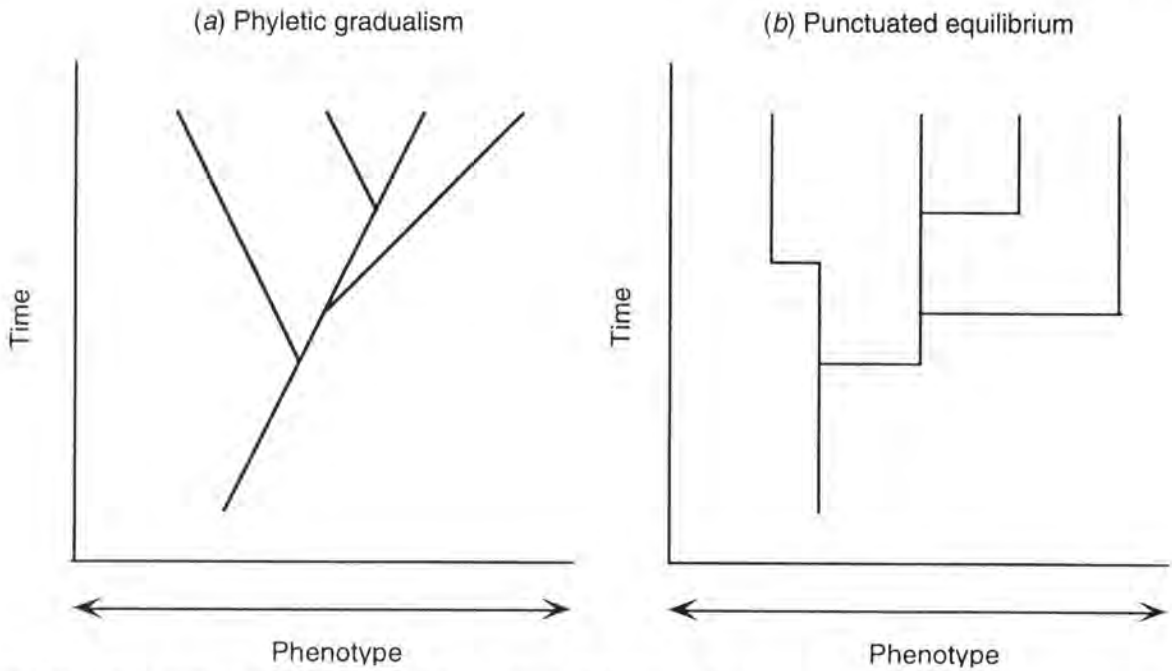

Figure 4.3-2: Phyletic gradualism versus punctuated equilibrium. Both figures show the same ancestral phenotype and the same phenotypic diversity in the end points. The rate of change illustrated by phyletic gradualism (a) is fairly constant over time, although lineages may differ. Punctuated equilibrium (b), on the other hand, is characterized by lengthy periods of very little phenotypic change interrupted by period of very rapid change.

race may be a separate evolutionary lineage. In other cases, a taxonomic name may be given to a morphological or colour variant and may represent merely different gene frequencies.

At this point populations or metapopulations are genetically differentiated. The next step in the diversification continuum is the species level, or speciation. There is much controversy about how evolution proceeds during speciation events. A long-standing hypothesis is that of phyletic gradualism. In phyletic gradualism the same micro-evolutionary processes that lead to population differentiation and adaptation continue, causing ever-increasing divergence between populations. At some point, enough divergence is accumulated for the differentiation to reach the level of species. In phyletic gradualism, evolution proceeds at nearly the same rate before, during and after speciation (Figure 4.3-2a). New species arise by the slow transformation of ancestral populations. The process of phyletic gradualism is implicit in Darwin's work, where he uses the concept of uniformitarianism to extrapolate from the process of natural selection to account for all of evolution including speciation and the formation of higher taxa. The pervasive view from the Neo-Darwinian synthesis is that most evolutionary transition takes place within established species; the branching process of cladogenesis adds new lineages but accounts for a relatively small amount of large-scale evolutionary change (Stanley 1979; Eldredge 1989).

Beginning in the 1970s, an alternative hypothesis of evolutionary rates and speciation was proposed – that of

punctuated equilibrium (Eldredge and Gould 1972; Gould and Eldredge 1977). The fossil record shows long periods of time when species remain relatively the same with little morphological change. At other times there appears to be rapid morphological evolution and speciation. Based on this common pattern in the fossil record, Eldredge and Gould (1972) proposed that evolutionary rates are not constant over time. They propose that for the most part, little evolutionary change occurs within species, and that the genetic changes associated with population-level phenomena do not account for species differences. Rather, most significant evolutionary change is associated with the event of speciation. The rate of evolution is accelerated by rapid divergent speciation. Between these 'punctuations' are periods of time with little or no evolutionary change; species are near equilibrium and experience periods of stasis (Figure 4.3-2b).

These two views are at opposite ends of a continuum of possible evolutionary changes. In many cases evolutionary rates are most likely somewhere in between, with periods of rapid and slow evolution and with periods of phyletic evolution and cladogenesis. But, regardless of the tempo or mode, the evolutionary process occurs and new species are formed.

As biologists learn more about the evolutionary process and species differences, the concept of what constitutes a species is becoming increasingly difficult (see Section 2.1.4). This must be borne in mind when considering the ways in which speciation takes place.

4.3.2 Speciation

The pivotal event in the proliferation of biotic diversity occurs when a new species comes into being: the process of speciation. This event must include enough divergence from other forms to allow diagnostic determination of the distinction between the new species and others. And under the biological species concept, the hallmark of this event is the acquisition of reproductive isolation (see Section 2.1.4). In the discussion here, we will outline the paths by which such barriers to interbreeding may arise between two groups, leading to speciation in this sense.

The commonly cited models of speciation include *allopatric* (geographic) speciation, where populations diverge while spatially separated; *parapatric* (semigeographic) speciation, where adjacent but non-overlapping populations diverge; and *sympatric* speciation, where differentiation occurs with no spatial separation or distinction between incipient species. In addition, since speciation is a genetic event as well, models must accommodate a genetic basis for speciation.

4.3.2.1 Allopatric speciation

Traditional models of geographic speciation have been well articulated by a number of insightful evolutionary biologists (Dobzhansky 1970; Mayr 1963; Grant 1963, 1981). These models all view the starting point as geographically isolated populations which may then progress through the stages of primary divergence (Figure 4.3-3; Grant 1963). If there is geographic isolation of two

populations (A and B in Figure 4.3-3) during some period, such that there is no gene flow between these populations, then these populations are in essence reproductively isolated although the barrier is geographic rather than genetic. If, over time, populations A and B diverge genetically to the point that they are diagnostically differentiated, then they might be recognized as subspecies or semispecies. When the lineages have diverged genetically to the point that they are no longer interfertile, they are then intrinsically reproductively isolated and this model would grant species status to each group. At this point geographic separation would no longer be relevant to the evolutionary fate of the two taxa. Reproductive isolation will remain even with the removal of geographic barriers.

The geographical barriers required for allopatric speciation may take many forms – mountain ranges, deserts, canyons, ocean basins and the like. Many examples of geographic speciation are known from oceanic islands near mainlands where populations can become *peripheral isolates*. An oft-cited example is provided by kingfishers on the mainland of New Guinea and nearby islands (Mayr 1942). The forms of *Tanysiptera galatea* on the mainland comprise three fairly indistinguishable subspecies. Five island forms of *T. galatea*, however, are quite distinct, and were originally described as separate species. The related *T. hydrocharis*, which today occupies both the mainland and an island, is believed to have reached its status as a separate non-interbreeding species while peripherally isolated from the mainland forms of *T. galatea* (Mayr 1942).

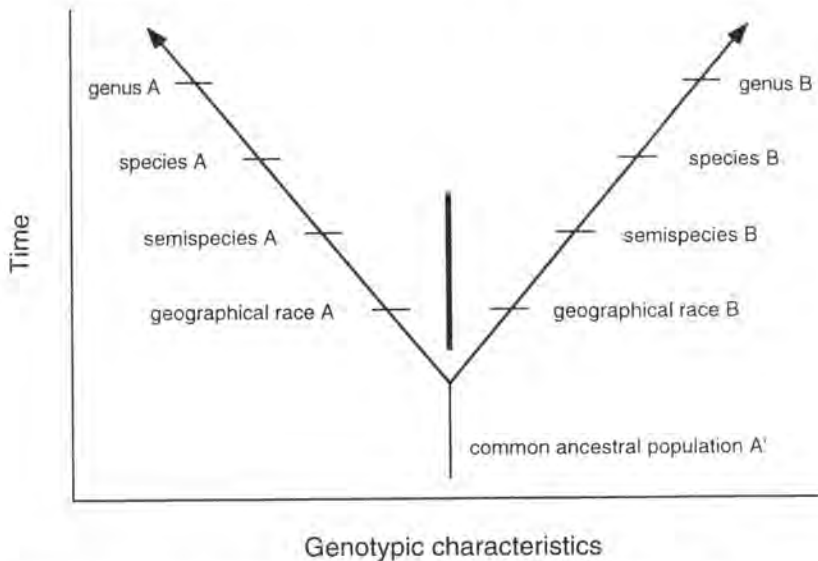

Figure 4.3-3: Stages of phenotypic divergence. In the diagram, the separation and divergence of two lineages over time is illustrated. Both lineages descend from their common ancestral population A'. While geographically separated, populations diverge to the point at which they are recognized as geographical races A and B, and perhaps after further divergence semispecies status is achieved. The heavy vertical line suggests geographical separation forms a barrier to gene flow between the diverging populations, although they remain interfertile. By the time the diverging lines are recognized as species A and B, the populations may still be geographically separated, but they are no longer interfertile. The geographical barrier to gene flow is no longer essential to maintenance of the divergent characteristics. Over time, the lineages may diverge to the point at which they are recognized as different genera, but that is not necessarily a consequence of geographic speciation. (Redrawn with modifications from Grant 1963.)

4.3.2.2 Parapatric speciation

In parapatric models of speciation, adjacent populations between which gene flow is possible diverge to the point of becoming separate species. The distinction is that there is no substantial geographic barrier to interbreeding between the two populations. For this divergence to occur, selection must favour alternative alleles in the adjacent populations, even in the face of possible gene exchange. As selection proceeds, distinct populations can be recognized, and where they are in contact a hybrid zone may be present. With sufficiently strong selection, differentiation may proceed to the point that populations are reproductively isolated, and they may be recognized as species meeting the isolation criterion of the biological species concept.

Some evolutionary biologists (e.g. Mayr 1970) believe that parapatric speciation can be viewed as a process of improving, in zones of secondary contact, imperfect isolating mechanisms that were acquired allopatrically. One commonly cited example is the narrow contact zone in Europe between the hooded crow (*Corvus corone*) to the west and the carrion crow (*C. cornix*) to the east. Although they interbreed and produce hybrids at the zone of contact, the forms remain distinct throughout the rest of their ranges. White (1978) cites several examples of what he terms clinal speciation, where parapatric speciation seems evident and there is no evidence of earlier periods of allopatry. We certainly know of cases of selection strong enough to lead to differentiation in adjacent populations. Perhaps the clearest cases are those involving evolution of heavy metal tolerance in plants on mine tailings despite gene flow from non-tolerant populations adjacent to the tolerant populations (Bradshaw 1971).

4.3.2.3 Sympatric speciation

In theory, a single species can give rise to two species completely within the original range of the ancestral species. Some of the ways this might happen are more controversial than others. One fairly non-controversial mode is via polyploidy, which may lead to 'instantaneous' speciation. This may be common among plants, and it will be discussed further below. But most of the theoretical models that allow sympatric speciation are based on disruptive selection (e.g. Maynard Smith 1966), and there remains considerable scepticism over whether the theoretically possible has been shown actually to occur (e.g. Paterson 1981; see 4.2.3.3).

One sort of example cited frequently as demonstrating sympatric speciation involves shifting host plants by phytophagous insects. Bush (1969) suggested that sympatric speciation was being observed in the fruit fly *Rhagoletis pomonella*, which has hawthorn as its native host in North America. It was first observed infesting introduced apples in 1864, and in this century it began to infest cherries. In Bush's explanation, as few as two genes

may be involved in host selection and survival, and selection can lead to host races separated by differing host preference, development and emergence times, and mating periods. However, Paterson (1981) has argued that sympatric speciation remains a theoretical concept without support from critically observed facts.

4.3.2.4 Other modes of speciation

Allopolyploidy is an important source of new species among plants. A starting point might be hybridization between two diploid species, with chromosome sets AA and BB, for example. The hybrid with non-homologous chromosome sets AB would typically be sterile due to meiotic failure resulting from the lack of chromosomal homology. But, if the chromosome number in the hybrid is doubled, the tetraploid composition would be AA BB. Since each chromosome is present as a homologous pair, normal meiosis is possible, and fertility may be achieved. Back-crosses to the original parental taxa would yield sterile triploids, so the new tetraploid is effectively isolated genetically from its progenitor species. Allopolyploidy is generally believed to be widespread in the plant kingdom. Grant (1963) reported 43% of 12 000 dicotyledon species and 58% of 5000 monocotyledon species were polyploid, suggesting that such a mechanism of species generation may be very important among plants.

Stasipatric speciation is the term used by White (1978) for changes in chromosome complements via rearrangements within the area occupied by an ancestral species. Such rearrangements can be extensive and result in reduce fertility when heterozygous. Populations homozygous for novel arrangements will become isolated from original populations. An example White cites involves dozens of chromosomal fusions and fissions among the more than 200 species in the Australian grasshopper subfamily Morabinae (White 1978). However, some workers feel that such multiple rearrangements typically arise allopatrically (Futuyma 1986).

Macrogenesis, the sudden appearance of a new species as the result of some type of saltational (rapid) macromutation conferring reproductive isolation, has from time to time been proposed as a mode of speciation. The proposed mechanism involves some type of revolutionary mutation which might produce what Goldschmidt (1940) has called a 'hopeful monster'. We do know of such changes in homeotic mutants of *Drosophila* like bithorax and aristapedia. However, as Mayr (1963) pointed out, most such mutants are 'hopeless'. Such macrogenesis is generally disregarded today.

Speciation in **asexual taxa** is an interesting concept. Since most models of speciation require some type of shift and stabilization of the genetic system involved, it is relevant to question how to evaluate speciation in asexual organisms. Like sexual organisms, asexuals have ancestor-descendent genetic continuity in lineages. Obviously, reproductive isolation is moot, since each lineage is

eternally isolated (except for exchange mechanisms such as plasmids). Mutation, selection and drift must be responsible for most of the diversity we observe today in organisms ranging from bacteria to obligately asexual fungi and plants. The phylogenetic and cohesion species concepts easily accommodate asexual taxa, since they do not depend on identifying reproductive boundaries to recognize that speciation has proceeded.

4.3.3 Multiplication of species

Charles Darwin's *On the Origin of Species* actually considers five different processes or theories of evolution (Mayr 1970). One of the central components of his work is the concept of multiplication of species. The branching of evolutionary lineages, cladogenesis, is the process that results in an increase in species biodiversity. Clearly the number of species has varied over geological time, both in an absolute sense and within specific taxonomic groups. For example, the diversity of marine animals has varied dramatically throughout the geological record (Sepkoski 1981, 1984; see Section 4.1). Some groups, such as starfish, have increased their diversity, and then remained constant. Other groups such as sea urchins, have had rapid increases in the number of species, then a decline in species numbers, and then another subsequent increase. Diversity is a function of both the speciation rate and the rate of extinction. If one examines the fossil record, periods of mass extinction are followed by a rapid increase in diversity. Here we will examine the processes that result in the formation of more species. Specifically, we address the issue of why evolutionary lineages branch. The other relevant process for species diversity, extinction, is discussed elsewhere in this volume.

Patterns of taxonomic diversification have generally been explained within an adaptationist framework. A major component of such explanations is the concept of a key innovation – a new character or structural/functional complex that may characterize a cluster of species. This cluster of species is often a clade, or a monophyletic group. Key innovations are a new way of making a living and are thought to be causally related to the subsequent success of the group possessing them. Key innovations allow a species group to occupy a novel suite of niches from which the group was previously excluded. That is, the species group can move into a new adaptive zone (Simpson 1944). The key innovation gives a species access to multiple new niches: cladogenesis and speciation occur as evolution adapts populations to these multiple niches. Closely associated with the concept of key innovation is the process of adaptive radiation, the rapid proliferation of species from a single ancestral lineage, often associated with the occupation of a new adaptive zone. Simpson (1944) considers adaptive radiation as the source of most large-scale morphological transitions and evolution.

Classic examples of key innovations include the bony skeleton of vertebrates, avian flight, the large brain of hominids, insect wings, and insect pollination in angiosperms. One of the most interesting cases of increase in diversity occurs in the cichlid fishes of African lakes. Liem (1973) in a classic study determined that a few modifications of the jaw apparatus of cichlid fishes comprised a key innovation that allowed cichlids to adapt and specialize on a variety of food types in numerous aquatic habitats. Rapid and frequent speciation occurred as these niches were filled.

Lineages may enter an adaptive zone and proliferate there because of the evolution of a key innovation, or the lineage may be pre-adapted to the adaptive zone. Key innovations are not necessary for adaptive radiation. When a whole suite of unoccupied niches is opened to a lineage, such as on islands, very rapid species proliferation may occur. The species of finch that first colonized the Galapagos Islands did not have a key innovation, yet produced perhaps the most famous adaptive radiation (Grant 1986). Cracraft (1990) has criticized the widespread interpretation of evolutionary innovations as a causal factor in adaptive radiation. For example, flight is often interpreted as a key innovation but is actually an aggregation of many morphological and physiological innovations which must have evolved at different times (Cracraft 1990). The multitude of flight innovations were occurring at the same time as diversity was proliferating and therefore could not be responsible for the evolutionary proliferation of birds. Recently molecular methods have been applied to the study of key innovations. The evolutionary success of flowering plants has been attributed to key innovations that originated at the base of the angiosperm clade. Sanderson and Donoghue (1994) used maximum likelihood methods to assess whether increases in the rate of branching were correlated with origin of supposed key innovations such as accelerated life-cycle and rhizomatous habit. From their analysis, large increases in branching rate did not occur until after the putative key innovations of angiosperms had evolved, suggesting that key innovations were not responsible for the adaptive radiation of angiosperms.

One other aspect of adaptive radiation needs to be considered, and that is the relationship between the extinction of one group and the rise of another. An example of this process is the rapid divergence of early mammals into the niches vacated by the extinction of dinosaurs. As with the dinosaurs and mammals, the rise of one taxon is often connected with the decline of another. Such a relationship suggests that competition plays a role in adaptive radiation and speciation. Why should one group replace another?

Ecological replacement of one group by another ecologically equivalent group has been used as evidence of

competitive exclusion of one group by another. That is, the dinosaurs kept the mammals suppressed until the dinosaurs became extinct. Then mammals were released for competition and were free to radiate. Such common scenarios have rightly come under criticism (Futuyma 1986). It is incorrect to assume that the decline of one group caused an increase in another, merely because of temporal sequence. The evolution of crocodiles provides a good example (Colbert 1949). Crocodiles invaded their niches after the phytosaurs had become extinct, and only after occupying these niches became increasingly adapted to aquatic life. Thus, there was no suppression of the crocodiles by competition with the phytosaurs, since the crocodile lineage did not occupy the same niches as the phytosaurs at the time they were both extant. On the other hand, angiosperms have replaced gymnosperms and peridophytes as the dominant group of terrestrial plants. In the fossil record one observes a strikingly parallel decline in conifers as angiosperms diversify, suggesting but not proving a role for competition in speciation.

4.3.4 Summary

The formation of species occurs by a number of different mechanisms, and this diversity of mechanisms has led to a corresponding diversity of species concepts which poses a pragmatic problem for conservationists. Which species concept is most appropriate to use, especially when evolutionary biologists themselves disagree? The use of a particular species concept is often based on the biological characteristics of a group of organisms. Thus, the determination of what exactly constitutes a species is, in many cases, best left to the biologists who study a taxonomic group.

Although many of the processes which lead to new species are debated, several points emerge. The formation of new species and the adaptive radiation of lineages have a strong ecological context. Speciation occurs predominantly as a result of adaptation either to a new environment or to a changing environment. The greatest rates of cladogenesis are all associated with the occupation of new adaptive zones. And if we take this argument one step further, species persist by maintaining adaptation to their ecological niches. The role of the environment is central to the formation of, and to the maintenance of, species diversity. Conservation of global biodiversity must centre on the conservation of habitats, so as to preserve not only species, but also the processes that lead to the formation of species.

4.4 Ecology of extinctions

4.4.1 Current rate of extinctions

In the public debate about biodiversity, it is often remarked that no species will survive forever. The other side of the coin is that every species is a unique potential ancestor of

new species, hence accelerated extinctions have profound consequences for the evolution of life on Earth. In the history of life, disappearance of species and higher taxa has been compensated for by the evolution of new forms from the existing ones (Chapter 4.1). The rates of extinction and speciation have varied greatly, but not always in parallel: the palaeontological record includes periods of net decline, and of net gain, in biodiversity (Chapter 4.1).

Our current concern about biodiversity stems largely from the judgement that the present rate of species extinction is extremely high in comparison with the natural average ('background') rate. The latter is so low that 'no biologist has documented the extinction of a continental species of plant or animal caused by non-human agencies such as competition, disease or environmental perturbation in situations unaffected by man' (Soulé 1983). The average species lifetime of mammals in the fossil record is in the order of one million years (Martin 1993), which would give roughly 0.5 extinctions per 100 years for the present mammalian fauna of nearly 5000 species. As will become apparent below, the current rate of extinction of mammals is roughly 100 times higher than this background rate. In other taxa the discrepancy may be even greater.

4.4.1.1 Past extinctions

Over geological time, among groups for which there is an adequate fossil record (the record is best for marine animals, but includes microbes, algae, fungi, protists, plants and terrestrial animals), species diversity has increased since life first arose nearly 4 billion years ago (Wilson 1988a; Benton 1995; see Section 4.1). However, this growth has been interrupted on numerous occasions by significant periods of species extinction including five 'mass extinctions' (Sepkoski 1992a; see Section 4.1). The largest of the mass extinctions, which took place at the end of the Permian (250 Ma ago), eliminated between 77% and 96% of marine animal species preserved in the fossil record (Valentine *et al.* 1978; Raup 1979b). The most recent mass extinction took place 65 Ma ago at the end of the Cretaceous, when the dinosaurs died out, and resulted in the loss of approximately 10% of families of terrestrial organisms and 15% of families of marine organisms. Even apart from these mass extinctions, 'background' rates of extinction are not constant. For example, during the past 250 Ma, relatively high rates of extinction are thought to have occurred nine times. Two of these nine episodes were mass extinctions: that of the late Triassic, 220 Ma ago, and that of the late Cretaceous (Sepkoski and Raup 1986).

Among organisms with adequate fossil records – including mammals, diatoms and some invertebrate groups – the average 'life-span' of a species is in the order of 5–10 Ma (Raup 1978; May *et al.* 1995). If this were to be applied to our estimate of approximately 13.5 million species of all groups currently alive, this would suggest that the expected

current rates of extinction would be very roughly one to three species per year (cf. May *et al.* 1995). There is, however, uncertainty about the average 'life-span' of species in the fossil record and there is variation in life-span estimates for different groups of organisms. For mammals, with an average lifespan of approximately 1 million years (Martin 1993), one extinction among the approximately 5000 mammal species on Earth would, on average, be expected approximately every two centuries. Among organisms with restricted ranges, prehistoric extinction rates may have been higher than the averages suggest, but for widespread species the 'background' extinction rate – that is, the average rate of extinction – is extremely low.

Humans have been a cause of species extinction for thousands of years. Significant extinctions of large mammals in the Americas and Australia took place between 15 000 and 35 000 years ago as humans first moved into these continents (Martin 1973, 1986). And prehistoric colonization of islands in the Pacific and Indian Oceans some 1000 to 2000 years ago by humans and their commensal animals such as rats, dogs and pigs may have led to the extinction of as many as one-quarter of the world's bird species (Olson and James 1982; Vitousek 1988; Olson 1989). On tropical Pacific islands alone, more than 2000 species of birds may have been driven to extinction, representing a 20% world-wide reduction in bird species (Steadman 1995).

4.4.1.2 Recent extinctions

Species are recorded by the World Conservation Monitoring Centre as 'extinct' (Ex) based on the criteria given in the IUCN (*Red Data Book*) categories of threat: they are taxa that are no longer known to exist in the wild after repeated searches of their type localities and other known or likely places. As applied to animals, following a resolution of the CITES Conference of the Parties in 1979, a species is recognized as extinct when it has not been found for at least 50 years, although this is not always applied rigorously. Moreover, in some instances, when the last few individuals of a species are being monitored closely, an extinction may also be recorded when the last individual dies. This means that our current records for species extinctions do not include all actual extinctions that may have taken place in recent decades. On the other hand, every year cases are reported of species thought to have been extinct being rediscovered, partly through imperfect exploration of the areas concerned (cf. Magsalay *et al.* 1995). It is immensely difficult, therefore, to know when the last individuals of a species, especially very small ones (such as insects and fungi) have disappeared. The use of statistical models derived from the capture–mark–recapture theory may provide better estimates of species extinction and colonization (Nichols and Pollock 1983; Clobert 1995),

in particular because it provides a way to correct for differences in intensity of area exploration (capture probability).

Since 1600, 484 animal and 654 plant species (mostly vertebrates and flowering plants) are recorded as having gone extinct according to data compiled by the World Conservation Monitoring Centre (Table 4.4-1), although this is certainly an underestimate of the true total, particularly with regard to tropical species. The rate of recorded extinctions in groups such as birds and mammals has increased dramatically during this period. Nearly three times as many species of birds and mammals were recorded as becoming extinct since 1810 (112 species), as were recorded as going extinct between 1600 and 1810 (38 species) (WCMC 1992). Geographically, extinctions during this period appear to have been most numerous on islands, island archipelagos, and in freshwater ecosystems. Among animals, for example, 75% of extinctions took place on islands (WCMC 1992). Freshwater systems are the terrestrial analogue of oceanic islands and are also particularly vulnerable to habitat loss and to the introduction of non-native species. Recorded extinctions in aquatic environments are predominantly from freshwater lakes and rivers.

The smaller the area and the more severe the environmental change the higher the rate of local loss of populations of species. For example, the Netherlands has an area of 35 000 km², a human population of 15 million, 5 million cattle, 15 million pigs and 100 million chickens (Anon. 1991). Of the higher plants, 37 of 1410 species went extinct in the Netherlands by 1940, and another 33 species were extinct by 1990. The proportions of nationally extinct species among grasshoppers and crickets, dragonflies, butterflies, breeding birds and mammals were 2%, 13%, 24%, 2% and 7%, respectively (Bink *et al.* 1994).

Table 4.4-1: Number of recorded species extinctions since 1600 (WCMC 1992; WCMC pers. comm. 15 February 1995).

Group	Number extinct since 1600
Molluscs	191
Birds	115
Mammals	58
Other animals	120
Total Animals	484
Plants	654

Considerable uncertainty surrounds any attempt to compare recent extinction rates with rates calculated from the fossil record. Quantitative palaeontological data are best among marine invertebrates (a group that is poorly documented today). Fossilized species are usually drawn

Table 4.4-2: Numbers of species considered 'Threatened' by the World Conservation Monitoring Centre. (WCMC classifies all species listed as 'Endangered', 'Vulnerable', 'Rare' or 'Indeterminate' as threatened species.) (WCMC pers. comm. 1995.)

Threatened	Endangered	Vulnerable	Rare	Indeterminate	Total
Mammals	177	199	89	68	533
Birds	188	241	257	176	862
Reptiles	47	88	79	43	257
Amphibians	32	32	55	14	133
Fishes	158	226	246	304	934
Invertebrates	582	702	422	941	2647
Plants	3632	5687	11485	5302	26106

from the more abundant and widespread taxa, and time resolution is rarely better than 10^3 – 10^4 years (Jablonski 1995). Moreover, mean durations of fossil species vary by more than an order of magnitude even within clades. Thus average 'background' rates of extinction conceal considerable variations in rates among different groups and considerable variation in rates over time. Additional uncertainty in comparative estimates results from the fact that records of recent extinctions are almost certainly under-recordings even for groups such as plants, birds and mammals.

Given these caveats, however, recent rates of extinction are still strikingly higher than rates in the fossil record. If we accept the measured background rate of roughly one extinction of a mammal species on average every 200 years, the 20 recorded mammal extinctions this century represents a rate of extinction 40 times greater than the 'average'. Assuming that the average species lifespan of birds falls within the average range of 5–10 million years, the more than 2000 extinctions that have taken place in the last 2000 years associated with human actions is a rate approximately 1000 times greater than the 'background' rate of extinction.

4.4.1.3 Current status and rate of extinctions

The most comprehensive source of information on extinctions and threats of extinction are the statistics on threatened species published in the *Red Lists and Red Data Books* compiled globally by the World Conservation Monitoring Centre (see Sections 7.2.8.3.2 and 13.4.3). Various systems exist for classifying the status of species with respect to their long-term probability of survival. The categories of threat for species, introduced by IUCN nearly 50 years ago, are widely used around the world although new IUCN Red List categories were introduced by IUCN in 1994 (IUCN 1995). A threatened species refers to a species considered to fall within one of the categories of threat (Extinct, Endangered, Vulnerable, Rare, Indeterminate) and in general terms can be considered to be

a species thought to be at significant risk of extinction in the foreseeable future because of random or deterministic factors affecting its population size or by virtue of its rarity. The numbers of species listed as threatened are minimum estimates, since species are listed only if enough is known about their population size, trends and potential threats to allow judgement of their status.

The estimates for the minimum numbers of globally threatened animal and plant species in 1994 are 5366 animals and 26 106 plants (Table 4.4-2). For individual groups, 11% of birds, 18% of mammals, 5% of fish, and 8% of plants are threatened. However, for the vast majority of the 1.75 million described species, and the many millions of undescribed species, no assessment of status has been made due to a lack of information.

Many threatened species are found on islands and in freshwater ecosystems. For example, one in three of all known threatened plants are island endemics. Among birds, some 23% of island species are threatened, compared with only 11% of birds world-wide (WCMC 1992). Other regions with particularly high levels of threat include the Mediterranean-climate regions. As a result of recent habitat change, introduced species, and the high degree of local endemism of plants in Mediterranean regions, an estimated 15% of vascular plants are threatened in the Mediterranean zone of California, 17% in the Cape Province of South Africa, and 24% in southwest Australia (Reid and Miller 1989), varying with the time of human implantation (Greuter 1995).

An important point that is emerging is that environmental changes, whether human-induced or not, are likely to have less impact on floras and faunas that have undergone similar stresses in the past. Thus Pimm et al. (1995a) show that there was lower recent extinction of birds in the islands of the western Pacific, which were colonized by humans some 3000–5000 years ago, than on the more recently colonized Hawaiian and other eastern Pacific islands. Also, Greuter (1995) has shown that records of recent plant extinctions in regions with a

Mediterranean flora are lowest in the Mediterranean proper (0.1%), where human impacts are oldest and higher where the impacts are more recent (the Cape Region – 0.3%; California – 0.4% and Western Australia – 1%)

For those groups of species for which sufficient data are available, including beetles, birds, vascular plants and mammals, the number of species found in a given habitat has been found to depend on the area of the habitat (Connor and McCoy 1979; Reid 1992). The empirical relationship between number of species and area for these groups, known as the 'species–area' relationship, can be used to project impending rates of extinction due to habitat loss. These estimates suggest the likely percentage of species within these groups that will eventually become extinct in a region as a result of habitat that has already been lost or that is projected to be lost. This reduction in equilibrium numbers is often referred to as the percentage of species 'committed to extinction' (Reid 1992; Heywood and Stuart 1992; Heywood *et al.* 1994; Magsalay *et al.* 1995) in the sense that these extinctions may not be immediate. In fact, it could take decades or even centuries for the reduced habitat to reach its 'equilibrium' number of species, and as Simberloff (1992) notes, there is no accepted theory for the rate at which species will be lost through time and the new equilibrium reached.

Because not all extinctions due to habitat loss take place immediately, the recovery of habitats before a new equilibrium number is reached can prevent some extinctions (Reid 1992; Heywood and Stuart 1992). For example, despite the reduction of the Atlantic forests ('Mata Atlântica') of Brazil to around 10% of their original extent over the past century, only a handful of species are known to have become extinct (Brown and Brown 1992), although many are reduced to small populations and are therefore susceptible to imminent extinction.

Species–area estimates of extinction rates give some indication of the long-term consequences of habitat loss, but they are imprecise due to uncertainty in: (1) rates of habitat loss; (2) likely survival of species in modified habitats; (3) detailed knowledge of the distributions of species and endemism (cf. Pimm *et al.* 1995b); (4) the influence of the pattern of habitat loss on species survival (fragmentation could result in greater impacts (Simberloff 1992) while the protection of certain critical habitats could greatly reduce impacts); (5) the variation among taxonomic groups in the relationship between species numbers and area; (6) past disturbance or habitat loss (residual losses of species may occur due to the habitat loss that took place recently, or rates may be lower than expected because of previous disturbance that caused the extinction of sensitive species); and (7) future changes in human behaviour or resource management that could ameliorate or exacerbate these effects (Reid 1992; Heywood and Stuart 1992).

A number of estimates of extinction rates in tropical forests have been made using species–area curves (Lovejoy

1980; Simberloff 1986; Raven 1987; Myers 1988; Wilson 1988b; Reid and Miller 1989; Reid 1992; reviewed in Reid 1992). Estimates of species that will become extinct or committed to extinction in tropical forests over approximately the next quarter century range from 2% to 25% in the groups examined (variously: plants, birds, plants and birds, and all species). The wide range in these estimates stems from different assumptions about future rates of forest loss and proportion of species diversity in tropical forests, use of different estimates for the slope of the species–area curve, and differences in the types of tropical forests considered. For example, considering only closed tropical forests at rates of loss measured in the late 1980s (approximately 10 million hectares per year, or just under 1% of closed tropical forest area per year) the equilibrium number of species would be reduced by 4% to 8% over the next quarter century (Reid 1992).

Because of the potential added impact of forest fragmentation on rates of extinction, these estimates may be conservative (Simberloff 1992), although if rates of forest loss decline during the next 25 years they could be over-estimates. They are likely to be most accurate for groups such as beetles, birds, plants and mammals for which empirical data on species–area curves are available. It is unlikely that the species–area relationship does not apply equally well to less well studied groups; however, it is likely that extinction estimates would differ across lesser known groups. For example, forest-canopy-dependent invertebrates might face greater threats from forest loss than soil-dwelling invertebrates or microorganisms. Estimates of species loss in tropical forests depend strongly on predictions of future rates of forest loss and in particular on the capacity and will of the countries concerned to act on deforestation and forest fragmentation (Simberloff 1992). Comparable estimates have not been made for the potential impact of habitat loss in other regions.

A rough idea of the global impact of these predicted tropical forest extinction rates can be made based on evidence that species diversity in tropical forests accounts for roughly one half of the world's species diversity (Myers 1980; Reid and Miller 1989). The published range of tropical forest extinction estimates thus suggests that roughly 1–10% of the world's species will become extinct or committed to extinction in the groups examined (plants, birds, plants and birds, and all species) over the next quarter century. These rates of extinction would be approximately 1000 to 10 000 times the average expected 'background' extinction rates.

Two alternative approaches to projecting rates of species extinctions give comparable estimates of impending extinction, based on data obtained from lists of species 'Threatened', 'Vulnerable', 'Endangered', 'Probably extinct' and 'Extinct' in international assessments. One method examines the rate at which individual species are

moving to progressively more threatened categories (Smith *et al.* 1993). For birds and mammals, the current rate at which species are moving into more threatened categories implies that 50% of the species in the groups will be extinct within 200–300 years (Smith *et al.* 1993). The second method examines species-by-species assessments of extinction probability distributions as a function of time (Mace 1995). Based on this approach, 50% of species in selected subsets of mammals, birds and reptiles are projected to be extinct within 100–1000 years. Extinction rates calculated with either of these methods are imprecise, since the numbers of species in various categories and changes in the status of species reflect not only biological factors but also the state of knowledge of the species involved, levels of human concern about the taxa, and rates of data entry.

The extinction of a species is generally due to multiple causes: no single threat to populations or species can be considered independently (see 4.4.2.3). For example, the loss of habitat may reduce the population of a species to a size small enough to be at risk from predation, disease or severe weather. The cumulative effect of various disturbances can seriously threaten a region's biodiversity. Even if the disturbances have only additive effects, small changes can add up to serious impacts.

Based on ecological theory, species that are most threatened with extinction are: (1) large organisms, (2) those highest on the food chain, (3) those with small population sizes, (4) those with small ranges or distributions, (5) those tied in some aspect of their biology to habitats or ecosystems that are threatened, (6) those that have evolved in isolation (e.g. island faunas and floras), (7) those with poor dispersal and colonization abilities, (8) those with colonial nesting habits, (9) migratory species, (10) those dependent on unreliable resources, and (11) those with little evolutionary experience of disturbances. Thus, many island and locally endemic plants and animals will be lost because of their susceptibility to habitat loss, and extinctions among top carnivores and large animals will be disproportionate because their population density is generally low (Reid and Miller 1989).

4.4.2 Mechanisms of extinction

Here we review the mechanisms of population extinction. Why does a population go extinct under the prevailing environmental conditions? Later (4.4.3) we turn to the *causes* of extinction. Why do populations become vulnerable to extinction? This latter question is generally related to various forms of environmental change. Instead of population extinction we may inquire about species extinction, recognizing that a species goes extinct when the last population goes extinct.

A population goes extinct with certainty if, in the long run, the death rate exceeds the birth rate (MacArthur and

Wilson 1967; Richter-Dyn and Goel 1972; Peters and Mangel 1990). Whatever causes population extinction (4.4.3), this process involves an increase in death rate, a decrease in birth rate, or both. A more subtle and challenging task is to understand the risks of extinction in environments in which, in principle, the population may persist forever (birth rate exceeds death rate at low density). We shall first discuss extinctions in the context of single populations, then move on to consider extinctions in metapopulations, systems of several connected local populations (Gilpin and Hanski 1991).

4.4.2.1 Single populations

4.4.2.1.1 Low population density: Allee effects. Individuals may be spread over such a large area, in comparison with their natural movement range, that their opportunities for interaction, including mating, are limited (Gilpin and Soulé 1986; Lande 1987; Dobson and Lyles 1989). This will directly affect population growth rate, which may drop below unity (death rate becoming greater than birth rate) when population density declines below a threshold value. Lowered population growth rate with decreasing density is called an Allee effect (Allee *et al.* 1949). A well-documented extinction of an isolated population in which an Allee effect was involved is the disappearance of the middle-spotted woodpecker *Dendrocopos medius* from Sweden in 1982 (Pettersson 1985). Extinction induced by low population density is a particularly worrying threat for species with highly evolved sociality.

4.4.2.1.2 Demographic stochasticity. Changes in population size due to births and deaths necessarily involve chance variation (stochasticity), because individual development and physiology involve randomness, such as the sex of the offspring and the development of cancer. Hence there is a finite probability that all individuals in a population happen to die in the same unit of time (Caswell 1989). This probability (of population extinction) mainly depends on the current population size (small populations are most vulnerable), mean survival rate, and the variance in the survival rate among individuals (Goodman 1987; Mode and Jacobson 1987). Not much is known about the consequences of genotypic and phenotypic variation among individuals to the susceptibility of population extinction (Lande and Barrowclough 1987). Such variation may amplify demographic stochasticity (Bengtsson 1991) but does not do so necessarily, for instance, if phenotype \times environment interaction is important (Stearns 1992).

Though demographic stochasticity necessarily poses a significant threat to the survival of very small populations (those consisting of some tens of individuals or less), larger populations are less affected because the expected time to extinction under demographic stochasticity increases roughly exponentially with the equilibrium population size

(assuming that the population is capable of recovering from perturbations to small size; Lande 1993). In large populations, demographic stochasticity is masked by environmental fluctuations as is discussed below. In models of both demographic and environmental stochasticity, extinction times tend to be roughly exponentially distributed (Strebel 1987; Gabriel and Burger 1992), which means that many populations may be expected to go extinct quickly while a few populations may last for a long time. A corollary of this result is that the average extinction time is not a very informative statistic, as most populations would go extinct faster than the average population.

4.4.2.1.3 Environmental stochasticity. Probabilities of birth and death in natural populations are typically affected by environmental factors with more or less correlated effects on many individuals. Such correlated stochasticity, or environmental stochasticity, will reduce the variance in the vital rates among individuals, which has the same effect as reducing population size and is hence harmful for survival. In the extreme case of complete catastrophe, the correlation is complete: if one individual dies, all others die as well. Large population size is then no guarantee of survival.

Environmental stochasticity is reflected in temporally fluctuating growth rates of populations. Long-term growth rates in variable environments (Caswell 1989; Tuljapurkar 1990) and the consequent risk of extinction (Leigh 1981; Goodman 1987; Lande and Orzack 1988; Lande 1993; Foley 1994; Mangel and Tier 1994a) are difficult to calculate analytically. None the less, it is clear that increasing variance of the growth rate increases the risk of extinction. Extinction risk is also increased by low average growth rate, low current population size, and low equilibrium population size (Lande 1993; Foley 1994). In particular cases, sufficiently realistic models and useful

predictions may be developed with numerical methods (Lande and Orzack 1988; Legendre *et al.* 1993; Mangel and Tier 1994a, b).

Of particular importance to the survival of species in temporally varying environments is the structure of the variability, as characterized by, for example, the autocorrelation function. Species have evolved different life histories depending on the type of environmental variation encountered in the past (Kaplan and Cooper 1984; Orzack and Tuljapurkar 1989). When predictability is weak, risk-spreading strategies are expected to evolve, whereas when predictability is high, life histories geared towards maximization of short-term fitness are expected. A particular threat to species survival is a change in the pattern of variability, which may render a particular life history inappropriate in the changed environment (see below). Theoretical and empirical studies on these topics are badly needed.

4.4.2.1.4 Genetic factors in extinction. Two widely discussed genetic factors in extinction are elevated risk of extinction due to inbreeding depression and loss of evolutionary adaptability to novel environments due to reduced genetic variation in small populations (Lande 1988a). These genetic factors are discussed at length in Chapter 4.2: here we summarize only the key points.

If a previously large population is suddenly reduced to a small size, individuals are forced to mate with close relatives and often experience reduced viability and fecundity, known as inbreeding depression (Lande 1988a). The mechanisms of inbreeding depression are not known for most species (Thornhill 1993), but in *Drosophila* about half of inbreeding depression is due to increased homozygosity of recessive deleterious mutations at about 5000 loci: the rest is caused by numerous slightly recessive and detrimental mutations (Lande 1988a). Inbreeding depression has been well documented for domestic and

Table 4.4-3: Extinctions of rare butterflies on nature reserves in Britain between 1960 and 1982 (modified from Warren 1992).

Species	Total number of populations in Britain	Number of populations on reserves	Percentage of populations on reserves that went extinct, 1960–81
<i>Lycaena dispar</i>	1	1	100%
<i>Maculinea arion</i>	4	4	100%
<i>Carterocephalus palaemon</i>	16	4	100%
<i>Melitaea cinxia</i>	18	7	0%
<i>Melitaea athalia</i>	29	7	29%
<i>Satyrrium pruni</i>	30	11	0%
<i>Hesperia comma</i>	52	33 ¹	27%
<i>Lysandra bellargus</i>	c. 75	19	21%

1. Nine populations on reserves went extinct but four new reserves were colonized during the same time period.

laboratory organisms and zoo populations (Lerner 1954; Falconer 1981; Ralls *et al.* 1986), but there is very limited information for natural populations (Shields 1993).

The rate of loss of genetic variation due to genetic drift (Chapter 4.2) increases with decreasing population size, N , which in this context should be understood as the 'effective population size' (an ideal population of size N with random union of gametes in reproduction). Effective population size is generally much smaller than the actual population size, often only 10–50% of the censused number of individuals. In the absence of forces maintaining genetic variation (e.g. mutation, migration, selection favouring heterozygotes), heterozygosity is expected to drop to 37% of its initial value in $2N$ generations. Heterozygosity is lost even more rapidly if mating occurs non-randomly, among close relatives.

4.4.2.1.5 Summary: the critical role of population size. The central message from practically all theoretical studies on extinction is that the risk of extinction increases, and hence the expected population lifetime decreases, with decreasing population size. Empirical investigations have found ample support for this prediction (Smith 1974; Terborgh and Winter 1980; Williamson 1981; Hanski 1986; Hanski and Thomas 1994; Diamond 1984; Schoener and Spiller 1987; van Dorp and Opdam 1987; Bengtsson 1988), though the actual mechanism of extinction has remained generally unknown. Demographic stochasticity poses a real threat to survival only when population size is very small, say fewer than 50 individuals (see 4.4.4.3). Inbreeding depression is likely to be important only under special circumstances, when a previously large population is suddenly reduced to a very small size (which may happen in the colonization of a previously empty locality). Environmental stochasticity, which leads to temporal fluctuation in birth and death rates, emerges as the main mechanism of extinction. Under environmental stochasticity, extinction probability decreases with increasing population size, but if the level of stochasticity is high, in the sense of much variation in the growth rate in comparison with the average growth rate, even large populations may have a relatively short expected lifetime.

The expected population size depends critically on the availability of essential resources and on the extent of suitable habitat (Boecklen and Simberloff 1986). The negative relationship between extinction probability and the size of the habitat fragment, which may be an island or a nature reserve, is well established (Diamond 1984). Factors other than resource limitation may affect average population size, for instance predation, disease and social interactions, which thereby affect extinction risk. The type of density dependence in population regulation also has relevance to the question of population extinction. Scramble competition and density dependence acting with a time delay may amplify population fluctuations (May 1976) and thereby increase the risk of extinction.

4.4.2.2 Metapopulations: assemblages of local populations Population biology has traditionally emphasized factors that pose a threat to the survival of single populations. The practice in conservation biology is much affected by this tradition, reflected for instance in the emphasis on the management of isolated nature reserves (Table 4.4-3). But many species have survived even if there are no large enough local populations which could be expected to persist for a long time, and species have survived in continuously changing landscapes. Species living in successional habitats provide clear-cut examples (Thomas 1995). In any one place, the right kind of habitat is present only for a limited period of time and local extinctions are inevitable, but a species may survive regionally if it is able to establish new local populations elsewhere, where the right kind of habitat has appeared. An assemblage of such extinction-prone local populations, connected to each other by migrating individuals, is a form of metapopulation (Levins 1969, 1970; Hanski 1991; see 4.3.1). Box 4.4-1 describes an example of an endangered species of butterfly persisting as a metapopulation in a naturally fragmented landscape.

Metapopulation persistence hinges on the processes that affect the rates of local extinction and the establishment of new populations. A necessary condition for metapopulation persistence is that the rate of establishment of new populations exceeds the rate of extinctions when the metapopulation is small, that is, when only a small fraction of the suitable habitat (patches) is occupied (this condition is analogous to the requirement that the expected birth rate must exceed the expected death rate for a local population to survive). Mechanisms of local extinction have been discussed above. Generally, extinction risk increases with decreasing population size and hence, typically, with decreasing size of the respective habitat patch (Hanski 1994b). A new element introduced by the metapopulation concept is the establishment of new populations, which has two necessary requirements: there must exist habitat patches in which a new population can be established, and there must be sufficient migration of individuals from the existing populations to the currently empty patches. Therefore, if a species functions as a classical metapopulation with high risk of local extinction, long-term persistence of the metapopulation depends not only on the currently occupied habitat patches (existing populations) but also on the presence, in sufficient numbers and at not-too-great distances, of unoccupied but suitable habitat. The emphasis on migration in metapopulation theories enlarges the biological traits that are significant in the context of population extinction.

Not all species are structured as classical metapopulations even in fragmented landscapes. In some cases the persistence of the metapopulation depends on some large core population(s) with a small risk of extinction, and which serves as a permanent source of

Box 4.4-1: Metapopulation persistence of an endangered butterfly in a fragmented landscape.

The Glanville fritillary *Melitaea cinxia* has become extinct or severely declined in many parts of Europe during the past few decades (Hanski and Kuussaari 1995). In Finland, the butterfly survives only on the *üländ* islands, within an area of 50 km × 70 km, in a network of 1502 suitable habitat patches (see map) in dry meadows with the larval host plants *Plantago lanceolata* and *Veronica spicata*. In 1993, a local population was found on 536 meadows (black dots on map; grey dots represent suitable but empty meadows). Hanski *et al.* (1995) conclude that the long-term persistence of this butterfly on *üländ* is based on metapopulation-level dynamics, i.e. a balance between stochastic local extinctions and recolonizations, because this metapopulation satisfies the following four conditions:

Condition 1. The species has a metapopulation structure; meadows are occupied by well-defined local populations, with >80% of butterflies staying on the natal meadow (Hanski *et al.* 1994).

Condition 2. The largest local population was <1000 individuals in 1993. Many studies on this and related butterflies (Table 4.4-3) have shown that such small populations are not safe from extinction on the time scale of tens of years.

Condition 3. The nearest-neighbour distance between meadows is 240 m (maximum 3870 m), whereas the mean, median and maximum distances moved by dispersing butterflies were 590 m, 330 m and 3050 m. Therefore, the meadows are not too isolated to prevent recolonization.

Condition 4. Local dynamics are not well synchronized, for reasons discussed in Hanski *et al.* (1995), which makes simultaneous extinction of all local populations unlikely.

Effect of patch area			Effect of patch density		
Area (ha)	Occupancy		Patches per 4 km ²	Occupancy	
	<i>n</i>	<i>P</i>		<i>n</i>	<i>P</i>
<0.01	23	0.24	1	61	0.21
0.01–0.1	138	0.24	2–3	70	0.32
0.10–1.0	88	0.40	4–7	58	0.25
>1.0	6	0.56	>7	66	0.41

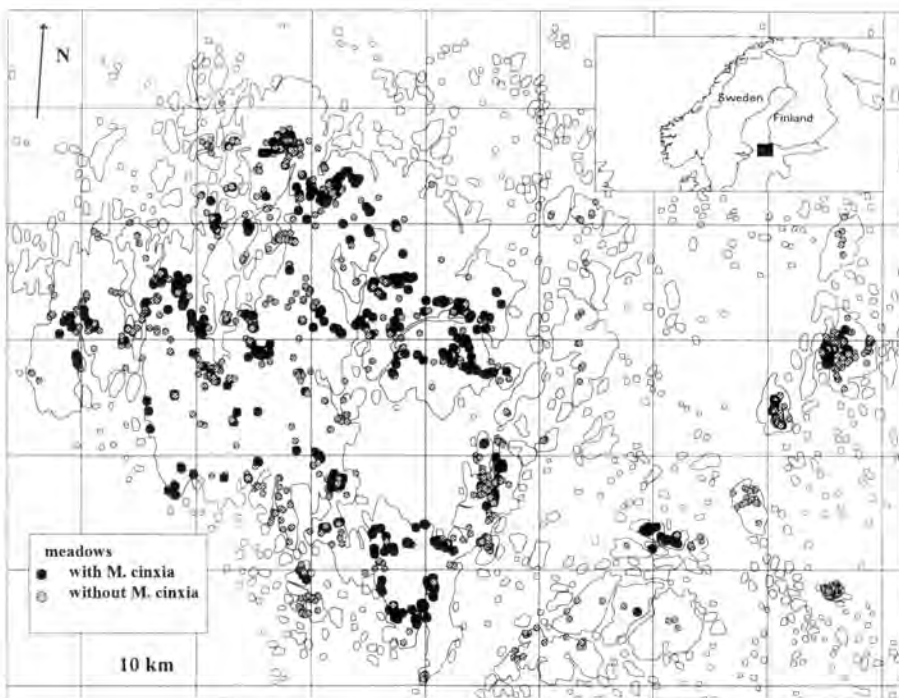

The table illustrates how the fraction of suitable meadows occupied by the butterfly at one point in time decreases with decreasing average area and increasing isolation of the meadows. For this analysis, the geographic range of the species was divided into 2 km × 2 km squares, and the fraction of occupied meadows in each square was scored (= occupancy, *P*). The area in the table gives the average area of meadows in the square. For details see Hanski *et al.* (1995).

immigrants to peripheral and smaller habitat fragments, where extinctions may be common (mainland–island metapopulations; Hanski 1991; Harrison 1991, 1994). In this case the conservation of the core population is critical. In other metapopulations some local populations serve as net producers of immigrants because of high population growth rate, perhaps due to superior habitat quality, while population growth rate in other populations may be significantly enhanced by immigration from these source populations (source–sink metapopulations; Pulliam 1988). Finally, an apparent metapopulation structure is no guarantee of long-term survival: the metapopulation may occur in a recently fragmented landscape where no balance between extinctions and colonizations has been achieved, and the entire metapopulation may be slowly declining to extinction (non-equilibrium metapopulations; Hanski 1994c).

Assuming that the landscape structure and the biology of the species would allow, in principle, long-term persistence of the metapopulation, its survival is threatened by two forms of metapopulation-level stochasticity, analogous to demographic and environmental stochasticities in the dynamics of local populations (Hanski 1991).

4.4.2.2.1 Colonization–extinction stochasticity. A metapopulation may go extinct, by chance, if it consists of a small number of local populations with a high risk of extinction: all local populations may go extinct at the same time. Colonization–extinction stochasticity poses a real threat to metapopulations living in networks consisting of only a few habitat patches. Thomas and Hanski (1991) suggest, based on both theoretical considerations and empirical data on butterflies, that a minimum of 10 to 15 well-connected habitat patches is required for long-term persistence when all patches are small and hence local populations have a high risk of extinction.

4.4.2.2.2 Regional stochasticity. Environmental variability, for instance weather effects, often affect the dynamics in and therefore the extinction and colonization probabilities of several local populations in a metapopulation. Such spatially correlated environmental stochasticity is called regional stochasticity. Typically, the strength of regional stochasticity decreases with increasing distance between local populations. Hanski and Woiwod (1993) demonstrated that the level of climate-induced synchrony in the dynamics of insect populations declined with distance in the UK, though a low level of synchrony remained up to almost 1000 km. Regional stochasticity increases the risk of simultaneous local extinctions and hence the risk of extinction of the entire metapopulation (Quinn and Hastings 1987; Gilpin, 1988 1990; Hanski 1989; Harrison and Quinn 1989).

4.4.3 Causes of extinction

In the above discussion of the mechanisms of extinction, we assumed no systematic environmental change, that is,

no change in the mean nor in the variance of the relevant biotic or abiotic parameters. This is the situation which biologists interested in the process of population extinction have traditionally assumed (Caughley 1994). In the real world, most environments change, and often in a complex manner. There is little doubt that the current escalation of the extinction rate is primarily caused by environmental changes, which may affect all the key parameters of the risk of extinction – current population size, equilibrium population size ('environmental carrying capacity'), population density, the mean and the variance of the population growth rate, the genetic structure of populations, and the size, number and distances apart of habitat patches and local populations in a metapopulation. Below, we discuss five kinds of environmental change and how they relate to the above-described mechanisms of extinction.

4.4.3.1 Loss of habitat

The most important reason for population extinctions, especially on small spatial scales, is habitat destruction (see Section 11). For instance, Temple (1986) has estimated that the following factors have significantly increased the risk of extinction of endangered bird species: habitat loss has affected 82% of the species, collecting has affected 44% of the species, interactions with introduced other organisms (predators, competitors) have affected 45% of the species, and 12% of the endangered bird species have suffered from other causes (many have been affected by several factors). At larger spatial scales, a metapopulation may go extinct when the density of habitat patches decreases below a critical threshold level (Hanski 1991; Nee and May 1992), even if some suitable habitat would still remain.

There is no 'safe' non-trivial level of habitat loss which would not increase the risk of extinction of some species. The reason for this bleak conclusion is that different species have different ecologies and individualistic patterns of spatial distribution; there are hardly any areas that would not be significant for the survival of some species, even if some areas have significantly more rare and endangered species than other areas ('hotspots'; Myers 1988). Prendergast *et al.* (1993) reached a similar conclusion from a comparison of distributional patterns in endangered animals and plants in the UK: no network of carefully selected reserves would suffice to protect all the species. In recent years, extinctions caused by habitat loss have been discussed most frequently in the case of tropical forests (Chapter 4.5), but habitat loss poses a severe threat in all biomes.

The risks associated with habitat loss are easier to assess when considering particular species, but the loss of biodiversity cannot be minimized just by a careful consideration of single species. Regardless of the context in which the consequences of habitat loss are assessed, loss of

natural habitats is the key ultimate cause of the present high rate of extinctions.

4.4.3.2 *Change in habitat quality*

Change in habitat quality, a less extreme environmental change than complete loss of habitat, may affect the mean and the variance of population growth rate as well as the equilibrium population size. Recent studies have emphasized likely changes in habitat quality due to climate change (Kareiva *et al.* 1993). A fundamental question in this context is whether species have enough time to migrate to new areas where conditions remain favourable, or have enough time to evolve locally (Lynch and Lande 1993). The rate of environmental change may well be faster than can be tracked by evolution in a local population, and some predictions about critical rates of environmental change beyond which extinction is inevitable have been made based on quantitative genetics theory. A different question is whether populations will respond by evolving or by changing habitat or geographic range.

A huge amount of empirical knowledge exists about the habitat requirements of a vast number of species, including most vertebrate species and many rare and endangered species. This knowledge, much of which remains as unwritten, personal experience of field biologists, is one of the most relevant sources of information for conservation biology (the challenge for conservation biologists is to collect, classify and maintain this information for easy access by all potential users; see Section 9). For many species, the consequences of even subtle changes in habitat quality can be confidently predicted on the basis of the existing knowledge about the species' requirements.

It is worth emphasizing in this context how superficial observations may lead to misleading conclusions. For instance, an increasing trend in population size over a short period of time is not a sufficient reason to expect low risk of extinction, as a small population may increase temporarily, by chance, even if its expected growth rate is below unity. In the same vein, the mere observation that a species is present in some particular habitat, even in large numbers, does not allow us to conclude that such populations are viable. There are examples in which the presence of a species in some (sink) habitats can only be maintained by immigration from other (source) habitats, where population growth is balanced by emigration (Pulliam 1988, 1994; Pulliam and Danielson 1991; Howe *et al.* 1991; Davis and Howe 1992). The possibility of such source-sink metapopulation dynamics should be taken into account while assessing population dynamic consequences of habitat loss and habitat change.

4.4.3.3 *Habitat fragmentation*

Habitat fragmentation may convert a previously more continuous population structure to a metapopulation

structure, with all or most local populations becoming so small that they have a substantial risk of extinction. Long-term persistence at the level of local populations becomes less likely, but metapopulation persistence still remains a possibility. One poorly understood but critical question is that of under which conditions a species that has evolved in a more continuous habitat will survive, or evolve to survive, in the more fragmented environment (see also discussion in Section 11.2.2.3).

A crucial factor in metapopulation survival is migration (dispersal) among habitat patches. Migration is often thought to have evolved to 'solve' an ecological problem, habitat instability, or a genetic problem, inbreeding depression (Dobson and Jones 1985; MacDonald and Smith 1990; Lidicker and Stenseth 1992). Strictly speaking, migration is expected to evolve whenever it increases individual fitness (Hamilton and May 1977). Of particular significance is the observation that individual selection does not necessarily lead to a migration rate that would maximize metapopulation persistence (Comins *et al.* 1980). High migration rate selected by group selection may occur in species that have evolved in patchy environments (Wilson 1980), but it is an open question whether such group selection will become a significant factor in environments fragmented by humans. The pessimistic but probably realistic viewpoint is that in recently and quickly fragmented landscapes, individual selection operating in local populations decreases migration rate further and thereby makes long-term persistence at the metapopulation level even less likely. Dempster (1991) describes some putative examples from endangered British butterflies.

Habitat fragmentation may increase the risk of extinction in many surprising ways. With decreasing fragment size relatively more of the habitat becomes affected by the edge of the habitat fragment. For instance, generalist predators invading the fragment from outside often impose an increasingly heavy mortality with decreasing fragment size on habitat specialist prey species (Wilcove 1985; Andrén and Angelstam 1988). Fine-scale habitat fragmentation may disrupt the usual foraging and breeding behaviour of species that have evolved to live in more continuous habitat, and thereby the population growth rate may become lowered (Rolstad 1991).

4.4.3.4 *Persecution and exploitation of populations*

Risk of extinction due to persecution and exploitation of populations has been, and continues to be, a special threat to some species, especially large vertebrates. Human hunters may have caused the extinction of large mammoths and other large-bodied Pleistocene mammals 10 000–20 000 years ago (Martin and Klein 1984). Large vertebrates generally attract the greatest public attention and the most detailed scientific scrutiny. Much of the theoretical study of the mechanisms of extinction (see 4.4.2) is also most

applicable to such species, and an extensive body of literature has been written on the subject of controlled exploitation of their natural populations to obtain a (maximum) sustainable yield (Getz and Haight 1989) and to avoid population extinction.

It is often assumed that large animals need large reserves because of their low population density. Large animals typically have lower densities than small ones (Peters 1983), though in many cases the observed low density is partly attributable to persecution. But equally importantly, many large species would survive in somewhat modified environments if they were not persecuted. For instance, in Finland most large-bodied birds and mammals, including both herbivorous and predatory species, have become more abundant in recent decades in a range of managed landscapes, apparently because they are no longer persecuted as widely as they used to be. Large reserves are needed if persecution outside the reserves cannot be eliminated. A point worth making in this connection, though not related to persecution, is that large reserves may often be needed most for the protection of the vast range of small-bodied specialist species which live in (networks of) microhabitats found only in large intact stretches of habitat (Hanski and Hammond 1995).

4.4.3.5 Change in the biotic environment

Another cause of extinctions is interaction with alien species, spread naturally or, more frequently, transported by humans to new environments. The spread of non-indigenous species is second only to habitat destruction in harming native communities (Simberloff 1995) (see also discussion in Section 11.2.2.4). The threats posed by non-indigenous species are especially grave on oceanic islands with small areas and specialized species (Atkinson 1989), though large area itself is no guarantee of survival: the red fox, an introduced generalist predator in Australia, appears to be the main cause of the extinction of several small marsupials (Dickman *et al.* 1993). Humans have also enhanced the spread of diseases and parasites, which may be responsible for more extinctions than is commonly believed (McCallum and Dobson 1995).

Human-induced extinctions of species on oceanic islands have occurred on a much larger scale than is generally recognized. Table 4.4-1 indicates that roughly 1% of bird species have gone extinct in historic times, most of them on oceanic islands. But this figure is a gross underestimate of the true number of island extinctions in recent times. Olson (1989) estimates that as many as one-quarter of the bird species that existed a few thousand years ago have already perished on islands under human influence. For instance, only three species of flightless rails remain, while hundreds most probably occurred on the thousands of islands in the Pacific in the past 2000 years (Olson 1989). We are rightly concerned about the imminent wave of mass extinctions in

tropical forests, but on oceanic islands a wave of mass extinctions has just occurred.

Hybridization with non-indigenous species and other forms of genetic introgression threaten large numbers of species in certain groups of birds, for instance ducks, and also mammals and fishes (Simberloff 1995).

4.4.3.6 Summary

In some cases a specific factor is known to have caused population decline, but in other cases no single cause can be identified. An example of the latter is the severe decline in the distribution and abundance of the European mink *Mustela lutreola*, once widely distributed in Europe, now surviving in less than a fifth of its original range with an estimated total population of 30 000 (Maran and Henttonen 1995). In this case, several factors are known to have contributed to the demise of the species in different places at different times: loss and fragmentation of habitat, loss of a key food source (the crayfish *Astacus astacus*), exploitation, competition with the introduced American mink *Mustela vison*, and hybridization with the European polecat *Mustela putorius* (Maran and Henttonen 1995). Compared with congeneric species, the European mink is an ecological specialist, and though widely distributed in Europe in the past, its occurrence may always have been relatively precarious. The European mink appears to be poorly adapted to cope with any kind of environmental change. In this respect it may exemplify many other specialized endangered species.

4.4.4 Predicting extinction rates

Predicting the expected lifetime of a population is a tremendously difficult and complex task as discussed in 4.4.1. Extinctions of particular species in particular environments can be predicted reliably only in those cases where there is an obvious environmental cause of extinction, be it habitat destruction, persecution or something else. In the absence of systematic environmental change, populations still face a risk of extinction. This is typically greater in the case of smaller populations, but in this case only statistical predictions of extinction are possible.

4.4.4.1 Single populations

An important first point to appreciate is that because of variation in population growth rates, a short record of increasing population size, especially in small populations, should not be accepted as sufficient evidence for long-term persistence (Lande and Orzack 1988). Secondly, simple models of population dynamics, with constant parameters and possibly no population regulation (density dependence), are not adequate for quantitative prediction of long-term dynamics, but such models may give valuable insight into the sensitivity of population growth rate and hence extinction proneness to modifications in age-specific fecundity and survival, age at maturity, etc. (Caswell 1978,

1989; Lande 1988a; Groenendael *et al.* 1988; Houllier and Lebreton 1986; Lebreton and Clobert 1991). Such information can be useful in indicating which management options are most likely to affect the risk of extinction (Pinero *et al.* 1984; Crouse *et al.* 1987; Lande 1988b; Menges 1990; Wootton and Bell 1992). These models are not yet used as widely as they should be in conservation biology. There is a demand for microcomputer programs in which such approaches have been implemented (Ferson and Akcakaya 1990; Shaffer 1990; Boyce 1992; Legendre *et al.* 1993).

Thirdly, classical models of population extinction are focused on demographic stochasticity (MacArthur and Wilson 1967). These models are of very limited use, because the impact of environmental stochasticity is overwhelmingly important in practically all natural populations. Furthermore, most models of demographic stochasticity ignore within-population heterogeneity, such as age structure, and the spatial extent of the population (Allée effect). Extinction models incorporating environmental stochasticity are potentially more useful, and several such models have been developed in recent years (Leigh 1981; Goodman 1987; Lande 1993; Foley 1994; Mangel and Tier 1994a, b). It is unfortunate that testing these models is difficult with the kind of data that are available and hence has rarely been attempted (Belovsky 1987; Foley 1994). A novel approach to estimating extinction rates from patterns of habitat patch occupancy in a metapopulation has been described by Hanski (1994a, b).

Fourthly, a particular difficulty in the prediction of extinction risk under environmental stochasticity is that the level of stochasticity assumed in the model is typically estimated from the past record of stochasticity (as reflected in the variability of population growth), over a relatively short period of time. Extinctions may often be triggered by novel sources of stochasticity, which could not have been anticipated from the past record. Mangel and Tier (1994b) make this point by observing that extinctions may often be caused by catastrophes – ‘unexpected’ environmental disturbances with a large impact on the population. An extreme possibility is that many of the extinctions in the past are due to catastrophes of various magnitude caused by meteorite impact (Raup 1991a). Mangel and Tier (1994a, b) have developed numerical methods to calculate extinction time from the knowledge of how birth and death rates depend on population size.

Finally, in a large assemblage of similar populations, extinction times are expected to be exponentially distributed, as we have already explained, which means that many populations go extinct very quickly while a few may last for a very long time. In this situation the average extinction time is a misleading statistic.

4.4.4.2 Metapopulations

Metapopulation models make predictions about metapopulation survival and expected lifetime in

fragmented landscapes. This may be the most relevant class of model for many environments extensively modified by humans. They may be used to draw recommendations about how landscapes should be modified to enhance metapopulation persistence (Hanski 1994a).

General metapopulation models indicate the conditions that must be met for long-term metapopulation persistence. Though not helpful in generating predictions for particular metapopulations, the qualitative conclusions are useful in directing attention to the factors that are likely to affect critically the survival of many species in fragmented landscapes. First, habitat fragments should be sufficiently large and located sufficiently close to each other to generate enough recolonizations to compensate for local extinctions. Second, the level of spatial correlation in environmental stochasticity (regional stochasticity) should be minimized. There is little that we can do with climate and weather conditions, which are the main cause of environmental stochasticity and are typically correlated over large spatial scales (for the effects on insect populations, see Hanski and Woiwod 1993). Often, however, the effects of weather are modified by local habitat quality. For instance, host plants for an insect species growing in different microhabitats may be more or less vulnerable to drought (Weiss *et al.* 1993). An obvious recommendation stemming from the general need to minimize regional stochasticity is then the following: in the case of multiple reserves, it may be better to include sites with variation in habitat quality, or to manage sites so that they retain a range of habitat qualities, rather than to aim at some single ‘best’ quality, which may be best in most years but fail badly under unusual circumstances. An additional advantage of having sites varying in quality is the possibility of increased genetic variation for stress-resistant traits in the metapopulation (Hoffmann and Parsons 1991).

Quantitative predictions about the risk of metapopulation extinction have to be based on models that incorporate the spatial locations of local populations and which allow explicit modelling of migration. Such models range in complexity from relatively simple incidence function models (Hanski 1994a, b) to complex simulation models (McKelvey *et al.* 1993; Hanski and Thomas 1994; Lahaye *et al.* 1994; Lamberson *et al.* 1994), possibly linked to Geographic Information Systems-orientated landscape descriptions (Akcakaya 1993). An ambitious example of the latter is the modelling of the northern spotted owl in North America (McKelvey *et al.* 1993). Model complexity is not necessarily a great virtue, however, and often simpler models are more practical in particular cases. In conservation, the main question is often to evaluate alternative scenarios of landscape change rather than to aim at accurate long-term predictions.

Regardless of the modelling approach adopted, one general difficulty remains. It is unlikely that the fragmented

environment in which the metapopulation now occurs will remain unchanged for long. Metapopulation dynamics necessarily occur on a relatively long time scale, and often it is doubtful whether a stochastic steady state between extinctions and colonizations will ever be reached. It is probable that a large number of threatened species occur in fragmented landscapes that are already inadequate for their long-term survival: the species still exist because they have not yet had time to go extinct (Hanski 1994c). How many such 'relict' or non-equilibrium metapopulations our fragmented landscapes presently harbour is an urgent question for conservation biologists.

4.4.4.3 Population viability analysis

The ultimate aim is to develop a procedure that will predict the expected lifetime of a population taking into account all the relevant mechanisms and causes of extinction, instead of focusing on some particular mechanism or cause. Such a procedure is known as Population Viability Analysis, PVA (Shaffer 1981, 1990; Gilpin and Soulé 1986; Soulé 1987; Boyce 1992). A general description of what constitutes a PVA is not possible, because any critical analysis involves an in-depth study of the biology of the focal species (or collection of relevant literature data) and is hence species-specific. Some 35 PVAs had been attempted by 1992 (Boyce 1992), though most of them have never been properly documented and published. The best known PVAs include those on the grizzly bear (Shaffer 1983) and the northern spotted owl (Marcot and Holthausen 1987; Lande 1988b) in North America.

An important element in Population Viability Analysis is the concept of Minimum Viable Population, MVP. Populations that are smaller than MVP are considered to be in imminent risk of extinction, hence the first priority in conservation must be to increase the population size and keep it above the MVP. Three values of MVP for three threats to survival are often mentioned in the conservation biological literature: MVP to avoid extinction due to demographic stochasticity (roughly 20 individuals; MacArthur and Wilson 1967); MVP to avoid inbreeding depression (roughly 50 individuals; Franklin 1980); and MVP to allow evolutionary change (roughly 500 individuals; Franklin 1980). The first value is based on simple models and is most probably an underestimate. To take into account individual variation in age, sex and other such factors, the demographic stochasticity MVP should be increased to at least 50–100 individuals (Ebenhard 1991). The latter two values refer to ideal populations in the population genetics sense. To take into account the difference between the actual and genetic effective population sizes, these MVPs should be increased to roughly 500 and 5000 individuals, respectively (Nunney and Campbell 1993).

These specific values of MVP and their justifications are discussed in the technical literature (Lande 1976, 1988a;

Franklin 1980; Lande and Barrowclough 1987; Boyce 1992). An important conclusion to emerge is that no universally applicable MVP sizes can be defended, and no conservation decisions should be based solely on such 'magic' numbers. None the less, as a general aim for the short-term conservation of any species, several hundreds of individuals should be maintained (Thomas 1990), as a minimum, and preferably in several localities (independent populations). More specific recommendations and the long-term conservation strategy must be based on knowledge of the biology of the species. Furthermore, if unusual events (catastrophes) are generally critical in population extinction (Raup 1991a; Mangel and Tier 1994b), the Minimum Viable Population concept has relatively little utility, and the only general conclusion that can be drawn safely is that smaller populations tend to have a shorter expected time to extinction than large ones.

4.4.5 Summary

It is obvious that the rate of extinction today is hundreds, if not thousands, of times higher than the natural background rate that prevailed before the beginning of rapid human population growth, a few thousand years ago. An examination of the mechanisms and causes of extinction reveals many issues and factors that are relevant to the study of extinctions. The process of extinction is examined above at two different scales: at the scale of single populations and at the scale of metapopulations (assemblages of local populations connected by migration). Several factors are particularly crucial to the survival or extinction of single populations: Allee effects (negative population growth in low density), demographic stochasticity due to randomness in births and deaths, environmental stochasticity due to weather effects and other such external randomness, and genetic factors. Theoretical studies dealing with all of these factors have uniformly concluded that the risk of population extinction increases as its size decreases. This conclusion is the most vital point of the summary above. Almost as important is the size of the habitat fragment in which the population is allowed to live. All of the factors important to single populations apply to metapopulations. However, the metapopulation concept brings several more ideas into play. The rate of migration into available habitat is important for species survival, as is the rate of formation of new habitats suitable for colonization. Colonization–extinction stochasticity and regional stochasticity (spatially correlated environmental stochasticity) are processes that are important to the dynamics of metapopulations.

Among the causes of extinction, environmental change is the most important, especially when it involves loss of habitat. In order to determine whether or not populations and metapopulations are truly in danger, models have been used to predict their fate. Population Viability Analysis

promises to predict for how long particular populations are expected to survive, taking into account all the known mechanisms of extinction. These models are valuable because they go one step further than the simple examination of the mechanisms and causes of extinction, and can be applied to specific situations and species. However, conservation strategies formulated to avoid extinction must not only include models that take into account the many factors that contribute to the decline of populations and species, but must also incorporate specific biological knowledge of the species in question.

4.5 Dynamics of biodiversity at the community and ecosystem level

4.5.1 Introduction

The main objective of this chapter is to emphasize the community and ecosystem context in which biodiversity originates, is maintained, and is lost. It will serve as an introduction to the processes that will be further developed in Sections 5 and 6.

The biodiversity present in any biotope is not a fixed attribute of that biotope but a dynamic attribute of communities and ecosystems. It is constantly changing, on both relatively short ecological time-scales and long evolutionary time-scales, and at any point in time it results from the past and present selective pressures exerted on the various organisms by the other components of the ecosystem, such as physicochemical factors, food, competitors, predators, parasites, diseases, mutualists, and the spatial and temporal variability of the environment. Thus these ecological factors play a central role in shaping local genetic and species diversity within populations, communities and ecosystems. The dynamics of biodiversity – the changes of biodiversity in time and space and the causes of such changes – cannot be understood without due consideration of the dynamics and organization of communities and ecosystems. A community- and ecosystem-centred viewpoint is indispensable in any management policy for natural or semi-natural habitats, whether nature reserves, national parks, forests or arable land.

Recently, much attention has been given to estimating the total number of existing species (e.g. May 1990, 1992; see Section 3.1.2). It is important to humankind to know the full diversity of their living companions on Earth but it is also necessary to use this framework of knowledge to investigate why there are so many species in the first place (Hutchinson 1959; MacArthur 1972; May 1973) and how their diversity is maintained. In other words, it is necessary to investigate both the species and ecosystem components of biodiversity: species exist in ecosystems and ecosystems are composed of species. Although species-level studies are still essential if one is interested in maintaining particular species (such as whales, elephants or the spotted owl) or

managing the genetic diversity of a given food crop species, it has been argued by some that, in general, the ecosystem component of biodiversity has been neglected and proposals to shift the emphasis from species to communities, ecosystems and landscapes have recently taken on a new intensity (Franklin 1993; Wiens *et al.* 1993; Barbault 1994, 1995).

The most sensible route towards understanding and predicting the dynamics of biodiversity is to develop fundamental and general ecological theory with the ultimate goal of linking diversity patterns, population dynamics, community organization and ecosystem functioning (Barbault and Hochberg 1992; Jones and Lawton 1995). Then, empirical observations and experiments to validate and test the theory become fruitful. A community ecology approach to biodiversity is especially useful because (1) it links population and conservation biology to ecological constraints; (2) it encourages integrated approaches that explicitly take into account the multifaceted nature of biodiversity dynamics, from individual organisms to ecosystems and landscapes; and (3) it links patterns and processes, by emphasizing the mechanisms that lead to the local build-up, maintenance, and erosion of biological diversity (Pimm 1991; Barbault 1992). Understanding how communities are assembled and maintained is necessary to assess the biological consequences of global change (Kareiva *et al.* 1993) and the way we can safeguard biodiversity (Western 1992). Today, conservation biologists face the same challenge as many community ecologists have faced for decades: identifying the processes and mechanisms that determine the diversity of communities and the relative abundance of species.

4.5.2 Competition and community organization

To grow, live and reproduce, every organism requires a favourable combination of abiotic environmental conditions – such as temperature, moisture, pH, salinity, current flow or soil structure, and a set of resources to provide it with energy and matter – mainly solar radiation, water and nutrients for plants, and food derived from other organisms for animals. The basic and obvious dependence of all organisms on such conditions and resources has naturally led ecologists to first seek an explanation of the composition and diversity of plant and animal communities in the local abiotic factors and resource availability. Communities were often considered and described as simple associations of species with similar requirements, and these associations did not necessarily involve any form of interaction among species in the communities.

A radically different and novel view of communities emerged from the mathematical models and experiments developed by Lotka (1925), Volterra (1926), Gause (1934) and others in the 1920s and 1930s. This theoretical and

experimental work focused on the dynamics of species interactions in simple model systems, and arrived at some strong results, in particular regarding competition between species. Competition refers to a negative mutual interaction between organisms resulting from the utilization of shared resources in limited supply. The models of Lotka, Volterra and Gause predicted that two species would not be able to coexist in the long term if they used the same resources, the more efficient competitor ultimately excluding the less efficient one. This prediction was successfully confirmed by Gause's experiments. It was later elevated to the rank of the 'competitive exclusion principle', and served as the foundation for a rich body of theory regarding competition as the major process leading to community organization and patterns. The importance of this principle was noted by many, notably Lack (1944), who pointed out that it should result in the partitioning of resources among species. As a corollary, the more the resources are partitioned, the higher the diversity of species. Hutchinson (1957, 1959) took Lack's reasoning one step further; he formalized resource utilization in terms of an ecological niche with measurable attributes in a multidimensional niche space. This formalization could now be applied to whole communities. Decisive developments of niche and competition theory were then made by MacArthur and Levins in the 1960s and early 1970s (MacArthur and Levins 1967; MacArthur 1972; May and MacArthur 1972), who formally related niche overlap and competition strength, and formulated the concept of limiting similarity. According to this, there is a maximum degree of niche overlap that can be tolerated between species for their continued coexistence.

Despite persistent controversies, niche and competition theory enjoyed a growing popularity among ecologists during the roughly 30 years that followed World War II. Innumerable studies applied its principles and concepts to the interpretation of patterns within communities. Several factors can explain its success:

- The theory provided explanations for the structure and species diversity of communities in terms of a simple lower-level process that was clearly identified and demonstrated by both mathematical models and laboratory experiments. Contrary to the views that were popular at the turn of the century, emphasizing the role of geographical and historical factors acting on broad spatial and temporal scales, this could reduce species diversity to small-scale interactions among component species. As in other sciences, this reduction power was a compelling attraction of the theory.
- Interspecific competition within communities is a simple extension of intraspecific competition within populations, both conceptually and in its mathematical formalization in models. Competition

among individuals of the same species was increasingly recognized as a necessary process in the stabilization or regulation of natural populations, hence competition was likely also to be important among individuals of different species.

- The empirical delimitation of communities by ecologists unconsciously favoured the search for competition as compared with other types of interactions such as predation and mutualism. Biologists and ecologists have the natural tendency to concentrate on particular taxonomic groups because the systematics, biology, ecology and study methods of taxonomically related species are also related. Competition is likely to be more frequent among species that use similar resources, hence also among taxonomically related species.
- Although science strives for objectivity, it can never be impervious to ambient ideology. In a society governed largely by competition relationships, it is inevitable that human beings tend to find the image of this competition in the natural world. This may in part explain why mutualism received so little attention compared with competition.
- Last but not least, competition is the only elementary interaction that results in a simple, potentially universal form of community organization. MacArthur (1972) compared the order generated by competition in communities to the formation of a crystal: competition tends to lead to a regular spacing of the species' niches, to a complementary utilization of available resources by the various surviving species. MacArthur went even further, for he showed that competition generates not only structure, but also functional properties at the community level — namely, competition results in a community that optimizes the fit between overall resource utilization and resource production (MacArthur 1970, 1972; Gatto 1990). Therefore, competition theory is able in principle to predict the number, identity and relative abundances of species in a community (MacArthur 1972; Tilman 1982).

The power, consistency and simplicity of niche and competition theory has exerted a considerable attraction on generations of ecologists. Since the theory predicts niche differentiation and resource partitioning among species at equilibrium, all forms of niche differentiation and resource partitioning have been looked for, and found, in natural communities. These forms include food partitioning according to prey size or prey type; temporal segregation during the day or the year, horizontal and vertical spatial segregation; complementarity between several niche dimensions; regular spacing of morphological characters such as body or beak size; and complementary

biogeographical distributions, but other patterns have also been interpreted in the light of the theory, such as the lower species/genus ratios (or average numbers of species per genus) on islands as compared with continents.

As is often the case, the strength of a theory turns eventually into a weakness. So many patterns in so many communities were interpreted as evidence for competition that the theory threatened to become a dogma. In the late 1970s and the 1980s, a number of scientists questioned these interpretations and submitted them to an intense statistical scrutiny. Rather than searching for patterns confirming the predictions of competition theory, they argued, one should instead try to falsify the null hypothesis that communities are random assemblages of independent species. Thus patterns have to be tested against *ad hoc* 'neutral' or 'null models' simulating communities as they would appear in the absence of interspecific competition. The first application of this type of approach dates back to Williams (1964) and Simberloff (1970), who conclusively established that the lower species/genus ratios on islands were statistical artefacts due to sampling of a smaller number of species. Simberloff and others then applied their 'null model' approach to the other patterns taken as evidence for the role of competition in communities (Strong *et al.* 1979; Connor and Simberloff 1979; Simberloff and Boecklen 1981; den Boer 1985). They almost invariably failed to detect any significant pattern and concluded that communities were likely to be random assemblages of independent species.

It soon appeared, however, that those 'null' models were very sensitive to hidden underlying assumptions, that they incorporated some competitive effects implicitly, and, accordingly, that the power of the tests was often so low that it was very difficult, indeed sometimes impossible, to reject the null hypothesis (Diamond and Gilpin 1982; Colwell and Winkler 1984; Loreau 1989b). Other, more powerful 'null' models were elaborated and successfully revealed significant patterns consistent with competition theory (Lawlor 1980; Gilpin and Diamond 1982; Schluter and Grant 1984; Schoener 1984; Loreau 1989b; Pimm and Gittleman 1990). Although some (but by no means all) community-wide patterns resisted this statistical scrutiny, the 'null model' controversy was beneficial in that it contributed greatly to relativize the role of competition in community organization. First, it forced community ecologists to view competition as one explanatory hypothesis among others. Sometimes even significant niche differences at one trophic level may in part reflect structure at the lower trophic level (Loreau 1994); only in rare cases have variations in resource availability been explicitly factored out (Schluter and Grant 1984). Second, significant patterns were usually detected only among a few closely related or dominant species and tended to vanish when large and heterogeneous assemblages of species were

considered (Gilpin and Diamond 1982; Loreau 1989b). Therefore, competition is unlikely to be the sole or major force structuring large communities.

One limitation inherent in the analysis of patterns is that it does not directly provide insight into the processes generating the patterns; the influence of a process such as competition is inferred indirectly from its predicted long-term consequences. Another approach used to test competition theory more directly has been field experimental manipulations. Field experiments, notably on interspecific competition, developed dramatically during the 1970s and 1980s. Although technically demanding, time-consuming and difficult to interpret, they often offer unique opportunities to test theories and processes under the conditions of the real, heterogeneous and fluctuating world. Competition between species has usually been tested by removing or adding populations and monitoring the responses of the other species. Schoener (1983) reviewed 164 field experimental studies on interspecific competition, and found that 90% of them had demonstrated the existence of interspecific competition. In a similar but more selective review of 72 studies dealing with a total of 527 field experiments, Connell (1983) found that interspecific competition was demonstrated in most of the studies and 43% of the experiments. In a meta-analysis of field competition experiments, Gurevitch *et al.* (1992) found that competition had a large effect overall, but with a great deal of variability among organisms.

Despite some discrepancies, these reviews do suggest that current interspecific competition is widespread. Its high percentage occurrence in the studies reviewed should not, however, be taken as representing its actual prevalence in natural communities. It is very likely that the species used in most experiments were chosen precisely because they were expected to compete, and positive results demonstrating competition were more readily reported and accepted for publication than were negative results failing to demonstrate significant effects. As Begon *et al.* (1990) put it, 'Judging the prevalence of competition from such studies is rather like judging the prevalence of debauched clergymen from the "gutter press"'. In addition, some groups of organisms are much less likely to compete than others (Gurevitch *et al.* 1992). Strong *et al.* (1984) reviewed studies on interspecific competition among phytophagous insects, and found that this was demonstrated in 41% of the studies, but only in a very small proportion of the possible pair-wise interactions. Interspecific competition may be especially rare in the group of phytophagous insects, as other data suggest (Lawton 1984). Lastly, while field experiments showed that competition is a significant force in many communities, they often did not show complete competitive exclusion of one species by another and, as far as is known, never showed regulation of species diversity by competition.

Therefore, once analysed critically, the recent evidence from both the 'null model' and field experimental approaches suggests similar tentative conclusions on the role of competition in community organization:

1. Interspecific competition plays some role in natural communities in agreement with the theory. It is relatively widespread, and it does seem to constrain local species diversity by limiting niche overlap among related species.
2. However, it is highly unlikely to explain the full structure and species diversity of communities, especially of large and heterogeneous communities. Even when it is important, it may significantly affect only a small proportion of the species interactions. It should mainly affect species with closely related niches, and dominant species reaching high enough densities (Hanski 1982; Loreau 1992, 1994).
3. Interspecific competition also varies greatly in importance from community to community. It tends to be more important in communities of large-bodied, territorial vertebrates and sessile organisms competing for space, and in stable environments, than in small-bodied vagile invertebrates and in temporary or disturbed environments (Schoener 1986).

The reason why competition plays a more limited role than originally envisaged in the theory is rather straightforward: the theory was built from simple model systems and simplifying assumptions that are not encountered in nature. The theory implicitly assumed a closed, homogeneous, constant environment, and the absence of interspecific interactions other than competition. In nature, organisms live in open, heterogeneous, variable environments, and have various kinds of direct and indirect interactions with other organisms. We shall now consider how these other interactions and environmental conditions influence the structure and species diversity of communities.

4.5.3 Predation and mutualism as diversity-maintaining processes

As an additional source of mortality, predation usually has obvious direct negative effects on prey populations: it tends to reduce population size, generate instability and population cycles (May 1973), and hence increase the risk of population extinction. Other forms of exploitation of one organism by another, such as herbivory, parasitism and disease, have similar negative effects. Predation can also have indirect negative effects on prey populations. If two prey species share the same predator, consumption of one species contributes to increase the predator population and

hence the predation pressure on the other species. In this way, predation mediates an indirect negative interaction between prey species, which has been variously called 'apparent competition' (Holt 1977, 1984) or 'competition for enemy-free space' (Jeffries and Lawton 1984). Through such negative effects, predation and other forms of exploitation tend to reduce local prey or host species diversity.

Yet exploitation can also be a powerful factor enhancing species diversity. Darwin (1859) already noticed that the mowing of a lawn or its browsing by large herbivores could maintain a higher richness of plants than occurred in its absence. Paine's (1966) experiment in the rocky intertidal zone of the Pacific coast of North America established conclusively the importance of predation in the maintenance of prey species diversity. After removal of the top carnivore, a starfish, the number of prey species collapsed from 15 to eight, and a single species, a mussel, covered almost the whole experimental site. The top predator played the role of a keystone maintaining the arch formed by the entire community, hence the name of 'keystone species' to designate such organisms (Paine 1969; see Box 5.2-1 for the modern definition). The mechanism underlying the maintenance of species diversity by predation was made clear experimentally by Lubchenco (1978) with a herbivorous periwinkle snail in another rocky intertidal region. She showed that the periwinkle increased algal diversity when its preferred algal species was competitively dominant, while it decreased algal diversity when its preferred algal species was competitively inferior. Thus predation enhances prey diversity when it counteracts interspecific competition among prey species. By selectively reducing the populations of competitively dominant species, it prevents competitive exclusion of the inferior species and hence benefits the latter indirectly. On the other hand, when predation is heavier on competitively inferior species, its negative effects add to those of competition and further contribute to the exclusion of these species, thereby reducing prey diversity. Note that predation-maintained diversity does not always imply the action of a single keystone predator: sometimes it results from the combined action of several predators, each of which has only a weak effect. This has been called 'diffuse predation' (Menge and Lubchenco 1981; Menge *et al.* 1994).

For a predator, it will be advantageous to specialize in prey that are abundant and not very resistant to predation. Since there is generally a trade-off between competitive ability and resistance to predation (which requires resource allocation to the production of physical, chemical or behavioural defences), competitively dominant prey may often be less protected against predation than are other species. Therefore predators contributing to the maintenance of prey species diversity should not be an exceptional occurrence. Indeed, since Paine's experiment, keystone predators have been found to be common in intertidal communities (Paine 1994; Menge *et al.* 1994; Menge

Box 4.5-1: Why are there so many plant species in tropical rain forests?

The plant diversity of tropical rain forests is unrivalled. In the case of plants, for example, in Amazonian Ecuador, one hectare supports 473 tree species (Valencia *et al.* 1994) while, in Europe, North America and Asia, temperate forests collectively cover 420 000 000 ha yet support just 1166 tree species (Latham and Ricklefs 1993). Although poorly studied, herbaceous understorey plants also form very diverse communities. The highest plant species density yet recorded, 365 species in 0.1 ha, was realized in the only complete enumeration of all plants in a tropical rain forest (Gentry and Dodson 1987). A variety of ecological processes contribute to this diversity, processes that in some cases are being disrupted by human activities.

The sombre understoreys of tropical rain forests are punctuated by openings created when a tree falls, perhaps dragging several of its neighbours to the ground. The resulting spatial heterogeneity provides the potential for plant species to specialize in different light intensities from the open centre of a treefall to the deeply shaded understorey, to different positions along the fallen tree associated with differences in substrate stability (Núñez-Farfán and Dirzo 1988), or to different soils from exposed clays where roots tip up to rich humic material where canopy leaves and branches decompose (Denslow 1987; Orians 1982). There is some empirical evidence for the existence of a variety of life-history types among tropical tree species in relation to treefalls: light-demanding pioneer species tend to germinate, establish and grow to maturity only in gaps, while non-pioneer or climax species tend to germinate and establish primarily in the shade, often attaining maturity when juveniles are released from suppression (Martínez-Ramos *et al.* 1989; Alvarez-Buylla and Martínez-Ramos 1992). Human alteration of the natural disturbance regime is then likely to reduce the number of coexisting species (Alvarez-Buylla and García-Barrios 1993). However, most plant species seem to respond similarly to treefall gaps, their performance improving with light levels (Denslow *et al.* 1990; Osunkoya *et al.* 1992). Preliminary data suggested that fewer than 25% of tropical rain forest species depend on light gaps for their performance and survival (see Martínez-Ramos 1994). But in repeated rigorous surveys of the performance of 250 000 trees in Panama, the great majority of species survived well and grew slowly both in treefall gaps and in the deeply shaded understory, and just 5% were specialized to treefall environments (Welden *et al.* 1991). Thus, spatial heterogeneity associated with treefalls seems to make a small contribution to tropical forest plant diversity.

The depredations of plant pests may be of greater significance. Plant pests include pathogens, insects and vertebrates that consume plant tissues. Even relatively small levels of insect damage are important because they promote pathogenic infection (Dirzo 1987). Plant pests act to increase plant diversity when they attack a superior competitor and thus prevent competitive dominance, or when they eliminate the dense congregations of seeds and seedlings that accumulate beneath fruiting plants, thus preventing regeneration of conspecifics in close proximity (Gillett 1962; Janzen 1970; Connell 1971). Herbivores do appear to reduce seed and seedling congregations in tropical forests (Clark and Clark 1984; Howe 1990). When herbivorous mammals are extirpated by hunting or habitat destruction (Dirzo and Miranda 1991) or excluded experimentally (Terborgh and Wright 1994), the dynamics of plant regeneration are altered dramatically, with large increases in the total density of seedlings and the development of single-species seedling carpets beneath fruiting plants. The movements of pathogens and insects from nearby adult plants may also reduce the survivorship and growth of saplings as large as 8 cm in diameter at breast height (Hubbell *et al.* 1990). Plant pests clearly alter the regeneration of tropical forests, and may contribute to maintain their high plant diversity.

It is unclear, however, how pest pressure might be related to the strongest gradient in plant diversity observed among tropical forests. The diversity of all vascular plant life forms increases with rainfall throughout the tropics (Whitmore 1975; Hall and Swaine 1981; Gentry 1988; Clinebell *et al.* 1995). Gross primary production of tropical forests also increases with rainfall (Brown and Lugo 1982; Jordan 1983; Medina and Klinge 1983). Plant diversity is greatest in the most productive tropical forests. There are at least two possible explanations of this pattern. First, rates of tree turnover and treefall formation are higher in more productive forests, leading to a more heterogeneous environment and thence to higher diversity (Grubb 1986; Phillips *et al.* 1994). We have seen, however, that just a few percent of tropical forest plant species are specialized to this type of spatial variation (Hubbell *et al.* 1990). Alternatively, the most productive forests occur where rainfall and soils are most favourable for plant growth. Here, the physiological requirements for moisture and mineral nutrients are fulfilled for the greatest number of species and relative allocation can be shifted from roots to photosynthetic functions, permitting the greatest number of species to maintain a positive carbon balance and regenerate from the shaded understorey (Gentry and Emmons 1987; Wright 1992).

Box 4.5-1 cont.

The clear-cutting of large tracts of tropical forest has received wide publicity (Myers 1992). Characteristics of the remaining forests and human impacts on those forests are less widely appreciated. Dry and moist tropical forests are often most suitable for agriculture and have suffered the most rapid rates of deforestation throughout the tropics (Brown and Lugo 1982). Fortunately, several tracts of the tropical rain forests that maintain the greatest diversity of plants and other taxa are relatively intact. Herbivorous mammals are, however, being hunted to local extinction over large areas of tropical rain forest with potentially grave consequences for forest regeneration and the ongoing maintenance of plant diversity (Redford 1992). The wetter tropical forests that harbour the greatest plant diversity are also coming under increasing pressure from expanding human populations throughout the tropics. Conservation and the development of technologies appropriate to sustainable use of these most diverse forests are urgently required.

1995). In grasslands, mowing or grazing by mammal herbivores are generally indiscriminate, but they affect most strongly those plants that grow tall and fast, and thus have the same effect as selective predation on competitive dominants. Grazing by sheep has long been known to maintain high plant species diversity and prevent the successional conversion of grasslands into forests. Grazing and mowing are being used in the conservation of threatened chalk grasslands in Europe (Bobbink and Willems 1988).

Two other powerful mechanisms contribute to the maintenance of prey species diversity by predation. The first is prey switching, in which the predator feeds disproportionately often on food items that are common, and switches its preference when those food items become rare. This type of frequency-dependent predation always acts selectively against abundant prey, and thus enhances the stability and diversity of prey communities (Murdoch and Oaten 1975). Frequency dependency is also likely in host mortality induced by parasites and disease because of increased transmission rates at high host density, leading to an increased potential for host species coexistence (Holt and Pickering 1985; Anderson and May 1986; Combes 1995).

The second powerful mechanism by which predation can maintain prey species diversity is spatial aggregation of predation. This is generally known to exert a strong stabilizing effect on predator-prey or parasite-host interactions (May 1978; Beddington *et al.* 1978; Hassell 1978; Hassell and May 1988). It has also been put forward as a key factor in maintaining the high richness of tree species in tropical forests. Janzen (1970) and Connell (1971) proposed that predation on seeds and seedlings is disproportionately high close to adult trees because host-specific consumers tend to concentrate in areas where food density is highest. Since seed density drops rapidly as the distance from the adult tree increases, tree recruitment should be highest at some intermediate distance from the adult tree, where the balance between decreased seed density and increased seed survival is most favourable. This hypothesis helps to explain both the high species diversity and the spatial heterogeneity

characteristic of tropical forests, and has received support from a number of studies (Box 4.5-1).

Species other than predators can play the role of keystone species and contribute to the maintenance of species diversity. A keystone species can be defined more generally as a species whose impacts on its community or ecosystem are large, and much larger than would be expected from its abundance (Power and Mills 1995; Sections 5 and 2.3 and Box 5.2-1). Although the concept has sometimes been used too broadly or vaguely (Mills *et al.* 1993), it usefully places emphasis on species that have a small biomass and yet play critical roles in their communities or ecosystems, and which, therefore, should be included in conservation priorities (Bond 1993). It also reminds us of the importance of non-trophic interactions in communities and ecosystems. Many species are important to others not because they feed upon them or are fed upon by them, but because they provide their physical environment ('structural species' – Huston 1994), modify their physical environment ('habitat modifiers' or 'ecosystem engineers' – Owen-Smith 1987; Jones *et al.* 1994) or provide them with diverse benefits such as protection or dispersal (various mutualists).

Mutualism, an interaction between organisms that brings mutual benefit, has received relatively little attention in ecology; yet it is extremely widespread and important to the persistence of organisms and populations, hence to the maintenance of biodiversity. 'A very significant proportion, probably most, of the world's biomass depends on it – for example, the dominant organisms of all grasslands and forests (plant roots intimately associated with fungi in mycorrhizae), and corals (animal polyps containing unicellular algae) are mutualists. Most rooting plants have mutualistic mycorrhizae; many flowering plants depend on insect pollinators; and a very great number of animals possess guts which contain a mutualistic community of microorganisms' (Begon *et al.* 1990). Mutualistic relationships are very diverse, and differ widely in their degree of dependency, ranging from facultative interactions, through interactions that are obligate for one or both partners, to

symbiosis, i.e. an intimate physical association between organisms (such as lichens or corals).

Facultative mutualism may be more frequent than previously thought. Recent research in African lakes, for example, shows that it is common in many feeding guilds of fishes in the form of exploitative co-operation (Takamura 1983; Hori 1987, 1991, 1993; Yuma 1993). Co-operation was also observed in their reproductive habits. Mutualistic relationships were even suggested between benthic animals and benthophagous fishes in these lakes (Nakai 1993). These kinds of facultative mutualisms can promote biological diversity (Matsuda *et al.* 1993, 1994).

Many plants depend on animals for their pollination and seed dispersal. Such obligate mutualistic relationships are inherently fragile when they are specialized; if the population density of one of the partners drops below some threshold, the two partners may be driven to extinction (May 1976; Wolin 1985). Some of the species involved in these interactions may be keystone species, which contribute to the maintenance of a large number of other species in tropical rain forests (Gilbert 1980). As an example, the canopy tree *Casearia corymbosa* in Costa Rica supports several obligate fruit-eaters that depend on it almost entirely during the 2–6 week annual scarcity of fruit (Howe 1977). The loss of that tree species is expected to lead to the disappearance of several bird species, which would in turn have consequences for the other tree species whose seed they disperse during the rest of the year (Howe 1977).

Mutualistic interactions, in particular symbiosis, also produce some new biological traits that cannot be attained by either of the partners alone. These 'synergetic traits' are biological 'innovations' which contribute to enhance biological diversity. For example, neither termites nor their symbionts (bacteria, protozoa and fungi) alone could process the vast amount of litter (dead plants) in tropical forests and savannahs. But in association with each other, they become 'superdecomposing machines' in tropical terrestrial ecosystems (Brian 1978; Higashi and Abe 1993). Progress in symbiosis may lead to a closer biological association accompanied by gene transmissions and thus changes in the DNA, and even ultimately to unification (fusion). This process is a source of novel genetic diversity.

4.5.4 How species are interdependent through manifold indirect interactions

Ecosystems are very complex systems in which many different organisms and species interact. Each organism interacts directly with only a limited number of other organisms through such processes as interference competition, predation and mutualism, but the consequences of its direct interactions extend far beyond those particular organisms, because these in turn interact with still other ones, and so on. The ecosystem can thus be viewed as a complex interaction network in which each

organism or species transmits indirect effects to all other organisms and species (Higashi and Burns 1991). It is the whole network of interactions that results in the overall properties of the ecosystem, such as energy flows, nutrient cycling and trophic structure. The importance of indirect interactions in communities and ecosystems is an issue that has far-reaching implications for the maintenance and conservation of biodiversity. If indirect interactions are typically strong, the loss or addition of a species may have dramatic, possibly unpredictable, consequences on unrelated species. Simple theoretical arguments suggest that distant indirect interactions should generally be weaker than proximate or direct interactions for a system to be stable and preserve its structure (Levins 1970; May 1973; Simon 1977). The hierarchical nature of many ecosystem processes (O'Neill *et al.* 1986) tends to meet this constraint, at least at large spatial and temporal scales. However, this by no means precludes the importance of indirect effects, especially at small scales and within subsets of species.

That indirect interactions can be important should be obvious from the fact that most of the simple interactions we have so far discussed are actually indirect. Competition in its pure form of exploitation competition is an indirect interaction mediated by a shared resource: the competitors may never encounter each other. Apparent competition is an indirect interaction mediated by a shared predator. Keystone predators owe their keystone nature to the very fact that they benefit indirectly prey which they do not consume. But several other forms of indirect interactions among a few species have been identified. Thus, two competing species can be indirect mutualists if they both compete more strongly with a third species or if their resources themselves compete (Levine 1976; Lawlor 1979; Vandermeer 1980). In a plant–herbivore–carnivore food chain, the plant and the carnivore are indirect mutualists because the plant indirectly provides the food on which the carnivore feeds, while the carnivore reduces the herbivore density, hence the grazing pressure on the plant.

The latter form of indirect mutualism seems to be frequent and important enough to evolve into direct mutualistic relationships, as in the ant–acacia mutualism (Janzen 1967). Plants are not passive interactants but sometimes actively affect the other members of the system. When they are infested by herbivorous invertebrates, they can emit 'infochemicals' (information in the form of chemical substances) which stimulate diverse interactions. For instance, some plants release a 'cry substance' upon being attacked, which acts as an agent that summons the natural enemies of the herbivores (Dickie *et al.* 1990; Takabayashi and Dickie 1993). Furthermore, an attacked plant may cause its uninfested neighbouring plants to initiate defensive reactions (Bruin *et al.* 1991). This can result in 'hotspots' of relative immunity to the herbivore formed by undamaged plants in the neighbourhood of

the damaged plants, due to induced indirect defensive actions.

Exploitation competition can also be much more indirect, asymmetrical and subtle than traditionally considered. Competitive interactions occur between herbivorous insects that are very distinct taxonomically and utilize different parts of the shared host plant in different ways, through changes in the quality and quantity of the host plant. Even insects feeding at different times or on different parts of a plant may have a substantial effect on the quantity or quality of their respective available resources. For instance, one species attacking the host plant early in the season can influence the performance or abundance of another species attacking late in the season, through changes in host quality. Such indirect effects mediated by the resource are more common than previously thought, notably in plant–insect systems (Faeth 1986; Loreau 1989a; Hunter *et al.* 1992). In general, complex interspecific interactions require the species involved to encounter and deal with a range of variations in interactions through time and space, thus promoting the diversity of their behaviours and adaptations.

The above examples concern indirect effects mediated by simple trophic interactions. Some important indirect interactions are much more distant and are mediated by ecosystem processes. In particular, nutrient cycling represents a circular causal pathway in ecosystems which transmits positive indirect effects to all ecosystem components. While direct trophic interactions are negative for the consumed organisms, the positive indirect interaction mediated by nutrient cycling may result in a net gain in productivity for those consumed organisms. As a rule, this occurs when consumers act to accelerate the circulation of nutrients within the ecosystem and their consumption is moderate (Loreau 1995). Thus, under these conditions, herbivores increase plant productivity, in agreement with the ‘grazing optimization hypothesis’ (Owen and Wiegert 1976; McNaughton 1979; Hilbert *et al.* 1981; DeAngelis 1992).

Given that indirect effects are certain to occur in communities and ecosystems, what is their frequency and relative importance compared with direct effects? Menge (1995) recently reviewed experimentally based studies from 23 rocky intertidal biotopes to answer this question. Although he considered only indirect effects mediated by simple trophic interactions, he identified 83 different kinds of indirect effects grouped into nine general types, of which keystone predation and apparent competition were most common, and he found that indirect effects accounted for 40–50% of the change in community structure resulting from experimental manipulations, with a range of 24–61%. Thus indirect interactions clearly are diverse, frequent and influential in intertidal communities. Such figures are unfortunately lacking for other communities.

One property of indirect effects is that they are often very sensitive to the values of the direct interaction

parameters (Bender *et al.* 1984; Yodzis 1988). Therefore, many of them are in principle difficult to predict, not only quantitatively but even qualitatively (Yodzis 1988). This means that the loss or addition of a species can have unpredictable effects on unrelated species, and potentially alter the whole interaction network. Past experience of species introductions tells us exactly this (Courtenay and Robins 1989; Carlton and Geller 1993). However, knowledge of the ecology of similar communities in conjunction with limited experiments and adequate analysis methods offers the promise of greatly enhancing our ability to predict significant indirect interactions (Wootton 1994; Menge 1995).

Food-web theory also offers some predictions on the potential effects on the rest of the community of species removal or addition. Pimm (1991) predicted that the species composition of complex food webs will be most resistant (least sensitive) to the loss of species at their base (plant species, for instance) and least resistant to the loss of their top predators. The results are expected to be reversed for simple food webs (Figure 4.5-1). ‘Complex communities should be most sensitive to the loss of species from the top of the food web, because secondary extinctions propagate more widely in complex than in simple communities. Simple communities should be more sensitive to the loss of plant species than complex communities, because in simple communities the consumers are dependent on only a few species and cannot survive their loss. The introduction of trophically generalized species should have profound effects on community composition, because such species can eliminate many of the species on which they feed. Specialized species should produce fewer changes’ (Pimm 1991). However, the evidence for these theoretical predictions is anecdotal and open to alternative explanations. For instance, Pimm compares the consequences of the loss of plant species on oceanic islands and on continental landmasses and notes that the simpler island food webs seem less resistant to plant loss. But this difference may also be due simply to an insular effect. Thus our ability to predict the long-term consequences of species losses or introductions on existing communities is still limited due to the manifold potential indirect interactions among species. This commands caution in attempts to manage biodiversity.

4.5.5 *The role of spatial and temporal variability of the environment in the maintenance of biodiversity*

Although the natural world is obviously heterogeneous and variable, until recently most ecological theories have been based on a view of a homogeneous and constant world inherited from classical physics. The implicit rationale for this simplification is that the behaviour of a homogeneous and constant system should approximate the average behaviour of a spatially and temporally variable system. While this is true for some processes considered at

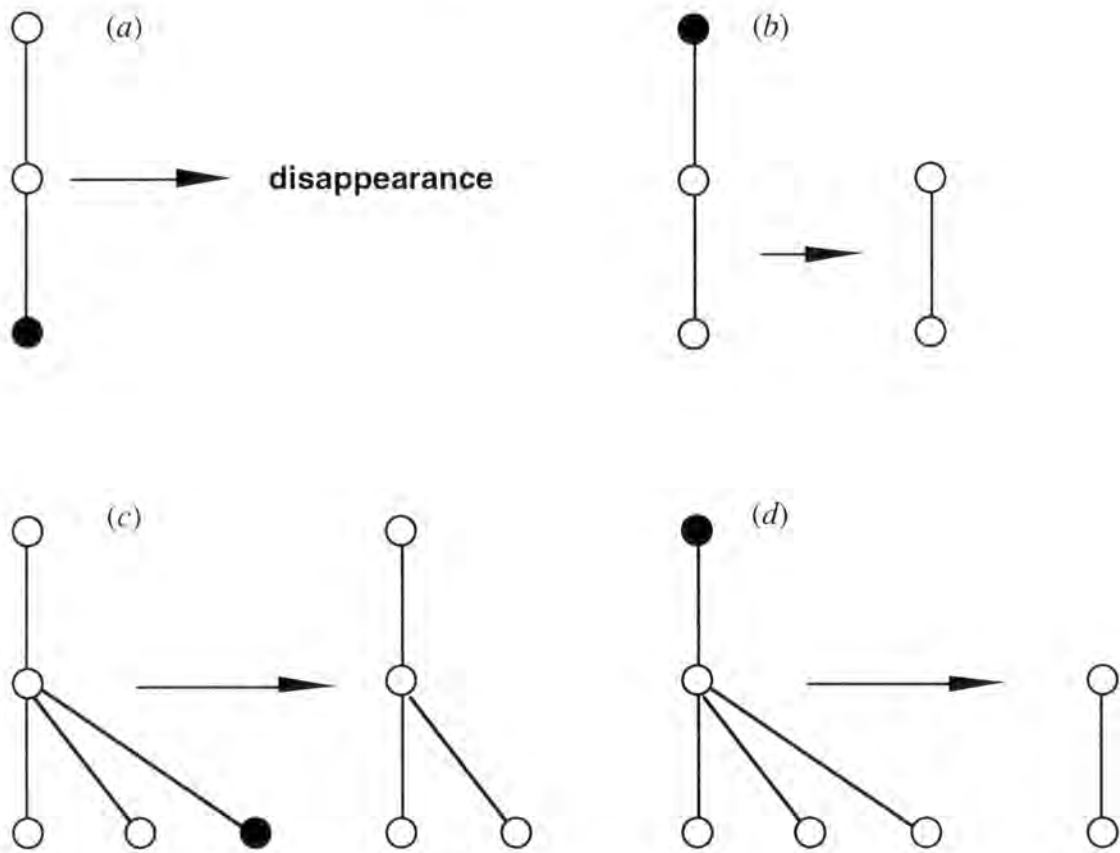

Figure 4.5-1: The effects of the elimination of one species on other species depends on the structure of the trophic network and the position of the species in the network. The extinction of a plant species at the base of a simple trophic chain can result in the disappearance of the entire network (a), while the removal of a predator from the top of the same network will have no effect (b). On the other hand, if the trophic network is more complex, the loss of a low level plant species can take place without consequences (c) whereas loss of a predator (d) can indirectly result in the extinction of several plant species (after Pimm 1991).

appropriate scales, it also hides important non-linear dynamic processes responsible for the coexistence of species. During the last two decades, spatial and temporal variability of the environment has increasingly been recognized as a major determinant of species diversity in communities and ecosystems.

As already mentioned above, spatial heterogeneity has generally been found to exert a strong stabilizing effect on predator-prey and parasite-host interactions (May 1978; Beddington *et al.* 1978; Hassell 1978; Hassell and May 1988). Similarly, it has been found often to increase the potential for coexistence between competing species (Hanski 1981; Ives and May 1985). It is considered by some to be one of the major factors explaining patterns of species diversity among communities at a regional scale, notably the common hump-shaped relationship between diversity and productivity (Rosenzweig and Abramsky 1993). It is regarded as being particularly important in plants. Since most plants depend on the same basic limiting resources – light, a few nutrients and space – the potential for niche differentiation seems to be much more limited for plants than for animals. How then to explain the

coexistence of so many competing plants, in tropical forests for instance?

Environmental heterogeneity is one of the possible answers: it can intervene through several mechanisms. First, the competitive ability of plants competing for nutrients is determined by the ratio in which the various nutrients are available; if this nutrient ratio is spatially variable, different plants will persist in different places, so that plant diversity can be high over a large enough area (Tilman 1982). Second, sessile organisms such as plants deplete resources only in a finite volume around them; if nutrients limit plant growth, competition for nutrients among plants will hinge upon the rate of nutrient transport between the local nutrient depletion zone around each plant's root system and the overall nutrient pool in the rest of the soil, so that many species can coexist at moderate transport rates (Huston and DeAngelis 1994). Environmental heterogeneity is then created by the organisms themselves; it is not a passive property of the environment. Third, even if the environment itself is homogeneous, the dynamics of colonization of vacant sites and individual death for sessile organisms such as plants

are likely to prevent complete monopolization of space by a single species and result in a shifting mosaic of diverse species, provided that there is a trade-off between competitive ability and colonization ability among them (Tilman 1994).

Temporal variability of the environment plays an equally important role. The equilibrium paradigm that dominated ecology until roughly twenty years ago has since then been challenged and eventually complemented by non-equilibrium concepts (DeAngelis and Waterhouse 1987; Huston 1994). There are several ways by which a variable environment can enhance species coexistence. If the time scale of significant environmental changes (such as seasonal changes in temperature or resource availability) is roughly the same as that of competitive exclusion between species, and if various species thrive under different environmental conditions, no species will ever be able to bring competitive exclusion to completion, so that many species can coexist on the same resource without reaching a competitive equilibrium (Hutchinson 1961; Chesson 1986). Levins (1979) showed that permanent, indefinite non-equilibrium coexistence is possible among species competing for the same resource provided that each species is limited by a different statistical moment of resource dynamics. But competing species may also be unable to coexist indefinitely, whether at equilibrium or far from it, and yet be able to avoid competitive exclusion so long as their persistence is governed by processes acting at biogeographical spatial scales and historical time scales. In particular, the more species that are competitively equivalent, the longer the time required to achieve competitive exclusion. Competitive equivalence among tree species has been suggested as one of the explanations for the maintenance of the high diversity of tropical forests (Hubbell and Foster 1986). Competitive exclusion can also be retarded by recurrent disturbances reducing population densities: it is expected to be slowest, and thus species diversity to be highest, at intermediate frequencies of disturbance and intermediate rates of population growth (Huston 1979; see also below).

Disturbances which open up gaps are of special significance to sessile organisms which have a requirement for open space. Disturbances may be either physical (e.g. storms, fires, earthquakes) or biological (e.g. predation, trampling by animals, tree falls). Their common action is to remove organisms, open up space which can be colonized by other organisms, and usually initiate a local mini-succession. The dynamics of recurrent disturbance and colonization then creates an ever-changing patchwork of successional stages (Pickett and White 1985). Spatial heterogeneity and temporal variability are here linked intimately: communities are viewed as a dynamic and heterogeneous mosaic of patches. Although patches are constantly changing as a result of succession towards a

climax, patch dynamics tends to attain a large-scale equilibrium under a constant regime of natural disturbance. This equilibrium, called the 'shifting mosaic', is characterized by a constant statistical distribution of patches in time and in space at the scale of the landscape (Pickett and White 1985). However, fluctuations in environmental factors that affect patch dynamics often tend to bring the community away from the equilibrium state. For example, in tropical rain forests, the main factor determining patch dynamics is gap formation by tree falls. These increase with increased precipitation, and thus fluctuations in the yearly amount of rain cause significant and correlated temporal fluctuations in the regime of disturbance.

Natural disturbances potentially span a wide range of temporal and spatial scales. What defines a disturbance versus a normal component of a system is very much scale- and context-dependent (see Section 5.3.1). The effects of disturbances are similar to those of some biological processes we have already discussed, such as keystone predation in rocky intertidal sites (which can actually be viewed as a kind of disturbance from the perspective of prey communities) or death of individuals in communities of sessile organisms. All those processes act to open up space for colonization by other organisms, and thus make a higher diversity of coexisting species possible. The 'intermediate disturbance hypothesis' (Levin and Paine 1974; Horn 1975; Connell 1978) proposes that the highest diversity is maintained at intermediate levels of disturbance. If disturbances are very frequent, gaps will be constantly reset to an early successional stage, and only pioneer species will be present. If disturbances are very rare, most of the community for most of the time will remain at the climax state, and competitively superior, climax species will dominate. At intermediate frequencies of disturbance, gaps and species from all successional stages will be present, and hence diversity will be highest. This hypothesis has been proposed as one explanation of the high diversity of tropical rain forests and coral reefs (Connell 1978), but recent evidence suggests that it is only a small part of the story (see Box 4.5-1). It has implications for the sustainable use of ecosystem components, in that ecosystems might be able to support a certain amount of disturbance in the form of controlled intervention without significant reductions in biodiversity.

The growing recognition of the significance of spatial and temporal variability in communities and ecosystems, the development of the equilibrium theory of island biogeography (MacArthur and Wilson 1967), and the failure to explain global patterns of biodiversity by local environmental conditions, have recently led to a greater emphasis on processes occurring at large spatial and temporal scales in community ecology. A local community – on whatever scale it may be defined – is affected not only

by small-scale interactions such as competition, predation and mutualism, but also by large-scale regional processes and unique historical and geographical circumstances, which influence the number of species it contains (Ricklefs 1987; Ricklefs and Schluter 1993). Over a landscape, diversity depends on the spatial dynamics of patches and biotopes and the dispersal properties of populations. Within larger regions, processes that determine the production of species over evolutionary time come into play. These geographical and historical dimensions of local biodiversity are discussed in Section 3.3: accordingly they will not be developed here.

4.5.6 From ecosystems to genes: the role of coevolution in the generation of biodiversity

The continued interaction between organisms and their natural environment is not only responsible for the maintenance of biodiversity; it also contributes to the generation of novel biological traits and functions. A simple but clear example of an interaction with the environment promoting biodiversity can be found at the cellular and molecular level in the immunological responses of an organism to alien materials invading the body. The diversity of antibodies and sequences of restructured DNA produced in immunological cells results from the necessity to counter the diversity of potential antigens present in the environment.

The many intra- and interspecific biological interactions within communities and ecosystems play an important role in the evolutionary generation of biodiversity. All organisms have evolved in response to selection pressures, of which a significant part originates from other organisms. Thus, all organisms are likely to have coevolved with other organisms to some extent, though the latter are not necessarily those with which they interact now. Coevolution is usually defined as a reciprocal evolutionary change in traits of two species as a result of their interaction (Janzen 1980), but the concept could apply to interactions among more than two species as well.

Since Ehrlich and Raven's (1964) classic paper on coevolution between butterflies and plants, many examples of coevolved traits have been suggested in plant-animal interactions. Through selection and evolution, plants develop defence systems that prevent or reduce attacks by a variety of herbivores. The hard structures made of cellulose and other cell-wall substances serve as a basic physical defence, whereas the secondary substances stored in the cytoplasm are effective chemical defences (Abe and Higashi 1991). Animals attacking plants develop means for coping with these defences, also through selection and evolution. An evolutionary arms race then takes place. This coevolutionary process may lead to the creation of amazing products on both sides. This is a good example of how species interactions, through co-evolutionary processes,

generate novel biological traits and thus enhance biodiversity. In the absence of herbivores, plants tend to reduce and eventually cease their production of secondary defence compounds because of the high costs necessary to continue such production. Thus, interactions with animals are necessary for the continued production of those substances. This shows that some biological traits cannot be maintained when an organism is kept alone, out of its proper biological environment.

Coevolution is likely to be particularly important in systems composed of a host and an associated organism. A large proportion of the known species are organisms (parasitoids, parasites, commensals and mutualists) that are associated with, and require the continued interaction with, a host. Actually, there does not seem to be any animal or plant group in which such host-associate interactions are absent. The host provides the 'habitat-resource' system that controls the evolution of its associated organisms, and the latter impose selective constraints on the host. Thus, coevolution is an almost inevitable outcome of such interactions. Coevolution in host-associate systems can be studied in two different ways. First, the genomic components of the host and its associate may be compared. This comparison is based on the concept of a 'gene-for-gene' correspondence between resistance in the host and virulence in the parasite or pathogen (Flor 1956). This mode of coevolution between partners has been reviewed by Barrett (1985) and Thompson and Burdon (1992). Second, direct examination of the species themselves sheds light on the role of co-speciation in the generation of biodiversity. Co-speciation, the concurrent production of new species in hosts and their associates, is a remarkable form of coevolution, which may represent a significant source of novel biodiversity in host-parasite systems (see Box 4.5-2).

4.5.7 Towards an integrated approach

Developments in community ecology during the last two decades have made it clear that no single factor (competition, abiotic factors, disturbances, etc.) can account for the whole structure and species diversity of communities. Abiotic factors, biological interactions such as competition, predation, parasitism and mutualism, and their various indirect effects, ecosystem processes, temporal and spatial variability of the environment, regional processes and historical contingency and evolutionary processes, all have to be taken into account to varying degrees to explain the diversity of species in any local community or region (Figure 4.5-2; Diamond and Case 1986; Gee and Giller 1987; Begon *et al.* 1990; Barbault 1992; Ricklefs and Schluter 1993; Huston 1994). Ecological theory is in a period of profound restructuring and synthesis in which different theories on the origins and maintenance of biodiversity are being integrated. The outcome of this

Box 4.5.2: Generation of biodiversity in host–parasite associations.

Co-speciation is generally held to play a key role in host–associate evolution (see Brooks and Mc Lennan 1991 for a review), and thus to be a significant evolutionary source of biodiversity in host–associate systems. In this mode of evolution, speciations in the two partners are concomitant, so that the phylogeny of one mirrors that of the other (Figure A, opposite). However, this process has not been well documented. Its only demonstrative study is a comparative analysis of genetic divergence among 15 species of rodents and 17 species of associated ectoparasites (chewing lice). Comparison of phylogenies, based on enzymatic polymorphisms and the DNA sequences of the gene coding for mitochondrial cytochrome oxidase, suggests that co-speciation is the rule in this association (Hafner and Nadler 1988; Hafner *et al.* 1994). Such an analysis also allows comparison of the rates of evolution of the host and parasite genomes and quantification of the levels of nucleotide divergence which, in this case, appear to be different in hosts and parasites.

In the strict sense of the term, co-speciation implies that a single parasite species is associated with each host species. The fact that the above study is so far the only one to have demonstrated it may reflect a lack of research in this field, or it may indicate that strict co-speciation is only a minor process in the evolution of host–associate interactions. Alternative processes are possible. Thus, several congeneric parasite species often co-exist in one host species. For instance, the teleostean *Alestes nurse* (Characidae) hosts on its gills a record eight congeneric species of monogeneans belonging to the genus *Annulotrema* (Birgi and Euzet 1982). Similarly, in the western Mediterranean, three congeneric species of teleostean fishes (Mugilidae) are parasitized by, respectively, two, three, and four host-specific, congeneric species of monogeneans belonging to the genus *Ligophorus* (Euzet and Sanfilippo 1981). In such cases, there are secondary speciations of parasites within a host species leading to an enrichment of parasite diversity. This phenomenon can be compared to gene duplications in genomes (Page 1994).

The above processes result in phylogenetic development of biodiversity. But non-phylogenetic processes also can contribute to increased biological diversity. Just as there are horizontal gene transfers between different genomes (insertion sequences), there are lateral transfers of parasite taxa between host lineages (host switching – Figure B, opposite). Such lateral transfers increase the parasite richness of the target lineage, and can cause subsequent speciation of its parasites. Host and parasite phylogenies, analysed after this process has taken place, can be very different. Even in the rodent–chewing lice association showing co-speciation, there are two known cases of lateral parasite transfer between host lineages. Hoberg (1986) suggested that the diversity of a bird (Alcidae) – cestode (Dilepididae) system evolved mainly by switching between host lineages. These lateral transfers can involve various processes – ecological, ethological, or biogeographical (Euzet and Combes 1980; Brooks and McLennan 1991). They are well known in the case of humans; as these occupied new areas of the planet and domesticated other animals, they acquired parasites of various origins (such as *Schistosoma*, *Trypanosoma*, etc.).

Other potential mechanisms involved in the evolution of host–parasite systems were suggested by a recent work of Verneau (1994) on co-speciation in an association between six teleostean fish species and their six host-specific endoparasite cestod species. Quantification of nucleotidic divergence by DNA/DNA hybridization in liquid phase and sequencing of part of rDNA 18S between pairs of hosts and parasites showed that co-speciation and lateral transfers were not the processes likely to govern the evolution of this system. Indeed, the smallest nucleotide divergence observed between host pairs was greater than the largest nucleotide divergence observed between parasites pairs. Yet the rates of evolution of hosts and parasites, analysed on the basis of rDNA 18S sequences, were not significantly different. Therefore, the speciation of these six parasite species, and thus the enrichment of biodiversity in the system, must have been produced in a very short time period, totally independently of their hosts, whose origin is far more ancient. Two hypotheses could explain these results: either sequential colonizations of different host species and subsequent speciation of parasites, or an explosion of an ubiquitous parasite species into a complex of host-specific species.

Such evolutionary processes are of prime interest for research into the palaeoclimatic and geological events which have marked the history of the Earth and shaped the present biological diversity. Periods of extinction or diversification of organisms over geological time should also be periods of extinction or diversification of their associated organisms. The understanding of the origins of the biological richness in host–associate systems provides a new potential line of research into the evolutionary history of organisms for which the fossil records will never be sufficiently informative to support viable hypotheses.

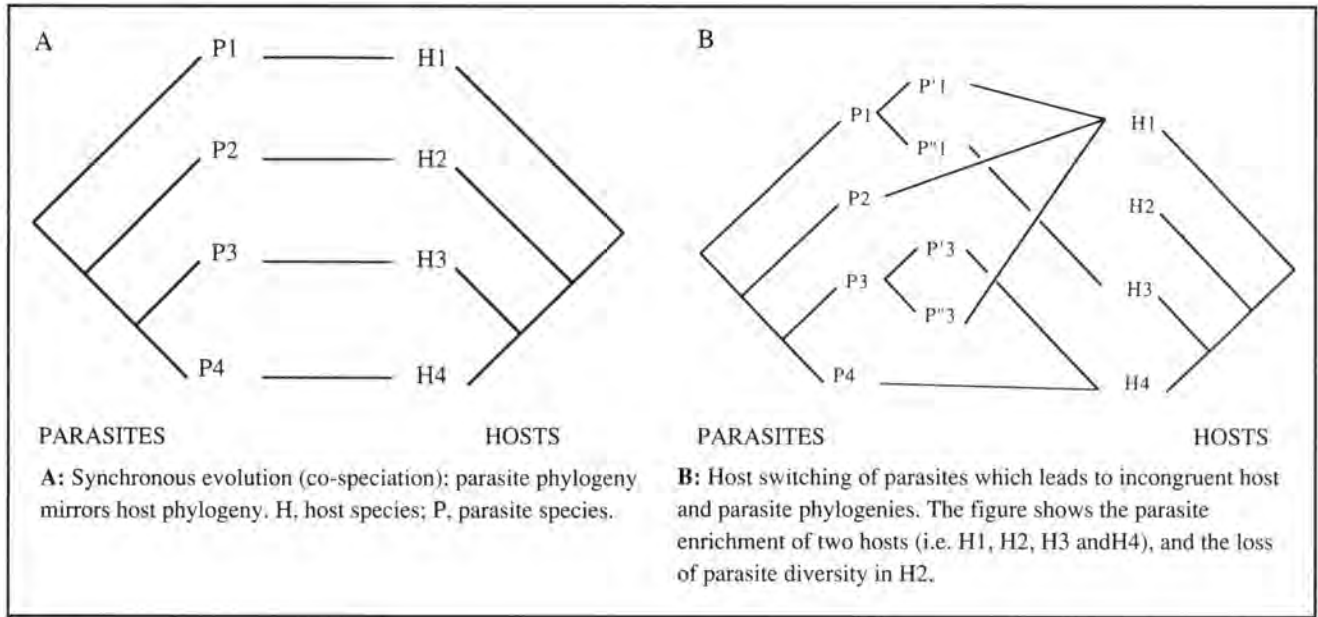

process should be a more unified theory that takes the many potential factors into consideration.

One attempt at integrating the various factors determining community structure and species diversity was made by Schoener (1986), who proposed to rank communities along primitive axes, defined by both organismic properties (body size, recruitment, generation time, individual motility, homeostatic ability, number of life stages) and environmental properties (severity of physical factors, trophic position, resource input, spatial fragmentation, long-term climatic variation, partitionability of resources). Derived axes then order ecological characteristics whose patterns are explained in terms of the primitive axes. Examples are the relative importance of physical versus biological processes, the relative importance of predation versus competition, the number of species, and the relative importance of history. In a similar vein, Menge and Sutherland (1987) proposed a model of community regulation predicting the relative importance of disturbance, competition and predation in relation to variation in environmental stress, recruitment density and trophic position. Here also, it is increasingly recognized that such patterns depend on a complex interplay between regional- and local-scale processes (Menge and Olson 1990).

Thus, in this process of integration, care must be taken to avoid the drawbacks of many classical community approaches, namely: (1) failure to link community and ecosystem processes; (2) disregard of the temporal, historical and evolutionary dimensions of the problem, notably the phylogenetic relationships between taxa (Brooks and McLennan 1991); and (3) lack of representation of spatial frameworks, with their heterogeneity at various scales, from microhabitat to landscape. The temporal and spatial dimensions of

biodiversity dynamics are considered explicitly in Wien's (1989) scheme of community assembly (Figure 4.5-3).

To face the challenge raised by the loss and management of biodiversity, a space- and ecosystem-oriented approach appears to be more useful and efficient than an accumulation of species-centred studies. Species richness and genetic variability are closely linked with ecosystem and landscape properties, such as biotic interactions, habitat diversity, spatial heterogeneity, disturbance regime, patch dynamics, etc. In this context, a landscape ecology approach is useful, because it helps in dealing with environmental heterogeneity in spatially explicit terms, as well as linking spatial patterns and processes (O'Neill and Shugart 1987; Turner 1989; Zonnerveld and Forman 1990; Wiens *et al.* 1993; Barbault 1994, 1995). This approach may also offer an appropriate tool to conserve the vast majority of biological diversity (Franklin 1993).

One message that emerges from this chapter is that the rich complexity of both the physical environment and the interactions among organisms and species is crucial for the maintenance and generation of the diversity of their biological traits (biochemical, physiological, behavioural, and other). Ecological complexity enhances biodiversity through slow evolutionary and biogeographic processes, whereas its degradation (the simplification of ecological interactions and habitat structure) tends to result in a fast decline in the diversity of phenotypic and genotypic traits. For the conservation of biodiversity, it is not sufficient to preserve living organisms or their gametes in isolation. Keeping animals and plants in zoological and botanical gardens or frozen as gametes cannot conserve the full range of biological diversity they exhibit in nature, because they lose the ecological complexity that they enjoy in their original habitats. To preserve the full biodiversity

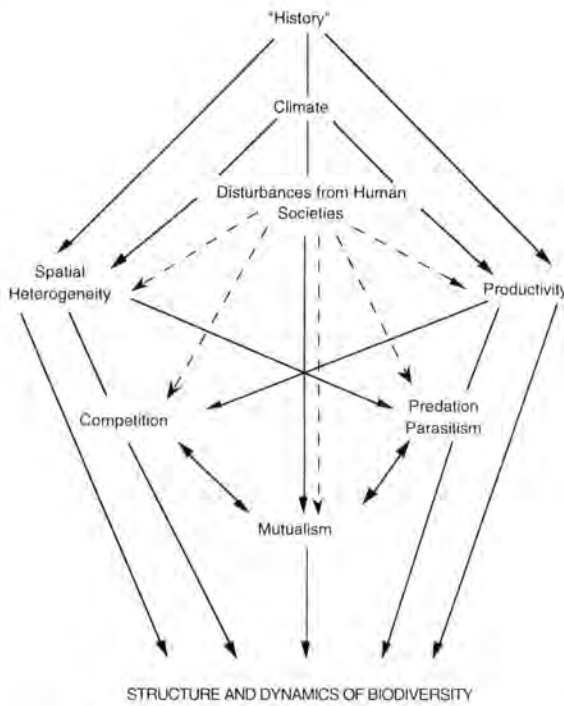

Figure 4.5-2: The diversity of factors usually called upon to explain the latitudinal gradients of fauna and flora richness, made more complete by the addition of human disturbances, should constitute the framework of a pluralist theory of historical and ecological determinism of biodiversity levels and dynamics (from Barbault 1992).

embodied in living organisms, these must be maintained in, and together with, their natural environment, *in situ*, with the proper ecological complexity and dynamics.

4.5.8 Summary

Biodiversity cannot be properly understood without due consideration of its dynamics in communities and ecosystems. Interactions among species play an essential role in the generation and maintenance of biodiversity. Interspecific competition tends to limit the number of coexisting species on an ecological time-scale, but also to increase niche differentiation among species, and thus to diversify species' traits on an evolutionary time-scale. Although predation has direct negative effects on the prey consumed, it can also be a powerful factor enhancing prey species diversity. Keystone predators, which maintain high prey species diversity by selectively reducing populations of competitively dominant species, appear to be common in several ecosystem types. Mutualistic interactions are extremely widespread and important to the persistence of species. Some mutualists may also be keystone species, which contribute to the maintenance of a large number of other species. Additionally, many other indirect interactions bind organisms together in ecosystems. Therefore, the loss or introduction of a single species or

group of species can have far-reaching effects on many other species and the ecosystem as a whole. The continued interactions among organisms are not only responsible to a significant extent for the maintenance of biodiversity, but also for its evolutionary generation. The co-evolution of species tends to produce novel biological traits: it is likely to be particularly important in host-associate systems, where it can take the form of co-speciation.

Spatial heterogeneity and temporal variability of the environment are also major factors determining the maintenance of biodiversity in communities and ecosystems. Environmental heterogeneity allows potentially more species to coexist, and may be especially important in the maintenance of the diversity of plants and other sessile organisms. Temporal fluctuations of the environment also increase the potential for coexistence of species. In particular, disturbances which open up gaps are of great significance to sessile organisms which have a requirement for open space. The dynamics of recurrent disturbance and colonization creates a shifting mosaic of patches at different successional stages, which tends to maintain highest species diversity at intermediate levels of disturbance. Species diversity depends also on regional, biogeographical, historical and evolutionary processes occurring at large spatial and temporal scales.

Thus, the rich complexity of both the physical environment and the interactions among organisms and species appears to be crucial for the maintenance and generation of biodiversity. It is traditional in conservation biology to focus on individual populations or species that are endangered. However, the species, though important, may not be the best overall target for conservation. The ecosystem and its component communities which contain the species appear to be more appropriate targets for conservation, because they take into account explicitly the many ecological interactions between organisms and their biotic and abiotic natural environment. A space-orientated approach up to the landscape scale may be the most appropriate tool with which to conserve the vast majority of biological diversity.

References

- Abe, T. and Higashi, M. 1991. Cellulose centered perspective on terrestrial community structure. *Oikos* **60**: 127–133.
- Ahlberg, P.E. and Milner, A.R. 1994. The origin and early diversification of tetrapods. *Nature* **368**: 507–514.
- Akçakaya, H.R. 1993. RAMAS/GIS. *Linking landscape data with population viability analysis*. Applied Biomath., Setauket, New York.
- Allee, W.C., Emerson, A.E., Park, O., Park, T. and Schmidt, K.P. 1949. *Principles of Animal Ecology*. Saunders, Philadelphia, Pa.
- Alvarez, L.W., Alvarez, W., Asaro, F. and Michel, H.V. 1980. Extraterrestrial cause for the Cretaceous–Tertiary extinctions. *Science* **208**: 1095–1108.

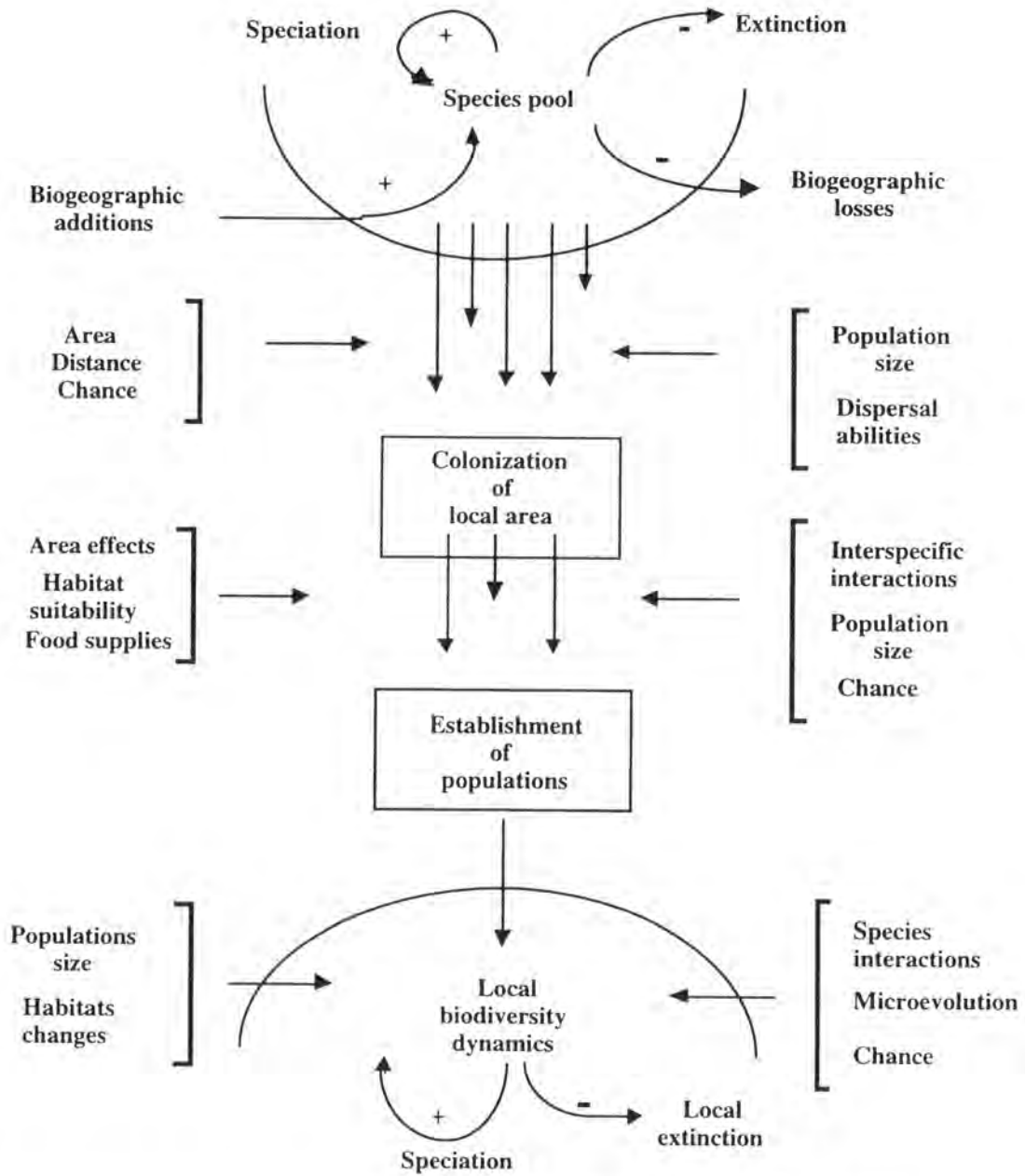

Figure 4.5-3: Analysing biodiversity dynamics along time and space (after Wiens 1989, adapted in Barbault 1992).

Alvarez, W., Alvarez, L.W., Asaro, F. and Michel, H.V. 1982. Current status of the impact theory for the terminal Cretaceous extinction. *Geological Society of America Special Paper* 190: 305–316.

Alvarez-Buylla, E.R. and Martínez-Ramos, M. 1992. Demography and allometry of *Cecropia obtusifolia*, a neotropical pioneer tree – an evaluation of the climax–pioneer paradigm for tropical rain forests. *Journal of Ecology* 80: 275–290.

Anderson, R.M. and May, R.M. 1986. The invasion, persistence and spread of infectious diseases within animal and plant communities. *Philosophical Transaction of the Royal Society of London, B* 314: 533–570.

Andrén, H. and Angelstam, P. 1988. Elevated predation rates as an edge effect in habitat islands: experimental evidence. *Ecology* 69: 544–547.

Anonymous 1991. *Rijksinstituut voor Volksgezondheid en Milieuhygiene. Nationale milieuverkenning 2 1990-2010*. RIVM Report, Samson H.D. Tjeenk Willink bv, Alphen aan de Rijn.

Atkinson, I. 1989. Introduced animals and extinctions. In: Western, D. and Pearl, M.C. (eds), *Conservation for the Twenty-first Century*. 54–75. Oxford University Press, Oxford.

Avise, J.C. 1993. *Molecular Markers, Natural History and Evolution*. Chapman and Hall, New York.

Awramik, S.M., Schopf, J.W. and Walter, M.R. 1983. Filamentous fossil bacteria from the Archean of Western Australia. *Precambrian Research* 20: 357–374.

Bambach, R.K. 1977. Species richness in marine benthic habitats through the Phanerozoic. *Paleobiology* 3: 152–167.

Bambach, R.K. 1983. Ecospace utilization and guilds in marine communities through the Phanerozoic. In: Tevesz, M.J.S. and

- McCall, P.L. (eds), *Biotic Interactions in Recent and Fossil Benthic Communities*. 719–746. Plenum Press, New York.
- Bambach, R.K.** 1993. Seafood through time: changes in biomass, energetics, and productivity in the marine ecosystem. *Paleobiology* **19**: 372–397.
- Barbault, R.** 1992. *Ecologie des Peuplements. Structure, Dynamique et Évolution*. Editions Masson, Paris.
- Barbault, R.** 1994. *Des Baleines, des Bactéries et des Hommes*. Editions Odile Jacob, Paris.
- Barbault, R.** 1995. Biodiversity dynamics: from population and community approaches to a landscape ecology point of view. *Landscape and Urban Planning* **31**: 89–98.
- Barbault, R.** and Hochberg, M. 1992. Population and community level approaches to studying biodiversity in international research programs. *Acta Oecologica* **13**: 137–146.
- Barnosky, A.D.** 1989. The late Pleistocene event as a paradigm for widespread mammal extinction. In: Donovan, S.K. (ed.), *Mass Extinctions: Processes and Evidence*, 235–254. Columbia University Press, New York.
- Barrett, J.** 1985. The gene for gene hypothesis: parable or paradigm. In: Rollinson and Anderson (eds), *Ecology and Genetics of Host-parasite Interactions*. Academic Press, London.
- Barton, N.H.** and Hewitt, G.M. 1989. Adaptation, speciation and hybrid zones. *Nature* **341**: 497–503.
- Baud, A., Magaritz, M.** and Holser, W.T. 1989. Permian–Triassic of the Tethys: carbon isotope studies. *Geologische Rundschau* **78**: 649–677.
- Beddington, J.R., Free, C.A.** and Lawton, J.H. 1978. Characteristics of successful natural enemies in models of biological control of insect pests. *Nature* **273**: 513–519.
- Begon, M., Harper J.L.** and Townsend, C.R. 1990. *Ecology. Individuals, Populations and Communities*, 2nd edn. Blackwell Scientific Publications, Oxford.
- Behrensmeyer, A.K., Damuth, J.D., DiMichele, W.A., Potts, R., Sues, H.D.** and Wing, S.L. (eds). 1992. *Terrestrial Ecosystems Through Time*. University of Chicago Press, Chicago.
- Belovsky, G.E.** 1987. Extinction models and mammalian persistence. In: Soulé, M.E. (ed.), *Viable Populations for Conservation*, Vol. 3. 35–58. Cambridge University Press, Cambridge.
- Bender, E.A., Case, T.J.** and Gilpin, M.E. 1984. Perturbation experiments in community ecology: theory and practice. *Ecology* **65**: 1–13.
- Bengtsson, J.** 1988. *Life histories, interspecific competition and regional distribution of three rockpool Daphnia species*. Unpublished thesis, Uppsala University, Sweden.
- Bengtsson, J.** 1991. Interspecific competition in metapopulations. In: Gilpin, M.E. and Hanski, I. (eds), *Metapopulation Dynamics*. 219–237. Academic Press, London.
- Bennett, K.D.** 1990. Milankovitch cycles and their effects on species in ecological and evolutionary time. *Paleobiology* **16**: 11–21.
- Benton, M.J.** 1985. Mass extinction among non-marine tetrapods. *Nature* **316**: 811–814.
- Benton, M.J.** 1987. Mass extinctions among families of non-marine tetrapods: the data. *Mémoires de la Société Géologique de la France* **150**: 21–32.
- Benton, M.J.** 1988. Mass extinctions and the fossil record of reptiles: paraphyly, patchiness and periodicity. In: Larwood, G.P. (ed.), *Extinction and Survival in the Fossil Record*. 269–294. Oxford University Press, Oxford.
- Benton, M.J.** 1989. Patterns of evolution and extinction in vertebrates. In: Allen, K.C. and Briggs, D.E.G. (eds), *Evolution and the Fossil Record*. 218–241. Belhaven Press, London.
- Benton, M.J.** 1990. Reptiles. In: McNamara, K.J. (ed.), *Evolutionary Trends*. 279–300. Belhaven Press, London.
- Benton, M.J.** 1995. Diversification and extinction in the history of life. *Science* **268**: 52–58.
- Benton, M.J.** and Simms, M.J. 1995. Testing marine and continental fossil records. *Geology* **23**: 601–604.
- Berg, D.E.** and Howe, M.H. 1989. *Mobile DNA*. American Society of Microbiologists, Washington, DC.
- Bink, R.J., Bal, D.** van den Berk, V.M. and Draaijer, L.J. 1994. Toestand van de natuur 2. *IKC-NBLF Report 4*, Wageningen.
- Birgi, E.** & Euzet, L. 1982. Espèces nouvelles du genre *Annulotrema* (Monogenea, Ancyrocephalidae) parasite branchial d'*Alestes nurse* (Teleostei) dans le bassin du Tchad. *Bulletin de la Société Zoologique de France* **33**: 123–128.
- Bobbink, R.** and Willems, J.H. 1988. Effects of management and nutrient availability on vegetation structure of chalk grassland. In: During, H.J., Werger, M.J.A. and Willems, J.H. (eds), *Diversity and Pattern in Plant Communities*. 183–193. SPB Academic Publishing, The Hague.
- Boecklen, W.J.** and Simberloff, D. 1986. Area-based extinction models in conservation. In: Elliot, D.K. (ed.), *Dynamics of Extinction*. 247–276. John Wiley, New York.
- Bohor, B.F., Foord, E.E., Modreski, P.J.** and Triplehorn, D.M. 1984. Mineralogic evidence for an impact event at the Cretaceous–Tertiary boundary. *Science* **224**: 867–869.
- Bond, W.Y.** 1993. Keystone species. In: Schulze, E.D. and Mooney, H.A. (eds), *Biodiversity and Ecosystem Function*. 237–253. Springer-Verlag, Berlin.
- Bottjer, D.J.** and Ausich, W.I. 1986. Phanerozoic development of tiering in soft substrata suspension-feeding communities. *Paleobiology* **12**: 400–420.
- Bourgeois, J., Hansen, T.A., Wiberg, P.L.** and Kauffman, E.G. 1988. A tsunami deposit at the Cretaceous–Tertiary boundary in Texas. *Science* **241**: 567–570.
- Bowring, S.A., Grotzinger, J.P., Isachsen, C.E., Knoll, A.H., Pelechaty, S.M.** and Kolosov, P. 1993. Calibrating rates of Early Cambrian evolution. *Science* **261**: 1293–1298.
- Boyce, M.S.** 1992. Population viability analysis. *Annual Review of Ecology and Systematics* **23**: 481–506.
- Bradshaw, A.D.** 1971. Plant evolution in extreme environments. In: Creed, E.R. (ed.), *Ecological Genetics and Evolution*. 20–50. Appleton-Century-Croft, New York.
- Brian, M.V.** (ed.) 1978. *Production Ecology of Ants and Termites*. Cambridge University Press, Cambridge.
- Briggs, J.C.** 1994. Species diversity: land and sea compared. *Systematic Biology* **43**: 130–135.
- Brooks, D. R.** and Mc Lennan, D.A. 1991. *Phylogeny, Ecology and Behaviour: A research program in comparative biology*. The University of Chicago Press, Chicago.
- Brown, A.H.D.** and Schoen, D.J. 1992. Plant population genetic structure and biological conservation. In: Sandlund, O.T.,

- Hindar, K. and Brown, A.H.D. (eds), *Conservation of Biodiversity for Sustainable Development*. 88–104. Scandinavian University Press, Oslo.
- Brown, J.H.** and Heske, E.J. 1990. Control of a desert-grassland transition by a keystone rodent guild. *Science* **250**: 1705–1707.
- Brown, K.S.** and Brown, G.G. 1992. Habitat alteration and species loss in Brazilian forests. In: Whitmore, T.C. and Sayer, J.A. (eds), *Tropical Deforestation and Species Extinction*. 119–142. Chapman and Hall, London.
- Brown, S.** and Lugo, A.E. 1982. The storage and production of organic matter in tropical forests and their role in the global carbon cycle. *Biotropica* **14**: 161–187.
- Bruin, J.**, Sabelis, M.W., Takabayashi, J. and Dicke, M. 1991. Uninfested plants profit from their infested neighbours. *Proceedings of Experimental and Applied Entomology N. E. V. Amsterdam* **2**: 103–108.
- Bush, G.L.** 1969. Sympatric host race formation and speciation in frugivorous flies of the genus *Rhagoletis* (Diptera: Tephritidae). *Evolution* **23**: 237–251.
- Buzas, M.A.** and Culver, S.J. 1994. Species pool and dynamics of marine paleocommunities. *Science* **264**: 1439–1441.
- Carlton, J.T.** and Geller, J.B. 1993. Ecological roulette – the global transport of nonindigenous marine organisms. *Science* **261**: 78–82.
- Caswell, H.** 1978. A general formula for the sensitivity of population growth rate to changes in life history parameters. *Theoretical Population Biology* **14**: 215–230.
- Caswell, H.** 1989. *Matrix Population Models*. Sinauer Associates, Sunderland, Mass.
- Caughley, G.** 1994. Directions in conservation biology. *Journal of Animal Ecology* **63**: 215–244.
- Cavalli-Sforza, L.L.** and Bodmer, W.F. 1971. *The Genetics of Human Populations*. W.H. Freeman, San Francisco.
- Cavalli-Sforza, L.L.** and Edwards, A.W.F. 1967. Phylogenetic analysis: models and estimation procedures. *Evolution* **21**: 550–570.
- Charlesworth, B.** 1980. *Evolution in Age-structured Populations*. Cambridge University Press, Cambridge.
- Chesson, P.L.** 1986. Environmental variation and the coexistence of species. In: Diamond, J. and Case, T.J. (eds), *Community Ecology*. 240–256. Harper and Row, New York.
- Clinebell, R.R.**, Phillips, O.L., Gentry, A.H., Stark, N. and Zuuring, H. 1995. Prediction of neotropical tree and liana species richness from soil and climatic data. *Biodiversity and Conservation* **4** (in press).
- Clobert, J.** 1995. Capture–recapture and evolutionary ecology: a difficult wedding? *Journal of Applied Statistics* (in press).
- Clark, D.A.** and Clark, D.B. 1984. Spacing dynamics of a tropical rain-forest tree: evaluation of the Janzen-Connell model. *American Naturalist* **124**: 769–788.
- Coates, M.I.** and Clack, J.A. 1991. Fish-like gills and breathing in the earliest known tetrapod. *Nature* **352**: 234–236.
- Colbert, E.H.** 1949. Progressive adaptations as seen in the fossil record. In: Jepsen, G.L., Simpson, G.G. and Mayr, E. (eds), *Genetics, Paleontology and Evolution*. 390–402. Princeton University Press, Princeton, NJ.
- Colwell, R.K.** and Winkler, D.W. 1984. A null model for null models in biogeography. In: Strong D.R., Simberloff D, Abele, L.G., and Thistle, A. (eds), *Ecological Communities: Conceptual issues and the evidence*. 344–359. Princeton University Press, Princeton, NJ.
- Combes, C.** 1995. *Interactions durables: Ecologie et Evolution du Parasitisme*. Masson, Paris.
- Comins, H.N.**, Hamilton, W.D. and May, R.M. 1980. Evolutionary stable dispersal strategies. *Journal of Theoretical Biology* **82**: 205–230.
- Connell, J.H.** 1971. On the role of natural enemies in preventing competitive exclusion in some marine animals and in rain forest trees. In: den Boer, P.J. and Gradwell, G.R. (eds), *Dynamics of populations*. 298–313. PUDOC, Wageningen.
- Connell, J.H.** 1978. Diversity in tropical rain forests and coral reefs. *Science* **199**: 1302–1310.
- Connell, J.H.** 1983. On the prevalence and relative importance of interspecific competition: evidence from field experiments. *American Naturalist* **122**: 661–696.
- Connor, E.F.** and McCoy, E.D. 1979. The statistics and biology of the species-area relationship. *American Naturalist* **113**: 791–833.
- Connor, E.F.** and Simberloff, D.S. 1979. The assembly of species communities: chance or competition? *Ecology* **60**: 1132–40.
- Conway Morris, S.** 1993. The fossil record and the early evolution of the Metazoa. *Nature* **361**: 219–225.
- Coope, G.R.** 1987. The response of late Quaternary insect communities to sudden climatic changes. In: Gee, J.H.R. and Giller, P.S. (eds), *Organization of Communities, Past and Present*. 421–438. Blackwell, Oxford.
- Coope, G.R.** 1994. The response of insect faunas to glacial–interglacial climatic fluctuations. *Philosophical Transactions of the Royal Society of London, B* **344**: 19–26.
- Cooper, P.** 1988. Ecological succession in Phanerozoic reef ecosystems: is it real? *Palaos* **4**: 424–438.
- Courtenay, W.R., J.** and Robins, C.R. 1989. Fish introductions: good management, mismanagement, or no management? *Critical Reviews in Aquatic Sciences* **1**: 159–172.
- Cracraft, J.** 1985. Biological diversification and its causes. *Annals of the Missouri Botanical Garden* **72**: 794–822.
- Cracraft, J.** 1990. The origin of evolutionary novelties: pattern and process at different hierarchical levels. In: Nitecki, M. (ed.), *Evolutionary Innovations*. 21–44. University of Chicago Press, Chicago.
- Cracraft, J.** 1992. Explaining patterns of biological diversity: integrating causation at differential spatial and temporal scales. In: Eldredge, N. (ed.), *Systematics, Ecology and the Biodiversity Crisis*. 59–66. Columbia University Press, New York.
- Crouse, D.T.**, Crowder, L.B. and Caswell, H. 1987. A stage-based population model for loggerhead sea turtles and implications for conservation. *Ecology* **68**: 1412–1423.
- Crow, J.F.** and Kimura, M. 1970. *An Introduction to Population Genetics Theory*. Burgess Publishing Company, Minneapolis.
- Darwin, C.** 1859. *On the Origin of Species by means of Natural Selection, or the Preservation of Favoured Races in the Struggle for Life*. John Murray, London.
- Davis, G.J.** and Howe, R.W. 1992. Juvenile dispersal, limited breeding sites, and the dynamic of metapopulations. *Theoretical Population Biology* **41**: 184–207.

- Davis, M.B.** 1986. Climatic instability, time lags, and community disequilibrium. In: Diamond, J. and Case, T.J. (eds), *Community Ecology*. 269–284. Harper and Row, New York.
- Davis, M.B.** 1989. Lags in vegetation response to greenhouse warming. *Climate Change* **15**: 75–82.
- DeAngelis, D.L.** 1992. *Dynamics of Nutrient Cycling and Food Webs*. Chapman and Hall, London.
- DeAngelis, D.L.** and Waterhouse, J.C. 1987. Equilibrium and nonequilibrium concepts in ecological models. *Ecological Monographs* **57**: 1–21.
- Dempster, J.P.** 1991. Fragmentation, isolation and mobility of insect populations. In: Collins, N.M. and Thomas, J.A. (eds), *Conservation of Insects and their Habitats*. 143–154. Academic Press, London.
- den Boer, P.J.** 1985. Exclusion, competition or coexistence? A question of testing the right hypotheses. *Zeitschrift für zoologische Systematik und Evolutionsforschung* **23**: 259–274.
- Denslow, J.S.** 1987. Tropical rainforest gaps and tree species diversity. *Annual Review of Ecology and Systematics* **18**: 431–451.
- Denslow, J.S.**, Schultz, J.C., Vitousek, P.M. and Strain, B.R. 1990. Growth responses of tropical shrubs to treefall gap environments. *Ecology* **71**: 165–179.
- D'Hondt, S.** and Keller, G. 1991. Some patterns of planktic foraminiferal assemblage turnover at the Cretaceous–Tertiary boundary. *Marine Micropaleontology* **17**: 77–118.
- Diamond, J.M.** 1984. 'Normal' extinction of isolated populations. In: Nitecki, M.H. (ed.), *Extinctions*. 191–246. University of Chicago Press, Chicago.
- Diamond, J.M.** and Case, T.J. (eds), 1986. *Community Ecology*. Harper and Row, New York.
- Diamond, J.M.** and Gilpin, M.E. 1982. Examination of the "null" model of Connor and Simberloff for species co-occurrences on islands. *Oecologia* **52**: 64–74.
- Dickie, M.**, Sabelis, M.W., Takabayashi, J., Bruin, J. and Posthumus, M.A. 1990. Plant strategies of manipulating predator–prey interactions through allelo-chemicals: prospects for application in pest control. *Journal of Chemical Ecology* **16**: 3091–3118.
- Dickman, C.R.**, Pressey, R.L., Lim, L., and Parnaby, H.E. 1993. Mammals of particular conservation concern in the Western division of New South Wales. *Biological Conservation* **65**: 219–248.
- Dirzo, R.** 1987. Estudios sobre interacciones planta–herbívoro en Los Tuxtlas, Veracruz. *Revista de Biología Tropical* **35**: 119–131.
- Dirzo, R.** and Miranda, A. 1991. Altered patterns of herbivory and diversity in the forest understory: a case study of the possible consequences of contemporary defaunation. In: Price, P.W., Lewinsohn, P.W., Fernandes, G.W. and Benson, W.W. (eds), *Plant–animal Interactions: Evolutionary ecology in tropical and temperate regions*. 273–287. John Wiley, New York.
- Dobson, A.P.** and Lyles, A.M. 1989. The population dynamics and conservation of primate populations. *Conservation Biology* **3**: 362–380.
- Dobson, F.S.** and Jones, W.T. 1985. Multiple causes of dispersal. *American Naturalist* **126**: 855–858.
- Dobzhansky, T.** 1970. *Genetics of the Evolutionary Process*. Columbia University Press, New York.
- Dobzhansky, T.**, Ayala, F.J., Stebbins, G.L. and Valentine, J.W. 1977. *Evolution*. W.H. Freeman, San Francisco.
- Dodson, P.** and Tatarinov, L.P. 1990. Dinosaur extinction. In: Weishampel, D.B., Dodson, P. and Osmolska, H. (eds), *The Dinosauria*, 55–62. University of California Press, Berkeley.
- Ebenhard, T.** 1991. Colonization in metapopulations: a review of theory and observations. In: Gilpin, M.E. and Hanski, I. (eds), *Metapopulation Dynamics*. 105–121. Academic Press, London.
- Ehrlich, P.R.** and Raven, P.H. 1964. Butterflies and plants: a study of coevolution. *Evolution* **18**: 586–608.
- Eldredge, N.** 1989. *Macro-evolutionary Dynamics*. McGraw-Hill, New York.
- Eldredge, N.** and Gould, S.J. 1972. Punctuated equilibria: an alternative to phyletic gradualism. In: Schopf, R.J.M. (ed.), *Models in Paleobiology*. 82–115. W.H. Freeman, San Francisco.
- Endler, J.A.** 1977. *Geographic Variation, Speciation, and Clines*. Princeton University Press, Princeton, NJ.
- Endler, J.A.** 1986. *Natural Selection in the Wild*. Princeton University Press, Princeton, NJ.
- Engels, W.R.** 1983. The P family of transposable elements in *Drosophila*. *Annual Review of Genetics* **17**: 315–344.
- Erwin, D.H.** 1993. *The Great Paleozoic Crisis. Life and Death in the Permian*. Columbia University Press, New York.
- Estes, J.A.**, Smith, N.S. and Palmisano, J.F. 1978. Sea otter predation and community organization in the western Aleutian Islands, Alaska. *Ecology* **59**: 822–823.
- Euzet, L.** and Combes, C. 1980. Les problèmes de l'espèce chez les animaux parasites. In: *Les Problèmes de l'Espèce dans le Règne Animal*. Vol. 3. *Mémoires de la Société Zoologique de France* **40**: 239–285.
- Euzet, L.** and Sanfilippo, D. 1981. La spécificité des monogènes parasites de muges en Méditerranée. *Annales de Parasitologie Humaine et Comparée* **25**: 83–88.
- Faeth, S.H.** 1986. Indirect interactions between temporally separated herbivores mediated by the host plant. *Ecology* **67**: 479–494.
- Falconer, D.S.** 1981. *Introduction of Quantitative Genetics*, 2nd edn. Longman, London.
- Feder, M.** and Watt, W.B. 1992. Functional biology of adaptation. In: Berry, R.J., Crawford, T.J. and Hewitt, G.M. (eds), *Genes in Ecology*. Blackwell, Oxford.
- Ferris, C.**, Oliver, R.P., Davy, A.J. and Hewitt, G.M. 1993. Native oak chloroplasts reveal an ancient divide across Europe. *Molecular Ecology* **2**: 337–344.
- Person, S.** and Akcakaya, H.R. 1990. RAMAS/age Modeling fluctuations in age-structured populations. Exeter Software, Setauket, New York.
- Fisher, D.C.** 1984. Mastodon butchery by North American paleo-Indians. *Nature* **308**: 271–272.
- Flessa, K.W.** 1975. Area, continental drift, and mammalian diversity. *Paleobiology* **1**: 189–194.
- Flor, H.H.** 1956. The complementary genic systems in flax and flax rust. *Advances in Genetics* **8**: 29–54.
- Foley, P.** 1994. Predicting extinction times from environmental stochasticity and carrying capacity. *Conservation Biology* (in press).
- Ford, E.B.** 1964. *Ecological Genetics*. Methuen, London.
- Forey, P.**, Humphries, C.J. and Vane-Wright, R. (eds.) 1994. Systematics and conservation evaluation. *Systematics Association Special Volume* **50**: 1–438.

- Franklin, I.R.** 1980. Evolutionary change in small populations. In: Soulé, M.E. and Wilcox, B.A. (eds), *Conservation Biology: An evolutionary-ecological perspective*. 135–149. Sinauer Associates, Sunderland, Mass.
- Franklin, J.F.** 1993. Preserving biodiversity: species, ecosystems or landscapes? *Ecological Applications* **3**: 202–205.
- Futuyma, D.** 1986. *Evolutionary Biology*. Sinauer Associates, Sunderland, Mass.
- Gabriel, W.** and Burger, R. 1992. Survival of small populations under demographic stochasticity. *Theoretical Population Biology* **41**: 44–71.
- Garland, T., Jr** and Adolph, S.C. 1991. Physiological differentiation of vertebrate populations. *Annual Review of Ecology and Systematics* **22**: 193–228.
- Gaston, K.J.** and Williams, P.H. 1993. Mapping the world's species – the higher taxon approach. *Biodiversity Letters* **1**: 2–8.
- Gaston, K.J., Williams, P.H., Eggketib, P.** and Humphries, C.J. 1995. Large scale patterns of biodiversity: spatial variation in family richness. *Proceedings of the Royal Society of London, B* **260**: 149–154.
- Gatto, M.** 1990. A general minimum principle for competing populations: some ecological and evolutionary consequences. *Theoretical Population Biology* **37**: 369–388.
- Gause, G.F.** 1934. *The Struggle for Existence*. Hafner, New York.
- Gee, J.** and Giller, P.S. (eds.) 1987. *Organisation of Communities, Past and Present*. Blackwell Scientific, Oxford.
- Gentry, A.H.** 1988. Changes in plant community diversity and floristic composition on environmental and geographical gradients. *Annals of the Missouri Botanical Garden* **75**: 1–34.
- Gentry, A.H.** and Dodson, C. 1987. Contribution of nontrees to species richness of a tropical rain forest. *Biotropica* **19**: 149–156.
- Gentry, A.H.** and Emmons, L.H. 1987. Geographical variation in fertility, phenology, and composition of the understory of neotropical forests. *Biotropica* **19**: 216–227.
- Getz, W.M.** and Haight, R.G. 1989. *Population Harvesting*. Princeton University Press, Princeton, NJ.
- Gilbert, L.E.** 1980. Food web organization and the conservation of neotropical diversity. In: Soulé, M.E. and Wilcox, B.A. (eds), *Conservation Biology: An evolutionary-ecological perspective*. 11–33. Sinauer Associates, Sunderland, Mass.
- Gillespie, J.H.** 1991. *The Causes of Molecular Evolution*. Oxford University Press, Oxford.
- Gillett, J.B.** 1962. Pest pressure, an underestimated factor in evolution. *Systematics Association Publication* **4**: 37–46.
- Gilpin, M.** 1991. The genetic effective size of a metapopulation. *Biological Journal of the Linnean Society* **42**: 165–175.
- Gilpin, M.E.** 1988. A comment on Quinn and Hastings extinction in subdivided habitats. *Conservation Biology* **2**: 290–292.
- Gilpin, M.E.** 1990. Extinction of finite metapopulation in correlated environments. In Shorrocks, B. and Swingland, I.R. (eds), *Living in a Patchy Environment*. 177–186. Oxford University Press, Oxford.
- Gilpin, M.E.** and Diamond, J.M. 1982. Factors contributing to non-randomness in species co-occurrences on islands. *Oecologia* **52**: 75–84.
- Gilpin, M.E.** and Hanski, I., (eds), 1991 *Metapopulation Dynamics*. Academic Press, London.
- Gilpin, M.E.** and Soulé, M.E. 1986. Minimum viable populations: processes of species extinction. In: Soulé, M.E. (ed.), *Conservation Biology: The science of scarcity and diversity*. 19–34. Sinauer Associates, Sunderland, Mass.
- Gleason, H.A.** 1926. The individualistic concept of the plant association. *Bulletin of the Torrey Botanical Club* **53**: 7–26.
- Glen, W.** 1994. What the impact/volcanism/mass-extinction debates are about. In: Glen, W. (ed.), *The Mass-Extinction Debates: How science works in a crisis*, 7–38. Stanford University Press, Stanford, Calif.
- Goldschmidt, R.B.** 1940. *The Material Basis of Evolution*. Yale University Press, New Haven, Conn.
- Goodman, D. 1987. The demography of chance extinction. In: Soulé, M.E. (ed.), *Viable Populations for Conservation*. 11–34. Cambridge University Press, Cambridge.
- Gould, S.J.** and Eldredge, N. 1977. Punctuated equilibria: the tempo and mode of evolution reconsidered. *Paleobiology* **3**: 115–151.
- Graham, R.W.** 1986a. Response of mammalian communities to environmental changes during the late Quaternary. In: Diamond, J. and Case, T.J. (eds), *Community Ecology*. 300–313. Harper and Row, New York.
- Graham, R.W.** 1986b. Plant-animal interactions and Pleistocene extinction. In: Elliott, D.K. (ed.), *Dynamics of Extinction*. 131–154. John Wiley, New York.
- Graham, R.W.** 1992. Late Pleistocene faunal changes as a guide to understanding effects of greenhouse warming on the mammalian fauna of North America. In: Peters, R.L. and Lovejoy, T.E. (eds), *Global Warming and Biology Diversity*. 76–87. Yale University Press, New Haven, Conn.
- Graham, R.W.** and Lundelius, E.L., Jr 1984. Coevolutionary disequilibrium and Pleistocene extinctions. In: Martin, P.S. and Klein, R.G. (eds), *Quaternary extinction: a prehistoric revolution*, 223–249. University of Arizona Press, Tucson.
- Grant, P.R.** 1986. *Ecology and Evolution of Darwin's Finches*. Princeton University Press, Princeton, NJ.
- Grant, V.** 1963. *Origin of Adaptations*. Columbia University Press, New York.
- Grant, V.** 1981. *Plant Speciation*, 2nd edn. Columbia University Press, New York.
- Gray, J.** 1985. The microfossil record of early land plants: advances in understanding of early terrestrialization, 1970–1984. *Philosophical Transactions of the Royal Society of London, B* **309**: 167–195.
- Greuter, W.** 1995. Extinctions in Mediterranean areas. In Lawton, J.H. and May, R.M. (eds), *Extinction Rates*. 89–97. Oxford University Press, Oxford.
- Groenendael, J.V., De Kroon, H.** and Caswell, H. 1988. Projection matrices in population biology. *Trends in Ecology and Evolution* **3**: 264–269.
- Grubb, P.J.** 1986. Global trends in species-richness in terrestrial vegetation: a view from the northern hemisphere. In: Gee, J.H.R. and Giller, P.S. (eds), *Organization of Communities Past and Present*. 99–118. Blackwell Scientific Publications, London.
- Guensburg, T.E.** and Sprinkle, J. 1992. Rise of echinoderms in the Paleozoic evolutionary fauna: significance of paleoenvironmental controls. *Geology* **20**: 407–410.
- Gurevitch, J., Morrow, L.L., Wallace, A.** and Walsh, J.S. 1992. A meta-analysis of competition in field experiments. *American Naturalist* **140**: 539–572.

- Hafner**, M.S. & Nadler, S.A. 1988. Phylogenetic trees support the coevolution of parasites and their hosts. *Nature* **332**: 258–259.
- Hafner**, M.S., Sudman, P.D., Villablanca, F.X., Spradling, T.A., Demastes, J.W. and Nadler S.A. 1994. Disparate rates of molecular evolution in cospeciating hosts and parasites. *Science* **265**: 1087–1090.
- Hall**, J.B. and Swaine, M.D. 1981. *Distribution and Ecology of Vascular Plants in a tropical Rain Forest*. Dr W. Junk Publishers, The Hague.
- Hallam**, A. 1987. End-Cretaceous mass extinction event: argument for terrestrial causation. *Science* **238**: 1237–1242.
- Hamilton**, W.D. and May, R.M. 1977. Dispersal in stable habitats. *Nature* **269**: 578–581.
- Hansen**, T.A., Farrell, B.R. and Upshaw, B., III 1993. The first 2 million years after the Cretaceous–Tertiary boundary in east Texas; rate and paleoecology of the molluscan recovery. *Paleobiology* **19**: 251–265.
- Hanski**, I. 1981. Coexistence of competitors in patchy environment with and without predation. *Oikos* **37**: 306–312.
- Hanski**, I. 1982. Dynamics of regional distribution the core and satellite species hypothesis. *Oikos* **38**: 210–221.
- Hanski**, I. 1986. Population dynamics of shrews on small islands accord with the equilibrium theory. *Biological Journal of the Linnean Society* **28**: 23–36.
- Hanski**, I. 1989. Metapopulation dynamics: does it help to have more of the same? *Trends in Ecology and Evolution* **4**: 113–114.
- Hanski**, I. 1991. Single-species metapopulation dynamics: concepts, models and observations. *Biological Journal of the Linnean Society* **42**: 17–38.
- Hanski**, I. 1994a. A practical model of metapopulation dynamics. *Journal of Animal Ecology* **63**: 151–162.
- Hanski**, I. 1994b. Patch-occupancy dynamics in fragmented landscapes. *Trends in Ecology and Evolution* **9**: 131–135.
- Hanski**, I. 1994c. Spatial scale, patchiness and population dynamics on land. *Philosophical Transaction of the Royal Society of London, B* **343**: 19–25.
- Hanski**, I. and Hammond, P. 1995. Biodiversity in boreal forests. *Trends in Ecology and Evolution* **10**: 5–6.
- Hanski**, I. and Kuussaari, M. 1995. Butterfly metapopulation dynamics In: Price, P. and Capuccino, N. (eds), *Population Dynamics: New approaches and synthesis*. Academic Press, London (in press).
- Hanski**, I., Kuussaari, M. and Nieminen, M. 1994. Metapopulation structure and migration in the butterfly *Melitaea cinxia* *Ecology* **75**: 747–762.
- Hanski**, I., Pakkala, T., Kuussaari, M. and Lei, G. 1995. Metapopulation persistence of an endangered butterfly in a fragmented environment. *Oikos* **72**: 21–28.
- Hanski**, I. and Thomas, C.D. 1994. Metapopulation dynamics and conservation: a spatially explicit model applied to butterflies. *Biological Conservation* **68**: 167–180.
- Hanski**, I. and Woiwod, I.P. 1993. Spatial synchrony in the dynamics of moth and aphid populations. *Journal of Animal Ecology* **62**: 656–668.
- Harrison**, S. 1991. Local extinction in metapopulation context: an empirical evaluation. In: Gilpin, M.E. and Hanski, I. (eds), *Metapopulation Dynamics*, 73–88. Academic Press, London.
- Harrison**, S. 1994. Metapopulations and conservation. In: Edwards, P.J., May, R.M. and Webb, N.R. (eds), *Large-scale Ecology and Conservation Biology*. 111–128. Blackwell Scientific Publications, Oxford.
- Harrison**, S. and Quinn, J.F. 1989. Correlated environments and the persistence of metapopulations. *Oikos* **56**: 293–298.
- Hartl**, D.L. and Clark, A.G. 1989. *Principles of Population Genetics*, 2nd ed. Sinauer Associates, Sunderland, Mass.
- Hassell**, M.P. 1978. *The Dynamics of Arthropod Predator-prey Systems*. Princeton University Press, Princeton, NJ.
- Hassell**, M.P. and May, R.M. 1988. Spatial heterogeneity and the dynamics of parasitoid–host systems. *Annales Zoologici Fennici* **25**: 55–61.
- Heywood**, V.H. and Stuart, S.N. 1992. Species extinctions in tropical forests. In: Whitmore, T.C. and Sayer, J.A. (eds), *Tropical Deforestation and Species Extinction*. 91–118. Chapman and Hall, London.
- Heywood**, V.H., Mace, G.M., May, R.M. and Stuart, S.N. 1994. Uncertainties in extinction rates. *Nature* **368**: 105.
- Higashi**, M. and Abe, T. 1993. Carbon-nitrogen balance and termite ecology. *Proceedings of the Royal Society of London, B* **246**: 303–308.
- Higashi**, M. and Burns, T.P. 1991. *Theoretical Studies of Ecosystems: The network perspective*. Cambridge University Press, Cambridge.
- Hilbert**, D.W., Swift, D.M., Detling, J.K. and Dyer, M.I. 1981. Relative growth rates and the grazing optimization hypothesis. *Oecologia* **51**: 14–18.
- Hildebrand**, A.R., Penfield, G.T., Kring, D.A., Pilkington, M., Camargo, A., Jacobsen, S.B. and Boynton, W.V. 1991. Chicxulub Crater: a possible Cretaceous/Tertiary boundary impact crater on the Yucatan Peninsula, Mexico. *Geology* **19**: 867–871.
- Hill**, W.G. 1972. Effective size of populations with overlapping generations. *Theoretical Population Biology* **3**: 278–289.
- Hill**, W.G. and Cabellero, A. 1992. Artificial selection experiments. *Annual Review of Ecology and Systematics* **23**: 287–310.
- Hoberg**, E. P. 1986. Evolution and historical biogeography of a host–parasite assemblage: *Alcataenia* spp. (Cyclophyllidae: Dilepididae) in Alcidae (Charadriiformes). *Canadian Journal of Zoology* **64**: 2576–2589.
- Hoffman**, A.A. and Parsons, P.A. 1991. *Evolutionary Genetics and Environmental Stress*. Oxford University Press, Oxford.
- Hollocher**, H., Templeton, A.R., DeSalle, R., and Johnston, J. S. 1992. The molecular through ecological genetics of *abnormal abdomen*. IV. Components of genetic variation in a natural population of *Drosophila mercatorum*. *Genetics* **130**: 355–366.
- Holt**, R.D. 1977. Predation, apparent competition and the structure of prey communities. *Theoretical Population Biology* **12**: 197–229.
- Holt**, R.D. 1984. Spatial heterogeneity, indirect interactions, and the coexistence of prey species. *American Naturalist* **124**: 377–406.
- Holt**, R.D. and Pichering, J. 1985. Infectious disease and species coexistence: a model of Lotka–Volterra form. *American Naturalist* **126**: 196–211.
- Hori**, M. 1987. Mutualism and commensalism in the fish community of Lake Tanganyika. In: Kawano, S., Connell, J.H.

- & Hidaka, T. (eds), *Evolution and Coadaptation in Biotic Communities*. 219–239. University Tokyo Press.
- Hori, M.** 1991. Feeding relationships among cichlid fishes in Lake Tanganyika: effects of intra- and interspecific variations of feeding behaviour on their coexistence. *Ecological International Bulletin* **19**: 89–101.
- Hori, M.** 1993. Frequency-dependent natural selection in the handedness of scale-eating cichlid fish. *Science* **260**: 216–219.
- Horn, H.S.** 1975. Markovian processes of forest succession. In: Cody, M.L. and Diamond, J.M. (eds), *Ecology and Evolution of Communities*, 196–213. Belknap Press, Cambridge, Mass.
- Horodyski, H.J.** and Knauth, P.L. 1994. Life on land in the Precambrian. *Science* **263**: 494–498.
- Houllier, F.** and Lebreton, J.D. 1986. A renewal equation approach to the dynamics of stage-grouped population. *Mathematical Biosciences* **79**: 185–197.
- Howe, H.F.** 1977. Bird activity and seed dispersal of a tropical forest tree. *Ecology* **58**: 539–550.
- Howe, H.F.** 1990. Seed dispersal by birds and mammals: implications for seedling demography. In: Bawa, K.S. and Hadley, M. (eds), *Reproductive Ecology of tropical Forest Plants*. 191–218. UNESCO, Paris.
- Howe, R.W., Davis, G.J., and Mosca, V.** 1991. The demographic significance of 'sink' population. *Biological Conservation* **57**: 239–255.
- Hubbell, S.P., Condit, R. and Foster, R.B.** 1990. Presence and absence of density dependence in a neotropical tree community. *Philosophical Transactions of the Royal Society of London, B* **330**: 269–281.
- Hubbell, S.P. and Foster, R.B.** 1986. Biology, chance, and history and the structure of tropical rain forest tree communities. In: Diamond, J. and Case, T.J. (eds), *Community Ecology*. 314–329. Harper and Row, New York.
- Hunter, M.D., Ohgushi, T. and Price, P.W.** (eds) 1992. *Effects of Resource Distribution on Animal-Plant Interactions*. Academic Press, San Diego.
- Hussner, H.** 1983. Die Faunenwende Perm/Trias. *Geologische Rundschau* **72**: 1–22.
- Huston, M.** 1979. A general hypothesis of species diversity. *American Naturalist* **113**: 81–101.
- Huston, M.A.** 1994. *Biological Diversity. The coexistence of species on changing landscapes*. Cambridge University Press, Cambridge.
- Huston, M.A. and DeAngelis, D.L.** 1994. Competition and coexistence: the effects of resource transport and supply rates. *American Naturalist* **144**: 954–977.
- Hut, P., Alvarez, W., Elder, W.P., Hansen, T., Kauffman, E.G., Keller, G., Shoemaker, E.M. and Weissman, P.R.** 1987. Comet showers as a cause of mass extinctions. *Nature* **329**: 118–1126.
- Hutchinson, G.E.** 1957. Concluding remarks. *Cold Spring Harbor Symposium on Quantitative Biology* **22**: 415–427.
- Hutchinson, G.E.** 1959. Homage to Santa Rosalia, or why are there so many kinds of animals? *American Naturalist* **93**: 145–159.
- Hutchinson, G.E.** 1961. The paradox of the plankton. *American Naturalist* **95**: 137–145.
- Huxley, J.S.** 1942. *Evolution: The modern synthesis*. George Allen and Unwin, London.
- International Union for the Conservation of Nature.** 1995. *IUCN Red List Categories*. Prepared by the IUCN Species Survival Commission, IUCN, Gland.
- Ives, A.R. and May, R.M.** 1985. Competition within and between species in a patchy environment: relations between microscopic and macroscopic models. *Journal of Theoretical Biology* **115**: 65–92.
- Jablonski, D.** 1986a. Causes and consequences of mass extinctions: a comparative approach. In: Elliott, D.K. (ed.), *Dynamics of Extinction*. 183–229. John Wiley, New York.
- Jablonski, D.** 1986b. Background and mass extinction: the alternation of macroevolutionary regimes. *Science* **231**: 129–133.
- Jablonski, D.** 1987. Heritability at the species level: analysis of geographic ranges of Cretaceous mollusks. *Science* **238**: 360–363.
- Jablonski, D.** 1991. Extinctions: a paleontological perspective. *Science* **253**: 754–757.
- Jablonski, D.** 1995. Extinctions in the fossil record. In: Lawton J.H. and May, R.M. (eds), *Extinction Rates*. Oxford University Press, Oxford.
- Jablonski, D. and Flessa, K.W.** 1986. The taxonomic structure of shallow-water marine faunas: implications for Phanerozoic extinction. *Malacologia* **27**: 43–66.
- Jackson, J.B.C.** 1994. Community unity? *Science* **264**: 1412–1413.
- Janis, C.M.** 1993. Tertiary mammal evolution in the context of changing climates, vegetation, and tectonic events. *Annual Review of Ecology and Systematics* **24**: 467–500.
- Janis, C.M. and Damuth, J.** 1990. Mammals. In: McNamara, K.J. (ed.), *Evolutionary Trends*. 301–345. Belhaven, London.
- Janzen, D.H.** 1967. Interaction of the bull's-horn acacia (*Acacia cornigera* L.) with an ant inhabitant (*Pseudomyrmex ferruginea* F. Smith) in Eastern Mexico. *University of Kansas Science Bulletin* **47**: 315–558.
- Janzen, D.H.** 1970. Herbivores and the number of tree species in tropical forests. *American Naturalist* **104**: 501–528.
- Janzen, D.H.** 1980. When is it coevolution? *Evolution* **34**: 611–612.
- Jarzembowski, E. and Ross, A.** 1993. Time flies: the geological record of insects. *Geology Today* 1993: 218–223.
- Jeffreys, A.J. et al.** 1991. Minisatellite repeat coding as a digital approach to DNA typing. *Nature* **354**: 204–209.
- Jeffries, M.J. and Lawton, J.H.** 1984. Enemy-free space and the structure of ecological communities. *Biological Journal of the Linnean Society* **23**: 269–286.
- Jimenez, J.A., Hughes, K.A., Alaks, G., Graham, L. and Lacy, R.C.** 1994. An experimental study of inbreeding depression in a natural habitat. *Science* **266**: 271–273.
- Jin Y., Zhang J. and Shang Q.** 1994. Two phases of the end-Permian mass extinction. *Canadian Society of Petroleum Geologists Memoir* **17**: 813–822.
- Johnson, C.C. and Kauffman, E.E.** 1990. Originations, radiations and extinction of Cretaceous rudistid bivalve species in the Caribbean Province. In: Kauffman, E.G. and Walliser, O. (eds), *Extinction Events in Earth History*. 305–324. Springer-Verlag, Berlin.
- Jones, C.G. and Lawton, J.H.** (eds). 1995. *Linking Species and Ecosystems*. Chapman and Hall, New York.

- Jones, C.G., Lawton, J.H. and Schachak, M.** 1994. Organisms as ecosystem engineers. *Oikos* **69**: 373–386.
- Jordan, C.F.** 1983. Productivity of tropical rain forest ecosystems and the implications for their use as future wood and energy sources. In: Golley, F.B. (ed.), *Ecosystems of the World. Tropical rain forest ecosystems*, 117–136. Elsevier, Amsterdam.
- Kaplan, R.H. and Cooper, W.S.** 1984. The evolution of developmental plasticity in reproductive characteristics: an application of the “adaptive coin flipping” principles. *American Naturalist* **123**: 393–410.
- Kareiva, P.M., Kingslover, J.G. and Huey, R.B.** 1993. *Biotic Interactions and Global Change*. Sinauer Associates, Sunderland, Mass.
- Kauffman, E.G.** 1988. The dynamics of marine stepwise mass extinction. *Revista Española de Paleontología* No. Extraordinario 57–71.
- Kauffman, E.G. and Erwin, D.H.** 1995. Surviving mass extinctions. *Geotimes*, March 1995: 14–17.
- Kauffman, E.G. and Fagerstrom, J.A.** 1993. The Phanerozoic evolution of reef diversity. In: Ricklefs, R.E. and Schluter, D. (eds), *Species Diversity in Ecological Communities*, 315–329. University of Chicago Press, Chicago.
- Keller, G.** 1989. Extended Cretaceous–Tertiary boundary extinctions and delayed population changes in planktonic foraminifera from Brazos River, Texas. *Paleoceanography* **4**: 287–332.
- Kimura, M.** 1983. *The Neutral Theory of Molecular Evolution*. Oxford University Press, Oxford.
- Kitchell, J.A. and Carr, T.R.** 1985. Nonequilibrium models of diversification: faunal turnover dynamics. In: Valentine, J.W. (ed.), *Phanerozoic Diversity Patterns; Profiles in macroevolution*, 277–310. Princeton University Press, Princeton, NJ.
- Knoll, A.H.** 1986. Patterns of change in plant communities through geological time. In: Diamond, J. and Case, T.J. (eds), *Community Ecology*, 126–141. Harper and Row, New York.
- Knoll, A.H.** 1992. The early evolutionary of eukaryotes: a global perspective. *Science* **256**: 622–627.
- Knoll, A.H.** 1994. Proterozoic and Early Cambrian protists: evidence for accelerating evolutionary tempo. *Proceedings of the National Academy of Sciences, USA* **91**: 6743–6750.
- Kunkel, T.A.** 1993. Slippery DNA and diseases. *Nature* **365**: 207–208.
- Labandeira, C.C. and Sepkoski, J.J., Jr.** 1993. Insect diversity in the fossil record. *Science* **261**: 310–315.
- Labandeira, C.C., Beall, B.S. and Hueber, F.M.** 1988. Early insect diversification: evidence from a Lower Devonian bristletail from Quebec. *Science* **242**: 913–916.
- Lack, D.** 1944. Ecological aspects of species-formation in passerine birds. *Ibis*, 1944: 260–286.
- Lahaye, W.S., Gutierrez, R.J. and Akcakaya, H.R.** 1994. Spotted owl metapopulation dynamics in Southern California. *Journal of Animal Ecology* **63**: 775–785.
- Lamberson, R.H., McKelvey, R., Noon, B.R. and Voss, C.** 1994. The effects of varying dispersal capabilities on the population dynamics of the northern spotted owl. *Conservation Biology* (in press).
- Lande, R.** 1976. The maintenance of genetic variability by mutation in a polygenic character with linked loci. *Genetical Research, Cambridge* **26**: 221–235.
- Lande, R.** 1979. Effective deme sizes during long-term evolution estimated from rates of chromosomal rearrangements. *Evolution* **33**: 234–251.
- Lande, R.** 1981. The minimum number of genes contributing to quantitative variation between and within populations. *Genetics* **99**: 541–553.
- Lande, R.** 1987. Extinction thresholds in demographic models of territorial populations. *American Naturalist* **130**: 624–635.
- Lande, R.** 1988a. Genetics and demography in biological conservation. *Science* **241**: 1455–1460.
- Lande, R.** 1988b. Demographic models of the northern spotted owl (*Strix occidentalis caurina*) *Oecologia* **75**: 601–607.
- Lande, R.** 1993. Risks of population extinction from demographic and environmental stochasticity and random catastrophes. *American Naturalist* **142**: 911–927.
- Lande, R. and Barrowclough, G.F.** 1987. Effective population size, genetic variation, and their use in population management. In: Soulé, M.E. (ed.), *Viable Populations for Conservation*, 87–123. Cambridge University Press, Cambridge.
- Lande, R. and Orzack, S.H.** 1988. Extinction dynamics of age-structured populations in a fluctuating environment. *Proceedings of the National Academy of Sciences, USA* **85**: 7418–7421.
- Lander, E.S. and Botstein, D.** 1989. Mapping Mendelian factors underlying quantitative traits using RFLP linkage maps. *Genetics* **121**: 185–199.
- Latham, R. E. and Ricklefs, R.E.** 1993. Continental comparisons of temperate-zone tree species diversity. In: Ricklefs, R.E. and Schluter, D. (eds), *Species Diversity in Ecological Communities*, 294–314. University of Chicago Press, Chicago.
- Lawlor, L.R.,** 1979. Direct and indirect effects of n-species competition. *Oecologia (Berlin)* **43**: 355–364.
- Lawlor, L.R.** 1980. Structure and stability in natural and randomly constructed competitive communities. *American Naturalist* **116**: 394–408.
- Lawton, J.H.** 1984. Non-competitive populations, non-convergent communities, and vacant niches: the herbivores of bracken. In: Strong, D.R., Simberloff, D., Abele, L.G. and Thistle, A.B. (eds), *Ecological Communities: Conceptual issues and evidence*. Princeton University Press, Princeton, NJ.
- Lebreton, J.D. and Clobert, J.** 1991. Bird population dynamics, management, and conservation: the role of mathematical modelling. In: Perrins, C.M., Lebreton, J.D. and Hiron, G.J.M. (eds), *Bird Population Studies: Relevance to conservation and management*. Oxford Ornithology Series, 105–125. Oxford University Press, Oxford.
- Legendre, S., Clobert, J. and Ferrière, R.** 1993. *ULM, Unified Life Models: A user guide*. Special Publications of the Laboratory of Ecology, Ecole Normale Supérieure, Paris.
- Leigh, E.G., Jr.** 1981. The average lifetime of a population in a varying environment. *Journal of Theoretical Biology* **90**: 213–239.
- Lenski, R.E. and Mittler, J.E.** 1993. The directed mutation controversy and neodarwinism. *Science* **259**: 188–194.
- Lerner, J.M.** 1954. *Genetic Homeostasis*. Oliver and Boyd, Edinburgh.
- Levin, S.A. and Paine, R.T.** 1974. Disturbance, patch formation, and community structure. *Proceedings of the National Academy of Sciences, USA* **71**: 2744–2747.

- Levine, S.H.** 1976. Competitive interactions in ecosystems. *American Naturalist* **110**: 903–910.
- Levins, R.** 1969. Some demographic and genetic consequences of environmental heterogeneity for biological control. *Bulletin of the Entomological Society of America* **15**: 237–240.
- Levins, R.** 1970. Extinction. In: Gerstenhaber, M. (ed.), *Some Mathematical Problems in Biology*, 77–107. American Mathematical Society, Providence, RI.
- Levins, R.** 1979. Coexistence in a variable environment. *American Naturalist* **114**: 765–783.
- Lewontin, R.C.** 1964. The interaction of selection and linkage. II. General considerations and heterotic models. *Genetics* **49**: 49–67.
- Lidgard, S.H.** and Crane, P.R. 1988. Quantitative analyses of the early angiosperm radiation. *Nature* **331**: 344–346.
- Lidicker, W.Z., Jr** and Stenseth, N.C. 1992. To disperse or not to disperse: who does it and why? In: Stenseth, N.C. and Lidicker, W.Z., Jr (eds), *Animal Dispersal – Small mammal as a model*, 21–34. Chapman and Hall, London.
- Liem, K.F.** 1973. Evolutionary strategies and morphological innovations in chlid pharyngeal jaws. *Systematic Zoology* **22**: 425–441.
- Loreau, M.** 1989a. Coexistence of temporally segregated competitors in a cyclic environment. *Theoretical Population Biology* **36**: 181–201.
- Loreau, M.** 1989b. On testing temporal niche differentiation in carabid beetles. *Oecologia (Berlin)* **81**: 89–96.
- Loreau, M.** 1992. Species abundance patterns and the structure of ground-beetle communities. *Annales Zoologici Fennici* **28**: 49–56.
- Loreau, M.** 1994. Ground beetles in a changing environment: determinants of species diversity and community assembly. In: Boyle, T.J.B. and Boyle, C.E.B. (eds), *Biodiversity, Temperate Ecosystems and Global Change*, 77–98. Springer-Verlag, Berlin.
- Loreau, M.** 1995. Consumers as maximizers of matter and energy flow in ecosystems. *American Naturalist* **145**: 22–42.
- Lotka, A.J.** 1925. *Elements of Physical Biology*. Reprinted as: *Elements of Mathematical Biology* (1956), Dover Publications, New York.
- Lovejoy, T.E.** 1980. A projection of species extinctions. In: *The Global 2000 Report to the President: Entering the Twenty-First Century. Council on Environmental Quality and the Department of State. U.S.* 328–331. Government Printing Office, Washington, DC.
- Lubchenco, J.** 1978. Plant species diversity in a marine intertidal community: importance of herbivore food preference and algal competitive abilities. *American Naturalist* **112**: 23–39.
- Lynch, M., Burger, R., Butcher, D.** and Gabriel, W. 1993. The mutational meltdown in asexual populations. *Heredity* **84**: 339–344.
- Lynch, M.** and Lande, R. 1993. Evolution and extinction in response to environmental change. In: Kareiva, P.M., Kingsolver, J.G. and Huey, R.B. (eds), *Biotic Interactions and Global Change*, 234–250. Sinauer Associates, Sunderland, Mass.
- MacArthur, R.H.** 1970. Species packing and competitive equilibrium for many species. *Theoretical Population Biology* **1**: 1–11.
- MacArthur, R.H.** 1972. *Geographical Ecology*. Princeton University Press, Princeton, NJ.
- MacArthur, R.H.** and Levins, R. 1967. The limiting similarity, convergence, and divergence of coexisting species. *American Naturalist* **101**: 377–85.
- MacArthur, R.H.** and Wilson, E.O. 1967. *The Theory of Island Biogeography*. Princeton University Press, Princeton, NJ.
- McCallum, H.** and Dobson, A. 1995. Detecting disease and parasite threat to endangered species and ecosystems. *Trends in Ecology and Evolution* **10**: 190–194.
- Macdonald, D.W.** and Smith, H. 1990. Dispersal, dispersion and conservation in the agricultural ecosystem. In: Bunce, R.G.H. and Howard, D.C. (eds), *Species Dispersal in Agricultural Habitats*, 18–64. Belhaven Press, London.
- Mackay, T.F.C.** 1985. Transposable element induced response to artificial selection in *Drosophila melanogaster*. *Genetical Research, Cambridge* **44**: 231–237.
- McKelvey, K.** Noon, B.R. and Lamberson, R.H. 1993. Conservation planning for species occupying fragmented landscapes: the case of the northern spotted owl. In: Kareiva, P.M., Kingsolver, J.G. and Huey, R.B. (eds), *Biotic Interactions and Global Change*, 424–450. Sinauer Associates, Sunderland, Mass.
- MacLeod, K.G.** and Orr, W.N. 1993. The taphonomy of Maastrichtian inoceramids in the Basque region of France and Spain and the pattern of their decline and disappearance. *Paleobiology* **19**: 235–250.
- MacLeod, N.** and Keller, G. 1994. Comparative biogeographic analysis of planktic foraminiferal survivorship across the Cretaceous/Tertiary (K/T) boundary. *Paleobiology* **20**: 143–177.
- McNaughton, S.J.** 1979. Grazing as an optimization process: grass–ungulate relationships in the Serengeti. *American Naturalist* **113**: 691–703.
- Mace, G.M.** 1995. Classification of threatened species and its role in conservation planning. In: Lawton, J.H. and May, R.M. (eds), *Extinction Rates*, 197–213. Oxford University Press, Oxford.
- Magsalay, P., Brooks, T., Dutson, G.,** and Timmins, R. 1995. Extinction and conservation on Cebu. *Nature* **373**: 294.
- Medina, E.** and H. Klinge. 1983. Productivity of tropical forests and tropical woodlands. In: Lange, O.L., Nobel, P.S., Osmond, C.B. and Ziegler, H. (eds), *Physiological Plant Ecology IV*, 281–303. Springer-Verlag, Berlin.
- Mangel, M.** and Tier, C. 1994a. Dynamics of metapopulations with demographic stochasticity and environmental catastrophes. *Theoretical Population Biology* (in press).
- Mangel, M.** and Tier, C. 1994b. Four facts every conservation biologist should know about persistence. *Ecology* **75**: 607–614.
- Maran, T.** and Henttonen, H. 1995. Why is the European mink (*Mustela lutreola*) disappearing? A review of the process and hypothesis. *Annales Zoologici Fennici* (in press).
- Marcot, B.G.** and Holthausen, R. 1987. Analyzing population viability of the spotted owl in the Pacific Northwest. *Transactions North America Aild. National Research Conference* **52**: 333–347.
- Marshall, L.G., Webb, S.D., Sepkoski, J.J., Jr** and Raup, D.M. 1982. Mammalian evolution and the Great American Interchange. *Science* **215**: 1351–1357.

- Martin, P.S.** 1973. The discovery of America. *Science* **179**: 969–974.
- Martin, P.S.** 1993. Primate origins: plugging the gaps. *Nature* **363**: 223–234.
- Martin, P.S.** 1984. Prehistoric overkill: the global model. In: Martin, P.S. and Klein, R.G. (eds), *Quaternary Extinction: A prehistoric revolution*. 354–403. University of Arizona Press, Tucson.
- Martin, P.S.** 1986. Refuting late pleistocene extinction models. In: Elliott D. K. (ed.), *Dynamics of Extinction*. 107–130. John Wiley, New York.
- Martin, P.S.** and Klein, R.G. (eds), 1984. *Quaternary Extinction: A prehistoric revolution*. University of Arizona Press, Tucson.
- Martínez-Ramos, M.** 1994. Regeneración natural y diversidad de especies arbóreas en selvas húmedas. *Boletín de la Sociedad Botánica de México* **54**: 179–224.
- Martínez-Ramos, M.,** Alvarez-Buylla, E.R. and Sarukhán, J.K. 1989. Tree demography and gap dynamics. *Ecology* **70**: 555–557.
- Matsuda, H.,** Abrams, P.A. and Hori, M. 1993. The effect of adaptive anti-predator behavior on exploitative competition and mutualism between predators. *Oikos* **68**: 549–559.
- Matsuda, H.,** Hori, M. and Abrams, P. A. 1994. Effect of predator-specific defence on community complicity. *Evolutionary Ecology* **8**: 628–638.
- May, R.M.** 1973. *Stability and Complexity in Model Ecosystems*. Princeton University Press, Princeton, N.J.
- May, R.M.** 1976. Mathematical aspects of the dynamics of animal populations. In: Levin, S.A. (ed.), *Studies in Mathematical Biology*. American Mathematical Society, Providence, RI.
- May, R.M.** 1976. *Theoretical Ecology*. Blackwell, Oxford.
- May, R.M.** 1978. Host–parasitoid systems in patchy environments: a phenomenological model. *Journal of Animal Ecology* **47**: 833–844.
- May, R.M.** 1988. How many species are there on Earth? *Science* **241**: 1441–1449.
- May, R.M.** 1990. How many species? *Philosophical Transactions of the Royal Society of London, B* **330**: 292–304.
- May, R.M.** 1992. L'inventaire des espèces vivantes. *Pour la Science* **182**: 30–35.
- May, R. M.** 1995. The cheetah controversy. *Nature* **374**: 309–310.
- May, R.M.,** Lawton, J.H. and Nígel, E.S. 1995. Assessing extinction rates. In: Lawton, J.H. and May, R.M. (eds), *Extinction Rates*. Oxford University Press, Oxford.
- May, R.M.** and MacArthur, R.H. 1972. Niche overlap as a function of environmental variability. *Proceedings of the National Academy of Sciences, USA* **69**: 1109–1113.
- Maynard Smith, J.** 1956. Fertility, mating behaviour and sexual selection in *Drosophila subobscura*. *Journal of Genetics* **54**: 261–279.
- Maynard Smith, J.,** Smith, N.H., O'Rourke, M. and Spratt, B.G. 1993. How clonal are bacteria? *Proceedings of the National Academy of Sciences, USA* **90**: 4384–4388.
- Mayr, E.** 1942. *Systematics and the Origin of Species*. Columbia University Press, New York.
- Mayr, E.** 1963. *Animal Species and Evolution*. Harvard University Press, Cambridge, Mass.
- Mayr, E.** 1970. *Populations, Species and Evolution*. Harvard University Press, Cambridge, Mass.
- Mead, J.I.** and Meltzer, D.J. 1984. North American late Quaternary extinctions and the radiocarbon record. In: Martin, P.S. and Klein, R.G. (eds), *Quaternary Extinction: A prehistoric revolution*. 440–450. University of Arizona Press.
- Menge, B.A.** 1995. Indirect effects in marine rocky intertidal interaction webs: patterns and importance. *Ecological Monographs* **65**: 21–74.
- Menge, B.A.** and Lubchenco, J. 1981. Community organization in temperate and tropical rocky intertidal habitats: prey refuges in relation to consumer pressure gradients. *Ecological Monographs* **51**: 429–450.
- Menge, B.A.** and Olson, A.M. 1990. Role of scale and environmental factors in regulation of community structure. *Trends in Ecology and Evolution* **5**: 52–57.
- Menge, B.A.** and Sutherland, J.P. 1987. Community regulation: variation in disturbance, competition, and predation in relation to environmental stress and recruitment. *American Naturalist* **130**: 730–757.
- Menge, B.A.,** Berlow, E.L., Blanchette, C.A., Navarrete, S.A. and Yamada, S.B. 1994. The keystone species concept: variation in interaction strength in a rocky intertidal habitat. *Ecological Monographs* **64**: 249–286.
- Menges, E.S.** 1990. Population viability analysis for an endangered plant. *Conservation Biology* **4**: 52–62.
- Mills, L.S.,** Soulé, M.E. and Doak, D.F. 1993. The keystone-species concept in ecology and conservation. *BioScience* **43**: 219–244.
- Mode, C.J.** and Jacobson, M.E. 1987. On estimating critical population size for an endangered species in the presence of environmental stochasticity. *Mathematical Biosciences* **85**: 185–209.
- Montanari, A.,** Hay, R.L., Alvarez, W., Asaro, F., Michel, H.V., Alvarez, L.W. and Smit, J. 1983. Spheroids at the Cretaceous–Tertiary boundary are altered impact droplets of basaltic composition. *Geology* **11**: 668–671.
- Murdoch, W.W.** and Oaten, A. 1975. Predation and population stability. *Advances in Ecological Research* **9**: 1–131.
- Myers, N.** 1980 *Conversion of Tropical Moist Forests*. National Research Council, National Academy of Sciences, Washington, DC.
- Myers, N.** 1988. Threatened biotas: 'Hot spots' in tropical forests. *The Environmentalist* **8** (3): 187–208.
- Myers, N.** 1992. *The Primary Source*. W.W. Norton, New York.
- Nakai, K.** 1993. Foraging of brood predators restricted by territoriality of substrate-brooders in a cichlid fish assemblage. In: Kawanabe, H., Cohen, J.E. and Iwasaki, K. (eds), *Mutualism and Community Organization: Behavioural, theoretical and food web approaches*. 84–108. Oxford University Press, Oxford.
- Narbonne, G.M.** and Hofmann, H.J. 1987. Ediacaran biota of the Wernecke Mountains, Yukon, Canada. *Palaeontology* **30**: 647–676.
- Nee, S.** and May, R.M. 1992. Dynamics of metapopulations: habitat destruction and competitive coexistence. *Journal of Animal Ecology* **61**: 37–40.
- Nei, M.** 1972. Genetic distance between populations. *American Naturalist* **106**: 283–292.
- Nei, M.** 1987. *Molecular Evolutionary Genetics*. Columbia University Press, New York.

- Nevo, E. 1978. Genetic variation in natural populations. *Theoretical Population Biology* **13**:121–177.
- Newell, N.D. 1967. Revolutions in the history of life. *Geological Society of America Special Paper*, **89**: 63–91.
- Nichols, J.D. and Pollock, K.H. 1983. Estimating taxonomy, diversity, extinction rates and speciation rates from fossil data using capture–recapture data. *Ecology* **73**: 306–317.
- Niklas, K.J., Tiffney, B.H. and Knoll, A.H. 1983. Patterns in vascular land plant diversification. *Nature* **303**: 614–616.
- Niklas, K.J., Tiffney, B.H. and Knoll, A.H. 1985. Patterns in vascular land plant diversification: analysis at the species level. In: Valentine, J.W. (ed.), *Phanerozoic Diversity Patterns: Profiles in macroevolution*. 97–128. Princeton University Press, Princeton, NJ.
- Núñez-Farfán, J. and Dirzo, R. 1988. Within-gap spatial heterogeneity and seedling performance in a Mexican tropical forest. *Oikos* **51**: 274–284.
- Nunney, L. and Campbell, K.A. 1993. Assessing minimum viable population size: demography meets population genetics. *Trends in Ecology and Evolution* **8**: 234–239.
- O'Brien, S.J. and Evermann, J.F. 1988. Interactive influence of infectious disease and genetic diversity in natural populations. *Trends in Ecology and Evolution* **3**: 254–259.
- O'Brien, S.J., Wildt, D.E., Goldman, D., Merrill, C.R. and Bush, M. 1983. The cheetah is depauperate in genetic variation. *Science* **221**: 459–461.
- Officer, C.B. and Drake, C.L. 1983. The Cretaceous-Tertiary transition. *Science* **219**: 1383–1390.
- Olivieri, I., Couvet, D. and Gouyon, P.H. 1990. The genetics of transient populations – research at the metapopulation level. *Trends in Ecology and Evolution* **5**: 207–210.
- Olson, S.L. 1989. Extinction on islands: man as a catastrophe. In: Western, D. and Pearl, M.C. (eds), *Conservation for the Twenty-first Century*. 50–53. Oxford University Press, Oxford.
- Olson, S.L. and James, H.F. 1982. Fossil birds from the Hawaiian Islands: evidence for wholesale extinction by man before western contact. *Science* **217**: 633–635.
- O'Neill, R.V., DeAngelis, D.L., Waide, J.B. and Allen, T.F.H. 1986. *A Hierarchical Concept of Ecosystems*. Princeton University Press, Princeton, NJ.
- O'Neill, R.V. and Shugart, H.H. 1987. Landscape ecology. *BioScience* **37**: 119–127.
- Orians, G. H. 1982. The influence of tree-falls in tropical forests in tree species richness. *Tropical Ecology* **23**: 255–279.
- Orive, M.E. 1993. Effective population size in organisms with complex life histories. *Theoretical Population Biology* **44**: 316–340.
- Orth, C.J., Gilmore, J.S., Knight, J.D., Pillmore, C.L., Tschudy, R.H. and Fassett, J.E. 1981. An iridium abundance anomaly at the palynological Cretaceous–Tertiary boundary in northern New Mexico. *Science* **214**: 1341–1343.
- Orzack, S.H. and Tuljapurkar, S. 1989. Population dynamics in variable environments. VII. The demography and evolution of iteroparity. *American Naturalist* **133**: 901–923.
- Osunkjoya, O.O., Ash, J.E., Hopkins, M.S. and Graham, A.W. 1992. Factors affecting survival of tree seedlings in North Queensland rainforests. *Oecologia* **91**: 569–578.
- Owen, D.F. and Wiegert, R.G. 1976. Do consumers maximize plant fitness? *Oikos* **27**: 488–492.
- Owen-Smith, N. 1987. Pleistocene extinctions: the pivotal role of megaherbivorous mammals. *Paleobiology* **13**: 351–362.
- Page, R.D.M. 1994. Maps between trees and cladistic analysis of historical associations among genes, organisms and areas. *Systematic Biology* **43**: 58–77.
- Paine, R.T. 1966. Food web complexity and species diversity. *American Naturalist* **100**: 65–75.
- Paine, R.T. 1969. A note on trophic complexity and community stability. *American Naturalist* **103**: 91–93.
- Paine, R.T. 1994. *Marine Rocky Shores and Community Ecology: An experimentalist's perspective*. Ecology Institute, Oldendorf/Luhe, Germany.
- Paterson, H.E.H. 1981. The continuing search for the unknown and unknowable: a critique of contemporary ideas on speciation. *South African Journal of Science* **77**: 113–19.
- Patterson, C. and Smith, A. 1987. Is the periodicity of extinctions a taxonomic artefact? *Nature* **330**: 348–382.
- Patterson, C. and Smith, A.B. 1989. Periodicity of extinction: the role of systematics. *Ecology* **70**: 802–811.
- Peters, C.S. and Mangel, M. 1990. New methods for the problem of collective ruin. *SIAM Journal of Applied Mathematics* **50**: 1442–1456.
- Peters, R.H. 1983. *The Ecological Implications of Body Size*. Cambridge University Press, Cambridge.
- Petersson, B. 1985. Extinction on an isolated population of the Middle-spotted Woodpecker *Dendrocopos medius* in Sweden and its relation to genome theories on extinctions. *Biological Conservation* **32**: 335–353.
- Phillips, O.L., Hall, P., Gentry, A.H., Sawyer S.A. and Vasquez, R. 1994. Dynamics and species richness of tropical rain forests. *Proceedings of the National Academy of Sciences, USA* **91**: 2805–2809.
- Pickett, S.T.A. and White, P.S. (eds) 1985. *The Ecology of Natural Disturbance and Patch Dynamics*. Academic Press, New York.
- Pimm, S.L. 1991. *The Balance of Nature? Ecological issues in the conservation of species and communities*. University of Chicago Press, Chicago.
- Pimm, S.L. and Gittleman, J. 1990. Carnivores and ecologists on the roads near Damascus. *Trends in Ecology and Evolution* **4**: 176–178.
- Pimm, S.L., Moulton, M.P. and Justice, L.J. 1995a. Bird extinctions in the central Pacific. In: Lawton, J.H. and May, R.M. (eds), *Extinction Rates*. 75–87. Oxford University Press, Oxford.
- Pimm, S.L., Russell, G.J., Gittleman, J.L. and Brooks, T.M. 1995b. The future of biodiversity. *Science* **269**: 347–350.
- Power, M.E. and Mills, L.S. 1995. The keystone cops meet in Hilo. *Trends in Ecology and Evolution* **10**: 182–184.
- Pinero, D., Martínez-Ramos, M. and Sarukhan, J. 1984. A population model of *Astrocaryum mexicanum* and a sensitivity analysis of its finite rate of increase. *Journal of Ecology* **72**: 977–991.
- Prance, G.T. 1994. A comparison of the efficacy of higher taxa and species numbers in the assessment of biodiversity in the neotropics. *Philosophical Transactions of the Royal Society of London, B* **345**: 89–99.
- Pulliam, H.R. 1988. Sources, sinks, and population regulation. *American Naturalist* **132**: 652–661.

- Pulliam, H.R.** 1994. Sources and sinks: how important is habitat specific demography? In: Rhodes, O.E., Jr (ed.), *Spatial and Temporal Aspects of Population Processes*. First Savannah River Symposium on Environmental Science, University of Georgia. (in press).
- Pulliam, H.R.** and Danielson, B.J. 1991. Sources, sinks, and habitat selection: a landscape perspective on population dynamics. *American Naturalist* **137**: 50–66.
- Quinn, J.F.** and Hastings, A. 1987. Extinction in subdivided habitats. *Conservation Biology* **1**: 198–208.
- Ralls, K., Harvey, P.H.** and Lyles, A.M. 1986. Inbreeding in natural populations of birds and mammals. In: Soulé, M.E. (ed.), *Conservation Biology: The science of scarcity and diversity*. 35–56. Sinauer Associates, Sunderland, Mass.
- Raup, D.M.** 1976. Species diversity in the Phanerozoic: a tabulation. *Paleobiology* **2**: 279–288.
- Raup, D.M.** 1978. Cohort analysis of generic survivorship. *Paleobiology* **4**: 1–5.
- Raup, D.M.** 1979a. Biases in the fossil record of species and genera. *Bulletin of the Carnegie Museum of Natural History* **13**: 85–91.
- Raup, D.M.** 1979b. Size of the Permo-Triassic bottleneck and its evolutionary implications. *Science* **206**: 217–218.
- Raup, D.M.** 1991a. *Extinction. Bad genes or bad luck?* W.W. Norton & Co., New York.
- Raup, D.M.** 1991b. A kill curve for Phanerozoic marine species. *Paleobiology* **17**: 37–48.
- Raup, D.M.** and Sepkoski, J.J., Jr. 1982. Mass extinctions in the marine fossil record. *Science* **215**: 1501–1503.
- Raven, P.H.** 1987. The scope of the plant conservation problem world-wide. In: Bramwell, D., Hamann, O., Heywood, V. and Synge, H. (eds), *Botanic Gardens and the World Conservation Strategy*. 19–29. Academic Press, London.
- Raymond, M., Callaghan, A., Fort, P.** and Pasteur, N. 1991. Worldwide migration of amplified insecticide resistance genes in mosquitoes. *Nature* **350**: 151–153.
- Redford, K. H.** 1992. The empty forest. *Bioscience* **42**: 412–422.
- Reid, W.V.** 1992. How many species will there be? In: Whitmore, T.C. and Sayer, J.A. (eds), *Tropical Deforestation and Species Extinction*. 55–74. Chapman and Hall, London.
- Reid, W.V.** and Miller, K.R. 1989. *Keeping Options Alive: The scientific basis for conserving biodiversity*. World Resources Institute, Washington, DC.
- Retallack, G.J.** 1985. Fossil soils as grounds for interpreting the advent of large plants and animals on land. *Philosophical Transactions of the Royal Society of London, B* **309**: 105–142.
- Retallack, G.J.** 1995. Permian-Triassic life crisis on land. *Science* **267**: 77–80.
- Richter-Dyn, N.** and Goel, N.S. 1972. On the extinction of a colonizing species. *Theoretical Population Biology* **3**: 406–433.
- Ricklefs, R.E.** 1987. Community diversity: relative roles of local and regional processes. *Science* **235**: 167–171.
- Ricklefs, R.E.** and Schluter, D. (eds) 1993. *Species Diversity in Ecological Communities. Historical and geographical perspectives*. University of Chicago Press, Chicago.
- Rolstad, J.** 1991. Consequences of forest fragmentation for the dynamics of bird populations: conceptual issues and the evidence. In: Gilpin, M.E. and Hanski, I. (eds), *Metapopulation Dynamics*. 149–163. Academic Press, London.
- Rosenzweig, M.L.** and Abramsky, Z. 1993. How are diversity and productivity related? In: Ricklefs, R.E. and Schluter, D. (eds), *Ecological Communities: Historical and geographical perspectives*. 52–65. University of Chicago Press, Chicago.
- Runnegar, B., Pojeta, J., Jr, Morris, N.J., Taylor, J.D., Taylor, M.E.** and McClung, G. 1975. *Biology of the Hyolitha Lethaia* **8**: 181–191.
- Sanderson, M.J.** and Donoghue, M.J. 1994. Shifts in diversification rate with the origin of angiosperms. *Science* **264**: 1590–1593.
- Schindewolf, O.** 1963. *Neokatastrophismus?* *Zeitschrift der Deutschen Geologischen Gesellschaft* **114**: 430–445.
- Schluter, D.** and Grant, P.R. 1984. Determinants of morphological patterns in communities of Darwin's finches. *American Naturalist* **123**: 175–196.
- Schoener, T.W.** 1983. Field experiments on interspecific competition. *American Naturalist* **122**: 240–285.
- Schoener, T.W.** 1984. Size differences among sympatric, bird-eating hawks: a worldwide survey. In Strong, D.R., Simberloff, D., Abele, L.G. and Thistle, A. (eds), *Ecological Communities: Conceptual issues and the evidence*. 254–281. Princeton University Press, Princeton, NJ.
- Schoener, T.W.** 1986. Overview: Kinds of ecological communities – ecology becomes pluralistic. In: Diamond, J. and Case, T.J. (eds.), *Community Ecology*. 467–479. Harper and Row, New York.
- Schoener, T.W.** and Spiller, D.A. 1987. High population persistence in a system with high turnover. *Nature* **330**: 474–477.
- Schopf, J.W.** 1992a. Paleobiology of the Archean. In: Schopf, J.W. and Klein, C. (eds), *The Proterozoic Biosphere*. 25–39. Cambridge University Press, Cambridge.
- Schopf, J.W.** 1992b. Patterns of Proterozoic microfossil diversity: an initial, tentative analysis. In: Schopf, J.W. and Klein, C. (eds), *The Proterozoic Biosphere*. 529–552. Cambridge University Press, Cambridge.
- Schopf, J.W.** and Packer, B. 1987. Early Archean (3.3-billion to 3.5-billion-year-old) microfossils from the Warrawoona Group, Australia. *Science* **237**: 70–73.
- Schopf, T.J.M.** 1974. Permo-Triassic extinctions: relation to sea-floor spreading. *Journal of Geology* **82**: 129–143.
- Seilacher, A.** 1989. Vendozoa: organismic construction in the Proterozoic biosphere. *Lethaia* **33**: 229–239.
- Sepkoski, J.J., Jr.** 1981. A factor analytic description of the Phanerozoic marine fossil record. *Paleobiology* **7**: 36–53.
- Sepkoski, J.J., Jr.** 1984. A kinetic model of Phanerozoic taxonomic diversity. III. Post-Paleozoic families and mass extinctions. *Paleobiology* **10**: 246–267.
- Sepkoski, J.J., Jr.** 1988. Alpha, beta, or gamma: where does all the diversity go? *Paleobiology* **14**: 221–234.
- Sepkoski, J.J., Jr.** 1989. Periodicity of extinction and the problem of catastrophism in the history of life. *Journal of the Geological Society of London* **146**: 7–19.
- Sepkoski, J.J., Jr.** 1991. Diversity in the Phanerozoic oceans: a partisan review. In: Dudley, E.C. (ed.), *The Unity of Evolutionary Biology*. 210–236. Dioscorides Press, Portland, Oregon.

- Sepkoski, J.J., Jr. 1992a. Phylogenetic and ecologic patterns in the Phanerozoic history of marine biodiversity. In: Eldredge, N. (ed.), *Systematics, Ecology, and the Biodiversity Crisis*, 77–100. Columbia University Press, New York.
- Sepkoski, J.J., Jr. 1992b. Proterozoic–Early Cambrian diversification of metazoans and metaphytes. In: Schopf, J.W. and Klein, C. (eds.), *The Proterozoic Biosphere*. 553–561. Cambridge University Press, Cambridge
- Sepkoski, J.J., Jr. 1993. Ten years in the library: new data confirm paleontological patterns. *Paleobiology* **19**: 43–51.
- Sepkoski, J.J., Jr, Bambach, R.K., Raup, D.M. and Valentine, J.W. 1981. Phanerozoic marine diversity and the fossil record. *Nature* **293**: 435–437.
- Sepkoski, J.J., Jr. and Kendrick, D.C. 1993. Numerical experiments with model monophyletic and paraphyletic taxa. *Paleobiology* **19**: 168–184.
- Sepkoski, J.J., Jr and Raup, D.M. 1986. Periodicity in marine extinction events. In: Elliott D.K. (ed.), *Dynamics of Extinction*. 3–36. John Wiley, New York.
- Shaffer, M.L. 1981. Minimum population size for species conservation. *BioScience* **31**: 131–134.
- Shaffer, M.L. 1983. Determining minimum viable population sizes for the grizzly bears. *International Conference of Bear Research and Management* **5**: 133–139.
- Shaffer, M.L. 1990. Population viability analysis. *Conservation Biology* **4**: 39–40.
- Sharpton, V.L., Dalrymple, G.B., Marin, L.E., Ryder, G., Schuraytz, B.C. and Urrutia-Fucugauchi, J. 1992. New links between the Chicxulub impact structure and the Cretaceous/Tertiary boundary. *Nature* **359**: 819–821.
- Shields, W.M. 1982. Philopatry, *Inbreeding and the Evolution of Sex*. State University of New York Press, Albany.
- Shields, W.M. 1993. The natural and unnatural history of inbreeding and outbreeding. In: Thornhill, N.W. (ed.), *The Natural History of Inbreeding and Outbreeding*. 143–172. University of Chicago Press, Chicago.
- Signor, P.W. 1990. The geologic history of diversity. *Annual Review of Ecology and Systematics* **21**: 509–539.
- Simberloff, D.S. 1970. Taxonomic diversity of island biotas. *Evolution* **24**: 23–47.
- Simberloff, D. 1986. Are we on the verge of a mass extinction in tropical rain forests? In: Elliott D.K. (ed.), *Dynamics of Extinction*. 165–180. John Wiley, New York.
- Simberloff, D. 1992. Do species–area curves predict extinction in fragmented forest? In: Whitmore T.C. and Sayer J.A. (eds), *Tropical Deforestation and Species Extinction*. 75–90. Chapman and Hall, London.
- Simberloff, D. 1995. Introduced species. In: *Encyclopedia of Environmental Biology*. Vol. 1. Academic Press, San Diego (in press).
- Simberloff, D.S. and Boecklen, W. 1981. Santa Rosalia reconsidered: size ratios and competition. *Evolution* **35**: 1206–1228.
- Simon, H.A. 1977. How complex are complex systems? In: Suppe, F. and Asquith, P.D. (eds), *Proceedings of the 1976 Biennial Meeting of the Philosophy of Science Association*, Vol. 2. Philosophy of Science Association, East Lansing, Michigan.
- Simpson, G.G. 1944. *Tempo and Mode in Evolution*. Columbia University Press, New York.
- Simpson, G.G. 1950. History of the fauna of Latin America. In: Baitshell, G.A. (ed.), *Science in Progress* **7**: 369–408.
- Simpson, G.G. 1953. *The Major Features of Evolution*. Columbia University Press, New York.
- Slatkin, M. 1985. Gene flow in natural populations. *Annual Review of Ecology and Systematics* **16**: 393–430.
- Slatkin, M. 1987. Gene flow and the geographic structure of natural populations. *Science* **236**: 787–792.
- Smith, A.B. 1994. *Systematics and the Fossil Record: Documenting evolutionary patterns*. Blackwell, London.
- Smith, A.T. 1974. Temporal changes in insular populations of the pika *Ochotona princeps* *Ecology* **61**: 8–13.
- Smith, F.D.M., May, R.M., Pellew, R., Johnson, T.H. and Walter, K.R. 1993. How much do we know about the current extinction rate? *Trends in Ecology and Evolution* **8**: 375–378.
- Sogin, M.L., Gunderson, J.H., Elwood, H.J., Alonso, R.A. and Peattie, D.A. 1989. Phylogenetic meaning of the kingdom concept: an unusual ribosomal RNA from *Giardia lamblia* *Science* **243**: 75–77.
- Solbrig, O.T. 1991. *From Genes to Ecosystems: A research agenda for biodiversity*. International Union of Biological Sciences, Paris.
- Soulé, M.E. (ed.) 1987. *Viable Populations for Conservation*. Cambridge University Press, Cambridge.
- Soulé, M.E. 1983. What do we really know about extinctions? In: Schonewald-Cox, C.M., Chambers, S.M., MacBryde, B. and Thomas, W.L. (ed.), *Genetics and Conservation: A reference for managing wild animal and plant populations*. 111–124. Benjamin/Cummings, Menlo Park, Calif.
- Springer, M.S. 1990. The effect of random range truncations on patterns of evolution in the fossil record. *Paleobiology* **16**: 517–520.
- Stanley, S. 1979. *Macroevolution: Pattern and process*. W.H. Freeman, San Francisco.
- Stanley, S.M. 1986. Anatomy of a regional mass extinction: Pliocene decimation of the western Atlantic bivalve fauna. *Palaeos* **1**: 17–36.
- Stanley, S.M. 1988. Paleozoic mass extinctions: shared patterns suggest global cooling as a common cause. *American Journal of Science* **288**: 334–352.
- Stanley, S.M. and Yang, X. 1994. A double mass extinction at the end of the Paleozoic Era. *Science* **266**: 1340–1344.
- Steadman, D.W. 1995. Prehistoric extinctions of Pacific island birds: Biodiversity meets zooarcheology. *Science* **267**: 1123–1131.
- Stearns, S.C. 1992. *The Evolution of Life Histories*. Oxford University Press, Oxford.
- Stebbins, G.L. 1950. *Variation and Evolution in Plants*. Columbia University Press, New York.
- Stehli, F.G., McAlester, A.L. and Helsley, C.E. 1967. Taxonomic diversity of Recent bivalves and some implications for geology. *Geological Society of America Bulletin* **78**: 455–466.
- Strauss, D. and Sadler, P.M. 1989. Classical confidence intervals and Bayesian probability estimates for ends of local taxon ranges. *Mathematical Geology* **21**: 411–427.
- Strelbel, D.E. 1987. Environmental fluctuations and extinction – single species. *Theoretical Population Biology* **27**: 1–26.

- Strong, D.R., Lawton, J.H. and Southwood, T.R.E.** (eds), 1984. *Insects on Plants: Community patterns and mechanisms*. Blackwell Scientific Publications, Oxford.
- Strong, D.R., Szyska, L.A. and Simberloff, D.S.** 1979. Tests of community-wide character displacement against null hypotheses. *Evolution* **33**: 897–913.
- Stucky, R.** 1990. Evolution of land mammal diversity in North America during the Cenozoic. In: Genoways, H.H. (ed.), *Current Mammalogy*. 375–432. Plenum Press, New York.
- Takabayashi, J. and Dicke, M.** 1993. Volatile allelochemicals that mediate interactions in a tritrophic system consisting of predatory mites, spider mites and plants. In: Kawanabe, H., Cohen, J.E. and Iwasaki, K. (eds.), *Mutualism and Community Organization: Behavioural, theoretical and food web approaches*. 280–295. Oxford University Press, Oxford.
- Takamura, K.** 1983. Interspecific relationship between two *aufwuchs* eaters *Petrochromis polyodon* and *Tropheus moorei* of Lake Tanganyika, with a discussion on the evolution and functions of a symbiotic relationship. *Physiological Ecology* **20**: 59–69.
- Teichert, C.** 1986. Times of crisis in the evolution of the Cephalopoda. *Paläontologische Zeitschrift* **60**: 227–243.
- Temple, S.A.** 1986. The problem of avian extinctions. *Current Ornithology* **3**: 453–485.
- Templeton, A.R.** 1986. Coadaptation and outbreeding depression. In: Soulé, M.E. (ed.), *Conservation Biology: The science of scarcity and diversity*. 105–116. Sinauer Associates, Sunderland, Mass.
- Templeton, A.R.** 1989. The meaning of species and speciation. In: Otte, D. and Endler, J.A. (eds), *Speciation and its Consequences*. 3–27. Sinauer Associates, Sunderland, Mass.
- Terborgh, J.** 1986. Keystone plant resources in the tropical forest. In: Soulé, M.E. (ed.), *Conservation Biology: The science of scarcity and diversity*. 330–334. Sinauer Associates, Sunderland, Mass.
- Terborgh, J. and Wright, S.J.** 1994. Effects of mammalian herbivores on plant recruitment in two neotropical forests. *Ecology* **75**: 1829–1833.
- Thayer, C.W.** 1983. Sediment-mediated biological disturbance and the evolution of marine benthos. In: Tevesz, M.J.S. and McCall, P.L. (eds), *Biotic Interactions in Recent and Fossil Benthic Communities*. 480–625. Plenum Press, New York.
- Thomas, C.D.** 1990. What do real population dynamics tell us about minimum viable population sizes? *Conservation Biology* **4**: 324–327.
- Thomas, C.D.** 1995. Local extinctions, colonizations and distributions: habitat tracking by British butterflies. In: Leather, S., Watt, A. and Mills, N. (eds), *Individuals, Populations and Patterns in Ecology*. Blackwell, Oxford (in press).
- Thomas, C.D. and Hanski, I.** 1991. Butterfly metapopulations. In: Hanski, I. and Gilpin, M.E. (eds), *Metapopulation Biology*. Academic Press, London.
- Thompson, J.N. and Burdon, J.J.** 1992. Gene-for-gene co-evolution between plant and parasite. *Nature* **360**: 121–125.
- Thornhill, N.W.** 1993. *The Natural History of Inbreeding and Outbreeding*. University of Chicago Press, Chicago.
- Tilman, D.** 1982. *Resource Competition and Community Structure*. Princeton University Press, Princeton, NJ.
- Tilman, D.** 1994. Competition and biodiversity in spatially structured habitats. *Ecology* **75**: 2–16.
- Tuljapurkar, S.D.** 1990. Population dynamics in variable environments. *Lecture Notes in Biomathematics 85* Springer-Verlag, New York.
- Turelli, M. and Barton, N.H.** 1989. Evolutionary quantitative genetics – how little do we know? *Annual Review of Genetics* **23**: 337–370.
- Turner, M.G.** 1989. Landscape ecology: the effect of pattern on process. *Annual Review of Ecology and Systematics* **20**: 171–197.
- Valdes, A.M., Slatkin, M. and Freimer, N.G.** 1993. Allele frequencies at microsatellite loci – the stepwise mutation model revisited. *Genetics* **133**: 737–749.
- Valencia, R., Balslev, H. and G. Paz y Mio C.** 1994. High tree alpha-diversity in Amazonian Ecuador. *Biodiversity and Conservation* **3**: 21–28.
- Valentine, J.W.** 1969. Patterns of taxonomic and ecological structure of the shelf benthos during Phanerozoic time. *Palaeontology* **12**: 684–709.
- Valentine, J.W.** 1971. Plate tectonics and shallow water diversity and endemism, an actualistic model. *Systematic Zoology* **20**: 253–264.
- Valentine, J.W. and Jablonski, D.** 1993. Fossil communities: compositional variation at many time scales. In: Ricklefs, R.E. and Schuller, D. (eds), *Species Diversity in Ecological Communities*. 341–348. University of Chicago Press, Chicago.
- Valentine, J.W., Theodore, C.F. and David, P.** 1978. A provincial model of Phanerozoic marine diversity. *Paleobiology* **4**: 55–66.
- Valentine, J.W., Tiffney, B.H. and Sepkoski, J.J., Jr.** 1991. Evolutionary dynamics of plants and animals: a comparative approach. *Palaos* **6**: 81–88.
- Van Dorp, D. and Opdam, P.F.M.** 1987. Effects of patch size, isolation and regional abundance on forest bird communities. *Landscape Ecology* **1**: 59–73.
- Van Valen, L.M.** 1985. How constant is extinction? *Evolutionary Theory* **7**: 93–106.
- Van Valkenburgh, B. and Janis, C.M.** 1993. Historical diversity patterns in North American large herbivores and carnivores. In: Ricklefs, R.E. and Schluter, D. (eds), *Species Diversity in Ecological Communities*. 330–340. University of Chicago Press, Chicago.
- Vartanyan, S.L., Garutt, V.E. and Sher, A.V.** 1993. Holocene dwarf mammoths from Wrangel Island in the Siberian Arctic. *Nature* **362**: 337–340.
- Vermeij, G.J.** 1977. The Mesozoic marine revolution: evidence from snails, predators, and grazers. *Paleobiology* **3**: 245–258.
- Vermeij, G.J.** 1987. *Evolution and Escalation: An ecological history of life*. Princeton University Press, Princeton, NJ.
- Vermeij, G.J.** 1989. Geographical restriction as a guide to the causes of extinction: the case of the cold northern oceans during the Neogene. *Paleobiology* **15**: 335–354.
- Vermeij, G.J.** 1991a. Anatomy of an invasion: the trans-Arctic interchange. *Paleobiology* **17**: 281–307.
- Vermeij, G.J.** 1991b. When biotas meet: understanding biotic interchange. *Science* **253**: 1099–1104.
- Vermeij, G.J.** 1995. Economics, volcanoes, and Phanerozoic revolutions. *Paleobiology* **21**: 125–152.

- Verneau, O.** 1994. *Evolution des Interactions durables: Phylogénies et Rythmes d'Evolution moléculaire dans l'association Poissons (Téléostéens) – Helminthes (Cestodes)*. Unpublished PhD thesis, Université de Paris-Sud, France.
- Vidal, G. and Knoll, A.H.** 1982. Radiations and extinctions of plankton in the Late Proterozoic and Early Cambrian. *Nature* **297**: 57–60.
- Visscher, H. and Brugman, W.A.** 1988. The Permian-Triassic boundary in the Southern Alps: a palynological approach. *Memorie della Societa Geological Italiana* **34**: 121–128.
- Vitousek, P.M.** 1988. Diversity and biological invasions of oceanic islands. In: Wilson, E.O. and Peter, F.M. (ed.), *Biodiversity*. 181–189. National Academy Press, Washington, DC.
- Volterra, V.** 1926. Variazioni e fluttuazioni del numero d'individui in specie animali conviventi. *Mem. Acad. Lincei* **2**: 31–113.
- Vrba, E.S.** 1992. Mammals as a key to evolutionary theory. *Journal of Mammalogy* **73**: 1–28.
- Wade, M.J. and McCauley, D.** 1988. Extinction and recolonization: their effects on the genetic differentiation of local populations. *Evolution* **42**: 995–1005.
- Warren, M.S.** 1992. The conservation of British butterflies. In: Dennis, R.L.H. (ed.), *The Ecology of Butterflies in Britain*. Oxford Science Publications, Oxford.
- Waser, N.M. and Price, M.V.** 1989. Optimal outcrossing in *Ipomopsis aggregata*: seed set and offspring fitness. *Evolution* **43**: 1097–1109.
- World Conservation Monitoring Centre (WCMC).** 1992. *Global Biodiversity: Status of the Earth's living resources*. Chapman and Hall, London.
- Webb, S.D.** 1989. The fourth dimension in North American terrestrial mammal communities. In: Morris, D.W., Abramsky, B., Fox, J. and Willis, M.R. (eds), *Patterns in the Structure of Mammalian Communities*. Special Publication 28. 181–203. Museum of Texas Technical University, Lubbock.
- Webb, S.D.** 1991. Ecogeography and the Great American Interchange. *Paleobiology* **17**: 266–280.
- Webb, T., III.** 1992. Past changes in vegetation and climate: lessons for the future. In: Peters, R.L. and Lovejoy, T.E. (eds), *Global Warming and Biological Diversity*. Yale University Press, New Haven, Conn.
- Weber, J.L. and Wong, C.** 1993. Mutation of human short tandem repeats. *Human Molecular Genetics* **2**: 1123–1128.
- Weir, B.S.** 1990. *Genetic Data Analysis*. Sinauer Associates, Sunderland, Mass.
- Welden, C. W., Hewett, S.W. Hubbell, S.P. and Foster, R.B.** 1991. Sapling survival, growth, and recruitment: relationship to canopy height in a neotropical forest. *Ecology* **72**: 35–50.
- Weiss, S.B., Murphy, D.D., Ehrlich, P.R. and Metzler, C.F.** 1993. Adult emergence phenology in checkerspot butterflies: the effects of macroclimate, topclimate, and population history. *Oecologia* **96**: 261–270.
- Western, D.** 1992. The biodiversity crisis: a challenge for Biodiversity. *Oikos* **63**: 29–38.
- White, M.J.D.** 1978. *Modes of Speciation*. W.H. Freeman, San Francisco.
- Whitmore, T.C.** 1975. *Tropical Rain Forests of the Far East*. Clarendon Press, Oxford.
- Wiens, J.A.** 1989. *The Ecology of Bird Communities*, Vols. 1 and 2. Cambridge University Press, Cambridge.
- Wiens, J.A., Stenseth, N.C., Van Horne, B. and Ims, R.A.** 1993. Ecological mechanisms and landscape ecology. *Oikos* **66**: 369–380.
- Wignall, P. and Hallam, A.** 1992. Anoxia as a cause of the Permian/Triassic mass extinction: facies evidence from northern Italy and the western United States. *Palaeogeography, Palaeoclimatology, Palaeoecology* **93**: 21–46.
- Wilcove, D.S.** 1985. Net predation in forest tracks and the decline of migratory songbirds. *Ecology* **66**: 1211–1214.
- Williams, C.B.** 1964. *Patterns in the Balance of Nature*. Academic Press, New York.
- Williams, P.H. and Gaston, K.J.** 1994. Measuring more of biodiversity: can higher-taxon richness predict wholesale species richness? *Biological Conservation* **67**: 211–217.
- Williamson, M.** 1981. *Island Populations*. Oxford University Press, Oxford.
- Wilson, D.S.** 1980. *The Natural Selection of Populations and Communities*. Benjamin/Cummings, Menlo Park, Calif.
- Wilson, E. O.** 1988a. The diversity of life. In: Ham J. De Blij (ed.), *Earth '88: Changing geographic perspectives*. 68–78. National Geographic Society, Washington, DC.
- Wilson, E.O.** 1988b. The current state of biological diversity. In: Wilson, E.O. and Peter, F.M. (eds.), *Biodiversity*. 3–18. National Academy Press, Washington, DC.
- Wilson, E.O.** 1992. *The Diversity of Life*. Belknap Press, Cambridge, Mass.
- Winston, J.E.** 1992. Systematics and marine conservation. In: Eldredge, N. (ed.), *Systematics, Ecology, and the Biodiversity Crisis*. 144–168. Columbia University Press, New York.
- Wolin, C.L.** 1985. The population dynamics of mutualistic systems. In: Boucher, D. (ed.), *The Biology of Mutualism: Ecology and evolution*. Croom Helm, London.
- Wootton, J.T.** 1994. Predicting direct and indirect effects: an integrated approach using experiments and path analysis. *Ecology* **75**: 151–165.
- Wootton, J.T. and Bell, D.A.** 1992. A metapopulation model of the peregrine falcon in California: viability and management strategies. *Ecological Applications* **2**: 307–321.
- Wright, S.** 1931. Evolution in Mendelian populations. *Genetics* **16**: 97–159.
- Wright, S.** 1938. Size of population and breeding structure in relation to evolution. *Science* **87**: 430–431.
- Wright, S.** 1970. Random drift and the shifting balance theory of evolution. In: Kojima, K. (ed.), *Mathematical Topics in Population Genetics*. 1–31. Springer-Verlag, Berlin.
- Wright, S.** 1978. *Evolution and the Genetics of Populations*. Vol. 4. *Variability within and among natural populations*. University of Chicago Press, Chicago.
- Wright, S.** 1992. Seasonal drought, soil fertility, and the species diversity of tropical forest plant communities. *Trends in Ecology and Evolution* **7**: 260–263.
- Xu, G.** 1991. Stratigraphical time-correlation and mass extinction event near Permian–Triassic boundary in South China. *Journal of the Chinese University of Geosciences* **2**: 36–46.
- Yablakov, Y.** 1974. *Variability in Mammals*. Amerind Co., Springfield, Va.

- Yodzis, P.** 1988. The indeterminacy of ecological interactions as perceived through perturbation experiments. *Ecology* **69**: 508–515.
- Yuma, M.** 1993. Competitive and cooperative interactions in Lake Tanganyika fish communities. In: Kawanabe, H., Cohen, J.E. & Iwasaki, K. (eds), *Mutualism and Community Organization: Behavioural, theoretical and food web approaches*, 213–227. Oxford University Press, Oxford.
- Zonneveld, I.S.** and Forman, R.T.T. 1990. *Changing Landscapes: An ecological perspective*. Springer-Verlag, Berlin.

5

Biodiversity and Ecosystem Functioning: Basic Principles

H.A. MOONEY, J. LUBCHENCO, R. DIRZO, O.E. SALA

Lead Authors:

J.H. Cushman, R. Dirzo, A.C. Janetos, J. Lubchenco, H.A. Mooney, O.E. Sala (Chapter 5.0); P.R. Ehrlich (Chapter 5.1); A.R. Templeton (Chapter 5.2.1); F.S. Chapin III, J. Lubchenco, H.L. Reynolds (Chapter 5.2.2), S. Harrison (Chapter 5.2.3); I.C. Burke, W.K. Lauenroth (Chapter 5.2.4); S.T.A. Pickett (Chapter 5.3.1); O.E. Sala (Chapter 5.3.2); J.H. Cushman, R. Dirzo, A.C. Janetos, J. Lubchenco, H.A. Mooney, O.E. Sala (Chapter 5.4)

Contributors:

J.H. Cushman, R. Dirzo, A.C. Janetos, H.A. Mooney, O.E. Sala, W.J. Bond, J.C. Castilla, G. Daily, J.A. Estes, J. Lubchenco, B.A. Menge, L.S. Mills, R.T. Paine, M. Power, N.G. Smith, D. Tilman (Chapter 5.2.2); O.E. Sala, P.M. Fearnside, C. Changdu, M.G. Turner (Chapter 5.2.4); S.R. Carpenter (Chapter 5.3.1); E.H. Bucher (Chapter 5.3.2)

CONTENTS

Executive Summary	279	References	303
5.0 Introduction	281	5.2.4 Biodiversity at landscape to regional scales	304
5.0.1 Background	281	5.2.4.1 Introduction	304
5.0.2 Important concepts	281	5.2.4.2 Diversity and ecosystem functioning at landscape to regional scales	305
5.0.3 Section organization	282	5.2.4.3 Keystone ecosystems	307
References	282	5.2.4.4 Land-use diversity	308
		5.2.4.5 Summary	310
5.1 Context: biodiversity and ecosystem services	282	References	310
References	285		
5.2 Functional properties of biodiversity: a hierarchical perspective	285	5.3 Drivers and dynamics of changes in biodiversity	311
5.2.1 Genetic diversity and ecosystem functioning	285	5.3.1 Overview of disturbance	311
References	287	5.3.1.1 Characteristics of disturbance	311
5.2.2 Biodiversity effects on patterns and processes of communities and ecosystems	289	5.3.1.2 Relationship of disturbance to other ecological processes	312
5.2.2.1 Introduction	289	5.3.1.3 Principles of disturbance	313
5.2.2.2 Relationship between species and the functioning of ecological communities and ecosystems: hypotheses concerning similarity amongst species	289	5.3.1.4 Disturbance and management	315
5.2.2.3 Key concepts and terms	291	References	316
5.2.2.4 Integrated framework	291	5.3.2 Human-induced perturbations on biodiversity	318
5.2.2.5 Effects of diversity <i>per se</i> on ecosystem processes	292	5.3.2.1 Introduction	318
5.2.2.6 Mechanisms of community and ecosystem change due to species traits	293	5.3.2.2 Changes in land and water use	318
5.2.2.7 Ecosystem-level feedbacks to biodiversity of invasions and extinctions	297	5.3.2.3 Changes in atmospheric composition	319
5.2.2.8 Conclusions	297	5.3.2.4 Climate change	319
References	298	5.3.2.5 Conclusions	321
5.2.3 Effects of spatial structure on ecosystem functioning	301	References	321
5.2.3.1 Introduction	301	5.4 Conclusions	323
5.2.3.2 Effects of spatial structure on species diversity and abundance	301	5.4.1 Background	323
5.2.3.3 Effects of spatial structure on species interactions	302	5.4.2 What are the influences of genetic diversity on ecosystem functioning?	323
5.2.3.4 Spatial structure and ecosystems	303	5.4.3 What are the influences of species diversity on ecosystem functioning?	323
		5.4.4 What are the influences of landscape diversity on ecosystem functioning?	324
		5.4.5 What are the human influences on ecosystem functioning?	324
		5.4.6 What are the management implications for goods and services?	325
		5.4.7 Summary	325

EXECUTIVE SUMMARY

The chapters in this section explore the ways in which diversity, at various levels, influences the functioning of ecosystems and how this, in turn, relates to human needs.

1. Ecosystems are composed of all the individuals of all the species in a given area, and their physical environment. Ecosystems provide free services to society including clean water, pure air, soil formation and protection, pest control, foods, fuel, fibres and drugs.
 2. The loss of genetic variability within the populations of a species in a given area reduces the flexibility of those species to adjust to environmental changes (such as climate changes, for example) and narrows the options available for the rehabilitation of specific habitats.
 3. The addition or deletion of a species can have profound effects on the capacity of an ecosystem to provide ecosystem services.
 4. We are beginning to develop the capacity to predict which species will cause the greatest system impacts, and hence the greatest ecosystem service changes, when added or deleted.
 - (a) Species with unique traits for fixing nitrogen, capturing water, emitting trace gases, and so forth, when added or deleted will have profound effects on the functioning of an ecosystem. These effects can be predicted *a priori*.
 - (b) Certain other species, without readily recognized specialized traits, when added or deleted may also have profound effects on the capacity of ecosystems to provide services. These are so-called 'keystone' species. With our current state of knowledge, their potential effects can only be assessed by direct experimentation.
 5. Based on the latest evidence, the capacity of ecosystems to resist changing environmental conditions, and to rebound from unusual climatic or biotic events, is related positively to species numbers.
 6. Fragmentation and disturbance of ecosystems and of landscapes will have profound effects on the services provided, since these impacts shift the balance of the kinds of species present - from large, long-lived species to small, short-lived ones. These shifts reduce the capacity of the systems to store nutrients, sequester carbon and provide pest protection, among other things.
 7. The simplification of ecosystems to obtain higher yields of individual products comes at the cost of the loss of ecosystem stability and of free services such as controlled nutrient delivery and pest control, which thus need to be subsidized by the use of fertilizers and pesticides.
 8. Modification of ecosystems by the introduction of alien species, either deliberately or accidentally, has positive and negative ecosystem effects - but too often the latter because of the reduced biotic controls on the invading species.
 9. We have been more successful in simplifying than in reconstructing complex ecosystems. Our lack of success in ecosystem restoration suggests that great caution should be exercised in reducing biodiversity through management practices because of the potential loss of goods and services in the long term.
-

5.0 Introduction

5.0.1 Background

Does it make any difference to the functioning of an ecological system if there are many species or only a few? Are species that perform similar functions within an ecosystem interchangeable, or do they differ in ways that matter to the workings of the system? Does the genetic diversity of species affect the sustainability of ecosystem-level functions? How does diversity among ecosystems affect the flow of energy, water or chemicals across the landscape? What are the ecosystem-level ramifications of human-driven changes in biodiversity?

Addressing these questions requires an understanding of the relationships between biological diversity and ecosystem functioning, and thus the functional consequences of changes in biological diversity. The importance of this topic is underscored by the realization that the provision of marketable goods and free ecological services are essential features of humankind's interest in and benefit from the biosphere's diversity. The explosive growth of the human population and its use of resources, energy and land are resulting in massive changes in diversity at a variety of levels throughout the world. Some of these changes, such as extinction of species, are truly irreversible; while others are not, but the challenge of managing natural resources in a sustainable manner has clearly increased. Increases in our understanding of the relationships between changes in biological diversity and the functioning of ecosystems can help improve a wide range of policies involving agriculture, forestry, fisheries and land use, transcending traditional conservation-based policies. Assessing our knowledge of the general principles of the relationships between diversity and the functioning of ecological systems is the focus of this Section.

Understanding the functional implications of biodiversity requires that issues addressed in population and community ecology be merged with those in ecosystems ecology. Each of these areas of ecology has developed research traditions largely without interaction with the other. However, in the past decade, there have been a number of attempts to bridge these two approaches (Vitousek *et al.* 1987; Vitousek 1990; Schulze and Mooney 1993; Naeem *et al.* 1994; Tilman and Downing 1994; Jones and Lawton 1995). International scientific reviews by SCOPE (Mooney *et al.* 1995) aimed at understanding the relationship between biodiversity and ecosystem functioning, and the broader approach by the Diversitas programme of IUBS and UNESCO (Solbrig 1991) designed to also analyse the origins, maintenance and monitoring of diversity, have played a critical role in the preparation of Sections 5 and 6 of the GBA.

5.0.2 Important concepts

The term biodiversity has frequently been equated with diversity of species. The strength of the term is its

simplicity. However, understanding the functional significance of biodiversity necessitates teasing apart the rich and multiple dimensions of the concepts underlying the term (see Section 1). There are four key concepts to consider: (1) the levels of biological and ecological organization and their interactions, (2) the numbers of different biological units within each level, (3) the influence and degree of similarity in the traits or roles that biological and ecological units within each level play, and (4) the spatial configuration of the units within any level. For example, at the species level we need to consider whether there are functional consequences of the total numbers of different species, whether the degree of similarity in their functional roles or traits has ecosystem-level consequences, and whether the spatial configuration of the species influences ecosystem functioning.

Ecological systems can be viewed at increasing levels of organization: genetic, population, species, community, ecosystem and landscape. Patterns and processes at any particular level affect not only the target level, but also the levels above and below. Because ecosystems provide ecological goods and services to humanity, the assessment in the following chapters is focused generally on the ecosystem level, but includes relevant functioning at lower and higher levels.

We use the term 'ecosystem' to refer to all the individuals, species and populations in a spatially defined area, the interactions among them, and those between the organisms and the abiotic environment (Likens 1993; see Section 2.3). 'Ecosystem functioning' denotes the sum total of processes operating at the ecosystem level, such as the cycling of matter, energy and nutrients, as well as those processes operating at lower ecological levels which impact on patterns or processes at the ecosystem level. Interactions among species or the transfer of genetic material are examples of some of the lower level processes that are immediately relevant to the ecosystem consequences of biodiversity. Thus, in the following sections, patterns of diversity at the genetic, species, community and ecosystem levels are related to key functional properties of ecosystems.

Following other syntheses (Lubchenco *et al.* 1991), we use the term 'ecological system' to refer to the characteristics or functioning of organisms, populations, communities or ecosystems at a level that is appropriate to the particular questions being asked. Thus, it is analogous to the use of the word 'taxon' by systematists.

The roles of different species and the extent to which they overlap in function have been a common theme in community ecology. The concepts of 'keystone species', 'redundancy', 'compensation', 'functional groups' and 'rivets' all deal with the extent to which individuals or species overlap in function, and the consequences of this overlap to the system. An understanding of unique species'

traits, overlap among species, and the possible functional significance of low or high numbers of species, apart from how they differ in traits, is clearly immediately relevant to understanding the conditions under which 'species matter'. Historically less attention has been paid to the equivalent questions dealing with functional overlap among genes or ecosystems. Nonetheless, comparable information is now recognized as immediately relevant to conservation and management.

The third important topic of interest to the relation between diversity and the functioning of ecological systems is that of the spatial configuration of the units within the system. For example, knowing the consequences of different habitat or ecosystem configurations to the functional properties of landscapes would enhance the design of reserves as well as the management of resources. Knowing how the populations within an ecosystem are distributed in space would enhance our ability to predict its functional resilience to stress from pathogens and environmental variability.

5.0.3 Section organization

Chapter 5.1 begins with an exploration of the social and political context within which the study of biodiversity and ecosystem functioning occurs. Why should society care? In particular, it considers the notion that one of the very important aspects of ecosystem functioning that depends on diversity is the provision of goods and services, and the provision of insurance against adverse changes due to stress or environmental variability.

Chapter 5.2 then considers how the diversity of the natural world is organized, and how diversity at each level of organization affects ecosystem functioning. Subsection 5.2.1 addresses the question of the extent to which intraspecific genetic variation is important in understanding the relationship between biodiversity and ecosystem functioning; 5.2.2 addresses the degree to which we can predict the ecosystem-level consequences of species additions, deletions and replacements, and synthesizes the state of knowledge with respect to the processes that determine the importance of species and communities in ecosystem-level functioning; 5.2.3 addresses the spatial structure of populations, its effect on abundance, species interactions and life-history characteristics, and the subsequent consequences for ecosystem functioning and 5.2.4 analyses the larger spatial scales of landscapes and regions, in which human activities exert large influences, and considers how the relationships of diversity and functioning at these scales are similar to, or different from the relationships at other levels of organization.

Chapter 5.3 considers the drivers and dynamics of changes in biodiversity, and their subsequent consequences for ecosystem functioning. Subsection 5.3.1 assesses our knowledge of disturbance as a factor that

strongly affects the structure and function of ecological systems, and examines closely the role that different intensities and frequencies of disturbance have in determining species diversity within ecosystems, while 5.3.2 reviews the influence of human-driven changes in diversity due to changes in land use and resource use, atmospheric composition and climate change, and the potential or realized consequences for ecosystem and landscape/regional-scale functioning.

The Conclusion to Section 5 summarizes key findings and provides a synthesis of the general patterns and principles relating biodiversity and ecosystem functioning.

References

- Jones, C.G. and Lawton, J.H. (eds) 1995. *Linking species and ecosystems: Fifth Cary Conference, Millbrook, New York, USA. May 8–12, 1993*. xvii+387. Chapman and Hall, New York.
- Jones, C.G., Lawton, J.H. and Shachak, M. 1994. Organisms as ecosystem engineers. *Oikos* **69**: 73–86.
- Likens, G.E. 1993. Human-accelerated environmental change: an ecologist's view. *Bulletin of the Ecological Society of America* **74**: 331.
- Lubchenco, J., Olson, A.M., Brubaker, L.B., Carpenter, S.R., Holland, M.M., Hubbell, S.P., Levin, S.A., MacMahon, J.A., Matson, P.A., Melillo, J.M., Mooney, H.A., Peterson, C.H., Pulliam, H.R., Real, L.A., Regal, P.A. and Risser, P.G. 1991. The sustainable biosphere initiative: an ecological research agenda. *Ecology* **72**: 371–412.
- Mooney, H.A., Cushman, J.H., Medina, E., Sala, O. and Schulze, E.-D. (eds). *Functional Roles of Biodiversity: A global perspective*. John Wiley, Chichester (in press).
- Naeem, S., Thompson, L.J., Lawler, S.P., Lawton, J.H. and Woodfin, R.M. 1994. Declining biodiversity can alter the performance of ecosystems. *Nature* **368**: 734–737.
- Schulze, E.-D. and Mooney, H.A. (eds) 1993. *Biodiversity and Ecosystem Function*. Springer-Verlag, Berlin.
- Solbrig, O.T. (ed.) 1991. *From Genes to Ecosystems: A research agenda for biodiversity*. IUBS, Paris.
- Tilman, D. and Downing, J.A. 1994. Biodiversity and stability in grasslands. *Nature* **367**: 363–365.
- Vitousek, P.M. 1990. Biological invasions and ecosystem processes: towards an integration of population biology and ecosystem studies. *Oikos* **57**: 7–13.
- Vitousek, P.M. and Walker, L.R. 1987. Colonization succession and resource availability: ecosystem-level interactions. In: Gray, A.J.M., Crawley, M. and Edwards, P.J. (eds), *Colonization, Succession and Stability*. 207–223. Blackwell Scientific Publications, Oxford.

5.1 Context: biodiversity and ecosystem services

The conditions and processes characterizing natural ecosystems supply humanity with an array of free services upon which society depends. These include: maintenance of the gaseous quality of the atmosphere (which in turn helps to regulate climate); amelioration of the weather;

control of the hydrological cycle (including reduction of the probability of serious floods and droughts); protection of coastal zones by generating and conserving coral reef and sand dune systems; generation and conservation of fertile soils, which are essential to agriculture and forestry; dispersal and breakdown of wastes and cycling of nutrients; control of the vast majority of potential crop pests and vectors of disease; pollination of many crops, and direct provision of food from sea and land; and the maintenance of a vast 'genetic library' from which *Homo sapiens* has already extracted the very basis of civilization in the form of crops, domestic animals, medicines and industrial products (Ehrlich and Ehrlich 1981, 1992).

One of the most important questions in ecology – indeed, one of the most important ones facing humanity – is the degree to which some overall level of biodiversity is required for the delivery of ecosystem services (Ehrlich 1993). This question is ordinarily interpreted to mean 'what is the minimum fraction, of the estimated 13.5 million species now extant, required to keep ecosystems functioning so that they can continue to supply these services?' In other words, how much of the world's species diversity is redundant? Would a 'weedy' world (see 5.2.3) from which most species diversity had been lost remain hospitable to humanity? If not, where on the continuum between today's species richness and a species-poor planet would one expect a serious deterioration of services? It is clear that many ecosystem services are already faltering: maintenance of the mix of gases in the atmosphere is an obvious example. Deforestation is partially responsible, and is associated with major losses of species diversity. In this case, however, as in most others, it is not possible to determine the degree to which species loss will impair the services in the long term. One can imagine polycultures substituted for natural forests that would sequester carbon, reduce nitrous oxide fluxes and otherwise help stabilize atmospheric composition. Similarly, ice plant (*Mesembryanthemum crystallinum*) and Bermuda grass (*Cynodon dactylon*) might hold soils in place in many parts of the world as thoroughly as species-rich mixes of native plants. Eucalyptus trees transpire, break the force of rain, protect soils, and thus contribute to regular flows of fresh water in California – possibly just as well as native live oaks. They also can provide the shade and wind-screening functions of a diversity of indigenous trees. It may be that most species are redundant from the viewpoint of ecosystem services, as suggested by Walker (1992) and developed further by Lawton and Brown (1993) – the so-called 'redundant species hypothesis' (see further discussion in 5.2.2). Even looking at the short term, it seems unlikely, however, that this is the case (e.g. Naeem *et al.* 1994).

The ability of a monoculture to maintain services becomes more problematical if the longer term is considered. A monoculture of a tree species may provide

many ecosystem services for decades or even a few centuries, but it may be more vulnerable to catastrophic disease and/or be less resilient in the face of environmental change than would a natural forest with its original tree species diversity. The presence of many species would generally increase the chance that, if rapid change exterminated some species, there would be ecological equivalents present, more tolerant to the particular change and able to take over their roles. Furthermore, a drastic reduction in species diversity in an ecosystem may lead to sequences of community development whose direction and consequences for ecosystem services may be very difficult to predict (e.g. Drake *et al.* 1993; Hughes 1994; Luh and Pimm 1993).

If the tree monoculture were genetically uniform, the ecosystem services it supplied would be even more vulnerable to disruption. A natural forest often contains a diversity of populations of component tree species – populations adapted to different environmental regimes (say, north- and south-facing slopes). They would contain interpopulation genetic variation which could be crucial to the ability of species to evolve in response to rapid changes in environmental conditions, such as climatic shifts due to global warming.

From a very broad perspective, the redundant species hypothesis seems even less likely to be correct. While a 'weedy' ecosystem might satisfactorily maintain the gaseous mix of the atmosphere, control erosion, conserve water flows, and so on, other services seem almost certain to be less secure than in a diverse natural system. A tree farm might not shelter the diversity of natural enemies of crop pests that would be found in a natural forest. For example, avian diversity is correlated with structural diversity in forests, and many bird species have habitat requirements not met in even aged stands of monocultures. In addition, a tree farm may be less effective than a mix of native species at recycling nutrients and maintaining a fertile soil (Aber and Melillo 1991).

Of course, it is difficult to predict the need for pest control services in a highly biologically depauperate world, although simple food-chain considerations would suggest that herbivorous pests would be more likely than their predacious enemies to persist in such an environment. Ecologists know that extinction of species will not necessarily cause deterioration of certain ecosystem services – that there is some redundancy at least in the short term since observed extinctions do not always cause detectable impacts on services. However, ecologists cannot determine the actual degree of redundancy present, nor whether short-term redundancy holds for the long term.

There are, of course, some ecosystem services that automatically would be compromised by losses of species, populations and genetic diversity. Direct provision of food and maintenance of the genetic library are the best

examples. Loss of fisheries or game species can more or less permanently remove a substantial source of human food – as did the extermination of the passenger pigeon (Blockstein and Tordoff 1985). The extinction of one species often leads to the extinction of others, which often are directly (as in the case of monophagous herbivores and parasites) or indirectly (e.g. Paine 1966; Gilbert 1980; Daily *et al.* 1993) dependent on the organism that has disappeared. Thus, while loss of any species or genetically distinct population by definition depletes the genetic library (and thus its potential for supplying direct economic benefits to society), each extinction also has the potential for generating cascades of further losses. Therefore, conservation efforts should focus not only on species, but also on ecological and evolutionary processes which occur in the matrix of the community and ecosystem (see also Section 4.5).

Given such examples, it would be prudent to assume that ecosystem services depend significantly on species diversity, and more heavily on population diversity (Ehrlich and Daily 1993; Daily and Ehrlich 1994), since on local, regional and global scales, ecosystem services are delivered by populations. Multitudinous populations of plants, animals and microorganisms, each usually genetically adapted to a relatively narrow range of environmental conditions, are necessary to maintain ecosystem functioning. After all, very few organisms of any functional group can thrive under a wide variety of physical and biotic conditions: adaptation to local circumstance is nearly ubiquitous. Much too little attention has been paid to the connection between the diversity of populations (both Mendelian populations and demographic units) and the delivery of ecosystem services.

The uncertainties of the relationship between species diversity and ecosystem services led more than a decade ago to the formulation of the 'rivet hypothesis' (Ehrlich and Ehrlich 1981). It says, in essence, that given the complexity of ecosystems and our lack of detailed knowledge of their functioning (especially in the long term), it is foolish to remove species randomly just as it would be foolish to pop rivets from an airplane's wing. There are more rivets in an airplane's wing than are necessary for its integrity, but removing too many can cause a structural disaster. At some point, removing one more rivet will cause others to pop out and the wing to fail. While there is at least some redundancy in the role of species in delivering services, there may also be extinction thresholds. For instance, if a 'keystone' species (see 5.2.2) is extirpated, it could lead to an extinction cascade that would eliminate a series of functionally related species and lead to unacceptable deterioration of an ecosystem service. Or, the removal of one or a few predatory species can lead to serious outbreaks of pest species. This is demonstrated by a well-

documented set of examples of the problem of 'promotion' of previously harmless organisms to the status of agricultural pests when natural predators have been reduced or eliminated from a system by misuse of pesticides (e.g. Barducci 1972).

There are, of course, costs involved in making an airplane wing safer. Strengthening the structure usually means adding more weight, which in turn means that less fuel or fewer passengers can be carried. A 747 that carried only one passenger could be made very safe indeed, but would be totally uneconomical. There are both costs and benefits of safety in airliners, and where the balance is struck is largely a social and economic decision.

The same is true for the preservation of biodiversity. About 11% of Earth's land surface is now covered by crops, rather than more diverse ecosystems, and attempts to provide food for a human population that may more than double in the next century is likely to lead to further conversion to agriculture of relatively natural ecosystems. Diverse systems seem doomed to diminish as a result of increasing urbanization, grazing pressure, and other consequences of the expanding scale of the human enterprise. Because of human needs (and greed), the costs of preserving diversity seem bound to increase rapidly, but simultaneously the costs to civilization of destroying it may escalate as well.

It remains a major challenge to ecologists to improve their understanding of the relationship between biodiversity and ecosystem functioning so they can better predict where the increasing risks of destroying biodiversity become greater than the increasing costs of preserving it. At the moment, about all that can be said is that until and unless it can be definitively shown that the rivet hypothesis is over-conservative, it would be folly for humanity to continue to wipe out species diversity indiscriminately. Further deliberate destruction of biodiversity at the genetic, population, species or ecosystem level should be permitted only as a last resort, when crucial human needs can be met in no other way. The burden of proof of need must rest on those proposing the destruction, and societies must guard against short-term financial gain at the expense of the majority.

On the basis of present knowledge, we cannot safely assume that a 'weedy world' will support the human enterprise as effectively or for as long as one rich in organisms that are not human inquilines. Until and unless further research clearly shows how diversity can safely be reduced, we must act as if all levels of diversity will be essential if ecosystems are to respond to the rapid and unprecedented environmental changes that now face human society. And even if ecologists show that 'weedy' species are all we need to supply basic services to humanity, they cannot show that the ethical and aesthetic arguments for

maximizing the preservation of biodiversity are incorrect. They lie outside realm of science, but contain some of the most powerful reasons for saving our only known living companions in the universe.

References

- Aber, J.D. and Melillo, J.M. 1991. *Terrestrial Ecosystems*. Saunders, Philadelphia.
- Barducci, T.B. 1972. Ecological consequences of pesticides used for the control of cotton insects in Canete Valley, Peru. In: Farvar, M.T. and Milton, J.P. (eds), *The Careless Technology: Ecology and international development*. 423–438. Natural History Press, Garden City, NY.
- Blockstein, D.E. and Tordoff, H.B. 1985. Gone forever: a contemporary look at the extinction of the passenger pigeon. *American Birds* **39**: 845–851.
- Daily, G.C. and Ehrlich, P.R. 1994. Population extinction and the biodiversity crisis. In: Mäler, K.-G., Folke, C., Holling, C.S. and Jansson, B.-O. (eds), *Biodiversity Conservation: Problems and policies*. Kluwer Academic Press, Dordrecht.
- Daily, G.C., Ehrlich, P.R. and Haddad, N.M. 1993. Double keystone bird in a keystone species complex. *Proceedings of the National Academy of Sciences, USA* **90**: 592–594.
- Drake, J.A., Flum, T.E., Witteman, G.J., Voskuil, T., Hoylman, A.M., Creson, C., Kenny, D.A., Huxel, G.R., Larue, C.S. and Duncan, J.R. 1993. The construction and assembly of an ecological landscape. *Journal of Animal Ecology* **62**: 117–130.
- Ehrlich, P.R. 1993. Foreword: biodiversity and ecosystem function: need we know more? In: Schulze, E.-D. and Mooney, H.A. (eds), *Biodiversity and Ecosystem Function*. vii–xi. Springer-Verlag, Berlin.
- Ehrlich, P.R. and Daily, G. C. 1993. Population extinction and saving biodiversity. *Ambio* **22**: 64–68.
- Ehrlich, P.R. and Ehrlich, A.H. 1981. *Extinction: The causes and consequences of the disappearance of species*. Random House, New York.
- Ehrlich, P.R. and Ehrlich, A.H. 1992. The value of biodiversity. *Ambio* **21**: 219–226.
- Gilbert, L.E. 1980. Food web organization and the conservation of tropical diversity. In: Soulé, M.E. and Wilcox, B.A. (eds), *Conservation Biology*. 11–33. Sinauer Associates, Sunderland, Mass.
- Hughes, T.P. 1994. Catastrophes, phase shifts, and large-scale degradation of a Caribbean coral reef. *Science* **265**: 1547–1551.
- Luh, H.-K. and Pimm, S.L. 1993. The assembly of ecological communities: a minimalist approach. *Journal of Animal Ecology* **62**: 749–765.
- Lawton, J.H. and Brown, V.K. 1993. Redundancy in ecosystems. In: Schulze, E.-D. and Mooney, H.A. (eds), *Biodiversity and Ecosystem Function*. 255–270. Springer-Verlag, Berlin.
- Naeem, S., Thompson, L.-J., Lawler, S.P., Lawton, J.H. and Woodfin, R.M. 1994. Declining biodiversity can alter the performance of ecosystems. *Nature* **368**: 734–737.
- Paine, R. 1966. Food web complexity and species diversity. *American Naturalist* **100**: 65–75.
- Walker, B.H. 1992. Biodiversity and ecological redundancy. *Conservation Biology* **6**: 18–23.

5.2 Functional properties of biodiversity: a hierarchical perspective

5.2.1 Genetic diversity and ecosystem functioning

In order to evaluate the significance of genetic diversity in ecosystem functioning, the role of the individual must first be appreciated. Individuals – not species – eat or are eaten, live or die, capture energy and transfer energy. Species do not interact: individuals of different species interact. Communities are not assemblages of species: they are assemblages of individuals of the same and different species. All too often in the ecological literature, species are treated as monolithic, static entities that are the basic building blocks of communities and ecosystems. Fortunately, a new, individual-based ecology is emerging (Hogeweg and Hesper 1990; Rose *et al.* 1993), and as it matures and develops, the role of individuals in ecological processes will undoubtedly gain a deeper appreciation. Much of the individual variation observed at the intraspecific level is due for example to the individual's sex, age or past interactions with the environment. However, one class of intraspecific variation – genetic variation – plays a particularly important role in processes above the individual level and this subsection will deal only with this genetic component of individual variation.

Genetic variation ties together the biological properties of the individual and the biological properties of the species. DNA, the material basis of genetic variation, can replicate and be passed on to future generations and to more than one individual. Accordingly, genetic variation has an existence in space and time that transcends the individual. This temporal and spatial existence of genetic variation provides both the raw material and the physical continuity for the process of evolution at the species level. This capacity to evolve provides insurance against future environmental changes. Therefore, the emergent population property of evolution augments – not diminishes – the importance of genetic diversity among individuals.

The above does not imply that species are not important in ecology or that they are not real biological units (Templeton 1989). Adaptation is one of the most important evolutionary processes that emerge at the population level. Through adaptation, individuals within a species come to have traits that help in their survival and reproduction with regard to both their physical and biotic environments. These adaptations result in an ecological distinctiveness that emerges at the species level that has been described as the 'keystone of evolution' because it serves as the basis of diversification of the organic world, adaptive radiation and evolutionary progress (Mayr 1970). Ecosystems function by a variety of processes that are shaped by adaptive evolution. They first require that energy be captured from the physical environment and be transferred into the biological realm in the form of biomass. The amount of physical energy that is converted into biomass is influenced

by the genotype of the individual, as evidenced by the fact that genetic variation among individuals is the basis of much of the improvement in biomass productivity of modern crop plants (Oldfield 1984). The genetic improvement of domesticated animal stocks also shows that the efficiency of energy transfer from one trophic level to the next is another genetically variable trait (Oldfield 1984), and indeed genetic variation of the proportion of ingested energy that is converted into biomass exists within our own species (Reilly *et al.* 1992).

The transfer of energy from one trophic level to the next is mediated by interactions among individuals, including individuals of different species. Many other types of inter-'specific' interactions are critical for ecosystem functioning, including competitive and mutualistic interactions. These interactions are shaped by adaptive processes working upon intraspecific genetic variability, as illustrated by the extensive literature on coevolution (Pirozynski and Hawksworth 1988; Thompson 1988; Mitter *et al.* 1991; Fritz and Simms 1992; Jolivet 1992; see Section 4.5), the evolution of human diseases (Ewald 1994), and the human evolutionary responses to these diseases (Weiss 1993). These biotic interactions shape the structure and the functioning of the biological community component of ecosystems. Although described as 'interspecific', these interactions are sometimes best understood at the level of intraspecific genetic variation. For example, in *Heliconius* butterflies the genetic system controlling adult wing pattern evolves as an intra- and interspecific mutualism (to provide a common inter/intraspecific signal of distastefulness to potential predators), while the genetic system controlling adult foraging behaviour evolves through intra- and interspecific competition for scarce pollen resources (Templeton and Gilbert 1985). Thus, species and even individuals cannot be said to have *an* interaction in this example. Rather, the community structure in this case can only be understood at the level of genetic traits within individuals (Templeton and Gilbert 1985).

Finally, ecosystem functioning requires interactions of individuals with the physical environment, and as with biotic interactions, these are shaped by adaptive evolution operating upon individual genetic variation. This includes adaptation to the geological/chemical environment (Ware 1990; Ware and Pinion 1990) and to physical stresses such as desiccation (Templeton *et al.* 1989) or flooding (Schwartz 1969).

As discussed above, genetic diversity as shaped by adaptive evolution underlies ecological processes at the population, species, community and ecosystem levels. Genetic diversity itself has a variety of meanings and levels of measurement (Templeton 1994; see also Section 2.2), the most basic being allelic diversity (alternative forms of genes at the same locus). Allelic diversity is created by the

process of mutation and can subsequently be lost during the evolutionary process, either at random (genetic drift in the species as a whole), or due to natural selection (elimination of deleterious alleles and fixation of favourable alleles). The amount of allelic diversity in a species represents a dynamic balance between these processes.

Species exist in both space and time, and so does intraspecific allelic diversity. In some species, the allelic diversity is widely and nearly uniformly distributed across a species' geographical range (Barrowclough 1983). At the other extreme are species in which local populations have little or no allelic diversity, although different local populations can be fixed for alternative alleles (Templeton *et al.* 1990). The forces that partition and create genetic hierarchies within a species include such factors as the system of mating, genetic drift, population subdivision, dispersal and gene flow (see Section 4.2). The partitioning of allelic diversity within and among local breeding populations is primarily due to the dynamic balance between local genetic drift (which causes the local breeding population to lose allelic diversity but causes an increase in among-population genetic differentiation) versus gene flow or dispersal (which brings new allelic diversity into the local population and reduces genetic differentiation among populations). In sexually reproducing populations, the allelic diversity within a local population is amplified into vast numbers of combinations of genotypic diversity through the mechanisms of gamete formation and union (system of mating). This determines the extent to which diploid individuals will themselves carry allelic diversity in the form of heterozygosity (an individual carrying two different alleles at a locus).

What is the significance of genetic diversity at these various intraspecific levels? Starting at the individual level in sexual populations, attention has focused on the importance of heterozygosity (see also Section 4.2). Several studies have concluded that as heterozygosity increases, individual fitness or fitness correlates also increase (Clarke 1993). Unfortunately, due to confounding factors, there is little convincing evidence for heterozygote superiority as a general phenomenon (Clarke 1993) or as a quantitatively important explanation of inbreeding depression (a loss of fitness in the offspring of matings between close biological relatives) (Templeton 1987). This is not to say that heterozygote superiority does not occur (for an example, see Templeton 1982): only that it is not universal. Plants and animals adapt to their system of mating, and if they have a system of mating that favours homozygosity, alleles with high fitness under homozygosity are favoured by natural selection (Templeton 1982). Because there is much diversity in systems of mating across species (from panmixia to selfing), heterozygosity may be important in some species and irrelevant in others. Heterozygosity is certainly irrelevant in

the vast numbers of haploid individuals that dominate the microbial world and commonly represent critical components of ecosystem functioning.

Studies on fitness and heterozygosity, and on inbreeding depression, do reveal one common theme – the importance of multilocus combinations in individual fitness (Templeton and Read 1984, 1994; Clarke 1993). Despite the fact that there is more consistent evidence for epistasis (multilocus interactions) leading to co-adapted gene complexes being more important than heterozygosity in determining individual fitness (Clarke 1993) and that epistasis is important for individual fitness in the haploid, microbial world as well (Lenski 1988a, b), combinatorial genetic diversity has been explicitly incorporated into only a handful of conservation programmes (e.g. Templeton and Read 1984, 1994; Emlen 1991).

At the level of a local population, genetic variation exists in the form of allelic and combinatorial diversity in the local population's gene pool. Concern about variation within local populations has focused on two issues: (1) the fear that genetic uniformity makes populations more susceptible to pests or disease pathogens (O'Brien *et al.* 1985; Potts and Wakeland 1993), and (2) the fear that loss of genetic diversity at this level will reduce a population's ability to respond to environmental change (both biotic and abiotic) through the process of adaptation via natural selection. Recently, Caro and Laurenson (1994) questioned the importance of genetic variation with respect to evidence for increased risk to short-term population extinction. The cases of increased susceptibility to pathogens in natural populations that are low in genetic variation are not definite proofs of the importance of genetic variation but are consistent with this conclusion (O'Brien *et al.* 1985; Moritz *et al.* 1991). Moreover, there is a rich agricultural literature on the dangers of genetic monocultures with respect to pathogens (Bishop and Cook 1981; Oldfield 1984; Browning 1991). Accordingly, it would be foolish to dismiss this role of genetic variation in mediating the intensity and ecological consequences of host/pathogen interactions. The necessity of genetic diversity for adaptive evolution is well established both theoretically (Templeton 1982) and experimentally (e.g. Carson 1961). There are also abundant natural examples of organisms utilizing their genetic diversity to adapt to environmental change, including human-induced environmental change (Bishop and Cook 1981). These adaptations can directly affect an organism's niche and biotic interactions in the community (Singer *et al.* 1993). For example Sork *et al.* (1993) have found that the northern red oaks in the Ozarks adapt very finely to variations in interactions with herbivores and to the physical environment. These examples illustrate the importance of genetic diversity as a component of adaptive evolution. Because adaptive flexibility is only realized in evolutionary time, the criterion of short-term extinction risk

(Caro and Laurenson 1994) is inherently inappropriate for assessing the importance of genetic diversity with respect to adaptation. The real danger from loss of genetic variation is the concomitant loss of adaptive flexibility in the face of changing environments, which reduces the long-term probability of persistence of the population.

Finally, genetic diversity exists as differences among local populations, with among-population differentiation tending to increase with decreasing gene flow in sexual populations and decreasing dispersal in asexual populations (see Section 3.1). This spatial component of genetic diversity augments the likelihood and accuracy of adaptation to local environments (Bishop *et al.* 1978; Templeton *et al.* 1989) and response to environmental change (Lynch and Lande 1993). As a result of local adaptation, different local populations of a species cannot be regarded as interchangeable (Powers *et al.* 1991; Watt 1991). One consequence of local adaptation is the expectation that reintroduction programmes will have increasing chances of success with increasing geographical proximity of the site of origin of the propagules to the site of release, as indeed has been repeatedly observed (Greig 1979; Griffith *et al.* 1989). In addition, genetic diversity has several direct implications for the relationship between biodiversity (at the intraspecific level in this case) and ecosystem services. Two representative examples are: (1) the maintenance of adaptive flexibility – an important component in recovery from disturbance and (2) the introduction of slash-and-burn agriculture which increased malaria in tropical Africa which in turn affected the incidence of sickle cell anaemia there (see Templeton 1982).

In summary, genetic diversity has many manifestations and plays many biologically significant roles within a species. This significance does not stop at the species boundary; rather, primarily through the intraspecific genetic process of adaptation, genetic diversity influences the emergence and functioning of higher order, ecological, systems.

References

- Barrowclough**, G.F. 1983. Biochemical studies of microevolutionary processes. In: Brush, A.H. and Clark, J.G.C. (eds), *Perspectives in Ornithology*, 223–261. Cambridge University Press, New York.
- Bishop**, J.A. and Cook, L.M. (eds) 1981. *Genetic Consequences of Man Made Change*. Academic Press, London.
- Bishop**, J.A., Cook, L.M. and Muggleton, J. 1978. The response of two species of moths to industrialization in northwest England. *Philosophical Transactions of the Royal Society of London*, **281**: 489–542.
- Browning**, J.A. 1991. Conserving crop-plant pathogen coevolutionary processes. In: Oldfield, M.L. and Alcorn, J.B. (eds), *Biodiversity: Culture, conservation, and ecodevelopment*, 59–85. Westview Press, Boulder, Colorado.

- Caro, T.M.** and Laurenson, M.K. 1994. Ecological and genetic factors in conservation: a cautionary tale. *Science* **263**: 485–486.
- Carson, H.L.** 1961. Heterosis and fitness in experimental populations of *Drosophila melanogaster*. *Evolution* **15**: 496–509.
- Clarke, G.M.** 1993. The genetic basis of developmental stability. I. Relationships between stability, heterozygosity and genomic coadaptation. *Genetica* **89**: 15–23.
- Emlen, J.M.** 1991. Heterosis and outbreeding depression: a multi-locus model and an application to salmon production. *Fisheries Research* **12**: 187–212.
- Ewald, P.W.** 1994. *Evolution of Infectious Disease*. Oxford University Press, Oxford.
- Fritz, R.S.** and Simms, E.L. (eds) 1992. *Plant Resistance to Herbivores and Pathogens: Ecology, evolution, and genetics*. University of Chicago Press, Chicago.
- Greig, J.C.** 1979. Principles of genetic conservation in relation to wildlife management in Southern Africa. *S. Afr. Tydskr. Natuurwet.* **9**: 57–78.
- Griffith, B., Scott, J.M., Carpenter, J.W.** and Reed, C. 1989. Translocation as a species conservation tool: status and strategy. *Science* **245**: 477–480.
- Hogeweg, P.** and Hesper, B. 1990. Individual-oriented modeling in ecology. *Mathematical and Computer Modelling* **13**: 83–90.
- Jolivet, P.** 1992. *Insects and Plants: Parallel evolution and adaptations*, 2nd edn. Sandhill Crane Press, Gainesville, Fla.
- Lenski, R.E.** 1988a. Experimental studies of pleiotropy and epistasis in *Escherichia coli*. I. Variation in competitive fitness among mutants resistant to virus T4. *Evolution* **42**: 433–440.
- Lenski, R.E.** 1988b. Experimental studies of pleiotropy and epistasis in *Escherichia coli*. II. Compensation for maladaptive effects associated with resistance to virus T4. *Evolution* **42**: 433–440.
- Lynch, M.** and Lande, R. 1993. Evolution and extinction in response to environmental change. In: Kareiva, P.M., Kinsolver, J.G. and Huey, R.B. (eds), *Biotic Interactions and Global Change*. 234–250. Sinauer Associates, Sunderland, Mass.
- Mayr, E.** 1970. *Populations, Species, and Evolution*. The Belknap Press of Harvard University Press, Cambridge, Mass.
- Mitter, C., Farrell, B.** and Futuyma, D.J. 1991. Phylogenetic studies of insect–plant interactions: insights into the genesis of diversity. *Trends in Ecology and Evolution* **6**: 290–293.
- Moritz, C., McCallum, H., Donnellan, S.** and Roberts, J.D. 1991. Parasite loads in parthenogenetic and sexual lizards (*Heteronotia binoci*): support for the Red Queen hypothesis. *Proceedings of the Royal Society of London, B* **244**: 145–149.
- O'Brien, S.J., Roelke, M.E., Marker, L., Newman, A., Winkler, C.A., Meltzer, D., Colly, L., Evermann, J.F., Bush, M.** and Wildt, D.E. 1985. Genetic basis for species vulnerability in the cheetah. *Science* **227**: 1428–1434.
- Oldfield, M.L.** 1984. *The Value of Conserving Genetic Resources*. U.S. Department of the Interior, National Park Service, Washington, DC.
- Pirozynski, K.A.** and Hawksworth, D.L. (eds) 1988. *Coevolution of Fungi with Plants and Animals*. Academic Press, London.
- Potts, W.K.** and Wakeland, E.K. 1993. Evolution of MHC genetic diversity: a tale of incest, pestilence and sexual preference. *Trends In Genetics* **9**: 408–412.
- Powers, D.A., Lauerman, T., Crawford, D.** and DiMichele, L. 1991. Genetic mechanisms for adapting to a changing environment. *Annual Review of Genetics* **25**: 629–659.
- Reilly, S.L., Ferrell, R.E., Kottke, B.A.** and Sing, C.F. 1992. The gender specific apolipoprotein E genotype influence on the distribution of lipids and apolipoproteins in the population of Rochester, Minnesota. II. Regression relationships with concomitants. *American Journal of Human Genetics* **51**: 1311–1324.
- Rose, K.A., Christensen, S.W.** and Deangelis, D.L. 1993. Individual-based modeling of populations with high mortality – a new method based on following a fixed number of model individuals. *Ecological Modelling* **68**: 273–292.
- Schwartz, D.** 1969. An example of gene fixation resulting from selective advantage in suboptimal conditions. *American Naturalist* **103**: 479–481.
- Singer, M.C., Thomas, C.D.** and Parmesan, C. 1993. Rapid human-induced evolution of insect–host associations. *Nature* **366**: 681–683.
- Sork, V.L., Stowe, K.A.** and Hochwender, C. 1993. Evidence for local adaptation in closely adjacent subpopulations of northern red oak (*Quercus rubra* L.) expressed as resistance to leaf herbivores. *American Naturalist* **142**: 928–936.
- Templeton, A.R.** 1982. Adaptation and the integration of evolutionary forces. In: Milkman, R. (ed.), *Perspectives on Evolution*. 15–31. Sinauer Associates, Sunderland, Mass.
- Templeton, A.R.** 1987. Inferences on natural population structure from genetic studies on captive mammalian populations. In: Chepko-Sade, B.D. and Halpin, Z.T. (eds), *Mammalian Dispersal Patterns*. 257–272. University of Chicago Press, Chicago.
- Templeton, A.R.** 1989. The meaning of species and speciation: a genetic perspective. In: Otte, D. and Endler, J.A. (eds), *Speciation and its Consequences*. 3–27. Sinauer Associates, Sunderland, Mass.
- Templeton, A.R.** 1994. Biodiversity at the molecular genetic level: experiences from disparate macroorganisms. *Philosophical Transactions of the Royal Society of London B* **345**: 59–64.
- Templeton, A.R.** and Gilbert, L.E. 1985. Population genetics and the coevolution of mutualisms. In: Boucher, D.H. (ed.), *The Biology of Mutualism: Ecology and evolution*. 128–144. Croom Helm, London.
- Templeton, A.R., Hollocher, H., Lawler, S.** and Johnston, J.S. 1989. Natural selection and ribosomal DNA in *Drosophila Genome* **31**: 296–303.
- Templeton, A.R.** and Read, B. 1984. Factors eliminating inbreeding depression in a captive herd of Speke's gazelle (*Gazella spekei*). *Zoo Biology* **3**: 177–199.
- Templeton, A.R.** and Read, B. 1994. Inbreeding: one word, several meanings, much confusion. In: Loeschcke, V., Tomiuk, J. and Jain, S.K. (eds), *Conservation Genetics*. 91–106. Birkhäuser-Verlag, Basel.
- Templeton, A.R., Shaw, K., Routman, E.** and Davis, S.K. 1990. The genetic consequences of habitat fragmentation. *Annals of the Missouri Botanical Garden* **77**: 13–27.

- Thompson, J.N.** 1988. Variation in interspecific interactions. *Annual Review of Ecology and Systematics* **19**: 65–87.
- Ware, S.** 1990. Adaptation to substrate – and lack of it – in rock outcrop plants: *Sedum* and *Arenaria*. *American Journal of Botany* **77**: 1095–1100.
- Ware, S.** and Pinion, G. 1990. Substrate adaptation in rock outcrop plants: Eastern United States *Talinum* (Portulacaceae). *Bulletin of the Torrey Botanical Club* **117**: 284–290.
- Watt, W.B.** 1991. Biochemistry, physiological ecology, and population genetics: the mechanistic tools of evolutionary biology. *Functional Ecology* **5**: 145–154.
- Weiss, K.M.** 1993. *Genetic Variation and Human Disease: Principles and evolutionary approaches*. Cambridge University Press, Cambridge.

5.2.2 Biodiversity effects on patterns and processes of communities and ecosystems

5.2.2.1 Introduction

The loss of species through changes in land-use has occurred frequently and is irrevocable (Solbrig 1991; NRC 1995). Reductions in population size, fragmentation of populations, and alterations in the relative abundance of species are increasingly common phenomena with profound ecological implications (5.2.3). Human introduction of new species into natural communities is also common, and often has profound ecological effects (Drake *et al.* 1989; Vitousek 1990; Carpenter *et al.* 1992; D'Antonio and Vitousek 1992; Carleton and Geller 1993; Huston 1994). How do these changes in diversity affect ecological communities and ecosystems? Can the consequences of deletions or additions be predicted? What patterns are emerging from the plethora of investigations into these complex phenomena?

During recent decades, several hypotheses have arisen to describe the observed or expected consequences of the addition or removal of species. These hypotheses are based in part on observations following species reductions, deletions or additions and in part on predictions from ecological modelling and theory. These hypotheses are often cast as alternatives, but often focus on different aspects of the topic. Some hypotheses emphasize the number of species in the community (Vitousek and Hooper 1993), others the degree of similarity among species in traits that affect community or ecosystem functioning (Menge *et al.* 1986; Walker 1992; Lawton and Brown 1993; Frost *et al.* 1995; Sala *et al.* 1996). Here, we briefly review some of these hypotheses, then present an emerging conceptual framework that integrates and synthesizes the disparate approaches. In reviewing the key ideas, we delineate the hypotheses that centre on the notion of functional similarity among species, suggest how these hypotheses relate to one another, and point out how a number of them have evolved as additional information and understanding have emerged.

5.2.2.2 Relationship between species and the functioning of ecological communities and ecosystems: hypotheses concerning similarity among species

Several hypotheses about changes in species diversity and community or ecosystem responses consider the functional similarity among species, in other words, how similar different species are to one another with respect to their roles in community or ecosystem processes. The different approaches may be viewed as lying along a continuum. At one extreme is the idea that each species is unique and important, such that its removal or loss will have demonstrable consequences to the functioning of the community or ecosystem. At the other end of the spectrum is the notion that species overlap in function to a sufficient degree that removal or loss of a species will be compensated by others, with negligible overall consequences to the community or ecosystem. In the middle of this continuum lies a mixed community, with some unique species and others with substantial overlap in functional properties.

One of the first attempts to address this similarity among species was the notion of 'keystone species' codified by Paine (1969). The central core of the keystone concept is that only one or a few species have uniquely important effects on the community or ecosystem by virtue of unique traits or attributes. Analogous to the removal of a keystone from an arch, removal of a keystone species results in dramatic changes in the functional properties of the ecological system (e.g. changes in diversity, abundance, habitat structure). Paine initially restricted the concept of keystone species to predators of competitive dominants in a community. Building on a series of investigations in a wide range of ecosystems, a recent review (Power and Mills 1995) expands the keystone concept to include any species with an impact on its community or ecosystem that is disproportionately large relative to the abundance of the species (Box 5.2-1). Their review concludes that (a) keystone species have been demonstrated in a wide variety of ecosystems, (b) based on indirect evidence, keystones may be more prevalent than has been demonstrated, and (c) the concept can apply to individual species or groups of species, but that (d) *a priori* prediction of a keystone species remains elusive.

At one end of the continuum of similarity among species lies the hypothesis that species overlap with one another in functional properties to a sufficient degree that loss of any one species has negligible effect. This hypothesis has been termed the redundancy hypothesis (Walker 1992; Lawton and Brown 1993) but others suggest that the term 'functional compensation' hypothesis is preferable (Menge *et al.* 1994; Frost *et al.* 1995). The far opposite end of the hypothetical continuum in similarity is suggested primarily for heuristic purposes. There is no evidence that each and every species plays a unique role such that its absence

Box 5.2-1: Keystone species – what are they and why do they matter?

A keystone species is a species whose impacts on its community or ecosystem are large and greater than would be expected from its relative abundance. This definition is unconstrained by a species' trophic status, mode of impact, or nature of community or ecosystem response. For any species, a relationship exists between the proportional abundance of that species and its total impact on the community or ecosystem. Proportional abundance is normally measured in units of biomass (see graph below). Species whose total impact scales exactly to their proportional abundance fall on the diagonal line ($X = Y$). keystones, in contrast, have total effects that greatly exceed this line of proportional equality. Very rare species with total impacts that exceed the diagonal, but are nonetheless relatively small, are not considered keystones, since their overall effect is minimal. For instance, a very rare rhinovirus that makes a wildebeest sneeze (V_R) might have a total effect far exceeding that expected from its biomass. However, the rhinovirus would not qualify as a keystone species because of its low absolute total effect.

By contrast, an equally rare distemper virus (V_D) that kills lions or wild dogs might have a total impact of sufficient magnitude for keystone designation. The keystone species illustrated in the figure include the sea star *Pisaster* (P), the predatory whelk *Concholepas* (C), sea otters (O), and freshwater bass (B). All are species whose total impact is large and large relative to their abundance. By contrast trees (T), giant kelp (K), prairie grass (G) and reef-building corals (Cr) which dominate community biomass also have total impacts that are large, but not disproportionate to their biomass. These non-keystone dominants are to the right of the line.

Keystone species are usually detected when they are removed or disappear from a system. In the cases illustrated, the absence of the keystone species resulted in dramatic changes to the rest of the community (Box 6.1-1 provides details on the otter example). Keystone species have been reported from a wide variety of ecosystems, all trophic levels and many taxa. Their pivotal impact is often not appreciated until they are absent.

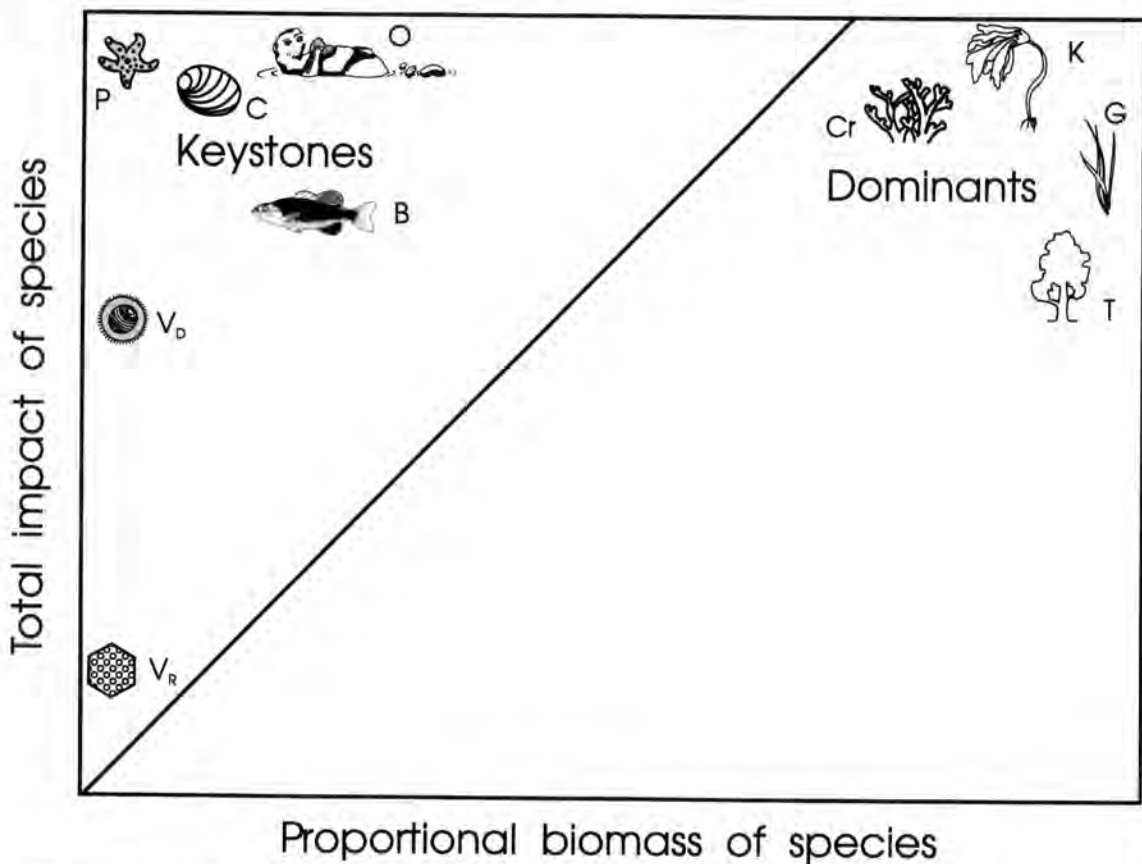

Total (collective) impact of a species (absolute value of community impact \times proportional abundance) of species versus their proportional abundance. Points representing a species whose total impact is proportional to its abundance would fall along the diagonal line ($X = Y$). Keystones are species whose effects exceed their proportional abundances by some large factor and whose total effect exceeds some threshold. Dominants are species which dominate community biomass and whose ecosystem impacts are large, but not disproportionate to their biomass. Letters represent examples of particular species described in the text (Power and Mills 1995).

would immediately result in a dramatic change in the functioning of the ecological system.

Another hypothesis concerning functional consequences of loss of species is the 'rivet hypothesis'. As originally formulated (Ehrlich and Ehrlich 1981), this hypothesis suggested that each species is like a rivet in an aircraft such that each species loss contributes equally to the probability of large changes in community and ecosystem processes. This hypothesis, too, has evolved and now (Chapter 5.1) suggests that, like rivets in critical places in an aircraft, certain species may play more critical roles than others. A number of features are essential to this hypothesis: the number of rivets (= species), their placement, and their immediate neighbours.

5.2.2.3 Key concepts and terms

Consideration of the relationship between species diversity and the functioning of communities and ecosystems requires a clear description of the important terms, e.g. **functional group**, **community patterns**, **community processes**, **ecosystem patterns** and **ecosystem processes**, as given below.

There is no intrinsically unique level at which biotic diversity affects ecosystem processes. The current level of conceptual understanding of the effects of biodiversity on ecosystem processes is so primitive that it is easiest to recognize these linkages at the level of **functional groups**, i.e. groups of species that have ecologically similar effects on ecosystem processes (Woodward 1987; Chapin 1993; Huston 1994). However, no two species or individuals are ecologically identical, so as our understanding improves we expect to recognize situations where species diversity within functional groups (Huston 1994; Cushman 1995) or genetic diversity within species (5.2.1) has important ecosystem consequences. Moreover, because most species belong to more than one functional group and affect species belonging to other functional groups, prediction of the overall consequences of a deletion or addition is complex. For example, large kelps provide the physical structure of a kelp forest in addition to providing a substantial portion of the primary production. Other macrophytes such as algal crusts or turfs and phytoplankton could compensate in part for the loss of production by kelps if kelps were deleted from the system, but would not provide the three-dimensional habitat for a diverse assemblage of invertebrates, juvenile and adult fishes, and marine mammals. Thus compensation by other members in one functional group is not automatically linked to compensation in other functions.

The **community processes** we consider here are species interactions (e.g. competition, predation, mutualism), which we distinguish from **ecosystem processes** — the flows of water, energy, and materials within and among ecosystems (e.g. primary production, microbial

immobilization, nutrient leaching). **Community patterns** are described in terms of the abundance and spatial distribution of species in an ecosystem, whereas **ecosystem patterns** are the quantities and configuration of water, energy and materials in biotic and abiotic components of the system. The same organisms carry out both community and ecosystem processes, so these and other levels of organization are closely linked. For example, introduction of a disease that alters the abundance of a flammable grass (a community change) may depend on genetic variability in disease resistance (genetic diversity) and may alter fire frequency and stand biomass (an ecosystem trait) and the propagation of fire among ecosystems in a watershed (a landscape process).

5.2.2.4 Integrated framework

Here we present a general framework, based on the hypotheses described above, for the information needed to predict the functional consequences of changes in diversity. To understand the community and ecosystem consequences of a species invasion or extinction, we must know at least (1) the approximate number of species in the community, (2) the relative abundance of these species, (3) how strongly a given species differs from other species in the community, (4) the impact of particular species traits on community and ecosystem processes and (5) the indirect effects that a species has on other species in the community. We refer to these as 'critical components of diversity'.

1. The number of species in an ecosystem (species richness) undoubtedly influences some community and ecosystem processes, but we do not know (a) the shape of the relationship between species number and the rate of an ecosystem process or (b) where this relationship saturates (Vitousek and Hooper 1993) (Figure 5.2-1a). If the relationship saturates, and we consider only species richness, we expect species additions or deletions to have their greatest effect when there are relatively few species in the community, as on islands (Cushman 1995).
2. The most abundant species of a community in terms of biomass typically accounts for the greatest proportion of productivity and nutrient cycling (Bormann and Likens 1979; Valiela 1984). Thus, we expect deletion of community dominants to have greater impact on some ecosystem processes than will deletion of species that are small and/or rare (Cushman 1995; Sala *et al.* 1996) (Figure 5.2-1b).
3. The impact of the addition or deletion of a particular species depends on its degree of functional similarity to other species in the community. If a species is

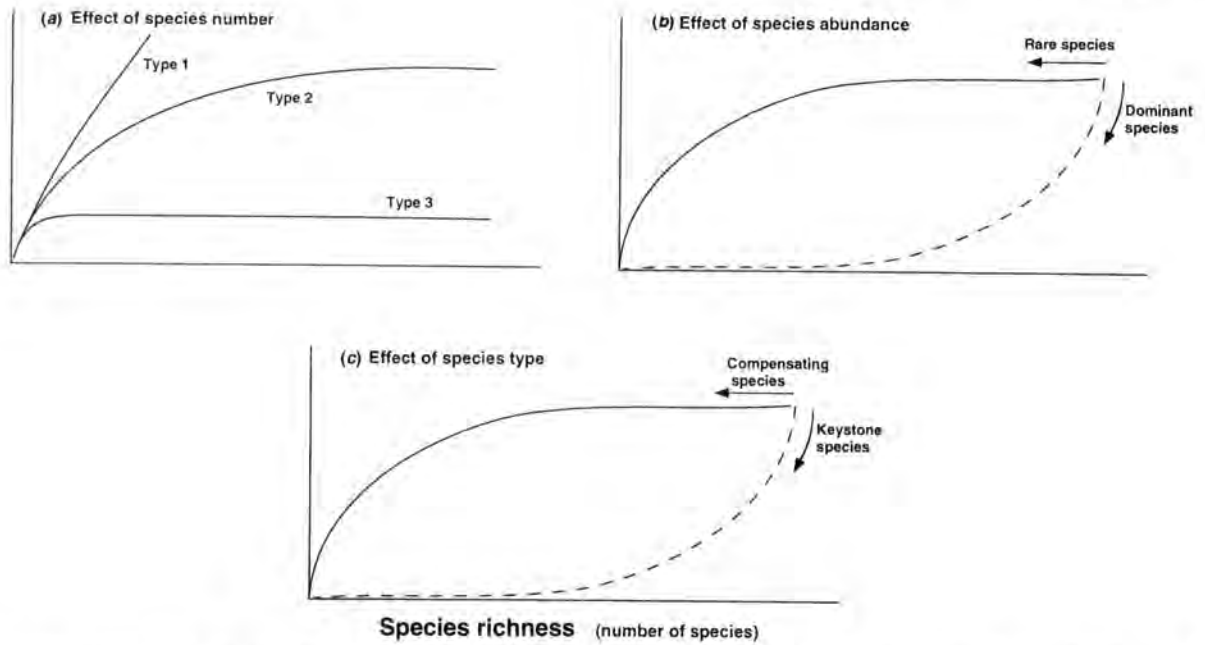

Figure 5.2-1: Some possible effects on ecosystem processes of (a) altering the number of species (ignoring relative abundance and traits of species; Vitousek and Hooper 1993); (b) deleting rare vs dominant species (Sala *et al.* 1996); (c) deleting keystone vs compensating species. The effect of number of species (a) depends on whether changes in ecosystem processes are equally affected by each species addition (Type 1), saturate with addition of new species (Type 2), or have an abrupt threshold with species diversity having no effect on ecosystem processes (Type 3). In (b) and (c), we assume a saturating relationship between ecosystem processes and species number. Arrows indicate the direction of change in ecosystem processes with deletion of species.

functionally similar to other species in the community (i.e. belongs to the same functional group) (Menge *et al.* 1986; Frost *et al.* 1995; Smith *et al.* 1995), its addition or deletion may have less effect than if the species has traits that uniquely affect community or ecosystem processes.

4. Certain traits of organisms have greater ecosystem impacts than other traits. Vitousek (1990) and Chapin *et al.* (1996) suggest that species modify ecosystem processes primarily through their effects on (1) availability of resources in the environment, (2) rates of consumption of resources or prey, and (3) the disturbance regime. In this section we summarize the general reasons for ecosystem sensitivity to changes in these categories of species effects. If a species is unique in the species or resources it consumes or controls (as often occurs at high trophic levels: top-down controls) or affects soil resource pools and supply rates (bottom-up controls, e.g. nitrogen fixation, hydraulic lift, litter quality) or disturbance frequency and intensity (the relative importance of equilibrium and non-equilibrium processes, e.g. digging and burrowing by animals, flammability in plants), gain or loss of such species is likely to have large *amplifying* effects on both community and ecosystem processes. These are the traits most likely to characterize keystone species. By contrast, if species are near the base of the food chain and are similar to other species in their resource (food) requirements, the addition or deletion of a

species generally has a small effect on ecosystem processes because of competitive interactions and *compensatory* responses by the existing or remaining species (Frost *et al.* 1995; Chapin *et al.* 1996). These compensatory changes alter community composition and diversity, but have minor effects on the quantity of resources consumed by the trophic level as a whole (Figure 5.2-1c).

5. Species which themselves have small effects on ecosystem processes can have large indirect effects if they influence the abundance of other species with large direct ecosystem effects. For example, a seed disperser or pollinator that has little direct effect on ecosystem processes may be essential for the persistence of a canopy species with greater direct ecosystem impact (Gilbert 1980; Paine 1980; Cushman 1995).

None of these criteria, taken singly, allow us to predict the community or ecosystem consequences of changes in diversity. However, taken together, these critical components of diversity determine the ecosystem consequences of addition or deletion of species from a community.

5.2.2.5 Effects of diversity per se on ecosystem processes

Species number (the first critical component of diversity) is functionally important because it (1) increases the rate or

efficiency of resource capture under steady-state conditions and (2) provides insurance against large changes in ecosystem processes in response to disturbance or environmental change. When species diversity is extremely low (e.g. a crop monoculture), total nutrient uptake and productivity of a crop, and its consumption by higher trophic levels, is often less than in more complex ecosystems (Swift and Anderson 1993; Vitousek and Hooper 1993; Naeem *et al.* 1994), although forests dominated by a single tree species are not notably less productive than highly diverse forests (Rodin and Bazilevich 1967). In artificial tropical communities, a variety of biogeochemical processes differed strikingly between plots with 0, 1, and 100 species but not among highly diverse plots of differing species composition (Ewel *et al.* 1991; Vitousek and Hooper 1993). Thus, we know that species diversity affects ecosystem processes somewhere between 1 and 100 species, but we do not know where this relationship saturates (Figure 5.2-1a). Artificial communities with differing numbers (1–4) of species per trophic level also differed in productivity (Naeem *et al.* 1994). The challenge in experimental studies is to separate the effects of species number from the effects of the traits of the component species. This is an important area for future research.

Species number is also important because it provides insurance against change in function in the event that a species is lost from an ecosystem. Because each species shows a unique response to climate and resources (Whittaker 1975; McNaughton 1977; Chapin and Shaver 1985), any change in climate or climatic extremes that is severe enough to cause extinction of one species is less likely to eliminate all members from a functional group. For example, Tilman and Downing (1994) showed that, due to the presence of drought-tolerant species, diverse grasslands maintain higher productivity in response to drought than do grasslands whose diversity has been reduced by experimental nutrient addition (see Section 6.1.7.3 and Figure 6.1-3). Conversely, the fewer species there are in a functional group or group of interacting species (e.g. pollinators), the more likely it is that any extinction event or series of such events will alter the ecosystem processes associated with that functional group (Holling 1986; Chapin *et al.* 1996). Thus, genetic and species diversity *per se* is important to the long-term maintenance of community and ecosystem structure and processes. This argues that no two species are ecologically redundant, even if they are similar in their ecosystem effects under a particular set of environmental circumstances.

It is intriguing to ask whether the hierarchical level at which diversity is expressed contributes significantly to the stability of ecosystem processes. Marine ecosystems may have a particularly broad range of physiological and genetic diversity because their diversity occurs at a higher

taxonomic level than in terrestrial systems. For example, 32 of the 33 extant animal phyla occur in the sea (Margulis and Schwartz 1988, Norse 1993) and exhibit a wide array of body plans, compared to the 17 phyla on land. We do not know whether this hierarchical level at which diversity is expressed contributes significantly to the environmental tolerance of ecosystem processes.

Species diversity is important to the maintenance of ecosystem processes over a complete cycle of common disturbance events. Following disturbance, initial colonization by early successional species often stabilizes the substrate, retains nutrients which are later used by other species, or retains moisture which facilitates colonization by less tolerant species. For example, riparian shrubs can stabilize stream banks sufficiently to allow colonization by forest trees (van Cleve *et al.* 1991). Rapid colonization by early successional species following fire or forest cutting retains nutrients which, in the long term, support the growth of late-successional forests (Stark and Steele 1977; Bormann and Likens 1979). The long-term stability and resilience of communities and ecosystems, therefore, probably requires a diversity of species whose ecosystem impact is minimal at most times but critical at certain phases of succession.

5.2.2.6 Mechanisms of community and ecosystem change due to species traits

Species often differ strikingly within and between communities in properties that affect community and ecosystem patterns and processes (Hobbie 1992, Wilson and Agnew 1992, Chapin 1993; van Breemen 1993; Paine 1994). Here we summarize the general reasons for ecosystem sensitivity to the fourth critical component of diversity, i.e. species traits that influence resource availability, resource consumption or disturbance.

(1) Ecosystem processes are highly sensitive to changes in species that influence the *supply or turnover rates* of water, nutrients or space. The supply of soil resources is an important 'bottom-up' control of terrestrial ecosystem processes (Jenny 1980). Similarly, nutrients are critical ecosystem controls in fresh water (Schindler 1978; Carpenter and Kitchell 1993) and in open and coastal marine ecosystems (Lobban and Harrison 1994; Menge *et al.* 1995). Space is a limiting resource in rocky intertidal communities (Dayton 1971; Connell 1978; Paine 1994). Many of the traits that influence resource supply tend to have highly skewed or discontinuous distributions among species in the community, so that a few species tend to have values for the trait that are quite different from those of other species in the community (Figure 5.2-1b,c). Introduction of exotic species with symbiotic nitrogen fixation in Hawaii greatly increased productivity and nitrogen cycling and altered the structure and species

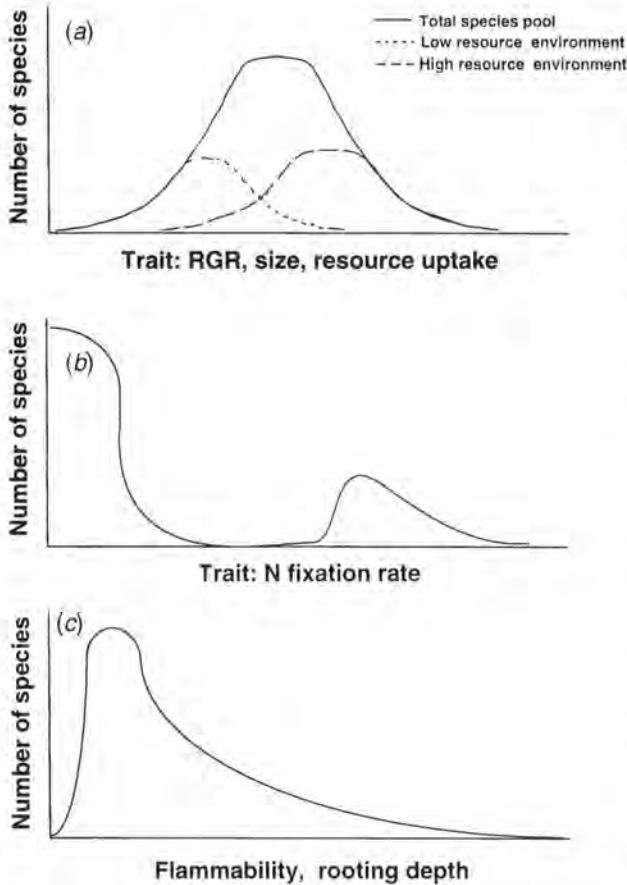

Figure 5.2-2: Typical frequency of occurrence of (a) continuously varying traits, (b) discrete traits, and (c) traits with skewed distribution among species in a community (Chapin *et al.* 1996).

composition of forests (Vitousek *et al.* 1987). Nepalese alder (*Alnus*) increases nitrogen inputs, and bamboo retains newly weathered potassium in Asian slash-and-burn agriculture (Ramakrishnan 1992). Each of the species in these examples differs strongly from other species in the community in its effects on nutrient supply. Similarly, introduction of deep-rooted species, such as *Eucalyptus* or *Tamarix*, can increase access to water and nutrients (van Hylckama 1974), thereby increasing the pool of resources available to support ecosystem productivity (Robles and Chapin 1996). These differences in rooting depth can be important at the regional scale. Simulations suggest that conversion of the Amazon Basin from forest to pasture would cause a permanent warming and drying of South America because the shallower roots of grasses would lead to reduced evapotranspiration and greater dissipation of energy as sensible heat (Shukla *et al.* 1990).

Animals can influence the resource base of the ecosystem by transporting nutrients among microsites within an ecosystem (e.g. concentration of nutrients in polygon troughs by lemmings (Batzli *et al.* 1980), on hilltops by sheep, or beneath desert shrubs by rodents) or by importing nutrients to oligotrophic ecosystems (e.g. nutrient movement from oceans to streams by migratory

salmon or transport of copepod fecal pellets to the deep sea). Species differences in soil microbial communities determine rates of nitrification, denitrification and methanogenesis and, consequently, the loss of trace gases to the atmosphere. Rates of nitrification also influence the susceptibility of N to loss by leaching or denitrification on land. Because these processes are controlled by relatively few species of microorganisms, i.e. the traits are uncommon and discontinuous, changes in their abundance could have large effects on N loss from ecosystems (Frost *et al.* 1995; Schimel 1995).

In terrestrial ecosystems, species also affect the resource supply rate through their influence on the turnover of nutrients in soils. Differences in tissue quality are critical controls over litter decomposition (Melillo *et al.* 1982; Flanagan and van Cleve 1983; Berg and McClaugherty 1989). Litter from low-resource plants decomposes slowly because of the negative effect on soil microbes of lignin, tannins, waxes and other recalcitrant or toxic compounds, reinforcing the low nutrient availability of these sites (Chapin 1991; Hobbie 1992). By contrast, species from high-resource sites produce rapidly decomposing litter with more N and P (Vitousek 1982) and *less* recalcitrant compounds. Thus, invasion or extinction of a species that differs substantially in litter quality from other species in the community could profoundly alter ecosystem processes. Long-term field experiments suggest that the nutrient content of litter is more important than carbon quality in exerting these ecosystem effects (Berendse *et al.* 1994). Because of the continuous variation in litter nutrient concentration among species (Chapin and Kedrowski 1983), litter-quality effects on ecosystem processes are probably a continuous function of plant traits. Plants can also alter nutrient supply rates through their effects on soil acidity, which is largely a function of the carbon quality of the litter and of the preferred form in which nitrogen is absorbed from the soil (Bormann and Likens 1979). Plants *indirectly* influence rates of nutrient supply through modification of the micro-environment (Wilson and Agnew 1992; Hobbie 1995). For example, arctic mosses, with their low rates of evapotranspiration (leading to water-logging) and effective insulation (preventing soil warming) indirectly inhibit decomposition (Gorham 1991). These species-specific effects could be important in determining both the pools of resources available to plants and higher trophic levels, and the rate at which these pools turn over.

Species traits that alter the resource supply have just as strong an effect on community processes as on ecosystem processes because resource supply and the balance of available resources determine the competitive balance among species in the community (Berendse *et al.* 1987; Tilman 1988; Aerts and van der Peijl 1993). In rocky intertidal communities, predation and herbivory on species that monopolize space play key roles in determining

community patterns and processes. By preventing mussels from dominating mid and lower shore levels, seastars on the northeastern Pacific and eastern Tasman shores, and snails on southeastern Pacific shores, make space available to a wide variety of invertebrates and seaweeds that would otherwise be outcompeted by mussels (Paine 1966, 1971; Duran and Castilla 1989). Likewise, herbivorous sea urchins and snails control the availability of critical resources (space and access to light) in tide pools by preferentially feeding on competitively dominant seaweeds (Dayton 1975; Lubchenco 1978). In terrestrial ecosystems, an increase in soil resources makes light relatively more limiting, shifting the competitive balance in favour of taller plants (Tilman 1985) and may increase the number of trophic levels that can be supported (Oksanen 1990; Power 1992). Thus, the impacts of resource supply on community structure extend well beyond the primary producers.

(2) The addition or loss of species that differ in their rates of resource consumption or the level to which resources are depleted can have either large or small effects on ecosystem processes, depending on their degree of overlap in resource use with other species in the community. Most plant species are similar to one another in the types of resources used (light, water and nutrients), although there can be specialization by rooting depth (see above), form of nitrogen utilized (Read 1991; Schulze *et al.* 1995), or the level to which soil resources are depleted (Tilman 1988). By contrast, animal and microbial disease organisms commonly vary in their degree of resource specialization and, therefore, in their degree of overlap with other species in a community. In many cases, specific traits of both the consumer and of the plant or prey, as well as characteristics of the environment in which the interaction occurs, determine the specific impact on rate of consumption of the resources or prey (Lubchenco and Gaines 1981).

Traits of plant species that best predict resource consumption are height (or biomass per individual) and relative growth rate (RGR) – traits that vary continuously among organisms (Grime and Hunt 1975) and that are unlikely to be strikingly distinct in any particular species (Figure 5.2-2a). Height (size) enhances resource capture in plants that are rooted to their substrates (e.g. terrestrial plants, aquatic macrophytes and sessile algae) by allowing the plant to reach the top of the canopy where most light is available and to exploit a large soil volume, whereas RGR is correlated with potential for carbon and nutrient acquisition (Olson and Lubchenco 1990; Lambers and Poorter 1992; Chapin 1993). In closed communities, any reduction in the abundance of one species should cause a compensatory increase in the abundance of other species due to release from competition, with little change in the total quantity of resources accumulated by vegetation at the ecosystem level (McNaughton 1977; Chapin and

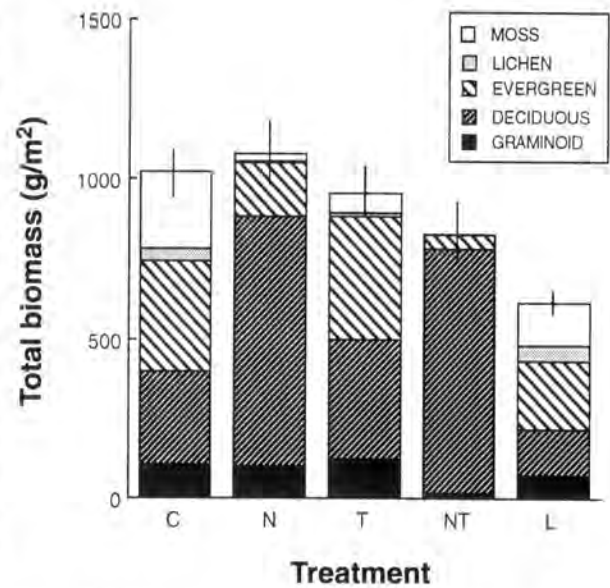

Figure 5.2-3: Total biomass (excluding roots) of plant functional groups in arctic tussock tundra after 9 years of different environmental manipulations: control (C), nutrient addition (N), greenhouse which raised summer air temperature by 3°C (T), fertilized greenhouse (NT), and shading to reduce light by 50% (L) (Chapin *et al.* 1996).

Shaver 1985). Consequently, we expect that the gain or loss of a species will have little effect on biogeochemical cycles within the ecosystem under 'steady-state' conditions (Shaver *et al.* 1995), if these species differ only in resource consumption. This hypothesis is supported by ecological responses to experimental and natural variation in resource supply, both of which show much larger changes in the abundance of individual species than in biogeochemical pools or fluxes measured at the ecosystem level (Figure 5.2-3, Table 5.2-1; McNaughton 1977; Chapin and Shaver 1985; Aerts and Berendse 1988; Chapin *et al.* 1995). In summary, even large changes in species diversity and abundance may have only modest *direct, short-term* effects on pools and fluxes of carbon and nutrients, when species differ only in rates of resource consumption. Similarly, many animal species, particularly grazers, have a broad overlap in diet, such that a change in abundance of one species is compensated by changes in abundance of competing species with minimal effect on the rate of consumption of their common prey species (Frost *et al.* 1995).

Many animal species (and some plant species) differ strikingly from all other species in the community in the resources they consume and, therefore, their effects on community structure. Addition or deletion of these species strongly influences the abundance of the limiting resources or prey that they consume, because they use discretely different resources from other species in the community. These top-down controls are particularly well developed in aquatic systems, where removal of sea otters releases sea

Table 5.2-1: Annual variation in production (% of five-year mean) of major tussock-tundra species and total community above-ground production (Chapin and Shaver 1985).

Species	Production (% of average)					Coefficient of variation (%)
	1968	1969	1970	1978	1981	
<i>Eriophorum</i>	77	58	148	101	116	35
<i>Betula</i>	30	52	55	248	121	88
<i>Ledum</i>	106	138	62	103	91	27
<i>Vaccinium</i>	135	172	96	28	71	56
Total production	93	110	106	84	107	11

urchins which graze down kelp (Estes and Palmisano 1974), or the addition or removal of a fish species can have large 'keystone' effects that propagate down the food chain (Carpenter *et al.* 1992; Power 1992). Many non-aquatic ecosystems also exhibit strong responses to changes in predator abundance (Hairston *et al.* 1960; Strong 1992). For example, removal of wolves can release deer populations which graze down vegetation (Rasmussen 1941), while the removal of elephants or other keystone mammalian herbivores leads to encroachment of woody plants into savannas (Owen-Smith 1988; Wilson and Agnew 1992). Similarly, epidemic diseases, such as rinderpest in Africa, can act as keystone species by greatly modifying competitive interactions and community structure (Bond 1993).

The strong effects of grazers and predators on community structure automatically translate into effects on ecosystem structure, for example by greatly altering the biomass of primary producers (Power 1992), perhaps even on a biogeographic scale (Gaines and Lubchenco 1982; Zimov *et al.* in press). However, we have only fragmentary information on the ways in which this altered ecosystem structure modifies ecosystem processes. Often these top-down controls by herbivores and predators have a much greater effect on the biomass and species composition of lower trophic levels than on the flow of energy or nutrients through the ecosystem (Carpenter *et al.* 1985) because declines in producer biomass are compensated by increased productivity and nutrient cycling rates by the remaining organisms. For example, intensively grazed grassland systems such as the southern and southeastern Serengeti Plains (McNaughton 1985) have a low plant biomass but rapid cycling of carbon and nutrients due to treading and excretion by large mammals, which prevent the accumulation of standing dead litter and return nutrients to the soil in plant-available forms (McNaughton 1988). Keystone predators or grazers can thus alter the pathway of energy and nutrient flow and modify the balance between herbivore-based and detritus-based food chains.

We expect these generalizations about the importance of traits determining resource consumption to apply to closed

communities where resource supply rather than colonization determines productivity and nutrient cycling and where multiple species use the same limiting resources. However, disturbance regime strongly influences the expression of these ecosystem effects (Menge *et al.* 1994; see also 5.3.1). As disturbance rate and intensity increase, patterns of resource supply and consumption become less important determinants of ecosystem processes, and the impact of strong biotic interactions and keystone predators is diminished (Menge *et al.* 1994).

(3) Animals or plants that greatly alter disturbance regime can have large effects on ecosystems by decreasing the relative importance of equilibrium processes relative to non-equilibrium processes. This is one of the most important ways in which animals affect ecosystem processes (Lawton and Jones 1995). For example, gophers and pigs create large areas of soil disturbance, creating sites for seedling establishment and favouring early-successional species (Hobbs and Mooney 1991; Kotanen in press), generally leading to a lower biomass and a higher ratio of production to biomass (Shaver 1995). Bivalves that bore into coral reefs increase the rate of bioerosion of coral heads and thus their susceptibility to dislodgment during storms (Highsmith 1980). At the regional scale, disturbances created by overgrazing can alter the albedo of the land surface and change patterns of regional temperature and precipitation (Charney *et al.* 1977; Schlesinger *et al.* 1990).

Plants can also alter disturbance regime through their effects on soil stability and their flammability. For example, introduction of grasses into forest or shrubland ecosystems can increase fire frequency and cause a replacement of forest by savannah (D'Antonio and Vitousek 1992). Similarly, boreal conifers are more flammable than deciduous trees because of their large leaf and twig surface area, low moisture content and high resin content (van Cleve *et al.* 1991). Plants and animals can also act to decrease disturbance. In early succession, plants are often critical in stabilizing soils and reducing wind and soil

erosion. This allows successional development and retains the soil resources that determine the structure and productivity of late-successional stages. Similarly, variation in size and shape of seaweeds has a substantial impact on their susceptibility to disturbance from wave forces (Gaylord *et al.* 1994) and, therefore, on community patterns of disturbance and succession (Dayton 1975). Both plant and animal traits that alter disturbance regime tend to be discontinuous, which increases their probability of having a large ecological impact on any given ecosystem. The ecological impact of adding or deleting species which influence disturbance regime depends on whether there are other species in the ecosystem sharing these traits.

Disturbance regime has just as large an impact on structure and processes at the community as at the ecosystem level through its effects on competitive interactions among species with different life-history traits. Disturbance regime determines the competitive balance between early and late-successional species (Olf *et al.* 1993), often resulting in the greatest species diversity at intermediate levels of disturbance (Connell 1978; Sousa 1979; Paine and Levin 1981; see 5.3.1).

5.2.2.7 Ecosystem-level feedbacks to biodiversity of invasions and extinctions

In natural ecosystems, biodiversity may be of greater inherent interest to society than ecosystem processes, because many of the goods and services (direct benefits of species; Ehrlich and Ehrlich 1981) that people derive from ecosystems relate to properties of species rather than to biogeochemical processes. However, the existence and quality of the Earth's atmosphere, climate, water and soil ('indirect benefits' of species; Ehrlich and Ehrlich 1981; Chapter 5.1) depend on biogeochemical processes. We have established that species traits and biodiversity do have implications for ecosystem processes. We also know that species are quite sensitive to their environment and that subtle changes in environment can alter competitive balances or rates of predation or herbivory, leading to changes in species composition and biodiversity (Lubchenco 1978). Perhaps the most important consequences of changes in species traits and biodiversity in natural ecosystems have to do with the largely unknown feedbacks of the altered environment to further changes in biodiversity. For example, invasion by alien grasses in Hawaiian forests resulted in increased fire frequency and a decline in the diversity of fire-sensitive woody species (D'Antonio and Vitousek 1992).

A second, largely unexplored consequence of changing biodiversity involves species-specific interactions with other species that have large ecosystem effects (the fifth critical component of diversity). For example, a seed disperser or pollinator that has little direct effect on ecosystem processes may be essential for the persistence of

a canopy species with greater direct ecosystem impact (Gilbert 1980; Paine 1980). At our present level of ignorance, these *indirect* effects of species on ecosystem processes are difficult to predict, suggesting that we should be conservative in drawing conclusions about the ecosystem impacts of loss of a given species or level of diversity.

5.2.2.8 Conclusions

Five critical components of diversity required to predict the functional consequences of species additions or losses are (1) the number of species in a community, (2) the relative abundance of these species, (3) how strongly an invading or deleted species differs from other species in the community, (4) the traits of the species and (5) the indirect effects that a species has on other species in the community. The major mechanisms by which species alter ecosystem processes are through changes in soil resource supply, the consumption of resources or food, and disturbance regime.

The gain or loss of a species will have its greatest impact on ecosystem processes when there are few species in the community, when the species gained or lost is a dominant species, and/or when the species differs strongly from other species in the community. When species are similar to one another in their resource requirements, as often occurs with plants and generalist herbivores, the gain or loss of a species has a large effect on community composition but less effect on ecosystem processes because of the compensatory responses of other species to the altered competitive environment. Compensatory responses are most likely to occur where there are many species per functional group. The traits that govern resource acquisition in these species are often continuously distributed among species, so that species differ quantitatively rather than qualitatively in their effects on ecosystem processes.

By contrast, the gain or loss of species that consume unique food or soil resources or that alter resource supply or disturbance regime can have large effects on ecosystem processes, which propagate through the ecosystem through a chain of indirect effects. Traits governing these processes often differ qualitatively among species, so that changes in the abundance of these species have widespread community and ecosystem impacts. Species effects on ecosystem processes are often as large as direct climatic effects and must be included in predictive models of the role of terrestrial ecosystems in global processes.

Species diversity (independent of species traits) is functionally important because it provides insurance against large changes in ecosystem processes and may enhance the efficiency with which resources are captured from the environment and transferred among species. Because each species shows a unique response to climate and resources, any change in climate or climatic extremes

that is severe enough to cause extinction is less likely to eliminate all members of a functional group. The fewer species there are in a functional group or group of interacting species (e.g. pollinators), the more likely it is that any extinction event or series of such events will seriously affect the function associated with that functional group. Although species clearly differ in the magnitude of their impact on community and ecosystem processes, the differences among species in their responses to disturbances and environmental extremes and their indirect ecosystem effects, mediated by species interactions, make it unlikely that there is much, if any, ecological redundancy in communities over time scales of decades to centuries, the time period over which environmental policy should operate.

References

- Aerts, R. and Berendse, F. 1988. The effect of increased nutrient availability on vegetation dynamics in wet heathlands. *Vegetatio* **76**: 63–69.
- Aerts, R. and van der Peijl, M.J. 1993. A simple model to explain the dominance of low-productive perennials in nutrient-poor habitats. *Oikos* **66**: 144–147.
- Batzli, G.O., White, R.G., MacLean, S.F. Jr, Pitelka, F.A. and Collier, B.D. 1980. The herbivore-based trophic system. In: Brown, J., Miller, P.C., Tieszen, L.L. and Bunnell, F.L. (eds), *An Arctic Ecosystem: The coastal tundra at Barrow, Alaska*. 335–410. Dowden, Hutchinson and Ross, Stroudsburg, Pa.
- Berendse, F., Oudhof, H. and Bol, J. 1987. A comparative study on nutrient cycling in wet heathland ecosystems. I. Litter production and nutrient losses from the plant. *Oecologia* **74**: 174–184.
- Berendse, F., Schmitz, M. and de Visser, W. 1994. Experimental manipulation of succession in heathland ecosystems. *Oecologia* **100**: 38–44.
- Berg, B. and McClaugherty, C. 1989. Nitrogen and phosphorus release from decomposing litter in relation to lignin. *Canadian Journal of Botany* **67**: 1148–1156.
- Bond, W.J. 1993. Keystone species. In: Schulze, E.-D. and Mooney, H.A. (eds), *Ecosystem Function and Biodiversity*. 237–253. Springer-Verlag, Berlin.
- Bormann, F.H. and Likens, G.E. 1979. *Pattern and Process in a Forested Ecosystem*. Springer-Verlag, New York.
- Carleton, J.T. and Geller, J.B. 1993. Ecological roulette: the global transport of nonindigenous marine organisms. *Science* **261**: 78–82.
- Carpenter, S.R., Fisher, S.G., Grimm, N.B. and Kitchell, J.F. 1992. Global change and freshwater ecosystems. *Annual Review of Ecology and Systematics* **23**: 119–139.
- Carpenter, S.R., and Kitchell, J.F. (eds) 1993. *The Trophic Cascade in Lakes*. Cambridge University Press, Cambridge.
- Carpenter, S.R., Kitchell, J.F. and Hodgson, J.R. 1985. Cascading trophic interactions and lake productivity. *BioScience* **35**: 634–639.
- Chapin, F.S., III. 1991. Effects of multiple environmental stresses on nutrient availability and use. In: Mooney, H.A., Winner, W.E. and Pell, E.J. (eds), *Response of Plants to Multiple Stresses*. 67–68. Academic Press, San Diego.
- Chapin, F.S., III. 1993. Functional role of growth forms in ecosystem and global processes. In: Ehleringer, J.R. and Field, C.B. (eds), *Scaling Physiological Processes: Leaf to globe*. 287–312. Academic Press, San Diego.
- Chapin, F.S., III and Kedrowski, R.A. 1983. Seasonal changes in nitrogen and phosphorus fractions and autumn retranslocation in evergreen and deciduous taiga trees. *Ecology* **64**: 376–391.
- Chapin, F.S., III, Reynolds, H.L., D'Antonio, C. and Eckhart, V. 1996. The functional role of species in terrestrial ecosystems. In: Walker, B. *Global Change in Terrestrial Ecosystems* (in press).
- Chapin, F.S., III and Shaver, G.R. 1985. Individualistic growth response of tundra plant species to environmental manipulations in the field. *Ecology* **66**: 564–576.
- Chapin, F.S., III, Shaver, G.R., Giblin, A.E., Nadelhoffer, K.G. and Laundre, J.A. 1995. Response of arctic tundra to experimental and observed changes in climate. *Ecology* **76**: 694–711.
- Charney, J.G., Quirk, W.J., Chow, S.-H. and Kornfield, J. 1977. A comparative study of effects of albedo change on drought in semiarid regions. *Journal of Atmospheric Science* **34**: 1366–1385.
- Connell, J.H. 1978. Diversity in tropical rain forests and coral reefs. *Science* **199**: 1302–1310.
- Cushman, J.H. 1995. Ecosystem-level consequences of species additions and deletions on islands. In: Vitousek, P.M. (ed.), *Islands*. 135–147. Springer-Verlag, Berlin.
- D'Antonio, C.M. and Vitousek, P.M. 1992. Biological invasions by exotic grasses, the grass-fire cycle, and global change. *Annual Review of Ecology and Systematics* **23**: 63–87.
- Dayton, P.K. 1971. Competition, disturbance and community organization: the provision and subsequent utilization of space in a rocky intertidal community. *Ecological Monographs* **41**: 351–389.
- Dayton, P.K. 1975. Experimental evaluation of ecological dominance in a rocky intertidal algal community. *Ecological Monographs* **45**: 137–159.
- Drake, J.A., Mooney, H.A., diCasteri, F., Groves, R.H., Durger, F. J., Rejmanek, M. and Williamson, M. (eds) 1989. *Biological Invasions: A global perspective*. John Wiley, Chichester.
- Durán, L.R. and Castilla, J.C. 1989. Variation and persistence of the middle rocky intertidal community of central Chile, with and without human harvesting. *Marine Biology* **103**: 555–562.
- Ehrlich, P.R. and Ehrlich, A.H. 1981. *Extinction. The causes and consequences of the disappearance of species*. Random House, New York.
- Estes, J.A., and Palmisano, J.F. 1974. Sea otters: their role in structuring nearshore communities. *Science* **185**: 1058–1060.
- Ewel, J.J., Mazzarino, M.J. and Berish, C.W. 1991. Tropical soil fertility changes under monocultures and successional communities of different structure. *Ecological Applications* **1**: 289–302.
- Flanagan, P.W. and van Cleve, K. 1983. Nutrient cycling in relation to decomposition and organic matter quality in taiga

- ecosystems. *Canadian Journal of Forest Research* **13**: 795–817.
- Frost, T.M., Carpenter, S.R., Ives, F. and Kratz, T.K.** 1995. Species compensation and complementarity in ecosystem function. In: Jones, C.G. and Lawton, J.H. (eds), *Linking Species and Ecosystems*. 224–239. Chapman and Hall, New York.
- Gaines, S.D. and Lubchenco, J.** 1982. A unified approach to marine plant-herbivore interactions. II. Biogeography. *Annual Review of Ecology and Systematics* **13**: 111–138.
- Gaylord, B., Blanchette, C.A. and Denny, M.W.** 1994. Mechanical consequences of size in wave-swept algae. *Ecological Monographs* **64**: 287–313.
- Gilbert, L.E.** 1980. Food web organization and the conservation of neotropical diversity. In: Soulé, M.E. and Wilcox, B.A. (eds), *Conservation Biology: An evolutionary-ecological perspective*. 11–33. Sinauer Associates, Sunderland, Mass.
- Gorham, E.** 1991. Northern peatlands: role in the carbon cycle and probable responses to climatic warming. *Ecological Applications* **1**: 182–195.
- Grime, J.P. and Hunt, R.** 1975. Relative growth rate: Its range and adaptive significance in a local flora. *Journal of Ecology* **63**: 393–422.
- Hairston, N.G., Smith, F.E. and Slobodkin, L.B.** 1960. Community structure, population control and competition. *American Naturalist* **94**: 421–425.
- Highsmith, R.C.** 1980. Geographic patterns of coral bioerosion: a productivity hypothesis. *Journal of Experimental Marine Biology and Ecology* **46**: 177–196.
- Hobbie, S.E.** 1992. Effects of plant species on nutrient cycling. *Trends in Ecology and Evolution* **7**: 336–339.
- Hobbie, S.E.** 1995. Direct and indirect effects of plant species on biogeochemical processes in arctic ecosystems. In: Chapin F.S. III and Körner, C. (eds), *Arctic and alpine biodiversity: Patterns, causes and ecosystem consequences*. 213–224. Springer-Verlag, Berlin.
- Hobbs, R.J., and Mooney, H.A.** 1991. Effects of rainfall variability and gopher disturbance on serpentine annual grassland dynamics. *Ecology* **72**: 59–68.
- Holling, C.S.** 1986. Resilience of ecosystems: Local surprise and global change. In: Clark, W. C. and Munn, R. E. (eds), *Sustainable Development and the Biosphere*. 292–317. Cambridge University Press, Cambridge.
- Huston, M.A.** 1994. *Biological Diversity: The coexistence of species on changing landscapes*. Cambridge University Press, Cambridge.
- Jenny, H.** 1980. *The Soil Resources: Origin and behavior*. Springer-Verlag, New York.
- Kotanen, P.M.** 1996. Responses of vegetation to a changing regime of disturbance: effects of feral pigs on a California coastal prairie. *Ecography* (in press).
- Lambers, H. and Poorter, H.** 1992. Inherent variation in growth rate between higher plants: a search for physiological causes and ecological consequences. *Advances in Ecological Research* **23**: 187–261.
- Lawton, J.H., and Brown, V.K.** 1993. Redundancy in ecosystems. In: Schulze, E.-D. and Mooney, H.A. (eds), *Biodiversity and Ecosystem Function*. 255–270. Springer-Verlag, Berlin.
- Lawton, J.H. and Jones, C.G.** 1995. Linking species and ecosystems: organisms as ecosystem engineers. In: Jones, C.G. and Lawton, J.H. (eds), *Linking Species and Ecosystems*. 141–150. Chapman and Hall, New York.
- Lobban, C.S. and Harrison, P.J.** 1994. *Seaweed Ecology and Physiology*. Cambridge University Press, Cambridge.
- Lubchenco, J.** 1978. Plant species diversity in a marine intertidal community: importance of herbivore food preference and algal competitive abilities. *American Naturalist* **112**: 23–39.
- Lubchenco, J. and Gaines, S.D.** 1981. A unified approach to marine plant-herbivore interactions. I. Populations and communities. *Annual Review of Ecology and Systematics* **12**: 405–437.
- McNaughton, S.J.** 1977. Diversity and stability of ecological communities: a comment on the role of empiricism in ecology. *American Naturalist* **111**: 515–525.
- McNaughton, S.J.** 1985. Ecology of a grazing ecosystem: the Serengeti. *Ecological Monographs* **53**: 259–294.
- McNaughton, S.J.** 1988. Mineral nutrition and spatial concentrations of African ungulates. *Nature* **334**: 343–345.
- Margulis, L. and Schwartz, K. V.** 1988. *Five Kingdoms: An illustrated guide to the phyla of life on earth*. W. H. Freeman, New York.
- Melillo, J.M., Aber, J.D. and Muratore, J.F.** 1982. Nitrogen and lignin control of hardwood leaf litter decomposition dynamics. *Ecology* **63**: 621–626.
- Menge, B.A., Berlow, E.L., Blanchette, C.A., Navarrete, S.A. and Yamada, S.B.** 1994. The keystone species concept: variation in interaction strength in a rocky intertidal habitat. *Ecological Monographs* **64**: 249–286.
- Menge, B.A., Daley, B. and Wheeler, P.A.** 1995. Control of interaction strength in marine benthic communities. In: Polis, G.A. and Winemiller, R. (eds), *Food Webs: Integration of pattern and dynamics*. Chapman and Hall, New York.
- Menge, B.A., Lubchenco, J., Ashkenas, L.R. and Ramsey, F.** 1986. Experimental separation of effects of consumers on sessile prey in the low zone of a rocky shore in the Bay of Panama: direct and indirect consequences of food web complexity. *Journal of Experimental Marine Biology and Ecology* **100**: 225–269.
- Naeem, S., Thompson, L.J., Lawler, S.P., Lawton, J.H. and Woodfin, R.M.** 1994. Declining biodiversity can alter the performance of ecosystems. *Nature* **368**: 734–737.
- Norse, E.A., (ed.)** 1993. *Global Marine Biological Diversity: A strategy for building conservation into decision making*. Island Press, Washington, DC.
- NRC.** 1995. *Understanding Marine Biodiversity*. National Academy Press, Washington, DC.
- Oksanen, L.** 1990. Predation, herbivory, and plant strategies along gradients of primary productivity. In: Grace, J.B. and Tilman, D. (eds), *Perspectives on plant competition*. 445–474. Academic Press, San Diego.
- Oloff, H., Huisman, J. and van Tooren, B.F.** 1993. Species dynamics and nutrient accumulation during early primary succession in coastal sand dunes. *Journal of Ecology* **81**: 693–703.
- Olson, A.M. and Lubchenco, J.** 1990. Competition in seaweeds: linking plant traits to competitive outcomes. *Journal of Phycology* **26**: 1–6.

- Owen-Smith, R.N. 1988. *Mega-herbivores: The influence of very large body size on ecology*. Cambridge University Press, Cambridge.
- Paine, R.T. 1966. Food web complexity and species diversity. *American Naturalist* **100**: 65–75.
- Paine, R.T. 1969. A note on trophic complexity and community stability. *American Naturalist* **103**: 91–93.
- Paine, R.T. 1971. A short-term experimental investigation of resource partitioning in a New Zealand rocky intertidal habitat. *Ecology* **52**: 1096–1106.
- Paine, R.T. 1980. Food webs: linkage, interaction strength and community infrastructure. *Journal of Animal Ecology* **49**: 667–685.
- Paine, R.T. 1994. *Marine Rocky Shores and Community Ecology: An experimentalist's perspective*. Ecology Institute, Oldendorf/Luhe.
- Paine, R.T. and Levin, S.A. 1981. Intertidal landscapes: disturbance and the dynamics of pattern. *Ecological Monographs* **51**: 145–178.
- Power, M.E. 1992. Hydrologic and trophic controls of seasonal algal blooms in northern California rivers. *Archiv für Hydrobiologie* **125**: 385–410.
- Power, M.E. and Mills, L.S. 1995. The Keystone cops meet in Hilo. *Trends in Ecology and Evolution* **10**: 182–184.
- Ramakrishnan, P.S. 1992. *Shifting Agriculture and Sustainable Development: An interdisciplinary study from North-eastern India*. Parthenon Publishing Group, Park Ridge, NJ.
- Rasmussen, D.I. 1941. Biotic communities of Kaibab Plateau, Arizona. *Ecological Monographs* **3**: 229–275.
- Read, D.J. 1991. Mycorrhizas in ecosystems. *Experientia* **47**: 376–391.
- Robles, M. and Chapin, F. S., III. 1996. Comparison of the influence of two exotic species on ecosystem processes in the Berkeley Hills. *Madroño* (in press).
- Rodin, L.E. and Bazilevich, N.I. 1967. *Production and Mineral Cycling in Terrestrial Vegetation*. Oliver and Boyd, Edinburgh, UK.
- Sala, O.E., Lauenroth, W.K., McNaughton, S.J., Rusch, G. and Zhang, X. 1996. Biodiversity and ecosystem function in grasslands. In: Mooney, H.A., Cushman, J.H., Medina, E., Sala, O.E. and Schulze, E.-D. (eds), *Functional Roles of Biodiversity: A global perspective*. John Wiley, Chichester (in press).
- Schimel, J. 1995. Ecosystem consequences of microbial diversity and community structure. In: Chapin, F. S., III. and Körner, C. (eds), *Arctic and Alpine Biodiversity: Patterns, causes and ecosystem consequences*. 237–252. Springer-Verlag, Berlin.
- Schindler, D.W. 1978. Factors regulating phytoplankton production and standing crop in the world's lakes. *Limnology and Oceanography* **23**: 478–486.
- Schlesinger, W.H., Reynolds, J.F., Cunningham, G.L., Huenneke, L.F., Jarrell, W.M., Virginia, R.A. and Whitford, W.G. 1990. Biological feedbacks in global desertification. *Science* **247**: 1043–1048.
- Schulze, E.-D., Chapin, F. S., III and Gebauer, G. 1995. Nitrogen nutrition and isotope differences among life forms at the northern treeline of Alaska. *Oecologia* **100**: 406–412.
- Shaver, G.R. 1995. Plant functional diversity and resource control of primary production in Alaskan arctic tundras. In: Chapin, F.S., III and Körner, Ch. (eds), *Arctic and Alpine Biodiversity: Patterns, causes and ecosystem consequences*. 199–211. Springer-Verlag, Berlin.
- Shaver, G.R., Giblin, A.E., Nadelhoffer, K.J. and Rastetter, E.B. 1995. Plant functional types and ecosystem change in arctic tundras. In: Smith, T., Shugart, H.H. and Woodward, F.I. *Plant Functional Types*. Cambridge University Press, Cambridge (in press).
- Shukla, J., Nobre, C. and Sellers, P. 1990. Amazon deforestation and climate change. *Science* **247**: 1322–1325.
- Smith, T., Shugart, H.H. and Woodward, F.I. (eds) 1995. *Plant Functional Types*. Cambridge University Press, Cambridge (in press).
- Solbrig, O.T., (ed.) 1991. *From Genes to Ecosystems: A research agenda for biodiversity*. International Union of Biological Sciences, Cambridge, Mass.
- Sousa, W.P. 1979. Disturbance in marine intertidal boulder fields: the nonequilibrium maintenance of species diversity. *Ecology* **60**: 1225–1239.
- Stark, N.M. and Steele, R. 1977. Nutrient content of forest shrubs following burning. *American Journal of Botany* **64**: 1218–1224.
- Strong, D.R. 1992. Are trophic cascades all wet? Differentiation and donor-control in speciose ecosystems. *Ecology* **73**: 747–754.
- Swift, M.J. and Anderson, J.M. 1993. Biodiversity and ecosystem function in agricultural systems. In: Schulze, E.-D. and Mooney, H.A. (eds) *Biodiversity and Ecosystem Function*. 15–41. Springer-Verlag, Berlin.
- Tilman, D. 1985. The resource-ratio hypothesis of plant succession. *American Naturalist* **125**: 827–852.
- Tilman, D. 1988. *Plant Strategies and the Dynamics and Function of Plant Communities*. Princeton University Press, Princeton, NJ.
- Tilman, D. and Downing, J.A. 1994. Biodiversity and stability in grasslands. *Nature* **367**: 363–365.
- Valiela, I. 1984. *Marine Ecological Processes*. Springer-Verlag, New York.
- van Breemen, N. 1993. Soils as biotic constructs favouring net primary productivity. *Geoderma* **57**: 183–211.
- van Cleve, K., Chapin, F. S., III, Dryness, C.T. and Viereck, L.A. 1991. Element cycling in taiga forest: State-factor control. *BioScience* **41**: 78–88.
- van Hytckama, T.E.A. 1974. Water use by salt cedar as measured by the water budget method. *Geological Survey Professional Paper* 491–E.
- Vitousek, P.M. 1982. Nutrient cycling and nutrient use efficiency. *American Naturalist* **119**: 553–572.
- Vitousek, P.M. 1990. Biological invasions and ecosystem processes: Towards an integration of population biology and ecosystem studies. *Oikos* **57**: 7–13.
- Vitousek, P.M. and Hooper, D.U. 1993. Biological diversity and terrestrial ecosystem biogeochemistry. In: Schulze, E.-D. and Mooney, H.A. (eds), *Biodiversity and Ecosystem Function*. 3–14. Springer-Verlag, Berlin.
- Vitousek, P.M., Walker, L.R., Whiteacre, L.D., Mueller-Dombois, D. and Matson, P.A. 1987. Biological invasion by *Myrica*

faya alters ecosystem development in Hawaii. *Science* **238**: 802–804.

Walker, B.H. 1992. Biodiversity and ecological redundancy. *Conservation Biology* **6**: 18–23.

Whittaker, R.H. 1975. *Communities and Ecosystems*. Macmillan, New York.

Wilson, J.B. and Agnew, D.Q. 1992. Positive-feedback switches in plant communities. *Advances in Ecological Research* **23**: 263–336.

Woodward, F.I. 1987. *Climate and Plant Distribution*. Cambridge University Press, Cambridge.

Zimov, S.A., Chuprynin, V.I., Oreshko, A.P., Chapin, F. S., III, Reynolds, J.F. and Chapin, M.C. 1995. Steppe–tundra transition: An herbivore-driven biome shift at the end of the Pleistocene. *American Naturalist* (in press).

5.2.3 Effects of spatial structure on ecosystem functioning

5.2.3.1 Introduction

Species are the building blocks of ecosystems, and as described in Section 5.2.2, the loss of species can lead to changes in ecosystem attributes beyond the species level, e.g. biomass, productivity, disturbance frequency, and the rates of biogeochemical flows. Not all species are equal in terms of their influence on their ecosystem, but Section 5.2.2 indicated some types of species likely to have large impacts: animal species high in the food chain; plant species with a dominant influence on the resource supply, or on the composition of the soil or litter; and species with unique attributes, such as nitrogen-fixing plants in N-poor environments. In Section 5.2.2 it is also suggested that ecosystem attributes depend on the total diversity of the biota, above and beyond the contributions of particular species.

Here the effects of spatial structure on ecosystem functioning are addressed. By spatial structure we mean the sizes and shapes of patches of different types of habitat (here used synonymously with ecosystem), and the distances of these patches from one another. A solid base of theory and empirical evidence shows that spatial structure can profoundly influence the diversity, abundance and interactions of species in ecosystems. In other words, two otherwise similar natural areas, differing only in their spatial configuration, will differ in their species composition and thus in other ecosystem attributes. This is of key importance, since one of humans' most ubiquitous effects on ecosystems is to fragment them. Virtually all natural areas today are not only smaller in total extent, but also considerably patchier than they once were (Groom and Schumaker 1993). Here we explain why patchiness matters, and why spatial structure must be a central consideration in conservation plans.

At the present state of ecological knowledge there is little evidence linking spatial structure directly to flows of

matter and energy, or to other attributes of ecosystems beyond the level of species. This remains an extremely important area for research. However, all ecosystem properties depend ultimately on the biota. Therefore, we review the considerable evidence on the effect of spatial structure on species and their interactions, returning at the end to the possible consequences at other levels of ecosystem organization. (Also see Saunders *et al.* 1991 and Fahrig and Merriam 1994 for excellent reviews of the consequences of fragmentation.)

5.2.3.2 Effects of spatial structure on species diversity and abundance

Local extinction and metapopulations. Ecologists increasingly view most species as consisting of so-called 'metapopulations', i.e. networks of local populations occupying discontinuous habitats, but partly connected to one another by occasional dispersal (see also Section 4.4). Extinctions of these local populations ('local' as opposed to regional or global extinction) may occur frequently in some species, owing to disturbances, changes in the habitat, or natural catastrophes. This implies that the survival of some species may be dependent on the ongoing founding of new local populations. Theory suggests that the chances of persistence for a metapopulation depend on how many local populations and suitable habitat patches there are, the length of time each local population persists before becoming extinct, and the propensity of the species to disperse between habitat patches and found new populations on empty patches (Hanski 1989, 1991; Hanski and Gilpin 1991; Fahrig and Merriam 1994; Hastings and Harrison 1994).

The majority of empirical studies of metapopulations have been on insects and other small and short-lived animals. Similar patterns are likely to be found in other species, but at larger scales of space and time. One common pattern is a 'mainland–island' spatial structure, in which the metapopulation contains one or more local populations large enough to be in no immediate danger of extinction, as well as many smaller populations. The small populations blink in and out of existence, going extinct during droughts, floods, harsh winters or other adverse circumstances, and being recolonized by immigrants from the mainland. If dispersal is blocked, the small populations will cease to exist: if the mainland population is lost, the species will become regionally extinct. Well-documented examples include several species of spiders on small islands (Schoener and Spiller 1987; Schoener 1991), and butterflies on patches of habitat supporting the plants on which their caterpillars feed (Harrison *et al.* 1988; Thomas and Harrison 1992).

In an alternative pattern there is no mainland and all local populations are fairly susceptible to local extinction. In this case the regional survival of the species is much

more precarious: there must be enough populations and available habitat patches within the region, and rates of dispersal among them must be high enough, to allow the founding of local populations can keep pace with their extinction. An excellent example is provided by the pool frog *Rana lessonae* in Sweden, on the northern edge of its distribution. Frog populations in individual ponds naturally become extinct during severe winters, or when succession obliterates the ponds. However, because modern forestry practices are both reducing the number of ponds and obstructing the dispersal of frogs among ponds, the frog may be on its way to regional extinction (Sjogren 1991, 1994). Similar patterns have been observed in other amphibians in temporary ponds (Gill 1978; Sinsch 1992).

Consequences for diversity and abundance. When the metapopulation processes of local extinction and recolonization are important, they lead to an obvious pattern in a species' spatial distribution. Habitat patches that are large and/or close to other patches will support populations of the species most of the time, while small or isolated patches will more often be unoccupied. This pattern is seen in amphibians (Laan and Verboom 1990), birds (Opdam 1990; Verboom *et al.* 1991), mammals (Lawton and Woodroffe 1991; Peltonen and Hanski 1991), and butterflies (Thomas *et al.* 1992) in fragmented European landscapes. Most importantly, when this is the case the regional survival of the species may be highly sensitive to any further changes in the spatial structure of its habitat. It may quickly collapse to regional extinction if the size or number of habitat patches is reduced, the average distances among patches increases, or changes in the habitat between patches make dispersal more difficult.

Based on this evidence, we may expect human-induced fragmentation to reduce the diversity of native species in natural habitats. The types of species most likely to be lost are those with the highest rates of local extinction on small habitat patches, such as the top predators and other species with large body sizes and large area requirements. Also likeliest to be lost are those species with the lowest abilities to disperse among and colonize habitat patches, which include typical late-successional ('climax') species. Conversely, the species likeliest to survive fragmentation will be those best adapted to patchy and frequently disturbed environments, meaning the well-dispersing, early-successional ('weedy') species (Tilman *et al.* 1994). Moreover, even if outright extinctions do not happen immediately, fragmentation will tend to shift species' relative abundances within ecosystems, such that the population densities of weedy species will increase and those of climax species decrease.

We also know that the genetic diversity within species is profoundly affected, and usually reduced, by the

fragmentation, extinction and recolonization of populations (McCauley 1991). What we do not know, as yet, is how much the loss of genetic variation affects the prospects for species' survival (see also 4.2).

5.2.3.3 Effects of spatial structure on species interactions

Pollination. If spatial structure can affect the distributions and abundances of species, it follows that its consequences can cascade through communities of interacting species. Some of the best examples concern the coevolved relationships between plants and the animals that pollinate them, or disperse their seeds (Bawa 1990). In Sweden, the herb *Dianthus deltooides* receives fewer visits by pollinating butterflies, and therefore suffers lower seed set, because of population fragmentation (Jennersten 1988). In small remnant patches of *chaco* (dry forest) in Argentina, numerous plant species experience fewer visits by specialized native pollinators and more visits by generalist introduced honeybees (*Apis mellifera*), leading to reduced seed output (Aizen and Feinsinger 1994a, b). Many similar examples are reviewed by Saunders *et al.* (1991) and Rathcke and Jules (1993). Possible consequences for plant populations include declining abundance, loss of genetic diversity and eventual extinction.

Herbivory. Because of their large area requirements, large mammals are usually among the first animal species to disappear from fragmented forests. Their loss may affect the structure of the entire forest because of the role they play as seed predators and herbivores. Leigh *et al.* (1993) examined small islands of tropical forest formed by the construction of a dam in Panama, and found they had fewer tree species than the forests on the nearby mainland. The islands were dominated by a few tree species whose seeds, on the mainland, were favoured foods of mammals such as agoutis. The absence of agoutis on the islands allowed these trees to become the dominant competitors, reducing overall diversity. Similarly, Dirzo and Miranda (1991) found that the absence of mammalian herbivores from small forest fragments in Mexico led to higher competition among tree seedlings, which led to forests dominated by a few competitively superior tree species.

Predation. Very important ecosystem services are provided by predators that control populations of herbivores, especially herbivores with potentially large effects on biomass and nutrient cycling. Large predators are especially likely to become scarce or disappear from fragmented ecosystems, for the reasons discussed above. Losing lions or cheetahs from fragmented African savannas may have enormous impacts on the vegetation and fire regimes, for example – effects that will be played out over the next several decades or centuries.

This point is best illustrated by predatory insects that can also have large ecosystem effects, but on faster time scales. Many herbivorous insects can undergo outbreaks that

devastate forests or other natural habitats. Ecologists believe that a major natural role in suppressing outbreaks is played by so-called parasitoids, which are insects (usually wasps or flies) that lay their eggs on the bodies of living host insects (which may be herbivorous 'pest' species). The developing larva of the parasitoid subsequently kills the host insect. Roland (1993) found that outbreaks of tent caterpillars lasted longer in heavily fragmented Canadian forests than in less fragmented ones, possibly because parasitoids were less efficient at finding their hosts (caterpillars) in patchy forests. Kruess and Tscharrntke (1994) found that in agro-ecosystems as well, fragmentation can lead to fewer parasitoids and more herbivorous insects on plants.

Conversely, fragmentation can also allow natural habitats to be invaded by predators that are scarce in less disturbed situations. Many studies have reported that birds breeding in remnant patches of forest suffer elevated losses of eggs and nestlings to domestic cats, avian brood parasites (e.g. cuckoos), and other predators that thrive in the surrounding human-dominated landscape (Wilcove 1985; Andren and Angelstam 1988; Small and Hunter 1988; Paton 1994). Fragmentation may also influence the prevalence and spread of pathogens (Jarosz and Burdon 1991; Grosholz 1993).

Decomposition. One of the most direct links between fragmentation and ecosystem processes was found by Klein (1989), who examined communities of dung beetles in remnant patches of Amazon Basin forest. Dung beetles are extremely important recyclers of organic matter in nutrient-poor tropical forests. Klein found that forest fragmentation not only altered species composition, with fewer species of dung beetles (and sparser populations) in small patches than in larger tracts of forest, but also led to lower rates of dung decomposition, indicating a significant change in nutrient processing. Although this is an isolated example, it may not be at all unusual. We simply do not know how many changes of ecosystem significance are happening in tropical forests, which are extraordinarily rich in species and specialized interactions, very poorly understood by biologists, and currently threatened by rapid and severe fragmentation.

5.2.3.4 Spatial structure and ecosystems

We have seen that spatial structure has major effects on species composition, abundance, and interactions between species in ecosystems. At present we cannot make definite statements about the consequences of spatial structure at other levels of ecosystem organization, such as disturbance rates or biogeochemical flows. However, we have seen that the kinds of species most sensitive to spatial structure include top predators and other large, area-sensitive species; late-successional ('climax') species, which tend to be poorer dispersers than early-successional ('weedy')

species; and species involved in obligate pollination or seed dispersal mutualisms, which disproportionately tend to be tropical and late-successional. Comparing this with the list of species most likely to have large influences on their ecosystems (5.2.2), we see considerable overlap, suggesting the scope for far-reaching consequences of altering the spatial structure of ecosystems.

The growing recognition by ecologists of the importance of spatial structure is being put into practice in attempts to conserve individual species. As conservationists attempt to design plans for large-bodied, fragmentation-sensitive species such as the northern spotted owl, the core principles are to make individual patches large enough for the rate of local extinction not to be too high, as well as close enough together (or connected by 'corridors' of habitat) for rates of dispersal and recolonization to be adequate (Doak 1989; Lamberson *et al.* 1992; but see Harrison *et al.* 1993).

However, one general problem with these strategies is that the responses of individual species to fragmentation are highly dependent on details of the species' demography and dispersal behaviour (Fahrig and Merriam 1994; Harrison 1994). We know too few of these idiosyncratic details, for any species, to predict with any confidence whether it can survive in a given fragmented landscape. Worse yet, a landscape that supports a viable metapopulation of one species may easily fail to do so for many others. Few principles exist yet to guide us in the conservation of entire fragmented ecosystems, except that, almost certainly, the less additional fragmentation we impose on them the better they will function at all levels of organization.

References

- Aizen, M.A.** and Feinsinger, P. 1994a. Forest fragmentation, pollination, and plant reproduction in a Chaco dry forest, Argentina. *Ecology* **75**: 330–351.
- Aizen, M.A.** and Feinsinger, P. 1994b. Habitat fragmentation, native insect pollinators, and feral honey bees in Argentine "Chaco Serrano". *Ecological Applications* **4**: 378–392.
- Andren, H.** and Angelstam, P. 1988. Elevated predation rates as a consequence of edge effects in habitat islands: experimental evidence. *Ecology* **69**: 544–547.
- Bawa, K.S.** 1990. Plant-pollinator interactions in tropical rainforests. *Annual Review of Ecology and Systematics* **21**: 399–422.
- Dirzo, R.** and Miranda, A. 1991. Altered patterns of herbivory and diversity in the forest understory: a case study of the possible consequences of contemporary deforestation. In: Price, P., Lewinsohn, T.M., Fernandes, G.W. and Benson, W.W. (eds), *Plant-animal Interactions: Evolutionary ecology in tropical and temperate regions*. 273–287. John Wiley, New York.
- Doak, D.** 1989. Spotted owls and old growth logging in the Pacific Northwest. *Conservation Biology* **3**: 389–396.

- Fahrig, L.** and Merriam, G. 1994. Conservation of fragmented populations. *Conservation Biology* **8**: 50–59.
- Gill, D.E.** 1978. The metapopulation ecology of the red-spotted newt, *Notophthalmus viridescens* (Rafinesque). *Ecological Monographs* **48**: 145–166.
- Groom, M.J.** and Schumaker, N. 1993. Evaluating landscape change: patterns of worldwide deforestation and local fragmentation. In: Kareiva, P., Kingsolver, J. and Huey, R.B. (eds), *Biotic Interactions and Global Change*. Sinauer Associates, Sunderland, Mass.
- Grosholz, E.D.** 1993. The influence of habitat heterogeneity on host–pathogen population dynamics. *Oecologia* **96**: 347–353.
- Hanski, I.** 1989. Habitat selection in a patchy environment: individual differences in common shrews. *Animal Behaviour* **38** (3): 414–422.
- Hanski, I.** 1991. Single-species metapopulation dynamics – concepts, models and observations. *Biological Journal of the Linnean Society* **42**: 17–38.
- Hanski, I.** and Gilpin, M. 1991. Metapopulation dynamics – brief history and conceptual domain. *Biological Journal of the Linnean Society* **42**: 3–16.
- Harrison, S.** 1994. Metapopulations and conservation. In: Edwards, P.J., Webb, N.R. and May, R.M. (eds), *Large-scale Ecology and Conservation Biology*. Oxford: Blackwells.
- Harrison, S., Doak, D.** and Stahl, A. 1993. Spatial models and spotted owls: exploring some biological issues behind recent events. *Conservation Biology* **7**: 950–953.
- Harrison, S., Murphy, D.D.** and Ehrlich, P.R. 1988. Distribution of the bay checkerspot butterfly, *Euphydryas Editha Bayensis*: evidence for a metapopulation model. *American Naturalist* **132**: 360–82.
- Hastings, A.** and Harrison, S. 1994. Metapopulation dynamics and genetics. In: Fautin, D.G. (ed.) *Annual Review of Ecology and Systematics* **25**: xi +686. Annual Reviews Inc.: Palo Alto, Calif.
- Jarosz, A.M.** and Burdon, J.J. 1991. Host–pathogen interactions in natural populations of *Linum Marginale* and *Melampsora lini*: II. Local and regional variation in patterns of resistance and racial structure. *Evolution* **45**: 1618–1627.
- Jennersten, O.** 1988. Pollination in *Dianthus deltooides* (Caryophyllaceae): effects of habitat fragmentation on visitation and seed set. *Conservation Biology* **4**: 359–366.
- Klein, B.C.** 1989. Effects of forest fragmentation on dung and carrion beetle communities in central Amazonia. *Ecology* **70**: 1715–1725.
- Kruess, A.** and Tschardt, T. 1994. Habitat fragmentation, species loss and biological control. *Science* **264**: 1581–1584.
- Laan, R.** and Verboom, B. 1990. Effect of pool size and isolation on amphibian communities. *Biological Conservation* **54**: 251–262.
- Lamberson, R.H., McKelvey, K., Noon, B.R.** and Voss, C. 1992. A dynamic analysis of northern spotted owl viability in a fragmented forest landscape. *Conservation Biology* **6**: 505–512.
- Lawton, J.H.** and Woodroffe, G.L. 1991. Habitat and the distribution of water voles: why are there gaps in a species' range? *Journal of Animal Ecology* **60**: 79–91.
- Leigh, E.G., Wright, S.J., Herre, E.A.** and Putz, F.E. 1993. The decline of tree diversity on newly isolated tropical islands: a test of a null hypothesis and some implications. *Evolutionary Ecology* **7**: 76–102.
- McCauley, D.E.** 1991. Genetic consequences of local population extinction and recolonization. *Trends in Ecology and Evolution* **6**: 5–8.
- Opdam, P.** 1990. Metapopulation theory and habitat fragmentation: a review of holarctic breeding bird studies. *Landscape Ecology* **5**: 93–106.
- Paton, P.W.C.** 1994. The effect of edge on avian nest predation: how strong is the evidence? *Conservation Biology* **8**: 17–26.
- Peltonen, A.** and Hanski, I. 1991. Patterns of island occupancy explained by colonization and extinction rates in shrews. *Ecology* **72**: 1698–1708.
- Rathcke, B.J.** and Jules, E.S. 1993. Habitat fragmentation and plant–pollinator interactions. *Current Science* **65**: 273–277.
- Roland, J.** 1993. Large-scale forest fragmentation increases the duration of tent caterpillar outbreak. *Oecologia* **93**: 25–30.
- Saunders, D.A., Hobbs, R.J.** and Margules, C.R. 1991. Biological consequences of ecosystem fragmentation. *Conservation Biology* **5**: 18–32.
- Schoener, T.W.** 1991. Extinction and the nature of the metapopulation: a case system. *Acta Oecologica* **12**: 53–75.
- Schoener, T.W.** and Spiller, D.A. 1987. High population persistence in a system with high turnover. *Nature* **330**: 474–477.
- Sinsch, U.** 1992. Structure and dynamics of a natterjack toad metapopulation (*Bufo calamita*). *Oecologia* **90**: 489–499.
- Sjogren, P.** 1991. Extinction and isolation gradients in metapopulations: the case of the pool frog (*Rana lessonae*). *Biological Journal of the Linnean Society* **42**: 135–147.
- Sjogren, P.** 1994. Distribution and extinction patterns within a northern metapopulation of the pool frog, *Rana lessonae*. *Ecology* **75**: 1357–1367.
- Small, M.F.** and Hunter, M.L. 1988. Forest fragmentation and avian nest predation in forested landscapes. *Oecologia* **90**: 489–499.
- Tilman, D., May, R.M., Lehman, C.L.** and Nowak, M.A. 1994. Habitat destruction and the extinction debt. *Nature* **367**: 363–365.
- Thomas, C.D.** and Harrison, S. 1992. Spatial dynamics of a patchily-distributed butterfly species. *Journal of Animal Ecology* **61**: 437–446.
- Thomas, C.D., Thomas, J.A.** and Warren, M.S. 1992. Distributions of occupied and vacant butterfly habitats in fragmented landscapes. *Oecologia* **92**: 563–567.
- Verboom, J.A., Opdam, P., Schotman, M.** and Metz, J.A.J. 1991. European nuthatch metapopulations in a fragmented agricultural landscape. *Oikos* **61**: 149–156.
- Wilcove, D.A.** 1985. Nest predation in forest tracts and the decline of migratory songbirds. *Ecology* **68**: 1211–1214.

5.2.4 Biodiversity at landscape to regional scales

5.2.4.1 Introduction

Most of the current emphasis on biodiversity has been focused on taxonomic or functional diversity. Even at the scale of ecosystems, the largest proportion of effort has

been focused on the relationship between species diversity and ecosystem functioning. While such work is of critical importance, it does not capture larger-scale patterns and processes, specifically those at the landscape to regional scale. At these large spatial scales, the appropriate biological unit that confers diversity is the ecosystem. Landscapes are composed of an assemblage of interacting ecosystems. A diverse landscape or region is one with many different ecosystems (richness component), or one in which the area occupied is similar for all ecosystems (evenness component). The key characteristic of a diverse landscape or region is that its constituent ecosystems perform different functions – physical, biological or human-related. Here, we do not address species or population diversity that occurs at large scales, nor heterogeneity induced at the scale of individuals (i.e. 'gap dynamics'), nor patchiness within an ecosystem. Rather, we focus our discussion at scales that are relevant to processes that occur at the landscape to regional scale: watershed dynamics, gaseous and energy exchange with the atmosphere, and socioeconomic and political dynamics.

These processes are responsible for the interactions between ecological units and global change, and we will refer to them as 'landscape or regional functions'.

Humans have demonstrated world-wide that alteration of the constituent ecosystems within landscapes and regions through land-use management can fundamentally alter local and global-scale hydrological cycles, atmospheric chemistry, terrestrial carbon storage, soil erosion rates, water quality and human welfare. A careful analysis of the role of biodiversity at large scales is therefore important for understanding and managing long-term global sustainability.

Our objective here is to explore the conditions under which biodiversity at landscape to regional scales is important for the large-scale system functions identified above. We will first set forth some ideas about a general relationship between biodiversity and landscape to regional function, providing examples from a diverse literature. Second, we will assess the types of landscapes or regions in which rare ecosystem types contribute largely to ecosystem functioning. Finally, we will assess the relationship of human land-use diversity to the functioning of both ecological and human systems.

5.2.4.2 Diversity and ecosystem functioning at landscape to regional scales

Conceptual framework: The extent to which biodiversity matters in a landscape or region is at least partly dependent upon the linkages among ecosystems. The currency of these linkages includes wind, water, trace gas exchange, plant and animal movements and human products and revenues. Certain ecosystems within a landscape or region may serve as sources of materials, energy or biota (Pulliam 1988), while others may serve as sinks. Risser (1987) and

Forman and Godron (1986) suggested that disturbances increase the rate of material flow among landscape units, but that fragmentation may also reduce flows and linkages.

The relationship between diversity and system functioning at large scales has strong analogies to generalizations made for the scale of species and functional-type diversity and ecosystem functioning by Sala *et al.* (1996). First, to understand the relationship between ecosystem diversity and landscape or regional function, one must understand the contribution of the various ecosystems to the specific function of interest, i.e. element export, gaseous flux, revenue, etc. Once this is understood, the relationship between diversity and function becomes clearer: deletion, disturbance or increases in the abundance of the ecosystem that contributes the most to the specific function will have the largest effect. In many cases the most abundant ecosystem will be the one that contributes the largest proportion to landscape or regional function. In some specific cases, there may be 'keystone' ecosystem types that are relatively rare within the landscape or region, but that provide a disproportionate contribution to function at that scale.

In many landscapes or regions, the presence of several ecosystem types that have high proportional land cover is most important in determining large-scale system functioning, for instance in susceptibility to disturbance. Human activity in such landscapes often preferentially reduces the abundance of one or more of these dominant ecosystem types, and thus may impact system functioning significantly. High-productivity ecosystems, such as the fertile tropical rain forests of the Amazon and the tallgrass prairie of North America are among the most likely to be cultivated or harvested. The impacts of reducing such dominant ecosystem types may be highly significant for landscape and regional function, resulting in large-scale habitat changes, alteration of storage or runoff of water, and associated consequences for sediment production, or altered carbon and nitrogen balance. In addition, in landscapes or regions that contain 'keystone' ecosystems, human interference with ecosystem functioning may have very dramatic influences, such as complete elimination of a crucial ecosystem function such as water storage.

Examples: Ecosystem diversity at landscape and regional scales is controlled by the interactions among large-scale patterns in climate and large and small scale heterogeneity in the physical environment. A diverse array of ecosystems within landscapes or regions may be important for providing both sources and sinks of propagules, fauna, sediments, water or nutrients. If the array contains an adequate balance of ecosystems that serve each of these functions, the function at the landscape or regional scale is likely to be able to persist in the face of disturbances. We will provide four examples, with particular attention to the

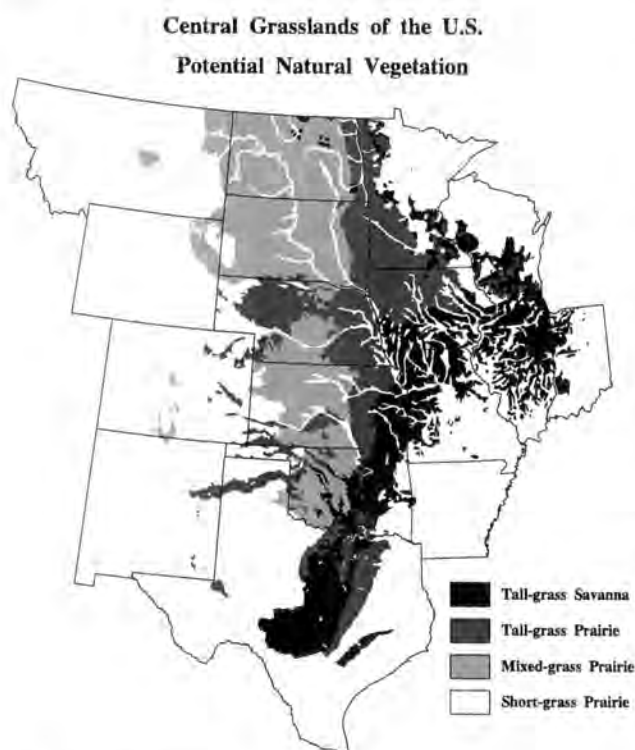

Figure 5.2-4: Potential natural vegetation of the central grasslands of the USA. Revised from Küchler 1964.

central grassland region of the USA, the system for which we have the most information and experience.

In central North America there is a strong west–east gradient in mean annual precipitation from the eastern foothills of the Rocky Mountains to the Mississippi River. Additionally, there is a nearly orthogonal north–south gradient in mean annual temperature. These gradients interact to provide regional-scale patterns in ecosystem types (Figure 5.2-4). These regional-scale patterns interact with small-scale patterns of topography and parent materials to produce an increasingly complex pattern of ecosystems as one scales down from the region to individual landscapes. At a mesoscale level (hundreds of km²), the Sand Hills of Nebraska provide a classic example of the effect of parent material on ecosystem development. Because of their effect of reducing evaporative losses and therefore increasing the effectiveness of precipitation (Noy-Meir 1973), these deep sandy soils (Figure 5.2-5) result in a westward extension of the tallgrass prairie into an area in which the typical vegetation is classified as northern mixed prairie (see Figure 5.2-4). Here, landscape-scale topographic gradients can result in gradients in ecosystem types over tens of metres.

This complex of scales of heterogeneity in both environments and ecosystems provides the grassland region with enormous response potential to certain large-scale disturbances such as climate change. This complex geographic mixing of ecosystem types changes the nature of the responses that will be necessary for the region to

adapt to new climatic changes. Instead of requiring regional-scale migration of species adapted to the new climate, response to climate change will in many cases only require local-scale dispersal. In addition, it is important to note that this regional distribution of soils and of ecosystem types has developed over many thousands of years: consideration of long time scales may be important for any assessment of the origin and maintenance of large-scale diversity.

A second example of the importance of landscape-scale heterogeneity occurs in systems that are subjected to large-scale fires. In coniferous subalpine forests, topographic variability results in a complex of ecosystem types, including forest successional stages, meadows and xeric vegetation (Romme and Knight 1981). This landscape-scale heterogeneity in ecosystem types, caused by physical patterns in drainage and nutrient availability, as well as by successional dynamics, results in natural fire-breaks which may reduce the likelihood of very large fires (Romme and Knight 1981; Romme 1982). Recent work in Yellowstone National Park in the USA has suggested that heterogeneous landscapes are more resistant to large fires than homogeneous landscapes, and that once burned, they have a greater ability to maintain water quality (Knight and Wallace 1989).

A third example is found in the interaction of migratory and other large fauna and the structure and function of landscapes and regions. A very large proportion of the world's fauna in subtropical to arctic regions depends upon multiple habitats which are used seasonally. Wild ungulate movements have been shown to influence significantly the patterns of net primary production, forage utilization and nutrient cycling (Ruess and Seagle 1994) at both landscape and regional scales. Coughenour (1991) suggested that for antelope (*Saiga tatarica*) in southern Asia, wildebeest in the Serengeti, and bison in North America, migration helps to conserve forage and protect landscapes from overgrazing. Interference in the ability of these ungulates to utilize a diversity of habitats through spatial constraints or habitat elimination has had very large impacts on ecosystem functioning, through local overabundance of herbivores or by removal of natural grazing (reviewed by Coughenour 1991). Maintenance of corridors for faunal migration may significantly enhance the ability of organisms to distribute their habitat use across broad regions (Forman 1987).

Landscape diversity and function may rely upon population dynamics of a single species. For example, beaver (*Castor canadensis*) in the boreal forest of North America have been shown to alter the distribution of hydrologic zones (forest, wet and dry meadows and ponds) (Naiman *et al.* 1994). The net effect of increasing beaver populations has been to convert forests into meadows and ponds, increasing the abundance and cover

of these ecosystems from minor constituents to the majority of land cover (Bridgham *et al.* 1995). The anaerobic conditions created by these ecosystems have altered regional biogeochemical processes, potentially doubling or tripling methane flux from the boreal forest (Bridgham *et al.* 1995), a significant constituent of the global flux. In addition, beaver activity influences the movement and accumulation of nutrients and water through alteration of drainage networks, an effect that may last for decades or even centuries (Naiman *et al.* 1994). In this example, a previously minor ecosystem type has increased in abundance and brought about change in a large-scale function.

Finally, landscapes in many areas of the world are subjected to anthropogenic inputs of sulphate and nitrate, causing net acidification. Within such landscapes, some of the ecosystems, such as coniferous forests, streams and oligotrophic lakes, have a very high sensitivity to such inputs. The presence of other ecosystems within these watersheds, capable of providing a sink for acidity or of providing a source of basic cations, has been demonstrated to be crucial for the continued functioning of these systems. This has been shown to be true particularly for streams and lakes in mountainous regions (Johnson *et al.* 1981; Charles 1991). Acidity that falls in mountainous regions is often not sufficiently filtered until it has passed through the soils of deciduous forests or subalpine bogs. Streams and lakes are dependent upon a relatively large areal extent of 'sink' systems in order to resist large-scale biological impacts resulting from net acidification.

5.2.4.3 Keystone ecosystems

There are several examples of ecosystems that contribute specialized functions to landscapes or regions despite being very small. The presence of such an ecosystem may add only a small increment to an index of 'diversity' based upon richness or evenness of ecosystem types, but may have a very significant influence on large-scale system functioning. Human interference with such 'keystone' ecosystems may occur at very small spatial scales, but may have dramatic effects at landscape to regional scale.

Riparian ecosystems, because of their physical and biological components, have a specialized function in landscapes and regions. They are well recognized for their abilities to filter sediments in overland flow, and to retain nutrients in overland flow and subsurface water movement (Gregory *et al.* 1991). For example, in an experimental watershed in Maryland, USA, croplands released considerable proportions of nitrogen and phosphorus received in a given year (92% and 59% of inputs, respectively), while riparian forests maintained most nutrient inputs (releasing 11% of nitrogen and 20% of phosphorus inputs) (Peterjohn and Correll 1984), including

Central Grasslands of the U.S. Soil Texture

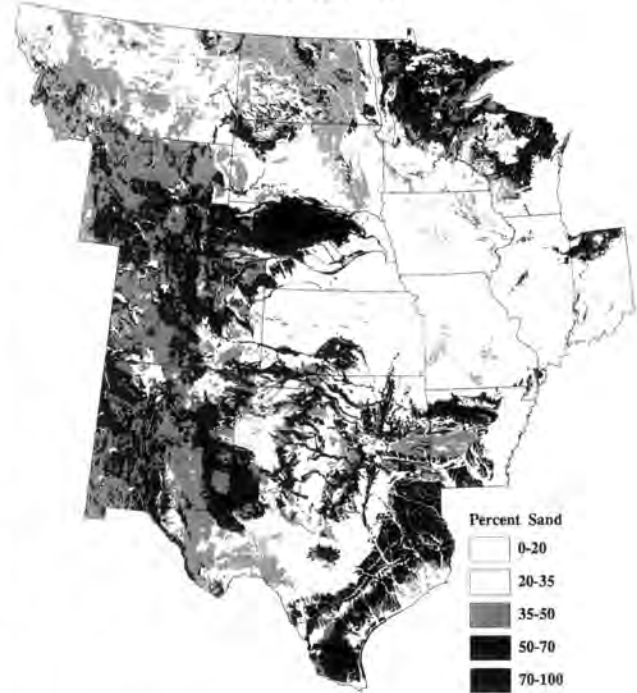

Figure 5.2-5: Sand content in the central grasslands of the USA. Data from USDA Soil Conservation Service 1989.

those received from adjacent croplands. When riparian biota are disturbed or destroyed, severe sedimentation and nutrient loading may occur. Riparian systems may be one of the best examples of 'keystone' elements in landscape diversity, because their influence is out of all proportion to their size.

Wetlands have long been recognized as providing a key role in absorption of phosphate and other materials that are harmful to aquatic systems (Verry and Timmons 1982; Urban *et al.* 1989). Anthropogenic sources of phosphate have major implications for the functioning of natural aquatic systems (e.g. Schindler 1974, and many others), causing algal blooms, increased consumer activities, oxygen deficits and large-scale fish kills. Although wetlands may provide a critical function in phosphate absorption, Richardson (1985) demonstrated that wetlands may saturate with phosphate under very high input more rapidly than ecosystems that have high levels of amorphous iron oxides in soils. These results suggest that a diverse array of surrounding terrestrial ecosystems may make critical contributions to the functioning of landscapes undergoing extreme stress.

Many other keystone ecosystems have been documented in the literature, for instance prairie potholes (Poiani and Johnson 1993) and tropical lagoons or mangroves (Morell and Corredor 1993). Clearly, identification of keystone ecosystems and their relationship to landscape or regional functioning should be a high priority.

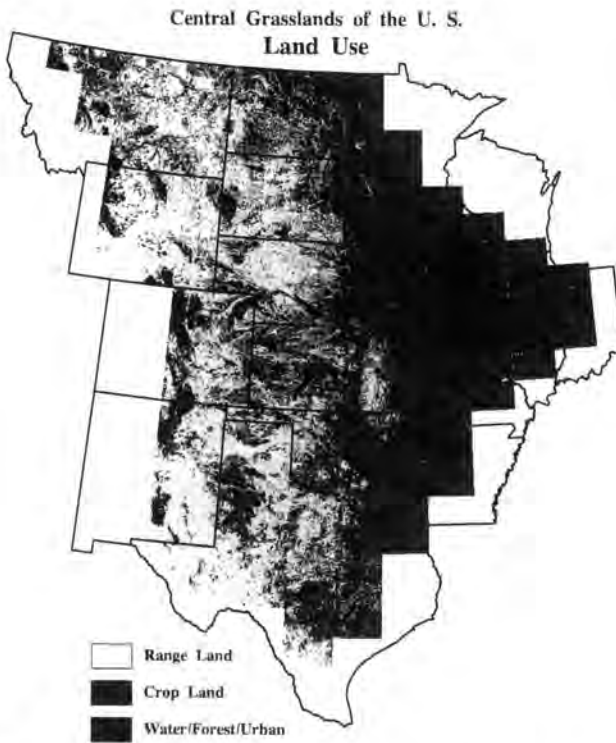

Figure 5.2-6: Land use in the central grasslands of the USA. Data from USDI US Geological Survey 1986.

5.2.4.4 Land-use diversity

One of the distinctive properties of landscapes or regions, as opposed to smaller units, is the extent to which humans must be considered a part of the system. Ecosystems are managed at spatial scales from landscapes to regions. Humans change the character of the ecosystems they manage by altering their properties with respect to exchange of nutrients, energy and sediments, and with respect to additional substances such as toxins or fertilizers. Inclusion of human processes as part of landscape and regional functioning is therefore necessary for any understanding of causes and effects at these scales (Naveh 1971). Furthermore, the structure of landscapes and regions has a large impact on patterns of human occupation, on land-use decisions, and on cultural and economic conditions. An integrated approach to human and ecological systems is the most appropriate approach to understanding landscape and regional functioning.

Probably the clearest examples of landscapes and regions that include a large diversity of ecosystem types are found in areas in which some of the natural ecosystems have been replaced with intensively managed ecosystems producing commodities such as timber or grain. This heterogeneity has tremendous consequences for landscape or regional-scale processes, including nutrient and sediment redistribution, and gaseous exchange with the atmosphere. Here, we will identify the causes of large-scale heterogeneity in land-use management practices, and discuss the significance of the

resulting heterogeneity for the functioning of landscapes and regions.

Heterogeneity in land-use is the result of interactions between climatic and edaphic constraints and human socioeconomic forces. Macroclimatic zones generally determine the range of land use management practices that are biologically and economically feasible in a region and therefore have a large influence on ecosystem diversity. For example, in the central grasslands of the USA (Figure 5.2-6), the distribution of cropland versus rangeland is generally controlled by precipitation, but patterns are modified locally by soil texture and depth, and by the availability of surface or ground water for use in irrigation. Qualitative evaluation of Figure 5.2-6 suggests an ecosystem analogue to the relationship that Whittaker and Niering (1975) reported for species diversity along a moisture gradient.

It appears that land-use diversity is low in the driest and wettest parts of the central grassland region. In the driest areas, along the eastern margin of the Rocky Mountains, landscapes are dominated by native grasslands because water availability limits crop production. In the wettest parts of the region, landscapes are dominated by cropland ecosystems because water availability is so favourable for crop production. The intermediate areas are mixtures of grassland and cropland ecosystems and have the highest landscape diversity. Social, cultural and economic conditions interact with environmental constraints to produce these observed patterns of land use (Riebsame *et al.* 1994).

In highly managed regions, human systems may be best maintained where land-use management practices have resulted in a pattern of ecosystem types that confers functional diversity for both ecological and economic systems. Cultivated ecosystems generally function as sources of sediments, as sources of trace gases such as ammonia, as areas that have net reductions in carbon storage, and as sources of cash revenue. To maintain regional functioning, we suggest that these systems must be balanced by ecosystems that can capture sediments, produce less (or even consume) trace gases, and serve as net carbon sinks. Naveh (1971) argued that human activity in Mediterranean ecosystems may be directed to the maintenance of a sufficient level of ecological diversity. We provide below two examples of systems that may be considered sufficiently diverse for ecosystem and human system functioning, and an example of one that may not.

The central grasslands of North America comprise a mosaic of land use, ranging from intensively cropped dryland systems to irrigated cropland and native grassland used for beef production. An index of land-use diversity for the region would probably be high, given the spatial complexity and the number of crop types distributed throughout the region. In terms of ecosystem functioning, the presence of native grasslands in this matrix, rather than

the diversity *per se*, may be extremely important. Cultivation results in significant regional losses of carbon through increasing decomposition and erosion which reduce the amount of organic matter in the soil (Burke *et al.* 1991). The presence of native grasslands is important for minimizing those carbon losses at a regional scale. The grasslands evolved in the presence of large generalist herbivores and appear to be well adapted to withstand domestic livestock grazing (Milchunas *et al.* 1988). In addition, cattle feedlot operations in the region produce large amounts of methane. While all soils in the region have net methane consumption, the grassland systems have significantly higher methane consumption than cultivated areas, and the presence of such sinks reduces the net regional methane contribution to the atmosphere (Mosier *et al.* 1991). In this case, diversity of land uses does not produce a 'better' balance of trace gas emissions (i.e. the lowest possible level of emissions), but, given that humans must use the area for grain production, the presence and distribution of the native grasslands is crucial for minimizing regional human impacts.

If we consider the dynamics of human populations, the presence and distribution of both grassland and cropland ecosystems may also be important for social and economic stability. Climatic variability in the region has produced large fluctuations in ecosystem production, economic welfare and land-use management (Albertson and Weaver 1944). For example, during the 1930s, a prolonged period of low precipitation resulted in failures of the winter wheat crop in the southwestern part of the region. Winter wheat requires sufficient soil water in the autumn to germinate and establish and enough water during the winter to promote tiller survival. Spring moisture is required for plant growth, flowering and grain production. By contrast, early and mid-summer soil water is necessary to promote forage production by the native grasslands. The probability of failures of both the winter wheat and forage crops in any given year is relatively low. Hence, the stability of human socioeconomic systems in the region is greater in the presence of both ranching and farming operations than it would be if only one land-use type were available.

Tropical deforestation in the Brazilian Amazon provides an example of the genesis of spatial patterns of ecosystems as a result of human use. In this case, a region dominated by a single ecosystem type (forest) is being made more diverse by adding a variety of crop and pasture ecosystem types. Skole and Tucker (1993) used satellite data to estimate that the area of the Amazon affected by deforestation increased from 78 000 km² in 1978 to 230 000 km² in 1988. This was accompanied by an increase in the total area of forest fragments (<100 km²) from 5115 km² to 16 228 km², suggesting that large blocks of forest are increasingly being broken up into smaller blocks. The 1990 IPCC estimate of net release of carbon to

the atmosphere as a result of tropical deforestation is 1.6 ± 1.0 Pg (Houghton *et al.* 1990). Initial studies of the effects of deforestation on other trace gases suggested that conversion to pasture was resulting in increases in N₂O-N of up to 1 Tg per year (Luizao *et al.* 1990). However, recent work has significantly altered our understanding by assessing the interactions of successional dynamics with trace gas fluxes. Keller *et al.* (1993) demonstrated that nitrogen oxide fluxes increase following conversion to pasture, but that these fluxes decrease to levels below those in forests after ten years. Similarly, they found that forest soils consume methane, and that recent, moist pastures are net producers of methane: however, these fluxes are reduced to predisturbance levels during secondary succession (Keller and Reiners 1994). Clearly, deforestation is altering regional and continental-scale processes: however, it is very important to note that the relationship of successional dynamics to these processes is complex and deserving of further study.

A final example of an intensively managed region is the Loess Plateau of China. Here, the spatial pattern of land-use management is apparently very diverse. There are large numbers of cultivated patches on valley bottoms, slopes (terraced or unterraced) and some remnant uplands, and grazing lands are located on the very steep dissected slopes. However, the ecological stability of the region is extremely low, due to the intensity with which each hectare of land is used. Many of the slopes are cultivated without building terraced fields, and the natural grasslands and shrublands on slopes have been so severely grazed that the vegetation is sparse and in many places the soils are bare. These land-use patterns combine with unfavourable natural conditions – namely loess consisting mainly of silt with porous structure and well-developed cleavages, and precipitation that is concentrated in the summer usually falling as high-intensity storms. Thus, the region is subjected to very high rates of erosion, and high rates of sediment loss. As a result, the Yellow River leaving the Loess Plateau carries an enormous sediment load (approximately 1.6×10^9 tonnes per year) (Integrated Scientific Research Team of the Loess Plateau of CAS, 1990), which makes it unsuitable for most natural biological activity and causes enormous deposition problems downstream. Human populations in the region are large, and expanding rapidly, which is placing increasingly heavy demands upon an already intensively utilized landscape. Inhabitants continue to cultivate more hillslopes and to graze the degraded grassland and shrubland ecosystems more intensively. Many of the flocks of sheep and goats are kept for personal status, not for food production, so over many areas the intensive grazing that is degrading the ecosystems adds relatively few commodities to the market-based economy of the region. In the Loess Plateau region, the fact that the landscape is diverse does

not alter the fact that almost the entire region serves as a net source of sediment.

5.2.4.5 Summary

Human use of ecosystems has sparked a world-wide concern for its effects on biodiversity. To a large extent the focus of concern has been on losses of species from ecosystems, and this in turn has raised the issue of the relationship between species diversity and ecosystem functioning. While this concern and effort is warranted and important, it does not deal fully with the issue of biodiversity. What is missing in this approach is the investigation of the diversity of ecosystems in landscapes and regions.

Diversity at the scale of landscapes and regions is related to hydrological balance, biotic interactions, trace gas fluxes and other large-scale processes, but the nature of the relationship appears to be landscape- or region-specific. Human activities have greatly altered broad-scale patterns of diversity, and a significant challenge remains regarding how to balance ecological functioning with human needs. Which ecosystems within landscapes play keystone roles? And how do we maintain natural processes, and hence diversity, while meeting the human demands of landscapes and regions?

References

- Albertson, F.A. and Weaver, J.E. 1944. Nature and degree of recovery from the Great Drought of 1933 to 1940. *Ecological Monographs* **14**: 394–479.
- Bridgham, C.A., Johnston, Pastor, J. and Updegraff, K. 1995. Potential feedbacks of northern wetlands on climate change. *BioScience* **45**: 262–274.
- Burke, I.C., Kittel, T.G.F., Lauenroth, W.K., Snook, P. and Yonker, C.M. 1991. Regional analysis of the central Great Plains: sensitivity to climate variability. *BioScience* **41**: 685–692.
- Charles, D.F. 1991. *Acidic Deposition in Aquatic Ecosystems: Regional case studies*. Springer-Verlag, New York.
- Coughenour, M.B. 1991. Spatial components of plant–herbivore interactions in pastoral, ranching, and native ungulate ecosystems. *Journal of Range Management* **44** (6): 530–542.
- DeAngelis, D.L. 1992. *Dynamics of Nutrient Cycling and Food Webs*. Chapman and Hall, New York.
- Forman, R.T.T. 1987. Ethics of isolation, spread of disturbance, and landscape ecology. In: Turner, M.G. (ed.), *Landscape Heterogeneity and Disturbance*. Ecological Studies **64**. 213–228. Springer-Verlag, New York..
- Forman, R.T.T. and Godron, M. 1986. *Landscape Ecology*. John Wiley, New York.
- Gregory, S.V., Swanson, F.J., McKee, W.A. and Cummins, K.W. 1991. An ecosystem perspective of riparian zones. *BioScience* **41**: 540–550.
- Houghton, J.T., Jenkins, G.J. and Ephraums, J.J. (ed.) 1990. *Climate Change: The IPCC scientific assessment*. Cambridge University Press, Cambridge.
- Integrated Scientific Research Team of Loess Plateau of CAS. 1990. *The characteristics of soil erosion of the loess plateau region of China and the way for its prevention and control*. The Chinese Science and Technology Publishing House.
- Johnson, N.M., Driscoll, C.T., Eaton, J.S., Likens, G.E. and McDowell, W.H. 1981. 'Acid rain', dissolved aluminum and chemical weathering at the Hubbard Brook Experimental Forest, New Hampshire. *Geochimica et Cosmochimica Acta* **45**: 1421–1437.
- Keller, M., Veldkamp, E., Weltz, A.M. and Reiners, W.A. 1993. Effect of pasture age on soil trace-gas emissions from a deforested area of Costa Rica. *Nature* **365**: 244–246.
- Keller, M. and Reiners, W.A. 1994. Soil–atmosphere exchange of nitrous oxide, nitric acid, and methane under secondary succession of pasture to forest in the Atlantic lowlands of Costa Rica. *Global Biogeochemical Cycles* **8**: 399–409.
- Knight, D.H., and Wallace, L.L. 1989. The Yellowstone fires: issues in landscape ecology. *BioScience* **39**: 700–706.
- Küchler, A.W. 1964. *Potential Natural Vegetation of the Coterminous United States*, Special Publication 36. American Geographical Society, New York.
- Luizao, F., Matson, P., Livingston, G., Luizao, R. and Vitousek, p. 1989. Nitrous oxide flux following tropical land clearing. *Global Biogeochemical Cycles* **3**: 281–285.
- Milchunas, D.G., Sala, O.E. and Lauenroth, W.K. 1988. A generalized model of the effects of grazing by large herbivores on grassland community structure. *American Naturalist* **132**: 87–106.
- Morrell, J.M. and Corredo, J.E. 1993. Sediment nitrogen trapping in a mangrove lagoon. *Estuarine, Coastal and Shelf Science* **37** (2): 203–212.
- Mosier, A.R., Schimel, D.S., Valentine, D., Bronson, K.F. and Parton, W.J. 1991. Methane and nitrous oxide fluxes in native, fertilized, and cultivated grasslands. *Nature* **350**: 330–332.
- Naiman, R. J., Pinay, G., Johnston, C. A., and Pastor, J. 1994. Beaver influences on the long-term biogeochemical characteristics of boreal forest drainage networks. *Ecology* **75**: 905–921.
- Naveh, Z. 1971. The conservation of ecological diversity of Mediterranean ecosystems through ecological management. In: Duffey, E. and Watt, A.S. (eds) *The Scientific Management of Animal and Plant Communities for Conservation*. 603–622. Blackwell Scientific Publications, Oxford.
- Noy-Meir, I. 1973. Desert ecosystems: environment and producers. *Annual Review of Ecology and Systematics* **4**: 23–51.
- Peterjohn, W.T. and Correll, D.L. 1984. Nutrient dynamics in an agricultural watershed: observations on the role of a riparian forest. *Ecology* **65**: 1466–1475.
- Poiani, K.A., and Johnson, W.C. 1993. A spatial simulation model of hydrology and vegetation dynamics in semi-permanent prairie wetlands. *Ecological Applications* **3**: 279–293.
- Pulliam, H.R. 1988. Sources, sinks, and population regulation. *American Naturalist* **132**: 652–661.
- Ruess, R.W. and Seagle, S.W. 1994. Landscape patterns in soil microbial processes in the Serengeti National Park, Tanzania. *Ecology* **75**: 892–904.

- Richardson, C.J.** 1985. Mechanisms controlling phosphorus retention capacity in freshwater wetlands. *Science* **228**: 1424–1427.
- Riebsame, W.E., Galvin, K.A., Young, R., Parton, W.J., Burke, I.C., Bohren, L. and Knop, E.** 1994. An integrated model of causes of and responses to environmental change: Land use/cover in the Central Great Plains. *BioScience* **44** (5): 350–356.
- Risser, P.G.** 1987. Landscape ecology: state of the art. In: Turner, M.G. (ed.), *Landscape Heterogeneity and Disturbance*. 3–14. Ecological Studies 64. Springer-Verlag, New York.
- Romme, W.H.** 1982. Fire and landscape diversity in subalpine forests of Yellowstone National Park. *Ecological Monographs* **52** (2): 199–221.
- Romme, W.H. and Knight, D.H.** 1981. Fire frequency and subalpine forest succession along a topographic gradient in Wyoming. *Ecology* **62**: 319–326.
- Sala, O.E., Lauenroth, W.K., McNaughton, S.J., Rusch, G. and Xinshi Zhang.** 1996. Biodiversity and ecosystem function in grasslands. In: Mooney, H.A. et al. (eds), *Functional Role of Biodiversity: A global perspective*. SCOPE (in press).
- Skole, D. and Tucker, C.** 1993. Tropical deforestation and habitat Amazon: Satellite data from 1978 to 1988. *Science* **260**: 1905–1910.
- Schindler, D.W.** 1974. Eutrophication and recovery in experimental lakes: implications for lake management. *Science* **184**: 897–899.
- USDA Soil Conservation Service.** 1989. STATSGO Soil Maps. National Cartographic Center, Fort Worth, Texas.
- USDI United States Geologic Survey.** 1986. *Land use and land cover digital data from 1:250,000 and 1:100,000 scale maps*. National Mapping Program Technical Instructions, Data Users Guide 4. Reston, Va.
- Urban, N.R., Eisenreich, S.J. and Grigal, D.F.** 1989. Sulfur cycling in a forested *Sphagnum* bog in northern Minnesota. *Biogeochemistry* **7**: 81–109.
- Verry, E.S. and Timmons, D.R.** 1982. Waterborne nutrient flow through an upland-peat watershed in Minnesota. *Ecology* **63**: 1456–1467.
- Whittaker, R.H. and Niering, W.A.** 1975. Vegetation of the Santa Catalina Mountains, Arizona. V. Biomass, production, and diversity along the elevation gradient. *Ecology* **56**: 771–790.

5.3 Drivers and dynamics of changes in biodiversity

5.3.1 Overview of disturbance

The relationship between biodiversity and disturbance has several important aspects. First, there can be both direct and indirect relationships between the two phenomena, although the indirect relationships are not yet well understood. Secondly, both biodiversity and disturbance are hierarchical concepts (Table 5.3-1), with different expressions at different levels of organization, such as organisms, populations, communities and ecosystems (Pickett *et al.* 1989). This indicates that the relationship between them may change as one focuses on different

levels of organization. Thus, events that disturb a community may not disturb a landscape. Thirdly, in order to understand the relationship between biodiversity and disturbance, several important clarifications about disturbance must be borne in mind. (1) Discussion of disturbance cannot be productive without an explicit, if perhaps tentative, model of the components, interactions and scale of the system of interest (Kolasa and Pickett 1989). Otherwise it will be impossible even to say what is or is not a disturbance or to disentangle the effects of disturbance and stress. (2) Assessment of disturbance requires a reference state (Rykiel 1985). Such reference states can be arbitrarily set, culturally determined, or derived from historical or palaeo-ecological records as long as the important past or external determinants of the system are known (Pickett *et al.* 1992) (3) Non-arbitrary reference states can be supplied by models of the system that specify the components and interactions of the system that are needed for that system to persist. Even in transient systems that are accidents of a certain time and place, such a model can be valuable in discerning disturbance and stress. Without substantial progress toward the rigour outlined above, the relationships between biodiversity and disturbance may be difficult to discover, let alone generalize or apply to management. Generalization must not, for example, mix different hierarchical levels of organization at which the expressions and mechanisms of interaction between biodiversity and disturbance are necessarily different.

Given the caveats above, disturbance is most generally defined as a physical disruption of the structure of a system. The system must be represented by an explicit model that specifies the components and the interactions within it. Placing the model in a hierarchical context indicates how particular disturbance events may or may not spread or affect other levels of organization or scale. The discussion that follows focuses on the ecological rather than the evolutionary impact of disturbance.

5.3.1.1 Characteristics of disturbance

It is important to specify the several dimensions characterizing disturbance (White 1979). The first characteristic is the identity of the event(s). What are the types of disturbance that act in a system? A caution to be applied here is that labelling events simply as fire or flood, for example, may not be adequate. Certain kinds of fire, or certain kinds of flood, may have both qualitatively and quantitatively different impacts on ecological systems at different levels of organization. The need for a model of the system must be re-emphasized here. It is simply impossible to say what is a disturbance without an explicit model of the system that specifies scale and organizational level.

Disturbance has intensity or severity (White and Pickett 1985). Although some might wish to characterize intensity

Table 5.3-1: Disturbance and biodiversity as expressed at different ecological levels of organization. Note that the scale at which an agent of disturbance acts may change the level of organization it impacts. Therefore the same agent may or may not act as a disturbance on different levels of organization.

Level	Illustrative element of biodiversity	Example of disturbance agent
Individual	Genotype	Predation
Population	Age structure	Disease
Community	Successional status	Lightning strike
Landscape	Patch type	Grazing exclusion
Biome	Ecoregion	Climate shift

by the amount of energy expended by the disturbance event, such a strategy will leave much of what is ecologically important about the disturbance hidden. It is not simply the force expended in blowing down a forest, for example, that is important in determining the response to that disturbance. It is also the nature of the substrate that results (White and Pickett 1985). How much of the soil is exhumed with the upturned roots of trees as opposed to merely being covered with debris resulting from the snapping of trees? In the case of fire, how patchy is the surface that is burned, and how much legacy remains from before the fire? And in another scenario, how many trees are defoliated by a herbivore at outbreak densities? Certainly, comparing vastly different intensities of disturbances as measured by energy expended by the event may lead to important generalizations about the nature of the template the disturbance leaves and the subsequent reorganization of the system, but at this stage in the development of disturbance theory, measuring intensity as energy expenditure alone seems inadequate. Joint characterization of disturbance events by energy expenditure *and* the nature of the habitat template they produce may be more promising (Barry and Dayton 1991).

Disturbances return to sites with some characteristic frequency (White and Pickett 1985). To speak figuratively, lightning does strike repeatedly at a site, and the ecological question is – how often? Stratifying the frequency by intensity is valuable additional information. Frequency can be specified in absolute terms or in terms relative to the temporal extent of the process or longevity of the system of interest. Typically, old-growth mesic, broad-leaved forests in many parts of the world experience treefalls at a given point once in 100 to 120 years (Hartshorn 1978; Reiners 1983). Boreal forests, having fire as the dominant disturbance, experience shorter return times (e.g. Heinselman 1973). Montane coniferous forests in wet environments generally turn over more slowly (Dale *et al.* 1986), although there is considerable variation based on site and community characteristics (Zackrisson 1977). Insect populations reach outbreak levels and disturb forest

canopies at intervals dependent on landscape and climate (Nothnagle and Schultz 1987).

The spatial scale and distribution of the disturbance is important as well (White and Pickett 1985). How large are the individual events relative to the size of the system? How are the events distributed in space? Are they near one another, or isolated? Answers to these questions about scale will help explain and predict the impact of disturbances on systems. For example, a chequerboard pattern of clearcuts intended to retain intact forest patches in a landscape is actually less likely to maintain old growth forest interiors in the Pacific Northwest than is contiguous cutting of an equivalent area (Franklin and Forman 1989).

Combining type, frequency and scale characterizes a disturbance regime (White and Pickett 1985). The term ‘regime’ could be replaced by pattern, as there is no necessity for constancy of pattern. Yet, different environments, landforms, human and natural landscapes, and regions can be characterized by the kind, recurrence and spatial pattern of disturbances within them. The term alerts ecologists to be prepared for regularities in patterns of disturbance that can evolutionarily select (Huston *et al.* 1988) or ecologically assort species (Noble and Slatyer 1980), in the same way that general patterns in climate may do. Indeed, natural disturbance regimes owe much of their regularity or repeatability to climatic patterns. Such a link points out the potential sensitivity of disturbance regimes to global climate change. Models that rely on the relative repeatability of disturbance regimes can successfully account for species distributions and behaviours (Waring and Schlesinger 1985; Horn *et al.* 1989). This is an important intersection between biodiversity and disturbance.

5.3.1.2 Relationship of disturbance to other ecological processes

In one system of characterizing disturbance, two additional factors are considered. Given the conceptual refinements above, these factors are more appropriately applied to stress, or to the inclusive concept of perturbation which includes both disturbance and stress.

One feature – the point of impact or point of pressure on a system – is a partial substitute for not having a specific model of the system, as discussed above. In both approaches, the idea is that different aspects of the natural world will be differentially sensitive to disturbance. Indeed, some will be immune to certain common events. This differential sensitivity must be known to study the relationship between biodiversity and disturbance.

The second feature that is more appropriate to the concept of stress or the inclusive concept of perturbation is duration. Disturbances are by definition discrete events (White and Pickett 1985). They may of course emerge from cumulative effects of stress, as when a grassland community is opened catastrophically by the aggregate effects of drought stress (e.g. Weaver and Albertson 1943). But the event of opening the canopy and root mat of the grassland community is discrete relative to the long persistence of such communities. It is important to recognize that the temporal patterns of disturbance as indicated by frequency, and the unusual juxtapositions of usual disturbance events in time, may result in ecological effects that are qualitatively or quantitatively different from the customary disturbance regime.

One of the emergent insights about disturbance is that it can operate in a similar way to predation as a disrupter of competitive exclusion and equilibrium species composition that would result from unchecked competition (Denslow 1985). This insight is encapsulated in the term 'non-equilibrium coexistence' (Connell and Keough 1985; Huston 1979) (see Chapter 4.5). Of course, coexistence determined by predation and by disturbance (acting with other factors) can establish an equilibrium composition. The term 'non-equilibrium' emphasizes the need to include other factors that can maintain communities in an equilibrium different from that achieved exclusively as a result of competition (Pickett 1980). The continued study of disturbance has confirmed this early insight (Loucks 1970).

5.3.1.3 Principles of disturbance

Most generalizations about disturbance currently stand as hypotheses, and focus on intermediacy of intensity, but more commonly, of frequency (Connell 1978; Lubchenco and Menge 1978; Huston 1979). The insight that diversity is expected to be maximized at intermediate frequencies or intensities of disturbance is called the 'intermediate disturbance hypothesis'. A majority of species could not survive very intense disturbances. Nor could most species persist in the highly competitive communities that arise when disturbance is infrequent or very mild (Horn 1974). Likewise, productivity can show the same pattern (Reiners 1983). These generalizations must be constrained by underlying fertility gradients (Tilman 1988; Grime and Hodgson 1992; Grace 1993), the life histories of the species

available, and the existence of competitive hierarchies (Connell and Keough 1985). In systems where competitive hierarchies exist, higher fertility is expected to increase the rate of exclusion of poorer competitors, and higher rates of disturbance are thus required to reduce competitive exclusion in such environments. Furthermore, life-history features of the species pool determine the mode and success of reinvasion or persistence in a site after disturbance.

Models of population extinction and recolonization in a patchy environment have shown the importance of effective recolonization rates of poorer competitors, spatial aggregation of superior competitors and alternative local equilibria, among other factors (Hanski 1995). Source-sink relationships in a metapopulation are key causes of species coexistence in patchy landscapes (Pulliam 1988; Opdam 1991).

The temporal and spatial patterns of disturbance, and the responses of communities and ecosystems to them at the landscape scale, can be summarized as patch dynamics. Disturbed patches can be treated as populations, with birth, growth, size and age distributions, and death of patches (Levin and Paine 1974; Whittaker and Levin 1977; Pickett and Thompson 1978; Levin 1986). On the ground, the pattern would appear as a shifting mosaic (Bormann and Likens 1979; Remmert 1991) which may, if the patches are not too large relative to the size of the entire landscape, come to a steady state. Some landscapes may not produce an equilibrium distribution of patches (e.g. Romme 1982). Such patterns of patches and their dynamics can represent important sources of biodiversity in landscapes (Pickett and Thompson 1978; Foster 1980; Gilbert 1980). In many landscapes, successional species (Pickett 1976), certain desirable wild flowers (Little 1977; Menges 1990) and keystone mutualists (Gilbert 1980), among others, may depend to some extent on new or recently disturbed patches. Likewise, some heath communities, or prairies and savannas in moist climates (Jordan 1993) require disturbance among their defining parameters.

The requirement of certain desirable or rare species, or of interesting community types for the existence of disturbance in the landscape, points out an important way in which disturbance is ecologically significant. At the community level, disturbances create opportunities for some species and at the same time can disadvantage other species. Because community disturbance alters resources and environmental signals and regulators, it shifts the community niche space, or environmental determinants, at least temporarily. At the least, disturbance may temporarily disadvantage competitively superior species, giving less competitive species a respite that permits them to persist in the community (Denslow 1980; Pickett 1980). If the occurrence of disturbance is regular enough, it can, as stated above, act as a selection pressure and drive the specialization of species on the conditions it creates. Thus

some degree of fugitivity exists in many plant species that are denizens of even closed communities (Harper 1977).

What creates opportunity for some species almost always creates a limitation for others (e.g. Connell 1978). Only in the most physically extreme environments where a very few species are able to surmount the problems of making a living will this generalization not be expected to hold. Thus limitation and opportunity are opposite sides of the same coin. The principle of allocation (Cody 1966), which states that

organisms must allocate their limited stores of assimilated energy among mutually exclusive structures or functions, explains the generality of this relationship. It is such a powerful principle that it provides the basic foundation of many ecological theories and models that are used to predict species distribution in time and space (e.g. Tilman 1988).

In relating disturbance to biodiversity at the community level, it is important to know what species in a community are favoured, and which ones are disfavoured, by

Box 5.3-1: Thresholds in ecosystems.

In many of the world's biomes, ecosystems can exist in two or more alternative states which may differ with respect to their species composition, ecosystem functioning or ability to provide some ecosystem service. Each state may appear stable because modest perturbations have small or short-lived effects. Large perturbations, however, may shift the ecosystem from one state to another. Such state shifts can have important policy implications if ecosystems are transformed from desirable to undesirable states. (Perceptions of desirability or undesirability are value judgements related to societal goals or expectations, which are also subject to change through time.) If the undesirable state is stable, substantial policy changes or enormous resource commitments may be needed to restore the ecosystem to the desirable state.

Examples of alternative states are known from both terrestrial and aquatic ecosystems. Semi-arid grassland can remain productive as long as grazer density is modest (Noy-Meir 1975). When grazer density rises above a threshold, community composition changes rapidly and the ecosystem shifts rapidly to a state of degradation and low productivity. Once this occurs, the range will remain unproductive unless managers reduce grazer density substantially while the ecosystem recovers to a productive state. Forests subject to outbreaks of grazing insects also exhibit alternative states, in which outbreaks are either suppressed or spread rapidly (Ludwig *et al.* 1978). In lakes, changes in nutrient inputs and fish stocks can shift the ecosystem between states of good or poor water quality (Scheffer 1991; Carpenter 1992; Scheffer *et al.* 1993). Alternative states that differ in productivity may also exist in marine ecosystems (Steele and Henderson 1984; 1992; Knowlton 1992).

When exploitation of living resources is modest, the resource exists in a high-productivity state and yield is high (Clark 1976; Walters 1986). When exploitation rate rises above a threshold, the ecosystem shifts to a state of low productivity and yield remains low. Large and sustained reductions in exploitation are necessary to return the ecosystem to the high-productivity state, and significant economic losses can occur during the collapse and recovery stages. Adaptive management techniques can be used to detect and avoid thresholds (Walters 1986) when the political and social circumstances are favourable (Lee 1993).

Thresholds in the relationship between biodiversity and ecosystem functioning are hypothetical but plausible (see graph below). When biodiversity is relatively high, the ecosystem follows the limb of the curve labelled 'high'. The ecosystem process rate, which corresponds to production or some other ecosystem service, is relatively high but declines smoothly as biodiversity declines. When biodiversity decreases to level A, the ecosystem process rate falls abruptly to the limb of the curve labeled 'low'. Along this lower limb of the curve, the ecosystem process rate remains relatively low but increases slightly as biodiversity rises. To return the ecosystem to the state with high process rates, it is necessary to increase biodiversity above level B. If species have been lost permanently, restoration may be impossible. Species conservation maintains restoration options.

A threshold hypothesis is consistent with much of the evidence about ecological consequences of species' extinction (Ehrlich and Ehrlich 1981). However, there is considerable scientific disagreement about the particular shapes of the curves and the locations of the thresholds (Schulze and Mooney 1993). There is also uncertainty about whether particular species are crucial in determining the location of thresholds (Schindler 1990; Frost *et al.* 1994). At present, scientific capacities to predict thresholds in ecosystem behaviour are poorly developed.

Thresholds have significant implications for resource economics, ecosystem restoration and sustainability of ecosystem services. When ecosystems are driven across thresholds to undesirable states, losses can be long-lasting or even permanent. Costs of ecological restoration in economic, energy or material terms can rise steeply if ecosystems must be forced across a threshold to restore them. In some cases, restoration may simply be impractical. Where biodiversity is reduced by global extinctions, opportunities for restoration may be permanently lost.

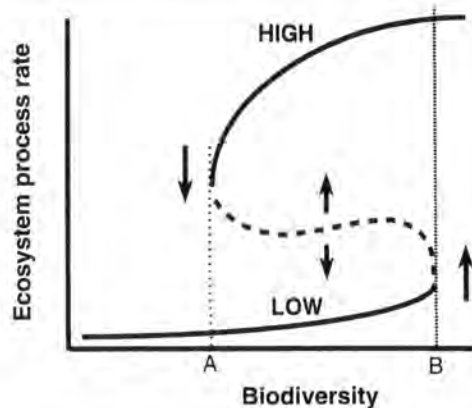

Hypothetical relationship between an Ecosystem Process Rate and Biodiversity. Solid lines are alternative stable states, or relationships to which the ecosystem will return after modest perturbation. The dashed curve is a breakpoint. If the system is perturbed across the breakpoint, it will move to the other state. Points A and B are biodiversity thresholds. If the biodiversity is reduced below A, the ecosystem will collapse from the high state to the low state. To restore the ecosystem to the high state, the biodiversity must be raised above threshold B.

disturbance (Bazzaz 1983). Managers have long recognized contrasting categories of plant species, such as increasers and decreaseers relative to grazing, and fire sensitive versus fire dependent species in certain forests, shrublands and grasslands. It would be inappropriate to argue that disturbance is good for all species in an assemblage. The insight that emerges from the last twenty years of new study, and synthesis of the insights of previous generations of ecologists, is that disturbance is 'good' for some species and ecological processes, not that it stimulates all natural or socially desirable species, ecological phenomena and systems. In other words, the role of disturbance is large in many systems, and biodiversity at various levels bears the stamp of disturbance. Successful management, restoration, conservation and sustainable development require that the role of disturbance in the target system and for critical processes, or for threatened and endangered species, be evaluated (Pickett *et al.* 1992). As a further elaboration of the analysis of the nature of disturbance, Carpenter (Box 5.3-1) discusses the importance of thresholds in perturbations to biodiversity as related to ecosystem processes.

5.3.1.4 Disturbance and management

Disturbance of ecosystems has implications for the maintenance and restoration of biodiversity at all hierarchical levels (McNaughton 1989; Walker 1989; Pickett and Parker 1994). The important role of both human agents (Mooney and Godron 1983; Naveh and Lieberman 1984) and natural agents of disturbance in a landscape is recognized here. Management involves the manipulation of existing systems, the restoration of a lost state (Hughes 1994), or the amelioration of an existing state of a system, while development, in the most positive sense, is the interpolation of anthropogenic and natural

systems. Every decision a manager makes (or neglects!) favours some species or ecological phenomena and disfavours others. This is the inexorable operation of the principle of allocation, and its resultant contrasts in the genetically determined strategies of organisms in the world as people now interact with it. No management (to use that word now to represent also restoration and sustainable development) can favour all species or states simultaneously. It is critical that management avoid damage to native and specialist species and their evolutionary potential. Management likewise must not neglect important processes and phenomena in landscapes, which is the *de facto* scale at which humans manage. In addition to understanding the biogeographic and evolutionary characteristics of the biota, successful management requires an understanding of the role of the disturbance regime in assembling the communities and ecosystems, and in driving ecosystem processes on which biodiversity depends. Management may sometimes have to maintain existing natural disturbance types, compensate for unavoidable natural disturbances, replace missing natural or pre-industrial human disturbances, or compensate for novel human stresses or reduced spatial extent of the system (Botkin 1991; Pickett *et al.* 1992). This list suggests that attention to the different kinds of disturbances, and the interactions among different anthropogenic and natural disturbances and stresses, is fundamental to successful and sustainable management, which must seek to maintain or recreate the multiplicity of opportunity that exists in the 'patch dynamic' natural world. The maintenance and importance of biodiversity are intertwined with these processes, and in order to use disturbance effectively, managers must know whether anthropogenic disturbances or stresses mimic the natural

ones that were important in the evolution or assembly of an ecological system.

Our understanding and use of the relationship between disturbance and biodiversity, rest on several key principles. Disturbance is the disruption of the structure of some specified ecological system. The most desirable way to specify the system is to provide a model that incorporates the system components, the connections among the components, and the scale of the system. Natural disturbance is an important and persistent component of the environments under which biodiversity evolved at the population and species levels and has been assembled at the community, ecosystem and landscape levels. Of course, the events that act as disturbance at each of these levels of organization differ in kind, frequency and scale. At some scales, apparently disruptive events become incorporated into the systems of interest, and the disturbance regime becomes a defining component of the larger system. In such situations disturbance must be maintained. Alternatively, if human management has prevented natural disturbance events, those events must be restored or substituted to permit the system to continue to exist. Thus, disturbance is a component of sustainability in some ecological systems and landscapes, but the type, intensity, frequency and scale must be properly applied if it is to remain a positive force in sustaining biodiversity.

References

- Barry**, J.P. and Dayton, P.K. 1991. Physical heterogeneity and the organization of marine communities. In: Kolasa, J. and Pickett, S.T.A. (eds), *Ecological Heterogeneity*. 270–320. Springer-Verlag, New York.
- Bazzaz**, F.A. 1983. Characteristics of populations in relation to disturbance in natural and man-modified ecosystems. In: Mooney, H.A. and Godron, M. (eds), *Disturbance and Ecosystems: Components of responses*. 259–275. Springer-Verlag, New York.
- Bormann**, F.H. and Likens, G.E. 1979. Catastrophic disturbance and the steady-state in northern hardwood forests. *American Scientist* **67**: 660–669.
- Botkin**, D.B. 1991. *Discordant Harmonies: A new ecology for the twenty-first century*. New York: Oxford University Press.
- Carpenter**, S.R. 1992. Destabilization of planktonic ecosystems and blooms of blue-green algae. in: Kitchell J.F. (ed.), *Food Web Management: A case study of Lake Mendota*. 461–482. Springer-Verlag, New York.
- Clark**, C.W. 1976. *Mathematical Bioeconomics*. John Wiley, NY.
- Cody**, M.L. 1966. A general theory of clutch size. *Evolution* **20**: 174–184.
- Connell**, J.H. 1978. Diversity in tropical rain forests and coral reefs. *Science* **199**: 1302–1310.
- Connell**, J.H. and Keough, M.J. 1985. Disturbance and patch dynamics of subtidal marine animals on hard substrata. In: Pickett, S.T.A. and White, P.S. (eds), *The Ecology of Natural Disturbance and Patch Dynamics*. 125–151. Academic Press, Orlando, Fla.
- Dale**, V.H., Hemstrom, M. and Franklin, J. 1986. Modeling long-term effects of disturbances on forest succession, Olympic Peninsula, Washington. *Canadian Journal of Forest Research* **16**: 56–67.
- Denslow**, J.S. 1980. Patterns of plant species diversity during succession under different disturbance regimes. *Oecologia* **46**: 18–21.
- Denslow**, J.S. 1985. Disturbance-mediated coexistence of species. In: Pickett, S.T.A. and White, P.S. (eds), *The Ecology of Natural Disturbance and Patch Dynamics*. 307–324. Academic Press, Orlando, Fla.
- Ehrlich**, P.R. and Ehrlich, A.H. 1981. *Extinction: The causes and consequences of the disappearance of Species*. Random House, New York.
- Foster**, R.B. 1980. Heterogeneity and disturbance in tropical vegetation. In: Soulé, M.-E. and Wilcox, B.A. (eds), *Conservation Biology: An evolutionary-ecological perspective*. 75–92. Sinauer Associates, Sunderland, Mass.
- Frost**, T.M., Carpenter, S.R., Ives A.R. and T.K. Kratz. 1994. Species compensation and complementarity in ecosystem function. In Jones C. and Lawton J. (eds), *Linking Species and Ecosystems*. Chapman and Hall, New York.
- Franklin**, J.F., and Forman, R.T.T. 1989. Creating patterns by cutting: ecological consequences and principles. *Landscape Ecology* **1**: 5–18.
- Gilbert**, L.E. 1980. Food web organization and the conservation of neotropical diversity. In: Soulé, M.E. and Wilcox, B.A. (eds), *Conservation Biology: An evolutionary-ecological perspective*. 11–33. Sinauer Associates, Sunderland, Mass.
- Grace**, J.B. 1993. The effects of habitat productivity on competition intensity. *Trends in Ecology and Evolution* **8**: 229–30.
- Grime**, J.P. and Hodgson, J.G. 1992. Botanical contributions to contemporary ecological theory. *New Phytologist* **106**: 283–295.
- Hanski**, I. 1995. Effects of landscape pattern on competitive interactions. In: Hansson, L., Fahrig, L. and Merriam, G. (eds), *Mosaic Landscapes and Ecological Processes*. 203–224. Chapman and Hall, New York.
- Harper**, J.L. 1977. *The Population Biology of Plants*, 1st edn. Academic Press, New York.
- Hartshorn**, G.S. 1978. Tree falls and tropical forest dynamics. In: Tomlinson, P.B. and Zimmerman, M.H. (eds), *Tropical Trees as Living Systems*. 617–638. Cambridge University Press, New York.
- Heinselman**, M.L. 1973. Fire in the virgin forests of the Boundary Waters Canoe Area, Minnesota. *Journal of Quaternary Research* **3**: 329–382.
- Horn**, H.S. 1974. The ecology of secondary succession. *Annual Review of Ecology and Systematics* **5**: 25–37.
- Horn**, H.S., Shugart, H.H. and Urban, D.L. 1989. Simulators of forest dynamics. In: Roughgarden, J., May, R.M. and Levin, S.A. (eds), *Perspectives in Ecological Theory*. 256–267. Princeton University Press, Princeton, NJ.
- Hughes**, T.P. 1994. Catastrophic phase shifts, and large-scale degradation of a Caribbean coral reef. *Science* **256**: 1547–51.
- Huston**, M. 1979. A general hypothesis of species diversity. *American Naturalist* **113**: 81–101.

- Huston, M., DeAngelis, D. and Post, W.** 1988. New computer models unify ecological theory. *BioScience* **38**: 682–691.
- Jordan, W.R., III.** 1993. Restoration as a technique for identifying and characterizing human influences on ecosystems. In: McDonnell, M. J. and Pickett, S.T.A. (eds), *Humans as Components of Ecosystems: The ecology of subtle human effects and populated areas*. 271–279. Springer-Verlag, New York.
- Knowlton, N.** 1992. Threshold and multiple stable states in coral reef community dynamics. *American Zoologist* **32**: 674–682.
- Kolasa, J. and Pickett, S.T.A.** 1989. Ecological systems and the concept of organization. *Proceedings of the National Academy of Sciences, USA* **86**: 8837–8841.
- Lee, K.** 1993. *Compass and Gyroscope*. Island Press, Washington, DC.
- Levin, S.A.** 1986. Population models and community structure in heterogenous environments. In: Hallam, T.G. and Levin, S.A. (eds), *Mathematical Ecology*. 295–320. Springer-Verlag, New York.
- Levin, S.A., and Paine, R.T.** 1974. Disturbance, patch formation, and community structure. *Proceedings of the National Academy of Sciences, USA* **71**: 2744–2747.
- Little, S.** 1977. Wildflowers of the pine barrens and their niche requirements. *New Jersey Outdoors* **1**: 16–18.
- Loucks, O.L.** 1970. Evolution of diversity, efficiency, and community stability. *American Zoologist* **10**: 17–25.
- Lubchenco, J. and Menge, B.A.** 1978. Community organization and persistence in a low rocky intertidal zone. *Ecological Monographs* **59**: 67–94.
- Ludwig, D., Jones, D.D. and Holling, C.S.** 1978. Qualitative analysis of insect outbreak systems: the spruce budworm and forest. *Journal of Animal Ecology* **47**: 315–332.
- McNaughton, S.J.** 1989. Ecosystems and conservation in the twenty-first century. In: Western, D. and Pearl, M.C. (eds), *Conservation for the Twenty-first Century*. 109–120. Oxford University Press, New York.
- Menges, E.S.** 1990. Population viability analysis for an endangered plant. *Conservation Biology* **4**: 52–62.
- Mooney, H.A. and Godron, M.** (eds.) 1983. *Disturbance and Ecosystems: Components of response*. Springer-Verlag, New York.
- Naveh, Z. and Lieberman, A.S.** 1984. *Landscape Ecology: Theory and application*. Springer-Verlag, New York.
- Noble, I.R., and Slatyer, R.O.** 1980. The use of vital attributes to predict successional changes in plant communities subject to recurrent disturbances. *Vegetatio* **43**: 5–21.
- Nothnagle, P.J. and Schultz, J.C.** 1987. What is a forest pest? In: Barbosa, P. and Schultz, J.C. (eds), *Insect Outbreaks*. 59–80. New York: Academic Press.
- Noy-Meir, I.** 1975. Stability of grazing systems: an application of predator–prey graphs. *Journal of Ecology*. **63**: 459–481.
- Opdam, P.** 1991. Metapopulation theory and habitat fragmentation: a review of Holarctic breeding bird studies. *Landscape Ecology* **5**: 93–106.
- Pickett, S.T.A.** 1976. Succession: an evolutionary interpretation. *American Naturalist* **110**: 107–119.
- Pickett, S.T.A.** 1980. Non-equilibrium coexistence of plants. *Bulletin of the Torrey Botanical Club* **107**: 238–248.
- Pickett, S.T.A. and Parker, V.T.** 1994. Avoiding the old pitfalls: opportunities in a new discipline. *Restoration Ecology* **2**: 75–79.
- Pickett, S.T.A. and Thompson, J.N.** 1978. Patch dynamics and the design of nature reserves. *Biological Conservation* **13**: 27–37.
- Pickett, S.T.A., Kolasa, J., Armesto, J.J. and Collins, S.L.** 1989. The ecological concept of disturbance and its expression at various hierarchical levels. *Oikos* **54**: 129–136.
- Pickett, S.T.A., Parker, V.T. and Fiedler, P.** 1992. The new paradigm in ecology: Implications for conservation biology above the species level. In: Fiedler, P. and Jain, S. (eds) *Conservation Biology: The theory and practice of nature conservation, preservation, and management*. 65–88. Chapman and Hall, New York.
- Pulliam, H.R.** 1988. Sources, sinks, and population regulation. *American Naturalist* **132**: 652–61
- Reiners, W.A.** 1983. Disturbance and basic properties of ecosystem energetics. In: Mooney, H.A. and Godron, M. (eds) *Disturbance and Ecosystems: Components of response*. 83–98. Springer-Verlag, New York.
- Remmert, H., (ed.)** 1991. *The Mosaic-cycle Concept of Ecosystems*. New York: Springer-Verlag.
- Romme, W.H.** 1982. Fire and landscape diversity in subalpine forests of Yellowstone National Park. *Ecological Monographs* **52**: 199–221.
- Rykiel, E.J.** 1985. Towards a definition of ecological disturbance. *Australian Journal of Ecology* **10**: 361–365.
- Scheffer, M.** 1991. Fish and nutrients interplay determines algal biomass: a minimal model. *Oikos* **62**: 271–282.
- Scheffer, M., Hosper, S.H., Meijer, M.-L., Moss, B. and Jeppesen, E.** 1993. Alternative equilibria in shallow lakes. *Trends in Ecology and Evolution* **8**: 275–279.
- Schindler, D.W.** 1990. Experimental perturbations of whole lakes as tests of hypotheses concerning ecosystem structure and function. *Oikos* **57**: 25–41.
- Schulze, E.-D. and Mooney H.A.** (eds.) 1993. *Biodiversity and Ecosystem Function*. Springer-Verlag, Berlin.
- Steele, J.H. and Henderson, E.W.** 1984. Modeling long-term fluctuations in fish stocks. *Science* **224**: 985–987.
- Steele, J.H. and Henderson, E.W.** 1992. The role of predation in plankton models. *Journal of Plankton Research* **14**: 157–172.
- Tilman, D.** 1988. *Plant Strategies and the Dynamics and Structure of Plant Communities*. Princeton University Press, Princeton, NJ.
- Walker, B.** 1989. Diversity and stability in ecosystem conservation. In: Western, D. and Pearl, M.C. (eds), *Conservation for the Twenty-first Century*. 121–130. Oxford University Press, New York.
- Walters, C.J.** 1986. *Adaptive Management of Renewable Resources*. Macmillan, New York.
- Waring, R.H., and Schlesinger, W.H.** 1985. *Forest Ecosystems: Concepts and management*. Academic Press, Orlando, Fla.
- Weaver, J.E., and Albertson, F.W.** 1943. Resurvey of grasses, forbs, and underground plant parts at the end of the great drought. *Ecological Monographs* **13**: 63–117.
- White, P.S.** 1979. Pattern, process, and natural disturbance in vegetation. *Botanical Review* **45**: 229–299.
- White, P.S. and Pickett, S.T.A.** 1985. Natural disturbance and patch dynamics: an introduction. In: Pickett, S.T.A. and

White, P.S. (eds), *The Ecology of Natural Disturbance and Patch Dynamics*. 3–13, Academic Press, Orlando, Fla.

Whittaker, R.H. and Levin, S.A. 1977. The role of mosaic phenomena in natural communities. *Theoretical Population Biology* **12**: 117–139.

Zackrisson, O. 1977. Influence of forest fire on the north Swedish boreal forest. *Oikos* **29**: 22–32

5.3.2 Human-induced perturbations biodiversity

5.3.2.1 Introduction

Human perturbations affect biodiversity both directly and indirectly through changes in land and water use (Figure 5.3-1). Such changes have a direct impact through habitat destruction and over exploitation of resources such as occurs in overfishing and overgrazing, and an indirect impact through their effects on the composition of the atmosphere and the climate, both of which directly affect biodiversity. Changes in biodiversity in turn modify the functioning of populations, ecosystems and landscapes. Finally, these changes feed back into land-use patterns, atmospheric composition and climate, accelerating or decelerating the rate of global change and the impacts of human activities. Here we focus on the effects of land use, atmospheric composition, and climate on the different components of biodiversity whereas most of Sections 5 and 6 of the GBA analyse the effects of changes in biodiversity on ecosystem functioning.

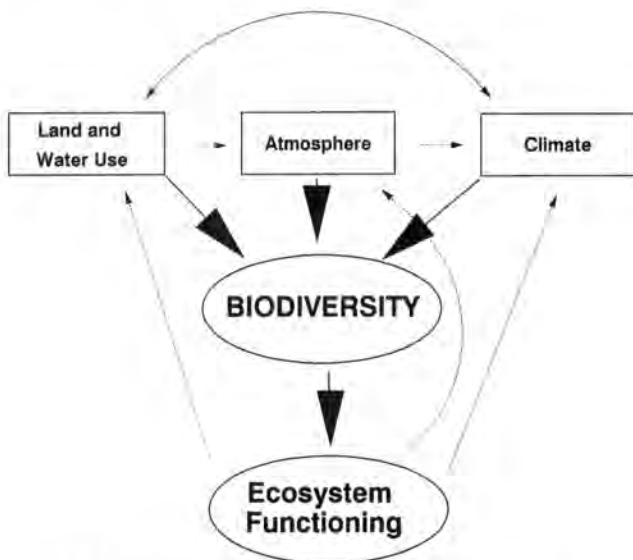

Figure 5.3-1: Conceptual model of the effects of human-induced perturbations on biodiversity and ecosystem functioning. Changes in land and water use directly affect biodiversity and simultaneously modify the composition of the atmosphere and the climate. The alterations of land and water use include the overexploitation of resources such as in overfishing or overgrazing as well as drastic transformations such as the conversion of forests into croplands. Changes in climate and in the composition of the atmosphere also directly alter biodiversity.

5.3.2.2 Changes in land and water use

Forests, grasslands, savannahs, and deserts have been altered drastically by human activity. Over the last three centuries, forests have decreased by 1.2 billion ha or 19%, and grasslands by 560 million ha or 8% (Richards 1993). This is mainly the result of increase in croplands of 1.2 billion hectares and the growth of urban areas. The rate of land-use change is accelerating very rapidly, as is demonstrated by agricultural expansion which was greater during the period 1950–80 than during the entire 150-year period between 1700 and 1850 (Richards 1993). Land-use change also includes changes associated with the over exploitation of resources which are ubiquitous and more difficult to quantify. For example, livestock overstocking has resulted in severe degradation of rangelands (referred to as desertification), bush encroachment or brush invasion altering large areas of North America, Africa and Australia (Buffington and Herbel 1965; Walker *et al.* 1981; van Vegten 1983; Archer 1989).

Marine environments have been and still are being drastically modified by human action. Changes in water use are usually not reflected in qualitative shifts like those we observe in terrestrial environments but in steady and quantitative changes of their chemical, physical and biological properties. Anthropogenic additions of nutrients are most obvious in relatively shallow coastal seas such as the Baltic or the North Sea in Europe, or Puget Sound along the open coast of the state of Washington in North America (Jickells *et al.* 1993). As a result of the discharge of wastes from heavily populated and industrialized areas, the nutrient content of the oceans has increased significantly. For example, phosphate concentration in the Baltic increased by a factor of 3 in the period 1958–80 (Jickells *et al.* 1993). Increases in nutrient availability stimulate the growth of plankton which in turn consumes dissolved oxygen as it decomposes (Lancelot *et al.* 1987). Simultaneously with the increase in nutrient availability, dissolved oxygen in the deep waters of some parts of the Baltic Sea decreased from 3 ml/l at the beginning of the century to almost zero at present (Jickells *et al.* 1993). Besides pollution, humans also drastically alter marine environments by over-exploiting resources. Overfishing has resulted in the elimination of substocks of herring, cod, ocean perch and salmon in several regions of the world (Ludwig *et al.* 1993).

Changes in land use are the major causes of habitat destruction and fragmentation, and these in turn are the major causes of recent extinctions, and constitute a major threat to biological diversity (WCMC 1992; Skole and Tucker 1993). A clear indication of the importance of habitat destruction in accounting for changes in biological diversity is that one way of estimating current and predicted losses of species diversity is based solely on combining information on current and projected

deforestation rates with information on species richness per unit area in tropical forests (Ehrlich and Wilson 1991; see also Section 4.4). The assumption that global terrestrial species extinction rates can be assessed from tropical forest extinction rates is justified on the assumption that most terrestrial species occur in tropical moist forests. Independent exercises using different approaches have estimated extinction rates to be of the same order of magnitude as those estimates based on species–area relations and the rate of habitat loss (Smith *et al.* 1993; Heywood *et al.* 1994).

Although drastic changes in land use such as large-scale transformations of forests into grasslands or grasslands into croplands usually result in reductions in global species diversity, more subtle human-induced changes sometimes increase local species diversity. For example, some grasslands that evolved under low grazing pressure have shown increases in species diversity as a result of the introduction of livestock and the consequent increase in grazing intensity (Sala *et al.* 1986; Milchunas *et al.* 1988). This pattern is accounted for mainly by the introduction of alien species better adapted to grazing conditions, without the disappearance of native grasses. Further increases in grazing intensity have reduced diversity as introduced grazing-tolerant species have become dominant. Human activity is mostly neutral or negative with respect to genetic or species diversity. Only recently – by means of biotechnology – have humans increased diversity. However, at the community and landscape levels human activity may either increase or decrease diversity. Naveh (1971) suggested that human-induced livestock grazing has increased plant, community and landscape level diversity in the Mediterranean Basin.

5.3.2.3 Changes in atmospheric composition

Recent changes in the composition of the atmosphere are a clear indication of the major disruption of biogeochemical cycles that have occurred as a result of human activities (Schlesinger 1991). First, scientists pointed out the perturbations of the carbon cycle and the resulting sharp increase in the concentration of carbon dioxide in the atmosphere (Keeling 1986). Next in importance is the disruption of the nitrogen cycle as evidenced by the magnitude of human-induced nitrogen fixation, the increase in nitrous oxide emissions, and the high values of nitrogen deposition over most of the developed world (Matson and Vitousek 1990; Vitousek 1994). These alterations of biogeochemical cycles have always resulted in ecosystem enrichment and, in most ecosystems, nutrient enrichment results in a sharp reduction in species diversity. Experimental fertilization of shortgrass steppe, tallgrass prairie, tundra and deciduous forest has always resulted in decreases in plant species richness (Lauenroth *et al.* 1978; Schulze 1989; Tilman 1993).

The increase in atmospheric CO₂, and the corresponding CO₂ fertilization effect, results in an ecosystem carbon enrichment which is modulated by nutrient and water availability (Mooney *et al.* 1991). Carbon enrichment can be expected to have effects on biodiversity similar to those that have been demonstrated for the enrichment of ecosystems with nutrients. Because our ability to perform CO₂ enhancement experiments in whole ecosystems is relatively recent, there is no experimental evidence to assess the effect of CO₂ fertilization on biodiversity. Experiments under controlled environmental conditions support the hypothesis that CO₂ enhancement changes plant–plant interactions, and alters the competitive balance among species, which might lead to a decrease in plant species diversity. Elevated CO₂ field experiments based on open-topped chambers showed a distinction between the response of C3 and C4 species in a salt-marsh (Curtis *et al.* 1989). Morse and Bazzaz (1994) also exposed two species with different photosynthetic pathways to elevated CO₂ concentrations and found that the C3 species (*Abutilon theophrasti*) showed a larger response than the C4 species (*Amaranthus retroflexus*). Based upon experiments under controlled environmental conditions, Polley *et al.* (1994) suggested that the invasion of the C4 grasslands in the southwestern United States by woody C3 mesquite (*Prosopis glandulosa*) during the past 150 years can be related to the observed 27% rise in atmospheric CO₂. Species-specific differences among CO₂ responses of forest trees have been reported for temperate zones (Williams *et al.* 1986; Norby *et al.* 1992) although not for tropical ecosystems (Körner and Amone 1992). Phillips and Gentry (1994) speculated that increased CO₂ may favour vine growth in tropical forests, which may explain the observed increase in tree mortality.

5.3.2.4 Climate change

The indirect effects of changes in the composition of the atmosphere and changes in land-use patterns occur via changes in climate. Changes in land-use and atmospheric composition have already been detected and will affect ecosystems and humans sooner than changes in climate. However, climate change has been the first global change phenomenon to attract the attention of scientists and policy-makers. Scientists agree that an increase in the atmospheric concentration of greenhouse gases such as CO₂ and methane will result in an increase in global temperature and a change in the global distribution of precipitation. Current uncertainties are related to the geographical patterns of those changes and the speed with which they will occur (Mitchell *et al.* 1990). Predicted changes in climate for a doubling of atmospheric CO₂ are quite significant for most regions in the world. Models that relate average climatic variables to the distribution of vegetation types are ideal tools for assessing the potential effect of climate change

Box 5.3-2: Management for sustainable biodiversity.

To manage and exploit the environment effectively, and sustainably, scientific information must be translated into management plans and actions. However, promoting the wise use of ecological concepts in managing the Earth's biodiversity is neither simple nor straightforward. It requires not only specific scientific skills, but also considerable leadership qualities in co-ordination, integration and advocacy. On the other hand, the challenges and opportunities for a decisive involvement of the ecological sciences in environmental management are greater than ever, given that the Convention on Biological Diversity and the *Agenda 21* document signed at the UNCED Rio summit in 1992 provide ample political support at the highest level. How do we translate ecological research into management? Here, some key aspects of the research/management interface are discussed.

1. *The available options are limited.* The options available to managers are restricted by practical feasibility, environmental acceptability, economic desirability, and in many cases political advantage (Saunders and Burbidge 1988). Time is a key constraint. Decisions need to be made within a given (and usually short) time horizon, and typically with only incomplete information available. In the case of biodiversity, for example, the rate of loss of both species and habitats is growing exponentially, leaving less and less time for detailed, long-term studies (Meadows *et al.* 1992).

2. *Management for sustainable biodiversity must be based on the precautionary principle.* The precautionary principle, and the associated notion of reserved rationality (Perrings 1991; see Section 12), apply to those decision-making problems in which both the level of fundamental uncertainty and the potential costs are high. Examples include the use of environmental resources in novel ways and at high levels of magnitude. Both principles imply the need to proceed cautiously to safeguard against the possibility of unexpectedly severe future costs when there is ignorance as to the probability distribution of the magnitude of the negative impacts. In other words, when dealing with decisions that have the potential to destroy crucial life-supporting systems, it is prudent to have some margin for error (on the conservative side) as one learns the outcomes of a given management policy. It is also prudent to make allowances for the potential, although uncertain, future losses associated with the resulting use of environmental resources and services. By necessity, the precautionary principle implies a high value-driven judgment about the responsibility borne by present generations toward future generations (Perrings 1991). Therefore, and acknowledging that at present we do not have all the answers we need, the only prudent policy to assume today is that while there is clearly redundancy in the role of species in delivering some services, there may also be an extinction threshold which, if crossed, will result in unacceptable deterioration of ecosystems services (see 5.1). Accordingly, the precautionary principle indicates that extreme care should be taken before labelling any species as 'redundant'. Since the precautionary principle entails a cost for human societies, decisions need to be made about how much the precautionary principle would have to be stretched or how much insurance different societies can afford to buy. These kinds of decisions will be greatly aided by a better understanding of the relationship between biodiversity and ecosystem functioning.

3. *The relationship between science and management is a two-way process.* There is no such a thing as a definite, prescription regarding environmental management. Management is a continuous, dynamic and interactive process involving research, implementation and monitoring. Therefore, a continuous feedback between researchers, managers and users is clearly necessary. Accordingly, the following basic steps are required in a well planned project: (a) planning and developing goal-orientated research, (b) dissemination of results, (c) implementation of management practices and policies, and (d) monitoring and feedback.

An important component of this two-way process is the adaptive management approach, i.e. using management practices as a research tool to obtain information and insight to fine-tune management practices. Use of management as a research tool has considerable potential, providing access to semi-experimental situations at a scale and degree of realism well beyond the possibilities of 'traditional' experiments (Holling 1978). Furthermore, the management project itself can be used as an experimental probe as, for example, when manipulating grazing pressure as a way of understanding vegetation dynamics in savannas or grasslands. The adaptive management approach is particularly useful when decisions need to be made in situations where data are incomplete and uncertainty is great, requiring an ongoing, flexible, and sometimes opportunistic process. A particularly important challenge for researchers on the functional role of biodiversity is the need to develop sustainable management models for each of the Earth's biomes, in which both ecological services and human use are made compatible (see for example Milton *et al.* 1994 for a discussion on savannas). Furthermore, involvement in real-world situations favours interdisciplinary work, while providing a better insight into the constellation of factors (biological, economic and social) affecting the system under management.

under equilibrium conditions. One of the earliest models of this kind is the one developed by Holdridge (1947) (see Section 2.3). Analysis of the distribution of vegetation in equilibrium with the new climatic conditions showed big shifts of vegetation types under a double CO₂ climate (Emanuel *et al.* 1985; Kramer and Leemans 1993). The main result is a poleward shift of vegetation patterns. Approximately 30% of the vegetation of the Earth will experience a shift as a result of the predicted climate change. Although the climate change is expected to be significant, the major threat for biodiversity is the speed with which this change will occur. Changes of the magnitude predicted for a doubling of CO₂ have occurred during the Earth's climate shift from glacial to interglacial periods. However, while these changes occurred over millennia, the expected human-induced changes will occur in less than a century (Watson *et al.* 1990). The rapid change in climatic conditions will hamper the ability of individual species to migrate to regions with climatic conditions similar to those of the present. Moreover, in some cases such as the Arctic, the area favourable for the survival of an individual species will be largely reduced. The reductions of suitable areas for a large number of species, and a change in climate faster than the migration rate of most species, is certain to result in a drastic reduction of global species diversity.

5.3.2.5 Conclusions

Human-induced perturbations differ quantitatively and qualitatively from natural perturbations. Humans have increased the frequency and severity of natural disturbances to the extent that their impact is now greater than that of most natural ones (Likens 1991). The duration of human disturbances is also usually much longer, and the frequencies are much higher, than natural ones (Reiners 1983; Woodwell 1983). Among the major threats to species diversity are the qualitatively new kind of disturbances for which no specific adaptations have yet evolved. Humans have synthesized new chemical substances which have reduced the stratospheric ozone layer at higher latitudes in the Southern Hemisphere as well as at mid-latitudes (Farman *et al.* 1985; Stolarski *et al.* 1991). A reduction in the ozone layer allows increased quantities of short wave radiation (UV) to penetrate through the atmosphere. There is evidence that increased UV results in major negative effects on primary producers as well as on the next trophic level (Caldwell *et al.* 1989; Smith *et al.* 1992; Bothwell *et al.* 1994). Equally new is the ability of humans to exchange floras and faunas which has resulted in rapid and major invasions of exotic plant and animal species (Drake *et al.* 1989). Increases of some insect, plant pathogen and weed pests may be associated with the increase in CO₂ and temperature (Pimentel *et al.* 1992).

All the human-induced perturbations described here result in reductions of global species and genetic diversity, although some human manipulations may result in local increases in genetic, species, community, ecosystem and landscape diversity. Human-induced perturbations under the term 'global change' directly affect ecosystems, and humans who depend on ecosystem services (Ehrlich and Mooney 1983). Global change reduces species diversity which in turn (as described in Sections 5 and 6) may affect ecosystem functioning. The truly irreversible nature of the loss of genetic and species diversity is what it makes it so important for humans (Vitousek 1994). In contrast, the changes in atmospheric composition and climate and to a large extent land use are reversible. Reducing of 'human forcing' will result in a slow return of the atmosphere and the climate to approximately original conditions. In contrast, the loss of population and species diversity is permanent. The combination of genes that results in a variety of morphologies and behaviours will be lost for millions of years or even forever. The issue of how to satisfy the increasing demands of human societies for goods and services and simultaneously to ameliorate the rate of species and populations loss, is discussed in Box 5.3-2.

References

- Archer, S. 1989. Have southern Texas savannas been converted to woodlands in recent history? *American Naturalist* **314**: 545–561.
- Bothwell, M.L., Sherbot, D.M.J. and Pollock, C.M. 1994. Ecosystem response to solar ultraviolet-B radiation: influence of trophic-level interactions. *Science* **265**: 97–100.
- Buffington, L.C. and Herbel, C.H. 1965. Vegetational changes on a semidesert grassland range from 1858 to 1963. *Ecological Monographs* **35**: 139–164.
- Caldwell, M.M., Teramura, A.H. and Tevini, M. 1989. The changing solar ultraviolet climate and the ecological consequences for higher plants. *Trends in Ecology and Evolution* **4**: 363–367.
- Curtis, P.S., Drake, B., Leadley, G.P.W., Arp, W.J. and Whigham, D.F. 1989. Growth and senescence in plant communities exposed to elevated CO₂ concentrations on an estuarine marsh. *Oecologia* **78**: 20–26.
- Drake, J.A., Mooney, H.A., di Castri, F., Groves, R.H., Kruger, F.J., Rejmanek, M. and Williamson, M. (eds) 1989. *Biological Invasions: A global perspective*. SCOPE edn, Volume 37. John Wiley, Chichester.
- Ehrlich, P.R. and Mooney, H.A. 1983. Extinction, substitution, and ecosystem services. *BioScience* **33**: 248–254.
- Ehrlich, P.R. and Wilson, E.O. 1991. Biodiversity studies: science and policy. *Science* **253**: 758–762.
- Emanuel, W.R., Shugart, H.H. and Stevenson, M.P. 1985. Climatic change and the broad-scale distribution of terrestrial ecosystem complexes. *Climatic Change* **7**: 29–43.

- Farman, J.C., Gardiner, B.G. and Shanklin, J.D.** 1985. Large losses of total ozone in Antarctica reveal seasonal ClO_x/NO_x interaction. *Nature* **315**: 207–210.
- Heywood, V.H., Mace, G.M., May, R.M. and Stuart, S.N.** 1994. Uncertainties in extinction rates. *Nature* **368**: 105.
- Holdridge, L.R.** 1947. Determination of the world formations from simple climatic data. *Science* **105**: 367–368.
- Holling, C.S. (ed.)** 1978. *Adaptive Environmental Assessment and Management*. John Wiley, Chichester.
- Jickells, T.D., Carpenter, R. and Liss, P.S.** 1993. Marine environment. In: Turner B.L., II, Clark, W.C., Kates, R.W., Richards, J.F., Mathews, J.T. and Meyer, W.B. (eds), *The Earth as Transformed by Human Action* 313–334. Cambridge University Press, Cambridge.
- Keeling, C.D.** 1986. *Atmospheric CO_2 Concentrations. Mauna Loa Observatory, Hawaii 1958–1986*. Carbon Dioxide Information Analysis Center, Oak Ridge, Tenn.
- Körner Ch. and Arnone, J.A.** 1992. Responses to elevated carbon dioxide in artificial tropical ecosystems. *Science* **257**: 1672–1675.
- Kramer, W. P., and Leemans, R.** 1993. Assessing impacts of climate change on vegetation using climate classification systems. In Solomon, A.M. and Shugart, H.H. (eds.), *Vegetation Dynamics and Global Change*. 190–217. Chapman and Hall, New York.
- Lancelot, C., Billen, G., Sournia, A., Weisse, T., Colijn, F., Vedhuís, M.J.W., Davies, A. and Wassman, P.** 1987. *Phaeocystis* blooms and nutrient enrichment in the continental coastal zones of the North Sea. *Ambio* **16**: 38–46.
- Lauenroth, W.K., Dodd, J.L. and Sims, P.L.** 1978. The effects of water- and nitrogen-induced stresses on plant community structure in a semiarid grassland. *Oecologia* **36**: 211–222.
- Likens, G.E.** 1991. Human-accelerated environmental change. *BioScience* **41**: 130.
- Ludwig, D., Hilborn, R. and Walters, C.** 1993. Uncertainty, resource exploitation, and conservation: lessons from history. *Science* **260**: 17–36.
- Matson, P.A., and Vitousek, P.M.** 1990. Ecosystem approach to a global nitrous oxide budget. *BioScience* **40**: 667–672.
- Meadows, D.H., Meadows, D.L. and Randers, J.** 1992. *Beyond the Limits*. Chelsea Green Publishing Co., Post Mills, Vermont.
- Milchunas, D.G., Sala, O.E. and Lauenroth, W.K.** 1988. A generalized model of the effects of grazing by large herbivores on grassland community structure. *American Naturalist* **132**: 87–106.
- Milton, S.J., Dean, W.R., du Pleiss, M.A. and Siegfried, W.R.** 1994. A conceptual model of arid rangeland degradation. *BioScience* **44**: 70–76.
- Mitchell, J.F.B., Manabe, S., Meleshko, V. and Tokioka, T.** 1990. Equilibrium climate change and its implications for the future. In: Houghton, J.T., Jenkins, G.J. and Ephraums, J.J. (eds), *Climate Change: The IPCC scientific assessment* 135–164. Cambridge University Press, Cambridge.
- Mooney, H.A., Drake, B.G., Luxmoore, R.J., Oechel, W.C. and Pitelka, L.F.** 1991. Predicting ecosystem responses to elevated CO_2 concentrations. *BioScience* **41**: 96–104.
- Morse, S.R. and Bazzaz, F.A.** 1994. Elevated CO_2 and temperature alter recruitment and size hierarchies in C3 and C4 annuals. *Ecology* **75**: 966–975.
- Naveh, Z.** 1971. The conservation of ecological diversity of Mediterranean ecosystems through ecological management. In: Duffey, E. and Watt, A.S. (eds), *The Scientific Management of Animal and Plant Communities for Conservation*. 603–622. Blackwell, Oxford.
- Norby, R.J., Gunderson, C.A., Wullschlegel, S.D., O'Neill, E.G. and McCracken, M.K.** 1992. Productivity and compensatory responses of yellow poplar trees in elevated CO_2 . *Nature* **357**: 322–324.
- Perrings, C.** 1991. Reserved rationality and the precautionary principle: technological change, time and uncertainty in environmental decision making. In: Constanza, R. (ed.), *Ecological Economics*. 153–166. Columbia University Press, New York.
- Phillips, O. and Gentry, A.H.** 1994. Increasing turnover through time in tropical forests. *Science* **263**: 954–958.
- Pimentel, D., Brown, N., Vecchio, F., La Capra, V., Hausman, S., Lee, O., Díaz, A., Williams, J., Cooper, S. and Newberger, E.** 1992. Ethical issues concerning potential global climate change on food production. *Journal of Agricultural and Environmental Ethics* **5**: 113–146.
- Polley, H.W., Johnson, H.B. and Mayeux, H.S.** 1994. Increasing CO_2 : comparative response of the C4 grass *Schizachyrium* and grassland invader *Prosopis*. *Ecology* **75**: 976–988.
- Reiners, W.A.** 1983. Disturbance and basic properties of ecosystem energetics. In: Mooney, H.A. and Godron, M. (eds), *Disturbance and Ecosystems*. Ecological Studies edition, Volume 44. 83–98. Springer-Verlag, New York.
- Richards, J.F.** 1993. Land transformation. In: Turner, B., II, Clark, W.C., Kates, R.W., Richards, J.F., Mathews, J.T. and Meyer, W.B. (eds) *The Earth as Transformed by the Human Action*. 163–178. Cambridge University Press, Cambridge.
- Sala, O.E., Oesterheld, M., León, R.J.C. and Soriano, A.** 1986. Grazing effects upon plant community structure in subhumid grasslands of Argentina. *Vegetatio* **67**: 27–32.
- Saunders, D.A. and Burbidge, A.A. (eds)**, 1988, *Ecological Theory and Biological Management of Ecosystems*. Occasional Paper 1/88, Department of Conservation and Land Management, Western Australia.
- Schlesinger, W.H.** 1991. *Biogeochemistry: An analysis of global change*. Academic Press, San Diego.
- Schulze, E. D.** 1989. Air pollution and forest decline in a spruce (*Picea abies*) forest. *Science*. **244**: 776–783.
- Skole, D., and Tucker, C.** 1993. Tropical deforestation and habitat fragmentation in the Amazon: Satellite data from 1978 to 1988. *Science* **260**: 1905–1910.
- Smith, R.C., Prézelin, B.B., Baker, K.S., Bidigare, R.R., Boucher, N.P., Coley, T., Karentz, D. and MacIntyre, S.** 1992. Ozone depletion: ultraviolet radiation and phytoplankton biology in Antarctic waters. *Science* **255**: 952–959.
- Smith, F.D.M., May, R.M., Pellew, R., Johnson, T.H. and Walter, K.S.** 1993. Estimating extinction rates. *Nature* **364**: 494–496.
- Stolarski, R.S., Bloomfield, P., McPeters, R.D. and Herman, J.R.** 1991. Total ozone trends deduced from Nimbus 7 TOMS data. *Geophysical Research Letters* **18**: 1015–1018.
- Tilman, D.** 1993. Species richness of experimental productivity gradients: how important is colonization limitation? *Ecology* **74**: 2179–2191.

- VanVegten, J.A.** 1983. Thornbush invasion in a savanna ecosystem in eastern Botswana. *Vegetatio* **56**: 3–7.
- Vitousek, P.V.** 1994. Beyond global warming: ecology and global change. *Ecology* **75**: 1861–1876.
- Walker, B.H., Ludwig, D., Holling, C.S. and Peterman, R.M.** 1981. Stability of semi-arid savanna grazing systems. *Journal of Ecology* **69**: 473–498.
- Watson, R.T., Rodhe, H., Oeschger, H. and Siegenthaler, U.** 1990. Greenhouse gases and aerosols. In: Houghton, J.T., Jenkins, G.J. and Ephraums, J.J. (eds), *Climate Change: The IPCC scientific assessment*, 5–40. Cambridge University Press, Cambridge.
- World Conservation Monitoring Centre.** 1992. *Global Biodiversity: Status of the Earth's living resources*. Chapman and Hall, London.
- Williams, W.E., Garbutt, K., Bazzaz, F.A. and Vitousek, P.M.** 1986. The response of plants to elevated CO₂ IV. Two deciduous-forest tree communities. *Oecologia* **69**: 454–459.
- Woodwell, G.M.** 1983. The blue planet: of wholes and parts and man. In: Mooney, H.A. and Godron, M. (eds), *Disturbance and Ecosystems*. Ecological Studies edition, Volume 44. 2–10. Springer-Verlag, New York.

5.4 Conclusions

5.4.1 Background

Fundamentally, we wish to answer the simple question: Does biodiversity matter in the functioning of ecological systems? This question should be addressed with respect to the four major principles introduced in Section 5.0: (1) the levels of biological and ecological organization and their interactions, (2) the numbers of different biological units within each level, (3) the influence and degree of similarity in the traits or roles that biological and ecological units within each level play, and (4) the spatial configuration of the units within any level. We have thus summarized the conclusions of the chapters in Section 5 with respect to these four principles. We then proceed with a synthesis of these conclusions with respect to the influence of human actions and implications for management. The summary and synthesis take the form of several simple questions.

5.4.2 What are the influences of genetic diversity on ecosystem functioning?

Ehrlich (5.1) and Templeton (5.2.1) both point out that intraspecific genetic variation can be, and has been, exploited to change quantitative aspects of ecosystem functioning, e.g. by increasing crop yields. In addition, intraspecific genetic variability confers some adaptive capability to those species, and thus increases the possibility that their functional roles can continue to be expressed in ecosystems that are undergoing environmental variability or stress. There is very little information on whether the genetic similarity of populations influences ecosystem functioning. Templeton (5.2.1) points out that

the phenomenon of local adaptation of populations to their environment is well known, and thus the spatial configuration of genetic variability might be important. Reintroduction of species to areas from which they have been lost is generally most successful if the reintroduced individuals are from populations that originated close to the original area. It is not unreasonable to suppose that there are ramifications of these observations for ecosystem functioning, but direct experimental evidence or observations are lacking.

5.4.3 What are the influences of species diversity in ecosystem functioning?

In many cases, species clearly matter. This is primarily because the species plays an important and unique role in its ecosystem. Removal or addition of the species results in a dramatic and obvious change in the other species in the ecosystem or in a key ecosystem process. The evidence for this conclusion is compelling; the number of examples is increasing as more systems are examined; and these keystone species (Chapin *et al.*, 5.2.2) have been reported from a wide range of ecosystem types. However, in spite of the widespread existence of the phenomenon, no species characteristics have emerged that allow prediction of which species will play keystone roles. In fact, some small or cryptic species have been found to play a keystone role.

In many other cases, however, there appears to be substantial overlap among species with respect to their functional roles. Their removal or addition appears to have little demonstrable effect either on other species or on an ecosystem process. Other species compensate for the absence of the target species, at least in the short term. However, it is not known with certainty if all functions of the species in question are compensated for (in fact, it is rarely understood what the full range of functions is for each species). For this reason, it is probably inappropriate to say that species are 'redundant'.

Ecosystems with greater overlap among species with respect to any particular process will be more resistant to change than otherwise comparable systems characterized by little compensatory potential. This stability is predicted to be a direct result of the fact that species that overlap with respect to a particular function probably differ with respect to their responses to environmental changes such as temperature, salinity, ultraviolet radiation (UV-B), or exposure to toxic compounds. Compensatory overlap is thus suggested to provide 'insurance' in the sense that key functions are more likely to continue despite changes that result in the loss of some species. There is some evidence for this prediction, but it is a very difficult phenomenon to demonstrate. There is no evidence that contradicts the predictions. This is an area where further research is needed.

The above conclusions focus on particular traits of species and the extent to which the traits are unique to a

species or not. A separate question of importance is whether the number of species *per se*, apart from their specific traits, has a strong influence on ecosystem properties. The number of species in an ecosystem is functionally important, independent of the traits of the species, for two reasons: (1) more species generally increase the rate or efficiency of resource capture under steady-state conditions, and (2) more species provide insurance against large changes in ecosystem processes in response to disturbance or environmental change (Chapin *et al.*, 5.2.2).

The spatial structure of species populations within ecosystems has influences on their interactions, their diversity and abundance, and therefore on ecosystem-level processes (Harrison, 5.2.3). Changes in spatial structure, especially fragmentation of habitats, act differentially on different kinds of organisms, depending in part on body size, trophic level, life-history characteristics and successional stage. Fragmentation reduces the diversity of native species in their natural habitats and the types of species most likely to be lost are those with the highest rates of local extinction on small habitat patches (e.g. top predators and other species with large body sizes and large area requirements). Also likely to be lost are species with lower abilities to disperse and colonize habitat patches. Species likely to survive fragmentation will be those best adapted to patchy and frequently disturbed environments, especially early successional and easily dispersed species.

Fragmentation is thus expected to result in ecosystems dominated by 'weedy' species characterized by short life-span, rapid growth rate, and high reproductive and dispersal capacity. This, in turn, is expected to result in numerous ecosystem-level consequences: faster turnover and leakier systems with respect to nutrients, nitrogen, and carbon; higher litter quality and therefore faster decomposition rates; simpler spatial structure; less overall protection from herbivory; and different kinds of chemical defences against herbivory, tending to low molecular weight compounds.

Thus, the assessment is revealing that in many cases 'species matter' in a fashion that can be demonstrated; in others, species appear to be sufficiently similar to other species with respect to their functional roles that their loss should have no immediate consequences, but unequivocal demonstration that they will or will not 'matter' over a longer period of time is difficult and unlikely to occur. This does not mean that every single species matters in every single situation. There are certainly examples where species have been lost and there has been no demonstrable change to the ecosystem's functioning. It is difficult to say, however, that no change occurred; the evidence available does suggest that there was no catastrophic change.

5.4.4 What are the influences of landscape diversity on ecosystem functioning?

At a landscape or regional scale, the key processes to understand are those that regulate the movement of materials (e.g. nutrients, water, trace gases, etc.), energy fluxes, and dispersal of organisms among the constituent ecosystems, and between the ecosystems and the atmosphere and hydrosphere (Burke and Lauenroth, 5.2.4). The number of different types of ecosystems on a landscape has obvious effects on the total functioning of the landscape. Those ecosystems that cover large areas obviously have important roles; however, some ecosystems on a landscape have functional importance out of proportion to their abundance (Burke and Lauenroth, 5.2.4). This is true of riparian areas and wetlands, particularly in respect of their capabilities to purify water before it reaches streams and rivers, and also for marine systems such as coral reefs, mangroves and kelp forests.

Because of climatic, topographic and geological variation; historical differences; and disturbance frequency, severity and extent (Pickett, 5.3.1; Burke and Lauenroth, 5.2.4), the arrangement of ecosystems on the landscape can be extremely complex, and this complexity affects the total functioning of the landscape. Many of the transfers across landscapes are the result of directional processes, such as wind and water flow, and therefore the total effect of the processes in a region may depend critically on the actual spatial arrangement of the ecosystems, and how that array is orientated with respect to these abiotic factors. The fragmentation of habitat associated with human activities can alter landscape/regional diversity by affecting the spatial patterns of ecosystems on the landscape, by fragmenting the landscape, in effect creating new, disturbed areas, and/or by decreasing the total area of different ecosystems on the landscape. Each of these effects may have characteristic results for different types of species, and thus for ecosystem processes. For example, the spatial pattern of the fragmentation results in the provision of dispersal corridors for some organisms, but reductions in available habitat and opportunities for dispersal and migration for others, and can have a great effect both on overall levels of biodiversity and on ecosystem functioning across the landscape.

5.4.5 What are the human influences on ecosystem functioning?

Human-induced changes in biodiversity are characterized by their increased frequency (rate of change), severity (magnitude of change), and increased spatial extent (Sala, 5.3.2). At a local scale, human activities can have negative (local population eradication), neutral (sustainable harvesting), or even positive (e.g. increase in the number of landscape units) effects on biodiversity. When viewed at a global scale, though, human activities reduce biodiversity

at genetic and species levels, and species' extinctions are completely irreversible. In addition, human activities can create environmental changes for which biota are not at all adapted, for example increased surface UV-B flux due to reduction in stratospheric ozone, or the proliferation of novel, but extremely toxic compounds in the environment.

Extractive activities, such as agriculture and forestry, tend to increase the fluxes of materials in ecosystems across a landscape, often leading to increased losses of nutrients, increased surface water flow, increased sedimentation in streams and rivers, and long-term reductions in soil carbon and soil fertility. These activities clearly affect landscape functioning through their effect on the diversity of ecosystems within a landscape. Other human activities, such as the construction of dams for water control, have very different effects at landscape scale, often resulting in the concentration and immobilization of nutrients and sediment in particular parts of the landscape. Still others, such as fire control in forests, have the effect of dramatically changing the disturbance regime, resulting in widespread changes in landscape functioning.

5.4.6 What are the management implications for goods and services?

To manage and exploit the environment effectively and sustainably, scientific information needs to be translated into management plans and actions. However, there is great difficulty in managing to provide goods and services simultaneously while maintaining diversity at prudent, sustainable levels. Several important principles can be used to guide the implications for management: (1) practical constraints on feasibility, environmental acceptability and economic desirability must be clearly understood; (2) a goal-orientated approach must be applied that recognizes that there are always multiple objectives in any management scenario; (3) an iterative process, analogous to that of adaptive management in forestry, should be employed in order to integrate the knowledge

gained from earlier management decisions into a continually improving management scheme; and (4) when uncertainty about the resource base or the knowledge base is predominant, the precautionary principle should be employed, thus avoiding whenever possible decisions that close off future options.

5.4.7 Summary

Section 5 has laid out in broad detail the important concepts governing the study of the relationships between biodiversity and ecosystem functioning. The importance of considering biodiversity at multiple levels of organization is emphasized, as is the degree of influence and similarity in traits, and the spatial arrangement of biological units within any level of organization. Redundancy of function of species within ecosystems and ecosystems within landscapes cannot be assumed: indeed, some species and ecosystems have unique functional roles that are significant out of all proportion to their abundance. The main consequence of diversity at all levels seems to lie in the degree of adaptive insurance it provides for the maintenance of ecosystem processes against environmental variation and/or stress.

The human influences on biodiversity and ecosystem functioning have largely taken the form of rapid, large, and frequent changes in land and resource use, increased frequency of biotic invasions, reductions in species numbers, creation of novel stresses, and the potential for change in the climate system. Although disturbance is a critical element controlling the composition and functioning of ecosystems, human influences have increased its pace and extent well beyond previously known levels. The major implications for the continued provision of ecological goods and services are to create and use management strategies in an adaptive fashion, to ensure that sufficient resources are maintained in the system to provide resilience, and to be cautious about making potentially irreversible decisions.

6

Biodiversity and Ecosystem Functioning: Ecosystem Analyses

H.A. MOONEY, J. LUBCHENCO, R. DIRZO AND O.E. SALA

Lead Authors:

J.H. Cushman, R. Dirzo, A.C. Janetos, J. Lubchenco, H.A. Mooney, O.E. Sala (Chapter 6.0); F.S. Chapin III, C. Körner, (Chapter 6.1.1); G.H. Orians, R. Dirzo, J.H. Cushman, E. Medina, S.J. Wright (Chapter 6.1.2); R.H. Waring, E.-D. Schulze (Chapter 6.1.3); L. Foster Huenneke, I. Noble (Chapter 6.1.4); E. Medina (Chapter 6.1.5); J. Pastor, D.J. Mladenoff, Y. Haila, J.P. Bryant, S. Payette (Chapter 6.1.6); O.E. Sala, W.K. Lauenroth, S.J. McNaughton, G. Rusch, X. Zhang (Chapter 6.1.7); R. Hobbs, G. Davis, J. Keeley (Chapter 6.1.8); J. Lubchenco, G.W. Allison, S. A. Navarrete, B.A. Menge, J. C. Castilla, O. Defeo, C. Folke, O. Kussakin, T. Norton, A.M. Wood (Chapter 6.1.9); T. Done, J. Ogden, W. Wiebe (Chapter 6.1.10); R.R. Twilley, S.C. Snedaker, A. Yañez-Arancibia, E. Medina (Chapter 6.1.11); M. Chandler, L. Kaufman, S. Muslow (Chapter 6.1.12); S.R. Carpenter, T. Frost, L. Persson, M. Power, D. Soto (Chapter 6.1.13); C.B. Field (Chapter 6.2.1); J.M. Anderson (Chapter 6.2.2); L.F. Huenneke (Chapter 6.2.3); H. Rennenberg (Chapter 6.2.4); I.R. Noble, I.C. Burke (Chapter 6.2.5); R. Dirzo, S. Naeem, J.H. Cushman (Chapter 6.2.6); D.U. Hooper, D.L. Hawksworth, S.S. Dhillon (Chapter 6.2.7); M.J. Swift, J. Vandermeer, P.S. Ramakrishnan, C.K. Ong, J.M. Anderson, B. Hawkins (Chapter 6.2.8); J.H. Cushman, R. Dirzo, A.C. Janetos, J. Lubchenco, H.A. Mooney, O.E. Sala (Chapter 6.3)

Contributors:

B. Ammen, J.-L. Bores, L. Brubaker, J. Bryant, T. Callaghan, Y. Chernov, G. Grabherr, A. Hershey, S. Hobbie, R. Jefferies, S. Jonasson, G. Kling, D. Murray, J. O'Brien, P. Ozenda, J. Pastor, J. Schimel, G. Shaver, M. Walker, O. Young, S. Zimov (Chapter 6.1.1); P.A. Colinvaux, J.S. Denslow, J.J. Ewel, L.E. Gilbert, S.R. Gliessman, D.L. Hawksworth, M.A. Huston, V. J. Jaramillo, D.J. Lodge, A.G. Power, M. Rejmanek, W.L. Silver (Chapter 6.1.2); B. Fox, M. Fox, H. Gitay, R.P. Herman, J. Landsberg, S. Lavorel, S. Morton, I. Noy-Meir, W.H. Schlesinger, W.G. Whitford (Chapter 6.1.4); J. Blondel, E. Fuentes, J. Moreno (Chapter 6.1.8); P.D. Boersma, G. Branch, R. Bustamante, R.R. Colwell, P.K. Dayton, M. Dethier, T. Done, J.A. Estes, R.M. Fujita, V. Gerard, F. Grassle, E. Jaramillo, S.A. Levin, R.T. Paine, C.H. Peterson, C. Safina, P. Sanchez, B. Santelices, B. Sherr, E. Sherr, W. Stolz, C. Trowbridge (Chapter 6.1.9); D. Bellwood, J. Benzie, C. Birkeland, J. Cortes, C. D'Elia, M. Eakin, R. Galzin, P. Glynn, M. Harmelin-Vivien, B. Hatcher, J.B.C. Jackson, C. Johnson, E. Jordan, N. Knowlton, J. McManus, J. Pandolfi, S. Planes, D. Potts, M. Reaka-Kudla, C. Roberts, B. Rosen, P. Sale, B. Salvat, K. Sebens, B. Thomassin, J. Veron, H. Yap (Chapter 6.1.10); H.A. Mooney (Chapter 6.1.11); J.T. Carlton, C. Stuart, E. Okemwa, C.A. Butman, F. Grassle (Chapter 6.1.12); K. Cottingham, T. Kratz (Chapter 6.1.13); V. Jaramillo, A. Austin, C. Körner, E.-D. Schulze, D. Tilman (Chapter 6.2.1); E. Cuevas, F.S. Chapin III, R.J. Hobbs, L.F. Pitelka, R.B. Jackson (Chapter 6.2.2); S. Carpenter, M. Chandler, G. Davis, T. Done, P. Risser, O.E. Sala (Chapter 6.2.3); A.C. Janetos, A.E. Lugo, H.A. Mooney, W. Seiler (Chapter 6.2.4); M. Higashi, B.R. Huntley, P.R. Jutro, O.T. Solbrig, D. Soto, N.G. Smith (Chapter 6.2.6); F.S. Chapin III, K. Dunkin, E. Medina, P.S. Ramakrishnan, M.J. Swift, P. Vitousek (Chapter 6.2.7).

CONTENTS

Executive Summary	333	References	348
6.0 Introduction	335	6.1.4 Arid and semi-arid lands	349
6.0.1 Background	335	6.1.4.1 Introduction	349
6.0.2 Biome essays and ecosystem processes	335	6.1.4.2 Productive capacity, biomass, decomposition and nutrient cycling	350
6.0.3 Cross-biome comparisons and syntheses	335	6.1.4.3 Soil structure and nutrient pools	350
Reference	335	6.1.4.4 Water distribution, balance and quality	351
6.1 Biome Essays	335	6.1.4.5 Feedbacks to atmospheric properties	351
6.1.1 Arctic and alpine systems	335	6.1.4.6 Landscape structure	351
6.1.1.1 Introduction	335	6.1.4.7 Biotic linkages and species interactions	351
6.1.1.2 Productive capacity, biomass, decomposition and nutrient cycling	335	6.1.4.8 Microbial activities	352
6.1.1.3 Soil structure and nutrient pools	336	6.1.4.9 Summary and relevance to human activities	352
6.1.1.4 Water distribution, balance and quality	336	References	352
6.1.1.5 Feedbacks to atmospheric properties	336	6.1.5 Tropical savannahs	354
6.1.1.6 Landscape and waterscape structure	337	6.1.5.1 Introduction	354
6.1.1.7 Biotic linkages and species interactions	337	6.1.5.2 Human impacts on biodiversity	354
6.1.1.8 Microbial activities	337	6.1.5.3 Productive capacity, biomass and decomposition	354
6.1.1.9 Summary and relevance to human activities	337	6.1.5.4 Soil structure and nutrients	355
References	338	6.1.5.5 Water distribution, balance and quality	355
6.1.2 Tropical forests	339	6.1.5.6 Atmospheric properties	355
6.1.2.1 Introduction	339	6.1.5.7 Landscape and waterscape structure	355
6.1.2.2 Human impacts on biodiversity	339	6.1.5.8 Biotic linkages and species interactions	355
6.1.2.3 Productive capacity, biomass, decomposition and nutrient cycling	340	6.1.5.9 Microbial activities	356
6.1.2.4 Water distribution, balance and quality	341	6.1.5.10 Summary and relevance to human activities	356
6.1.2.5 Atmospheric properties and feedback	341	References	356
6.1.2.6 Landscape and waterscape structure	341	6.1.6 Boreal forests	358
6.1.2.7 Biotic linkages and species interactions	341	6.1.6.1 Introduction	358
6.1.2.8 Microbial activities	342	6.1.6.2 Human-induced impacts and threats to biodiversity	358
6.1.2.9 Summary and relevance to human activities	342	6.1.6.3 Productive capacity, biomass and decomposition	358
References	343	6.1.6.4 Soil structure and nutrients	359
6.1.3 Temperate forest systems	345	6.1.6.5 Water distribution, balance and quality	359
6.1.3.1 Introduction	345	6.1.6.6 Feedbacks to atmospheric properties	359
6.1.3.2 Productive capacity, biomass, decomposition and nutrient cycling	345	6.1.6.7 Landscape structure	359
6.1.3.3 Soil structure and nutrient pools	346	6.1.6.8 Biotic linkages and species interactions	359
6.1.3.4 Water distribution, balance and quality	346	6.1.6.9 Microbial activities	360
6.1.3.5 Feedbacks to atmospheric properties	346	6.1.6.10 Summary and relevance to human activities	360
6.1.3.6 Landscape and waterscape structure	347	References	360
6.1.3.7 Biotic linkages and species interactions	347	6.1.7 Temperate grasslands	361
6.1.3.8 Microbial activities	348	6.1.7.1 Introduction	361
6.1.3.9 Summary and relevance to human activities	348	6.1.7.2 Human impact on biodiversity	362
		6.1.7.3 Productive capacity	362

6.1.7.4	Decomposition and soil structure	363	6.1.11.5	Water distribution, balance and quality	388
6.1.7.5	Water distribution and balance	363	6.1.11.6	Atmospheric properties	389
6.1.7.6	Atmospheric properties	364	6.1.11.7	Landscape and waterscape structure	389
6.1.7.7	Landscape structure	364	6.1.11.8	Biotic linkages and species interactions	389
6.1.7.8	Biotic linkages and species interactions	364	6.1.11.9	Microbial activities	389
6.1.7.9	Microbial activities	364	6.1.11.10	Summary and relevance to human activities	390
6.1.7.10	Summary and relevance to human activities	364	References		390
	References	365	6.1.12	Open oceans	393
6.1.8	Mediterranean-type ecosystems	366	6.1.12.1	Introduction	393
6.1.8.1	Introduction	366	6.1.12.2	Threats to the oceans	394
6.1.8.2	Productive capacity, biomass and decomposition	367	6.1.12.3	Productive capacity, biomass, decomposition and nutrient cycling	395
6.1.8.3	Soil structure and nutrients	367	6.1.12.4	Sediment structure and nutrient pools	396
6.1.8.4	Water distribution, balance and quality	367	6.1.12.5	Water distribution, balance and quality	396
6.1.8.5	Atmospheric properties	367	6.1.12.6	Feedbacks to atmospheric properties	396
6.1.8.6	Landscape and waterscape structure	367	6.1.12.7	Landscape and waterscape structure	396
6.1.8.7	Biotic linkages and species interactions	367	6.1.12.8	Biotic linkages and species interactions	397
6.1.8.8	Microbial activities	368	6.1.12.9	Microbial activities	397
6.1.8.9	Summary and relevance to human activities	368	6.1.12.10	Summary and relevance to human activities	397
	References	368	References		398
6.1.9	Coastal systems	370	6.1.13	Lakes and rivers	399
6.1.9.1	Introduction	370	6.1.13.1	Introduction	399
6.1.9.2	Major human-induced impacts on and threats to biodiversity	371	6.1.13.2	Productivity, biomass, decomposition and nutrient cycling	400
6.1.9.3	Productive capacity, biomass, decomposition and nutrient cycling	372	6.1.13.3	Water distribution, balance and quality	400
6.1.9.4	Sediment structure	373	6.1.13.4	Atmospheric properties	400
6.1.9.5	Water movement and quality	374	6.1.13.5	Landscape and waterscape structure	400
6.1.9.6	Feedbacks to atmospheric properties	375	6.1.13.6	Biotic linkages and species interactions	401
6.1.9.7	Landscape and waterscape structure	375	6.1.13.7	Microbial activities	401
6.1.9.8	Biotic linkages and species interactions	376	6.1.13.8	Summary and relevance to human activities	401
6.1.9.9	Microbial activities	376	References		401
6.1.9.10	Summary and relevance to human activities	377	6.2 Cross-biome comparisons		402
	References	377	6.2.1	Productive capacity and biomass accumulation	402
6.1.10	Coral reefs	381	6.2.1.1	Introduction	402
6.1.10.1	Introduction	381	6.2.1.2	Lessons from agriculture	402
6.1.10.2	Threats to reefs	382	6.2.1.3	Habitat variation in space and time	403
6.1.10.3	Productive capacity, biomass and decomposition	382	6.2.1.4	Production and resource augmentation	404
6.1.10.4	Sediment structure and nutrients	382	6.2.1.5	Biomass and disturbance	405
6.1.10.5	Water circulation and quality	383	References		405
6.1.10.6	Atmospheric properties	384	6.2.2	The soil system	406
6.1.10.7	Landscape and seascape structure	384	6.2.2.1	Introduction	406
6.1.10.8	Biotic linkages and species interactions	384	6.2.2.2	Lessons from agriculture	406
6.1.10.9	Microbial activities	385	6.2.2.3	Soil organic matter	408
6.1.10.10	Summary and relevance to human activities	385	6.2.2.4	Functional importance of spatial complexity	408
6.1.10.11	Management implications	385	6.2.2.5	Summary and relevance to human activities	409
	References	386	References		409
6.1.11	Mangrove systems	387	6.2.3	Effects of biodiversity on water distribution and quality	412
6.1.11.1	Introduction	387	6.2.3.1	Introduction	412
6.1.11.2	Human impacts on relevant biodiversity components	387	6.2.3.2	Distribution of water	412
6.1.11.3	Productive capacity, biomass and decomposition	388	6.2.3.3	Groundwater fluxes	413
6.1.11.4	Soil structure and nutrients	388	6.2.3.4	Evapotranspiration	413
			6.2.3.5	Filtration and assimilative capacity	414

6.2.3.6 Trophic cascades and other biotic influences on water quality	414	6.2.7.1 Background	433
6.2.3.7 Summary and implications	414	6.2.7.2 Important aspects of microbial diversity	433
References	415	6.2.7.2.1 Substrate-based groups	434
6.2.4 Atmospheric feedbacks	417	6.2.7.2.2 Size-based groups	434
6.2.4.1 Introduction	417	6.2.7.2.3 Species-specific interactions	435
6.2.4.2 Biogenic emissions and atmospheric properties	417	6.2.7.2.4 Qualitative and stabilizing effects of diversity	435
6.2.4.3 Fluxes of atmospheric constituents into the biosphere	419	6.2.7.3 Changes in biodiversity and microbial activity	435
6.2.4.4 Climate change and biosphere/atmosphere interactions at the level of biodiversity and ecosystem functioning	419	6.2.7.3.1 Biotic interactions	436
6.2.4.5 Conclusions and management implications	420	6.2.7.3.2 Trace gas production	436
References	420	6.2.7.3.3 Carbon and nutrient cycling	437
6.2.5 The influence of biodiversity on landscape structure	422	6.2.7.4 Conclusions	437
6.2.5.1 Introduction	422	References	440
6.2.5.2 Specific systems	423	6.2.8 Agroecosystems	443
6.2.5.2.1 Arid systems	423	6.2.8.1 Introduction	443
6.2.5.2.2 Temperate and boreal forests and grasslands	423	6.2.8.2 Impact of agricultural intensification on relevant biodiversity components	443
6.2.5.2.3 Tropical savannahs	423	6.2.8.3 Ecosystem consequences of impacts	443
6.2.5.2.4 Wet tropics	424	6.2.8.3.1 Productivity capacity, biomass and decomposition	443
6.2.5.2.5 Aquatic systems	424	6.2.8.3.2 Soil structure and nutrients	444
6.2.5.3 Generalizations	425	6.2.8.3.3 Water distribution, balance and quality	444
References	426	6.2.8.3.4 Atmospheric properties	444
6.2.6 Biotic linkages and ecosystem functioning	427	6.2.8.3.5 Landscape and waterscape structure	444
6.2.6.1 Introduction	427	6.2.8.3.6 Biotic linkages and species interactions	445
6.2.6.2 Human impacts	427	6.2.8.3.7 Microbial activities	445
6.2.6.3 Effects of removal of species on biotic linkages	429	References	445
6.2.6.3.1 Empirical evidence of the effects on ecosystem functioning	429	6.3 Conclusions	446
6.2.6.4 Effects of addition of species on biotic linkages	429	6.3.1 Background	446
6.2.6.4.1 Empirical evidence of the effects on ecosystem functioning	430	6.3.2 The importance of ecosystem approach	446
6.2.6.5 Cross-biome comparison and ecosystem services	430	6.3.3 Ecological goods and services	446
6.2.6.5.1 Pollination linkages	430	6.3.4 Drivers of change	447
6.2.6.5.2 Seed dispersal linkages	430	6.3.5 Factors affecting the functional sensitivities of ecosystems	447
6.2.6.5.3 Grazing linkages	430	6.3.6 Invasions, introductions and species losses	448
6.2.6.6 Conclusions	432	6.3.7 Transformations and fragmentation of populations and ecosystems	449
References	432	6.3.8 Goods and services at risk	450
6.2.7 Microbial diversity and ecosystem processes	433	6.3.9 Implications	451
		Acknowledgements	452

EXECUTIVE SUMMARY

1. Ecosystems provide services to humans that are crucial for their well-being. These services are not widely recognized, nor are they properly valued in economic, or even social terms.
 2. The Earth is covered by a myriad distinctive ecosystems all of which are increasingly impacted by human activity.
 3. Human-driven perturbations to ecosystems are altering their structure, depleting stores of resources that fuel productivity, disconnecting populations and disrupting species interdependencies.
 4. The accidental introduction of species can have major, and often detrimental, impacts on the functioning of ecosystems. Successful establishment of invaders is greatest in those systems that are biotically simple, such as islands, and those that have been disturbed by human activity. The potential success of a particular invading species is difficult to predict but its ecosystem impact depends on whether it utilizes or produces a resource unique to its new habitat.
 5. All ecosystem services are affected to one degree or another by reductions in diversity. This fact follows simply from the greater resource capture, i.e. of energy, water, nutrients, sediments, of diverse systems compared to simple systems. However, depending on the time dimension and functional types present, the exact relationship between diversity and function will vary.
 6. Certain ecosystems, such as arid and arctic ecosystems, and those found on islands, appear particularly vulnerable to human disruptions and hence alteration of their functioning. These sensitive systems all have low representation of key functional types (organisms that share a common role).
 7. The types of connection among ecosystems within a landscape greatly influence the exchange of nutrients, water, sediments and genetic material. Ecosystems, and the services they provide, must be considered in a total landscape context and in some cases even on an intercontinental basis.
 8. As society exerts ever greater control and management of the ecosystems of the world, great care must be taken to ensure their sustainability, which is due in large part to the buffering capacity provided by biotic complexity.
-

6.0 Introduction

6.0.1 Background

In this section, the general principles outlined in Section 5 are used to assess our current knowledge of the ecosystem-level consequences of human-induced changes in biodiversity. We provide separate assessments for a selection of the major biomes of the world because the human impacts on biodiversity and the associated ecosystem consequences differ among biomes and because decision-makers will require different information for each. Our sample includes freshwater, marine and terrestrial systems that represent a significant portion of the ecosystems on Earth.

6.0.2 Biome essays and ecosystem processes

For each of the 15 biomes surveyed, the authors provide information on the consequences of human-induced changes in biodiversity for seven ecosystem processes and/or properties:

- Productive capacity and biomass
- Soil structure, nutrients and decomposition
- Water distribution, balance and quality
- Atmospheric properties and feedbacks
- Landscape and waterscape structure
- Biotic linkages/species interactions
- Microbial activity

These topics involve key ecosystem processes, such as carbon, water and nutrient cycling. They also recognize the importance of higher levels of integration in ecological systems: interactions between the Earth's surface and atmospheric properties; biotic linkages, because they result in the provision of many essential ecosystem services; and microbial activity, which fuels many ecosystem-level processes. More extensive discussions of these points with respect to each ecosystem can be found in the forthcoming SCOPE volume (Mooney *et al.* 1996).

The biome essays provide biome-specific information on (a) the drivers of change in biodiversity, (b) the impact of these drivers on biodiversity at multiple levels, and (c) the ecosystem consequences of these changes in biodiversity. For example, as outlined in the coral reef essay (6.1.10), a major driver of change in these systems is overfishing by the growing human populations that inhabit the adjacent coastlines. The impact of this driver on biodiversity is to reduce greatly the abundance and diversity of algae-grazing fishes. A significant ecosystem consequence of this change is the transformation of reefs from coral-dominated to algae-dominated systems. These changes have direct and immediate feedbacks to people who depend on coral reefs: in addition to buffering coastal environments from storms, coral reefs provide an array of highly specific taxa that are important in commercial and subsistence harvesting.

6.0.3 Cross-biome comparisons and syntheses

After considering each of the 15 biomes in our sample, the authors generate cross-biome comparisons of the ecosystem consequences of human-induced impacts on biodiversity. These seven essays provide comparative analyses of the functional consequences of an increasingly modified world. We then synthesize the findings of the individual biome essays and the cross-biome comparisons to derive our final conclusions.

We have attempted throughout to provide a synthesis of our conclusions that is in a form accessible to both policy-making and scientific communities. Inevitably, our current ability to address all the questions for which one would like answers is limited in some cases. However, the hope is that future efforts will benefit from an articulation of these questions and from knowing where the gaps in scientific knowledge exist.

Reference

- Mooney, H.A., Cushman, J.H., Medina, E., Sala, O.E. and Schulze, E.-D. 1996. *Functional Roles of Biodiversity: A global perspective*. John Wiley, Chichester (in press).

6.1 Biome essays

6.1.1 Arctic and alpine systems

6.1.1.1 Introduction

Arctic and alpine ecosystems are cold-dominated ecosystems lacking trees. These ecosystems occupy about 8% of the terrestrial surface of the globe (5% Arctic, 3% alpine) but support only about 4% of the global flora (1500 Arctic species, 10 000 alpine species) and fauna. Species diversity of plants and animals in Arctic and alpine regions declines with increasing latitude and altitude, but genetic diversity within species appears unrelated to climatic severity. Within both regions species diversity of plants and animals is concentrated in areas of high vertical relief, lacking a well-developed organic mat. The vast expanses of peat-covered landscape in the Arctic and in level terrain in alpine regions have very few species (generally <10 vascular plant species per m²), and these species have a widespread geographic distribution. Landscape diversity strongly influences terrestrial-aquatic exchanges, particularly in permafrost-dominated Arctic terrain, where water and nutrients flow laterally among ecosystems (Kling 1995).

6.1.1.2 Productive capacity, biomass, decomposition and nutrient cycling

Human impacts on biodiversity. Other than the direct impacts of land use, the most profound human impacts result from activities outside Arctic and alpine ecosystems, such as CO₂-induced climatic change, which may increase

reproductive output and growth in the high Arctic (Wookey *et al.* 1993) and cause major changes in growth-form composition in the low Arctic (Chapin *et al.* in press) and alpine regions. CO₂ has little direct effect on Arctic or alpine plant growth (Tissue and Oechel 1987) or ecosystem CO₂ flux (Oechel *et al.* 1994; Körner *et al.* 1995). Arctic haze derived from pollutants produced at low latitudes could reduce the cover of mosses and lichens (Lechowicz 1987), which provide the major insulating layer protecting permafrost integrity (Tenhunen *et al.* 1992).

Ecosystem consequences of impacts. In the Arctic, changes in the relative abundance of current species generally have little direct effect on productivity and nutrient cycling because reduced abundance of some species is balanced by increased abundance of others (Chapin and Shaver 1985). Overall productivity is strongly constrained by climate and nutrient supply, so that energy and nutrient cycling are relatively insensitive to large changes in relative abundance of species and growth forms. However, these changes in species composition can have long-term effects on nutrient cycling and productivity through changes in litter quality and rates of decomposition (Shaver *et al.* 1995) or nitrogen inputs by lichens and the blue-green algae associated with mosses. Climatic warming increases the abundance of shrubs which have higher litter quality than the mosses they replace (Chapin *et al.*, in press). Similarly, reduction in moss cover resulting from pollutant inputs could increase energy inputs to soil and soil temperature (Tenhunen *et al.* 1992; Zimov *et al.* 1993a). Warmer soils enhance decomposition and the nutrient supply to vascular plants (Nadelhoffer *et al.* 1991). Lichens, which are important both as a source of N fixation and as winter food for caribou, are particularly sensitive to shading by shrubs (Chapin *et al.* in press) and to air pollutants (Lechowicz 1987). Changes in grazing can also modify the diversity of plant functional groups. For example, large mammalian browsers increase in response to increased shrub growth. In the boreal forest, these browsers speed the rate of succession by removing highly palatable species, leaving species with lower litter quality and associated declines in decomposition and nitrogen mineralization (Pastor *et al.* 1993). Thus, the major effects of climatic warming may operate primarily through changes in composition of plant and animal communities and litter-quality feedbacks to nutrient supply rather than directly on the productive capacity of vegetation.

6.1.1.3 Soil structure and nutrient pools

Human impacts on biodiversity. Soil structure and nutrient pools are most strongly dependent on human activities that influence long-term ecosystem persistence. In both the Arctic and the alpine, human disturbance that destabilizes soils (e.g. tourist developments in the alpine and use of tracked vehicles in the arctic) increases the

physical interactions among landscape units. For example, destabilization of slopes in the alpine causes down-slope delivery of avalanche debris. In the Arctic, permafrost degradation associated with mining and oil development expands beyond the initial zone of disturbance due to heating of adjacent soils, melting of ice, impoundment of water, and slumping of soils (Billings 1973; Walker *et al.* 1987).

Ecosystem consequences of impacts. This shift in landscape structure from mesic to wet tundra results in lower productivity, lower decomposition and greater carbon storage than does the original tundra from which it was formed (Chapin *et al.* 1980; Oechel and Billings 1992). Some of the biologically richest ecosystems in the lower alpine zone in Eurasia have developed over millennia of traditional cattle grazing or mowing but are losing species with the current abandonment of lands. This loss of diversity affects slope stability and drainage. In both Arctic and alpine ecosystems, return to the original ecosystem type following soil destabilization can require hundreds to thousands of years.

6.1.1.4 Water distribution, balance and quality

Human impacts on biodiversity. Human impacts on ecosystem integrity and landscape diversity (see above) strongly influence water quality and distribution. Destabilization of alpine slopes reduces plant cover and increases the quantity and seasonal variation in runoff to rivers, presumably affecting aquatic community structure and trophic dynamics. In the Arctic, human-induced melting of permafrost can lead to siltation of rivers and to formation of new ponds (Walker *et al.* 1987).

Ecosystem consequences of impacts. Even small anthropogenic nitrogen or phosphorus additions to Arctic lakes and streams substantially increase algal and fish production, increase production by benthic mosses, and greatly alter the species composition of zooplankton (lakes) and insect grazers (streams), shifting from a detritus-based to an algae-based food web (Peterson *et al.* 1993).

6.1.1.5 Feedbacks to atmospheric properties

Human impacts on biodiversity. Recent climatic warming is already causing upward migration of alpine species (Grabherr *et al.* 1994) and is predicted to cause northward and up-slope movement of treelines (D'Arrigo *et al.* 1987; Briffa *et al.* 1990). This represents a major change in distribution and diversity of species and functional groups in cold-dominated ecosystems. If climatic warming leads to drier soils, this would change landscape diversity, which at present is largely determined by topography and soil water movement.

Ecosystem consequences of impacts. Northward and upward movement of treelines would substantially increase annual energy absorption by northern ecosystems by

masking snow and reducing albedo. This would act as a positive feedback to regional climatic warming, an effect that would be most pronounced at high latitudes, but could extend to the tropics (Bonan *et al.* 1992). The current net CO₂ efflux observed in Arctic ecosystems may depend directly on soil drying (Oechel *et al.* 1993) in the wet Arctic of North America (with diversity playing little role), but the increased CO₂ efflux in the drier Russian Arctic could reflect a reduction in cover of pollutant-sensitive mosses, whose insulative properties govern the soil temperature regime (Zimov *et al.* 1993b). Arctic wetlands and associated loess sediments are large terrestrial sources of methane (Reeburgh and Whalen 1992; Fukuda 1994), and changes in landscape diversity, as a result of soil drying, could reduce methane efflux. Changes in the abundance or species composition of sedges, which transport most methane from Arctic soils to the atmosphere (Torn and Chapin 1993), could alter fluxes of this greenhouse gas and, therefore, the role of methane in atmospheric warming (Whalen and Reeburgh 1992).

6.1.1.6 Landscape and waterscape structure

Human impacts on biodiversity. Human agricultural (alpine) and industrial (arctic) developments have substantially altered landscape structure and diversity. For example, in the Arctic, the building of roads and pipelines has altered patterns of water drainage, and the relative abundance of waterlogged and well-drained soils. In the alpine regions, the construction of ski runs has smoothed the landscape and introduced new plant communities. Such land-use change can alter hydroelectric yield. These indirect impacts of energy development are many times larger than the direct impact of development (Walker *et al.* 1987).

Ecosystem consequences of impacts. For ecosystem consequences, see the above sections on soil structure and water distribution.

6.1.1.7 Biotic linkages and species interactions

Human impacts on biodiversity. Increasing demand by non-Arctic people for Arctic animal products, combined with increasing hunting efficiency, has resulted in a greater human harvest of marine and terrestrial mammals, in many cases causing or contributing to population declines. This is often combined with changes in human social structure which might otherwise have placed limits on the exploitation of these animal resources (Young and Chapin 1995). In addition, human-induced climatic warming is altering the competitive balance and diversity of plant species within the Arctic (see productive capacity) and could decouple the phenology of plants and their pollinators, leading to elimination of plant species that may have important ecosystem effects (Inouye and McGuire 1991).

Ecosystem consequences of impacts. In cases where animals (e.g. sea otters) are keystone predators, over-

hunting produces effects that propagate through the entire ecosystem. Human hunting of the Pleistocene megafauna may have triggered the change from grass-dominated steppe to less productive moss-dominated tundra at the end of the Pleistocene (Zimov *et al.* 1995). Changes in abundance of reindeer or herding practices in Russia and Scandinavia greatly influence lichen cover and, therefore, the vegetation structure and productivity of these landscapes (Andreev 1978). Geese and other waterfowl determine productivity, nitrogen input and cycling rates, and disturbance regimes, in Arctic salt marshes (Jefferies and Bryant 1995), and recent changes in the abundance of geese have totally altered the structure and dynamics of these coastal ecosystems. Little is known about the ecosystem impacts of possible changes in pollinator abundances. Insect-pollinated species are concentrated in areas of vertical relief, which contribute little to carbon storage or methane flux but are important in slope stability.

6.1.1.8 Microbial activities

Human impacts on biodiversity. Human impacts on microbial activity are mediated primarily by changes in species composition and litter quality (see productive capacity) and secondarily by the introduction of contaminants from oil spills and pollution.

Ecosystem consequences of impacts. Most Arctic and alpine ecosystems have a similar spectrum of enzymatic potentials to degrade common substrates such as lignin, cellulose and proteins, despite large differences in litter chemical composition (Schimel 1995). Ecosystems do differ, however, in their capacity to produce or consume methane, petroleum products and many anthropogenic pollutants. Changes in microbial diversity are thus more likely to be important in the production and degradation of unusual substrates than in the normal processing of plant litter and soil organic matter.

6.1.1.9 Summary and relevance to human activities

Arctic and alpine ecosystems are particularly vulnerable to human impacts on species diversity, because there are few species in the most widespread vegetation types, so the loss or gain of even one or two species has a large proportional impact on diversity. Furthermore, landscape diversity is easily altered by human impact, due to the sensitivity to disturbance of steep alpine slopes and the sensitivity of Arctic soils to permafrost degradation. Resulting ecosystem changes affect local inhabitants primarily by reducing the productivity of various animal species (reindeer, marine mammals, fish) on which they depend. In alpine and down-slope ecosystems, these changes influence run-off, landslide danger and the quality of drinking water. Other effects of human-induced changes on Arctic and alpine ecosystems are indirect, resulting from potential positive

feedbacks of CO₂ and CH₄ emissions to climate warming. Because human impacts on the Arctic and alpine regions originate primarily outside these regions, they are generally decoupled from, and unresponsive to, the effects they cause.

References

- Andreev, V.N.** (ed.) 1978. *Seasonal and Weather-Related Dynamics of Phytomass in the Subarctic Tundra*. Nauka, Siberian Section, Novosibirsk.
- Billings, W.D.** 1973. Arctic and alpine vegetation: similarities, differences, and susceptibility to disturbance. *BioScience* **23**: 697–704.
- Bonan, G.B., Pollard, D. and Thompson, S.L.** 1992. Effects of boreal forest vegetation on global climate. *Nature* **359**: 716–718.
- Briffa, K.R., Bartholin, T.S., Eckstein, D., Jones, P.D., Karlen, W. and Schweingruber, F.H.** 1990. A 1,400-year tree-ring record of summer temperatures in Fennoscandia. *Nature* **346**: 434–439.
- Chapin, F.S., III, Miller, P., Billings, W.D. and Coyne, P.I.** 1980. Carbon and nutrient budgets and their control in coastal tundra. In: Brown, J., Miller, P.C., Tieszen, L.L. and Bunnell, F.L. (eds), *An Arctic Ecosystem: The coastal tundra at Barrow, Alaska*. 458–482. Dowden, Hutchinson, and Ross, Stroudsburg.
- Chapin, F.S., III and Shaver, G.R.** 1985. Individualistic growth response of tundra plant species to environmental manipulations in the field. *Ecology* **66**: 564–576.
- Chapin, F.S., III, Shaver, G.R., Giblin, A.E., Nadelhoffer, K.G. and Laundre, J.A.** (1995). Response of arctic tundra to experimental and observed changes in climate. *Ecology* (in press).
- D'Arrigo, R., Jacoby, G.C. and Fung, I.Y.** 1987. Boreal forests and atmosphere–biosphere exchange of carbon dioxide. *Nature* **329**: 321–323.
- Fukuda, M.** 1994. Occurrence of ice-complex (edoma) in Lena River delta region and Big Lhyavosky Island, high arctic eastern Siberia. In: Inoue, G. (ed.), *Proceedings of the Second Symposium on the Joint Siberian Permafrost Studies between Japan and Russia in 1993*. 5–13, Isebu, Ibaraka, Japan.
- Grabherr, G., Gottfried, M. and Pauli, H.** 1994. Climate effects on mountain plants. *Nature* **369**: 448.
- Inouye, D.W., and McGuire, A.D.** 1991. Effects of snowpack on timing and abundance of flowering in *Delphinium nelsonii*: implications for climate change. *American Journal of Botany* **78**: 997–1001.
- Jefferies, R.L., and Bryant, J.P.** 1995. The plant-vertebrate herbivore interface in arctic tundra ecosystems. In: Chapin, F.S., III and Körner, C. (eds), *Arctic and Alpine Biodiversity: Patterns, causes, and ecosystem consequences*. 269–279. Springer-Verlag, Berlin.
- Kling, G.** 1995. Land-water interactions: the influence of terrestrial diversity on aquatic ecosystems. In: Chapin, F.S., III and Körner, C. (eds), *Arctic and Alpine Biodiversity: Patterns, causes and ecosystem consequences*. 295–308. Springer-Verlag, Berlin.
- Körner, C., Diemer, M., Schappi, B. and Zimmermann, L.** 1995. The response of alpine vegetation to elevated CO₂. In: Koch, G.W. and Mooney, H.A. (eds), *Terrestrial Ecosystem Response to Elevated CO₂*. Academic Press, New York.
- Lechowicz, M.J.** 1987. Resistance of the caribou lichen *Cladonia stellaris* (Opiz.) Brodo to growth reduction by simulated acidic rain. *Water, Air and Soil Pollution* **34**: 71–77.
- Nadelhoffer, K.J., Giblin, A.E., Shaver, G.R. and Laundre, J.A.** 1991. Effects of temperature and substrate quality on element mineralization in six arctic soils. *Ecology* **72**: 242–253.
- Oechel, W.C., and Billings, W.D.** 1992. Effects of global change on the carbon balance of arctic plants and ecosystems. In: Chapin F.S., III, Jefferies, R.L., Reynolds, J.F., Shaver, G.R. and Svoboda, J. (eds), *Arctic Ecosystems in a Changing Climate: An ecophysiological perspective*. 139–168. Academic Press, San Diego.
- Oechel, W.C., Cowles, S., Grulke, N., Hastings, S.J., Lawrence, W., Prudhomme, T., Riechers, G., Strain, B., Tissue, D. and Vourlitis, G.** 1994. Transient nature of CO₂ fertilization in arctic tundra. *Nature* **371**: 500–503.
- Oechel, W.C., Hastings, S.J., Vourlitis, G., Jenkins, M., Riechers, G. and Grulke, N.** 1993. Recent change of Arctic tundra ecosystems from a net carbon dioxide sink to a source. *Nature* **361**: 520–523.
- Pastor, J., Dewey, B., Naiman, R.J., McInnes, P.F. and Cohen, Y.** 1993. Moose browsing and soil fertility in the boreal forests of Isle Royale National Park. *Ecology* **74**: 467–480.
- Peterson, B.J., Deegan, L., Helfrich, J., Hobbie, J., Hullar, M., Moller, B., Ford, T., Hershey, A., Hiltner Kipphut, G., Lock, M.A., Fiebig, D.M., McKinley, V., Miller, M.C., Vestal, J.R., Ventullo, R. and Volk, G.** 1993. Biological responses of a tundra river to fertilization. *Ecology* **74**: 653–672.
- Reeburgh, W.S. and Whalen, S.C.** 1992. High latitude ecosystems as CH₄ sources. *Ecological Bulletin (Copenhagen)* **42**: 62–70.
- Schimel, J.** 1995. Ecosystem consequences of microbial diversity and community structure. In: Chapin, F.S., III and Körner, C. *Arctic and Alpine Biodiversity: Patterns, causes and ecosystem consequences*. 237–252. Springer-Verlag, Berlin.
- Shaver, G.R., Giblin, A.E., Nadelhoffer, K.J. and Rastetter, E.B.** 1995. Plant functional types and ecosystem change in arctic tundras. In: Smith, T., Shugart, H.H. and Woodward, F.I. (eds), *Plant Functional Types*. Cambridge University Press, Cambridge (in press).
- Tenhunen, J.D., Lange, O.L., Hahn, S., Siegwolf, R. and Oberbauer, S.F.** 1992. The ecosystem role of poikilohydric tundra plants. In: Chapin, F.S., III, Jefferies, R.L., Reynolds, J.F., Shaver, G.R. and Svoboda, J. (eds), *Arctic Ecosystems in a Changing Climate*. 213–237. Academic Press, San Diego.
- Tissue, D.T. and Oechel, W.C.** 1987. Response of *Eriophorum vaginatum* to elevated CO₂ and temperature in the Alaskan tussock tundra. *Ecology* **68**: 401–410.
- Torn, M.S., and Chapin, F.S., III.** 1993. Environmental and biotic controls over methane flux from arctic tundra. *Chemosphere* **26**: 357–368.
- Walker, D.A., Webber, P.J., Binnian, E.F., Everett, K.R., Lederer, N.D., Nordstrand, E.A. and Walker, M.D.** 1987. Cumulative impacts of oil fields on northern Alaskan landscapes. *Science* **238**: 757–761.

- Whalen, S.C. and Reeburgh, W.S. 1992. Interannual variations in tundra methane emission: a 4-year time series at fixed sites. *Global Biogeochemical Cycles* **6**: 139–159.
- Wookey, P.A., Parsons, A.N., Welker, J.M., Potter, J.A., Callaghan, T.V., Lee, J.A. and Press, M.C. 1993. Comparative responses of phenology and reproductive development to simulated environmental change in sub-arctic and high arctic plants. *Oikos* **67**: 490–502.
- Young, O.R., and Chapin, F.S., III. 1995. Anthropogenic impacts on biodiversity in the Arctic. In: Chapin, F.S. III and Körner, C. (eds.) *Arctic and Alpine Biodiversity: Patterns, causes, and ecosystem consequences*. 181–193. Springer-Verlag, Berlin.
- Zimov, S.A., Chuprynin, V.I., Oreshko, A.P., Chapin F.S., III, Reynolds, J.F. and Chapin, M.C. (1995). Steppe–tundra transition: an herbivore-driven biome shift at the end of the Pleistocene. *American Naturalist* (in press).
- Zimov, S.A., Semiletov, I.P., Davidov, S.P., Voropaev, L.V., Prosyannikov, S.F., Wong, C.S. and Chan, Y.H. 1993a. Wintertime CO₂ emission from soils of northeastern Siberia. *Arctic* **46**: 197–204.
- Zimov, S.A., Zimova, G.M., Daviodov, S.P., Daviodova, A.I., Voropaev, Y.V., Voropaeva, Z.V., Prosiannikov, S.F., Prosiannikova, O.V., Semiletova, I.V. and Semiletov, I.P. 1993b. Winter biotic activity and production of CO₂ in Siberian soils: a factor in the greenhouse effect. *Journal of Geophysical Research* **98D**: 5017–5023.

6.1.2 Tropical forests

6.1.2.1 Introduction

Tropical forests grow in frost-free regions between the Tropic of Cancer and the Tropic of Capricorn. In the New World, evergreen forests of the humid tropics extend from the border of the San Luis Potosí–Veracruz States of Mexico (Dirzo and Miranda 1991a), south to the east coast of Brazil. In Africa, these forests are confined to the Guinea coast, the Zaire Basin and the eastern part of Madagascar. In Asia, they are found in the monsoon areas north to the southern slopes of the Himalayas, in southeastern India, and in Malaysia, Indonesia, the Philippines, Thailand, and New Guinea. Evergreen tropical forests extend south in a narrow discontinuous strip on the east coast of Australia.

Most tropical forest regions, even the wettest ones, have dry seasons during which one to several months may receive <100 mm of rain. Only in Malaysia and Indonesia are there large areas that are always wet (i.e. >100 mm of rainfall per month) (Walter 1973). Tropical areas with longer dry seasons are typically found poleward from wet forest regions, but they also exist in regions that are dry for topographic reasons. If these areas have not been heavily disturbed, they support moist and dry deciduous forests. In tropical and subtropical regions with lengthy dry seasons, rainfall reaches its maximum at the time the sun is at its zenith; the winter months, which are only slightly cooler than the summer months, are relatively dry.

Rainfall increases with elevation on the slopes of tropical mountains except in areas that lie in the lee of tall mountains. Clouds form on most days around 1500 metres above sea level, with the result that cloud forests prevail between 1000 and 2500 m on mountain slopes. Precipitation decreases rapidly above the cloud belt. Forests above the cloud zone have short stature and the leaves of trees are smaller and more xeromorphic than those at lower elevations. Above these low-stature forests is a zone dominated by scleromorphic shrubs (Grubb 1977).

One of the most distinctive features of tropical forests is their biological richness, particularly in numbers of species. The world records for species richness are 473 tree species (considering only individuals with a diameter at breast height (dbh) of 10 cm or more) in a 1 hectare plot in Amazonian Ecuador (Valencia *et al.* 1994), which supersedes the previously known and highly publicized record of 300 woody species (trees and lianas dbh >10 cm) in a 1 ha plot in Ecuador (Gentry 1988) (see also Section 3.2 and Latham and Ricklefs (1993) for an analysis of tree species diversity) and 1200 species of beetle collected from a single tree species in Panama (Erwin 1982). Fourteen of the 18 areas on Earth with unusually high degrees of plant endemism lie within the moist tropics. Their collective expanse, which is smaller than California, constitutes less than 5% of the remaining undisturbed forests. These forests contain more than 37 000 endemic plant species, or 15% of all plant species, in less than 311 000 km², or just 0.2% of the Earth's land surface (Myers 1988, 1990). Plant life-forms are also exceedingly diverse in tropical forests and include trees, shrubs, herbs, epiphytes, hemi-epiphytic trees, epiphytic cacti, terrestrial and climbing palms, climbing herbs, bamboos and more (Richards 1952; Whitmore 1975; Gentry 1990). These impressive figures of tropical biodiversity should not conceal the fact that our current knowledge is still very limited. Two splendid accounts of our ignorance on this subject are those of Gentry (1992) for plants and Gaston (1991) for insects. The following statements taken from these two sources provide compelling examples. In the supposedly well-collected region of Iquitos, Peru, nearly 70% of extracted timber comes from a tree first described in 1976, and the most common climbing species in the inundated forests of this area was first discovered in 1976. For insects, estimates of the proportion of tropical species still not described range from a low of perhaps 65%, to a high of 99% (see Section 3.1.2).

For unknown reasons, these forests are relatively resistant to invasions; invaders tend to be restricted to disturbed rather than natural areas (Rejmanek 1989; Whitmore 1991).

6.1.2.2 Human impacts on biodiversity

Considerable attention has been directed towards tropical forests because their rate of loss is currently very high (Myers 1989; Lanly *et al.* 1991; Whitmore and Sayer

1992). According to the last published calculations of FAO (1990), tropical closed forests were being destroyed at a rate of at least 110.5 million ha per year. Rates of loss of forest cover vary greatly by continent and habitat type, and true deforestation rates are difficult to determine because satellite data are incomplete and ground truthing is available for relatively few areas (Myers 1994). In Central America, more than 95% of tropical dry forest has been converted to agriculture, whereas a much higher percentage of evergreen humid forest still remains (Janzen 1988). If recent rates of destruction of tropical forests continue, massive extinctions of populations and species are expected to occur in the coming years and decades (Wilson 1992; Whitmore and Sayer 1992).

The extensive conversion of forests to pastures and agricultural lands as well as shifting cultivation and forestry plantations in Southeast Asia greatly reduce biodiversity at both local and landscape scales. Few of the many species that make tropical forests the richest habitat type on Earth can survive in the croplands, pastures or second-growth forests that replace the forests. However, some of them can be extremely successful in those habitats (e.g. *Cecropia* spp. and *Ochroma pyramidale*, among other plants (Gómez-Pompa and Kaus 1992). In addition, because of their narrow ranges many tropical species are vulnerable to extinction from loss of forests in local areas. For example, many species of cloud forest plants in tropical Latin America are endemic to isolated sites smaller than 10 km² (Gentry 1992) while among the birds of tropical forests in South America, 440 species (25% of the total) have ranges of less than 50 000 km². In contrast, only eight species (2% of the total) of bird species in the United States and Canada have such restricted ranges (Terborgh and Winter 1980).

6.1.2.3 Productive capacity, biomass, decomposition and nutrient cycling

Primary productivity of tropical forests is apparently positively correlated with plant species richness only when the number of species is far below that which characterizes most mainland tropical forests, even those that are fragmented and highly disturbed (Vitousek and Hooper 1993; Wright in press). However, some tropical forests, especially those growing on unusual soils, are dominated by one or a few species of trees (Connell and Lowman 1989; Hart 1990). Examples include *Mora excelsa* stands adjacent to mangrove forests (Richards 1952); *Eperua* forests in South America (Richards 1952; Klinge and Medina 1978; Klinge and Herrera 1983; Herrera *et al.* 1984; Cuevas and Medina 1988), and the *Pterocarpus officinalis* or *Celaenodendron mexicanum* forests of Mexico (Martijena 1993). These forests have not been studied well enough to determine whether their productive capacity is influenced by their low species richness. Recent

studies have failed to detect significant differences in nutrient levels of soils between forests dominated by *Celaenodendron mexicanum* and adjacent mixed (diverse) patches of seasonally dry forests (Martijena 1993) or between evergreen forests dominated by single species and mixed forests in India (Kadambi 1942), Zaire (Hart *et al.* 1989; Hart 1990) and Malaysia (Whitmore 1975).

None the less, biodiversity may influence tropical forest productivity if there is much variation in weather and if disturbances are relatively frequent or severe. Annual productivity is higher and less variable in species-rich than in species-poor temperate grasslands because some species perform better during wet years, while others do better during dry years (Tilman and Downing 1994). It is possible that a similar variation in performance occurs among tropical trees, but we are unaware of any relevant data. Gathering such data may be difficult because little variation is expected in the number of leaves produced per unit area. The rate of biomass accumulation depends strongly on the nature and intensity of disturbance, and species differ in the speed with which they respond to disturbances. Therefore, although there are no data available to test the hypothesis, species richness may influence the rate at which biomass accumulates after disturbance (Denslow 1995).

The consequences of forest disturbance for ecosystem productivity and nutrient cycling depend on the scale and frequency of the disturbance. In the Atlantic lowlands of Costa Rica, intermediate-scale experimental clear-cutting of forests on residual soils resulted in rapid, short-term increases in nutrient concentrations in soil solutions, increased percolation of water through the soil, and increased losses of soil nutrients (Parker 1994). With no additional disturbance, the large pulse of nutrients lost below the rooting zone in percolating water was transient: concentrations returned to pre-disturbance levels in less than two years. Small-scale disturbances, such as in natural or artificial treefall gaps, do not result in increased soil nutrient availability (Vitousek and Denslow 1986) or solution losses (Parker 1994) compared to the intact forest. On the other hand, large-scale, long-term conversion of forests to grasslands or cropland results in major changes in nutrient pools and the soil biota (Olson 1963; Hamilton and King 1983; Macedo and Anderson 1993; Henrot and Robertson 1994). In combination with extraction of nutrients in harvested biomass, these changes cause the productivity of the transformed tropical agro-ecosystems to decrease rapidly.

Litter decomposes so rapidly on the floor of lowland tropical wet forests that there is no interannual accumulation of decomposing litter (Barrow 1991). Hence, tropical trees may not influence the development of soil profiles in highly species-specific ways as strongly as they do in high-latitude forests. However, tropical trees differ markedly in tissue chemistry (Rodin and Basilevich 1967;

Golley 1983a, b), suggesting that they differ in what they remove from the soil and what they deposit on the soil surface. Soils under the legume *Pentaclethra maculosa* at La Selva, Costa Rica, have lower pH values than soils away from individuals of this species, presumably because the trees fix nitrogen, which is then nitrified (Parker 1994). Soils under female *Trophis involucrata* individuals have higher phosphorus concentrations than soils under males (Cox 1981). The meager evidence so far available suggests that trees of different species may generate significant differences in the soils in the areas affected by their roots and litter fall, but whether these differences are important for regeneration, growth, species richness and productivity of tropical forests remains to be determined (Parker 1994).

6.1.2.4 Water distribution, balance and quality

Deforestation, agricultural practices and soil erosion reduce landscape complexity and diversity and also result in the pollution of many rivers and streams that flow through tropical forests. Pollution can alter species diversity and trophic dynamics considerably, as in the case of lead- and mercury-polluted segments of the Orinoco River caused by gold mining (Pfeiffer and De Lacerda 1988).

Alteration of landscape structure and diversity affect water distribution and balance in terms of the seasonal variation in runoff to rivers and lakes and associated nutrient inputs. Water distribution and quality are also affected by the type of management techniques and the diversity components associated with management practices. For example, in a seasonally dry forest in Mexico, soil erosion within the forest was negligible (< 2 Mg/ha/yr), whereas conversion to maize and grassland increased erosional losses up to 130 Mg/ha/yr (Maass *et al.* 1988). In this study, as much as 185 k/ha of nitrogen, 27 k/ha of phosphorus, and 378 k/ha of calcium were lost via erosion within a year of deforestation, whereas less than 0.1 k/ha of each element was lost from the intact forest. Presumably, the nutrients eroded from deforested soils end up in neighbouring rivers and lakes where they alter water quality. In addition, runoff from cut-over forests leads to erosion along tropical coasts, which may cause death to corals.

6.1.2.5 Atmospheric properties and feedback

Tropical deforestation and subsequent conversion to other simplified systems (largely grasslands) lead to changes in the rates of fixation and storage of carbon in vegetation. Tropical forest destruction and burning is currently a net source of atmospheric CO₂, but this is due to reduction of the total acreage of forests and to extensive burning (Detwiler and Hall 1988; Hall and Uhlig 1991; Houghton 1991) and not to loss of species *per se*. In general, tropical wet forest deforestation contributes more to carbon emissions than does cutting of seasonally dry forests

(Masera *et al.* 1992). Conversion to grassland, the most common type of forest conversion in the tropics, contributes the largest amounts of carbon emissions (Masera *et al.* 1992). Because tropical plantations can and do accumulate carbon at rates similar to those of natural species-rich forests (Cuevas *et al.* 1991; Ewel *et al.* 1991; Lugo 1992), there is no reason to expect that carbon budgets of tropical forests are strongly influenced by species richness.

Tropical wetland areas are a major global source of methane, but upland tropical soils can be significant methane sinks. Conversion of upland tropical forests to agriculture can transform these soils from methane sinks to net methane sources. Agricultural activities and development projects that alter, destroy or create (artificial) tropical wetlands also affect biodiversity components of these systems with potential atmospheric effects. Methanogenic bacteria in tropical wetlands are responsible for 60% of the total global methane emissions from natural sources, but gut symbionts of termites are also a significant source of methane (Wassmann *et al.* 1992; but see Martius *et al.* 1993). How emission rates of methane and other chemicals vary with biodiversity is unknown, though ongoing research indicates that emission rates vary with the species of termite.

6.1.2.6 Landscape and waterscape structure

Deforestation is dramatically altering tropical forest landscapes and waterscapes (Shukla *et al.* 1990). However, although deforestation is causing reductions in species diversity, there is no evidence that species loss is, in turn, influencing the structure of landscapes or waterscapes. It has been established that, in Amazonia, tropical landscape modification in the form of transformation of forest to grassland may alter local climate, particularly through the intensification of rainfall seasonality (Shukla *et al.* 1990).

6.1.2.7 Biotic linkages and species interactions

Deforestation, fragmentation and isolation, edge effects, contemporary defaunation (*sensu* Dirzo and Miranda 1991a), and reduction of forest habitat size (Lovejoy *et al.* 1986) have profound effects on biotic linkages and species interactions. Most tropical plants are animal-pollinated (Bawa 1979; Bawa and Beach 1981; Baker *et al.* 1983; Bawa and Hadley 1990); they are fed upon by a wide variety of generalist and specialist herbivores (Dirzo 1987); and they also depend upon animals for dispersal of their seeds (see Estrada and Fleming 1986). Flowering plant species inhabiting forest fragments can experience severely reduced rates of pollinator visitation which can lead to reduced seed production and/or genetic diversity of progeny (Aizen and Feinsinger 1994a, b). Similar effects may be operating as a consequence of reductions in the abundance of critical pollinators, such as Euglossine bees

in Amazonian forest fragments (Lovejoy *et al.* 1986), or the outright loss of hummingbird species on Panama's Barro Colorado Island (Karr 1982). Reduction or loss of other species or functional guilds as a consequence of forest fragmentation (e.g. seed-dispersing birds and bats) may also affect plant reproductive biology, forest structure and forest dynamics. Fragmentation and isolation also alters the guild of vertebrate seed consumers in fragmented tropical landscapes, thereby affecting floristic composition (Cox *et al.* 1991; Dirzo and Miranda 1991a; Leigh *et al.* 1993). Contemporary defaunation (due to habitat alteration and hunting) of medium- to large-sized understorey vertebrates is correlated with local reductions of floristic diversity and the occurrence of monospecific seedling carpets in tropical forests (Dirzo and Miranda 1991b). Although the long-term ecosystem consequences of such changes have not been studied, biodiversity disruptions such as defaunation and creation of local monocultures probably affect patterns of litterfall deposition and possibly nutrient dynamics. Long-term ecosystem consequences of alterations of biotic diversity in the tropics warrant further study.

Secondary productivity is potentially highly sensitive to species richness because different plants allocate their primary production in highly distinctive ways. Plant species differ strikingly in the proportion of primary production allocated to defences; which defensive compounds are synthesized; the quantities and composition of tissues that function to attract mutualists (Coley *et al.* 1985; Davidson *et al.* 1991) and the chemical composition of their wood. Because tropical climatic conditions allow heavy herbivore pressure throughout the year, tropical woody plants allocate relatively large amounts of energy to the production of chemical defences (Levin 1978; Levin and York 1978; McKey 1979) and to the production of resources that attract predators and parasites of herbivores (Simms 1992). Consumers may increase primary productivity by maintaining individual plants and plant populations in rapid growth phases, by reducing the accumulation of living plant biomass, by reducing respiratory losses, and by recycling nutrients, but the relatively small amount of new primary production typically consumed by herbivores in tropical forests probably has little effect on total net primary production (Huston 1994).

'Mobile link' species (i.e. animals necessary for the persistence of plant species that in turn support otherwise separate food webs – Gilbert 1980, pp. 19–20), such as pollinators, seed dispersal agents and plant defence mutualists, alter fluxes of energy and materials very little in ecological time, but they may be critical to the maintenance of the species richness of tropical forests. Many species in tropical forests depend upon a small suite of frugivores for dispersing their seeds. Loss of these species, many of which disappear when forests are fragmented, may

adversely affect the long-term population viability of many tree species (Howe and Smallwood 1982; Terborgh 1986).

6.1.2.8 Microbial activities

Fungi and bacteria are involved in a wide range of fundamental processes in tropical ecosystems, from global geochemistry to decomposition and nutrient cycling (Hawksworth *et al.* 1996). However, the taxonomy of tropical microbes is so poorly understood that we know very little about the functional roles played by individual taxa and how sensitive ecosystem processes are to human-induced deletions of these species. Although we know very little about the effects of tropical deforestation on microbial biodiversity, it is clear that microbial activity declines considerably in cleared areas. One possible way in which microbial activity may be affected is by differential effects of human activities on plant species that associate with nitrogen-fixing bacteria, but there is no evidence of such effects in tropical forests. However, we speculate that in forests remaining near deforested areas the edge effect, which is known to increase tree falls and forest turnover rates, may indirectly affect microbial diversity through the creation of advancing fronts of secondary plant species, with leaf chemistry and litterfall characteristics different from those of the mature forest. Deforestation and fragmentation which threaten the entire guild of nitrogen-fixing microbes may directly affect productivity and nutrient cycling in tropical forests.

In mature forest patches, in comparison to gaps, plants grow slowly, use nutrients efficiently, and produce relatively low-quality litter that decomposes slowly and may deter litter herbivores. Gap pioneer species, in contrast, grow rapidly, produce comparatively more degradable litter, and are easier to use by litter feeders — thus enhancing rates of nutrient cycling (Hobbie 1992). In addition, positive feedbacks to nutrient cycling may arise due to species differences in carbon deposition and competition with microbes for nutrients in the rhizosphere.

6.1.2.9 Summary and relevance to human activities

Humans are impacting biodiversity in tropical systems primarily through forest destruction, largely for conversion to pastures, cropland and plantations. Current rates of habitat loss and associated species loss are higher in tropical regions than elsewhere in the world (Janzen 1988; Raven 1988; Whitmore and Sayer 1992). Reductions of intraspecific genetic diversity are poorly documented, but they are certainly taking place, perhaps at a very serious level. Other human activities that affect biodiversity and ecosystem functioning include water pollution and development projects such as dams, but the ecosystem consequences of such perturbations are poorly known. It is sometimes assumed that the profusion of species in tropical forests may compensate for the loss of some or many of

them. However, given the paucity of data on many critical aspects of the relationships between biodiversity and ecosystem processes, such an assumption is unwarranted and may be dangerous.

References

- Aizen, M.A., and Feinsinger, P. 1994a. Habitat fragmentation, native insect pollinators, and feral honey bees in Argentine "Chaco Serrano". *Ecological Applications* **4**: 378–392.
- Aizen, M.A., and Feinsinger, P. 1994b. Forest fragmentation, pollination, and plant reproduction in a chaco dry forest, Argentina. *Ecology* **75**: 320–341.
- Baker, H.W., Bawa, K.S., Frankie, G.W. and Opler, P.A. 1983. Reproductive biology of plants in tropical forests. In: Golley, F.B. (ed.), *Tropical Rain Forest Ecosystems: Structure and function*. 183–215. Elsevier.
- Barrow, C.J. 1991. *Land Degradation*. Cambridge University Press, Cambridge.
- Bawa, K.S. 1979. Breeding systems of trees in a tropical wet forest. *New Zealand Journal of Botany* **17**: 521–524.
- Bawa, K.S. and Beach, J.H. 1981. Evolution of sexual systems in flowering plants. *Annals of the Missouri Botanical Garden* **68**: 254–274.
- Bawa, K.S. and Hadley, M. (eds) 1990. *Reproductive Ecology of Tropical Forest Plants*. UNESCO, Paris and Parthenon, London.
- Coley, P.D., Bryant, J.P. and Chapin, F.S. 1985. Resource availability and plant antiherbivore defense. *Science* **230**: 895–899.
- Connell, J.H. and Lowman, M.D. 1989. Low-diversity tropical rain forests: Some possible mechanisms for their existence. *American Naturalist* **134**: 88–119.
- Cox, P.A. 1981. Niche partitioning between sexes of dioecious plants. *American Naturalist* **117**: 295–307.
- Cox, P.A., Elmqvist, T., Pierson, E. D. and Rainey W.E. 1991. Flying foxes as strong interactors in South Pacific island ecosystems: a conservation hypothesis. *Conservation Biology* **5**: 448–454.
- Cuevas, R., Brown, S. and Lugo, A.E. 1991. Above- and below-ground organic matter storage and production in a tropical pine plantation and a paired broadleaf secondary forest. *Plant and Soil* **35**: 257–268.
- Cuevas, E. and Medina, E. 1988. Nutrient dynamics within amazonian forest ecosystems. II. Root growth, organic matter decomposition and nutrient release. *Oecologia* **76**: 222–235.
- Davidson, D.W., Foster, R.B., Snelling, R.R., and Lozada, P.W. 1991. Variable composition of tropical ant-plant symbioses. In: Price, P.W., Lewinsohn, T.M., Fernandes, G.W. and Benson, W.W. (eds), *Plant-Animal Interactions*. 145–163. John Wiley, New York.
- Denslow, J.S. 1995. The effects of diversity on disturbance ecology of tropical forests. In: Orians, G.H., Dirzo, R. and Cushman, J.H. (eds), *Diversity and Processes in Tropical Forest Ecosystems*. Springer-Verlag, Berlin, (in press).
- Detwiler, R.P. and Hall, C.A.S. 1988. Tropical forests and the global carbon cycle. *Science* **239**: 42–47.
- Dirzo, R. 1987. Estudios sobre interacciones planta-herbívoro en Los Tuxtlas, Veracruz. *Revista de Biología Tropical* **35**: 119–131.
- Dirzo, R. and Miranda, A. 1991a. Altered patterns of herbivory and diversity in the forest understory: a case study of the possible consequences of contemporary defaunation. In: Price, P.W., Lewinsohn, T.M., Fernandes, G.W. and Benson, W.W. (eds), *Plant-Animal Interactions*. 273–287. John Wiley, New York.
- Dirzo, R. and Miranda, A. 1991b. El límite boreal de la selva tropical húmeda en el continente Americano. *Interciencia* **16**: 240–247.
- Erwin, T.L. 1982. Tropical forests: their richness in coleoptera and other arthropod species. *Coleopterists Bulletin* **36**: 74–75.
- Estrada, A. and Fleming, T.H. (eds) 1986. *Frugivores and Seed Dispersal*. Junk Publishers, Dordrecht.
- Ewel, J.J., Mazzarino, M.J. and Berish, C.W. 1991. Tropical soil fertility changes under monocultures and successional communities of different structure. *Ecological Applications* **1**: 289–302.
- Food and Agriculture Organisation of the UN 1990. *Interim report on forest resources assessment, 1990 Project*. Committee on Forestry, COFO-90/8(a). FAO, Rome.
- Gaston, K.J. 1991. The magnitude of global insect species richness. *Conservation Biology* **5**: 283–296.
- Gentry, A.H. 1988. Tree species richness of open Amazonian forests. *Proceedings of the National Academy of Science* **85**: 156–159.
- Gentry, A.H. (ed.) 1990. *Four Neotropical Forests*. Yale University Press, New Haven, Conn.
- Gentry, A.H. 1992. Tropical forest biodiversity: distributional patterns and their conservational significance. *Oikos* **63**: 19–28.
- Gilbert, L.E. 1980. Food web organization and conservation of neotropical diversity. In: Soulé, M.E. and Wilcox, B. (eds), *Conservation Biology* 11–33. Sinauer Associates, Sunderland, Mass.
- Golley, F.B. 1983a. The abundance of energy and chemical elements. In: Golley, F.B. (ed.), *Ecosystems of the World*, Vol. 14A. *Tropical Rain Forest Ecosystems*. 101–115. Elsevier Scientific, Amsterdam.
- Golley, F.B. 1983b. Nutrient cycling and nutrient conservation. In: Golley, F.B. (ed.), *Ecosystems of the World* Vol. 14A. *Tropical Rain Forest Ecosystems*, 137–156. Elsevier Scientific, Amsterdam.
- Gómez-Pompa, A. and Kaus, A. 1992. Taming the wilderness myth. *BioScience* **42**: 271–279.
- Grubb, P.J. 1977. Control of forest growth and distribution on wet tropical mountains; with reference to mineral nutrition. *Annual Review of Ecology and Systematics* **8**: 83–107.
- Hall, C.A.S. and Uhlig, J. 1991. Refining estimates of carbon released from tropical land-use change. *Canadian Journal of Forestry Research* **21**: 118–131.
- Hamilton, L.S. and King, P.N. 1983. *Tropical Forested Watersheds: Hydrologic and soil responses to major users or conversions*. Westview Press, Boulder, Colorado.
- Hart, T.B. 1990. Monospecific dominance in tropical rain forests. *Trends in Ecology and Evolution* **5**: 6–11.
- Hart, T.B., Hart, J.A. and Murphy, P.G. 1989. Monodominant and species-rich forests of the humid tropics: causes for their co-occurrence. *American Naturalist* **133**: 613–633.

- Henrot, J.** and Robertson, G.P. 1994. Vegetation removal in two soils of the humid tropics: Effect on microbial biomass. *Soil Biology and Biochemistry* **26**:111–116.
- Herrera, H., Medina, E., Klinge, H., Jordan, C.F. and Uhl, C.** 1984. Nutrient retention mechanisms in tropical forests: the Amazon Caatinga, San Carlos pilot project, Venezuela. In: diCasteri, F., Baker, F.W.G. and Hadley, M. (eds), *Ecology in Practice, Part 1: Ecosystem Management*. 85–97, UNESCO, Paris, and Tycooly Int. Publ. Ltd., Dublin.
- Hobbie, S.E.** 1992. Effects of plant species on nutrient cycling. *Trends in Ecology and Evolution* **7**: 336–339.
- Houghton, R.A.** 1991. Tropical deforestation and atmospheric carbon dioxide. *Climatic Change* **19**: 99–118.
- Howe, H. and Smallwood, J.** 1982. Ecology of seed dispersal. *Annual Review of Ecology and Systematics* **13**: 201–228.
- Huston, M.A.** 1994. Biological diversity, soils and economics. *Science* **262**: 1676–1680.
- Janzen, D.H.** 1988. Tropical dry forests: the most endangered major tropical ecosystem. In: Wilson, E.O. and Peters, F.M. (eds), *Biodiversity*. 130–137. National Academy Press, Washington, DC.
- Kadambi, K.** 1942. The evergreen Gath rainforests of the Tunga and Bhadra river sources. *Indian Forester* **68**: 233–240.
- Karr, J.R.** 1982. Avian extinction in Barro Colorado Island, Panama: a reassessment. *American Naturalist* **119**: 220–239.
- Klinge, H. and Herrera, R.** 1983. Phytomass structure of natural plant communities on spodosols in southern Venezuela: the tall Amazon caatinga forest. *Vegetatio* **53**: 65–84.
- Klinge, H. and Medina, E.** 1978. Rio Negro Caatingas and Campinas, Amazonas states of Venezuela and Brazil. In: Specht, R.L. (ed.), *Ecosystems of the World*, Vol. 9. 483–488. Elsevier, Amsterdam.
- Lanly, J.-P., Singh, K.D., and Janz, K.** 1991. FAO's 1990 reassessment of tropical forest cover. *Nature and Resources* **27**: 21–26.
- Latham, R.E., and Ricklefs, R.E.** 1993. Global patterns of tree species richness in moist forests: energy–diversity theory does not account for variation in tree species richness. *Oikos* **67**: 325–333.
- Leigh, E.G. Jr., Wright, S.J., Herre, E.A. and Putz, F.E.** 1993. The decline of tree diversity on newly isolated tropical islands: a test of a null hypothesis and some implications. *Evolutionary Ecology* **7**: 76–102.
- Levin, D.A.** 1978. Alkaloids and geography. *American Naturalist* **112**: 1133–1134.
- Levin, D. A. and York, B.M.** 1978. The toxicity of plant alkaloids: An ecogeographic perspective. *Biochemical Systematics and Ecology* **6**: 61–76.
- Lodge, D.H., Hawksworth, D.L. and Ritchie, B.J.** 1995. Fungal and bacterial diversity in the functioning of tropical forest ecosystems. In: Orians, G.H., Dirzo, R. and Cushman, J.H. (eds), *Diversity and Processes in Tropical Forest Ecosystems*. Springer-Verlag, Berlin (in press).
- Lovejoy, T.E., Bierregaard, R., Ryland, A.B., Malcolm, J.R., Quintela, C.E., Harper, L.H., Brown, K.S., Powell, A.H., Powell, G.N., Schubart, H.O.R. and Hays, M.B.** 1986. Edge and other effects of isolation on Amazon forest fragments. In: Soulé, M. (ed.), *Conservation Biology*. 257–285. Sinauer Associates Sunderland, Mass.
- Lugo, A.E.** 1992. Comparison of tropical tree plantations with secondary forests of similar age. *Ecological Monographs* **62**: 1–41.
- Macedo, D.S. and Anderson, A.B.** 1993. Early ecological changes associated with logging in an Amazonian floodplain. *Biotropica* **25**: 151–163.
- McKey, D.** 1979. The distribution of secondary compounds within plants. In: Rosenthal, G.A. and Janzen, D.H. (eds), *Herbivores: Their interactions with secondary plant metabolites*. 56–133. Academic Press, New York.
- Masera, O., Ordóñez, M.J. and Dirzo, R.** 1992. *Carbon Emissions from Deforestation in Mexico*. Environmental Protection Agency and Lawrence Berkeley Laboratory, University of California, Berkeley.
- Maass, J.M., Jordan, C. and Sarukhán, J.** 1988. Soil erosion and nutrient losses in seasonal tropical agroecosystems under various management techniques. *Journal of Applied Ecology* **25**: 595–607.
- Martijena, N.E.** 1993. *Establecimiento y sobrevivencia de plántulas de especies arbóreas en un bosque tropical decíduo de baja diversidad, dominado por una sola especie*, Ph.D. Thesis, UNAM, Mexico.
- Martius, C., Wassmann, R., Thein, U., Bandeira, A., Renneberg, H., Junk, W. and Seiler, W.** 1993. Methane emission from wood-feeding termites in amazonia. *Chemosphere* **26**: 623–632.
- Myers, N.** 1988. Tropical forests: much more than stocks of wood. *Journal of Tropical Ecology* **4**: 209–221.
- Myers, N.** 1989. *Deforestation Rates in Tropical Countries and Their Climatic Implications*. Friends of the Earth, Washington, DC.
- Myers, N.** 1990. The biodiversity challenge: expanded hot-spots analysis. *The Environmentalist* **10**: 243–256.
- Myers, N.** 1994. Global Biodiversity II: Losses. In: Meffe, G.K. and Carroll, C.R. (eds), *Principles of Conservation Biology*. 110–140. Sinauer Associates, Sunderland, Mass.
- Olson, J.S., Watts, J.A., and Allison, L.J.** 1983. *Carbon in Live Vegetation of Major World Ecosystems*. TR004, US Department of Energy.
- Parker, G.G.** 1994. Soil fertility, nutrient acquisition, and nutrient cycling. In: McDade, L.A., Bawa, K.S., Hespenheide, H.A. and Hartshorn, G.S. (eds), *La Selva. Ecology and natural history of a Neotropical rain forest*, 54–63. University of Chicago Press, Chicago.
- Pfeiffer, W.C. and De Lacerda, L.D.** 1988. Mercury inputs into the Amazon Region, Brazil. *Environmental Technology Letters*. **9**: 325–330.
- Raven, P.H.** 1988. Our diminishing tropical forests. In: Wilson, E.O. and Peters, F.M. (eds), *Biodiversity*. 119–122. National Academy Press, Washington, DC.
- Rejmanek, M.** 1989. Invasibility of plant communities. In: Drake, J.A., Mooney, H.A., di Castri, F., Groves, R. H., Kruger, F.J., Rejmanek, M. and Williamson M. (eds), *Biological Invasions: A global perspective*. SCOPE 37. 369–388. John Wiley, New York.
- Richards, P.W.** 1952. *The Tropical Rain Forest*. Cambridge. Cambridge University Press.
- Rodin, L.E. and Basilevich, N.I.** 1967. *Production and Mineral Cycling in Terrestrial Vegetation*. Oliver and Boyd, Edinburgh.

- Shukla, T., Nobre, C. and Sellers, P.** 1990. Amazon deforestation and climate change. *Science* **247**: 1322–1325.
- Simms, E.L.** 1992. Costs of plant resistance to herbivory. In: Fritz, R.S. and Simms, E.L. (eds), *Plant Resistance to Herbivores and Pathogens*. University of Chicago Press, Chicago.
- Terborgh, J.** 1986. Community aspects of frugivory in tropical forests. In: Estrada, A. and Fleming, T.H. (eds), *Frugivores and Seed Dispersal*. 371–384. Junk Publishers, Dordrecht.
- Terborgh, J. and Winter, B.** 1980. Some causes of extinction. In: Soulé, M.E. and Wilcox, B.A. (eds), *Conservation Biology: An evolutionary–ecological perspective*. 119–134. Sinauer Associates, Sunderland, Mass.
- Tilman, D. and Downing, J.A.** 1994. Biodiversity and stability in grasslands. *Nature* **367**: 363–365.
- Valencia, R., Balslev, H. and Paz y Miño, G.** 1994. High tree alpha-diversity in Amazonian Ecuador. *Biodiversity and Conservation* **3**: 21–28.
- Vitousek, P.M. and Denslow, J.S.** 1986. Nitrogen and phosphorus availability in treefall gaps of a lowland tropical forest. *Journal of Ecology* **74**: 1167–1178.
- Vitousek, P.M. and Hooper, D.U.** 1993. Biological diversity and terrestrial ecosystem biogeochemistry. In: Schulze, E.-D. and Mooney, H.A. (eds), *Biodiversity and Ecosystem Function*. 3–14. Springer-Verlag, Berlin.
- Walter, H.** 1973. *Vegetation of the Earth in Relation to Climate and the Ecophysiological Conditions*. Springer-Verlag, New York.
- Wassmann, R., Thein, U.G., Whiticar, M.J., Rennenberg, H., Seiler, W. and Junk, W.J.** 1992. Methane emission from the Amazon floodplain: characterization of production and transport. *Global Biogeochemical Cycles* **6**: 3–13.
- Whitmore, T.C.** 1975. *Tropical rainforests of the Far East*. Clarendon Press, Oxford.
- Whitmore, T.C.** 1991. Tropical rain forest dynamics and its implications for management. In: Gómez-Pompa, A., Whitmore, T.C. and Hadley, M. (eds), *Tropical Rain Forest Regeneration and Management*. UNESCO, Paris and Carnforth, UK.
- Whitmore, T.C. and Sayer, J.A.** (eds) 1992. *Tropical Deforestation and Species Extinction*. Chapman and Hall, London.
- Wilson, E.O.** 1992. *The Diversity of Life*. Belknap Press, Cambridge, Mass.
- Wright, S.J.** 1995. Plant diversity and ecosystem function in tropical forests. In: Orians G.H., Dirzo, R. and Cushman, J.H. (eds), *Diversity and Processes in Tropical Forest Ecosystems*. Springer-Verlag, Berlin (in press).

North and South America and on the islands of New Zealand and Tasmania. In Western Europe and in the eastern part of the United States and Canada, precipitation is equitably distributed as snow or rain throughout the year. In eastern Asia, under a monsoon climate, most of the precipitation falls in the summer. Along the Pacific coasts of North and South America, where the climate is more Mediterranean, precipitation occurs mainly during the winter months. The forests are dominated by deciduous and, to a lesser extent, evergreen broad-leaf and needle-leaf trees encompassing a potential area of about 18.6×10^6 km² (Melillo *et al.* 1993), more than 50% of which has been converted to cultivation (Matthews 1983). In total, more than 1200 tree species are represented. Differences in history since the Tertiary have caused large variations in tree diversity in the four regions. East Asia, in spite of extensive reduction in forest area, has six times as many species as North America, eight times more than Europe, and eighteen times more than Chile.

6.1.3.2 Productive capacity, biomass, decomposition and nutrient cycling

Human impacts on biodiversity. For centuries the temperate forest regions have experienced intensive human activity. The East Asian forests of China were the first to be largely cleared for agricultural development before 3200 BP (Teng 1927). Clearing followed much later in Europe, North America and much of the Southern Hemisphere (Perlin 1989). In addition, many native forests have been converted to plantations of a few species, largely represented by conifers. Human activities have affected biodiversity in forests to a lesser extent by introducing pests and pathogens, by creating air and water pollution, and by selectively harvesting various products (tree species, game animals, mushrooms and litter). If, through consumption of fossil fuels, humans induce predicted climatic change, the biodiversity of temperate forests as well as other biomes will be substantially altered (Peters and Lovejoy 1992).

Ecosystem consequences of impacts. A major consequence of clearing activities is a reduction in ecosystem carbon stores, in both biomass and soil organic matter. Globally, temperate forests today, although much smaller in extent than originally, are thought to be a net sink for carbon dioxide exchange (Tans *et al.* 1990). If so, this is mainly the result of faster growth rates associated with younger forests (Wofsy *et al.* 1993). The total biomass, both alive and in dead woody material, is much less in young forests than in older ones (Waring and Franklin 1979). Although biodiversity in plantations is usually reduced, growth rates are generally increased due to genetic selection and intensive management. Air and water pollution, pest and pathogens, and most harvesting practices tend to increase the rates at which minerals cycle

6.1.3 Temperate forest systems

6.1.3.1 Introduction

Temperate forest ecosystems of the mid latitudes occupy a climatic zone with pronounced variation in seasonal temperatures. Distribution is mainly in the Northern Hemisphere, in Europe, East Asia and eastern North America. In addition, representatives of this biome exist in a narrow band of rain forest along the Pacific coasts of

and nutrients are lost from the forest ecosystem. Genetic and species diversity is usually sufficient, however, for maintenance of net primary production, given time for re-establishment of a full canopy (Shugart and West 1977). Immediately following forest clearing the microbial system is able to sequester critical nutrients and prevent their loss by leaching (Vitousek and Matson 1985; Griffiths *et al.* 1994).

6.1.3.3 Soil structure and nutrient pools

Human impacts on biodiversity. Frequent disturbances associated with thinning and harvesting activities modify the surface litter and may compact the soil, which causes surface runoff and erosion from steep ground. The increasing use of fertilizers in forestry and agriculture, combined with nitrogen and sulphur in the atmosphere derived from consumption of fossil fuels, add to wet and dry deposition of these elements (Galloway *et al.* 1987). Unpaved roads create dust, and winds distribute calcium, potassium and other elements across wide areas (Hedin *et al.* 1994). Where ozone levels are high, and combine with atmospheric deposition of heavy metals, the recycling of nutrients through decomposition may be slowed, and may eventually limit the production of organic matter (Tyler 1972). Pests and pathogens, on the other hand, have fewer long-term effects and generally increase the rate at which minerals and nutrients cycle through soils (Waring and Schlesinger 1985).

Ecosystem consequences of impacts. The practice of clear-felling all the trees in a watershed temporarily increases the export of nutrients into groundwater, lakes and streams (Likens *et al.* 1978). Unless land is permanently cleared, however, the soil organic matter content is not substantially reduced (Gholz and Fisher 1982). The microbial system associated with shrubs and other vegetation may survive on dead roots and is usually sufficient to prevent immediate mobilization of critical nutrients (Vitousek and Matson 1985). In much of the temperate forest region, where forests are rarely clear-felled, wet and dryfall from air pollution acidifies soils and increases N and S pools. As a result, leaching of cations (Ca, Mg, K) is accelerated and seepage water is enriched in nitrogen (Schulze 1989). Even without atmospheric deposition, monocultures of evergreen species may acidify soils (Last and Watling 1991), although this depends on the type of soil, the species of evergreens (Speirs *et al.* 1986), and the presence of species that may cycle calcium or other elements from deeper soil horizons (Thomas 1959; Attiwell and Adam 1993).

6.1.3.4 Water distribution, balance and quality

Human impacts on biodiversity. Fragmentation of forests causes increased desiccation of canopies into the interior of remaining forests (Saunders *et al.* 1991; Chen *et al.* 1995).

As a result, epiphyte cover is reduced and less precipitation is intercepted by the canopy. Outbreaks of insect defoliators occur more regularly, causing a weakening of the surviving trees which reduces their flower and seed production, which in turn limits the number of vertebrates and invertebrates present. Replacement of deciduous forests with extensive plantations of evergreens increases stream-flow (Swift *et al.* 1975). A closed forest canopy along stream channels prevents the development of an algae-based food chain in the aquatic system (Triska *et al.* 1982). Where forests are frequently cut or where agricultural lands are intermixed with forests, surface and subsoil runoff to streams increases. The runoff carries with it soil, minerals, and often pesticide residues that degrade the stream habitat and reduce species diversity. As a result, spawning habitat for salmon, striped bass and other commercial and sport fisheries has been lost throughout much of the temperate forest region, and surviving populations of fish and other aquatic animals often carry high residues of pesticides.

Ecosystem consequences of impacts. Reduction in the leaf area of forests, and conversion to agricultural or urban development, greatly impact the way in which solar energy is dissipated. At full leaf area, a forest may transpire the equivalent of 3–5 mm water per day. Agricultural crops do not develop a full canopy until mid growing season and are harvested before the end of the normal growing season so that the total surface of foliage available for interception and evaporation is much reduced compared to forested conditions. Urban landscapes transpire or evaporate even less water. Peak storm flow increases following forest disturbance, causing flood damage downstream (Waring and Schlesinger 1985). The shorter stature of vegetation in fields and woodlands that replaces mature forests tends to make the surrounding area warmer (Kelliher *et al.* 1993). A major impact of forest removal is upon streams. Loss of shade increases water temperatures, and harvesting activities reduce the periodic addition to streams of large woody debris that creates pools and enhances the processing of dissolved and particulate organic matter. Increased erosion fills channels and allows silt to accumulate over gravels in which spawning fish lay their eggs. Acidification and pesticide residues further limit the ability of stream organisms to process organic matter and to remove harmful materials.

6.1.3.5 Feedbacks to atmospheric properties

Human impacts on biodiversity. Fragmented landscapes composed of deciduous woodlands, evergreen forests, fields and urban areas, absorb solar radiation differently from a uniform cover of vegetation. With generally less surface area in forest canopy, evaporative cooling is reduced and the meso-scale climate becomes less stable (Pielke *et al.* 1991). Dust and haze created by air pollutants

reduce incident solar radiation. Conversion to plantations of conifers increases the production of hydrocarbons by the vegetation (Chameides *et al.* 1988).

Ecosystem consequences of impacts. The presence of forest cover increases the surface area of exchange for the deposition of aerosols by up to 20 times that of bare ground while the loss of the forest canopy and its epiphyte community allows wider distribution of the aerosol load (Lindberg *et al.* 1986). Haze generated by compounds produced by trees or by human activities diffuses light and increases the efficiency of photosynthesis by plants. The concomitant reduction in solar radiation heats surfaces less and reduces respiration so that net ecosystem carbon balances may not be changed as much as otherwise predicted (Hollinger *et al.* 1994). Evergreen forests reflect less solar energy than deciduous forests (Goward *et al.* 1994). As a result, when separate blocks of deciduous and evergreen forests are present, heat islands develop, which increase afternoon thunderstorm activity (Nicholls *et al.* 1995). Snow that accumulates under evergreen forests will not reflect as much solar radiation as that deposited under deciduous canopies. The presence of snow may also lengthen the start of the growing season by delaying soil warming.

6.1.3.6 Landscape and waterscape structure

Human impacts on biodiversity. Agriculture, urbanization, road building and surface mining throughout temperate forest ecosystems have substantially altered landscape structure and diversity. The building of roads introduces corridors for the transportation of plants, insects and pathogens. Road construction also increases hillslope erosion, which reduces landscape diversity. The removal of forests along the floodplains reduces the capacity of the land to store water, which leads to more rapid runoff and excessive flooding when dam capacities are exceeded. The simplification and instability of floodplain vegetation are increased when unstable slopes are present in upper drainages. In total, the overall diversity of habitats is reduced across a drainage area when forests are fragmented or converted to other uses.

Ecosystem consequences of impacts. The net effect of reduced forest cover is accelerated transfer of soil, organic matter and water into streams, lakes and reservoirs, and because water carries high concentrations of nutrients, eutrophication of waterways results. The general effect is degradation and simplification of aquatic systems. Pollution, and the introduction of nonnative plants, insects and pathogens, make native forests less resilient and thus more sensitive to periodic disturbance and sustained nutrient losses. As a result, the productive capacity of the landscape may be degraded, and in extreme cases prevented from supporting forests (Schulze and Ulrich 1991).

6.1.3.7 Biotic linkages and species interactions

Human impacts on biodiversity. With increased commerce between continents, many insects and pathogens have been introduced into forests without co-evolved biotic controls. For example, virulent pathogens such as Dutch elm disease (*Graphium ulmi*) and chestnut blight (*Endothia parasitica*) have largely removed their respective host trees from the landscape in the eastern US. Gypsy moth (*Lymantria dispar*) and other introduced insects have also caused extensive damage. In addition, invasive plants such as Kudzu (*Pueraria lobata*), a nitrogen-fixing vine, have taken over many areas in the Southeastern USA and restricted the regeneration of forests. When European livestock were introduced into the New Zealand forests they destroyed much of the native vegetation, which was ill-adapted to browsing, and caused excessive compaction of the soil (Veblen and Stewart 1982). Air pollution has greatly reduced the epiphytic component of forest canopies (Hawksworth and Rose 1970) as has the conversion of old-growth forests to younger age classes (Sollins *et al.* 1980). More locally, where road systems are well developed, organisms are readily transported across natural boundaries, often without their biotic controlling agents. Pesticide applications to farmland and forests accumulate in food chains and are particularly harmful to raptors (Carson 1962), and reduction in forest cover, combined with bounty hunting and trapping, has caused the extinction of many large carnivores such as wolves, bears and mountain lions. Keystone species such as beaver and coypu have also been lost. Selective management of forests for particular sizes and types of trees has great consequence for the diversity of all species, as do policies for fire suppression, waste deposition and air pollution. The reduction in the area of forests, together with loss of tree species, has an especially hard impact on bird populations. Birds that migrate between temperate and tropical forests are most affected because they are losing habitat in both biomes (Wilcove 1990). Reduction in bird populations allows defoliating insects to reach epidemic population levels more frequently and thus further endangers the survival of some species of trees (Crawford and Jennings 1989; Mason *et al.* 1983).

Ecosystem consequences of impacts. Continual reduction in forest cover accentuates pollution, erosion and species extinction. Forests managed on short rotations limit diversity: fire protection, on the other hand, may lead to equally unstable conditions where multiple age classes of trees provide excessive accumulation of fuel. Thinning and salvage logging have an important role to play in such situations. Management may also ameliorate the effects of acid rain by liming soils and surface waters and by judicious tree harvesting, careful road construction, and expansion of land conservation policies. Some opportunities for organic matter recycling from urban areas

and agricultural fields into forests may buffer trends, but heavy metal concentrations and excessive applications of fertilizer lead to more polluted streams and ground water. Policies that favour fire protection often result in a change in species composition and a more fire-prone situation than normal. On the other hand, short cutting cycles or selective harvesting of the largest trees reduces habitat niches for many species of vertebrates and invertebrates while increasing the availability of forage for a few species of ungulates (Turner *et al.* 1994). Birds, butterflies and other species that migrate between temperate and tropical forests are particularly sensitive because losses of habitat are occurring in both types of forests. The loss of keystone animals such as beaver and coypu from most of the temperate forests has reduced the area of wetlands and the availability of habitat for fish, birds and other animals. Loss of large carnivores allows populations of ungulates to oscillate more widely, resulting in selective removal of more palatable deciduous shrubs and trees unless hunting pressures are increased accordingly. If headwater forests, floodplain woods and adjacent wetlands can be protected in corridors, some buffering may be provided against erosion and the eutrophication of water bodies, even with expanded use of other lands.

6.1.3.8 Microbial activities

Human impacts on biodiversity. Most temperate forest ecosystems have a large capacity to store nitrogen, but chronic additions may lead to saturation (Aber *et al.* 1994). Deposition of heavy metals in sewage sludge or from atmospheric sources represents an increasing problem near urban areas. Increases in the evergreen component of forests changes the quality of litter for microbial activity, while removal of the litter for bedding, as was done in Europe for centuries, leads to impoverished substrates. Atmospheric additions of S and N encourage microbial activity that converts these elements to gases. At the same time, other functional groups of microbes may be lost, such as N-fixing bacteria and many fungi adapted to low levels of nutrients.

Ecosystem consequences of impacts. Increased enrichment with nitrogen and sulphur may not enhance microbial decomposition if the carbon substrate is inappropriate, particularly if symbiotic fungi (mycorrhizae) become less active on the roots of trees and other plants. On the other hand, denitrification and trace gas production of sulphur compounds is enhanced (Aber *et al.* 1994) unless heavy metal concentrations are sufficient to limit microbial activity. Loss of earthworms due to compaction and acidification reduces mixing and will further limit decomposition rates. Global increases in atmospheric CO₂, however, may result in more carbon being allocated by plants to mycorrhizal fungi, which should enhance nutrient mobilization in the rooting zone. Concomitant changes in

climate may completely alter forest composition and distribution (Neilson and Marks 1994).

6.1.3.9 Summary and relevance to human activities

The dominant effect of human activity on temperate forest ecosystems has been their conversion to agricultural use. Large plantations of single species of conifers and hardwoods, combined with more frequent harvesting, exert a major impact on ecosystem functioning and biodiversity. In the last half-century, air pollution has changed the properties of the atmosphere and precipitation, and this has resulted in the removal of some species, alterations in nutrient cycling, and the creation of ecosystems more susceptible to outbreaks of insects and diseases. Loss of some keystone species and the introduction of others further destabilize temperate forest ecosystems. The full impact of changes in the chemical composition of the atmosphere induced by human activity is not known but if climatic conditions change rapidly, as they are predicted to do, we would expect forests composed of long-lived trees, typically with infrequent seed production, to be particularly vulnerable, along with the complex food chains they support. As a result, we predict largely negative consequences on biodiversity, net primary production, and net ecosystem production with rapid climate change.

References

- Aber, J.D., Magill, A., Boone, R., Melillo, J.M., Steudler, P. and Bowden, R. 1994. Plant and soil responses to chronic nitrogen additions at the Harvard Forest, Massachusetts. *Ecological Applications* **4**: 156–166.
- Attiwill, P.M. and Adams, M.A. 1993. Nutrient cycling in forests. Tansley Review No. 50. *New Phytologist* **124**: 561–582.
- Carson, R. 1962. *Silent Spring*. Crest Books, Greenwich, Conn.
- Chameides, W.L., Lindsey, R.W., Richardson, J. and Kiang, C.S. 1988. The role of biogenic hydrocarbons in urban photochemical smog: Atlanta as a case study. *Science* **95**: 18569–18576.
- Chen, J., Franklin, J.F. and Spies, T.A. 1995. Growing-season microclimatic gradients from clearcut edges into old-growth Douglas-fir forests. *Ecological Applications* **5**: 74–86.
- Crawford, H.S. and Jennings, D.T. 1989. Predation by birds on spruce budworm *Choristoneura fumiferana*: functional, numerical and total response. *Zoology* **70**: 152–163.
- Galloway, J.N., Dianwu, Z., Jiling, X. and Likens, G.E. 1987. Acid rain: China, United States, and a remote area. *Science* **236**: 1559–1562.
- Gholz, H.L. and Fisher, R.F. 1982. Organic matter production and distribution in slash pine (*Pinus elliottii*) plantations. *Ecology* **63**: 1827–1839.
- Goward, S.N., Huemmrich, K.F. and Waring, R.H. 1994. Visible-near infrared spectral reflectance of landscape components in Western Oregon. *Remote Sensing of Environment* **47**: 190–203.
- Griffiths, R.P., Baham, J.E. and Caldwell, B.A. 1994. Soil solution chemistry of ectomycorrhizal mats in forest soil. *Soil Biology and Biochemistry* **26**: 331–337.

- Hawksworth, D.L.** and Rose, F. 1970. Qualitative scale for estimating sulphur dioxide air pollution in England and Wales using epiphytic lichens. *Nature* **227**: 145–148.
- Hedin, L.O., Granat, L., Likens, G.E., Buishand, T.A., Galloway, J.N., Butler, T.J. and Rodhe, H.** 1994. Steep declines in atmospheric base cations in region of Europe and North America. *Nature* **367**: 351–354.
- Hollinger, D.Y., Kelliher, F.M., Byers, J.N., Hunt, J.E., McSeveny, T.M. and Weir, P.L.** 1994. Carbon dioxide exchange between an undisturbed old-growth temperate forest and the atmosphere. *Ecology* **7**: 134–150.
- Kelliher, F.M., Leuning, R. and Schulze, E.-D.** 1993. Evaporation and canopy characteristics of coniferous forests and grasslands. *Oecologia* **95**: 153–163.
- Last, F.T. and Watling, R.** 1991. *Acid Deposition – Its nature and impacts*. The Royal Society of Edinburgh.
- Likens, G.E., Bormann, F.H., Pierce, R.S. and Reiners, W.A.** 1978. Recovery of a deforested ecosystem. *Science* **199**: 492–496.
- Lindberg, S.E., Lovett, G.M., Richter, D.D. and Johnson, D.W.** 1986. Atmospheric deposition and canopy interactions of major ions in a forest. *Science* **231**: 141–146.
- Matthews, E.** 1983. Global vegetation and land use: new high-resolution data bases for climate studies. *Journal of Climate and Applied Meteorology* **23**: 474–487.
- Mason, R.R., Torgersen, T.R., Wickman, B.E. and Paul, H.G.** 1983. Natural regulation of a Douglas-fir tussock moth (Lepidoptera: Lymantridae) population in the Sierra Nevada. *Environmental Entomology* **12**: 587–594.
- Melillo, J.M., McGuire, A.D., Kicklighter, D.W., Moore, B. III, Vorosmarty, C.J. and Schloss, A.L.** 1993. Global climate change and terrestrial net primary production. *Science* **363**: 234–240.
- Neilson, R.P. and Marks, D.** 1994. A global perspective of regional vegetation and hydrologic sensitivities from climate change. *Journal of Vegetation Science* **5**: 715–730.
- Nicholls, M.E., Pielke, R.A., Eastman, J., Finley, C.A., Lyons, W.A., Tremback, C.J., Walko, R.L. and Cotton, W.R.** 1995. Applications of the RAMS numerical model to dispersion over urban areas. In: Cermak, J.E. *et al.* (eds), *Wind Climate in Cities*. 703–732.
- Pielke, R.A., Dalu, G.A., Snook, J.S., Lee, T.J. and Kittel, T.G.F.** 1991. Nonlinear influences of mesoscale land use on weather and climate. *Journal of Climate* **4**: 1053–1069.
- Perlin, J.** 1989. *A Forest Journal: The role of wood in the development of civilization*. W.W. Norton and Co., New York.
- Peters, R.L., and Lovejoy, T.E.** (eds) 1992. *Global Warming and Biological Diversity*. Yale University Press, New Haven, Conn.
- Saunders, D.A., Hobbs, R.J. and Margules, C.R.** 1991. Biological consequences of ecosystem fragmentation: a review. *Conservation Biology* **5**: 18–32.
- Schulze, E.-D.** 1989. Air pollution and forest decline in a spruce (*Picea abies*) forest. *Science* **244**: 776–783.
- Schulze, E.-D. and Ulrich, B.** 1991. Acid rain – a large-scale unwanted experiment in forest ecosystems. *SCOPE* **45**, 8–106.
- Shugart, H.H. and West, D.C.** 1977. Development of an Appalachian deciduous forest succession model and its application to assessment of the impact of the chestnut blight. *Journal of Environmental Management* **5**: 161–179.
- Sollins, P., Grier, C.C., McCorison, F.M., Cromack, K. Jr, and Fogel, R.** 1980. The internal element cycles of an old-growth Douglas-fir ecosystem in western Oregon. *Ecological Monographs* **50**: 261–285.
- Speirs, G.A., Gagnon, D., Nason, G.E., Packee, E.F. and Louiser, J.D.** 1986. Effects and importance of indigenous earthworms on decomposition and nutrient cycling in coastal forest ecosystems. *Canadian Journal of Forest Research* **16**: 983–989.
- Swift, L.W., Swank, W.T., Mankin, J.B., Luxmoore, R.J. and Goldstein, R.A.** 1975. Simulation of evapotranspiration and drainage from mature and clearcut deciduous forests and young pine plantation. *Water Resources Research* **11**: 667–673.
- Tans, P.P., Fung, I.Y. and Takahashi, T.** 1990. Observational constraints on the global atmospheric CO₂ budget. *Science* **247**: 1431–1438.
- Teng, S.-C.** 1927. The early history of forestry in China. *Journal of Forestry* **25**: 564–570.
- Thomas, W.A.** 1959. Accumulation and cycling of calcium by dogwood trees. *Ecological Monographs* **39**: 101–120.
- Triska, F.J., Sedell, J.R. and Gegory, S.V.** 1982. Coniferous forest streams. In: Waring, R.H. (ed.), *Forests: Fresh perspectives from ecosystem analysis. Proceedings, 40th Annual Biological Colloquium*. 171–190. Oregon State University Press, Corvallis.
- Tyler, G.** 1972. Heavy metals pollute nature, may reduce productivity. *Ambio* **1**: 52–59.
- Turner, M.G., Wu, Y., Wallace, L.L., Romme, W.H. and Brenkert, A.** 1994. Simulating winter interactions among ungulates, vegetation, and fire in northern Yellowstone Park. *Ecological Applications* **4**: 472–496.
- Veblen, T.T. and Stewart, G.H.** 1982. The effects of introduced wild animals on New Zealand forests. *Annals of the Association of American Geographers* **72**: 372–397.
- Vitousek, P.M. and Matson, P.A.** 1985. Disturbance, nitrogen availability, and nitrogen losses in an intensively managed loblolly pine plantation. *Ecology* **66**: 1360–1376.
- Waring, R.H., and Franklin, J.F.** 1979. Evergreen coniferous forests of the Pacific Northwest. *Science* **204**: 1380–1386.
- Waring, R.H. and Schlesinger, W.H.** 1985. *Forest Ecosystems: Concepts and management*. Academic Press, Orlando, Fla.
- Wilcove, D.** 1990. Empty skies. *Nature Conservancy Magazine* **40**: 4–13.
- Wofsy, S.C., Goulden, M.L., Munger, J.W., Fan, S.-M., Bakwin, P.S., Daube, B.C., Bassow, S.L. and Bazzaz, F.A.** 1993. Net exchange of CO₂ in a mid-latitude forest. *Science* **260**: 1314–1317.

6.1.4 Arid and semi-arid lands

6.1.4.1 Introduction

In arid lands, water availability (precipitation vs. evaporative demand) imposes severe constraints on biological activity. Precipitation is characterized by unpredictability in time and space as well as by low total amounts (Noy-Meir 1973). Semi-arid ecosystems differ from true arid areas in structure and in the rate and regulation of ecosystem processes. We differentiate between these two, and highlight cases of conversion from semi-arid to arid lands (desertification; Verstraete and

Schwartz 1991). Biodiversity, reflected in species richness, is moderately high in semi-arid regions and declines with increasing aridity for most taxa (Shmida 1985; Pianka and Schall 1981; O'Brien 1993). Certain taxa are diverse relative to other biomes (e.g. predatory arthropods, ants and termites, grasshoppers, snakes and lizards, rodents, annual plants), but there is substantial variation in the richness of particular taxa among the deserts of different continental areas. The abundance and activity of desert organisms are 'pulsed' in correspondence with episodes of high moisture availability (Noy-Meir 1973; Louw and Seely 1982); while the prevalence of dormancy, cryptobiosis, aestivation and other modes of escaping harsh conditions means that most of the biodiversity of arid regions can be impossible to census or sample during most time periods.

6.1.4.2 Productive capacity, biomass, decomposition and nutrient cycling

Human impacts on biodiversity. Human activity has caused changes in the biodiversity of arid lands primarily through the use of arid and semi-arid systems for grazing of livestock. Introductions of domestic and game animals have altered the character and the magnitude of animal consumption (Oesterheld *et al.* 1992), and these have been accompanied by creation of water points, introduction of non-native plants, and removal of predators and of burrowing and herbivorous animals seen as threats to livestock. Plant species diversity decreases when the local extinction of grazing- or trampling-sensitive species exceeds the establishment of new grazing-tolerant or weedy species (Westoby *et al.* 1989; Milchunas and Lauenroth 1993); after a time lag, loss of native plant species may result in a loss of animal taxa (Jones 1981; Jepson-Innes and Bock 1989; Heske and Campbell 1991). In some regions the intensive cultivation of irrigated croplands has eliminated large portions of native ecosystems (Jackson *et al.* 1991).

Ecosystem consequences of impacts. In North America and Africa, semi-arid grasslands have often been converted to shrublands by grazing and by the dispersal of shrub seeds by livestock (e.g. Peinetti *et al.* 1993), leading to a different structure and display of biomass as well as altered species composition (Schlesinger *et al.* 1990). Production will be reduced if grazers remove leaf area and cause an increase in the proportion of water lost to evaporation, rather than being used by plants. However, net primary productivity or NPP (the amount of plant material produced by photosynthesis per unit area over a time period) is not necessarily changed by changes in plant species composition induced by grazing (Milchunas and Lauenroth 1993). Decreases in NPP are most pronounced where there has been no long evolutionary history of intense grazing (Milchunas and Lauenroth 1993). Some semi-arid and arid ecosystems comprise diverse assemblages of different plant

growth forms, physiologies and life histories, which form distinct guilds with respect to water use because of correlations among morphological, phenological and physiological traits (e.g. Golluscio and Sala 1993). Where the members of a guild (e.g. perennial grasses using shallow water during the hot season) respond similarly to a disturbance (e.g. are all grazing-sensitive), the elimination of that functional group will have direct influences on the structure and functioning of the ecosystem. In addition, the importance of macro-organisms in determining microbial populations (Gallardo and Schlesinger 1992) means that removal of plants or alteration of the distribution and abundance of plant roots will alter the pool and rates of activity of decomposers, thus altering rates of decomposition as well as of organic matter inputs. Termites and nest- or burrow-building mammals provide micro-environments that enhance decomposition and nutrient cycling. Their removal by humans has the potential to slow decomposition and increase the chances of loss or transport of nutrients from the surface (Whitford 1991).

Conversion of semi-arid or arid lands to agriculture (usually by irrigation) may increase local NPP values, but the effects on biodiversity are severe. Native plant communities are displaced, and are notoriously difficult to restore after cessation of cultivation (Jackson *et al.* 1991). In India the birds of semi-arid regions have proved especially likely to disappear following cultivation and fragmentation of native habitats (Daniels *et al.* 1990). It is not clear how human activities have altered the role that fire plays in semi-arid regions. In some places fires may have maintained semi-desert grassland, suggesting that grazing (causing the reduction of fuel loads) and fire suppression have contributed to the conversion of grasslands to shrublands. However, in other systems the perennial grasses appear to be more sensitive to fire than the woody plants (Wright 1980), and there is no clear guideline for the use of fire in maintaining grassland or manipulating species composition (Bock and Bock 1992).

6.1.4.3 Soil structure and nutrient pools

Human impacts on biodiversity. Introduction of hooved livestock to regions lacking a recent evolutionary history of ungulate grazing (e.g. Australia, southwestern North America) has been the primary human effect on the biodiversity of semi-arid regions. This has been accompanied by reduction of populations of native burrowing herbivores (e.g. North American prairie dogs, Australian marsupials), thus reducing the soil-disturbing activities of these animals.

Ecosystem consequences of impacts. The introduction of large hooved animals to regions previously lacking them has caused changes in the compaction of soil, reducing infiltration (Roundy *et al.* 1992), while also churning up dry surface soil and increasing its vulnerability to erosion.

Vegetation influences the 'roughness' of the surface, which in turn influences the movement and erosive power of wind and water (e.g. Abrahams *et al.* 1994); thus the activities of livestock (or humans) have direct influences on the rates of erosion of surface layers. Erosion and transport of surface soil particles will in turn influence the transport and loss of mineral nutrients from the site (Schlesinger *et al.* 1990). The soil-binding properties of plant roots are especially critical in dunes, where species that can stabilize sediments serve a critical role in determining ecosystem structure (e.g. Klopatek and Stock 1994). Harvesting or loss of these species may shift a stable substrate (offering habitat for plant and animal populations) to a much harsher migrating dune system. Disruption of a microbial 'crust' on the soil surface (e.g. by hooves) alters inputs of nitrogen by these N-fixers (see 6.1.4.8). Burrowing animals (termites, ants, rodents, marsupials) create and reinforce heterogeneity in soil structure and nutrients (Whitford 1993).

6.1.4.4 Water distribution, balance and quality

Human impacts on biodiversity. Human and livestock activity have altered plant species composition and vegetation cover in many regions, both by reducing native vegetation and by introducing non-native species, either deliberately or accidentally. Aquatic habitats (riparian zones, springs) have been especially vulnerable to invasions of non-native plants. Populations of burrowing organisms have also been reduced. Road construction and other activities have altered drainage patterns, with resulting changes in water distribution and hydrologic regimes: these changes then impact the distribution and behaviour of organisms.

Ecosystem consequences of impacts. Vegetation cover modulates the impact energy of raindrops, reducing the amount of sediment dislodged and transported during heavy storms (Wood *et al.* 1987; Rogers and Schumm 1991). Rooted plants provide root channels which in turn enhance deep percolation of water into the soil profile (e.g. Greene 1992), and the nature of the plant canopy influences the proportion of rainfall that is intercepted and that falls either as throughfall or stem-flow (West and Gifford 1976; Navar and Bryan 1990; Tromble 1987). Deep roots of shrubs, and transpirational losses, are a strong influence on soil water content in the lower parts of the soil profile and thus on the depth of carbonate deposition, leading potentially to alterations in the effective rooting depth of the soil (Schlesinger *et al.* 1987). Removal of shrubs would then be expected to have potentially strong effects on soil moisture content and other characteristics. On the other hand, Dugas and Mayeux (1991) and Carlson *et al.* (1990) found that increased herbaceous cover following shrub removal resulted in little net change in water distribution or in total evapotranspiration from dry rangeland sites over the short term. Introduction of phreatophytic (deep-rooted)

plants, especially the genus *Tamarix*, has dramatically altered hydrology in some riparian systems (Blackburn *et al.* 1982), even leading to the elimination of surface water from previous spring sites due to its high evapotranspiration). Reduction in populations of termites (small burrowing animals) has a dramatic influence on infiltration and surface runoff (Elkins *et al.* 1986).

6.1.4.5 Feedbacks to atmospheric properties

Human impacts on biodiversity. At the global scale, human activity is expressed primarily through direct and indirect alterations of vegetation cover and disturbance of the soil surface.

Ecosystem consequences of impacts. Vegetation cover is negatively associated with albedo. Arid lands are significant determinants of the Earth's overall albedo (Otterman 1989) and thus of its global radiation balance. Arid lands are also significant contributors of dust, and reductions in vegetation cover caused by grazing or other human activity (e.g. roads) increase these contributions (Pewe 1981; Pye 1987). While it has been proposed that arid-zone termites contribute substantial amounts of methane to the atmosphere, recent work suggests that arid regions are actually a significant sink for methane (Striegl *et al.* 1992). Conversion of semi-arid grassland to shrubland or woodland may increase carbon storage, affecting the global carbon cycle (McPherson *et al.* 1993).

6.1.4.6 Landscape structure

Human impacts on biodiversity. Human alterations to semi-arid landscapes are generally to facilitate grazing by livestock: they include fencing of pastures or paddocks, creation of new water points for animals, and construction of roads or trails for transport. Human and livestock activity often creates gradients of disturbance or of alteration (a 'variegated' landscape), rather than the conspicuously patchy or fragmented nature of landscapes in other ecosystem types (McIntyre and Barrett 1992).

Ecosystem consequences of impacts. Creation of new watering points has perhaps increased local rates of NPP. Conversely, disruption of normal drainage patterns (e.g. by road construction or by diversion of water) alters the hydrology of intermittent streams and playas, and decreases the productivity of vegetation dependent on that water flow (Schlesinger and Jones 1984).

6.1.4.7 Biotic linkages and species interactions

Human impacts on biodiversity. Importation of non-native plants for improvement of forage or as weeds in some regions has reduced local plant diversity by replacing native species. Humans have attempted direct removals of plant species considered to be undesirable forage species (e.g. large-scale removals of native shrubs in southwestern US rangelands). Populations of some tree species in semi-

arid regions have been depleted by heavy use for fuel or other purposes. Populations of native mammals have been reduced either intentionally, when these are viewed as competitors for forage or as possible predators of livestock, or indirectly, e.g. through the effects of insecticide use on bat populations.

Ecosystem consequences of impacts. Alteration of native to non-native grass cover has apparently reduced populations of native ants and other consumers in Arizona (Whitford, pers comm). There is also some evidence that declining bat populations in the southwestern states of the USA have led to decreased frequency of effective pollination in some bat-pollinated monocarpic species of *Agave* (Howell and Roth 1981). Many biotic interactions in arid lands are less direct, however, resulting from the modification or modulation of the harsh environment by one species in such a fashion as to facilitate the occurrence or reproduction of other organisms. Among plants this facilitation is described as the 'nurse plant' phenomenon. The regeneration of one species under another might create a cyclic replacement or successional series (McAuliffe 1988; Yeaton and Esler 1990; Gutierrez *et al.* 1993): there are many reports that the presence of one plant species creates a specific environment that facilitates the establishment of other particular species (e.g. Montaña 1992; Silvertown and Wilson 1994). The loss of large woody species for use as fuel or as carving material has been suggested as a negative influence on the persistence of many typical species of desert plants (e.g. Franco and Nobel 1989). Introductions of large animals (as game or livestock) have often established wild or feral populations (horses, camels, oryx) that affect native vegetation and compete with native herbivores.

6.1.4.8 Microbial activities

Human impacts on biodiversity. The most prominent and conspicuous arena of microbial activity is the formation of crusts on the soil surface by algae, cyanobacteria and lichens (Isichei 1990; West 1990). Introduction of hoofed grazers has reduced the prevalence and development of these crusts in many regions (West 1990).

Ecosystem consequences of impacts. Microbial crusts play significant roles in nitrogen cycling and in stabilizing the soil surface against erosion (Eldridge and Greene 1994). In some cases these microbes secrete polysaccharides that absorb water, increasing the effective infiltration of precipitation; in other cases the secretions are actually hydrophobic, reducing soil wetting. Reductions in soil crusts are assumed to have reduced nitrogen fixation, increased soil erosion, and altered local infiltration of moisture.

6.1.4.9 Summary and relevance to human activities

Human alterations of biodiversity in desert regions have been mediated chiefly by the management of semi-arid and

arid regions for livestock use and by the importation of non-native plants. Arid regions are a reservoir of genetic variation useful for the development of new crops and new varieties of existing crops better suited to agriculture in marginal environments (e.g. Glenn *et al.* 1991). Because biological activity plays such an important role in moderating the harsh environment of arid regions, alteration of biodiversity is expected to have negative feedbacks on the remaining biological components of the system. These feedbacks lead to the formation of alternative stable states of the system, with stronger control by abiotic forces (Schlesinger *et al.* 1990), and the necessity for management strategies focused on transitions between states (Westoby *et al.* 1989).

References

- Abrahams, A.D., Parsons, A.J. and Wainwright, J. 1994. Resistance to overland flow on semiarid grassland and shrubland hillslopes, Walnut Gulch, southern Arizona. *Journal of Hydrology* **156**: 431–446.
- Blackburn, W.H., Knight, R.W. and Schuster, J.L. 1982. Saltcedar influence on sedimentation in the Brazos River. *Journal of Soil and Water Conservation* **37**: 298–301.
- Bock, J.H. and Bock, C.E. 1992. Vegetation responses to wildfire in native versus exotic Arizona grassland. *Journal of Vegetation Science* **3**: 439–446.
- Carlson, D.H., Thurow, T.L., Knight, R.W. and Heitschmidt, R.K. 1990. Effect of honey mesquite on the water balance of Texas Rolling Plains rangeland. *Journal Range Management* **43**: 491–496.
- Daniels, R.J.R., Joshi, N.V., and Gadgil, M. 1990. Changes in the bird fauna of Uttara Kannada, India, in relation to changes in land use over the past century. *Biological Conservation* **52**: 37–48.
- Dugas, W.A. and Mayeux, H.S. 1991. Evaporation from rangeland with and without honey mesquite. *Journal of Range Management* **44**: 161–5.
- Eldridge, D.J. and Greene, R.S.B. 1994. Assessment of sediment yield by splash erosion on a semi-arid soil with varying cryptogam cover. *Journal of Arid Environments* **26**: 221–232.
- Elkins, N.Z., Sabol, G.V., Ward, T.J. and Whitford, W.G. 1986. The influence of subterranean termites on the hydrological characteristics of a Chihuahuan desert ecosystem. *Oecologia* **68**: 521–528.
- Franco, A.C. and Nobel, P.S. 1989. Effect of nurse plants on the microhabitat and growth of cacti. *Journal of Ecology* **77**: 870–886.
- Gallardo, A. and Schlesinger, W.H. 1992. Carbon and nitrogen limitations of soil microbial biomass in desert ecosystems. *Biogeochemistry* **18**: 1–17.
- Glenn, E.P., O'Leary, J.W., Watson, M.C., Thompson, T.L. and Kuehl, R.O. 1991. *Salicornia bigelovii*: an oilseed halophyte for seawater irrigation. *Science* **251**: 1065–1067.
- Golluscio, R.A. and Sala, O.E. 1993. Plant functional types and ecological strategies in Patagonian forbs. *Journal of Vegetation Science* **4**: 839–846.

- Greene, R.S.B.** 1992. Soil physical properties of three geomorphic zones in a semi-arid mulga woodland. *Australian Journal of Soil Research* **30**: 55–69.
- Gutiérrez, J.R., Meserve, P.L., Contreras, L.C., Vasquez, H. and Jaksic, F.M.** 1993. Spatial distribution of soil nutrients and ephemeral plants underneath and outside the canopy of *Porlieria chilensis* shrubs in arid coastal Chile. *Oecologia* **95**: 347–352.
- Heske, E.J. and Campbell, M.** 1991. Effects of an 11-year livestock enclosure on rodent and ant numbers in the Chihuahuan desert, southeastern Arizona. *Southwestern Naturalist* **36**: 89–93.
- Howell, D.J. and Roth, B.S.** 1981. Sexual reproduction in agaves: the benefits of bats, the cost of semelparous advertising. *Ecology* **62**: 1–7.
- Isichei, A.O.** 1990. The role of algae and cyanobacteria in arid lands: a review. *Arid Soil Research and Rehabilitation* **4**: 1–17.
- Jackson, L.L., McAuliffe, J.R. and Roundy, B.A.** 1991. Desert restoration. *Restoration and Management Notes* **9**: 71–79.
- Jepson-Innes, K. and Bock, C.E.** 1989. Response of grasshoppers (Orthoptera: Acrididae) to livestock grazing in southeastern Arizona: differences between seasons and subfamilies. *Oecologia* **78**: 430–431.
- Jones, K.B.** 1981. Effects of grazing on lizard abundance and diversity in western Arizona. *Southwestern Naturalist* **26**: 107–115.
- Klopatek, J.M. and Stock, W.D.** 1994. Partitioning of nutrients in *Acanthosicyos horridus*, a keystone endemic species in the Namib Desert. *Journal of Arid Environments* **26**: 233–240.
- Louw, G.N. and Seely, M.K.** 1982. *Ecology of Desert Organisms*. Longman, London.
- McAuliffe, J.R.** 1988. Markovian dynamics of simple and complex desert plant communities. *American Naturalist* **131**: 459–490.
- McIntyre, S. and Barrett, G.W.** 1992. Habitat variegation, an alternative to fragmentation. *Conservation Biology* **6**: 146–147.
- McPherson, G.R., Boutton, T.W. and Midwood, A.J.** 1993. Stable carbon isotope analysis of soil organic matter illustrates vegetation change at the grassland/woodland boundary in southeastern Arizona, USA. *Oecologia* **93**: 95–101.
- Milchunas, D.G. and Lauenroth, W.K.** 1993. Quantitative effects of grazing on vegetation and soils over a global range of environments. *Ecological Monographs* **63**: 327–366.
- Montaña, C.** 1992. The colonization of bare areas in two-phase mosaics of an arid ecosystem. *Journal of Ecology* **80**: 315–327.
- Navar, J. and Bryan, R.** 1990. Interception loss and rainfall redistribution by three semi-arid growing shrubs in northeastern Mexico. *Journal of Hydrology* **115**: 51–63.
- Noy-Meir, I.** 1973. Desert ecosystems: environment and producers. *Annual Review of Ecology and Systematics* **4**: 25–51.
- O'Brien, E.M.** 1993. Climatic gradients in woody plant species richness: towards an explanation based on an analysis of southern Africa's woody flora. *Journal of Biogeography* **20**: 181–198.
- Oesterheld, M., Sala, O.E. and McNaughton, S.J.** 1992. Effect of animal husbandry on herbivore-carrying capacity at a regional scale. *Nature* **356**: 234–236.
- Otterman, J.** 1989. Enhancement of surface-atmosphere fluxes by desert-fringe vegetation through reduction of surface albedo and of soil heat-flux. *Theoretical and Applied Climatology* **40**: 67–79.
- Peinetti, R., Pereyra, M., Kin, A. and Sosa, A.** 1993. Effects of cattle ingestion on viability and germination rate of calden (*Prosopis caldenia*) seeds. *Journal of Range Management* **46**: 483–486.
- Pewe, T.L.** 1981. *Desert Dust: Origin, characteristics, and Effect on man*. Geological Society of America, Boulder, Colorado.
- Pianka, E.R. and Schall, J.J.** 1981. Species densities of Australian vertebrates. In: Keast, A. (ed.), *Ecological Biogeography of Australia*. 1675–1694. W. Junk, The Hague.
- Pye, K.** 1987. *Aeolian Dust and Dust Deposits*. Academic Press, London.
- Rogers, R.D. and Schumm, S.A.** 1991. The effect of sparse vegetative cover on erosion and sediment yield. *Journal of Hydrology* **123**: 19–24.
- Roundy, B.A., Winkel, V.K., Khalifa, H. and Matthias, A.D.** 1992. Soil water availability and temperature dynamics after one-time heavy cattle trampling and land imprinting. *Arid Soil Res. Rehabil.* **6**: 53–69.
- Schlesinger, W.H., Fonteyn, P.J. and Marion, G.M.** 1987. Soil moisture content and plant transpiration in the Chihuahuan desert of New Mexico. *Journal of Arid Environments* **12**: 119–126.
- Schlesinger, W.H. and Jones, C.S.** 1984. The comparative importance of overland runoff and mean annual rainfall to shrub communities of the Mojave Desert. *Botanical Gazette* **145**: 116–124.
- Schlesinger, W.H., Reynolds, J.F., Cunningham, G.L., Huennike, L.F., Jarell, W.M., Virginia, R.A. and Whitford, W.G.** 1990. Biological feedbacks in global desertification. *Science* **247**: 1043–1048.
- Shmida, A.** 1985. Biogeography of the desert flora. In: Evenari, M., Noy-Meir, I. and Goodall, D.W. (eds), *Ecosystems of the World*, Vol. 12A. *Hot Deserts and Arid Shrublands*. 23–77. Elsevier, Amsterdam.
- Silvertown, J. and Wilson, J.B.** 1994. Community structure in a desert perennial community. *Ecology* **75**: 409–417.
- Striegl, R.G., McConnaughey, T.A., Thorstenson, D.C., Weeks, E.P. and Woodward, J.C.** 1992. Consumption of atmospheric methane by desert soils. *Nature* **357**: 145–147.
- Tromble, J.M.** 1987. Water interception by two arid land shrubs. *Journal of Arid Environments* **15**: 65–70.
- Verstraete, M.M. and Schwartz, S.A.** 1991. Desertification and global change. *Vegetatio* **91**: 3–13.
- West, N.E.** 1990. Structure and function of microphytic soil crusts in wildland ecosystems of arid to semi-arid regions. *Advances in Ecological Research* **20**: 179–223.
- West, N.E. and Gifford, G.F.** 1976. Rainfall interception by cool-desert shrubs. *Journal of Range Management* **29**: 171–172.
- Westoby, M., Walker, B. and Noy-Meir, I.** 1989. Opportunistic management for rangelands not at equilibrium. *Journal of Range Management* **42**: 266–274.
- Whitford, W.G.** 1991. Subterranean termites and long-term productivity of desert rangelands. *Sociobiology* **19**: 235–243.
- Whitford, W.G.** 1993. Animal feedbacks in desertification: an overview. *Revista Chilena de Historia Natural* **66**: 243–251.

Wood, J.C., Wood, M.K. and Tromble, J.M. 1987. Important factors influencing water infiltration and sediment production on arid lands in New Mexico. *Journal of Arid Environments* 12: 111–118.

Wright, H.A. 1980. *The Role and Use of Fire in the Semidesert Grass-shrub Type*. USDA Forest Service General Technical Report INT-85, Intermountain Forest and Range Experiment Station.

Yeaton, R.I. and Esler, K.J. 1990. The dynamics of a succulent karoo vegetation. *Vegetatio* 88: 103–113.

6.1.5 Tropical savannahs

6.1.5.1 Introduction

Savannahs are tropical ecosystems ‘...forming a continuum of physiognomic types ranging from closed woodlands with a heliophytic grass understorey, through open savannah woodlands to treeless edaphic grasslands’ (Huntley and Walker 1982). In all these areas, grasses with the C4 photosynthetic pathway dominate the herbaceous layer while the woody component, at the moist end of the moisture gradient, comprises fire-tolerant trees and shrubs. With an estimated area ranging from 15 to 24.6×10^6 km² (Whittaker and Likens 1975; Olson *et al.* 1983) savannah ecosystems constitute the largest single type of terrestrial biome. Savannahs develop in soils of generally low fertility, under a regime of strongly seasonal rainfall, and are submitted to recurrent disturbances through herbivory and fire (Figure 6.1-1) (Sarmiento 1984; Scholes and Walker 1993). These environmental constraints largely determine structure and productive capacity of these ecosystems (Walker 1987; Detling 1988). Population reductions due to disturbance, and spatial patchiness, contribute to the maintenance of species and functional group diversity (Huston 1979). Lowering perturbation frequency results in a large accumulation of litter leading to a reduction in diversity of the grass layer (Tilman 1993). However, diversity of the tree layer increases in the absence of perturbation due to the survival of fire- or grazing-sensitive species (San José and Fariñas 1991).

6.1.5.2 Human impacts on biodiversity

Human intervention in tropical savannahs has been continuous throughout human history: thus it has been present in Africa longer (around 500 000 years), than in Australia (*c.* 40 000 years) and South America (*c.* 12 000 years). Human modification of savannahs occurs through the utilization of fire for hunting, and the grazing of domesticated herbivores. Human invasions have been associated with large-scale megafauna extinctions in South America during the Pleistocene (Martin 1973). Massive modifications of landscape are, however, relatively recent, beginning with the arrival of European settlers. Most changes are related to the agricultural utilization of grasslands, and the largest human impacts on biodiversity

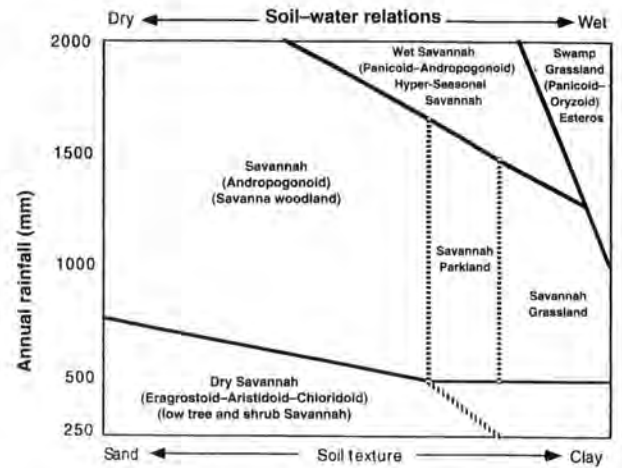

Figure 6.1-1: Savannahs of the world. The Andropogonoid grasses dominate the core savannahs in the 500–2000 mm rainfall zone. Humid savannahs with heavier soils are dominated by Eragrostoid, Aristidoid and Chloridoid grasses. The former are more common in South America, while the latter are found in Africa, Australia and South America. Within the core savannahs, woodlands occupy the medium light-textured and more freely drained soils characterized by *Eucalyptus* woodlands in Australia, the *Brachystegia*, *Isoberrinia* and *Julbernardia* woodlands of Africa, and the *Curatella-Byrsonima* woodlands of South America. Savannah parklands occupy the medium to heavy textured soils in both Africa and Australia. The woody stratum is characterized by leguminous genera (*Acacia*, *Bauhinia/Lysiphylum*) and *Terminalia*. On heavy cracking clay soils, trees and shrubs are rare. There are savannahs at altitudes above 800–1000 m in Africa and South America. The *Cerrado* region in Brazil contains possibly the largest diversity of woody species in tropical savannahs. (Slightly modified from Johnson and Tothill 1985.)

are related to the introduction of cattle; the over exploitation or overprotection of large native herbivores, and the introduction of alien grasses and legumes (Laws 1970; Hatton and Smart 1984; Mott 1986; Owen-Smith 1988; Braithwaite *et al.* 1989; Braithwaite 1990; Freeland 1990; Holmes and Mott 1993; Klink *et al.* 1993; Young and Solbrig 1993).

6.1.5.3 Productive capacity, biomass and decomposition

Reductions in diversity of primary producers lowers both resistance to grazing by a single species of ungulate and resilience after grazing, thereby decreasing biomass stability through the seasons. Changes in the composition and density of ungulates affect primary productivity because herbivory regulates competition between plant species through maintenance of an open canopy, conservation of soil moisture and nutrient recycling. The ecological properties of the plant species have important consequences for ecosystem organization and they appear not to be interchangeable (McNaughton 1985, 1994). Ruminant (e.g. zebra) and non-ruminant (e.g. wildebeest)

ungulates graze seasonally in grasslands with a high proportion of nutritious species. These plant species assemblages are more likely to occur in grasslands of higher diversity, and therefore support more herbivores (Ben-Shahar and Coe 1992). Diverse natural grasslands seem to be more resilient to drought-induced changes in productivity than simplified systems developed through long-term fertilization (Frank and McNaughton 1991; Tilman and Downing 1994). Changes in biodiversity in Australian and South American savannahs have affected biogeochemical cycles leading to habitat and landscape deterioration. The planting of exotic grasses with high production capacity is frequently followed by a reduction in yield and quality of forage due to slower mineralization of humic material and turnover of nitrogen in plant residues with high lignin:nitrogen ratios, and the gradual loss of nitrogen from animal excreta (Holmes and Mott 1993; Klink *et al.* 1993).

6.1.5.4 Soil structure and nutrients

Introduction of African grasses into South American and Australian savannahs increases biomass production per unit area, allowing larger numbers of cattle to be grazed per unit of land. Higher cattle density reduces soil permeability and vegetation cover, and leads to increased runoff and erosion (Mott *et al.* 1979; Seiny-Boukar 1992). Grazing-intolerant native grasses are being replaced by faster growing, invasive grasses (Mott *et al.* 1979; Holmes and Mott 1993). In dry years overgrazing destroys the grassland allowing the penetration of woody weeds, and resulting in extended erosion (Winter 1990). Exclusion of large herbivores in East Africa reduced overgrazing and resulted in tree regeneration and a significant increase in soil fertility (Hatto and Smart 1984), while introduction of legumes improved nitrogen availability in Australian grasslands (Henzell 1968; Myers and Robbins 1991). Higher palatability of legumes, and patchy distribution in pasture, leads to increased trampling and soil deterioration strongly affecting pasture productivity in the short term (Mott *et al.* 1979).

6.1.5.5 Water distribution, balance and quality

Large-scale agricultural utilization of savannahs either changes the composition of primary producers (native grasses are substituted by alien grasses and legumes for intensified cattle production), or eliminates the plant cover for planting of cash crops (soybean, peanuts, sugar cane, etc.). In both cases savannah soils require a heavy input of fertilizers leading to long-term impacts on water quality (pollution of underground water resources and rivers) (Mott *et al.* 1979; Gillard *et al.* 1989; Seiny-Boukar *et al.* 1992).

6.1.5.6 Atmospheric properties

Periodic burning of savannah landscapes reduces tree/grass ratios (Medina and Silva 1990) and has implications for

atmospheric chemistry (Lobert *et al.* 1990). There are potential strong feedbacks between the species composition of grasslands and nitrogen cycling. Grass species differ in below-ground biomass accumulation and tissue-nitrogen and lignin concentrations, and these factors affect nitrogen mineralization rates (Wedin and Tilman 1990). Grass species also differ in their nitrogen requirements depending on their mode of photosynthetic C4 pathway. Malate formers seem to require less nitrogen and have lower tissue-nitrogen concentration, while aspartate formers require more nitrogen and are more palatable (Huntley 1982). The relative proportion of these photosynthetic types may therefore affect nitrogen losses through fire and the rate of nitrogen mineralization in soils. Changes in soil nitrogen availability modify substantially the relative proportion of malate and aspartate formers in South African grasslands (Medina and Huber 1992). The rapid transition from *miombo* woodland and savannah to maize-based agriculture in southern Africa results in an almost complete loss of ecosystem carbon pools. Clearing of the *miombo* and establishment of maize-based agriculture on a sandy alfisol resulted in a decline in total soil organic carbon from 28 to 9 Mg/ha (Woomer 1993).

6.1.5.7 Landscape and waterscape structure

Habitat heterogeneity determined by the co-occurrence of trees and grasses in savannahs is considered to be a key factor for the maintenance of their biodiversity (Gillard *et al.* 1989; Holmes and Mott 1993). Utilization of savannah lands for grazing has modified their original fire regimes. Natural savannah fires have a low frequency because they depend on the occurrence of dry electrical storms, but fire frequency has been increased under human influence in order to prevent excessive fuel accumulation and to provide green forage for cattle during the dry season. As a result, tree/grass ratios have changed markedly. Trees are more sensitive to fire than grasses, because the latter accumulate most of their biomass and nutrient resources below ground. High fire frequency reduces the number of tree species, and the numbers of individuals per species in most savannah sites (San José and Fariñas 1991; Dauguet and Menaut 1992).

6.1.5.8 Biotic linkages and species interactions

The co-occurrence of trees and grasses in savannahs results in patchiness of resource availability. Changes in tree/grass ratios significantly modify rates of biogeochemical and energy cycling as a result of the contrasting characteristics of the two components with respect to light interception and nutrient requirements (Kellman 1979; Georgiadis 1989; Ben-Shahar 1991; Isichei and Muoghalu 1992; Belsky *et al.* 1993; Mordelet *et al.* 1993). The recent human population explosion in Africa, and the migratory constraints imposed by political boundaries, increased the occupation of land with a consequent restriction of the

ranges of wild animals. Most of the formerly wooded southern section of the Murchison Falls National Park (Uganda), c. 2600 km², has been converted from woodland into grassland (Hatton and Smart 1984). Numbers of elephants in Tsavo National Park increased dramatically after the Second World War as a result of the enforcement of anti-poaching activities, and the consequent overpopulation of elephants resulted in habitat deterioration, particularly along waterways. Under the influence of elephants and fire the dry *Commiphora-Acacia* bush has been destroyed over large areas and replaced by grassland (Laws 1970; Owen-Smith 1988). In the same area, a long-term experiment excluding herbivory by large ungulates resulted in a marked tree regeneration, and a pronounced increase in soil fertility (Hatton and Smart 1984).

Vegetation-herbivore interactions are highly varied. In eastern Africa herbivory patchiness can be associated with nutritional quality of the forage, but also grazing animals can modify plant nutritional properties through their influence on soil nutrient availability and plant species composition (McNaughton 1985; Georgiades and McNaughton 1990). Although savannahs of northern Australia and South America evolved in conjunction with herbivore pressure, their herbivore megafauna disappeared in the Pleistocene (Martin 1973). Europeans introduced several medium- and large-sized herbivore species, in numbers comparable to those of native herbivores elsewhere. In Australia, due to the lack of predators and pathogens, the density of feral populations of introduced herbivores is much larger than in their original habitats, and the high density of herbivores has led to ecosystem deterioration (Freeland 1990). Mutualistic relationships in Australian ecosystems have frequently evolved presumably in response to low resource availability. Australasian woody plants produce copious quantities of nectar, and this has had a pronounced effect on the fauna. Forty-two percent of the honey-eater species of the family Meliphagidae occur in Australia, and most of the rest are found in New Guinea (Braithwaite 1990). The potential damage for tree reproduction following reductions in honey-eaters' diversity is large. Pasture improvement and tree clearances have produced substantial reductions in the number and frequency of native herbaceous species, but also of bird species and soil invertebrates (Greenslade 1992). Thinning of bird populations has been associated with the spread of eucalyptus dieback (rural dieback) caused by more intensive defoliation by insect herbivores.

6.1.5.9 Microbial activities

Mycorrhizae play an important role in nutrient uptake, and possibly also water uptake, by vascular plants. C₄ plants in nutrient-poor soils appear to be more dependent on mycorrhizal symbiosis than are C₃ plants (Hetrick *et al.*

1990), both at the seedling stage and during regrowth from rhizomes. Mycorrhizal abundance in grasslands is generally inversely related to soil fertility and positively related to the ratio of plant to soil nutrient contents (McNaughton and Osterheld 1990). Therefore, mycorrhizal associations are thought to stabilize ecosystem nutrient fluxes. The semi-arid savannahs in Botswana (rainfall 500 mm) have been degraded by overgrazing, so restoration depends on the probability of inoculation of seedlings' roots (Veenendaal *et al.* 1992). Populations of mycorrhizae in the soil can be managed by the introduction of spores of species differing in their host selectivity and efficiency in phosphorus uptake capacity (Dodd *et al.* 1990). Changes in ecological conditions leading to modifications in the mycorrhizal fungi may result in disturbances of the phosphorus availability for native grasses. Introduction of legumes improves nitrogen supply to the vegetation through symbiotic nitrogen fixation (Henzell 1968). Plant growth in eastern African grasslands induced by rainfall events is accompanied by strong pulses of microbial activity, and the concentration of large herbivores attracted by the green foliage. Therefore, soil microbial activity is closely correlated with patterns of herbivore use and intensity of herbivory in natural grasslands of eastern Africa (Ruess and Seagle 1994).

6.1.5.10 Summary and relevance to human activities

Savannah ecosystems have been profoundly modified throughout human history. Most modifications are related to overpopulation and mismanagement of natural resources. Reductions in landscape, community, and species diversity have affected ecosystem functioning as expressed by habitat deterioration and diminished capacity of savannah environments to support human populations. Erosion, pollution of water sources, reductions in soil fertility and diminished carrying capacity for herbivores are some of the ecological consequences relevant for the continued use of these environments. Restoration of ecosystem functioning through the recovery of biodiversity is an essential step in the planning of sustainable use of savannahs.

References

- Belsky, A.J., Mwonga, S.M., Amundson, R.G., Duxbury, J.M. and Ali, A.R. 1993. Comparative effects of isolated trees on their undercanopy environments in high- and low-rainfall savannahs. *Journal of Applied Ecology* **30**: 143–155.
- Ben-Shahar, R. 1991. Abundance of trees and grasses in a woodland savannah in relation to environmental factors. *Journal of Vegetation Science* **2**: 345–350.
- Ben-Shahar, R. and Coe, M.J. 1992. The relationships between soil factors, grass nutrients and the foraging behaviour of wildebeest and zebra. *Oecologia* **90**: 422–428.
- Braithwaite, R.W. 1990. Australia's unique biota: implication for biological processes. *Journal of Biogeography* **17**: 347–354.

- Braithwaite, R.W., Lonsdale, W.M. and Estbergs, J.A.** 1989. Alien vegetation and native biota: the impact of *Mimosa pigra*. *Biological Conservation* **48**: 189–210.
- Dauget, J.M. and Menaut, J.C.** 1992. Evolution sur 20 années d'une parcelle de savanne boisée protégée du feu dans la réserve de Lamto (Côte d'Ivoire). *Candollea* **47**: 621–630.
- Detling, J.K.** 1988. Grassland and savannahs: regulation of energy flow and nutrient cycles by herbivores. In: Pomeroy, L.R. and Alberts, J.J. (eds), *Concepts in Ecosystem Ecology*. Ecological Studies Vol. 67. 131–148. Springer-Verlag, Berlin.
- Dodd, J.C., Arias, I. and Koomen, I., Hayman, D.S.** 1990. The management of populations of vesicular-arbuscular mycorrhizal fungi on plant growth and nutrition in the field. *Plant and Soil* **122**: 229–240.
- Frank, D.A. and McNaughton, S.J.** 1991. Stability increases with diversity in plant communities: empirical evidence from the 1988 Yellowstone drought. *Oikos* **62**: 360–362.
- Freeland, W.J.** 1990. Large herbivore mammals: exotic species in northern Australia. *Journal of Biogeography* **17**: 445–449.
- Georgiadis, N.J.** 1989. Microhabitat variation in an African savannah: effect of woody cover and herbivores in Kenya. *Journal of Tropical Ecology* **5**: 93–108.
- Georgiadis, N.J. and McNaughton, S.J.** 1990. Elemental and fiber contents of savannah grasses: Variation with grazing, soil type, season and species. *Journal of Applied Ecology* **27**: 623–634.
- Gillard, P., Williams, J. and Money Penny, R.** 1989. Clearing trees from Australia's semi-arid tropics – production, economic and long term hydrological changes. *Agricultural Science* **2**: 34–39.
- Greenslade, P.** 1992. Conserving invertebrate diversity in agricultural, forestry and natural ecosystems in Australia. *Agriculture, Ecosystems and Environment* **40**: 297–312.
- Hatton, J.C. and Smart, N.O.E.** 1984. The effect of long-term exclusion of large herbivores on soil nutrient status in Murchison Falls National Park, Uganda. *African Journal of Ecology* **22**: 23–30.
- Henzell, E.F.** 1968. Sources of nitrogen for Queensland pastures. *Tropical Grasslands* **2**: 1–17.
- Hetrick, B.A.D., Wilson, G.T.W. and Todd, T.C.** 1990. Differential responses of C3 and C4 grasses to mycorrhiza symbiosis, phosphorus fertilisation, and soil microorganisms. *Canadian Journal of Botany* **68**: 461–467.
- Holmes, J.H. and Mott, J.J.** 1993. Towards the diversified use of Australia's savannahs. In: Young, M.D. and Solbrig, O.T. (eds), *The World's Savannahs*. Man and the Biosphere Series Vol. 12. 283–317. UNESCO and Parthenon Publ. Group Ltd., Paris.
- Huntley, B.J.** 1982. African savannahs. In: Huntley, B.J. and Walker, B.H. (eds), *Ecology of Tropical Savannahs*. Springer-Verlag, Berlin.
- Huntley, B.J. and Walker, B.H.** 1982. Introduction. In: Huntley, B.J. and Walker, B.H. (eds), *Ecology of Tropical Savannahs*. Springer-Verlag, Berlin.
- Huston, M.** 1979. A general hypothesis of species diversity. *American Naturalist* **113**: 81–101.
- Isichei, A.O. and Muoghalu, J.I.** 1992. The effects of tree canopy cover on soil fertility in a Nigerian savannah. *Journal of Tropical Ecology* **8**: 329–338.
- Johnson, R.W. and Tothill, J.C.** 1985. Ecology and management of world savannahs. Definition and broad geographic outline of savannah lands. In: Tothill, J.C. and Mott, J.J. (eds), *Ecology and Management of World Savannahs*. 1–13. Australian Academy of Sciences, Canberra.
- Kellman, M.** 1979. Soil enrichment by neotropical savannah trees. *Journal of Ecology* **67**: 565–577.
- Klink, C.A., Moreira, A.G. and Solbrig, O.T.** 1993. Ecological impact of agricultural development in the Brazilian Cerrados. In: Young, M.D. and Solbrig, O.T. (eds.) *The World's Savannahs*. Man and the Biosphere Series, Vol. 12. 259–282. UNESCO and Parthenon Publ. Group Ltd., Paris.
- Laws, R.M.** 1970. Elephants as agents of habitat and landscape change in East Africa. *Oikos* **21**: 1–15.
- Lobert, J.M. Scharffe, D.H. Hao, W.M. and Crutzen, P.J.** 1990. Importance of biomass burning in the atmospheric budgets of nitrogen-containing gases. *Nature* **346**: 552–554.
- McNaughton, S.J.** 1985. Ecology of a grazing ecosystem: the Serengeti. *Ecological Monographs* **55**: 259–294.
- McNaughton, S.J.** 1994. Conservation goals and the configuration of biodiversity. In: Forey, P.L., Humphries, C.J. and Vane-Wright, R.I. (eds), *Systematics and Conservation Evaluation*. 41–62. Clarendon Press, Oxford.
- McNaughton, S.J. and Oesterheld, M.** 1990. Extramatricial mycorrhizal abundance and grass nutrition in a tropical grazing ecosystem, the Serengeti National Park, Tanzania. *Oikos* **59**: 92–96.
- Martin, P.S.** 1973. The discovery of America. *Science* **179**: 969–974.
- Medina, E. and Huber, O.** 1992. The role of biodiversity in the functioning of savannah ecosystems. In: Solbrig, O.T., van Emden, O.H.M and van Oordt P.G.W.J. (eds), *Biodiversity and Global Change*. 139–158. Monograph No. 8. IUBS, Paris.
- Medina, E. and Silva, J.** 1990. The savannahs of northern South America: a steady state regulated by water–fire interactions on a background of low nutrient availability. *Journal of Biogeography* **17**: 403–413.
- Mordelet, P., Abbadie, L. and Menaut, J.-C.** 1993. Effects of tree clumps on soil characteristics in a humid savannah of West Africa (Lamto, Côte d'Ivoire). *Plant and Soil* **153**: 103–111.
- Mott, J.J., Bridge, B.J. and Arndt, W.** 1979. Soil seals in tropical all pastures of northern Australia. *Australian Journal of Soil Research* **30**: 483–494.
- Mott, J.J.** 1986. Planned invasions of Australian tropical savannahs. In: Groves, R.H. and Burdon, J.J. (eds), *Ecology of Biological Invasions*. 89–96. Cambridge University Press. Cambridge.
- Myers, R.J.K. and Robbins, G.B.** 1991. Sustaining productive pastures in the tropics. 5. Maintaining productive sown grass pastures. *Tropical Grasslands* **25**: 103–111.
- Olson, J.S., Watts, J.A. and Allison, L.J.** 1983. *Carbon in Live Vegetation of Major World Ecosystems*. US Department of Energy, Oak Ridge National Laboratory, Tenn.
- Owen-Smith, R.N.** 1988. *Megaherbivores. The influence of very large body size on ecology*. Cambridge University Press, Cambridge.
- Ruess, R.W. and Seagle, S.W.** 1994. Landscape patterns in soil microbial processes in the Serengeti National Park, Tanzania. *Ecology* **75**: 892–904.
- San José, J.J. and Fariñas, M.** 1991. Temporal changes in the structure of a *Trachypogon* savannah protected for 25 years. *Acta Oecologica* **12**: 237–247.

- Sarmiento, G.** 1984. *The Ecology of Neotropical Savannahs*. Harvard University Press, Cambridge, Mass.
- Scholes, R.J. and Walker, B.H.** 1993. *An African Savannah: Synthesis of the Nylsvlei study*. Cambridge University Press, Cambridge.
- Seiny-Boukar, L., Floret, C. and Pontanier, R.** 1992. Degradation of savannah soils and reduction of water available for the vegetation: the case of northern Cameroon Vertisols. *Canadian Journal of Soil Science* **72**: 481–488.
- Tilman, D.** 1993. Species richness of experimental productivity gradients: how important is colonization limitation? *Ecology* **74**: 2179–2191.
- Tilman, D. and Downing, J.A.** 1994. Biodiversity and stability in grasslands. *Nature* **367**: 363–365.
- Veenendaal, E.M., Monnaapula, S.C., Gilika, T. and Magole, I.L.** 1992. Vesicular-arbuscular mycorrhizal infection of grass seedlings in a degraded semi-arid savannah in Botswana. *New Phytologist* **121**: 477–485.
- Walker, B.H. (ed.)** 1987. *Determinant of tropical savannahs*. IUBS Monograph 3, IRL Press, Oxford.
- Wedin, D.A. and Tilman, D.** 1990. Species effect on nitrogen cycling: a test with perennial grasses. *Oecologia* **84**: 433–441.
- Whittaker, R.H. and Likens, G.E.** 1975. The biosphere and man. In: Lieth, H. and Whittaker, R.H. (eds), *Primary Productivity of the Biosphere*. Springer-Verlag, Berlin.
- Winter, W.H.** 1990. Australia's northern savannahs: a time for change in management philosophy. *Journal of Biogeography* **17**: 525–529.
- Woomer, P.L.** 1993. The impact of cultivation on carbon fluxes in woody savannahs of Southern Africa. *Water and Air Pollution* **70**: 403–412.
- Young, M.D. and Solbrig, O.T. (eds)**, 1993. *The World's Savannahs. Economic driving forces, ecological constraints and policy options for sustainable land use*. Man and the Biosphere Series, Vol. 12. UNESCO and Parthenon Publishing Group, Paris.

6.1.6 Boreal forests

6.1.6.1 Introduction

The boreal forest is a circumpolar biome covering approximately 13×10^6 km² in upland forest and 2.6×10^6 km² in peatland in North America and Eurasia (Olson *et al.* 1983; Shugart *et al.* 1992; Apps *et al.* 1993). Although ecosystems in this biome are generally species-poor, many species respond to and affect resource availability, food supply for herbivores, and disturbance regimes in very different ways (Bryant and Chapin 1986; Payette 1992; Pastor and Mladenoff 1992). Functional diversity is therefore high, but each functional group is represented by only a few species. These strong feedbacks between species life traits, resources and disturbance regimes may in turn cause cyclic fluctuations in populations of animals (Hansson 1979; Haukioja *et al.* 1983). Plant tissue chemistry integrates biodiversity with ecosystem properties. Tissue chemistry varies not only

between species but also between biogeographic provinces of major plant species (Bryant *et al.* 1989, 1994). Tissue chemistry controls decomposition and nutrient availability, palatability and flammability (Bryant and Chapin 1986; Pastor and Mladenoff 1992; Pastor and Naiman 1992) and is correlated with life form, growth rates and longevity (Chapin 1986; Bryant and Chapin 1986).

6.1.6.2 Human-induced impacts and threats to biodiversity

Increased atmospheric loadings of radiatively active gases, with consequent warming of the climate, and logging are the two human activities with great consequences for changes in biodiversity and ecosystem properties in boreal regions over the next several decades. Initially, these societal impacts will alter the diversity of tree species. Because of the couplings between tree species, food web structure, nutrient cycling and the atmosphere, these changes in tree species composition ramify throughout the ecosystem and biome. The probability of climate warming and increased logging over the next several decades is high, but the ecosystem effects of these impacts are greatly conditioned by the functional group affected and local conditions. Human-induced changes in biodiversity in boreal regions therefore introduce high variance in ecosystem properties at local and regional scales.

6.1.6.3 Productive capacity, biomass and decomposition

Human impacts on biodiversity. Global warming will cause differential migration of tree species northward from the boreal zone into the tundra, and from grasslands and northern hardwood areas into areas currently occupied by boreal trees (Pastor and Post 1988; Davis and Zabinski 1992; Pastor and Johnston 1992). Logging in the boreal forest generally consists of clear-cutting or plantation establishment. Clear-cutting alone perpetuates early successional forests dominated by shade-intolerant hardwoods, but with generally high species richness, while plantations consist mainly of monocultures of conifers (Mladenoff and Pastor 1993; Haila 1994).

Ecosystem consequences of impacts. As the climate warms, the differential migration of tree species changes productivity, biomass and decomposition (Payette *et al.* 1985; Pastor and Post 1988; Bonan *et al.* 1990; MacDonald *et al.* 1993). The direction of change depends on the local distribution of soil types. On sandy soils in mid-continental regions south of the permafrost line, drought stress will increase and the boreal forest will be replaced by a jack pine–oak savannah of low productivity and slow decomposition. On clay soils that can retain water, the boreal forest will be replaced by northern hardwoods of higher productivity and decomposition rates (Pastor and Post 1988). In far northern regions, the local distribution of permafrost affects how ecosystems respond to climate warming because of differential sorting of species (Bonan

et al. 1990). Similarly, forestry practices can increase productivity and biomass where they favour rapidly growing hardwoods or where plantations of slow-growing conifers are fertilized (Mladenoff and Pastor 1993); however, the increased productivity in monoculture plantations comes at the expense of local species richness.

6.1.6.4 Soil structure and nutrients

Human impacts on biodiversity. The shifts in relative abundance of hardwoods and conifers through logging and climate warming noted above affect soil structure and nutrients through changes in the amounts and arrays of litter returned to the soil (Flanagan and van Cleve 1985; Pastor and Mladenoff 1993).

Ecosystem consequences of impacts. Where abundances of hardwoods increase, soil nutrient availability will also increase because the chemistry of litter from these species makes them easily decomposable (Flanagan and van Cleve 1983; Pastor and Post 1988; Pastor and Mladenoff 1993). In contrast, increased abundances of conifers on droughty soils in a warmer climate or in monoculture plantations will cause declines in soil nutrient availability because of the high lignin and low nutrient contents of their litter. These changes in nutrient availability will then feed back and affect productivity and biomass because of nutrient limitations to growth (Pastor and Post 1988; Pastor and Mladenoff 1993).

6.1.6.5 Water distribution, balance and quality

Human impacts on biodiversity. Climate warming will have the greatest effect on water distribution by changing the relative abundance of conifers and hardwoods and thus altering regional evapotranspiration rates, and by causing melting of permafrost in far northern regions.

Ecosystem consequences of impacts. The ecosystem consequences of the effects of altered biodiversity on the hydrologic cycle are less well studied than for other ecosystem processes. However, widespread melting of permafrost will certainly alter large-scale drainage patterns (Post 1990) with consequent region-wide impacts on water quality and river flows.

6.1.6.6 Feedbacks to atmospheric properties

Human impacts on biodiversity. By altering the relative abundance and distribution of functional groups, climate warming and logging will change the carbon balance of ecosystems. Furthermore, warming of the soils of peatlands and other northern wetlands will change the amount and types of trace gas loadings through changes in the microbial community (Gorham 1991).

Ecosystem consequences of impacts. Boreal regions contain large portions of the global carbon pool. Currently this biome is probably a net sink for carbon, but upon warming it can be converted to a net source (Post 1990;

Apps et al. 1993). Warming of the soils, particularly in wetlands, can increase trace gas loadings, especially that of methane (Gorham 1991). However, the net increase in trace gas loadings, and the balance of methane versus carbon dioxide, depends on the types of plant communities and the ease of decomposition of the soil or sediment organic matter (Roulet *et al.* 1992; Updegraff *et al.* 1994). Logging can increase productivity and thereby offset the net export of carbon, but only if rotations are long enough to allow the biomass to recover completely to achieve that in old-growth forests. If logging causes large losses of conifers over large areas, the albedo of the boreal region may increase and therefore its role in the heat and water budgets of the Earth may also be seriously changed (Bonan *et al.* 1992).

6.1.6.7 Landscape structure

Human impacts on biodiversity. By changing the relative distribution of stands composed largely of one functional group or another, both climate warming and logging alter the structural patterns of landscapes with consequent effects on the fauna that depend on them. Furthermore, climate warming can have secondary effects on landscape structure by increasing fire frequency and intensity (Clark 1989; Payette 1992).

Ecosystem consequences of impacts. Besides the impacts on productivity, nutrient cycling and atmospheric feedbacks noted above, changes in landscape structure have significant effects on habitat for important groups of fauna. By homogenizing stand and landscape structure and composition, logging has severe consequences for the diversity of those faunal groups — particularly avian and insect fauna — that depend on old-growth stands, microsite habitats, and a diversity of habitat elements (Jarvinen and Vaisanen 1977, 1978; Jarvinen *et al.* 1977; Helle 1984; Virkkala 1987, 1991; Telfer 1992). Fairly subtle changes in habitat structure can have large ecological consequences if they occur uniformly over large areas (von Haartman 1973; Jarvinen *et al.* 1977; Haila *et al.* 1980; Helle and Jarvinen 1986). Because many breeding birds are neotropical migrants, this loss of habitat has important consequences for tropical forests as well.

6.1.6.8 Biotic linkages and species interactions

Human impacts on biodiversity. Climate warming and logging will indirectly affect herbivore–ecosystem interactions by altering the relative abundance of plants used as food and, for mammalian herbivores, those used as cover. However, the herbivores themselves can alter the relative abundance of species, thus introducing strong feedbacks into the changes in biodiversity caused by human activities.

Ecosystem consequences of impacts. Browsing by moose (*Alces alces*) and other large ungulates changes the relative composition of the plant community from highly browsed

hardwoods with high litter quality and decay rate to unbrowsed conifers with low litter quality and decay rate (Bryant and Chapin 1986; Pastor *et al.* 1993a). Thus, heavily browsed areas have lower nutrient availability as conifers invade (Pastor *et al.* 1993a). Food quality is related to secondary chemistry and there is growing evidence that there are longitudinal gradients of palatability at the subspecies level across entire continents (Bryant *et al.* 1989, 1994). Changes in the relative abundance of aspen affect habitat for beaver, which in turn affects the abundance, diversity and distribution of wetlands created by this important keystone species (Johnston and Naiman 1990; Pastor *et al.* 1993b). Increased probability of insect outbreak can also be induced by increased drought upon climate warming (Mattson and Haack 1987; Holling 1992). There is therefore the very strong likelihood that climate and logging-induced changes in biodiversity and ecosystem functioning will be strongly conditioned by secondary feedbacks through herbivores and the entire food web.

6.1.6.9 Microbial activities

Human impacts on biodiversity. Human impacts on the microbial community and its activities are mediated primarily through changes in litter quality and quantity, with changes in the relative distribution of plant functional groups, and through changes in soil temperature and water balance.

Ecosystem consequences of impacts. The changes in nutrient cycling rates and trace gas loading to the atmosphere discussed above are all mediated through changes in the microbial community. The diversity of the microbial community appears to be more important in determining the relative proportion of trace gases and forms of inorganic nutrients than in determining the mass balance of carbon and nutrients through the soil (Roulet *et al.* 1992; Updegraff *et al.* 1994).

6.1.6.10 Summary and relevance to human activities

Properties of boreal ecosystems can change rapidly with changes in species composition, whether because of natural succession (Wien and El-Bayoumi 1983; Pastor and Mladenoff 1992; Payette 1992); herbivory (Bryant and Chapin 1986; Pastor *et al.* 1993); human-induced changes through climate warming (Pastor and Post 1988; Bonan *et al.* 1990), or logging (Mladenoff and Pastor 1993a; Haila 1994). The loss of a few species can therefore have significant consequences for ecosystem functioning, but the direction of change depends to a great extent on the functional group to which the species belongs.

References

- Apps, M.J., Kurz, W.A., Luxmoore, R.J., Nilsson, L.O., Sedjo, R.A., Schmidt, R., Simpson, L.G., and Vinson, T.S. 1993. Boreal forests and tundra. *Water, Air and Soil Pollution* **70**: 39–53.

- Bonan, G.B., Pollard, D. and Thompson, S.L. 1992. Effects of boreal forest vegetation on global climate. *Nature* **359**: 716–718.
- Bonan, G.B., Shugart, H.H. and Urban, D.L. 1990. The sensitivity of high-latitude forests to climatic parameters. *Climatic Change* **16**: 9–29.
- Bryant, J.P. and Chapin, F.S., III. 1986. Browsing–woody plant interactions during boreal forest plant succession. In: Van Cleve, K., Chapin, F.S., III, Flanagan, P.W., Viereck, L.A. and Dryness, C.T. (eds), *Forest Ecosystems in the Alaskan Taiga*. 213–225, Springer-Verlag, New York.
- Bryant, J.P., Swihart, R.K., Reichardt, P.B. and Newton, L. 1994. Biogeography of woody plant chemical defense against snowshoe hare browsing: comparison of Alaska and eastern North America. *Oikos* (in press).
- Bryant, J.P., Tahvanainen, J., Sulkinoja, M., Julkunen-Tiitto, R., Reichardt, P.B. and Green, T. 1989. Biogeographic evidence for the evolution of chemical defense by boreal birch and willow against mammalian browsing. *American Naturalist* **134**: 20–34.
- Chapin, F.S., III. 1986. Controls over growth and nutrient use by taiga forest trees. In: Van Cleve, K., Chapin, F.S. III, Flanagan, P.W., Viereck, L.A., and Dryness, C.T. (eds), *Forest Ecosystems in the Alaskan Taiga*, 296–311. Springer-Verlag, New York.
- Clark, J.S. 1989. Effects of long-term water balances on fire regime, north-western Minnesota. *Journal of Ecology* **77**: 989–1004.
- Davis, M.B. and Zabinski, C. 1992. Changes in geographical range resulting from greenhouse warming: effects on biodiversity in forests. In: Peters, R.L. and Lovejoy, T. (eds), *Global Warming and Biodiversity*. 297–308. Yale University Press, New Haven, Conn.
- Flanagan, P.W. and Van Cleve, K. 1983. Nutrient cycling in relation to decomposition and organic matter quality in taiga ecosystems. *Canadian Journal of Forest Research* **13**: 795–817.
- Gorham, E.A. 1991. Northern peatlands: role in the carbon cycle and probable responses to climatic warming. *Ecological Applications* **1**: 182–195.
- Hartman, L. von 1973. Changes in the breeding bird fauna of North Europe. In: Farner, D.S. (ed.), *Breeding Biology of Birds*. 448–481. National Academy of Sciences, Washington, DC.
- Haila, Y. 1994. Preserving ecological diversity in boreal forests: ecological background, research, and management. *Annales Zoologici Fennici* **31**: 203–217.
- Haila, Y., Jarvinen, O. and Vaisanen, R.A. 1980. Effects of changing forest structure on long-term trends in bird populations in southwest Finland. *Ornis Scand.* **11**: 12–22.
- Hansson, L. 1979. On the importance of landscape heterogeneity in northern regions for the breeding population densities of homeotherms: a general hypothesis. *Oikos* **33**: 182–189.
- Haukioja, E., Kapiainen, K., Niemela, P. and Tuomi, J. 1983. Plant availability hypothesis and other explanations of herbivore cycles: complementary or exclusive alternatives? *Oikos* **40**: 419–432.

- Helle, P.** 1984. Effect of habitat area on breeding bird communities in northeastern Finland. *Annales Zoologici Fennici* **21**: 421–425.
- Helle, P.** and Jarvinen, O. 1986. Population trends of North Finnish land birds in relation to their habitat selection and changes in forest structure. *Oikos* **46**: 107–115.
- Holling, C.S.** 1992. The role of forest insects in structuring the boreal landscape. In: Shugart, H.H., Leemans, R. and Bonan, G.B. (eds), *A Systems Analysis of the Global Boreal Forest*, 170–192. Cambridge University Press, Cambridge.
- Jarvinen, O.** and Vaisanen, R. 1977. Long-term changes of the North European land bird fauna. *Oikos* **29**: 225–228.
- Jarvinen, O.** and Vaisanen, R. 1978. Long-term population changes of the most abundant south Finnish forest birds during the past 50 years. *Journal of Ornithology* **119**: 441–449.
- Jarvinen, O., Vaisanen, R.** and Kuusela, K. 1977. Effects of modern forestry on the numbers of breeding birds in Finland in 1945–1975. *Silvae Fennica* **11**: 284–294.
- Johnston, C.A.** and Naiman, R.J. 1990. Aquatic patch creation in relation to beaver population trends. *Ecology* **71**: 1617–1621.
- MacDonald, G.M., Edwards, T.W.D., Moser, K.A., Pienetz, R.** and Smol, J.P. 1993. Rapid response of tree-line vegetation and lakes to past climatic warming. *Nature* **361**: 243–246.
- Mattson, W.J.** and Haack, R.A. 1987. The role of drought in outbreaks of plant-eating insects. *BioScience* **37**: 110–118.
- Mladenoff, D.J.** and Pastor, J. 1993. Sustainable forest ecosystems in the northern hardwood and conifer region: Concepts and management. In: Aplet, G.H., Johnson, N., Olson, J.T., and Sample, V.A. (eds), *Defining Sustainable Forestry*, 145–180. Island Press, New York.
- Olson, J.S., Watts, J.A.,** and Allison, L.J. 1983. Carbon in live vegetation of major world ecosystems. *Oak Ridge National Laboratory Technical Report ORNL-5862*, Oak Ridge, Tenn.
- Pastor, J., Bonde, J., Johnston, C.A.** and Naiman, R.J. 1993b. Markovian analysis of the spatially dependent dynamics of beaver ponds. *Lectures on Mathematics in the Life Sciences* **23**: 5–27.
- Pastor, J., Dewey, B., Naiman, R.J., McInnes, P.F.** and Cohen, Y. 1993a. Moose browsing and soil fertility in the boreal forests of Isle Royale National Park. *Ecology* **74**: 467–480.
- Pastor, J.** and Johnston, C.A. 1992. Using simulation models and geographic information systems to integrate ecosystem and landscape ecology. In: Naiman, R.J. (ed.), *Watershed Management: Balancing sustainability with environmental change*, 324–346. Springer-Verlag, New York.
- Pastor, J.** and Mladenoff, D.J. 1993. The southern boreal–northern hardwood forest border. In: Shugart, H.H., Leemans, R. and Bonan, G.B. (eds), *A Systems Analysis of the Global Boreal Forest*, 216–240. Cambridge University Press, Cambridge.
- Pastor, J.** and Naiman, R.J. 1992. Selective foraging and ecosystem processes in boreal forests. *American Naturalist* **139**: 690–705.
- Pastor, J.** and Post, W.M. 1988. Response of northern forests to CO₂-induced climate change. *Nature* **334**: 55–58.
- Payette, S.** 1992. Fire as a controlling process in the North American boreal forest. In: Shugart, H.H., Leemans, R. and Bonan, G.B. (eds), *A Systems Analysis of the Global Boreal Forest*, 144–169. Cambridge University Press, Cambridge.
- Payette, S., Filion, L., Gauthier, L.** and Boutin, Y. 1985. Secular climate change in old-growth tree-line vegetation of northern Quebec. *Nature* **315**: 135–138.
- Post, W.M.** (ed.) 1990. Report of a Workshop on Climate Feedbacks and the Role of Peatlands, Tundra, and Boreal Ecosystems in the Global Carbon Cycle. *Oak Ridge National Laboratory Technical Monograph ORNL/TM-11457*, Oak Ridge, Tenn.
- Roulet, N.T., Ash, R.** and Moore, T.R. 1992. Low boreal wetlands as a source of atmospheric methane. *Journal of Geophysical Research* **97**: 3739–3749.
- Shugart, H.H., Leemans, R.** and Bonan, G.B. (eds) 1992. *A Systems Analysis of the Global Boreal Forest*. Cambridge University Press, Cambridge.
- Telfer, E.S.** 1992. Wildfire and the historical habitats of boreal forest avifauna. In: Kuhnke, D.H. (ed.), *Birds in the Boreal Forest*, 27–39. Northern Forestry Centre, Edmonton, Alberta.
- Updegraff, K., Pastor, J., Bridgham, S.D.** and Johnston, C.A. 1995. Environmental and substrate quality controls over carbon and nitrogen mineralization in a beaver meadow and a bog. *Ecological Applications*, (in press).
- Virkkala, R.** 1987. Effects of forest management on birds breeding in northern Finland. *Annales Zoologici Fennici* **24**: 281–294.
- Virkkala, R.** 1991. Population trends of forest birds in Finnish Lapland in a landscape of large habitat blocks: consequences of stochastic environmental variation or regional habitat alteration? *Biological Conservation* **56**: 223–240.
- Wein, R.W.** and El-Bayoumi, M.A. 1983. Limitations to predictability of plant succession in northern ecosystems. In: Wein, R.W., Riewe, R.R. and Methven, I.R. (eds), *Resources and Dynamics of the Boreal Zone*, 214–225. Association of Canadian Universities for Northern Studies, Ottawa.

6.1.7 Temperate grasslands

6.1.7.1 Introduction

Grasslands are the potential natural vegetation on approximately 25% ($33 \times 10^6 \text{ km}^2$) of the land surface of the Earth (Shantz 1954), although estimates of their current extent range from 16% (Whittaker and Likens 1975) to 30% (Ajtay *et al.* 1979).

Three aspects of grassland environments distinguish them from other ecosystem types (Anderson 1982; Milchunas *et al.* 1988): these are drought, fire and grazing by large ungulate herbivores. All three factors provide selection pressures favouring high turnover of above-ground plant organs, location of perennating organs near the soil surface, and location of a large fraction of plant biomass and activity below ground. Drought is a frequent influence on dry grasslands: fire is a much more significant force in shaping grasslands in humid regions than it is in dry regions. Grazing can be an important evolutionary force across the moisture gradient but its specific influence depends upon the moisture status of the site (Milchunas *et al.* 1988). Adaptations that enhance survival in arid and semi-arid environments may promote tolerance or

avoidance to grazing (Coughenour 1985). Therefore, grazing should have a larger effect on the species composition in humid than in arid and semi-arid grasslands (Milchunas *et al.* 1988).

6.1.7.2 Human impact on biodiversity

The most common use of grasslands is for grazing by domestic animals to produce mainly meat, milk and fibre. The first management action in most cases has been to replace native grazers and their predators with a few species of domestic animals. In an attempt to enhance animal production, humans have tried to increase primary production and/or animal consumption. Techniques aimed at increasing primary production, such as fertilization and irrigation, are all practices that raise resource availability for plants. Given that domestic animals have a selective intake, a large fraction of management techniques attempts to change species composition to match domestic animal preference. By their selective grazing behaviour, livestock tend to modify species composition in opposition to the efforts of managers. Even minimum husbandry has resulted in significant increases in animal biomass density in vast grassland regions (Oesterheld *et al.* 1992).

Grazing does not necessarily reduce plant biodiversity although overgrazing can result in losses of diversity at the population, species, ecosystem and landscape levels. The lack of grazing in some grassland types also results in biodiversity losses (Sala *et al.* 1986; Sala 1988). In general, ecosystem enrichment via fertilization or irrigation results in a decrease in diversity at the population and species levels (Tilman 1993). The replacement of animal or plant species by introduced species has a clear and direct negative effect on biological diversity. Changes in ecosystem and landscape diversity occur as a result of habitat selection by livestock (Smith *et al.* 1992) and replacement of native ecosystems by cultivated grasslands and croplands (Burke *et al.* 1991).

6.1.7.3 Productive capacity

Human impact on biodiversity. Primary production is most often manipulated by the addition of water or mineral nutrients. Both kinds of resource additions directly and indirectly modify biodiversity (Rosensweig 1971; Mellinger and McNaughton 1975; Lauenroth *et al.* 1978; Tilman 1993).

Ecosystem consequences of the impacts. A decrease in species richness, with initial deletion of the rarest species, results in no change in primary production until a threshold is reached beyond which there is a steady and substantial decrease in production (Figure 6.1-2). Removal of rare species in the Serengeti grasslands resulted in full compensation of production by the remaining species (McNaughton 1983). Deletion of species of intermediate

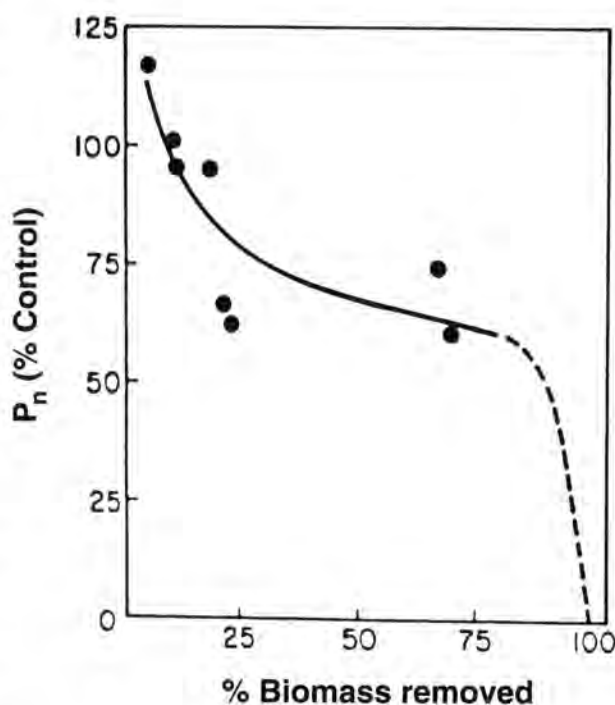

Figure 6.1-2: The effect upon primary productivity (P_n) of removing species that have different biomass in the intact ecosystems. In each case, all the individuals of a different species were removed. Remaining species were able to compensate for the removal of species with small biomass but were not able to compensate for the removal of the most abundant species (From: McNaughton 1983).

abundance resulted in production being only partially compensated. Finally, removal of dominant species resulted in a significant decrease in production.

Grasslands provide several examples in which the relationship between diversity and primary production has been assessed experimentally. The sites studied are geographically diverse and include California annual grasslands, old fields in New York, and grasslands in the Serengeti (McNaughton 1993). Results are contradictory: a negative relationship was observed between productivity and biodiversity in the annual grasslands of California and in the old fields of New York, whereas no relationship between productivity and diversity was found in the Serengeti. The effects of species diversity on production should be assessed with reference to which species have been deleted, and with respect to the driving forces behind the observed changes in diversity, rather than the diversity itself. In the case of the Serengeti, differences in diversity resulted from differences in grazing regime, while in the old fields in New York the diversity differences were a consequence of a successional process.

The diversity–stability hypothesis (McNaughton 1977) suggests that perturbations will result in a larger change in

ecosystem functioning in simple systems than in diverse systems. There is experimental evidence to test this hypothesis in grasslands. McNaughton (1993) analysed the response to a perturbation caused by fertilization along a diversity gradient which emerged as a result of a successional process. Similarly, Tilman and Downing (1994) analysed the response to a perturbation caused by a severe drought along a diversity gradient resulting from an experimental nitrogen fertilization where diversity was maximum in the native system and decreased as fertility increased (Figure 6.1-3). In both cases, the effect of perturbation on production was at a maximum in the simple systems and a minimum in the most diverse systems. The conclusions emerging from the experiment which used a diversity gradient created by differential fertilization has been criticized because greater soil fertility generally favours plants with lower root: shoot ratio, higher leaf conductance, and greater photosynthetic capacity (Givnish 1994). These characteristics also result in lower drought resistance. Therefore, the largest effect of drought observed in low diversity plots could have been the result of those plots being dominated by drought sensitive plants. The critical experiment to address this question has not been done yet: it would compare the response to similar perturbations of ecosystems with different levels of natural or experimentally created diversity, and should disentangle the effect of diversity from the effect of individual species.

6.1.7.4 Decomposition and soil structure

Human impact on biodiversity. Range managers use chemical, fire and mechanical means to modify plant species composition by deleting those species that are least preferred by domestic animals or by adding those that are highly preferred. Selective grazing by domestic herbivores also modifies plant species composition.

Ecosystem consequences of the impacts. The effects of biodiversity on decomposition in grasslands can be viewed from the plant perspective or the microbial perspective. Microbial diversity is not well documented in grasslands and its effect on decomposition is even less clearly understood. The effects of plant species diversity on decomposition result mainly from differences in litter quality among species. Several experiments have demonstrated the importance of species characteristics to total soil nutrients, nutrient availability and the rate of decomposition (e.g. Wedin and Tilman 1990; Matson 1990; Hobbie 1992; Vinton and Burke in press).

6.1.7.5 Water distribution and balance

Human impact on biodiversity. Management manipulations and foraging behaviour may change biodiversity. Large areas of grasslands in North America and Africa have slowly changed into shrublands and savannahs presumably as a result of grazing (Buffington

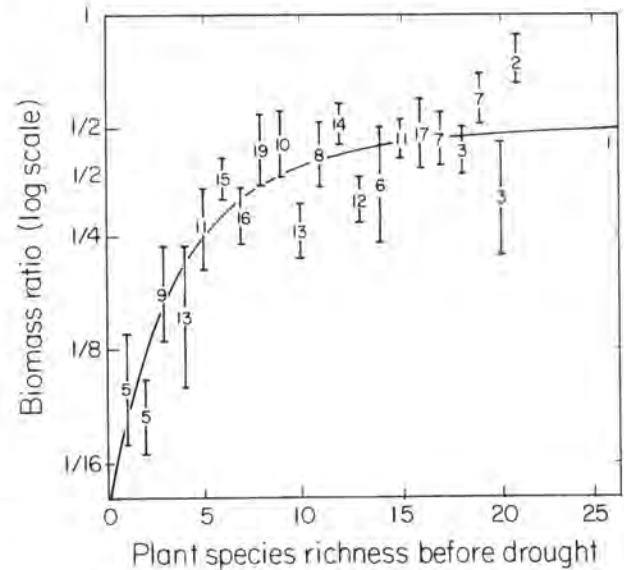

Figure 6.1-3: The effect of plant species richness before a severe drought on above-ground biomass during the drought year expressed as a fraction of previous year biomass. Standard error and number of plots with a given species richness are shown. The gradient of species richness was experimentally created by fertilization (from: Tilman and Downing 1994).

and Herbel 1965; Walker *et al.* 1981; van Vegten 1983; Neilson 1986; Archer 1989).

Ecosystem consequences of the impacts. Important input and output flows, which determine water balance and distribution of water, change with the scale of the unit under consideration. At the ecosystem level, the major flows are transpiration, bare soil evaporation, deep percolation, run-on, run-off and precipitation. At the plant level, transpiration is the only relevant flow but at higher levels of organization, watershed variables become dominant. All the output flows of water at one scale are intimately related, and although the biotic components directly affect mainly absorption and transpiration, they affect all other components of the water balance indirectly.

Reduction of transpiration as a result of species deletions is related to species-specific characteristics that affect water dynamics. Rooting depth, phenology, maximum transpiration rate, drought resistance or avoidance are all species characteristics that affect water balance. Species with deep roots are able to absorb water from a different part of the soil profile than species with shallow roots. Species with different phenological patterns (early vs late season) are able to use water available at different times of the year. In addition, many of these characteristics are self-associated. For example, late season phenology is associated in several systems to xerophytism or deep root systems (Gulmon *et al.* 1983; Golluscio and Sala 1993).

Experiments and associated models of grassland water dynamics have shown how removal of functional types such as perennial grasses or shrubs results in profound

alterations of the ecosystem water balance (Knoop and Walker 1985; Paruelo and Sala 1995). Deep percolation losses increase as a result of a decrease in the abundance of one of the functional types and the distribution of water in the soil profile changes as a result of deleting deep or shallow root functional types. Only a fraction of the water freed by the removal of a functional type is used by the remaining functional type (Sala *et al.* 1989). Most of these experiments focused on the deletions of entire functional types, providing no experimental evidence for the effects of deleting individual species.

6.1.7.6 Atmospheric properties

Human impact on biodiversity. Range management results in changes in biodiversity as described previously.

Ecosystem consequences of the impacts. Atmospheric CO₂ is an important trace gas and a major component of the carbon cycle. We have described how biological diversity at scales ranging from species to landscapes affects production and decomposition which are the major processes driving the carbon cycle. We are not aware of any studies relating species diversity to atmospheric properties. However, Burke *et al.* (1991) calculated the effects on the carbon balance of converting a large fraction of the North America Central Grassland Region into cropland. Cultivation resulted in a net release of carbon from soil organic matter larger than the expected loss as a result of climate change. The current increase in atmospheric methane is not related to an increase in the number of grazing mammals (Crutzen *et al.* 1986).

6.1.7.7 Landscape structure

Human impact on biodiversity. Croplands have expanded dramatically during this century, from 9.1×10^6 to 15×10^6 km² (Richards 1990). This expansion has altered landscape heterogeneity in grasslands. Habitat selectivity by domestic livestock has differentially influenced riparian ecosystems and therefore altered landscape diversity. Domestic livestock, and especially cattle, tend to congregate in the topographically lowest portions of the landscape (Senft *et al.* 1985; Pinchak *et al.* 1991). Such habitat selectivity has negative effects on the plant and animal diversity of riparian ecosystems (Kauffman and Krueger 1984; Smith *et al.* 1992).

Ecosystem consequences of the impacts. The reduction in diversity of streamside vegetation and its productivity have negative effects on both physical and chemical indicators of water quality (Kauffman and Krueger 1984). Reduction in the diversity and productivity of the herbaceous vegetation layer can change the velocity and erosive energy of the stream flow, while losses of the woody overstorey have large effects on water temperature. Both the overstorey and understorey vegetation layers have important effects on the rates and kinds of aquatic

processes that occur in a stream (Kauffman and Krueger 1984), and the diversity and productivity of invertebrates and fishes are profoundly influenced by the diversity of the streamside vegetation.

6.1.7.8 Biotic linkages and species interactions

Human impact on biodiversity. Invasions in grasslands are common and in some cases have been associated with changes in grazing regime. Examples of grasslands that have been invaded by exotic species are the California grasslands and the intermontane west of North America, the *pampas* in South America, and the savannahs in tropical South America (Sala *et al.* 1986; D'Antonio and Vitousek 1992).

Ecosystem consequences of the impacts. Invasions in grasslands have usually occurred in association with an increase in grazing intensity and/or a change in dominant grazer. Vulnerability to invasions associated with grazing appears to be related to moisture availability and the grazing history in evolutionary time (Milchunas *et al.* 1988). Grasslands that evolved under light grazing conditions and under mesic conditions are more vulnerable to invasions than those that evolved under heavy grazing in xeric environments. Semi-arid grasslands of the northwest USA and southwest Canada have a short evolutionary grazing history, and before the introduction of cattle they were dominated by perennial tussock grasses (Tisdale 1947; Daubenmire 1970). The inability of these grasses to cope with heavy grazing resulted in the invasion and dominance of many areas by Eurasian weeds (Daubenmire 1940, 1970; Ellison 1960; Mack 1981; Mack and Thompson 1982). Invasions often disrupt competitive interactions (D'Antonio and Vitousek 1992) which result in changes in species composition with the ecosystem effects described above.

6.1.7.9 Microbial activities

Human impact on biodiversity. See discussion of decomposition and soil structure above.

Ecosystem consequences of the impacts. The effect of changes in plant species diversity on microbial activity as a result of changes in litter quality and quantity are described in the decomposition section above.

6.1.7.10 Summary and relevance to human activities

On a world-wide basis the response of grasslands to the major human use – domestic livestock grazing – has been variable (Milchunas and Lauenroth 1993). In some areas where the native vegetation is well adapted as a result of evolution, changes in biodiversity have been very small (Milchunas *et al.* 1988). In other areas changes have been very large. In some cases and especially in tropical and subtropical grasslands, the large changes have involved a shift from a grass-dominated vegetation to one dominated

by woody plants (Walker *et al.* 1981; vanVegten 1983; Archer 1989). In other cases the large changes have involved invasions of exotic plants which have profoundly altered the ecosystems. Conversion of grasslands to croplands or seeded pastures has also had a major influence on biodiversity and ecosystem functioning. In many cases these converted grasslands have become net sources of carbon and nutrients accelerating global change. These major transformations of grasslands and their effects on biodiversity modify the water, carbon and nutrient cycles to an extent that significantly contributes to altering the Earth's life support system.

References

- Ajtay, G.L., Ketner, P. and Duvigneaud, P. 1979. Terrestrial primary production and phytomass. In: Bolin, B., Degens, E., Kempe, S. and Ketner, P. (eds), *The Global Carbon Cycle*, SCOPE edition. Vol. 13, 129-182. John Wiley, Chichester.
- Anderson, R.C. 1982. An evolutionary model summarizing the roles of fire, climate, and grazing animals in the origin and maintenance of grasslands. In: Estes, J.R. and Tyrl, R.J. (eds), *Grasses and Grasslands: Systematics and ecology*, 312. University of Oklahoma Press, Norman.
- Archer, S. 1989. Have southern Texas savannahs been converted to woodlands in recent history? *American Naturalist* **134**: 545-561.
- Buffington, L.C. and Herbel, C.H. 1965. Vegetational changes on a semidesert grassland range from 1858 to 1963. *Ecological Monographs* **35**: 139-164.
- Burke, I.C., Kittel, T.G.F., Lauenroth, W.K., Snook, P., Yonker, C.M. and Parton, W.J. 1991. Regional analysis of the central great plains. *BioScience* **41** (10): 685-692.
- Coughenour, M.B. 1985. Graminoid responses to grazing by large herbivores: adaptations, exaptations, and interacting processes. *Annals of the Missouri Botanical Garden* **72**: 852-863.
- Crutzen, P.J., Aselmann, I. and Seiler, W. 1986. Methane production by domestic animals, wild ruminants, other herbivorous fauna and humans. *Tellus* **38B**: 271-284.
- D'Antonio, C.M., and Vitousek, P.M. 1992. Biological invasions by exotic grasses, the grass/fire cycle, and global change. *Annual Review of Ecology and Systematics* **23**: 63-87.
- Daubenmire, R. 1940. Plant succession due to overgrazing in the *Agropyron* bunchgrass prairie of south-eastern Washington. *Ecology* **21**: 55-65.
- Daubenmire, R. 1970. *Steppe vegetation of Washington*. Washington Agriculture Experimental Station Technical Bulletin Edition. Vol. 62. Washington State University, Pullman.
- Ellison, L. 1960. Influence of grazing on plant succession of rangelands. *Botanical Review* **26**: 1-78.
- Givnish, T.J. 1994. Does diversity beget stability? *Nature* **371**: 113-114.
- Golluscio, R.A., and Sala, O.E. 1993. Plant functional types and ecological strategies in Patagonian forbs. *Journal of Vegetation Science* **4**: 839-846.
- Gulmon, S.L., Chiariello, N.R., Mooney, H.A. and Chu, C.C. 1983. Phenology and resource use in three co-occurring grassland annuals. *Oecologia* **58**: 33-42.
- Hobbie, S.E. 1992. Effects of plant species on nutrient cycling. *Trends in Ecology and Evolution* **7**: 336-339.
- Kauffman, J. B., and Krueger, W.C. 1984. Livestock impacts on riparian ecosystems and streamside management implications: a review. *Journal of Range Management* **37**: 430-437.
- Knoop, W.T. and Walker, B.H. 1985. Interactions of woody and herbaceous vegetation in a Southern African Savannah. *Journal of Ecology* **73**: 235-253.
- Lauenroth, W.K., Dodd, J.L. and Sims, P.L. 1978. The effects of water- and nitrogen-induced stresses on plant community structure in a semiarid grassland. *Oecologia* **36**: 211-222.
- Mack, R.N. 1981. Invasion of *Bromus tectorum* L. into western North America: an ecological chronicle. *Agro Ecosystems* **7**: 145-165.
- Mack, R.N. and Thompson, J.N. 1982. Evolution in steppe with few large, hooved mammals. *American Naturalist* **119**: 757-773.
- McNaughton, S.J. 1977. Diversity and stability of ecological communities: a comment on the role of empiricism in ecology. *American Naturalist* **111**: 515-525.
- McNaughton, S.J. 1983. Serengeti grassland ecology: the role of composite environmental factors and contingency in community organization. *Ecological Monographs* **53**: 291-320.
- McNaughton, S.J. 1993. Biodiversity and function of grazing systems. In: Schulze, E.-D. and Mooney, H.A. (eds), *Biodiversity and Ecosystem Function*, 361-383. Springer-Verlag, Berlin.
- Matson, P. 1990. Plant-soil interactions in primary succession at Hawaii Volcanoes National Park. *Oecologia* **85**: 241-246.
- Mellinger, M.V. and McNaughton, S.J. 1975. Structure and function of successional vascular plant communities in central New York. *Ecological Monographs* **45**: 161-182.
- Milchunas, D.G. and Lauenroth, W.K. 1993. Quantitative effects of grazing on vegetation and soils over a global range of environments. *Ecological Monographs* **63**: 327-366.
- Milchunas, D.G., Sala, O.E. and Lauenroth, W.K. 1988. A generalized model of the effects of grazing by large herbivores on grassland community structure. *American Naturalist* **132**: 87-106.
- Neilson, R.P. 1986. High resolution climatic analysis and Southwest biogeography. *Science* **232**: 27-34.
- Oosterheld, M., Sala, O.E. and McNaughton, S.J. 1992. Effect of animal husbandry on herbivore-carrying capacity at a regional scale. *Nature* **356**: 234-236.
- Paruelo, J.M., and Sala, O.E. 1995. Water losses in the Patagonian steppe: a modelling approach. *Ecology* **76**: 510-520.
- Pinchak, W.E., Smith, M.A., Hart, R. H. and Waggoner, J.W. 1991. Beef cattle grazing distribution patterns on foothill range. *Journal of Range Management* **44**: 267-275.
- Richards, J.F. 1990. Land transformation. In: Turner, B.L., II, Clark, W.C., Kates, R.W., Richards, J., Mathews, J.T and Meyer, W.B. (eds.) *The Earth as Transformed by Human Action*, 161-178. Cambridge University Press, Melbourne.
- Rosenzweig, M.L. 1971. Paradox of enrichment: destabilization of exploitation ecosystems in ecological time. *Science* **171**: 385-387.

- Sala, O.E. 1988. The effect of herbivory on vegetation structure. In: Werger, M.G.A., van der Aart, P.J.M., During, H.J. and Verhoeven, J.T.A. (eds), *Plant Form and Vegetation Structure*. 317–330. SPB Academic Publishing, The Hague.
- Sala, O.E., Golluscio, R.A., Lauenroth, W.K. and Soriano, A. 1989. Resource partitioning between shrubs and grasses in the Patagonian steppe. *Oecologia* **81**: 501–505.
- Sala, O.E., Oesterheld, M., León, R.J.C. and Soriano, A. 1986. Grazing effects upon plant community structure in subhumid grasslands of Argentina. *Vegetatio* **67**: 27–32.
- Senft, R.L., Rittenhouse, L.R. and Woodmansee, R.G. 1985. Factors influencing patterns of cattle grazing behavior on shortgrass steppe. *Journal of Range Management* **38**: 82–86.
- Shantz, H.L. 1954. The place of grasslands in the earth's cover of vegetation. *Ecology* **35**: 142–145.
- Smith, M.A., Rogers, J.D., Dodd, J.L. and Skinner, Q.D. 1992. Habitat selection by cattle along an ephemeral channel. *Journal of Range Management* **45**: 385–390.
- Tilman, D. 1993. Species richness of experimental productivity gradients: how important is colonization limitation? *Ecology* **74**: 2179–2191.
- Tilman, D. and Downing, J.A. 1994. Biodiversity and stability in grasslands. *Nature* **367**: 363–365.
- Tisdale, E.W. 1947. The grasslands of the southern interior of British Columbia. *Ecology* **28**: 346–382.
- van Vegten, J.A. 1983. Thornbush invasion in a savannah ecosystem in eastern Botswana. *Vegetatio* **56**: 3–7.
- Walker, B.H., Ludwig, D., Holling, C.S. and Peterman, R.M. 1981. Stability of semi-arid savannah grazing systems. *Journal of Ecology* **69**: 473–498.
- Wedin, D.A., and Tilman, D. 1990. Species effects on nitrogen cycling: a test with perennial grasses. *Oecologia* **84**: 433–441.
- Whittaker, R.H. and Likens, G.E. 1975. The biosphere and man. In: Lieth, G.E. and Whittaker, R.H. (eds), *Primary productivity of the biosphere*. Ecological Studies Edition, Vol. 14. 305–328. Springer-Verlag, New York.

6.1.8 Mediterranean-type ecosystems

6.1.8.1 Introduction

Mediterranean-type ecosystems share a climate of cool wet winters and a distinct summer drought, and are found in the Mediterranean Basin, California, Chile, the Cape Province of South Africa and southwestern and southern Australia. Estimates of biome cover vary depending on the climatic classification used, but are approximately as follows, given as 10^6 km² (estimates of numbers of plant species in each region are given in parentheses where available): Mediterranean Basin 1.87 (*c.* 25 000), California 0.32 (5050), Chile 0.14 (*c.* 2100), Cape Province 0.09 (*c.* 8550), Southwestern Australia 0.31 (*c.* 8000) (Quézel 1981; Cowling *et al.* 1992; Fuentes *et al.* 1995; Hobbs *et al.* 1995; Keeley and Swift 1995). The last four regions are listed as 'hot spots' for species diversity by WCMC (1992), although parts of the Mediterranean Basin also possess high plant diversities, as estimated on a species per km² basis (Davis *et al.* 1986; Valdés *et al.* 1987; Moreno Saiz

and Sainz Ollero 1993). The five regions have markedly different biogeographic characteristics, histories and current patterns of human habitation and use, and markedly different patterns of biodiversity. These differences are most clearly obvious between the Mediterranean region, which has a long history of human habitation, and some of the areas more recently settled by Europeans, such as Australia. Mediterranean-type ecosystems consist of a variety of vegetation types, including forest, woodland, shrubland and grassland. A feature of many of the vegetation types is their sclerophyllous nature, and high levels of secondary compounds such as terpenes. Floristic diversity and degree of endemism are high in most Mediterranean areas, and shrublands in Australia and South Africa are particularly noted for their high floristic diversity.

Human impacts on biodiversity vary between regions, and include both positive and negative components. In the Mediterranean Basin, where human activities have modified the landscape for thousands of years, current levels of biodiversity are in part maintained by continued human influence. Where traditional human activities cease, plant and animal diversity can be reduced (González Bernáldez 1991; Naveh 1994) and susceptibility to disturbances, especially fire, can be increased (Moreno 1989). This in turn can promote landscape homogenization, with resultant negative effects on biodiversity (Faraco *et al.* 1993; Pérez *et al.* in press). Landscape homogenization can also result from the abandonment of agricultural/pastoral land (Fernández-Alés *et al.* 1992). Human activities have also played an important role in determining the distribution of vegetation and ecosystems in Chile, and may be important in the retention of components of the biodiversity within these ecosystems (Fuentes and Muñoz 1994; Fuentes *et al.* 1995).

In South Africa and Australia, and in California, human impacts are largely negative. These include reductions in population size and/or distribution of sensitive species which have occurred as a result of land-use changes and fragmentation (Saunders 1989, 1993; Hopper *et al.* 1990; Cowling and Bond 1992; Hopper 1992). Reduced age structure diversity of dominant species results from altered disturbance regimes (Yates *et al.* 1994); genetic diversity is reduced through habitat loss (Rebelo 1992), and loss of species diversity is caused by introduced predators, herbivores, plants and diseases (Mooney *et al.* 1986; di Castri *et al.* 1990; Groves and di Castri 1991; Scougall *et al.* 1993; Wills 1993).

Reduced structural complexity can occur because of management practices such as post-fire re-seeding (Barro and Conrad 1987) or deforestation, but this is countered in some cases by local increases in complexity through reforestation (Blondel 1976). Human activities can maintain structural diversity where vegetation patterns are

largely a result of past activities, especially in the Mediterranean Basin and Chile. Ecosystem and landscape fragmentation and simplification result from agriculture, forestry and urbanization, and changed disturbance regimes. This includes the addition of new disturbances, modification of natural regimes, and the discontinuation of traditional human management (Le Houérou 1990; Van Wilgen *et al.* 1992; Aronson *et al.* 1993; Hobbs 1993; Hobbs *et al.* 1993; Keeley 1993). The introduction of exotic species and altered disturbance regimes affect biodiversity at all levels. The likely magnitude of impacts is uncertain and varies between regions.

6.1.8.2 Productive capacity, biomass and decomposition

Human impacts on biodiversity. Changes in productive capacity and biomass result from type conversions, the invasion of exotic species, grazing by introduced herbivores, spread of pathogens and changed disturbance/management regimes (references in Introduction)

Ecosystem consequences of impacts. Impacts on biodiversity can cause a net decline in biomass and productive capacity in areas subject to transformation by agriculture (with a switch toward human-orientated productivity), urbanization or grazing (Scougall *et al.* 1993; Keeley 1993). Reduced diversity may lead to reduced resilience to episodic disturbances such as fire, flood and drought (Atkins and Hobbs 1995). Effects on resilience will become apparent only over long time-frames. Localized increase in productive capacity can occur where invasion by N-fixers occurs (Macdonald and Richardson 1986; Stock and Allsop 1992). This also occurs after fire or abandonment in the Mediterranean Basin, where fast-growing native legumes invade (Faraco *et al.* 1993; Pérez *et al.*, 1995).

6.1.8.3 Soil structure and nutrients

Human impacts on biodiversity. Changes result from type conversions, agricultural development and loss of native plant cover, changes in grazing management, and changed fire regimes (references in Introduction)

Ecosystem consequences of impacts. Reduced uptake and increased efflux can occur where there is a loss of functional groups with specialized uptake mechanisms (Hobbs 1993b). Reduced soil aeration and loss of macropore structure result from the loss of soil macrofauna (Hobbs *et al.* 1995). These are certain, widespread impacts. Nitrogen fixation can increase or decrease following addition or deletion of N-fixers (Stock and Allsop 1992), with concomitant changes in ecosystem response to disturbance. The direction of change is dependent on which species are added or lost. Changed fire cycles and intensities lead to changes in soil chemical and structural properties, erodability and nutrient losses (Scott and van Wyk 1990; Marion *et al.* 1991; Giovannini 1994; Riggan *et al.* 1994). Fire intensity can profoundly alter post-fire

ecosystem functioning, both directly and indirectly (Moreno and Oechel 1994). These are likely to be localized effects.

6.1.8.4 Water distribution, balance and quality

Human impacts on biodiversity. Changes result from agricultural development and loss of native plant cover, loss of riparian and wetland vegetation, and reduced landscape heterogeneity through fragmentation, land abandonment and afforestation (references in Introduction).

Ecosystem consequences of impacts. Reduced structural and landscape diversity leads to reduced buffering and greater peak flows. Reduced diversity of groups with specialized water redistribution and uptake mechanisms leads to reduced internal redistribution, lower water use, greater vertical and horizontal water movement and increased salinization and erosion (Nulsen *et al.* 1986; Scott and van Wyk 1992; McFarlane *et al.* 1992, 1993). Reduced species and landscape diversity also lead to reduced resilience to episodic high rainfall events, for the same reasons. These are certain, widespread effects, which occur over time scales of years to decades. The use of natural water containing non-pathogenic levels of *Phytophthora cinammomi* for irrigation leads to pathogenic outbreaks in transformed systems (Von Broemsen 1984).

6.1.8.5 Atmospheric properties

Human impacts on biodiversity. Of potential importance is the large-scale removal of complex perennial vegetation and its replacement by agriculture (Hobbs *et al.* 1993).

Ecosystem consequences of impacts. Regional changes in albedo, evaporation, cloud formation and rainfall distribution may be caused by changes from complex perennial vegetation to annual crop and pasture land (Smith *et al.* 1992). Changes are uncertain, but could be widespread.

6.1.8.6 Landscape and waterscape structure

Human impacts on biodiversity. Fragmentation, urbanization, type conversion, deforestation and reforestation, and changes in disturbance regimes (references in Introduction) are particularly important.

Ecosystem consequences of impacts. Impacts result in reduced landscape diversity and connectivity and increased probability of landscape degradation (Fernández Alés *et al.* 1992; Hobbs *et al.* 1993; Keeley 1993). Reduced landscape and structural diversity around water bodies leads to changes in chemical, physical and biotic characteristics (e.g. a change from freshwater to saline: Froend *et al.* 1987; Bell and Froend 1990; Froend and McComb 1991). There is also a higher probability of irreversible system change following episodic storm events. Changes could be widespread.

6.1.8.7 Biotic linkages and species interactions

Human impacts on biodiversity. Species introductions have potentially large impacts on diversity at all levels

(Mooney *et al.* 1986; di Castri *et al.* 1990; Groves and di Castri 1991) and species deletions can result from changes in landscape structure caused by habitat modification, homogenization, fragmentation and changes in utilization patterns (references in Introduction).

Ecosystem consequences of impacts. Consequences include the disruption of obligatory mutualisms involving for example pollination or dispersal and the breakdown of complex systems of predator–prey and plant–herbivore interactions (Fuentes and Etchegaray 1983; Bond and Slingsby 1984; Bond and Stock 1989; Jaksic *et al.* 1992; Main 1992; Norton *et al.* 1994; Fuentes *et al.* 1995). Such changes may have potential follow-on effects on productive capacity, nutrient uptake and retention, and ecosystem response to disturbance, although the exact nature of these follow-on effects will be difficult to predict. Introduced plant species have been shown to have a positive effect on honey production in Chile, which is dependent on the presence of an array of species with different flowering times (Fuentes *et al.* 1995). Follow-on effects are most likely where the species lost are ‘keystones’ or have no functional equivalents.

6.1.8.8 Microbial activities

Human impacts on biodiversity: New suites of micro-organisms, including pathogens, soil micro-organisms and nitrogen-fixing and mycorrhizal symbionts have been introduced into areas where they were previously absent (Stock and Allsopp 1992). Human modification of ecosystems may also induce pathogenic outbreaks of organisms previously present at non-pathogenic levels (Von Broembsen 1984). Alterations to soil and litter characteristics resulting from agriculture and ecosystem modification will lead to changes in microbial activities, although it is not known exactly how microbial diversity is affected (e.g. Brandenburg and Sparling 1990).

Ecosystem consequences of impacts. Introduced pathogens dramatically alter ecosystem structure and functioning, and can differentially affect specific plant functional groups (Wills 1993; Hobbs 1993a). Loss of N-fixers through altered disturbance regimes, or their addition through introduction with invasive plants may alter nutrient cycling (Hobbs 1992; Stock and Allsopp 1992). Pathogens that cause the death of above-ground plant parts may also alter fuel properties and hence affect fire behaviour and intensity (Riggan *et al.* 1994). Changes in microbial populations also lead to changes in soil respiration (Brandenburg and Sparling 1994). The extent and importance of these changes is largely unknown.

6.1.8.9 Summary and relevance to human activities

Mediterranean-type ecosystems are generally made up of a mosaic of different vegetation types, and the five Mediterranean regions, while resembling each other in

some ways, differ greatly in their levels of diversity and degree of modification. This heterogeneity both between and within regions makes generalizations difficult. Mediterranean regions are generally heavily populated and modified, and the major impacts on biodiversity arise from this modification, particularly at the landscape scale. In the Mediterranean Basin, the continuation of traditional human activities maintains landscape heterogeneity and has a positive influence on biodiversity, while in Australia, recent human activities have had the opposite effect of reducing heterogeneity and negatively influencing biodiversity. The three other regions fall between these two extremes.

The likely consequences of changes in biodiversity are often unclear. In systems that are very species-rich, such as the South African *fynbos* or the Australian *kwongan*, the ecosystem effects of the loss of particular species may be minimal in the short term, although the longer term impacts on resilience to change and disturbance may be more important. On the other hand, reductions in ecosystem and landscape diversity have already had profound impacts in terms of altered hydrology and reduced agricultural production.

References

- Aronson, J., Floret, C., Le Floc'h, E., Ovalle, C. and Pontanier, R. 1993.) Restoration and rehabilitation of degraded ecosystems. *Restoration Ecology* **1**: 1–10.
- Atkins, L. and Hobbs, R.J. 1995.) Measurement and effects of fire heterogeneity in southwest Australian wheatbelt vegetation. *CALMScience* **2**: (in press).
- Barro, S.C. and Conrad, S.G. 1987. *Use of Ryegrass Seeding as an Emergency Revegetation Measure in Chaparral Ecosystems*. USDA Forest Service, General Technical Report PSW-102.
- Bell, D.T. and Froend, R.H. 1990. Mortality and growth of species under stress at Lake Toolibin in the Western Australian wheatbelt. *Journal of Royal Society of Western Australia* **72**: 63–66.
- Blondel, J. 1976. L'influence des reboisements sur les communautés d'oiseaux, l'exemple du Mont-Ventoux. *Ann. Sci. Forest.* **33**: 221–245.
- Bond, W.J. and Slingsby, P. 1984. Collapse of an ant plant mutualism – the Argentine ant, *Iridomyrmex humilis* and myrmecochorous Proteaceae. *Ecology* **65**: 1031–1037.
- Bond, W.J. and Stock, W.D. 1989. The costs of leaving home: ants disperse myrmecochorous seeds to low nutrient sites. *Oecologia* **81**: 412–417.
- Brandenburg, A. and Sparling, G.P. 1990. A comparison of total C, microbial C and respiration in revegetated, pasture and native woodland habitats in the Western Australian wheatbelt. In: Pankhurst, C.E., Doube, B.M., Gupta, V.V.S.R. and Grace, P.R. (eds), *Soil Biota. Management in sustainable farming systems*. 173–176. CSIRO, Melbourne.
- Cowling, R.M. and Bond, W.J. 1992. How small can reserves be? An empirical approach in Cape fynbos. *Biological Conservation* **58**: 243–256.

- Cowling, R.M., Holmes, P.M. and Rebelo, A.G.** 1992. Plant diversity and endemism. In: Cowling, R.M. (ed.) *The Ecology of Fynbos: Nutrients, fire and diversity*. 62–112. Oxford University Press, Cape Town.
- Davis, D.D., Droop, S.J.M., Gregerson, P., Henson, L., Leon, C.J., Villa-Lobos, J., Syngé, H. and Zantovska, J.** 1986. *Plants in danger – What do we know?* IUCN, Gland, Switzerland.
- di Castri, F., Hansen, A.J. and Debussche, M.** 1990. *Biological Invasions in Europe and the Mediterranean Basin*. Kluwer, Dordrecht.
- Faraco, A.M., Fernández, F. and Moreno, J.M.** 1993. Post-fire dynamics of pine woodlands and shrublands in the Sierra de Gredos. In: Traubaud, L. and Prodon, R. (eds), *Fire in Mediterranean Ecosystems*. Ecosystems Research Report 5: 101–113.
- Fernández Alés, R., Martín, A., Ortega, F. and Alés, E.E.** 1992. Recent changes in landscape structure and function in a Mediterranean region of SW Spain (1950–1984). *Landscape Ecology* 7: 3–18.
- Froend, R.H., Heddlé, E.M., Bell, D.T. and McComb, A.J.** 1987. Effects of salinity and waterlogging on the vegetation of Lake Toolibin, Western Australia. *Australian Journal of Ecology* 12: 281–298.
- Froend, R.H. and McComb, A.J.** 1991. An account of the decline of Lake Towerrinning, a wheatbelt wetland. *Journal of the Royal Society Western Australia* 73: 123–128.
- Fuentes, E.R. and Etcheagaray, J.** 1983. Defoliation patterns in matorral ecosystems. In: Kruger, F.J., Mitchell, D.T. and Jarvis, J.V. (eds), *Mediterranean-type Ecosystems*. 525–542. Springer-Verlag, New York.
- Fuentes, E.R., Montenegro, G., Rundel, P.W., Arroyo, M.T.K., Ginocchio, R. and Jaksic, F.M.** 1995. Functional approaches to biodiversity in the Mediterranean-type ecosystems of central Chile. In: Davis, G.W. and Richardson, D.M. (eds), *Biodiversity and Function in Mediterranean-type Ecosystems*. 185–232. Springer-Verlag, Heidelberg.
- Fuentes, E.R. and Muñoz, M.** 1994. The role of humans in changing the landscapes of central Chile. In: Arroyo, M.K.T., Zedlar, P.H. and Fox, M.D. (eds), *Ecology and biogeography of Mediterranean ecosystems in Chile, California and Australia*. Springer-Verlag, New York.
- Giovannini, G.** 1994. The effect of fire on soil quality. In: Sala, M. and Rubio, J.L. (eds), *Soil Erosion and Degradation as a Consequence of Forest Fires*. 15–27. Geoforma Ediciones, Logroño, Spain.
- González Bernáldez, F.** 1991. Ecological consequences of the abandonment of traditional land use systems in central Spain. In: Baudry, J. and Bunce, R.G.H. (eds), *Land Abandonment and Its Role in Conservation*. 23–29. Options Méditerranéennes Ser. A15.
- Groves, R.H. and di Castri, F.** 1991. *Biogeography of Mediterranean Invasions*. Cambridge University Press, Cambridge.
- Hobbs, R.J.** 1992. Is biodiversity important for ecosystem functioning? Implications for research and management. In: Hobbs, R.J. (ed.), *Biodiversity of Mediterranean Ecosystems in Australia*. 211–229. Surrey Beatty and Sons, Chipping Norton, NSW.
- Hobbs, R.J.** 1993. Effects of landscape fragmentation on ecosystem processes in the Western Australian wheatbelt. *Biological Conservation* 64: 193–201.
- Hobbs, R.J.** 1995. Can we use plant functional types to describe and predict responses to environmental change? In: Smith, T.M., Shugart, H.H. and Woodward, F.I. (eds), *Plant Functional Types*. Cambridge University Press, Cambridge. (in press).
- Hobbs, R.J., Richardson, D.M. and Davis, G.W.** 1995. Mediterranean-type ecosystems: opportunities and constraints for studying the function of biodiversity. In: Davis, G.W. and Richardson, D.M. (eds), *Biodiversity and Function in Mediterranean-type Ecosystems*. 233–284. Springer-Verlag, Heidelberg.
- Hobbs, R.J., Saunders, D.A., Lobry de Bruyn, L.A. and Main, A.R.** 1993. Changes in biota. In: Hobbs, R.J. and Saunders, D.A. (eds), *Reintegrating Fragmented Landscapes. Towards sustainable production and nature conservation*. 65–106. Springer-Verlag, New York.
- Hopper, S.D.** 1992. Patterns of plant diversity at the population and species level in south-west Australian mediterranean ecosystems. In: Hobbs, R.J. (ed.), *Biodiversity of Mediterranean Ecosystems in Australia*. 27–46. Surrey Beatty and Sons, Chipping Norton, NSW.
- Hopper, S.D., van Leeuwen, S., Brown, A.P. and Patrick, S.J.** 1990. *Western Australia's Endangered Flora and Other Plants Under Consideration for Declaration*. Department of Conservation and Land Management, Wanneroo, Western Australia.
- Jaksic, F.M., Jiménez, J.E., Castro, S.A. and Feinsinger, P.** 1992. Numerical and functional response of predators to a long-term decline in mammalian prey at a semi-arid neotropical site. *Oecologia* 89: 90–101.
- Keeley, J.E.** (ed.) 1993. *Interface Between Ecology and Land Development in California*. Southern California Academy of Sciences, Los Angeles.
- Keeley, J.E. and Swift, C.C.** 1995. Biodiversity and ecosystem functioning in Mediterranean-climate California. In: Davis, G.W. and Richardson, D.M. (eds), *Biodiversity and Function in Mediterranean-type Ecosystems*. 122–183. Springer-Verlag, Heidelberg.
- Le Houérou, H.N.** 1990. Global change: vegetation, ecosystems and land use in the southern Mediterranean Basin by the mid twenty-first century. *Israel Journal of Botany* 39: 481–508.
- Macdonald, I. A. W. and Richardson D. M.** 1986. Alien species in terrestrial ecosystems of the fynbos biome. In: MacDonald, I.A., Kruger, F.J. and Ferrar, A.A. (eds), *The Ecology and Management of Biological Invasions in Southern Africa*. 77–91. Oxford, University Press.
- McFarlane, D.J., George, R.J. and Farrington, P.** 1993. Changes in the hydrologic cycle. In: Hobbs, R.J. and Saunders, D.A. (eds), *Reintegrating Fragmented Landscapes. Towards sustainable production and nature conservation*. 146–86. Springer-Verlag, New York.
- McFarlane, D.J., Howell, M.R., Ryder, A.T. and Orr, G.J.** 1992. The effect of agricultural development on the physical and hydraulic properties of four Western Australian soils. *Australian Journal of Soil Research* 30: 517–532.
- Main, A.R.** 1992. The role of diversity in ecosystem function: an

- overview. In: Hobbs, R.J. (ed.) *Biodiversity of Mediterranean Ecosystems in Australia*. 77–93. Surrey Beatty and Sons, Chipping Norton, NSW.
- Marion, G.M., Moreno, J.M. and Oechel, W.C.** 1991. Fire severity, ash deposition, and clipping effects on soil nutrients in chaparral. *Soil Science Society of America Journal* **55**: 235–240.
- Mooney, H.A., Hamburg, S.P. and Drake, J.A.** 1986. The invasion of plants and animals into California. In: Mooney, H.A. and Drake, J.A. (eds), *The Ecology of Biological Invasions of North America and Hawaii*. 250–272. Springer-Verlag, New York.
- Moreno, J.M.** 1989. Los ecosistemas terrestres mediterráneos y el fuego. *Política Científica* **18**: 46–50.
- Moreno, J.M. and Oechel, W.C.** 1994. Fire intensity as a determinant factor of postfire plant recovery in southern California chaparral. In: Moreno, J.M., and Oechel, W.C. (eds), *The role of Fire in Mediterranean-type Ecosystems*. 26–45. Springer-Verlag, New York.
- Moreno Saiz, and J.C. Sainz Ollero, H.** 1993. El endemismo vegetal ibérico-balear. *Vida silvestre* **75**: 35–41.
- Naveh, Z.** 1994. The role of fire and its management in the conservation of Mediterranean ecosystems and landscapes. In: Moreno, J.M. and Oechel, W.C. (eds), *The Role of Fire in Mediterranean-type Ecosystems*. 163–186. Springer-Verlag, New York.
- Norton, D.N., Hobbs, R.J. and Atkins, L.** 1995. Fragmentation, disturbance and plant distribution: mistletoes in woodland remnants in the Western Australian wheatbelt. *Conservation Biology* (in press).
- Nulsen, R.A.** 1992. Changes in soil properties. In: Hobbs, R.J. and Saunders, D.A. (eds), *Reintegrating Fragmented Landscapes: Towards sustainable production and nature conservation*. Springer-Verlag, New York.
- Pérez, B., Sánchez, D. and Moreno, J.M.** 1995. Effects of past and current land-use on post-fire vegetation in Sierra de Gredos, Spain. In: Balabanis, P. (ed.), *Forest Fire Risk and Management*. Commission of the European Communities, EUR Report Series (in press).
- Quézel, P.** 1981. The study of plant groupings in the countries surrounding the Mediterranean: Some methodological aspects. In: di Castri, F., Goodall, D.W. and Specht, R.L. (eds), *Mediterranean-type Shrublands*. Ecosystems of the World Vol. 11. 87–94. Elsevier, Amsterdam.
- Rebelo, A.G.** 1992. Preservation of biotic diversity. In: Cowling, R.M. (ed.), *The Ecology of Fynbos: Nutrients, fire and diversity*. 309–344. Oxford University Press, Cape Town.
- Riggan, P.J., Franklin, S.E., Brass, J.A. and Brooks, F.E.** 1994. Perspectives of fire management in Mediterranean ecosystems of southern California. In: Moreno, J.M. and Oechel, W.C. (eds), *The Role of Fire in Mediterranean-type Ecosystems*. 140–162. Springer-Verlag, New York.
- Saunders, D.A.** 1989. Changes in the avifauna of a region, district and remnant as a result of fragmentation of native vegetation: the wheatbelt of Western Australia. A case study. *Biological Conservation* **50**: 99–135.
- Saunders, D.A.** 1993. Community based observer scheme to assess avian response to habitat reduction and fragmentation in south western Australia. *Biological Conservation* **64**, 203–218.
- Scott, D.F. and van Wyk, D.B.** 1990. Effects of wildfire on soil wetability and hydrological behaviour of a forested catchment. *Journal of Hydrology*. **121**: 239–256.
- Scott, D.F. and van Wyk, D.B.** 1992. The effects of fire on soil water repellency, catchment sediment yields and streamflow. In: van Wilgen, B.W., Richardson, D.M., Kruger, F.J. and van Hensbergen, H.J. (eds), *Fire in South African Mountain Fynbos. Ecosystem, community and species response at Swartboskloof*. 216–239. Springer-Verlag, Berlin.
- Scougall, S.A., Majer, J.D. and Hobbs, R.J.** 1993. Edge effects in grazed and ungrazed Western Australian wheatbelt remnants in relation to ecosystem reconstruction. In: Saunders, D.A., Hobbs, R.J. and Ehrlich, P.R. (eds), *Reconstruction of Fragmented Ecosystems, Global and Regional Perspectives*. Nature Conservation 3. 163–178. Surrey Beatty and Sons, Chipping Norton, NSW.
- Smith, R.C., Huang X., Lyons, T.J., Hacker, J.H. and Hick, P.T.** 1992. Change in land surface albedo and temperature in southwestern Australia following the replacement of native perennial vegetation: satellite observations. Paper No. IAF-92-0117. 43rd Congress of the International Astronautical Federation, Washington, DC.
- Stock, W.D. and Allsopp, N.** 1992. Functional perspective of ecosystems. In: Cowling, R.M. (ed.) *The Ecology of Fynbos. Nutrients, Fire and Diversity*. 241–259. Oxford University Press, Cape Town.
- Valdés, B., Talavera, S. and Fernández-Galiano, E.** (eds). 1987. *Flora Vascular de Andalucía Occidental*. KETRES Editora, Barcelona, Spain.
- Van Wilgen, B.W., Bond W.J. and Richardson D.M.** 1992. Ecosystem management. In: Cowling, R.M. (ed.) *The Ecology of Fynbos: Nutrients, fire and diversity*, 345–371. Oxford University Press, Cape Town.
- Von Broembsen, S.** 1984. Distribution of *Phytophthora cinammomi* in rivers of the south-western Cape Province. *Phytophylactica* **16**: 227–229.
- World Conservation Monitoring Centre.** 1992. *Global Biodiversity. Status of the Earth's Living Resources*. Chapman and Hall, London.
- Wills, R.T.** 1993. The ecological impact of *Phytophthora cinammomi* in the Stirling Range National Park, Western Australia. *Australian Journal of Ecology* **18**: 145–160.
- Yates, C.J., Hobbs, R.J. and Bell, R.W.** 1994. Landscape-scale disturbances and regeneration of semi-arid woodlands of south-western Australia. *Pacific Conservation Biology* **1**, (in press).

6.1.9 Coastal systems

6.1.9.1 Introduction

We use the term 'coastal systems' to mean the general marine region extending from the upper tidal limits out across the continental shelf, slope and rise (Brink 1993). This definition includes rocky shores, sandy beaches, kelp forests, subtidal benthos and the water column over the shelf, slope and rise. 'Coastal systems' are generally considered to encompass the Exclusive Economic Zones of nations (Hight 1992), a strip approximately 200 nautical miles wide along the 440 000 km long outlines of the

continents (Ryther 1969; Highet 1992; Goldberg 1993). This simple geographic definition is used for convenience. In reality, 'coastal systems' often represent the margins of larger ecosystems (Sherman *et al.* 1990), and they vary considerably depending on atmospheric, oceanographic, historical and geological factors. For example, island coastal systems often have much higher endemism than continental coastal systems (Castilla 1988). This review focuses on the nearshore benthic communities whose biological dynamics are better known than those of pelagic or deep sea communities. Estuaries, mangroves and coral reefs are covered elsewhere in this Section.

The importance of coastal systems to humanity is high: most of the world's people live within 80 km of the coast (Sobel 1993). Both land- and ocean-based activities are concentrated at the coastal margins: tourism, recreation, fishing, mariculture, domestic and industrial waste disposal, military activities, transportation, mining and energy industries (Goldberg 1993). Many kelp forests and rocky intertidal shores are among the most productive of any ecosystem in the world (Valiela 1984; Leigh *et al.* 1987; Highsmith and Coyle 1990). Coastal fisheries are the richest in the world, with more than 75% of the world's fish catch coming from coastal waters (FAO 1991; Brink 1993). In addition to the commercial importance of coastal fisheries, many people in developing countries obtain a significant amount of their nutrition from the consumption of local seaweeds, shellfish and fish (Tseng 1984; Bustamante and Castilla 1987; Durán *et al.* 1987; Santelices 1989; FAO 1991; Norse 1993). The aesthetic beauty of coastal shores, though difficult to evaluate in economic terms, is nonetheless real and invaluable to many.

Coastal and other marine systems differ from terrestrial systems in several important ways, both with respect to patterns of diversity and with respect to the functional implications of those patterns. High diversity is found not only at the species level as in terrestrial systems (where insects constitute the vast majority of animal species), but also at higher taxonomic levels. In general, marine systems have a much greater diversity of types of organisms and types of body plans than do terrestrial systems. For example, of the 33 extant phyla of animals (Margulis and Schwartz 1988), 32 occur in the sea, 15 are exclusively marine, and five are nearly so (see Section 3.2; Norse 1993). Most of these phyla are abundant in coastal systems (Ray 1991; Ray and Grassle 1991).

One consequence of the high level of diversity is that functional groups (see Section 5.2.2) often include species that are physiologically and genetically more distinct from one another than is the case within a comparable assemblage on land. One possible consequence of the greater differences among members of a functional group is a greater probability that the members will respond

differently to environmental changes. In other words, the greater the taxonomic diversity within a functional group, the greater the genetic and physiological base for adaptation to change. It is possible that this higher level of diversity confers on the marine world a greater potential for ecosystem resilience to change (see Section 5.2.2).

Primary producers in coastal systems are particularly diverse in many important ways. They range in size from microscopic plankton to giant kelps up to 60 m long. Most seaweeds are anchored to the bottom, but others, like the phytoplankton suspended in the water column, are transported in and out of the anchored communities. One result of this fluid transport is that carbon that is fixed in one place may be consumed or decomposed many kilometres away. The generally smaller size and faster growth rates of primary producers in the oceans is one reason why changes occurring over very large spatial scales (thousands of kilometres) can take place over much shorter temporal scales (weeks) compared to equivalent changes on land (Steele 1985). Primary producers in coastal systems are taxonomically diverse, and photosynthetic bacteria and protists play a much more prominent role than these groups do on land.

Biogeographic diversity patterns are well known for many marine taxa. Although some taxa (e.g. molluscs, fishes) exhibit the highest species diversity at lower latitudes, others (seaweeds) are most diverse at mid latitudes (Gaines and Lubchenco 1982; Bolton 1994), still others (marine mammals and bryozoa) are most diverse at higher latitudes, and many other taxa show no latitudinal cline at all (Clarke 1992). In temperate regions, the eastern margins of ocean basins tend to be more diverse than the western margins. Large inter-oceanic differences in diversity occur, and reflect, in part, geological and historical phenomena (see Section 3.2). The coastal biota of the temperate North Atlantic, for example, is less diverse than that of the North Pacific; and the macrophyte flora of temperate South America is depauperate compared with the temperate North Pacific or temperate Australasia.

6.1.9.2 Major human-induced impacts on and threats to biodiversity

Diversity of coastal systems is affected directly and indirectly by numerous human activities (Aronson 1990; Folke *et al.* 1991; Hammer *et al.* 1993; Norse 1993; Barbier *et al.* 1994; Perrings *et al.* 1994; National Research Council 1995). Threats include over-exploitation of fishes, invertebrates and seaweeds (for fishery and non-fishery uses); coastal aquaculture; physical alteration of the habitat (by trampling, trawling, dredging, drilling, dynamiting, building and dumping); noise pollution; thermal pollution; and chemical pollution from both toxins and nutrients. Long-term effects of oil spills are generally not well known, but some impacts have been found to be substantial

(Keller and Jackson 1993a, b). Biological invasions are a serious threat to biodiversity, especially in bays, estuaries and inland seas (Ben-Tuvia 1973; Ben-Yami and Glaser 1974; Dromgoole and Foster 1983; Spanier and Galil 1991; Carlton and Hodder 1995), and the transportation of potential invaders in the ballast water of ships has only recently been recognized as a serious concern (Carlton and Geller 1993; McCarthy and Khambaty 1994). Numerous activities occurring on land also have strong impacts on coastal systems: for example, logging, livestock grazing, agricultural practices, industrial activities, residential and resort development and damming vary the load of sediment, pesticides, sewage, industrial pollutants and other wastes delivered to coastal waters. Although global-scale threats such as climate change and increases in ultra violet-B radiation have strong potential to affect coastal regions (Smith *et al.* 1992; Castilla *et al.* 1993; Lubchenco *et al.* 1993; Peterson *et al.* 1993; Barry *et al.* 1995; Roemmich and McGowan 1995a, b), the threats to diversity from land-use practices and overfishing are real, serious and more immediate (Paine 1993; Perrings *et al.* 1994; National Research Council 1995). Many areas are already severely degraded. Moreover, the rates, spatial extent and types of perturbations are increasing alarmingly.

Documentation of the effects of these threats is severely hampered by several factors which, though applicable to many terrestrial systems, are often more chronic in marine systems (Grassle *et al.* 1991); they include (1) lack of long-term, basic baseline information about the distribution and abundance of biota and how the patterns change through time (Wood *et al.* 1993; but see Barry *et al.* 1995 and Roemmich and McGowan 1995a, b for exceptions); (2) inadequate basic systematic information and a paucity of trained taxonomists (Andersen 1992; Wood and Leatham 1992; Knowlton 1993; Knowlton and Jackson 1994; National Research Council 1995); (3) lack of documentation of extinctions (Carlton 1993); (4) difficulty in adequately surveying and sampling benthic and pelagic systems; (5) slow expression of the consequences, which often take years or decades to occur, and thus appear 'invisible' to humans (Magnuson 1990); (6) long-distance transport of chemicals (Bacon *et al.* 1992; Tatsukawa *et al.* 1994), organisms and phenomena. Coastal systems are strongly affected by processes occurring both in the immediate vicinity and far away, not only via air-water interactions but also through long-distance transportation within the aquatic medium. Spatial scale, transport and dispersal events are of particular importance to the dynamics of coastal systems (Gaines *et al.* 1985; Roughgarden *et al.* 1985; Grassle *et al.* 1991; Steele 1991; Levin 1992) and to the evolution of species within these systems (Palumbi 1992; Steinberg *et al.* 1995).

Despite these limitations to adequate documentation of impacts, many effects are all too obvious. The extinction of

numerous wild salmon runs and the ongoing decline of many of the remaining runs in the Pacific Northwest of the United States; eutrophication in Chesapeake Bay and Buzzards Bay in the eastern USA; effects of sewage sludge dumping off New Jersey, and the massive decline of most major fisheries, provide ample evidence of adverse impacts. Human exclusion experiments along the coast of Chile document previously unknown but dramatic direct impacts of people on the shore (Moreno *et al.* 1984; Castilla and Durán 1985; Durán *et al.* 1987; Durán and Castilla 1989; Castilla *et al.* 1993, 1994). Comparable changes may be occurring elsewhere (Dethier *et al.* 1989; Hawkes 1992; Adessi 1994).

6.1.9.3 Productive capacity, biomass, decomposition and nutrient cycling

Human impacts on biodiversity. Over-exploitation of coastal fisheries world-wide represents one of the most serious but least well documented threats to nearshore biodiversity. Despite the fact that overfishing of many commercially important fish and shellfish stocks has resulted in the demise of numerous fisheries throughout the world, there is often little specific information about the overall consequences to genetic, species or ecosystem diversity in most of the affected systems. The largest impacts may well be caused by indirect effects, as initial declines in target species in turn affect other species.

The effects of over-exploitation of a few species are known or can be inferred, especially where ecological relationships with the species' predators, symbionts, competitors or prey are known (Barkai and MacQuaid 1988; Paine 1993). The over-exploitation of sea otters along the northeastern rim of the Pacific Ocean, for example, has been well documented. Comparison of Aleutian Islands with and without otters suggests that the removal of this keystone predator in Alaska results in profound changes in the biodiversity of the rest of the kelp forest community (Box 6.1-1); Estes and Palmisano 1974; Estes *et al.* 1978; Duggins *et al.* 1989). Other changes in diversity resulting from overfishing have been described for Northwest Atlantic continental shelf systems (Sherman 1990), Haiti, the US Virgin Islands (Hay 1984), Hainan Island, China (Hutchings and Wu 1987) and the Baltic Sea (Hammer *et al.* 1993).

Ecosystem consequences of impacts. Little information is available with which to evaluate comprehensively the consequences of changes in diversity on production biomass, decomposition or nutrient cycling. We know of no studies evaluating the consequences of changes in number of species *per se*. However, there is evidence that changes in abundance of certain species can have profound impacts on these processes. For example, in the sea otter—sea urchin—kelp interaction (Box 6.1-1), the deletion of a single species (the otter) resulted in dramatic changes in biomass and probably also primary and secondary

Box 6.1-1: Sea otters: keystone predators in Alaskan kelp forests.

Sea otters in Alaska demonstrate the strong influence that a single species can have on an entire community. Otters play a pivotal role in maintaining kelp forests by eating and controlling sea urchins which consume kelps. In the absence of otters, urchins increase in size and numbers and overgraze the kelps. A lush kelp forest is thus converted to an 'urchin barren', a community composed primarily of a pavement of encrusting coralline algae and urchins (Estes and Palmisano 1974; Simenstad *et al.* 1978; Duggins *et al.* 1989). Urchin barrens are devoid of kelps and other large seaweeds, and lack the diverse assemblage of macroscopic benthic and pelagic invertebrates and fishes, and marine mammals associated with kelp forests. The otter is thus a 'keystone' species because it exerts a disproportionately large influence on the entire community (see Box 5.2-1).

Conversion of a kelp forest to an urchin barren results in the loss of important ecosystem services. In addition to providing a habitat for resident species, kelp forests may also function as important nursery areas for many fish (Carr 1994) and may modify larval transport to adjacent shores (Gaines *et al.* 1985). They also provide dissolved and particulate organic matter that is consumed locally and by organisms such as deposit- and filter-feeding mussels, clams and barnacles in adjacent intertidal and subtidal communities (Duggins *et al.* 1989). Moreover, kelp forests often protect coastal shorelines from the full force of waves, especially during winter storms. In this case, the absence of a keystone species results in the conversion of a community from a lush forest to a depauperate plain with attendant loss of habitat, primary and secondary production, export to nearby systems and buffering capacity to nearshore areas.

production, nutrient cycling, decomposition, and export of organic matter to nearby systems (Estes and Palmisano 1974; Simenstad *et al.* 1978; Duggins *et al.* 1989).

Alterations in the relative abundance of phytoplankton or macrophytes resulting from climate change could have important cascading consequences for the structure and functioning of the rest of the coastal systems (Peterson *et al.* 1993), but the specific consequences to primary production, biomass, decomposition and nutrient cycling cannot be predicted with confidence.

Climate change has been predicted to result in warmer water, sea level rise (Houghton *et al.* 1990, 1992) and alterations in coastal upwelling patterns (Bakun 1990). Each of these would be likely to have effects on biodiversity, though the direct and indirect changes are difficult to predict (Castilla *et al.* 1993; Lubchenco *et al.* 1993; Paine 1993; Peterson *et al.* 1993). Barry *et al.* (1995) report shifts in temperatures and in intertidal plants and animals over a 50-year time span in Monterey Bay, California, USA, which may be due to global warming. Different taxa of macrophytes as well as phytoplankton vary considerably in their responses to changes in temperature and their ability to take up and store nutrients (Wheeler 1983; Fujita 1985). Changes in the frequency, duration or intensity of coastal upwelling would be expected to alter the relative abundances of the major taxa of macrophytes and phytoplankton as well as affect the overall levels of productivity (Menge *et al.* 1995; Roemmich and McGowan 1995a, b).

6.1.9.4 Sediment structure

Human impacts on biodiversity. Dredging, trawling, anchoring, trampling, raking and digging have wide-

ranging but sporadically documented consequences for marine biota. These activities disrupt sediment structure, destroy burrows, bury or clog organisms and suspend particles, and modify wave and tidal energy, all of which may affect patterns of diversity in soft-sediment environments (McLachlan *et al.* 1993). One short-term effect of sediment resuspension should be increased respiration and mineralization of sediment organic matter and a consequent increase in inorganic nutrients into the water column. Increase in nuisance phytoplankton blooms would be expected to follow. Other expected consequences include mobilization of toxic metals and inorganics into the water column and a disruption of anaerobic microzones and thus biogeochemical cycles.

The use of new, economically more efficient techniques for harvesting shellfish can sometimes have negative consequences on the target commercial species and the rest of the community compared with traditional hand-gathering techniques (Defeo 1989, 1993). Contamination of freshwater effluents by human activities (e.g. through the use of chemicals and increased nutrients from agriculture) can affect the composition of these communities and potentially reduce species diversity above and beyond the effect produced by the reduction in salinity (Defeo *et al.* 1990; Defeo 1993). Taxa vary widely in the extent to which they themselves modify the structure of the sediments and thus alteration of sediment structure may result in further modifications through trophic and non-trophic interactions among species. Intra- and interspecific biological interactions are poorly understood in these systems.

Ecosystem consequences of impacts. The ecosystem consequences of these disruptive activities are largely

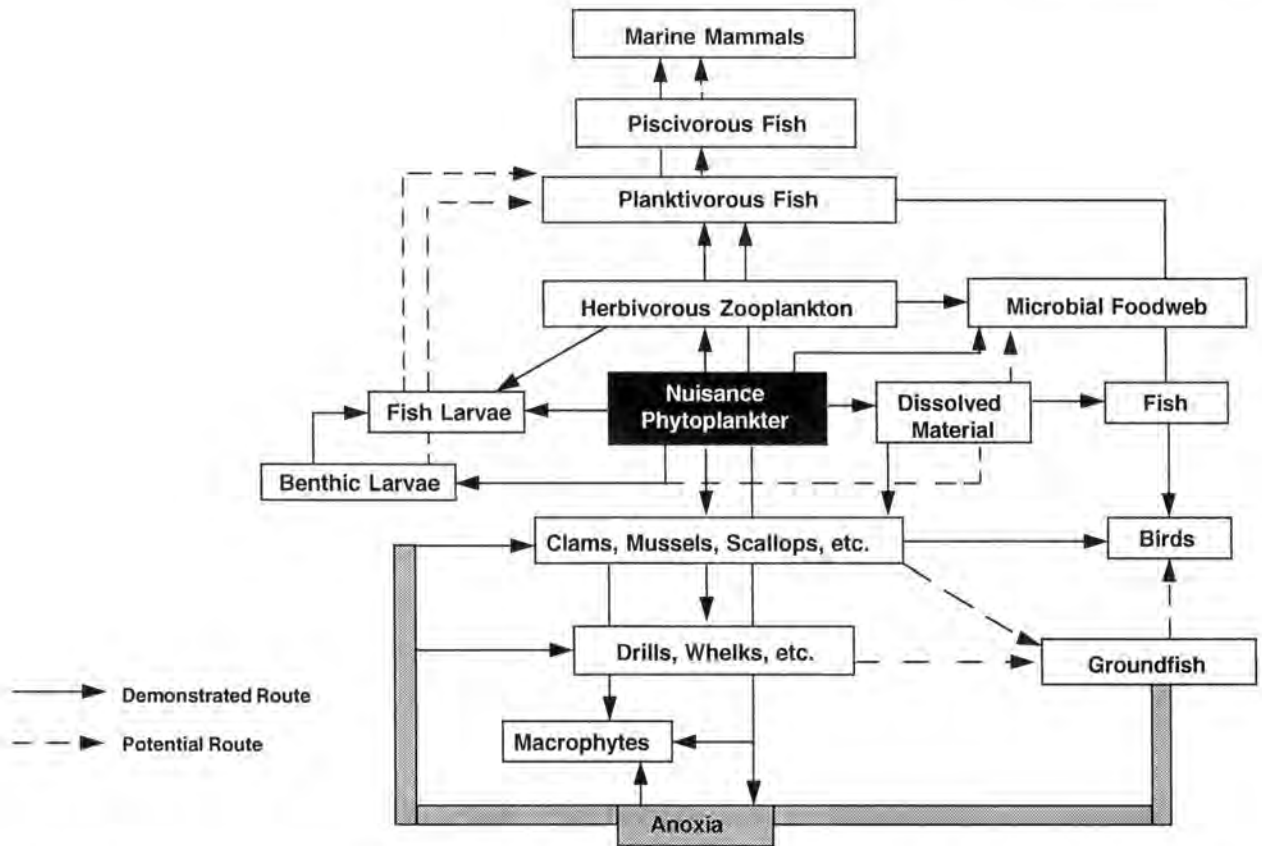

Figure 6.1-4: Trophic linkages between nuisance phytoplankton blooms and species illustrating some direct and vectored routes through which toxins, inimical species and anoxia affect the depicted compartments and may cause recruitment failure and/or mortality (after: Smayda 1992).

unknown. The experimental exclusion of humans to create a *de facto* closing of the fishery of the yellow clam *Mesodesma mactroides* from a sandy beach on the coast of Uruguay illustrates, however, that these activities can have far-reaching consequences. The yellow clam is an important artisanal fishery in Uruguay, and many fishing communities are devoted to its extraction (Defeo 1989). The experimental manipulation of the fishery led to important changes in overall abundance and in the kinds of processes regulating the dynamics of the populations of not only *M. mactroides* but also the coexisting wedge clam, *Donax hanleyanus*, which is not exploited by humans (Defeo 1993; Defeo and DeAlava 1995). Changes in the abundance of other non-exploited species were also observed following the 'exclusion' of humans.

6.1.9.5 Water movement and quality

Human impacts on biodiversity. Nutrients in shallow coastal systems are taken up directly from the aquatic medium, and nutrient availability is heavily affected by sewage discharge, freshwater runoff, dumping of industrial wastes, and atmospheric deposition of toxics and nutrients. In 1982, anthropogenic inputs of nutrients to coastal waters were estimated to equal or exceed natural inputs (Meybeck

1982). The UN's Group of Experts on the Scientific Aspects of Marine Pollution (GESAMP 1991) has 'identified nutrients as the most damaging class of pollutants in the marine realm' (Norse 1993). Nutrient enrichment of coastal waters is generally characterized by increases in primary production, shifts in the relative abundance of phytoplankton species, dense plankton blooms and nuisance macro-algal blooms (GESAMP 1991; Norse 1993). One specific mechanism of these shifts appears to be alteration in the Si:N and Si:P ratios, which favour non-diatom blooms (Smayda 1992). Explosive increases in certain taxa such as various dinoflagellates produce 'red tides'. The diversity of organisms producing toxic phytoplankton blooms has increased during the last few decades (Wood *et al.* 1993), and the frequency, extent and intensity of toxic phytoplankton blooms is increasing (Dundas *et al.* 1989; Smayda 1990; Hallegraeff 1993). Moreover, certain blooming species are apparently spreading globally, perhaps aided by transport in the ballast water of ships (Hallegraeff and Bolch 1991). Smayda (1990) terms this 'a global epidemic' with far-reaching consequences.

Ecosystem consequences of impacts. Coastal eutrophication has dramatic effects on water quality,

aquaculture, fisheries, human health and ecosystem structure and functioning. The well-known effects of coastal eutrophication include toxic algal blooms, anoxia, fish kills, shifts to a decomposition food web, and loss of water quality (Fenchel *et al.* 1990; Turner and Rabalais 1991). Red-tide or other algal blooms can result in human health hazards such as paralytic shellfish poisoning or aquacultural die-offs (Richardson 1989). Toxins produced by red-tide blooms have recently been shown to result in a wide variety of other ecosystem effects, ranging from reduced fecundity and recruitment and increased mortality of fishes (Smayda 1992) to marine mammal die-offs (Geraci *et al.* 1989) (Figure 6.1-4). Hence, differential responses of phytoplankton taxa to nutrient shifts can result in substantial alteration of the relative abundance of phytoplankton with far-reaching consequences involving not only water quality but also other ecosystem properties as well. Changes in the relative abundance of phytoplankton taxa are also influenced by shifts in the relative abundance of zooplankton and higher trophic level taxa.

6.1.9.6 Feedbacks to atmospheric properties

Human impacts on biodiversity. A wide variety of bacteria, phytoplankton and macrophytes produce gases that have been suggested to be of potential importance to the radiative balance of the Earth's atmosphere. Chemically important marine biogases include species of carbon (CO_2 , CO, CH_4), sulphur (DMS), nitrogen (N_2O , NH_3), and halogens (CH_3I , CH_3Cl , and CH_3Br) (Wolfe *et al.* 1991). Some of these gases are also produced by terrestrial biota. However, the marine environment is thought to be the main source of dimethylsulphide (DMS) and carbonylsulphide (COS), two trace constituents of the atmosphere which have important effects on the global atmospheric and climatic balance (Charlson *et al.* 1987; see also 6.2.4). The production of atmospherically active gases is not uniformly distributed among species within a given habitat. A few species produce a disproportionate fraction of the most active atmospheric constituents (e.g. bacterial catabolism of certain phytoplankton species produces a large fraction of all the atmospheric DMS). Factors affecting the relative abundance of these species have the potential to exert large effects on the atmosphere and consequently the global climate. Pollutants, eutrophication of coastal waters, sedimentation, and depletion of atmospheric ozone with the consequence of increasing UV-B radiation (Karentz 1991; Helbling *et al.* 1992; Smith *et al.* 1992) can all alter the diversity and abundance of these producers and thus have the potential to alter global climate.

Ecosystem consequences of impacts. Emission of DMS from the open ocean and its effect in the formation of cloud condensation nuclei (CCN) has been hypothesized to be a

major regulatory factor of the global climate. Production of DMS varies dramatically depending on species composition (Keller *et al.* 1989). It is also known that blooms of calcifying coccolithophorids found in coastal waters have global significance in the CO_2 and DMS cycles (Holligan *et al.* 1983; Matrai and Keller 1993; Brown and Yoder 1994). Although factors regulating both species composition and the outbreak of blooms are not clearly understood in these systems, alteration of these regulatory factors (e.g. the relative availability of nutrients) by human activities can have potential global consequences.

The coastal marine environment is the main biogenic source of COS, which is thought to be the major source of sulphur in the stratosphere. After oxidation, these constituents play a major role in the global radiation budget and thus climate, by scattering sunlight back to space and interfering with stratospheric ozone (Lazrus and Gandrun 1977; Hofman 1990). The general degradation of coastal environments can affect the global levels of CS_2 , changing the atmospheric composition and in turn affecting the rest of the biota.

6.1.9.7 Landscape and waterscape structure

Human impacts on biodiversity. Coastal systems are characterized by steep physical gradients in desiccation, wave action, water movement, depth, light attenuation, mixing, temperature, particle size, particle movement, salinity and substrate type. One consequence of these steep gradients is a high landscape diversity, with rocky shores closely juxtaposed with sandy beaches, kelp forests, estuaries or other habitats. The linkage of these different communities by water flowing and organisms moving within and among them provides for substantial interchange. Human activities such as over-exploitation of resources, physical alteration of the habitat, pollution, introduction of alien species and climate change are already affecting genetic, species and ecosystem diversity and hence modifying landscape structure.

Ecosystem consequences of impacts. Most landscape-level alterations resulting from changes in biodiversity have not been well documented. The potential for these changes is illustrated in the greater Everglades ecosystem in Florida, USA. Massive alteration of natural hydrologic patterns for flood control and development throughout the entire Everglades region appears to be one of the primary triggers of the ecological collapse of Florida Bay (Butler *et al.* 1994). The enormous anthropogenic flows of flood waters into coastal waters to the east and west of Lake Okeechobee have decimated hard-bottom communities.

Two smaller-scale examples provide more information about possible roles of biodiversity in mediating landscape-level changes. The absence of sea otters from certain Aleutian islands (Box 6.1-1), and the creation of marine

protected areas in intertidal sites in Chile, illustrate how changes in diversity mediated through deletions of a top predator have resulted in drastic alteration of the ecosystem and landscape structure. Conversion of a kelp forest to an urchin barren modifies water movement patterns, delivery of dissolved and particulate organic matter to adjacent intertidal beaches and intertidal and subtidal rocky shores, protection of juvenile fishes and hence recruitment into pelagic communities. In Chile, humans remove gastropods (Oliva and Castilla 1986; Durán *et al.* 1987), seaweeds (Castilla and Bustamante 1989) and fishes, and because of the effects of each of these groups on other species in the community, the result is a transformation of the community.

6.1.9.8 Biotic linkages and species interactions

Human impacts on biodiversity. Overfishing, overcollecting, trampling, modification of the physical structure, pollution and species introductions are all substantial threats to coastal biodiversity. Influences range from 'bottom-up' effects wherein species at the base of the food web are affected first (e.g. eutrophication or harvesting of macrophytes) to 'middle-out' effects involving alterations in herbivores (e.g. harvesting of sea urchins or herbivorous fishes), to 'top-down' effects where top predators are directly affected (e.g. removals of otters, molluscs, sea stars, lobsters, sharks and other fishes). The relative importance of these regulatory effects may vary among communities and along environmental gradients (Sousa 1979; Menge 1992). None of these impacts is limited to the taxon, functional group or trophic level first affected; all of these effects reverberate throughout the rest of the ecosystem via biological interactions.

Ecosystem consequences of impacts. Biotic interactions and species linkages are particularly well known from nearshore coastal benthic communities where experimental manipulation of species has resulted in a mechanistic understanding of the links among species, including the importance of interaction strength, keystone species, and compensation among species within a functional group (reviewed in Paine 1980, 1992; Menge *et al.* 1994; Power *et al.* 1995; Power and Mills 1995). If keystone species are removed, for example, the entire ecosystem can be affected. Sea otters and sea-stars provide well-documented examples (Box 6.1-1). In contrast, some systems are characterized by the lack of a keystone species (Menge and Lubchenco 1981; Robles and Robb 1993). These systems provide an interesting comparison which is immediately relevant to the relationship between biodiversity and ecosystem functioning. Rocky intertidal shores on the Pacific coast of Panama have rich diversity within all trophic and functional groups (Lubchenco *et al.* 1984). Experiments demonstrate that the entire assemblage of

predators and herbivores has dramatic effects in maintaining the barren appearance of the shores. However, no single species or group of species has a demonstrable effect. Removal of species or functional group such as molluscan predators or molluscan herbivores or large fishes or small fishes and crabs has little effect on the community because other groups with overlapping functions compensate for the absence of the target group (Menge *et al.* 1986). High diversity within the functional groups of this community provides for continuation of the function in the absence of any individual constituents (Menge *et al.* 1986; Menge and Lubchenco 1981). This is a fundamentally different result from that obtained in Alaskan kelp communities or rocky intertidal shores off Washington and Oregon (Paine 1966, 1994; Menge *et al.* 1994) or tide pools in New England (Lubchenco 1978) where removal of a single keystone species totally changes the community. The Panama system is characterized by high functional overlap and thus the potential for compensation.

Even in communities such as rocky intertidal systems where the relationships between species diversity and community patterns and processes are among the best understood of any assemblage, relatively little is known about effects at the ecosystem level. The consequence of removal of keystone species to nutrient flows, rates of production or decomposition have not been measured.

6.1.9.9 Microbial activities

Human impacts on biodiversity. Several anthropogenic changes have had broad impacts on micro-organisms. Excess nutrient input from sewage, fertilizers and soil erosion can drastically change nutrient availability in many coastal systems (GESAMP 1991; Norse 1993). Increased UV irradiation from a thinning ozone layer probably has a detrimental effect on phytoplankton over vast areas (Hebling *et al.* 1992; Smith *et al.* 1992). Warming from climate change reduces available oxygen and probably favours some species over others (Epstein *et al.* 1993) or causes evolutionary change in organisms that experience these environmental impacts as a form of directional selection (Lynch *et al.* 1991; Lynch and Lande 1993). Both processes are likely to change the structure of microbial communities, with unpredictable impacts on ecosystem functioning.

The biodiversity of marine microorganisms has been greatly underestimated in the past. Only recently, through molecular methods, has the tremendous taxonomic diversity of these groups begun to be documented (Giovannoni *et al.* 1990; Fuhrman *et al.* 1993). Specific impacts on this diversity are thus poorly understood.

Ecosystem consequences of impacts. These broad impacts may have several consequences. Nutrient influx has created a variety of eutrophication problems in many

coastal regions (Richardson 1989; Turner and Rabalais 1994). For example, a cascade of disturbances, apparently caused by an increase in cyanobacterial blooms in Florida Bay, Florida, USA, has caused the widespread loss of sponge populations and a decline in lobster abundance (Butler *et al.* 1994). Outbreaks of human disease, such as cholera, have been linked to plankton reservoirs that have been enhanced by nutrient addition (Epstein *et al.* 1993). Further, anoxic conditions created by algal blooms have been implicated in significant mortality of fish stocks and benthic fauna in several regions (Tulkki 1965; Jorgensen 1980; Richardson 1989). Numerous unexplained mass mortalities or disease outbreaks remain enigmatic, though pathogens are often suspected of playing key roles, for example in urchins (Lessios *et al.* 1984; Lessios 1988), asteroids (Dungan *et al.* 1982), abalone (Steinbeck *et al.* 1992; Richards and Davis 1993), sea grasses (Rasmussen 1977) and marine mammals (Dietz *et al.* 1989). In most cases, neither the causes of the outbreaks nor the specific vectors are known.

Viruses, previously disregarded by marine microbiologists, are clearly important in regulating phytoplankton (Suttle *et al.* 1990) and bacterioplankton populations (Bergh *et al.* 1989; Bratbak *et al.* 1990; Proctor and Fuhrman 1990). As with symbiotic relations, virus–host interactions are highly species-specific and changes in diversity will change the dynamics of these interactions (Steward *et al.* 1992).

Loss of certain functional groups (see Section 5.2.2) such as methane oxidizers would have a dramatic effect on global biogeochemistry because these functional groups are taxonomically limited in scope.

Close coupling of temperature for maximum growth rate and average temperatures *in situ* have profound impacts on bacterial growth and the fate of carbon from phytoplankton in high latitude seas (Pomeroy and Deibel 1986; Pomeroy *et al.* 1991; Wiebe *et al.* 1992). Similar close correlation between *in situ* temperatures and optimum growth rate has been observed in other members of the microbial community from the Arctic (Choi and Peters 1992) and bacterial communities from temperate ecosystems (Shiah and Ducklow 1994), suggesting that the entire microbial food web of a given environment will be very sensitive to changes in average temperature, even if this involves a change of only a few degrees.

6.1.9.10 Summary and relevance to human activities

Coastal systems are among those most heavily affected by humans. They are also among the systems most vital to humans, and provide food, recreation, inspiration, transportation, waste disposal, and the buffering of coastlines from erosion. Threats to biodiversity in these systems are multiple and serious; they may also be synergistic. The full impact of the resulting changes to

diversity are not sufficiently known, but early indications suggest they may be profound. The effects of over-exploitation and pollution are increasingly obvious and serious but the full consequences of species introductions, physical habitat destruction, changes in UV-B radiation and climate change are yet to be documented.

References

- Addressi, L. 1994. Human disturbance and long-term changes on a rocky intertidal community. *Ecological Applications* **4**: 786–797.
- Andersen, R.A. 1992. Diversity of eukaryotic algae. *Biodiversity and Conservation* **1**: 267–292.
- Aronson, R.B. 1990. Onshore–offshore patterns of human fishing activity. *Palaios* **5**: 88–93.
- Bacon, C.E., Jarman, W.M. and Costa, D.P. 1992. Organochlorine and polychlorinated biphenyl levels in pinniped milk from the Arctic, Antarctic, California, and Australia. *Chemosphere* **24**: 779–791.
- Bakun, A. 1990. Global climate change and intensification of coastal ocean upwelling. *Science* **247**: 198–201.
- Barbier, E.B., Burgess, J.C. and Folke, C. 1994. *Paradise Lost? The ecological economics of biodiversity*. Earthscan, London.
- Barkai, A. and MacQuaid, J. 1988. Predator–prey role reversal in a marine benthic ecosystem. *Science* **242**: 62–64.
- Barry, J.P., Baxter, C.H., Sagarin, R.D. and Gilman, S.E. 1995. Climate-related, long-term faunal changes in a California rocky intertidal community. *Science* **267**: 672–675.
- Ben-Tuvia, A. 1973. Man-made changes in the eastern Mediterranean Sea and their effect on the fishery resources. *Marine Biology* **19**: 197–203.
- Ben-Yami, M. and Glaser, T. 1974. The invasion of *Saurida undosquamis* (Richardson) into the Levant Basin - an example of biological effect of interoceanic canals. *Fishery Bulletin* **72**: 359–373.
- Bergh, Ø., Børsheim, K.Y., Bratbak, G. and Heldal, M. 1989. High abundance of viruses found in aquatic environments. *Nature* **340**: 467–468.
- Bolton, J.J. 1994. Global seaweed diversity: patterns and anomalies. *Botanica Marina* **37**: 241–247.
- Bratbak, G., Heldal, M., Norland, S. and Thingstad, T.F. 1990. Viruses as partners in spring bloom microbial trophodynamics. *Applied and Environmental Microbiology* **56**: 1400–1405.
- Brink, K.H. 1993. The coastal ocean processes (CoOP) effort. *Oceanus* **36**: 47–49.
- Brown, C.W. and Yoder, A. 1994. Distribution patterns of coccolithophorids in the western North Atlantic Ocean. *Continental Shelf Research* **14**: 175–197.
- Bustamante, R.H. and Castilla, J.C. 1987. The shellfishery in Chile: An analysis of 26 years of landings (1960–1985). *Biología Pesquera (Chile)* **16**: 79–97.
- Butler, M.J., Herrmkind, W.F. and Hunt, J.H. 1994. Cascading disturbances in an ailing marine ecosystem impact the spiny lobster nursery of south Florida. *Bulletin of the Ecological Society of America (Supplement)*, **75** (2): 29.
- Carlton, J.T. 1993. Neoextinctions of marine invertebrates. *American Zoologist* **33**: 499–509.

- Carlton, J.T.** and Geller, J.B. 1993. Ecological roulette: the global transport of nonindigenous marine organisms. *Science* **261**: 78–82.
- Carlton, J.T.** and Hodder, J. 1995. Biogeography and dispersal of coastal organisms: experimental studies on a replica of a 16th century sailing vessel. *Marine Biology* **121**: 721–730.
- Carr, M.H.** 1994. Effects of macroalgal dynamics on recruitment of a temperate reef fish. *Ecology* **75**: 1320–1333.
- Castilla, J.C.** (ed.) 1988. *Islas Oceanicas Chilenas: Conocimiento Científico y Necesidades de Investigaciones*. Ediciones Universidad Católica De Chile, Santiago, Chile.
- Castilla, J.C.** and Bustamante, R.H. 1989. Human exclusion from rocky intertidal of Las Cruces, central Chile: effects on *Durvillaea antarctica* (Phaeophyta, Curvilliales). *Marine Ecological Progress Series* **50**: 203–214.
- Castilla, J.C.** and Durán, L.R. 1985. Human exclusion from the rocky intertidal of central Chile: the effects on *Concholepas concholepas* (Gastropoda). *Oikos* **45**: 391–399.
- Castilla, J.C.**, Branch, G.M. and Barkai, A. 1994. Exploitation of two critical predators: the gastropod *Concholepas concholepas* and the rock lobster *Jasus ladandi*. In: Siegfried, W.R. (ed.), *Rocky Shores: Exploitation in Chile and South Africa*. Ecological Studies Vol. 103. 101–130. Springer-Verlag, Berlin.
- Castilla, J.C.**, Navarrete, S.A. and Lubchenco, J. 1993. Southeastern Pacific coastal environments: main features, large-scale perturbations and global climate change. In: Mooney, H.A., Fuentes, E.R. and Kronberg, B.I. (eds), *Earth System Response to Global Change: Contrasts between North and South America*, 167–188. Academic Press, San Diego.
- Charlson, R.J.**, Lovelock, J.E., Andreae, M.O. and Warren, S.G. 1987. Oceanic phytoplankton, atmospheric sulphur, cloud albedo and climate. *Nature* **326**: 655–661.
- Choi, J.W.** and Peters, F. 1992. Effects of temperature on two psychrophilic ecotypes of a heterotrophic nanoflagellate, *Paraphysomonas imperforata*. *Applied and Environmental Microbiology* **58**: 593–599.
- Clarke, A.** 1992. Is there a latitudinal diversity cline in the sea? *Trends in Ecology and Evolution* **7**: 286–287.
- Defeo, O.** 1989. Development and management of artisanal fishery for yellow clam *Mesodesma mactroides* in Uruguay. *Fishbyte* **7**: 21–25.
- Defeo, O.**, Mendez, S., Riestra, G. and Brazeiro, A. 1990. Agriculture drainage affecting the community structure of organisms of an Uruguayan sandy beach. *International Conference on Marine Coastal Eutrophication* (Abstract).
- Defeo, O.** 1993. The effect of spatial scales in population dynamics and modelling of sedentary fisheries: the yellow clam *Mesodesma mactroides* of an Uruguayan exposed sandy beach. Doctoral dissertation, CINVESTAV-IPN Unidad Mérida, México.
- Defeo, O.** and DeAlava, A. 1995. Effects of human activities on long-term trends in sandy beach populations: the wedge clam *Donax hanleyanus* in Uruguay. *Marine Ecology Progress Series* (in press).
- Dethier, M.N.**, Duggins, D.O. and Mumford, T.F. Jr. 1989. Harvesting of non-traditional marine resources in Washington State: trends and concerns. *Northwest Environmental Journal* **5**: 71–87.
- Dietz, R.**, Jorgensen, M.P.H. and Harkonen, T. 1989. Mass deaths of harbor seals (*Phoca vitulina*) in Europe. *Ambio* **18**: 258–264.
- Dromgoole, F.I.** and Foster, B.A. 1983. Changes to the marine biota of the Auckland Harbour. *Tane* **29**: 79–96.
- Duggins, D.O.**, Simenstad, C.A. and Estes, J.A. 1989. Magnification of secondary production by kelp detritus in coastal marine ecosystems. *Science* **245**: 170–173.
- Dundas, I.**, Johannessen, O.M., Berge, G. and Heimdal, B. 1989. Toxic algal bloom in Scandinavian waters, May–June 1988. *Oceanography* (April) 9–14.
- Dungan, M.L.**, Miller, T.E. and Thomson, D.A. 1982. Catastrophic decline of a top carnivore in the Gulf of California rocky intertidal zone. *Science* **216**: 989–991.
- Durán, R.**, Castilla, J.C. and Oliva, D. 1987. Intensity of human predation on rocky shores at Las Cruces, central Chile. *Environmental Conservation* **14**: 143–149.
- Durán, R.L.** and Castilla, J.C. 1989. Variation and persistence of middle rocky intertidal community of central Chile with and without human harvesting. *Marine Biology* **103**: 555–562.
- Epstein, P.R.**, Ford, T.E. and Colwell, R.R. 1993. Marine ecosystems. *The Lancet* **343**: 1216–1219.
- Estes, J.A.** and Palmisano, J.F. 1974. Sea otters: their role in structuring nearshore communities. *Science* **185**: 1058–1060.
- Estes, J.A.**, Smith, N.S. and Palmisano, J.F. 1978. Sea otter predation and community organization in the western Aleutian Islands, Alaska. *Ecology* **59**: 822–833.
- Food and Agriculture Organization of the United Nations.** 1991. *Catches and Landings*. Statistics Series No. 68. FAO, Rome.
- Fenchel, T.**, Kristensen, L.D. and Rasmussen, L. 1990. Water column anoxia: vertical zonation of planktonic protozoa. *Marine Ecology Progress Series* **62**: 1–10.
- Folke, C.**, Hammer, M. and Jansson, A.M. 1991. Life-support value of ecosystems: a case study of the Baltic Sea region. *Ecological Economics* **3**: 123–137.
- Fuhrman, J.A.**, McCallum, K. and Davis, A.A. 1993. Phylogenetic diversity of subsurface marine microbial communities from the Atlantic and Pacific Oceans. *Applied and Environmental Microbiology* **59**: 1294–1302.
- Fujita, R.M.** 1985. The role of nitrogen status in regulating transient ammonium uptake and nitrogen storage by macroalgae. *Journal of Experimental Marine Biology and Ecology* **92**: 283–301.
- Gaines, S.D.**, Brown, S. and Roughgarden, J. 1985. Spatial variation in larval concentrations as a cause of spatial variation in settlement for the barnacle, *Balanus glandula*. *Oecologia* **67**: 267–272.
- Gaines, S.D.** and Lubchenco, J. 1982. A unified approach to marine plant–herbivore interactions. II. Biogeography. *Annual Review of Ecology and Systematics* **13**: 111–138.
- Geraci, J.R.**, Anderson, D.M., Timperi, R.J., St. Aubin, D.J., Early, G.A., Prescott, J.H. and Mayo, C.A. 1989. Humpback whales (*Megaptera novaeangliae*) fatally poisoned by dinoflagellate toxin. *Canadian Journal of Fisheries and Aquatic Science* **46**: 1895–1898.
- GESAMP** (Joint Group of Experts on the Scientific Aspects of Marine Pollution) 1991. *The State of the Marine Environment*. Blackwell Scientific Publications, Oxford.

- Giovannoni, S.J.**, Britschgi, T.B., Moyer, C.L. and Field, K.G. 1990. Genetic diversity in Sargasso Sea bacterioplankton. *Nature* **345**: 60–63.
- Goldberg, E.D.** 1993. Competitors for coastal ocean space. *Oceanus* **36** (1): 12–18.
- Grassle, J.F.**, Lasserre, P., McIntyre, A.D. and Ray, G.C. 1991. *Biology International: Marine Biodiversity and Ecosystem Function*. Vol. 23. International Union of Biological Sciences, Paris.
- Hallegraeff, G.M.** 1993. A review of harmful algal blooms and their apparent global increase. *Phycologia* **32**: 79–99.
- Hallegraeff, G.** and Bolch, C. 1991. Transport of toxic dinoflagellate cysts via ships' ballast water. *Marine Pollution Bulletin* **22** (1): 27–30.
- Hammer, M.**, Jansson, A.M. and Jansson, B.-O. 1993. Diversity, change and sustainability: implications for fisheries. *Ambio* **22** (2–3): 97–105.
- Hawkes, M.W.** 1992. Seaweed biodiversity and marine conservation in the Pacific Northwest. *Northwest Environmental Journal* **8**: 146–148.
- Hay, M.E.** 1984. Patterns of fish and urchin grazing on Caribbean coral reefs: are previous results typical? *Ecology* **65**: 446–54.
- Helbling, E.W.**, Villafañe, V., Ferrario, M. and Holm-Hansen, O. 1992. Impact of natural ultraviolet radiation on rates of photosynthesis and on specific marine phytoplankton species. *Marine Ecology Progress Series* **80**: 89–100.
- Hight, K.** 1992. The legal odyssey of the continental shelf: Is it a shelf? Is it a slope? Is it only a legal concept? *Oceanus* **35** (4): 6–8.
- Highsmith, R.C.** and Coyle, K.O. 1990. High productivity of northern Bering Sea benthic amphipods. *Nature* **344**: 862–864.
- Hofman, D.J.** 1990. Increase in stratospheric background sulfuric acid aerosol mass in the past 10 years. *Science* **248**: 996–1000.
- Holligan, P.M.**, Viollier, M., Harbour, D.S., Camus, P. and Champagne-Philippe, M. 1983. Satellite and ship studies of coccolithophore production along a continental shelf edge. *Nature* **304**: 339–342.
- Houghton, J.T.**, Jenkins, G.J. and Ephraum, J.J. (eds) 1990. *Climate Change: The IPCC Scientific Assessment*. Cambridge University Press, Cambridge.
- Houghton, J.T.**, Callander, B.A. and Varney, S.K. (eds) 1992. *Climate Change 1992: The Supplementary Report to the IPCC Assessment*. Cambridge University Press, Cambridge.
- Hutchings, P.A.** and Wu, B.L. 1987. Coral reefs of Hainan Island, South China Sea. *Marine Pollution Bulletin* **18**: 25–26.
- Jorgensen, B.B.** 1980. Seasonal oxygen depletion in the bottom waters of a Danish fjord and its effect on the benthic community. *Oikos* **34**: 68–76.
- Karentz, D.** 1991. Ecological considerations of Antarctic ozone depletion. *Antarctic Science* **3** (1): 3–11.
- Keller, B.D.** and Jackson, J.B.C. (eds) 1993a. *Long-term Assessment of the Oil Spill at Bahia Las Minas, Panama. Synthesis Report*. Vol. I. *Executive Summary*. US Department of the Interior, Minerals Management Service, New Orleans.
- Keller, B.D.** and Jackson, J.B.C. (eds) 1993b. *Long-term Assessment of the Oil Spill at Bahia Las Minas, Panama. Synthesis Report*. Vol. II. *Technical Report*. US Department of the Interior, Minerals Management Service, New Orleans.
- Keller, M.D.**, Bellows, W.K. and Guillard, R.R.L. 1989. Dimethylsulfide production in marine phytoplankton. In: Saltzman, E.S. and Cooper, W.J. (eds), *Biogenic Sulfur in the Environment*. 167–182. ACS Symposium Series No. 393.
- Knowlton, N.** 1993. Sibling species in the sea. *Annual Reviews of Ecology and Systematics* **24**: 189–216.
- Knowlton, N.** and Jackson, J.B.C. 1994. New taxonomy and niche partitioning on coral reefs: jack of all trades or master of some? *Trends in Ecology and Evolution* **9**: 7–9.
- Lazrus, A.L.** and Gandrun, B.W. 1977. Stratospheric sulfate at high altitudes. *Geophysical Research Letter* **4**: 521–522.
- Leigh, E.G.**, Paine, R.T., Quinn, J.F. and Suchanek, T.H. 1987. Wave energy and intertidal productivity. *Proceedings of the National Academy of Sciences, USA* **84**: 1314–1318.
- Lessios, H.A.** 1988. Mass mortality of *Diadema antillarum* in the Caribbean: what have we learned. *Annual Review of Ecology and Systematics* **19**: 371–394.
- Lessios, H.A.**, Robertson, D.R. and Cubit, J.D. 1984. The spread of *Diadema* mass mortality through the Caribbean. *Science* **226**: 335–337.
- Levin, S.A.** 1992. The problem of pattern and scale in ecology. *Ecology* **73**: 1943–1983.
- Lubchenco, J.** 1978. Plant species diversity in a marine intertidal community: importance of herbivore food preference and algal competitive abilities. *American Naturalist* **112**: 23–39.
- Lubchenco, J.**, Menge, B.A., Garrity, S.D., Lubchenco, P.J., Ashkenas, L.R., Gaines, S.D., Emlet, R., Lucas, J. and Strauss, S. 1984. Structure, persistence, and role of consumers in a tropical rocky intertidal community (Taboguilla Island, Bay of Panama). *Journal of Experimental Marine Biology and Ecology* **78**: 23–73.
- Lubchenco, J.**, Navarrete, S.A., Tissot, B.N. and Castilla, J.C. 1993. Possible ecological responses to global climate change: nearshore benthic biota of Northeastern Pacific Coastal Ecosystems. In: Mooney, H.A., Fuentes, E.R. and Kronberg, B.I. (eds), *Earth System Response to Global Change: Contrasts between North and South America*. 147–166. Academic Press, San Diego.
- Lynch, M.**, Gabriel, W. and Wood, A.M. 1991. Adaptive and demographic responses of plankton populations to environmental change. *Limnology and Oceanography* **36** (7): 1301–1312.
- Lynch, M.** and Lande, R. 1993. Evolution and extinction in response to environmental change. In: Kareiva, P.M., Kingsolver, J.G. and Huey, R.B. (eds), *Biotic Interactions and Global Change*. 234–250. Sinauer Associates, Sunderland, Mass.
- McCarthy, S.** and Khambaty, F. 1994. International dissemination of epidemic *Vibrio cholerae* by cargo ship ballast and other nonpotable waters. *Applied and Environmental Microbiology* **60** (7): 2597–2601.
- McLachlan, A.**, Jaramillo, E., Donn, T.E. and Wessels, F. 1993. Sandy beach macrofauna communities and their control by the physical environment: a geographical comparison. *Journal of Coastal Research* **SI 15**: 27–38.
- Magnuson, J.J.** 1990. Long-term ecological research and the invisible present. *BioScience* **40**: 495–501.
- Margulis, L.** and Schwartz, K.V. 1988. *Five Kingdoms: An*

- Illustrated Guide to the Phyla of Life on Earth*, 2nd edn. W.H. Freeman, New York.
- Matrai, P.A.** and Keller, M.D. 1993. Dimethylsulfide in a large-scale coccolithophore bloom in the Gulf of Maine. *Continental Shelf Research* **13**: 831–843.
- Menge, B.A.** 1992. Community regulation: under what conditions are bottom-up factors important on rocky shores? *Ecology* **73**: 755–765.
- Menge, B.A., Berlow, E.L., Blanchette, C.A., Navarrete, S.A.** and Yamada, S.B. 1994. The keystone species concept: variation in interaction strength in a rocky intertidal habitat. *Ecological Monographs* **64**: 249–286.
- Menge, B.A.** and Lubchenco, J. 1981. Community organization in temperate and tropical rocky intertidal habitats: prey refuges in relation to consumer pressure gradients. *Ecological Monographs* **51**: 429–450.
- Menge, B.A., Lubchenco, J., Ashkenas, L.R.** and Ramsey, F. 1986. Experimental separation of effects of consumers on sessile prey in the low zone of a rocky shore in the Bay of Panama: direct and indirect consequences of food web complexity. *Journal of Experimental Marine Biology and Ecology* **100**: 225–269.
- Menge, B.A., Daley, B.** and Wheeler, P.A. 1995. Control of interaction strength in marine benthic communities. In: Polis, G.A. and Winemiller, R. (eds), *Food Webs: Integration of pattern and dynamics*. Chapman and Hall, New York (in press).
- Meybeck, M.** 1982. Carbon, nitrogen and phosphorus transport by world rivers. *American Journal of Science* **282**: 401–450.
- Moreno, C.A., Sutherland, J.P.** and Jara, F.H. 1984. Man as a predator in the intertidal zone of southern Chile. *Oikos* **46**: 359–364.
- National Research Council** 1995. Understanding Marine Biodiversity. National Academy of Sciences, Washington, DC.
- Norse, E.A.** (ed.) 1993. *Global Marine Biological Diversity. A strategy for building conservation into decision making*. Island Press, Washington, DC.
- Oliva, D.** and Castilla, J.C. 1986. The effect of human exclusion on the population structure of key-hole limpets *Fissurella crassa* and *F. limbata* on the coast of central Chile. *Publ. Staz. Zool. Napoli (I. Mar. Ecol.)* **7**: 201–217.
- Paine, R.T.** 1966. Food web complexity and species diversity. *American Naturalist* **100**: 65–75.
- Paine, R.T.** 1980. Food webs: linkage, interaction strength and community infrastructure. *Journal of Animal Ecology* **49**: 667–685.
- Paine, R.T.** 1992. Food-web analysis through field measurements of per capita interaction strength. *Nature* **355**: 73–75.
- Paine, R.T.** 1993. A salty and salutary perspective on global change. In: Kareiva, P.M., Kingsolver, J.G. and Huey, R.B. (eds), *Biotic Interactions and Global Change*. 347–355. Sinauer Associates, Sunderland, Mass.
- Paine, R.T.** 1994. *Marine Rocky Shores and Community Ecology: An experimentalist's perspective*. Ecology Institute, Oldendorf/Luhe, Germany.
- Palumbi, S.R.** 1992. Marine speciation on a small planet. *Trends in Ecology and Evolution* **7**: 114–118.
- Perrings, C., Mäler, K.-G., Folke, C., Holling, C.S.** and Jansson, B.-O. (eds), 1994. *Biodiversity Loss: Ecological and Economic Issues*. Cambridge University Press, Cambridge.
- Peterson, C.H., Barber, R.T.** and Skilleter, G.A. 1993. Global warming and coastal ecosystem response: how northern and southern hemispheres may differ in the Eastern Pacific Ocean. In: Mooney, H.A., Fuentes, E.R. and Kronberg, B.I. (eds), *Earth System Response to Global Change: Contrasts between North and South America*. 17–34. Academic Press, San Diego.
- Pomeroy, L.R.** and Deibel, D. 1986. Temperature regulation of bacterial activity during the spring bloom in Newfoundland coastal waters. *Science* **233**: 359–361.
- Pomeroy, L.R., Wiebe, W.J., Deibel, D., Thompson, R.J., Rowe, G.T.** and Pakulski, J.D. 1991. Bacterial responses to temperature and substrate concentration during the Newfoundland spring bloom. *Marine Ecology Progress Series* **75**: 143–159.
- Power, M.E., Tilman, D., Estes, J., Menge, B.A., Bond, W.J., Mills, L.S., Daily, G., Castilla, J.C., Lubchenco, J., Mooney, H.A.** and Paine, R.T. 1995. Challenges in the quest for keystones. *BioScience* (in press).
- Power, M.E.** and Mills, L.S., 1995. The keystone cops meet Hilo. *Trends in Ecology and Evolution* **10** (5): 182–184.
- Proctor, L.R.** and Fuhrman, J.A. 1990. Viral mortality of marine bacteria and cyanobacteria. *Nature* **343**: 60–62.
- Rasmussen, E.** 1977. The wasting disease of eelgrass (*Zostera marina*) and its effects on environmental factors and fauna. In: McRoy, C.P. and Helfferich, C. (eds), *Seagrass Ecosystems*. 1–51. Marcel Dekker, New York.
- Ray, G.C.** 1991. Coastal-zone biodiversity patterns. *BioScience* **41**: 490–498.
- Ray, G.C.** and Grassle, J.F. 1991. Marine biological diversity. *BioScience* **41**: 453–457.
- Richards, D.V.** and Davis, G.E. 1993. Early warnings of modern population collapse in black abalone *Haliotis cracherodii*, Leach, 1814, at the California Channel Islands. *Journal of Shellfish Research* **12** (2): 189–194.
- Richardson, K.** 1989. Algal blooms in the North Sea: the good, the bad and the ugly. *Dana* **8**: 83–93.
- Robles, C.** and Robb, J. 1993. Varied carnivore effects and the prevalence of intertidal algal turfs. *Journal of Experimental Marine Biology and Ecology* **166**: 65–91.
- Roemmich, D.** and McGowan, J. 1995a. Climatic warming and the decline of zooplankton in the California Current. *Science* **267**: 1324–1326.
- Roemmich, D.** and McGowan, J. 1995b. Climatic warming and the decline of zooplankton in the California Current. *Science* **268**: 352–353.
- Roughgarden, J., Iwasa, Y.** and Baxter, C. 1985. Theory of population processes for marine organisms. I. Demography of an open population with space-limited recruitment. *Ecology* **66**: 54–67.
- Ryther, J.H.** 1969. Photosynthesis and fish production in the sea. *Science* **166**: 72–76.
- Santelices, B.** 1989. *Algas Marinas De Chile*. Ediciones Universidad Católica de Chile, Santiago, Chile.
- Sherman, K.** 1990. Productivity, perturbations and options for biomass yields in Large Marine Ecosystems. In: Sherman, K., Alexander, L.M. and Gold, B.D. (eds), *Large Marine Ecosystems: Patterns, processes and yields*. 206. American Association for the Advancement of Science, Washington, DC.

- Sherman, K., Alexander, L.M. and Gold, B.D. (eds) 1990. *Large Marine Ecosystems: patterns, processes and yields*. American Association for the Advancement of Science, Washington, DC.
- Shiah, F.-K. and Ducklow, H.W. 1994. Temperature and substrate regulation of bacterial abundance, production and specific growth rate in Chesapeake Bay, USA. *Marine Ecology Progress Series* **103**: 297–308.
- Simenstad, C.A., Estes, J.A. and Kenyon, K.W. 1978. Aleuts, sea otters and alternate stable-state communities. *Science* **200**: 403–411.
- Smayda, T. 1990. Novel and nuisance phytoplankton blooms in the sea: evidence for a global epidemic. In: Graneli, E., Sundstrom, B., Elder, L. and Anderson, D.M. (eds), *Toxic Marine Phytoplankton*. 29–40. Elsevier, New York.
- Smayda, T. 1992. Global epidemic of noxious phytoplankton blooms and food chain consequences in large ecosystems. In: Sherman, K., Alexander, L.M. and Gold, B.D. (eds), *Food Chains, Yields, Models and Management of Large Marine Ecosystems*. 275–307. Westview Press, Boulder, Colorado.
- Smith, R.C., Prezelin, B.B., Baker, K.S., Bidigare, R.R., Boucher, N.P., Coley, T., Karentz, D., MacIntyre, S., Matlick, H.A., Menzies, D., Ondrusek, M., Wan, Z. and Waters, K.J. 1992. Ozone depletion; ultraviolet radiation and phytoplankton biology in Antarctic waters. *Science* **255**: 952–959.
- Sobel, J. 1993. Conserving biological diversity through marine protected areas. *Oceanus* **36**: 19–26.
- Sousa, W.P. 1979. Disturbance in marine intertidal boulder fields: the non-equilibrium maintenance of species diversity. *Ecology* **60**: 1225–1239.
- Spanier, E. and Galil, B. 1991. Lessepsian migration: a continuous biogeographical process. *Endeavor*, New Series, **15** (3): 102–106.
- Steele, J.H. 1985. A comparison of terrestrial and marine ecological systems. *Nature* **313**: 355–358.
- Steele, J.H. 1991. Marine functional diversity. *BioScience* **41**: 470–474.
- Steinbeck, J.R., Groff, J.M., Friedman, C.S., McDowell, T. and Hedrick, R.P. 1992. Investigations into a mortality among populations of the California black abalone *Haliotis cracherodii* on the central coast of California, USA. In: Shepherd, S. and Tegner, M. (eds), *Proceedings of the First International Abalone Symposium: Biology, fisheries, and culture*. Chapter 16. Blackwell Scientific Publications Ltd., Sydney.
- Steinberg, P.D., Estes, J.A. and Winter, F.C. 1995. Evolutionary consequences of food chain length in kelp forest communities. *Proceedings of the National Academy of Sciences, USA* (in Press).
- Steward, G.F., Wikner, J., Cochlan, W.P., Smith, D.C. and Azam, F. 1992. Estimation of virus production in the sea: II. Field results. *Marine Microbial Food Webs* **6**: 79–90.
- Suttle, C.A., Chan, A.M. and Cottrell, M.T. 1990. Infection of phytoplankton by viruses and reduction of primary productivity. *Nature* **347**: 467–469.
- Tatsukawa, R., Tanabe, S., Miyazaki, N. and Tobayama, T. (eds.) 1994. Marine pollution – mammals and toxic contaminants. *The Science of the Total Environment*, Vol. 154/2,3. Elsevier, New York.
- Tseng, C. K. 1984. *Common Seaweeds of China*. Science Press, Beijing.
- Tulkki, P. 1965. Disappearance of the benthic fauna from basins of Bornholm (southern Baltic) due to oxygen deficiency. *Cahiers de Biologie Marine* **6**: 445–463.
- Turner, R.E. and Rabalais, N.N. 1991. Changes in Mississippi River water quality this century: implications for coastal food webs. *BioScience* **41** (3): 140–147.
- Turner, R.E. and Rabalais, N.N. 1994. Coastal eutrophication near the Mississippi River delta. *Nature* **368**: 619–621.
- Valiela, I. 1984. *Marine Ecological Processes*. Springer-Verlag, New York.
- Wheeler, P.A. 1983. Phytoplankton nitrogen metabolism. In: Carpenter, E.J. and Capone, D.G. (eds), *Nitrogen in the Marine Environment*. 309–346. Academic Press, New York.
- Wiebe, W.J., Sheldon W.M. Jr, and Pomeroy, L.R. 1992. Bacterial growth in the cold: evidence for an enhanced substrate requirement. *Applied and Environmental Microbiology* **58**: 359–364.
- Wolfe, G.V., Bates, T.S. and Charlson, R.J. 1991. Climatic and environmental implication of biogas exchange at the sea surface: modeling DMS and the marine biological sulfur cycle. In: Mantoura, R.F.C., Martin, J.-M. and Wollast, R. (eds), *Ocean Margin Processes in Global Change*. 383–400. John Wiley, Chichester.
- Wood, A.M., Apelian, N. and Shapiro, L. 1993. Novel toxic phytoplankton: a component of global change? In: Guerrero, R. and Pedro-Alio, C. (eds), *Trends in Microbial Ecology, Proceedings, VI International Symposium on Microbial Ecology*. 479–483. Spanish Society for Microbiology, Barcelona.
- Wood, A.M. and Leatham, T. 1992. The species concept in phytoplankton ecology. *Journal of Phycology* **28**: 723–729.

6.1.10 Coral reefs

6.1.10.1 Introduction

The complex and diverse assemblage of organisms that constitutes the coral reef ecosystem covers over 600 000 km² (<30 m deep) of the tropical ocean. Over half this area is in the Indo-Western Pacific and about 15% is in the tropical Atlantic, the two centres of reef diversity (Smith 1978; Veron 1986; World Conservation Monitoring Centre 1992) (Figure 6.1-5). Modern coral reefs, representing approximately 6000 years of growth during the most recent period of sea-level rise, have an average gross carbonate production of 10 kg/m²/yr and average vertical growth rates of 3 mm/yr (Chave *et al.* 1972; Smith 1983). They are the oldest and largest biogenic structures in nature, holding detailed palaeoecological and climate records (Smith and Buddemeier 1992; Dunbar and Cole 1993). Coral reefs have more species per unit area than any other marine ecosystem but, with the exception of a few groups such as fishes and corals, most are poorly studied (Böhlke and Chaplin 1968; Springer 1982; Achituv and Dubinsky 1990; National Research Council 1995). Reefs have fewer species than tropical forests, with which they are often compared, but a much higher phyletic diversity (Ray and Grassle 1991; Briggs 1994). Disturbance appears to play a major role in the maintenance of species diversity in coral reefs,

(Connell 1978; Harmelin-Vivien and Bourlière 1989; Sale 1991a, b). However, the uncertain species-level taxonomy of even the best-known organisms makes it difficult to evaluate with confidence either the total number of species or the role of niche diversification among them (Knowlton and Jackson 1994). Many coral reef species rely for population replenishment on larvae released from 'upstream' reefs. This reliance may increase opportunities for genetic diversification compared to populations replenished from local stocks and/or by vegetative reproduction, which are also common among reef species (Benzie 1994). Day-to-day metabolic requirements are provided by a low steady supply of inorganic nutrients (D'Elia and Wiebe 1990). While reefs are characterized by the complexity of their biological relationships, it is their ability to construct massive calcium carbonate frameworks which sets them apart from all other ecosystems. The construction comes about through interactions of organisms, heuristically lumped into functional groups, including framework builders (corals), facilitators (symbiotic algae), and grazers (Figure 6.1-6). Studies of reef communities through geological time or across gradients of diversity indicate that different combinations of species may constitute a functional group (Jackson 1992, 1994a). However, changes in keystone species (single-species functional groups) can cause dramatic alterations in reef structure and functioning.

6.1.10.2 Threats to reefs

The principal direct human impacts that threaten reefs are nutrient loading, sedimentation and destruction from poor land-use practices, dredging and coral mining. Reefs hold a significant proportion of the world's fishery resources, and they are very sensitive to overfishing, particularly the removal of large predators and herbivorous fishes (Salvat 1987; Wells 1988; Hatcher *et al.* 1989; Russ 1991). A key feature of human impact on reefs is the disturbance of biotic and abiotic factors which shift reef composition from framework builders (corals) to non-framework builders

(algae; Figure 6.1-6). While global climate change, including sea-level rise, increased seawater temperatures, and increased ultraviolet (UV-B) radiation, are a potential long-term threat to reefs, there is an immediate need to manage the impact of relentless coastal human population growth (D'Elia *et al.* 1991; Norse 1993).

6.1.10.3 Productive capacity, biomass and decomposition

Human impacts on biodiversity. Reef corals thrive in the low but steady input of nutrients from the oligotrophic ocean waters of the tropics. Extreme nutrient loading may disrupt the dynamic balance of corals and algae in favour of the benthic algae which can overgrow, shade and smother corals (Littler and Littler 1985). Suspended sediments and planktonic algal blooms may shade corals and result in over-dominance of benthic algae.

Ecosystem consequences of impacts. Coral reef productivity, respiration and calcification have been well studied, and 'standards of functional performance' have been suggested as indicators of ecosystem health (Odum and Odum 1955; Johannes *et al.* 1972; Kinsey 1991). In a healthy reef, the ratio of gross Productivity/Respiration = 1, indicating internal cycling. This P/R ratio can shift to >1 if there are excessive nutrients, additional production and export, or to <1 if there is increased respiration over production implying import of material (D'Elia and Wiebe 1990; Kinsey 1991). Excess nutrients stimulate algal growth and can inhibit calcification and reef bioconstruction, shifting the balance to bioerosion (Kinsey and Davies 1979; Hallock and Schlager 1986).

6.1.10.4 Sediment structure and nutrients

Human impacts on biodiversity. Increased sedimentation from poor land-use practices may change sediments from aerobic to anaerobic as organic material accumulates. Nutrients may then 'bleed' out of the sediments over time, stimulating benthic productivity and prolonging the impact long after corrective measures have been taken (Maragos *et al.* 1985; Smith *et al.* 1981).

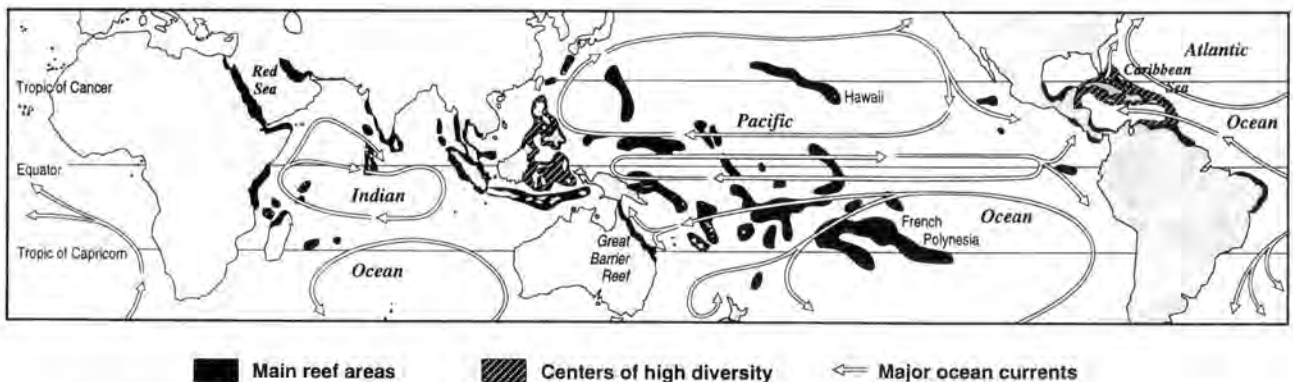

Figure 6.1-5: Global distribution of the coral reef biome. (From: Wells and Hanna, 1992.)

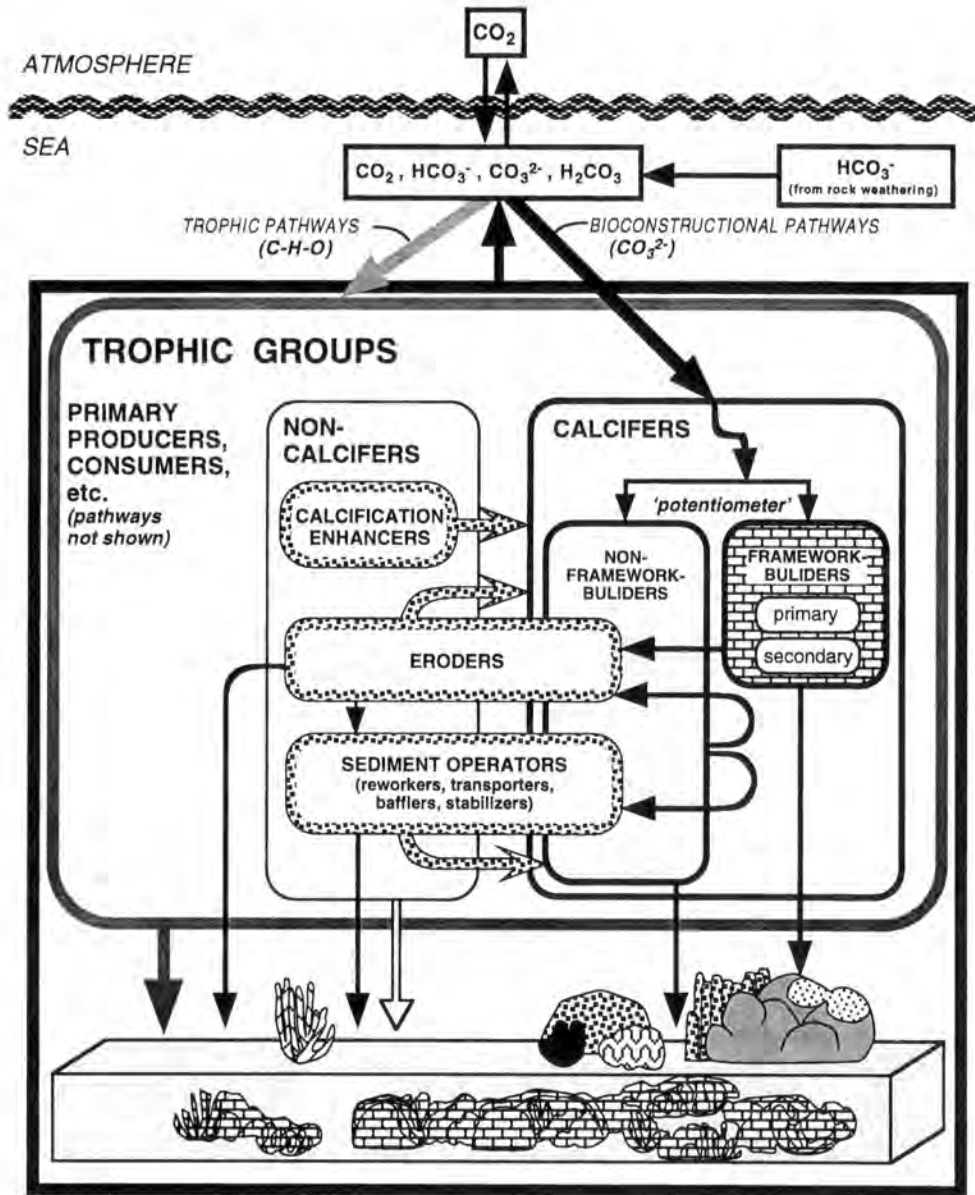

Figure 6.1-6: The principal bioconstrucational functional groups of the coral reef ecosystem. Reef construction is a result of the activities of stony coral-framework builders which are influenced by 'modifier groups' such as calcification enhancers, eroders and sediment operators. A key feature of the figure is the 'potentiometer' which shifts between framework-builders and non-framework-builders depending on changes in nutrients, grazing and physical conditions.

Ecosystem consequences of impacts. Coral reef ecosystems are characterized by slow removal and loss of nutrients and relatively low sediment accumulation (Johannes *et al.* 1983; Pomeroy *et al.* 1974). Human impact can switch the reef ecosystem to external cycling of nutrients and shift benthic dominance from corals to algae (D'Elia and Wiebe 1990).

6.1.10.5 Water circulation and quality

Human impacts on biodiversity. Coral reefs thrive in well circulated waters, both clear and naturally turbid (Done 1982). However, enhanced turbidity and freshwater

runoff from land is generally inimical to reef growth and development (Kühlmann 1988). Coral and sand mining and dredging can alter the configuration of reefs and hence water circulation patterns.

Ecosystem consequences of impacts. Coral atolls (necklaces of oceanic reefs and coral islands surrounding a central lagoon) provide good examples of functional differences driven by water circulation. Atolls may be characterized by their connection to surrounding water masses. The lagoons of 'closed' atolls are profoundly different from 'open' ones with increased nutrient retention time and productivity (Birkeland 1987).

6.1.10.6 Atmospheric properties

Human impacts on biodiversity. Increased seawater temperatures, possibly linked to global warming, and elevated UV-B radiation have been implicated in coral bleaching through the loss of symbiotic algae and/or their pigments (Williams and Bunkley-Williams 1991; Brown and Ogden 1992; Gleason and Wellington 1993). Bleaching stresses corals causing decreased calcification and reproductive capacity (Szmant and Gassman 1990), death and extirpation over wide areas (Glynn 1988). Increased seawater temperatures and rates of sea-level rise may 'drown' some reefs and cause a geographic shift in reef distribution (Buddemeier and Smith 1988). Some scenarios of global warming suggest an increased frequency of tropical storms, which may affect the rate of reef growth.

Ecosystem consequences of impacts. While reefs are sinks for CO₂ over geologic time, reef calcification causes pH reduction and release of CO₂ from seawater resulting in a net positive flux to the atmosphere (Smith and Buddemeier 1992). It is not expected that changes in reef biodiversity will have major impacts on the global atmosphere.

6.1.10.7 Landscape and seascape structure

Human impacts on biodiversity. Reefs protect the coast from the open ocean, fostering the development of a complex interdependent 'seascape' of ecosystems, including mangrove forests and seagrass beds. Human occupation and exploitation of the coastal zone cause profound changes in the configuration and interaction of the major ecosystems of the coastal seascape. Coastal clearing and deforestation for development, construction materials, charcoal and mariculture and destruction of seagrass beds, cause increased runoff of sediments and nutrients inimical to coral reefs. Reef biodiversity is dependent on the accessibility of adjacent ecosystems for feeding areas, nursery grounds, and flows of energy and materials (Ogden 1987, 1988; Figure 6.1-7).

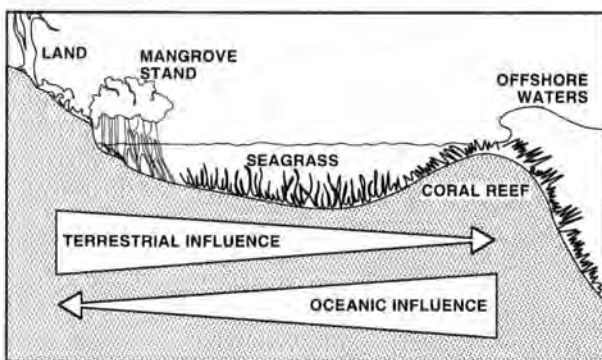

Figure 6.1-7: The tropical coastal seascape showing buffering of the land from the ocean by reefs and the buffering of reefs from the land by coastal forests and seagrass beds (see text for detail). (After: Ogden 1987.)

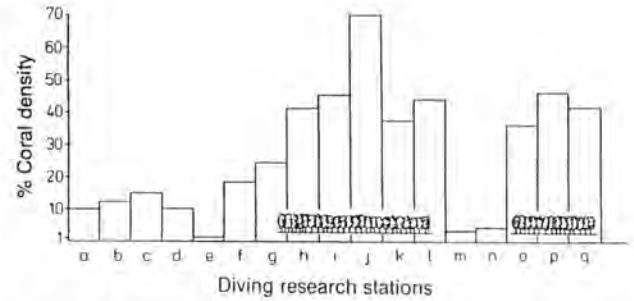

Figure 6.1-8: The average coral density (cover) around Ishigaki Island, Ryukyus, Japan. The pollutant-absorbing effects of the shoreline forest belt is illustrated. (From: Kühlmann 1988.)

Ecosystem consequences of impacts. Coastal reefs attain their greatest development when isolated or otherwise protected from land run-off by coastal forests and adjoining seagrass beds which slow and baffle water movements allowing sediments to fall from suspension and nutrients to be absorbed. Kühlmann (1988) found that coral density was directly related to the preservation of this buffering capacity of forest margins in the Ryukyu Islands (Figure 6.1-8).

6.1.10.8 Biotic linkages and species interactions

Human impacts on biodiversity. Coral reefs are perhaps best known for the complexity of the biological relationships between species and functional groups. For example, Figure 6.1-9,a shows the hypothetical relationship between fishes, the ratio of corals/algae, and the major herbivorous sea urchin *Diadema* on undisturbed reefs in the Caribbean. The first critical disturbance was overfishing, which removed the larger size classes of predatory fishes as well as herbivorous groups. This impact 'released' *Diadema* populations from predation and competition and they attained artificially high population densities (Hay 1984; Figure 6.1-9,b). The mass mortality of *Diadema* in 1983–84 removed this remaining herbivore and the coral/algal ratio of Caribbean reefs shifted to an alternate state of algal dominance (Lessios *et al.* 1984; Carpenter 1986; Knowlton 1992; Hughes 1994; Figure 6.1-9,c).

This Caribbean basin-wide phenomenon has been exacerbated by circumstances that lower thresholds for macroalgal dominance over corals (Knowlton 1992): they include increased availability of nutrients (Hallock and Schlager 1986); increased sedimentation associated with deforestation (Cortes and Risk 1985); storm damage (Woodley *et al.* 1981), oil spills (Jackson *et al.* 1989), and mass bleaching of corals (Williams and Bunkley-Williams 1991). Similarly, 'outbreaks' of crown-of-thorns starfish populations in the Indo-Pacific can dominate the dynamics of many coral reefs (Done 1987, 1992).

Ecosystem consequences of impacts. The complex biotic linkages characteristic of reefs depend upon the ecosystem-

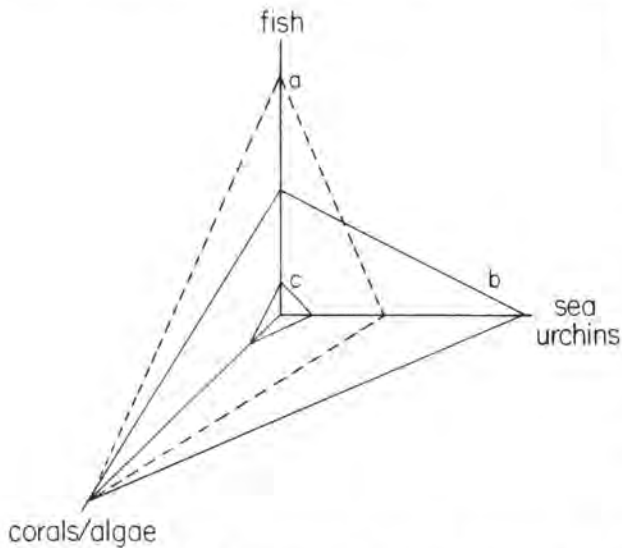

Figure 6.1-9: Model of the negative synergistic response of Caribbean coral reef communities to overfishing and sea urchin disease. Prior to overfishing, reefs existed in state (a), with high fish abundance, moderate urchin abundance, and large amounts of coral relative to algae. Overfishing (state b) led to a switch in the relative abundances of fishes and sea urchins, but no change in the relative abundances of coral and algae. Collapse of the sea urchins due to disease (state c) resulted in the replacement of corals by algae and further declines in fishes (From: Jackson, 1994b.)

wide effects of a few functional groups and organisms and influences such as nutrients which can shift the balance of reefs from framework-building corals to non-framework-builders such as benthic algae (Figure 6.1-6).

6.1.10.9 Microbial activities

Human impacts on biodiversity. Little is known about the human impact on reef microbial populations with the exception of inorganic nutrient processing. Under undisturbed conditions, virtually all microbial activity takes place within the benthos. Nitrogen gas is fixed by procaryotes on reef fronts and microbially transformed to nitrate, some of which is exported out of the reef system (Wiebe 1985). Phosphate is slowly exchanged by the benthos (Atkinson and Smith 1983).

Ecosystem consequences of impacts. Nutrient pollution (sewage, runoff) reduces N fixation and causes: (1) accumulation of PO_4 and fixed N within the sediments; (2) benthic macro-algal blooms; (3) micro-algal blooms in the water column. These blooms reduce light penetration which adversely affects the normal benthic plants and symbiotic algae. Prolonged exposure to high nutrients can lead to the smothering of corals and the transformation of the benthos into a low-diversity, benthic algal dominated system (D'Elia and Wiebe 1990).

6.1.10.10 Summary and relevance to human activities

Coral reefs, which are exploited by millions of people, are

acknowledged to be the most diverse marine ecosystem. Periodic disturbance plays a major role in the maintenance of their biodiversity, the persistence of which relies on the interconnections among often widely dispersed metapopulations, and on a low, steady supply of inorganic nutrients. The massive calcium carbonate structures of reefs are formed through the collaboration of unique functional groups including framework-builders (corals), facilitators (symbiotic algae) and grazers. Studies of reef communities through geological time or across gradients of diversity show that the composition of functional groups can vary greatly. However, changes in keystone species (single-species functional groups) can cause dramatic alterations in reef structure and functioning. The most common manifestation of disturbance is a shift from coral dominance to benthic algal dominance. Reefs protect the coast from the open ocean, fostering the development of a complex interdependent 'seascape' of ecosystems, including mangrove forests and seagrass beds. Reef biodiversity is dependent on adjacent ecosystems for feeding areas and nursery grounds and for protection against land runoff, allowing sediments to be trapped and nutrients to be sequestered. It is generally conceded that global reef diversity is declining from the impact of chronic human disturbances and is threatened by global climate change. Some effects of chronic human disturbance may be temporarily 'invisible': for example, few reef scientists worried about the effects of prolonged overfishing on corals until the demise of the sea urchin *Diadema* led to the wholesale replacement of corals by algae on these reefs (Figure 6.1-9). Similarly, some currently abundant species may already be doomed because of 'extinction debts' associated with habitat reduction. There appears to be little hope for the survival of reefs that are near relentlessly expanding coastal populations. Protection of more remote reefs will require inter-governmental co-operation in surveying, monitoring, comparative research and integrated coastal management within global sub-regions, such as the tropical western Atlantic, encompassing the geographic range of reef metapopulations and of key ocean processes.

6.1.10.11 Management implications

Reefs have responded to efforts to protect them from exploitation in parks and reserves (McClanahan 1994) and to pollution control (Maragos *et al.* 1985), and these efforts at the grassroots and local government level should be encouraged and expanded. However, the meta-population characteristics of most reef organisms argue strongly that the ultimate conservation of reefs, as much of the ocean environment, will be through inter-governmental management of human impact within ecologically defined sectors of the world's tropical oceans.

References

- Achituv, Y. and Dubinsky, Z. 1990. Evolution and zoogeography of coral reefs. In: Dubinsky, Z. (ed.), *Ecosystems of the World 25: Coral Reefs*. 1–9. Elsevier, Amsterdam.
- Atkinson, M.J. and Smith, S.V. 1983. C:N:P ratios of benthic marine plants. *Limnology Oceanography* **28**: 568–574.
- Benzie, J.A.H. 1994. Patterns of genetic variation in the Great Barrier Reef. In: Beaumont, A. (ed.), *Genetics and Evolution of Aquatic Organisms*, 69–79. Chapman and Hall, London.
- Birkeland, C. (ed.) 1987. Comparison between Atlantic and Pacific tropical marine coastal ecosystems: community structure, ecological processes, and productivity. *UNESCO Reports in Marine Science* 46. UNESCO, Paris.
- Böhlke, J.E. and Chaplin, C.C.G. 1968. *Fishes of the Bahamas and adjacent waters*. Livingston Publ. Co., Wynnewood, Pa.
- Briggs, J.C. 1994. Species diversity: land and sea. *Systematic Biology* **43**: 130–135.
- Brown, B.E. and Ogden, J.C. 1992. Coral bleaching. *Scientific American* **268** (1): 64–70.
- Buddemeier, R.W. and Smith, S.V. 1988. Coral reef growth in an era of rapidly rising sea levels: predictions and suggestions for longterm research. *Coral Reefs* **7**: 51–56.
- Carpenter, R.C. 1986. Partitioning herbivory and its effects on coral reef algal communities. *Ecology Monographs* **56**: 345–365.
- Chave, K.E., Smith, S.V. and Roy, K.J. 1972. Carbonate production by coral reefs. *Marine Geology* **12**: 123–140.
- Connell, J.H. 1978. Diversity in tropical rainforests and coral reefs. *Science* **199**: 1302–1310.
- Cortes, J. and Risk, M.J. 1985. A reef under siltation stress: Cahuita, Costa Rica. *Bulletin of Marine Science* **36**: 339–356.
- D'Elia, C.F., Buddemeier, R.W. and Smith, S.V. 1991. Workshop on coral bleaching, coral reef ecosystems and global change: report of proceedings. *Maryland Sea Grant*, 49.
- D'Elia, C.F. and Wiebe, W.J. 1990. Biochemical nutrient cycles in coral reef ecosystems. In: Dubinsky, Z. (ed.), *Ecosystems of the World 25: Coral Reefs*. 49–74. Elsevier, Amsterdam.
- Done, T.J. 1982. Patterns in the distribution of coral communities across the central Great Barrier Reef. *Coral Reefs* **1**: 95–107.
- Done, T.J. 1987. Simulation of the effects of *Acanthaster planci* on the population structure of massive corals in the genus *Porites*: evidence of population resilience? *Coral Reefs* **6**: 75–90.
- Done, T.J. 1992. Constancy and change in some Great Barrier Reef coral communities: 1980–1990. *American Zoologist* **32**: 655–662.
- Dunbar, R.B. and Cole, J.E. (eds) 1993. Coral records of ocean atmosphere variability. *Publ Univ. Corp. for Atmospheric Research (UCAR)*, Boulder, Col.
- Gleason, D.F. and Wellington, G.M. 1993. Ultraviolet radiation and coral bleaching. *Nature* **365**: 836–838.
- Glynn, P.W. 1988. El Niño–Southern Oscillation 1982–83: nearshore population, community, and ecosystem responses. *Annual Review of Ecology and Systematics* **19**: 309–345.
- Hallock, P. and Schlager, W. 1986. Nutrient excess and the demise of coral reefs and carbonate platforms. *Palaeos* **1**: 389–398.
- Harmelin-Vivien, M.L. and Bourlière, F. (eds). 1989. *Vertebrates in Complex Tropical Systems. Ecological Studies* **69**: Springer-Verlag, Berlin.
- Hatcher, B.G., Johannes, R.E. and Robertson, A.I. 1989. Review of research relevant to the conservation of shallow water tropical marine systems. *Oceanography and Marine Biology Annual Review* **27**: 337–414.
- Hay, M.E. 1984. Patterns of fish and urchin grazing on Caribbean coral reefs: are previous results typical? *Ecology* **65**: 446–454.
- Hughes, T.P. 1994. Catastrophe, phase shifts and large scale degradation of a Caribbean coral reef. *Science* **226**: 1547–1549.
- Jackson, J.B.C. 1991. Adaptation and diversity of reef corals. *Bioscience* **41**: 475–482.
- Jackson, J.B.C. 1992. Pleistocene perspectives on coral reef community structure. *American Zoologist* **32**: 719–731.
- Jackson, J.B.C. 1994a. Community unity? *Science* **264**: 1412–1413.
- Jackson, J.B.C. 1994b. Constancy and change of life in the sea. *Philosophical Transactions of the Royal Society of London, B* **344**: 55–60.
- Jackson, J.B.C., Cubit, J.D., Keller, B.D., Batista, V., Burns, K., Caffey, H.M., Caldwell, R.L., Garrity, S.D., Getter, C.D., Gonzales, C., Guzman, H.M., Kaufman, K.W., Knap, A.H., Levings, S.C., Marshall, M.J., Steger, R., Thompson, R.C. and Weil, E. 1989. Ecological effects of a major oil spill on Panamanian coastal marine communities. *Science* **243**: 37–44.
- Johannes, R.E., Alberts, J., D'Elia, C., Kinzie, R.A., Pomeroy, L.R., Sottile, L., Wiebe, W., Marsh, J.A. Jr., Helfrich, P., Maragos, J., Meyer, J., Smith, S., Crabtree, D., Roth, A., McClosky, L.R., Betzer, S., Marshall, N., Pilson, M.E.Q., Telek, G., Clutter, R.I., DuPaul, W.D., Webb, K.L. and Wells, J.M. Jr. 1972. The metabolism of some coral reef communities: a team study of nutrient and energy flux at Eniwetok. *Bioscience* **22**: 541–543.
- Johannes, R.E., Wiebe, W.J. and Crossland, C.J. 1983. Three patterns of nutrient flux in a coral reef community. *Marine Ecology Progress Series* **12**: 131–136.
- Kinsey, D.W. 1991. The coral reef: an owner-built, high-density, fully-serviced, self-sufficient, housing estate in the desert: or is it? *Symbiosis* **10**: 1–22.
- Kinsey, D.W. and Davies, P.J. 1979. Effects of elevated nitrogen and phosphorous on coral reef growth. *Limnology Oceanography* **24**: 935–940.
- Knowlton, N. 1992. Thresholds and multiple stable states in coral reef community dynamics. *American Zoologist* **32**: 674–682.
- Knowlton, N. and Jackson, J.B.C. 1994. New taxonomy and niche partitioning on coral reefs: jack of all trades or master of some? *Trends in Ecology and Evolution* **9**: 7–9.
- Kühlmann, D.H.H. 1988. The sensitivity of coral reefs to environmental pollution. *Ambio* **17**: 13–21.
- Lessios, H.A., Robertson, D.R. and Cubit, J.D. 1984. Spread of *Diadema* mass mortality through the Caribbean. *Science* **226**: 335–337.
- Littler, M.M. and Littler, D.S. 1985. Factors controlling relative dominance of primary producers on biotic reefs. *Proceedings Fifth International Coral Reef Congress, Tahiti*, Vol. **4**: 35–39.
- McClanahan, T.R. 1994. Kenyan coral reef lagoon fish: effects of fishing, substrate complexity and sea urchins. *Coral Reefs* **13**: 231–241.
- Maragos, J.E., Evans, C. and Holthus, P. 1985. Reef corals in Kaneohe Bay six years before and after termination of sewage

- discharges (Oahu, Hawaiian Archipelago) *Proceedings, Fifth International Coral Reef Congress, Tahiti*, Vol. 4: 189–194.
- National Research Council** 1995. *Understanding Marine Biodiversity: A research agenda for the nation*. National Academy Press, Washington, DC.
- Norse, E.A.** (ed.) 1993. *Global Marine Biological Diversity: A strategy for building conservation into decision making*. Island Press, Washington, DC.
- Odum, H.T. and Odum, E.P.** 1955. Trophic structure and productivity of a windward coral reef community on Eniwetok Atoll. *Ecological Monographs* 25: 295–320.
- Ogden, J.C.** 1987. Cooperative coastal ecology at Caribbean marine laboratories. *Oceanus* 30: 9–15.
- Ogden, J.C.** 1988. The influence of adjacent systems on the structure and function of coral reefs. *Proceeding, Sixth International Coral Reef Symposium, Australia*, Vol. 1: 123–129.
- Pomeroy, L.R., Pilson, M.E.Q. and Wiebe, W.J.** 1974. Tracer studies of the exchange of phosphorus between reef water and organisms on the windward reef of Eniwetok Atoll. *Proceedings, Second Internat. Coral Reef Symposium* 1: 87–96.
- Ray, G.C. and Grassle, J.F.** 1991. Marine biological diversity. *Bioscience* 41: 453–457.
- Russ, G.R.** 1991. Coral reef fisheries: effects and yields. In: Sale, P.F. (ed.). *The Ecology of Fishes on Coral Reefs*. 601–635. Academic Press, New York.
- Sale, P.F.** (ed.) 1991a. *The Ecology of Fishes on Coral Reefs*. Academic Press, New York.
- Sale, P.F.** 1991b. Reef fish communities; open non-equilibrium systems. In: P.F. Sale (ed.). *The Ecology of Fishes on Coral Reefs*. 564–598. Academic Press, New York.
- Salvat, B.** (ed.) 1987. *Human Impacts on Coral Reefs: Facts and recommendations*. Antenne Museum Ecole Pratique des Hautes Etudes, French Polynesia.
- Smith, S.V.** 1978. Coral-reef area and the contributions of reefs to processes and resources of the world's oceans. *Nature* 273: 225–226.
- Smith, S.V.** 1983. Coral reef calcification. In: Barnes, D.J. (ed.). *Perspectives on Coral Reefs*. 240–247. Australian Institute of Marine Science, Townsville, Qld.
- Smith, S.V. and Buddemeier, R.W.** 1992. Global change and coral reef ecosystems. *Annual Review of Ecology and Systematics* 23: 89–118.
- Smith, S.V., Kimmerer, W.J., Laws, E.A., Brock, R.E. and Walsh, T.W.** 1981. Kaneohe Bay sewage diversion experiment: perspectives on ecosystem responses to nutritional perturbation. *Pacific Science* 35: 279–402.
- Springer, V.G.** 1982. Pacific Plate biogeography, with special reference to shorefishes. *Smithsonian Contributions in Zoology* 367: 1–182.
- Szmant, A.M. and Gassman, N.J.** 1990. The effects of prolonged bleaching on the tissue biomass and reproduction of the reef coral *Montastrea annularis*. *Coral Reefs* 8: 217–224.
- Veron, J.E.N.** 1986. *Coral Reefs of Australia and the Indo-Pacific*. Angus and Robertson, Australia.
- Wells, S.M.** 1988. *Coral Reefs of the World*, 3 Vols. UNEP/IUCN.
- Wells, S. and Hanna, N.** 1992. *The Greenpeace Book of Coral Reefs*. Sterling Publ. Co., New York.
- Wiebe, W.J.** 1985. Nitrogen dynamics on coral reefs. *Proceedings, Fifth International Coral Reef Symposium*, Vol. 3: 401–406.
- Williams, E.H. and Bunkley-Williams, L.** 1991. The world-wide coral reef bleaching cycle and related sources of coral mortality. *Atoll Research Bulletin* 331: 1–17.
- Woodley, J., Chornesky, E., Clifford, P., Jackson, J., Kaufman, L., Knowlton, N., Lang, J., Pearson, M., Porter, J., Rooney, M., Rylaarsdam, K., Tunnicliffe, V., Wahle, C., Wulff, J., Curtis, A., Dallmeyer, M., Jupp, B., Koehl, M., Niegel, J. and Sides, E.** 1981. Hurricane Allen's impact on Jamaican coral reefs. *Science* 214: 749–755.
- World Conservation Monitoring Centre.** 1992. *Global Biodiversity: Status of the Earth's living resources*. Chapman and Hall, London.

6.1.11 Mangrove systems

6.1.11.1 Introduction

The major form of vegetation supporting biodiversity in tropical estuarine ecosystems is the intertidal forested wetland known as mangrove. About $240 \times 10^3 \text{ km}^2$ of mangroves (Lugo *et al.* 1990; Twilley *et al.* 1992) dominate tropical river deltas, lagoons and estuarine complexes developed from terrigenous sediments (Thom 1982). In addition, mangroves colonize shorelines and islands in sheltered shallow coastal waters formed principally from carbonate sediments. These are geomorphologically distinct regional landscapes with local variations in topography and hydrology that result in the evolution of distinct ecological types of mangroves (with respect to both structure and function) such as riverine, fringe, basin and dwarf forests (Lugo and Snedaker 1974). Although there are relatively few species of mangrove trees (54 species; Tomlinson 1986), mangrove ecosystems are nevertheless unique because they include structural niches and refugia for numerous non-mangrove species. Mangroves are salt-tolerant forested wetlands at the land–sea interface which form interdependent links between inland terrestrial landscapes and the nearshore marine environment (Macnae 1968; Chapman 1976; Odum *et al.* 1982; Tomlinson 1986; Gilmore and Snedaker 1993; Twilley *et al.* 1993). The dominant ecological ‘services’ of mangroves are the maintenance of nearshore marine habitats and the concomitant provision of food and refugia to a variety of organisms at different trophic levels (Odum and Heald 1972; Thayer *et al.* 1987; Sasekumar *et al.* 1992; Yañez-Arancibia *et al.* 1988, 1993; Rojas *et al.* 1992). Mangroves also play a major role in maintaining water quality and shoreline stability by controlling nutrient and sediment distributions in estuarine waters (Walsh 1967; Twilley 1988).

6.1.11.2 Human impacts on relevant biodiversity components

The coupling of mangroves to coastal waters is considered to be the most important link in the sustainability of

subsistence, commercial and recreational fisheries in estuaries and related nearshore marine habitats. Historically, the establishment of mangrove plantations promoted sustainable use of this valuable resource for forest products such as timber, fuelwood, tannins, pulpwood and charcoal in the Old World tropics (see Watson 1928; Saenger *et al.* 1983; Snedaker 1986). Recent forms of direct impact include the destruction of biodiversity by land uses such as aquaculture (shrimp ponds), agriculture (rice and salt ponds), urban development, and forest clear-felling for economic gain and other purposes (see Pannier 1979). Indirect loss of mangrove biodiversity components has resulted from human alterations of upland watersheds, causing diversion of freshwater flows (dams and canals), and deterioration of water quality from the input of toxic materials (heavy metals, oil spills, pesticides) and nutrients to rivers and coastal waters.

6.1.11.3 Productive capacity, biomass and decomposition

Ecosystem consequences of impacts: On a global scale, the highest species diversity and primary productivity occur in low-latitude regions where precipitation exceeds evaporation. Standing crop may reach 300–400 Mg/ha (Twilley *et al.* 1992; Saenger and Snedaker 1993). Human impacts change productivity, distribution and biomass accumulation by altering soil conditions such as salinity, sulphide concentrations, waterlogging, redox potentials, nutrient concentrations, soil structure and pH (Cintrón *et al.* 1978). Regional rates of litter production in mangroves are a function of water turnover and have been ranked according to ecological type as riverine > fringe > basin > dwarf (Pool *et al.* 1975; Twilley *et al.* 1986). The surficial hydrology is a critical factor in maintaining these diverse functions. Artificially reduced exposure to tides, and lower freshwater input, cause higher soil salinity (Cintrón *et al.* 1978), anoxia, and the accumulation of growth-inhibiting toxic substances such as hydrogen sulphide (Carlson *et al.* 1983; Nickerson and Thibodeau 1985; McKee *et al.* 1988) which result in increased stress (Hicks and Burns 1975). Regional-scale changes in freshwater surface inflow into mangrove areas have also caused reduction in the secondary productivity of tropical estuarine ecosystems due to the degradation of habitat and water quality of estuarine ecosystems. Changes in the species composition of mangrove communities alter the quality of leaf litter and result in different rates of decomposition and an altered quality of organic matter export (POC vs DOC) to the adjacent estuary (Boto and Bunt 1981; Twilley 1985, 1988; Snedaker 1989). Eliminating a given species of mangrove along zones of edaphic conditions may also alter specific types of refugia available to consumers (e.g. those offered by species with prop roots vs those with pneumatophores).

6.1.11.4 Soil structure and nutrients

Ecosystem consequences of impacts. Mangroves, particularly those in the genus *Rhizophora*, have a low decomposition rate of root biomass relative to root production, which results in the accumulation of organic matter in the soil and leads to the development of mangrove peat deposits (Snedaker 1993). Differences in litter quality among mangrove species also affect litter decomposition, leading to nutrient immobilization and accumulation (particularly nitrogen), and hence the fertility of mangrove soils (Twilley *et al.* 1986; Steyer 1988). Mineral accumulation is enhanced by mangrove prop roots and pneumatophores, which trap sediments suspended in the water column during low-velocity flooding. Coastal forested wetlands thereby enrich intertidal soils and retard the forces of erosion along the shoreline (Scoffin 1970; Lynch *et al.* 1989). In areas colonized by benthic calcareous algae (e.g. *Halimeda* and *Penicillus*), mangroves stabilize the new carbonate sediment and promote soil development. This process has led to a significant expansion of mangrove shorelines in southeast Florida along with a rise in sea level equivalent to about 23 cm per 100 years (Maul and Martin 1993; Snedaker *et al.* 1994). Mangrove rookeries are enriched in nitrogen and phosphorus which stimulate the productivity of mangrove vegetation. The density and diversity of herbivores is greater on mangrove island rookeries, compared to proximal islands that lack nutrient enrichment (Onuf *et al.* 1977). The so-called 'soil reclamation' projects in Africa, as well as in parts of Asia (cf. Ponnampurna 1984) for agriculture (and aquaculture) have reduced regional levels of coastal productivity due to loss of mangrove habitats. In many instances the conversion of organic-rich, pyritic mangrove soils leads to the formation of acid sulphate soils that are both extremely difficult to reclaim further, and incapable of supporting the original diversity of the landscape (cf. Dost 1973; Moorman and Pons 1975).

6.1.11.5 Water distribution, balance and quality

Ecosystem consequences of impacts. The conversion of coastal landscapes to agriculture has resulted in the deterioration of water quality in contiguous estuarine ecosystems. In Ecuador, pesticides from banana plantations have been implicated in the morphological deformity of shrimp in the Guayas River estuary (Taura syndrome). Water-borne heavy metals in the coastal regions of Brazil and Malaysia (Peterson *et al.* 1979) influence mangrove biodiversity and have impacts on the biodiversity and response of estuarine ecosystems. In Malaysia, the reduction of mangroves has resulted in increased turbidity of estuarine waters in the affected areas (Nixon *et al.* 1984). The nutrient removal capacity of the mangrove community *sensu lato* has been utilized for waste-water treatment in many tropical localities, particularly for nitrate

removal (Nedwell 1975; Clough *et al.* 1983). This practice is presumed to interfere with the dissolved organic matter (DOM) export from basin mangrove forests that augments aquatic primary production and the dynamics of phytoplankton (Prakash 1971; Prakash *et al.* 1973; Rivera *et al.* 1995).

6.1.11.6 Atmospheric properties

Ecosystem consequences of impacts. Nitrogenase activity has been observed on decomposing leaves, root surfaces (prop roots and pneumatophores), and in sediment. This enzyme makes an important contribution to the nitrogen budget in mangrove systems (Kimball and Teas 1975; Gotto and Taylor 1976; Zuberer and Silver 1978; Potts 1979; Gotto *et al.* 1981). Mangrove sediments in southern Florida fix nitrogen at rates of 0.4 to 3.2 g N/m²/yr (Kimball and Teas 1975; Zuberer and Silver 1978) and most of this fixation occurs in mangrove litter at specific stages of decomposition (Gotto *et al.* 1981; van der Valk and Attiwill 1984). This source of nitrogen can account for some of the nitrogen immobilization in leaf litter (Twilley 1988). Rates of nitrogen fixation in mangrove leaf litter are species-specific, depending on the chemical composition of the leaf. Thus, the contribution of this ecological process to the fertility of mangrove ecosystems may depend on the species composition and diversity of leaf litter, which differs among riverine, fringe, basin and dwarf zones. Mangrove forests also fix and store carbon in wood and organic-rich sediments. The total carbon sequestration in tropical coastal ecosystems is unknown, but it may contribute to the potentially significant carbon sinks in deltaic continental margins (Twilley *et al.* 1992).

6.1.11.7 Landscape and waterscape structure

Ecosystem consequences of impacts. River (and surface runoff) diversions that deprive tropical coastal deltas of fresh water and silt result in losses of mangrove species diversity and organic production, and alter the terrestrial and aquatic food webs that mangrove ecosystems support. Freshwater diversion of the Indus River to agriculture in Sind Province over the last several hundred years has reduced the once species-rich Indus River Delta to a sparse community dominated by *Avicennia marina*: it is also responsible for causing significant erosion of the seafront due to sediment starvation and the silting-in of the abandoned spill rivers (Snedaker 1984). A similar phenomenon has been observed in southwestern Bangladesh following natural changes in the distributary rivers of the Ganges, and the construction of the Farakka barrage which reduced the dry season flow of fresh water into the mangrove-dominated western Sundarbans. Freshwater starvation, both natural and human-induced, has had negative impacts on the rich vertebrate fauna (e.g. arboreal primates, deer, gaviel, large cats) of the Ganges

River Delta (Hendricks 1975; Das and Siddiqi 1985) and the Santa Marta lagoon (Ciénaga Grande) in Colombia (Botero 1990). Change in the species composition and distribution of mangroves and ecological types, such as fringe and basin forests, alters the quantity and quality of organic matter (DOM vs POC) contributed to adjacent estuaries (Twilley 1988). The effects of land-use changes at the landscape scale of tropical estuaries are also significant because of the dependence of marine organisms on estuarine conditions during the juvenile or adult stages of their life cycles (Yañez-Arancibia *et al.* 1994). The seasonal supply of organic matter by different primary producers, along with seasonal variations in physical constraints of organisms, such as temperature and salinity, provides a unique set of conditions for estuarine-dependent life cycles (Rojas *et al.* 1992). The fragmentation of mangrove-dominated landscapes may create the same types of problems for estuarine-dependent organisms that are associated with the fragmentation of upland forests, yet there has been little, if any, research on this topic.

6.1.11.8 Biotic linkages and species interactions

Ecosystem consequences of impacts. Organisms associated with mangrove forests may play many roles. In Malaysia, for example, bats that visit mangroves are also responsible for pollinating trees bearing the highly valued durian fruit. In Belize, wood-boring insects in mangroves are important to the formation of gaps and the specific architecture of mangrove trees (Feller 1993). Crabs are diverse in mangrove habitats (Jones 1984) with many functions such as contributing to plant zonation by differential seed predation (Smith 1987), to litter dynamics (leaf burrowing; Robertson 1986; Robertson and Daniel 1989; Twilley *et al.* 1993), and to nutrient dynamics (soil aeration from burrows; Smith *et al.* 1991) (see Box 6.1-2). Sponges, tunicates and a variety of other forms of epibionts on prop roots are equally diverse (Ruetzler and Feller 1988; Ellison and Farnsworth 1992) and may be sources of nutrition for higher level predators as well as influencing various processes in mangrove fringe forests. Finfish and macro-invertebrates may exert top-down control of community dynamics in fringe mangrove zones (Robertson and Duke 1990). Also, the diverse avifauna, mainly those that use mangroves for rookeries, control nutrient levels and foliage dynamics through nesting and the associated herbivory (cited above). These keystone guilds have disproportionate effects on the ecological processes of mangrove ecosystems, and illustrate the multiple roles of biodiversity in ecosystem functioning (Ray and McCormick 1992).

6.1.11.9 Microbial activities

Ecosystem consequences of impacts. The production and accumulation of mangrove peat occurs when root

Box 6.1-2: Crabs – a central ecosystem element in mangrove forests.

Crabs are extraordinarily abundant in many mangrove forests. They can make up nearly 80% of the macrofaunal biomass (Golley *et al.* 1962) and can reach densities of 80–90 per m² (Macintosh 1988). Two families of crabs are particularly associated with mangrove ecosystems (mangal) – the Grapsidae with 63 mangrove species, and the Ocypodidae with over 80 species (Jones 1984). These animals can have an enormous impact on ecosystem dynamics:

1. They can process as much as 70% of the leaf litter, and leaf processing by crabs in Australian mangrove systems can turn over litter at a rate in excess of 75 times that of microbial decay. The latter process predominates in New World mangrove ecosystems (Robertson and Daniel 1989).
2. Most of the mangal crabs feed on vascular plant material, including litter, but they also feed on green leaves, including seedlings. Seedling grazing, particularly by members of the genus *Sesarma*, may slow regeneration of these systems (Jones 1984) and crab seed predators greatly influence tree distribution in many mangrove forests. In the forests of Malaysia, Panama and Australia, grapsid crabs are the prime seed predators whereas in Florida snails occupy this functional role (Smith *et al.* 1989).
3. Mangal crabs not only fill every feeding niche but also occupy virtually all spatial dimensions of their habitat, showing species replacements horizontally from the sea inward and from the muddy substrate to the top of the canopy. Most, however, are burrowing forms (Jones 1984).
4. Crabs, through their burrowing activity modify the microtopography of the mangrove forest floor, not only influencing sediment texture distribution but also negatively affecting the abundance of surface algae (Warren and Underwood 1986).
5. Crabs of the mangrove forest positively influence tree productivity, and reproductive output, presumably by aerating the soil through burrowing activity and by decreasing sulphide levels. For this and many of the other activities described here Smith *et al.* (1991) have designated crabs as keystone species in mangrove systems.

production and mortality exceeds decomposition. The relative rate of below-ground production and decomposition in wetland plant communities depends on the presence of sulphate in seawater that is utilized by anaerobic sulphate reducers (Alongi 1988). In this regard, Snedaker (1993) has argued that in terms of climate change, changes in precipitation and freshwater run-off are the most important parameters (see also Pool *et al.* 1975) since each promotes mangrove [root] production and restricts root-peat decomposition by seawater-sulphate reducers. The succession of microbial processes also controls the transformation of nutritionally-poor mangrove leaf litter to a protein-rich food substrate which represents a significant contribution to the energy and nutrient budgets of tropical estuarine ecosystems (Heald 1971; Odum 1971; Fell and Master 1973).

6.1.11.10 Summary and relevance to human activities

A 1991 workshop on the status of mangroves of Southeast Asian coastlines (Sasekumar 1993) reported that the region has lost large areas of mangroves in the Philippines (80%), Thailand (50%), Indonesia (50%) and Malaysia (32%). This pattern is likely to continue as greater demands are placed on forest and fishery resources along with land use-changes along coastlines and in upland watersheds. The result will necessarily cause a change in the ecological characteristics of tropical estuaries. Many of the biodiversity components are sensitive to changes in physical conditions (salinity, turbidity), chemical balances (eutrophication) and biological changes (exotic species). The environmental quality of tropical estuaries relies on the unknown balance of the mosaic of ecosystem functioning, many components of which are still poorly understood. Major restoration projects in countries such as Colombia (Botero 1990), Pakistan (Qureshi 1990), Ecuador (Twilley *et al.* 1993) and Bangladesh (Siddiqi and Khan 1990) will challenge our ability to rebuild tropical estuaries and the dependent fisheries that have collapsed or been altered as a consequence of human interference.

References

- Alongi, D.M. 1988. Bacterial productivity and microbial biomass in tropical mangrove sediments. *Microbiology and Ecology* **15**: 59–79.
- Botero, L. 1990. Massive mangrove mortality on the Caribbean coast of Colombia. *Vida Silvestre Neotropical* **2**: 77–78.
- Boto, K.G. and Bunt, J.S. 1981. Tidal export of particulate organic matter from a Northern Australian mangrove system. *Estuarine, Coastal and Shelf Science* **13**: 247–255.
- Carlson, P.R., Yarbrow, L.A., Zimmermann, C.F. and Montgomery, J.R. 1983. Pore water chemistry of an overwash mangrove island. *Florida Scientist* **46**: 239–249.
- Chapman, V.J. 1976. *Mangrove Vegetation*. J. Cramer, Germany.

- Cintrón, G., Lugo, A.E., Pool, D.J. and Morris, G.** 1978. Mangroves of arid environments in Puerto Rico and adjacent islands. *Biotropica* **10**: 110–121.
- Clough, B.F., Boto, K.G. and Attiwill, P.M.** 1983. Mangroves and sewage: a re-evaluation. In: Teas, H.J. (ed.), *Biology and Ecology of Mangroves*. Vol. 8. 188. Dr W. Junk Publishers, The Hague.
- Das, S. and Siddiqi, N.A.** 1985. *The Mangroves and Mangrove Forests of Bangladesh*. Mangrove Silviculture Division Bulletin No. 2. 142. Bangladesh Forest Research Institute, Chittagong.
- Dost, H. (ed.)** 1973. *Acid Sulfate Soils*, Vols. I and II. International Institute for Land Reclamation and Improvement, Publication No. 575. Wageningen, The Netherlands.
- Ellison, A.M. and Farnsworth, E.J.** 1992. The ecology of Belizean mangrove-root fouling communities: patterns of epibiont distribution and abundance, and effects on root growth. *Hydrobiologia* **247**: 871–98.
- Fell, J.W. and Master, I.M.** 1973. Fungi associated with the degradation of mangrove (*Rhizophora mangle* L.) leaves in south Florida. In: Stevenson, L.H. and Colwell, R.R. (eds), *Estuarine Microbial Ecology*. 455–465. University of South Carolina Press, Columbia, SC.
- Feller, I.C.** 1993. *Effects of nutrient enrichment on growth and herbivory of dwarf red mangrove*. Ph.D. dissertation, Georgetown University, Washington, DC.
- Gilmore, R.G. and Snedaker, S.C.** 1993. Mangrove forests. In: Martin, W.H., Boyce, S. and Echternacht, K. (eds), *Biodiversity of the Southeastern United States: Lowland terrestrial communities*. 165–198. John Wiley, New York.
- Golley, F., Odum, H.T. and Wilson, R.F.** 1962. The structure and metabolism of a Puerto Rican red mangrove forest in May. *Ecology* **43**: 9–18.
- Gotto, J.W., Tabita, F.R. and Baalen, C.V.** 1981. Nitrogen fixation in intertidal environments of the Texas gulf coast. *Estuarine, Coastal and Shelf Science* **12**: 231–235.
- Gotto, J.W. and Taylor, B.F.** 1976. N_2 fixation associated with decaying leaves of the red mangrove (*Rhizophora mangle*). *Applied and Environmental Microbiology* **31**: 781–783.
- Heald, E.J.** 1971. The production of organic detritus in a south Florida estuary. *University Miami Sea Grant Technical Bulletin No. 6*.
- Hendricks, H.** 1975. The status of the tiger *Panthera tigris* (Linne 1758) in the Sundarbans mangrove forest (Bay of Bengal). *Saigetierkundliche Mitteilungen*. **23** (3):161–199.
- Hicks, D.B. and Burns, L.A.** 1975. Mangrove metabolic response to alterations of natural freshwater drainage to southwestern Florida estuaries. In: Walsh, G., Snedaker, S. and Teas, H. (eds), *Proceedings of the International Symposium on the Biology and Management of Mangroves*. 238–255. Institute of Food and Agricultural Sciences, University of Florida, Gainesville.
- Jones, D.A.** 1984. Crabs of the mangal ecosystem. In: Por, F.D. and Dor, I. (eds), *Hydrobiology of the Mangal*. 89–110. Dr W. Junk Publishers, The Hague.
- Kimball, M.C. and Teas, H.J.** 1975. Nitrogen fixation in mangrove areas of southern Florida. In: Walsh, G., Snedaker, S. and Teas, H. (eds), *Proceedings of the International Symposium on the Biology and Management of Mangroves*. 654–660. Institute of Food and Agricultural Sciences, University of Florida, Gainesville.
- Lugo, A.E. and Snedaker, S.C.** 1974. The ecology of mangroves. *Annual Review of Ecology and Systematics* **5**: 39–64.
- Lugo, A.E., Brown, S. and Brinson, M.M.** 1990. Concepts in wetland ecology. In: Lugo, A.E., Brinson, M. and Brown, S. (eds), *Ecosystems of the World 15: Forested Wetlands*. 53–85. Elsevier, Amsterdam.
- Lynch, J.C., Meriwether, J.R., McKee, B.A., Vera-Herrera, F. and Twilley, R.R.** 1989. Recent accretion in mangrove ecosystems based on ^{137}Cs and ^{210}Pb . *Estuaries* **12**: 284–299.
- Macintosh, D.J.** 1988. The ecology and physiology of decapods of mangrove swamps. *Symposia of the Zoological Society of London* **59**: 315–341.
- Macnae, W.** 1968. A general account of the fauna and flora of mangrove swamps and forests in the Indo-West-Pacific region. *Advances in Marine Biology* **6**: 73–270.
- McKee, K.L., Mendelssohn, I.A. and Hester, M.W.** 1988. Reexamination of pore water sulfide concentrations and redox potentials near the aerial roots of *Rhizophora mangle* and *Avicennia germinans*. *American Journal of Botany* **75**: 1352–1359.
- Maul, G.A. and Martin, D.M.** 1993. Sea level rise at Key West, Florida, 1846–1992: America's longest instrument record? *Geophysical Research Letters* **20** (18): 1955–1958.
- Moorman, F.R. and Pons, L.J.** 1975. Characteristics of mangrove soils in relations to their agricultural land use and potential. In: Walsh, G., Snedaker, S. and Teas, H. (eds), *Proceedings of the International Symposium on the Biology and Management of Mangroves*. 529–547. Institute of Food and Agricultural Sciences, University of Florida, Gainesville.
- Nedwell, D.B.** 1975. Inorganic nitrogen metabolism in an eutrophicated tropical mangrove estuary. *Water Research* **9**: 221–231.
- Nickerson, N.H. and Thibodeau, F.R.** 1985. Association between pore water sulfide concentrations and the distribution of mangroves. *Biogeochemistry* **1**: 183–192.
- Nixon, S.W., Furnas, B.N., Lee, V., Marshall, N., Jin-Eong, O., Chee-Hoong, W., Wooi-Khoon, G. and Sasekumar, A.** 1984. *The role of mangroves in the carbon and nutrient dynamics of Malaysia estuaries*, 534–544. Proceedings Symposium on Mangrove Environments – Research and Management.
- Odum, W.E.** 1971. Pathways of energy flow in a south Florida estuary. *University of Miami Sea Grant Bulletin No. 7*.
- Odum, W.E. and Heald, E.J.** 1972. Trophic analysis of an estuarine mangrove community. *Bulletin of Marine Science* **22**: 671–738.
- Odum, W.E., McIvor, C.C. and Smith, T.J. III.** 1982. *The Ecology of the Mangroves of South Florida: A community profile*. Fish and Wildlife Service/Office of Biological Services, Washington, DC. FWS/OBS-81/24.
- Onuf, C., Teal, J. and Valiela, I.** 1977. The interactions of nutrients, plant growth, and herbivory in a mangrove ecosystem. *Ecology* **58**: 514–526.
- Pannier, F.** 1979. Mangrove impacted by human-induced disturbance: A case study of the Orinoco Delta mangrove ecosystem. *Environmental Management* **3**: 205–216.

- Peterson, P.J., Burton, M.A.S., Gregson, M., Nye, S.M. and Porter, E.K.** 1979. Accumulation of tin by mangrove species in west Malaysia. *Science of the Total Environment* **11**: 213–221.
- Ponnamperuma, F.N.** 1984. Mangrove swamps in south and southeast Asia as potential rice lands. In: Soepadmo, E., Rao, A.N. and McIntosh, D.J. (eds), *Proceedings Asian Mangrove Symposium, 25–29 August 1980, Kuala Lumpur, Malaysia*. 672–683. Percetakan Ardyas Sdn. Bhd., Kuala Lumpur.
- Pool, D.J., Lugo, A.E. and Snedaker, S.C.** 1975. Litter production in mangrove forests of southern Florida and Puerto Rico. In: Walsh, G., Snedaker, S. and Teas, H. (eds), *Proceedings of the International Symposium on the Biology and Management of Mangroves*. 213–237. Institute of Food and Agricultural Sciences, University of Florida, Gainesville, Florida.
- Potts, M.** 1979. Nitrogen fixation (acetylene reduction) associated with communities of heterocystous and non-heterocystous blue-green algae on mangrove forests of Sinai. *Oecologia* **39**: 359–373.
- Prakash, A.** 1971. Terrigenous organic matter and coastal phytoplankton fertility. *Proceedings of an International Conference on the Fertility of the Sea, Sao Paulo, Brazil*. Gordon and Breach Science Publishers.
- Prakash, A., Jensen, A. and Rashid, M.A.** 1973. Humic substances and aquatic productivity. In: Povoledo, D. and Goltzman, H.L. (eds), *Humic substances: Their structure and function in the biosphere*.
- Qureshi, M.T.** 1990. Experimental plantation for rehabilitation of mangrove forests in Pakistan. In: Field, C.B. (ed.), *Mangrove Ecosystems Occasional Papers No. 4*. COMAR, Unesco, Paris.
- Ray, G.C. and McCormick-Ray, M.G.** 1992. Functional coastal-marine biodiversity. *Transactions 57th North American Wildlife and Natural Research Conference*. 384–397.
- Rivera-Monroy, V.H., Day, J.W., Twilley, R.R., Vera-Herrera, F. and Coronado-Molina, C.** 1995. Flux of nitrogen and sediment in a fringe mangrove forest in Terminos Lagoon, Mexico. *Estuarine, Coastal and Shelf Science* **40**: 139–160.
- Robertson, A.I.** 1986. Leaf-burying crabs: their influence on energy flow and export from mixed mangrove forests (*Rhizophora* spp.) in northeastern Australia. *Journal of Experimental Marine Biology and Ecology* **102**: 237–248.
- Robertson, A.I. and Daniel, P.A.** 1989. The influence of crabs on litter processing in high intertidal mangrove forests in tropical Australia. *Oecologia* **78**: 191–198.
- Robertson, A.I. and Duke, N.C.** 1990. Mangrove fish-communities in tropical Queensland, Australia: spatial and temporal patterns in densities, biomass and community structure. *Marine Biology* **104**: 369–379.
- Rojas Galaviz, J.L., Yañez-Arancibia, A., Day, J.W. and Vera-Herrera, F.** 1992. Estuary primary producers: Laguna de Terminos — a case study. In: Seeliger, U. (ed.), *Coastal Plant Communities of Latin America*. 141–154. Academic Press, New York.
- Ruetzler, K. and Feller, C.** 1988. Mangrove swamp communities. *Oceanus* **30**: 16–24.
- Saenger, P. and Snedaker, S.C.** 1993. Pantropical trends in mangrove above-ground biomass and annual litterfall. *Oecologia* **96**: 293–299.
- Saenger, P., Hegerl, E.J. and Davie, J.D.S.** 1983. Global Status of Mangrove Ecosystems. *The Environmentalist* **3**, Supplement 3.
- Sasekumar, A.** 1993. Asean-Australia marine science project: Living coastal resources. *Proceedings of a workshop on mangrove fisheries and connections, 26–30, August 1991*. Australian International Development Assistance Bureau (AIDAB).
- Sasekumar, A., Chong, V.C., Leh, M.U. and D'Cruz, R.** (spelling) 1992. Mangroves as habitat for fish and prawns. In: Jaccarini, V. and Martens, E. (eds), *The Ecology of Mangroves and Related Habitats*. Development in Hydrobiology 80. 195–207. Kluwer Academic Publishers, Boston.
- Scoffin, T.P.** 1970. The trapping and binding of subtidal carbonate sediments by marine vegetation in Bimini Lagoon, Bahamas. *Journal of Sedimentary Petrology* **40**: 249–273.
- Siddiqi, N.A. and Khan, M.A.S.** 1990. Growth performance of mangrove trees along the coastal belt of Bangladesh. In: Field, C.D. (ed.), *Mangrove Ecosystems Occasional Papers No. 8*. 4–14. COMAR, Unesco, Paris.
- Smith, T.J., III.** 1987. Seed predation in relation to tree dominance and distribution in mangrove forests. *Ecology* **68**: 266–273.
- Smith, T.J., III, Chan, H.T., McIvor, C.C. and Robblee, M.B.** 1989. Comparison of seed predation in tropical, tidal forests from three continents. *Ecology* **70**: 146–151.
- Smith, T.J., III, Boto, K.G., Frusher, S.D. and Giddins, R.L.** 1991. Keystone species and mangrove forest dynamics: the influence of burrowing by crabs on soil nutrient status and forest productivity. *Estuarine, Coastal and Shelf Science* **33**: 419–432.
- Snedaker, S.C.** 1984a. The mangroves of Asia and Oceania: status and research planning. In: Soepadmo, E., Rao, A.N. and McIntosh, D.J. (eds), *Proceedings, Asian Mangrove Symposium, 25–29 August 1980, Kuala Lumpur, Malaysia*. 5–15. Percetakan Ardyas Sdn. Bhd., Kuala Lumpur.
- Snedaker, S.C.** 1984b. Mangroves: A summary of knowledge with emphasis on Pakistan. In: Haq, B.U. and Milliman, J.D. (eds.) *Marine Geology and Oceanography of Arabian Sea and Coastal Pakistan*. 255–262. Van Nostrand Reinhold Company, New York.
- Snedaker, S.C.** 1986. Traditional uses of South American mangrove resources and the socio-economic effect of ecosystem changes. In: Kunstadter, P., Bird, E.C.F. and Sabhasri, S. (eds), *Proceedings, Workshop on Man in the Mangroves*. 104–112. United Nations University, Tokyo.
- Snedaker, S.C.** 1989. Overview of ecology of mangroves and information needs for Florida Bay. *Bulletin of Marine Science* **44** (1): 341–347.
- Snedaker, S.C.** 1993. Impact on mangroves. In: Maul, G.A. (ed.), *Climate Change in the Intra-Americas Sea*. 282–305. Edward Arnold, Kent, UK.
- Snedaker, S.C., Meeder, J.F., Ross, M.S. and Ford, R.G.** 1994. Discussion of Joanna C. Ellison and David R. Stoddart, Mangrove ecosystem collapse during predicted sea-level rise: Holocene analogues and implications. *Journal of Coastal Research* **10** (2): 497–498.
- Steyer, G.** 1988. *Litter dynamics and nitrogen retranslocation in three types of mangrove forests in Rookery Bay, Florida*. M.S. Degree, University of Southwestern Louisiana, Lafayette.
- Thayer, G.W., Colby, D.R. and Hettler, W.F. Jr.** 1987. Utilization

- of red mangrove prop root habitat by fishes in south Florida. *Marine Ecology Progress Series* **35**: 25–38.
- Thom, B.G.** 1982. Mangrove ecology: a geomorphological perspective. In: Clough, B.F. (ed.), *Mangrove Ecosystems in Australia*. 3–17. Australian National University Press, Canberra.
- Tomlinson, P.B.** 1986. *The Botany of Mangroves*. Cambridge University Press, New York.
- Twilley, R.R.** 1985. The exchange of organic carbon in basin mangrove forests in a southwest Florida estuary. *Estuarine, Coastal and Shelf Science* **20**: 543–557.
- Twilley, R.R., Lugo, A.E. and Patterson-Zucca, C.** 1986. Production, standing crop, and decomposition of litter in basin mangrove forests in southwest Florida. *Ecology* **67**: 670–683.
- Twilley, R.R.** 1988. Coupling of mangroves to the productivity of estuarine and coastal waters. In: Jansson, B.O. (ed.), *Coastal-Offshore Ecosystem Interactions*. 155–180. Springer-Verlag, Berlin.
- Twilley, R.R., Chen, R.H. and Hargis, T.** 1992. Carbon sinks in mangroves and their implications to carbon budget of tropical coastal ecosystems. *Water, Air and Soil Pollution* **64**: 265–288.
- Twilley, R.R., Boderó, A. and Robadue, D.** 1993. Mangrove ecosystem biodiversity and conservation: case study of mangrove resources in Ecuador. In: Potter, C.S., Cohen, J.I. and Janczewski, D. (eds), *Perspectives on biodiversity: Case studies of genetic resource conservation and development*. 105–127. AAAS Press, Washington, DC.
- van der Valk, A.G. and Attiwill, P.M.** 1984. Acetylene reduction in an *Avicennia marina* community in southern Australia. *Australian Journal of Botany* **32**: 157–164.
- Walsh, G.E.** 1967. An ecological study of a Hawaiian mangrove swamp. In: Lauff, G.H. (ed.) *Estuaries*. 420–431. AAAS Press, Washington, DC.
- Warren, J. H., and Underwood, A.J.** 1986. Effects of burrowing crabs on the topography of mangrove swamps in New South Wales. *Journal of Experimental Marine Biology and Ecology* **102**: 223–235.
- Watson, J.** 1928. Mangrove forests of the Malay Peninsula. *Malayan Forest Records* 6. Fraser and Neave, Ltd, Singapore.
- Yañez-Arancibia, A., Sanchez-Gil, P. and Lara-Dominguez, A.L.** 1994. Functional groups, seasonality, and biodiversity in Terminos Lagoon a tropical estuary, Mexico. In: *Proceedings, International Workshop Ecosystem Function of Marine Biodiversity in Estuaries, Lagoons and Near-shore Coastal Ecosystems*. IUBS Journal Biology International (in press).
- Yañez-Arancibia, A., Lara-Dominguez, A.L., Rojas Galaviz, J.L., Sanchez-Gil, P., Day, J.W. and Madden, C.J.** 1988. Seasonal biomass and diversity of estuarine fishes coupled with tropical habitat heterogeneity (southern Gulf of Mexico). *Journal of Fish Biology* **33** (Suppl. A): 191–200.
- Yañez-Arancibia, A., Lara-Dominguez, A.L. and Day, J.W.** 1993. Interactions between mangrove and seagrass habitats mediated by estuarine nekton assemblages: coupling of primary and secondary production. *Hydrobiologia* **264**: 1–12.
- Zuberer, D.A. and Silver, W.S.** 1978. Biological nitrogen fixation (acetylene reduction) associated with Florida mangroves. *Applied and Environmental Microbiology* **35**: 567–575.

6.1.12 Open oceans

6.1.12.1 Introduction

Open-ocean systems include all environments on Earth minus the landmasses and the continental shelf benthos. These systems comprise more than 70% of the Earth's surface, and over 90% of its habitable volume. Open-ocean ecosystems are unique in being almost completely devoid of higher plants, and depauperate in other forms of biogenic structure which is limited to drift-weed, terrigenous flotsam (especially wood) and the surfaces of other, usually motile living creatures. Primary production is dominated by phytoplankton, and averages one-fifth that of the mean terrestrial ecosystem (Valiela 1984), although turnover rates of oceanic plankton may be more than one order of magnitude greater than those of terrestrial vascular plants. Biomes within the open ocean are defined by the intersection of four factors: energy source for primary productivity, physical structure, depth/light attenuation, and latitude (Figure 6.1-10). Approximately 15% of described species are marine (Barnes 1989; May 1992). The diversity of open-ocean taxa is poorly known for both high and low taxonomic levels (Grassle and Maciolek 1992; Fuhrman and Davis 1994). The most conservative estimate for the total number of species in the open ocean – half a million – is still at least twice the number of species thus far described (May 1992), and estimates range up to 10 million (Grassle and Maciolek 1992; Poore *et al.* 1994; but see May 1992; Briggs 1994). Global phyletic diversity is dominated by oceanic taxa: 32 out of the 33 phyla are marine, and 15 of these phyla are marine endemics (Margulis and Schwartz 1988; Ray and Grassle 1991; Angel 1993). The variety of major functional groups in the marine environment also overshadows that found in other biomes. In particular, we must emphasize the significance of biodiversity within the microbial groups at the fundamental biochemical level. These are arguably the most unfamiliar, fundamentally 'different' life-forms in recent discovery (Fuhrman *et al.* 1992; Fuhrman and Davis 1994). And we have barely scratched the surface of the sediments (Grassle and Maciolek 1992; Poore and Wilson 1993; Poore *et al.* 1994). Species diversity is generally higher at low latitudes, with three peaks, dependent upon taxonomic group: photic zone, benthic environments at 2000 to 3000 m depth (mostly on the continental slope), and the abyssal plain (Vinogradova 1979b; Grassle 1991; Alongi 1992; Grassle and Maciolek 1992; Angel 1993; Poore and Wilson 1993; Brey *et al.* 1994). Life in the epipelagic zone is dominated by generalists with a dynamic metapopulation structure (Steele 1985, 1991). The deep benthos harbours a much higher diversity of species (Grassle and Maciolek 1992) and a higher proportion of local or regional endemics. Relationships among species in highly diverse deep-sea communities have not been well studied, and rates of dispersal of deep-sea species among

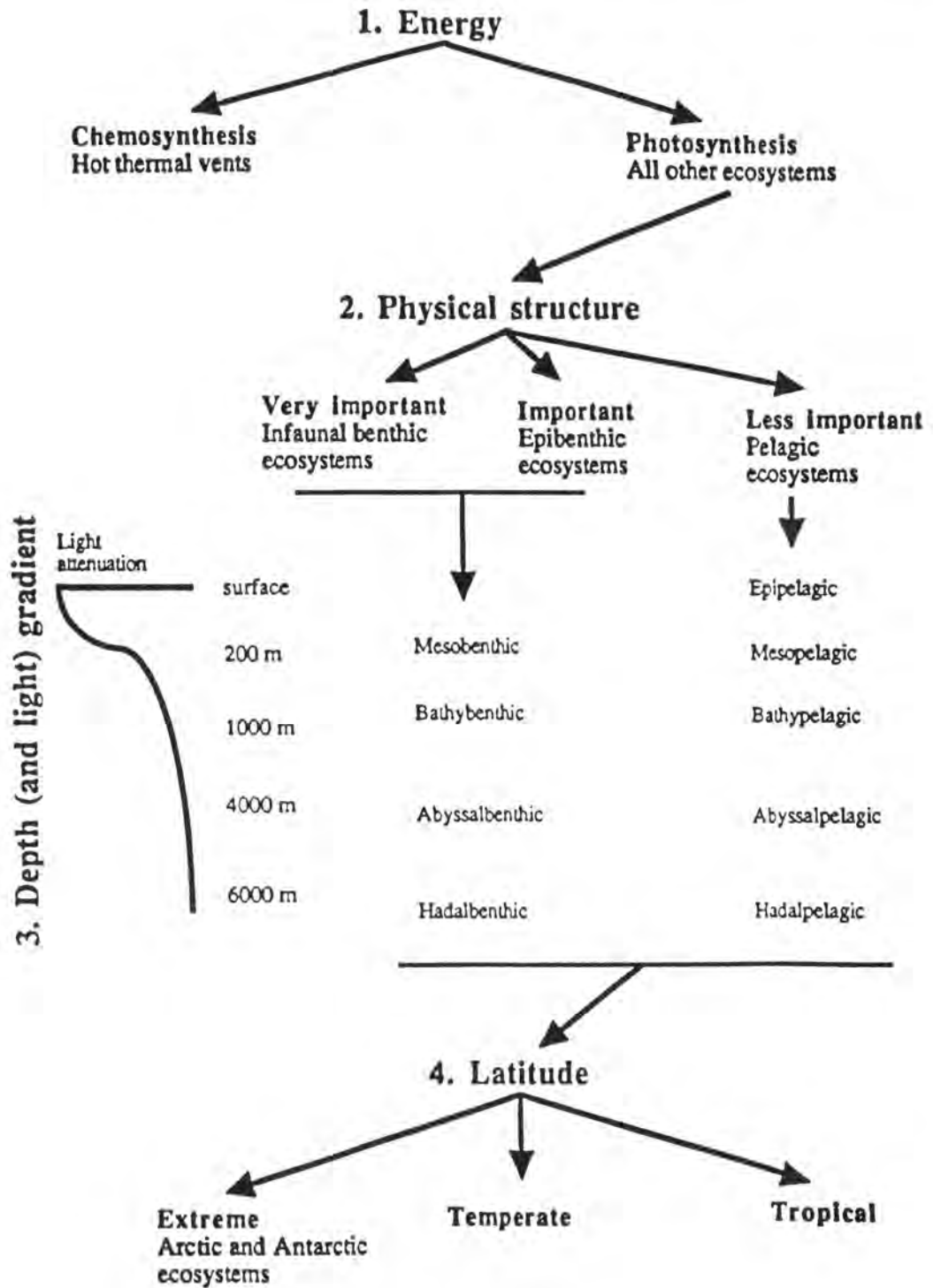

Figure 6.1-10: A heuristic view of the structure of open-ocean ecosystems.

geographic regions are also poorly known. There is an extremely important and dynamic link between the open ocean and coastal pelagic biomes due to the high prevalence of the larvae of many coastal marine organisms dependent upon pelagic dispersal.

6.1.12.2 Threats to the oceans

Increases in ultraviolet radiation may directly affect both phytoplankton and zooplankton in open ocean pelagic

areas. A steady increase in temperature amounting to 0.32 °C over the last 35 years has been observed at abyssal depths (Parrilla *et al.* 1994). Pollutants have been observed on the deep-sea floor in all areas where they have been looked for, and increases from atmospheric sources (LaFlemme and Hites 1978; Takada *et al.* 1994) are inevitable. The greatest flux of pollutants to the deep sea is likely to occur on continental margins where sediments from land sources accumulate. Human impacts on biodiversity in the open-

ocean biomes are summarized in Table 6.1-1. The biodiversity impact of changes in atmospheric gases (i.e. acid rain, global warming and ozone depletion processes) is uncertain, but likely to be significant. The reason for the uncertainty is partly that our knowledge of the biodiversity of the smallest epipelagic organisms is extremely poor. The likelihood of there being direct effects of these processes on the biodiversity of the megafauna is unknown. Fishery collapses in every sector of the world ocean point to a clear human impact on the diversity of top-level carnivores and herbivores in the epipelagic zone (Brown 1993; Norse 1993; Paine 1993; Anon. 1994), and major changes in community structure of oceanic ecosystems following the over-exploitation of dominant vertebrates and invertebrates have been observed in the Antarctic (Laws 1985), North Atlantic (Beddington and May 1982; Weber 1986), and Pacific Oceans (MacCall 1986; Cox 1993). Another human impact is the potential for acoustic noise to disrupt normal social and migratory behaviour of marine mammals and large teleosts.

There is insufficient baseline information about the distribution and abundance of deep-sea species to

determine whether or not major changes are occurring in deep-sea ecosystems (Grassle *et al.* 1990). The number of quantitative samples from the deep sea is minuscule, and increases in pollutants are not monitored in any area of the deep ocean. Furthermore, few scientists are capable of identifying species within even the better-known deep-sea taxa. Present information is insufficient for determining whether introductions or extinctions are taking place in either pelagic or benthic assemblages.

6.1.12.3 Productive capacity, biomass, decomposition and nutrient cycling

Human impacts on biodiversity. Most of the impacts mentioned above should be included here. There is evidence for major intra- and interspecific shifts in life history profiles of the dominant taxa in the open ocean due to over-extraction in fisheries and as by-catch (Nelson and Soule 1987; Rijnsdorp 1993; Stokes *et al.* 1993). Intraspecifically, there is evidence for response to overharvesting of sexually mature individuals, manifested as a reduction in age at first maturity and of maximum adult size. Fisheries have systematically reduced the

Table 6.1-1: Human impacts on the biodiversity of the open-ocean biomass.

Anthropogenic impacts ¹	Coastal ²		Open ocean	
	Benthic and pelagic	Epipelagic ³	Mesopelagic ³	Benthic
Land-based activities				
Air pollution				
Change in atmospheric gases (e.g. CO ₂ , methane, acid rain)	**** ⁴	***	indirect	indirect
Increase UV radiation	***	***	indirect	indirect
Global warming	***	***	indirect	indirect
Land pollution				
Siltation	***	*	indirect	**
Accidental waste disposal (e.g. flotsam)	***	**	*	
Waste disposal	***	**	**	
Ocean-based activities				
Inputs				
Introductions	***	***	?	
Accidental waste disposal (e.g. oil spills)	***	***	***	
Waste disposal	***	**	***	
Outputs				
Resource extraction (harvesting and mining)	***	***	**	***

1. References to the impacts are found in text.
2. Coastal systems extend to the limits of the continental shelf.
3. Epipelagic systems occur above 200 m; mesopelagic systems occur below 200 m.
4. Ranking of impact: ***expected serious impact; **expected moderate impact; *expected mild impact; indirect/direct effects may cascade impacts down down to other ocean systems,

abundance of all species of large organisms in the epipelagic zone.

Ecosystem consequences of impacts. Human impacts on productive capacity in the open ocean are predominantly nutrient-loading effects. However, alterations to biodiversity could have important secondary impacts on productive capacity or its spatial distribution. Shifts in the abundances of non-cetacean planktivores in Antarctic waters are probably a consequence of this impact (Valiela 1984). Elimination of large carnivores and herbivores should also have profound effects on the efficiency and form of open-ocean food webs. The effects of removal of large epipelagic species should cascade down to the rest of the water column, as these are significant agents of nutrient transport, both as living individuals undergoing frequent vertical migration, and as deadfall (Smith *et al.* 1989; Pfannkuche and Lochte 1993). Recent simulations of oceanic systems suggest that the effects of altering species composition are very difficult to predict, may be highly counterintuitive, and are dependent on relevant temporal and spatial scales (Yodzis 1988, 1994).

6.1.12.4 Sediment structure and nutrient pools

Human impacts on biodiversity. Removal of manganese nodules eliminates one important type of surface structure exploited by a distinct assemblage of epifauna (Thiel 1982). Reduction in epipelagic megafauna has compromised deadfall, which serves both as a source of nutrients and as a potential stepping-stone for dispersal of rift-associated organisms (Smith *et al.* 1989).

Ecosystem consequences of impacts. It is not known if human activity has yet had any significant impact on the biodiversity that affects sediment structure of infaunal dynamics in the deep sea. The possibility for impact exists through alteration of physical structure, chemical or radiological contamination, and alteration of nutrient inputs from surface waters. As for impact specifically emergent from loss of deep ocean soft sediment species, nothing can be surmised at this time. A cautionary note is in order, however. It is apparent that the diversity of microbial activity in the deep benthos is not only a key attribute of the system, but also of enormous potential value to humanity. The possibility of losing specific taxa or strains as a result of direct human alteration of sections of sea bottom should be taken seriously.

6.1.12.5 Water distribution, balance and quality

Human impacts on biodiversity. Principal concerns for the open ocean include toxic inputs (oil spills, ocean dumping of PCBs, heavy metals, pseudohormones, atmospheric inputs of toxic organic compounds), discharges, and alteration of nutrient regimes (Tanabe *et al.* 1984; Tanabe 1988; Cox, 1993). Although these are currently thought of as principally coastal phenomena

(GESAMP 1990), this is almost certainly a product of ignorance rather than an accurate reflection of fact. Even the most distant oceanic ecosystems have traces of human activities (Flegal *et al.* 1993).

Ecosystem consequences of impacts. The pervasive nature of chemical pollution suggests that open-ocean organisms and ecosystems are likely to experience levels of disruption at least as great as those observed in coastal systems. Existing data suggest, however, that substantially longer time scales are likely to be needed for recovery from such impacts. The biomagnification of toxins up through the food web could lead to significant changes in community structure if the larger apex organisms are negatively affected (Tanabe *et al.* 1984; Tanabe 1988; Addison 1989).

6.1.12.6 Feedbacks to atmospheric properties

Human impacts on biodiversity. Human impact on the biodiversity that influences atmospheric processes is difficult to ascertain because of our ignorance of which biogenic products are most important in regulating climate. Dimethyl sulphide, carbonyl sulphate and bromoform are gases that potentially can have an important impact on cloud formation or the greenhouse effect. All three gases are known to be produced by marine organisms (primarily the diatoms and non-calcifying coccolithophorids) (Charlson *et al.* 1987; Turner *et al.* 1988; Iverson *et al.* 1989; Kiene and Bates 1990). The relative abundance of these species and their distributions are poorly known, although anthropogenic activities (see Table 6.1-1 and above) will most likely alter their current status, because different taxa respond differently to eutrophication, chemical pollution, UV radiation and species introduction. Recent studies have suggested that oceanic phytoplankton may act as a carbon sink for globally increasing levels of carbon dioxide.

Ecosystem consequences of impacts. To the extent that the relative abundances of plankton producing carbonyl sulphate and dimethyl sulphide are impacted by human activities in the open ocean, change in at least the regional climate is likely to occur (Fuhrman and Capone 1991). This is a largely unexplored yet important field with possible wide-ranging ramifications given the potential ability of climate models to predict effects of global weather.

6.1.12.7 Landscape and waterscape structure

Human impacts on biodiversity. Patch dynamics are very important to the way open-ocean ecosystems function. Pelagic systems are heterogeneous at all scales (Steele 1985; Colebrook 1991; Kawasaki 1991); hydrodynamic structure predominates and is provided to oceanic systems principally by currents and waves from small-scale eddies, through warm-core rings of water moving across ocean basins, to trans-oceanic currents. Open-ocean biomes are not dominated by a biogenic physical structure, such as

angiosperms, that humans can alter. The extent of large floating mats of raftweed, such as *Sargassum*, may, however, have declined. Much of the benthic environment is very distant to most human activities, although mining and fish trawling in benthic habitats may differentially impact significant members of the benthic community (Watling and Langton 1994).

Ecosystem consequences of impacts. Physical structure is important to the functioning of the deep benthos, primarily because of the tunnelling activities and mixing of the sediments by specific biota, which alter biogeochemical cycling of nutrients and oxygen availability. Recent interest in mining and harvesting the deep sea will probably impact the structure of the seascape, although this effect has not been quantified.

6.1.12.8 Biotic linkages and species interactions

Human impacts on biodiversity. The decline of many marine fish stocks and the complete closure of many formerly productive marine fisheries signifies an important depletion in many top-level predators and herbivores in the open ocean. As one species becomes depleted, another is exploited until it, too, is scarce. Many of the formerly common fishes and marine mammals are now already rare, and two attributes of ocean systems may make them especially vulnerable. The first is pelagic recruitment. These species are subject to highly stochastic determinants and when disrupted sufficiently at large scales the outcome is highly unpredictable. Second, these systems are ordinarily very resilient so that a shift in the dominant species may be extremely difficult to reverse. This resilience is predicted from the prevalence of pelagic larval dispersal plus the likelihood that many adults can prey on the juveniles of many other species. Another important human impact comes from the introduction of marine species into novel environments via tanker ballast water, etc. (Carlton 1993; Carlton and Geller 1993; see 6.1.12.3). It is often assumed that open-ocean taxa are more cosmopolitan in distribution and that open-ocean systems should be less prone to the introduction of novel organisms, but this has yet to be tested.

Ecosystem consequences of impacts. Many of the organisms exploited by humans play pivotal roles in the food web, and because many of the top-level species are being exploited simultaneously, substantial changes in the composition of oceanic communities can be expected. The change in Antarctic communities due to whale harvesting, and the shift from a community dominated by bony fish to one dominated by cartilaginous fish in the Northwestern Atlantic are two examples of the transformation of open-ocean communities (Laws 1985; Weber 1986). Introduction of new organisms into an environment may result in the exposure of key organisms to novel diseases or predators (Carlton 1993; Carlton and Geller 1993), which can result

in dramatic shifts in community structure. These effects have been noticed most dramatically in coastal and coral reef systems. The lack of quantitative sampling over any time period in the open ocean precludes any firm conclusion on whether the effects of novel disease or predation are more or less important in oceanic systems. The recent mortalities of marine mammals along the Atlantic coastlines from viral epidemics (Visser *et al.* 1993) may reflect only the most visible outcome of some of the changes currently occurring in ocean ecosystems.

6.1.12.9 Microbial activities

Human impacts on biodiversity. The microbial world of both the pelagic and the benthic open ocean are poorly understood, in part because only now are molecular techniques revealing surprising information about the relatively high abundances of certain organisms (e.g. Archaea in surface waters) (Bergh *et al.* 1989; Giovannoni *et al.* 1990; Bolliger *et al.* 1991; Fuhrman *et al.* 1992, 1993). Its importance cannot be denied: the heterotrophic microbial loop accounts for over 70% of the total carbon and nitrogen in the euphotic zone (Fuhrman and Capone 1991). Chemical pollution could have a serious effect on microbial diversity by differentially impacting particular species.

Ecosystem consequences of impacts. Very little is known about the consequences of changing microbial communities because of the difficulty of identifying micro-organisms, and the dearth of knowledge about their ecology. Circumstantial evidence suggests that microbial processes such as degradation and the utilization of specific nutrients are most efficiently performed by specific microbes. Changes in the abundance of these organisms would thus alter the microbial loop. A high diversity of bacteria may be important in stabilizing microbial loops, given the large numbers of parasitic viruses found in open oceans (Bergh *et al.* 1989).

6.1.12.10 Summary and relevance to human activities

Although a great deal is known in principle about open-ocean biodiversity and potential human impacts, the empirical database is small, and our capacity to monitor and trace cause-effect relationships extremely limited. Many oceanic taxa are generalists, with a well-distributed population structure characterized by boom-and-bust cycles (Steele 1991). This may suggest that for many species, removal would have little overall effect on oceanic ecosystem processes; however, humans have simultaneously reduced the abundance of many organisms in higher trophic levels. This is predicted to cause a substantial change in the community structure and productivity of oceanic systems. Novel diseases and predators that will substantially change the functioning of certain oceanic ecosystems are likely to occur at some point

if the redistribution and introduction of organisms by humans continues. Changes in planktonic communities because of greenhouse effects, increased UV radiation, or food-web structural alterations may have large effects on our global climate because several of the climate-modulating gases are produced by relatively few plankton taxa. That we have overlooked open-ocean biodiversity in the past is understandable. That we should continue to do so is indefensible.

References

- Addison, R.F.** 1989. Organochlorines and marine mammal reproduction. *Canadian Journal of Fisheries and Aquatic Science* **46**: 360–368.
- Alongi, D.M.** 1992. Bathymetric patterns of deep-sea benthic communities from bathyal to abyssal depths in the western South Pacific (Solomon and Coral Seas). *Deep Sea Research: A Oceanographic Research Papers* **39**: 549–565.
- Angel, M.V.** 1993. Biodiversity of the pelagic ocean. *Conservation Biology* **7**: 760–772.
- Anon.** 1994. The tragedy of the oceans. *The Economist*, 19 March 1994.
- Barnes, R.D.** 1989. Diversity of organisms: How much do we know? *Amer. Zool.*, **29**: 1075–1084.
- Beddington, J.R.** and May, R.M. 1982. The harvesting of interacting species in a natural ecosystem. *Scientific American* **247** (5): 62–69.
- Bergh, Ø., Børsheim, K.Y., Bratbak, G.** and Heldal, M. 1989. High abundance of viruses in aquatic environments. *Nature* **340**: 462–468.
- Bolliger, R., Hanselmann, K.W.** and Bachofen, R. 1991. Microbial potential in deep-sea sediments. *Experientia* **47**: 517–523.
- Briggs, J.C.** 1994. Species diversity: land and sea compared. *Systematic Biology* **43**: 130–135.
- Brey, T., Klages, M., Dahn, C., Gomey, M., Cull, J., Hain, S., Stillner, M.** and Arntz, W.F. 1994. Antarctic benthic diversity. *Nature* **368**: 297.
- Brown, L.R.** 1993. A new era unfolds. In: Starke, L. (ed.), *State of the World. A Worldwatch Institute report on progress toward a sustainable society*. W.W. Norton and Co., New York.
- Carlton, J.T.** and Geller, J.B. 1993. Ecological roulette: The global transport of nonindigenous marine organisms. *Science* **261**: 78–82.
- Carlton, J.T.** 1993. Neoextinctions of marine invertebrates. *American Zoologist* **33**: 499–509.
- Charlson, R.J., Lovelock, J.E., Andreae, M.O.** and Warren, S.G. 1987. Oceanic phytoplankton, atmosphere sulfur, cloud albedo and climate. *Nature* **326**: 655–661.
- Colebrook, J.M.** 1991. Continuous plankton records: from seasons to decades in the plankton of the north-east Atlantic. In: Kawasaki, T., Tanaka, S., Toba, Y. and Taniguchi, A. (eds), *Long-term Variability of Pelagic Fish Populations and their Environment*. 29–45. Pergamon Press, New York.
- Cox, G.W.** 1993. *Conservation Ecology*. W.C. Brown Publishers, Dubuque, Iowa.
- Flegal, A.R., Maring, H.** and Niemeyer, S. 1993. Anthropogenic lead in Antarctic sea water. *Nature* **365**: 242–244.
- Fuhrman, J.A.** and Capone, D.G. 1991. Possible biogeochemical consequences of ocean fertilization. *Limnology and Oceanography*, **36** (8): 1951–1959.
- Fuhrman, J.A.** and Davis, A.A. 1994. Unexplored marine prokaryotic biodiversity. *Abstract Ocean Sciences Meeting, February*.
- Fuhrman, J.A., McCallum, K.** and Davis, A.A. 1992. Novel major archeobacterial group from marine plankton. *Nature* **356**: 148–149.
- Fuhrman, J.A., McCallum, K.** and Davis, A.A. 1993. Phylogenetic diversity of subsurface marine microbial communities from the Atlantic and Pacific Oceans. *Applied Environmental Microbiology* **59**: 1294–1302.
- GESAMP** (Joint group of experts on the Scientific Aspects of Marine Pollution). 1990. *The State of the Marine Environment*. Blackwell Scientific, Cambridge, Mass.
- Giavannoni, S.J., Britschgi, T.B., Moyer, C.L.** and Field, K.G. 1990. Genetic diversity in Sargasso Sea bacterioplankton. *Nature* **345**: 60–63.
- Grassle, J.F.** 1989. Species diversity in deep-sea communities. *Trends in Ecology and Evolution* **4**: 12–15.
- Grassle, J.F.** 1991. Deep-sea benthic biodiversity. *BioScience* **41**: 464–469.
- Grassle, J.F.** and Maciolek, N.J. 1992. Deep-sea species richness: regional and local diversity estimates from quantitative bottom samples. *American Naturalist* **139**: 313–341.
- Grassle, J.F., Maciolek, N.J.** and Blake, J.A. 1990. Are deep-sea communities resilient? In: Woodwell, G.M. (ed.), *The Earth in Transition: Patterns and processes of biotic impoverishment*. 386–394. Cambridge University Press, New York.
- Iverson, R.L., Nearhoof, F.L.** and Andreae, M.O. 1989. Production of dimethylsulphide propionate and dimethylsulphide by phytoplankton in estuarine and coastal waters. *Limnology and Oceanography* **34**: 53–67.
- Kawasaki, T.** 1991. Long-term variability in the fish populations. In: Kawasaki, T., Tanaka, S., Toba, Y. and Taniguchi, A. (eds), *Long-term variability of Pelagic Fish Populations and their Environment*. 29–45. Pergamon Press, New York.
- Kiene, R.O.** and Bates, T.S. 1990. Biological removal of dimethylsulphide from seawater. *Nature* **345**: 702–705.
- La Flamme, R.E.** and Hites, R.A. 1978. The global distribution of polycyclic aromatic hydrocarbons in recent sediments. *Geochimica Cosmochimica Acta* **41**: 289–303.
- Laws, R.M.** 1985. The ecology of the southern ocean. *American Scientist* **73**: 26–40.
- MacCall, A.D.** 1986. Changes in the biomass of the California Current ecosystem. In: Sherman, K. and Alexander, L.M. (eds), *Variability and Management of Large Marine Ecosystems*. 33–54. American Association for the Advancement of Science, Washington, DC.
- Margulis, L.** and Schwartz, K.V. 1988. *Five Kingdoms*. W.H. Freeman, New York.
- May, R.M.** 1992. Bottoms up for the oceans. *Nature* **357**: 278–279.
- Nelson, K.** and Soulé, M. 1987. Genetical conservation of exploited fishes. In: Ryman, N. and Utter, F. (eds) *Population*

- Genetics and Fisheries Management*. Washington Sea Grant Program. 345–368. University of Washington Press, Seattle.
- Norse, E.A.** 1993. *Global Marine Biological Diversity: A strategy for building conservation into decision making*. Island Press, Washington, DC.
- Paine, R.T.** 1993. A salty and salutary perspective on global change. In: Kareiva, P.M., Kingsolver, J.G. and Huey, R.B. (eds), *Biotic Interactions and Global Change*. 347–363. Sinauer Associates, Sunderland, Mass.
- Parilla, G., Lavin, A., Bryden, H., Garcia, M. and Millard, R.** 1994. Rising temperatures in the subtropical North Atlantic Ocean over the past 35 years. *Nature* **369**: 48–51.
- Pfannkuche, O. and Lochte, K.** 1993. Open ocean pelago-benthic coupling: Cyanobacteria as tracers of sedimenting salp faeces. *Deep Sea Research 1, Oceanography Research Paper* **40**: 727–733.
- Poore, G.C.B. and Wilson, G.D.F.** 1993. Marine species richness. *Nature* **361**: 597–598.
- Poore, G.C.B., Just, J. and Cohen, B.F.** 1994. Composition and diversity of Crustacea. Isopoda of the southeastern Australian continental slope. *Deep-Sea Research 1*, **41**: 677–693.
- Ray, G.C. and Grassle, J.F.** 1991. Marine biological diversity. *Bioscience* **41**: 453–457.
- Rijnsdorp, A.D.** 1993. Fisheries as a large-scale experiment on life-history evolution: disentangling phenotypic and genetic effects in changes in maturation and reproduction of North sea plaice, *Pleuronectes platessa* L. *Oecologia* **96**: 391–401.
- Smith, C. R., Kukert, H., Wheatcoff, R.A., Jumars, P.A. and Deming, J.W.** 1989. Vent fauna on whale remains. *Nature* **341**: 27–28.
- Steele, J.H.** 1985. A comparison of marine and terrestrial ecological systems. *Nature* **313**: 355–358.
- Steele, J.H.** 1991. Marine functional diversity. *BioScience* **41**: 470–474.
- Stokes, T.K.A., Law, R., and McGlade, J.** 1993. *The Exploitation of Evolving Populations*. Springer-Verlag, Berlin.
- Takada, H., Farrington, J.W., Bothner, M.H., Johnson, C.G. and Tripp, B.W.** 1994. Transport of sludge-derived organic pollutants in deep-sea sediments at Deep Water Dump Site 106. *Environmental Science and Technology* **28**: 1062–1072.
- Tanabe, S.** 1988. PCB problems in the future: Foresight from current knowledge. *Environmental Pollution* **50**: 5–28.
- Tanabe, S., Tanaka, H. and Tatsukawa, R.** 1984. Polychlorophenyls, DDT, and hexachlorocyclohexane isomers in the western North Pacific ecosystem. *Archives of Environmental Contamination and Toxicology* **13**: 731–738.
- Thiel, H.** 1982. Deep-sea environment disturbance and recovery potential. *Int. Rev. Gesamt. Hydrobiol.* **77**: 331–339.
- Turner, S.M., Malin, G., Liss, P.S., Harbour, D.S. and Holligan, P.M.** 1988. The seasonal variation of dimethylsulphide and dimethylsulfonio-propionate concentrations in near shore waters. *Limnology and Oceanography* **33**: 364–375.
- Valiela, I.** 1984. *Marine Ecological Processes*. Springer-Verlag, New York.
- Vinogradova, N.G.** 1979a. Vertical zonation in the distribution of deep-sea benthic fauna in the ocean. *Deep-Sea Research* **8**: 245–250.
- Vinogradova, N.G.** 1979b. The geographical distribution of the abyssal and the hadal (ultra-abyssal) fauna in relation to vertical zonation of the oceans. *Sarsia* **64**: 41–50.
- Visser, I.K.G., van Bresse, M.F., Baret, T. and Osterhaus, A.D.M.E.** 1993. Morbillivirus infections in aquatic mammals. *Veterinary Record* **24**: 169–178.
- Watling, L. and Langton, R.** 1994. Fishing, habitat disruption, and biodiversity loss. *Abstract, Ocean Sciences Meeting*, February.
- Weber, M.** 1986. Federal marine fisheries management. In: DiSilvestro, R.L. (ed.), *Audubon Wildlife Report* 1986. 267–344 National Audubon Society, New York.
- Yodzis, P.** 1988. The indeterminacy of ecological interactions, as perceived by perturbation experiments. *Ecology* **69**: 508–515.
- Yodzis, P.** 1994. Food webs, dynamics and perturbations. *Abstract at Canadian Society of Zoologists Meeting Bulletin* **25** (2): 111.

6.1.13 Lakes and rivers

6.1.13.1 Introduction

Freshwater ecosystems (lakes and rivers) cover about 2.5×10^6 km², less than 2% of the Earth's surface (Wetzel 1983). Only 0.014% of Earth's water occurs in the soils, rivers and lakes of the biosphere (la Riviere 1989); freshwater lakes contain 1.25×10^5 km³ of water (Wetzel 1983), while rivers contain about 1.2×10^3 km³ (Wetzel 1983). Combined, lakes and rivers contain about 0.009% of Earth's water (Wetzel 1983). Fresh water is a crucial resource for terrestrial ecosystems and human life. In addition, extensive riparian areas associated with rivers and lakes include some of the most productive ecosystems of the landscape. The small pool of water available for life is distributed irregularly, and water often limits terrestrial productivity and economic development (Gleick 1993). Climate and geomorphology determine the global distribution and diversity of fresh waters. Diversity of fresh waters across landscapes depends in part on regional geochemistry and land use. At the species level, diversity is best known for fishes (8400 species, 40% of the world's total fish diversity; WCMC 1992) and aquatic vascular plants (1022 species, Sculthorpe 1967). Other groups are less well known. For example, phytoplankton diversity may be in the order of 10^5 species, but only 10% or so of these are known (WCMC 1992).

Human impacts on biodiversity. A few common drivers account for virtually all human impacts on freshwater biodiversity components (Moyle and Leidy 1992; National Research Council 1992; Allan and Flecker 1993). The most important and widespread of these are:

1. Habitat loss and degradation, driven mainly by land transformations such as agriculture and forestry (Naiman *et al.* 1993) and by direct transformations of freshwater bodies by large water projects (Allan and Flecker 1993).
2. Species invasions and introductions (Lodge 1993).

3. Overharvesting (Moyle and Leidy 1992; Allan and Flecker 1993; Persson 1993).
4. Secondary effects, or cascading consequences of the loss of a native species, addition of an exotic, or overharvesting (Carpenter and Kitchell 1993).
5. Chemical pollution (National Research Council 1992).

Climate change is a potential driver with implications that are less certain than those of drivers 1–5 (Firth and Fisher 1991; Carpenter *et al.* 1992).

Methods for restoring damaged freshwater ecosystems are currently an area of active research (National Research Council 1992; Cooke *et al.* 1993). Rates of recovery are variable, and as a rule of thumb, are proportional to the water renewal time and the generation times of the longest-lived keystone organisms (see Box 5.2-1) (which are usually fishes or higher plants, including riparian trees). Water renewal times of the world's rivers are about 0.05 year and lake renewal times range up to 100 years (Wetzel 1983). Generation times of the keystone organisms are typically about a decade or longer.

Ecosystem consequences of impacts. Scientific certainty is relatively high for the following effects, except where noted otherwise.

6.1.13.2 Productivity, biomass, decomposition and nutrient cycling

Agriculture and construction activity promote erosion and nutrient loading which cause eutrophication of fresh waters. Input of sewage or household wastes can also result in eutrophication. Eutrophication involves increased primary production (especially of nuisance plants which reduce water quality; Cooke *et al.* 1993, increased storage of organic matter, and decreased decomposition due to anaerobiosis (National Research Council 1992). Dams can also increase primary production and storage of organic matter, while decreasing decomposition. In many cases exotic species, overharvesting, and their secondary effects have led to reduction of valuable fishery resources. Some kinds of chemical pollution can reduce fish stocks.

Eutrophication is generally associated with increased nutrient availability and retention in freshwater ecosystems (Wetzel 1983). Exotic species and overharvesting have complex effects on sediments and nutrients. Exotic macrophytes alter sediment accumulation rates and biogeochemistry (Lodge *et al.* 1988), while changes in fish communities affect recycling rates of limiting nutrients (Lamarra 1975; Kitchell *et al.* 1979) and can shift the limiting nutrient between nitrogen and phosphorus (Elser *et al.* 1988; Carpenter and Kitchell 1993). Species composition, size distribution, and migratory behaviour of zooplankton and fishes largely determine the rates and spatial patterns of nutrient recycling in lakes (Carpenter *et al.* 1992; Schindler *et al.* 1993).

6.1.13.3 Water distribution, balance and quality

Eutrophication reduces water quality (Peierls *et al.* 1991, National Research Council 1992). Exotic species, overexploitation, and their secondary consequences, can either improve or degrade water quality. For example, exploitation of large fishes leads to increases in the numbers of small zooplanktivorous fishes, decreases in herbivorous zooplankton, excess algal growth and reduced water quality (Carpenter and Kitchell 1993). On the other hand, invasions of the zebra mussel in Eurasia and North America may improve water quality by filtering particles from the water. In rivers, the impacts of invasion or over-exploitation may depend very much on spatial scale and the elapsed time since last major flood (Grimm 1992). Chemical pollution reduces water quality.

6.1.13.4 Atmospheric properties

Anoxia, which has significant impacts on aquatic life, is a common consequence of eutrophication that is in a sense 'atmospheric'. Regional climates are affected by large freshwater bodies (Firth and Fisher 1991). Scientific certainty is relatively low for the following atmospheric effects.

Carbon dioxide: Most lakes have high $p\text{CO}_2$ relative to the atmosphere and therefore outgas CO_2 (Cole *et al.* 1994). However, the direction of gas exchange with the atmosphere can be reversed by adding nutrients or by adding fish that eat herbivorous zooplankton (Schindler 1977; Cole *et al.* unpublished). In either case productivity rises and uses the excess CO_2 , decreasing $p\text{CO}_2$ in the lake and causing CO_2 to invade from the atmosphere.

Methane: Anoxic sediments of wetlands, lakes and ponds produce considerable amounts of CH_4 at rates linked to landscape biodiversity and the biogeography of beaver (Carpenter *et al.* 1992). Beaver distributions control water retention, soil hydration and oxygenation, nutrient cycling and gas flux over vast continental areas (Naiman *et al.* 1993).

6.1.13.5 Landscape and waterscape structure

For ecosystem consequences of habitat loss and degradation, see 6.1.13.2 and 6.1.13.3.

Landscape and waterscape structures have been altered by river canalization, damming, reservoir construction, sedimentation and saltwater encroachment. Land-use practices that remove or alter riparian vegetation decrease the inputs of large woody debris to rivers and lakes, affecting cover, food resources and spawning habitat of fishes (Maser and Sedell 1994). Impacts of these structural changes are relatively well known scientifically.

6.1.13.6 Biotic linkages and species interactions

Because of the insularity of fresh waters, species introductions, overharvesting and management actions targeted on particular species can have effects that ramify throughout freshwater systems, affecting production, decomposition and nutrient recycling as well as other species (Power 1990; Carpenter *et al.* 1992; National Research Council 1992; Carpenter and Kitchell 1993; Lodge 1993; Persson 1993). These changes may also affect wildlife and waterfowl that use freshwater systems for drinking, habitat and food. Biodiversity of functional guilds in fresh waters can stabilize process rates in stressed ecosystems (Schindler 1990). This resistance to stress depends on the capacity of more tolerant species to replace the contributions of less tolerant ones (Frost *et al.* 1994). The resilience of freshwater ecosystems (i.e. their rate of recovery from perturbation) depends in part on biotic linkages and species interactions (Cottingham and Carpenter 1994). However, there is considerable scientific uncertainty about the responses of freshwater systems to changes in biodiversity. Species invasions have had a wide range of impacts on freshwater communities and ecosystems (Lodge 1993). For a given freshwater system, the nature and consequences of future invasions by exotic species may be difficult to predict.

6.1.13.7 Microbial activities

Eutrophication affects microbial activity, the biodiversity of microbial metabolic pathways, and the biodiversity of biogeochemical pathways through anaerobiosis (Wetzel 1983). Effects of species introductions and overharvesting on microbial activity are poorly resolved (Porter *et al.* 1988). Pelagic microbial activity closely tracks the productivity of phytoplankton, which can be effected by food-web structure (Pace 1993). Chemical pollution can directly and selectively affect crucial biogeochemical transformations (e.g. nitrification and sulphate reduction; Schindler 1990).

6.1.13.8 Summary and relevance to human activities

Landscapes and freshwater bodies are linked by powerful feedbacks. Terrestrial landscape diversity affects fresh waters by determining rates of erosion, siltation and nutrient input. Freshwater bodies are a magnet for human settlement and use, and human activities determine landscape biodiversity in the watersheds. Freshwater bodies are insular habitats in which biotic interactions can have major consequences. Species introductions and fish manipulations have significantly changed productivity, nutrient cycling and physical characteristics of fresh waters, and the net consequence of land-use changes and species introductions has been to increase the similarity among fresh-water ecosystems through eutrophication and community change.

Humans need fresh water for drinking, fishing, industry, irrigation, recreation and transportation (Schindler and Bayley 1990). These uses are impaired by landscape changes that fill, eutrophicate or pollute lakes and rivers, and by exotic species introductions and overharvesting that displace or eliminate living resources. A diversity of freshwater systems on the landscape is valuable as insurance against fluctuations in the productivity of, or need for, particular freshwater resources. Freshwater ecosystem diversity requires a diversity of riparian vegetation that buffers freshwater systems from upland erosion or other disturbances. Species management is a component of many methods for restoring fresh waters that have become degraded (National Research Council 1992). Species diversity guarantees a range of options for restorations that are potentially self-sustaining and consequently less costly. A major reason for sustaining freshwater biodiversity is to preserve options for maintaining high-quality water resources under different environments in the future.

References

- Allan, J.D. and Flecker, A.S. 1993. Biodiversity conservation in running waters. *BioScience* **43**: 32–43.
- Carpenter, S.R., Cottingham, K.L. and Schindler, D.E.. 1992. Biotic feedbacks in lake phosphorus cycles. *Trends in Ecology and Evolution* **7**: 332–336.
- Carpenter, S.R., Fisher, S.G., Grimm, N.B. and Kitchell, J.F. 1992. Global change and freshwater ecosystems. *Annual Review of Ecology and Systematics* **23**: 119–139.
- Carpenter, S.R., Frost, T.M., Kitchell, J.F. and Kratz, T.K. 1992. Species dynamics and global environmental change: a perspective from ecosystem experiments. In: Kareiva, P.M., Kingsolver, J. and Huey, R. (eds), *Biotic Interactions and Global Change*. 267–279. Sinauer Associates, Sunderland, Mass.
- Carpenter, S.R. and Kitchell, J.F. (eds), 1993. *The Trophic Cascade in Lakes*. Cambridge University Press, Cambridge.
- Cole, J.J., Caraco, N.F., Kling, G.W. and Kratz, T.K. 1994. Carbon dioxide supersaturation in the surface waters of lakes. *Science* **265**: 1568–1570.
- Cooke, G.D., Welch, E. B., Peterson, S.A. and Newroth, P.R. 1993. *Restoration and Management of Lakes and Reservoirs*, 2nd edn. Lewis Publishers, Boca Raton, Fla.
- Cottingham, K.L. and Carpenter, S.R. 1994. Predictive indices of ecosystem resilience: consistency and testability in models of North Temperate lakes. *Ecology* **75**: 2127–2138.
- Elser, J.J., Elser, M.M., MacKay, N.A. and Carpenter, S.R. 1988. Zooplankton-mediated transitions between N- and P-limited algal growth. *Limnology and Oceanography* **33**: 1–14.
- Firth, P. and Fisher, S.G. 1991. *Climate Change and Freshwater Ecosystems*. Springer-Verlag, New York.
- Frost, T.M., Carpenter, S.R., Ives, A.R. and Kratz, T.K. 1994. Species compensation and complementarity in ecosystem function. In: Jones, C. and Lawton, J. (eds), *Linking Species and Ecosystems*. Chapman and Hall, New York.

- Gleick, P.H.** 1993. *Water in Crisis: A guide to the world's fresh water resources*. Oxford Science Publications, London.
- Grimm, N.B.** 1992. Implications of climate change for stream communities. In: Kareiva, P.M., Kingsolver, J. and Huey, R. (eds), *Biotic Interactions and Global Change*. 293–314. Sinauer Associates, Sunderland, Mass.
- Kitchell, J.F., O'Neill, R.V., Webb, D., Gallepp, G., Bartell, S.M., Koonce, J.F. and Ausmus, B.S.** 1979. Consumer regulation of nutrient cycling. *BioScience* **29**: 28–34.
- Lamarra, V.** 1975. Digestive activities of carp as a major contributor to the nutrient loading of lakes. *Verh. Int. Verein. Limnol.* **19**: 2461–2468.
- la Riviere, J.W.M.** 1989. Threats to the world's water. *Scientific American*, September 1989: 80–94.
- Lodge, D.M.** 1993. Biological invasions: lessons for ecology. *Trends in Ecology and Evolution* **8**: 133–137.
- Lodge, D.M., Barko, J.W., Strayer, D., Melack, J.M., Mittelbach, G.G., Howarth, R.W., Menge, B. and Titus, J.E.** 1988. Spatial heterogeneity and habitat interactions in lake communities. In: Carpenter, S.R. (ed.), *Complex Interactions in Lake Communities*. 181–208. Springer-Verlag, New York.
- Maser, C. and Sedell, J.R.** 1994. *From the Forest to the Sea: The ecology of wood in streams, rivers, estuaries and oceans*. St Lucie Press, Delray Beach, Fla.
- Moyle, P.B. and Leidy, R.A.** 1992. Loss of biodiversity in aquatic ecosystems: evidence from fish faunas. In: Fiedler, P.L. and Jain, S.K. (eds), *Conservation Biology: The theory and practice of nature conservation, preservation, and management*. 128–169. Chapman and Hall, New York.
- Naiman, R.J., DeCamps, H. and Pollock, M.** 1993. The role of riparian corridors in maintaining regional biodiversity. *Ecological Applications* **3**: 209–212.
- National Research Council** 1992. *Restoration of Aquatic Ecosystems*. National Academy Press, Washington, DC.
- Pace, M.L.** 1993. Heterotrophic microbial processes. In: Carpenter, S.R. and Kitchell, J.F. (eds), *The Trophic Cascade in Lakes*. 252–277. Cambridge University Press, Cambridge.
- Peierls, B.L., Caraco, N.F., Pace, M.L. and Cole, J.J.** 1991. Human influence on river nitrogen. *Nature* **350**: 386–387.
- Persson, L.** 1993. Natural patterns of shifts in fish communities – mechanisms and constraints on the sustenance of mass removals. In: Cox, I.G. (ed.), *Rehabilitation of Freshwater Fisheries*. 421–434. Blackwell, London.
- Porter, K.G., Paerl, H., Hodson, R., Pace, M., Prisco, J., Riemann, B., Scavia, D. and Stockner, J.** 1988. Microbial interactions in lake food webs. In: Carpenter, S.R. (ed.), *Complex Interactions in Lake Communities*. 209–228. Springer-Verlag, Berlin.
- Power, M.E.** 1990. Effects of fish in river food webs. *Science* **250**: 411–415.
- Schindler, D.W.** 1977. Evolution of phosphorus limitation in lakes: natural mechanisms compensate for deficiencies of nitrogen and carbon in eutrophied lakes. *Science* **195**: 260–262.
- Schindler, D.W.** 1990. Experimental perturbations of whole lakes as tests of hypotheses concerning ecosystem structure and function. *Oikos* **57**: 25–41.
- Schindler, D.W. and Bayley, S.E.** 1990. Fresh waters in cycle. In: Mungall, C. and McLaren, D.J. (eds), *Planet Under Stress*. 149–167. Oxford University Press, Oxford.
- Schindler, D.W., Kitchell, J.F., He, X., Carpenter, S.R., Hodgson, J.R. and Cottingham, K.L.** 1993. Food web structure and phosphorus cycling in lakes. *Transactions of the American Fisheries Society* **122**: 756–772.
- Sculthorpe, C.D.** 1967. *The Biology of Aquatic Vascular Plants*. Edward Arnold, London.
- World Conservation Monitoring Centre** 1992. *Global Biodiversity: Status of the earth's living resources*. Chapman and Hall, London.
- Wetzel, R.G.** 1983. *Limnology*. Saunders, Philadelphia, Pa.

6.2 Cross-biome comparisons

6.2.1 Productive capacity and biomass accumulation

6.2.1.1 Introduction

The response of ecosystem net primary production (plant growth) to biodiversity has two major components. One reflects the role of diversity in providing genotypes or species adapted to the full range of habitats within a biome, over the long term, including year-to-year climate variation and cycles of disturbance and recovery. The other concerns the response of production to diversity in a single year and at a single site. Because the relevant evidence, the underlying principles, and the feasible approaches for studying these two components are quite different, they are treated here in sequence.

Here, when referring to biodiversity, we generally refer to genetic and species diversity of the primary producers with the dominant life-form, i.e. trees in forests, grasses in grasslands, macro-algae in nearshore habitats and so on. Whole ecosystem biodiversity has additional dimensions, some of which may be critical determinants of production. For example, a relatively uncommon insect that preys on insect herbivores can have a major impact on production. At present, general tools for identifying species with a functional impact much larger than their biomass are not available (see Section 5.2.2). A focus on consequences of the diversity of primary producers in the dominant life form provides a starting point for understanding the functional role of biodiversity, but it clearly does not address the entire range of potentially important interactions.

6.2.1.2 Lessons from agriculture

Modern agriculture and plantation forestry are based on the premise that low-diversity ecosystems can be highly productive. While this premise is broadly validated in intensively managed ecosystems, the experience of agriculture highlights the critical sensitivity of low-diversity ecosystems to variation in climate and soils as well as outbreaks of pests and pathogens. Across all of the world's biomes, temporal and spatial variation in climate, soils, disturbance (e.g. fire, hurricanes) and biotic influences (e.g. pests, pathogens, dispersers, pollinators) are the rule rather than the exception. This variability,

much of which modern practices in agriculture and forestry are designed to suppress, establishes important constraints on the productivity of low-diversity natural ecosystems, especially over long time periods.

Lessons from agriculture provide useful guideposts for understanding the role of biodiversity in regulating production. First, when the genetic diversity of agricultural crops is severely limited, as when single hybrids are planted over large areas, pests and pathogens can be devastating. The outbreak of *Helminthosporium maydis* on CMS-T hybrid corn in 1969 and 1970 is an extreme example (Williams and Levings 1992). Second, maintaining productivity across a mixture of good and bad years is one of the most common motivations for multi-crop agriculture (Francis 1986; Vandermeer 1988; Swift and Anderson 1993). Third, progressive losses of productivity in some intensively farmed regions demonstrate that high productivity in low diversity ecosystems may be transient, depleting the accumulated capital of soil nutrients rather than operating on the sustainable supply.

6.2.1.3 Habitat variation in space and time

The role of biodiversity in modulating the sensitivity of production in natural ecosystems to variation in climate, soils and biotic factors is far from completely understood, but several lines of evidence establish its importance. Some of the evidence is very direct. For example, Tilman and Downing (1994) observed that biomass production was less drought-sensitive in high-diversity grassland plots than in low-diversity plots in the American Midwest (see Section 6.1.7.3). Year-to-year variations in climate can strongly favour different species in different years (Hobbs and Mooney 1991), a pattern that appears to result in higher productivity than occurs with continuous dominance by a single species.

Much of the evidence for the links between production and the biodiversity sufficient to provide species that thrive across a biome and over time is indirect and comes more from studies of pattern than of process. For example, vegetation differences between north- and south-facing slopes, drier upland and moister lowland sites, or sites on different soil types, are very common (Chabot and Mooney 1985). Whenever biodiversity falls below the minimum representing the suite of species or genotypes best adapted to each of the major habitat types within a biome, the overall vegetation becomes less well adapted to local conditions. With variation in slope, aspect, elevation, soils, moisture, temperature and wind, most biomes include several habitats that support distinctive local ecosystems. While these broad patterns do not necessarily maximize production in any particular year, they consistently yield solid compromises between short-term productivity and long-term persistence (Grime 1979; Chapin 1980). In

general, a single species does not thrive over the entire range of habitats in a biome. The uniform dominance of the tree *Metrosideros polymorpha* in natural Hawaiian habitats is an exception, though the recent history of biological invasions in Hawaii (Vitousek *et al.* 1987) points to the sensitivity of this pattern. Except in intensively managed systems, parallel changes in the habitat and in functional characteristics of the dominant plants make it likely that production increases with biodiversity, at least until each major habitat within a biome is occupied by least one species that thrives in it (Figure 6.2-1).

In many biomes, the vegetation on a patch depends on the time since disturbance, and the distinctions between early successional and late successional species are often striking (Tilman 1988). The failure of late successional species to thrive in early successional habitats and vice versa has been tested in many cases and supported experimentally in some, but not all, studies (e.g. Chapin *et al.* 1994). To the extent that the dominant species of one successional stage fail to thrive in others, production tends to increase with biodiversity whenever the increased biodiversity represents a specialist on an empty successional stage or time since disturbance (Figure 6.2-1).

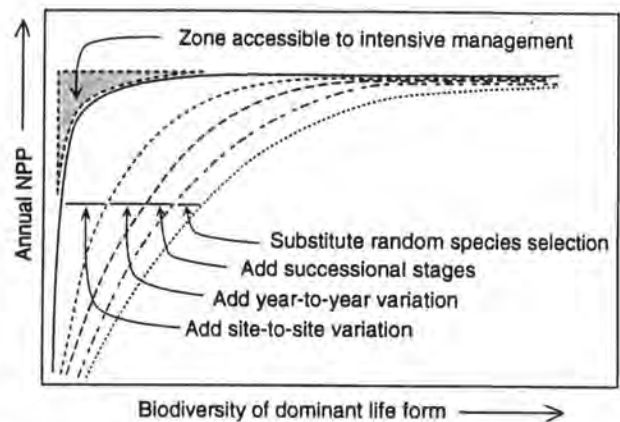

Figure 6.2-1: A conceptual schematic of the response of average annual net primary production (NPP) to the biodiversity of plant species or genotypes in the dominant life-form, showing how mechanisms are likely to combine. The basic idea is that, at one site and in one year, low-diversity ecosystems subjected to intensive management can achieve nearly the same NPP as highly diverse ecosystems. In real biomes, however, spatial variation in climate and resources, temporal variation in climate, and successional dynamics related to disturbance history all increase the range of biodiversity over which NPP changes. NPP of any suite of species not skillfully chosen to provide plants adapted to the full range of habitats probably saturates even more slowly with biodiversity.

Vegetation production and persistence often reflect a balance between highly competitive species that use resources efficiently, and less competitive species that effectively colonize disturbed sites (Tilman 1993). A loss

of species anywhere along the continuum is likely to decrease long-term average productivity. Removal of strong competitors should result in less complete or efficient resource use, while a loss of good colonizers should lead to decreased production through incomplete establishment in recently disturbed areas (Tilman *et al.* 1994).

These three factors (spatial variability, temporal variability, and variation in time since disturbance) all tend to make average annual production an initially increasing function of biodiversity, without necessarily requiring more than one species of the dominant life form per habitat type. For a biome populated with a random selection of the possible species and genotypes, duplication of functional types or suites of adaptations would increase the number of species and genotypes at which long-term average production saturates (Figure 6.2-1).

Given these mechanisms that favour an increase in production with an increase in biodiversity, at what level of biodiversity should production reach a maximum, and how should this vary across biomes? In general, production should saturate at lower levels of biodiversity in biomes with lower levels of spatial and temporal complexity. Biomes certainly differ in the source and scale of the major modes of variation, but differences in the total amount or importance of variation are less clear. In tropical rain forests, the dominant sources of variation are probably related to small-scale gap dynamics (Martínez-Ramos *et al.* 1988) while in Arctic tundra, variation due to topography and soils is especially important (Chapin and Shaver 1989). In other biome types, year-to-year climate variation is a dominant source of variation. The response of grassland production to rainfall is a clear example of this (Sala *et al.* 1994). Precise quantitative estimates of the number of distinctive zones of habitat, climate and disturbance within each major biome are not yet possible. A rough but reasonable estimate is in the order of 10 substantially different zones per biome, with a range of perhaps 4 to 40. Additional experiments will be necessary before it is feasible to develop a more detailed accounting.

6.2.1.4 Production and resource augmentation

The mechanisms discussed above do not address the response to biodiversity of production at a single site in a single year. This topic is not well studied and neither the shape nor the quantitative limits of the response is generally known. In some cases, biological and biogeochemical characteristics related to production appear to saturate with a few species, even in a complex ecosystem like a tropical forest (Ewel *et al.* 1991). But when low-diversity ecosystems fail to develop complete canopies, as a consequence of the suite of plant species present or of interactions across trophic levels, increased diversity can lead to increased production (Naeem *et al.* 1994). Most of

the current hypotheses on the role of biodiversity in production at one site in one year are summarized by a resource augmentation model, which states that adding a species should increase production only if that species has access to, or prevents losses of, previously unused light, water or nutrients. Examples of mechanisms for increasing resource access or decreasing loss include symbiotic nitrogen fixation (for increased access to nutrients (Vitousek *et al.* 1987), increased rooting depth (for increased access to water; Davis and Mooney 1986), improving the temporal match between nutrient release and uptake (Swift and Anderson 1993), releasing extracellular phosphatases into the soil solution (to increase phosphorus availability), faster canopy development (for increased light capture), increased leaf longevity (for decreased nutrient loss), and providing a refuge for ants or other defenders against herbivory (for decreased nutrient loss).

The resource augmentation model predicts that only a fraction of the many possible species additions should lead to increased production. But it also presents the possibility that many of the consequences of additions and deletions should be predictable on the basis of a species' pattern of resource utilization (Hobbie *et al.* 1993) or its relative abundance (Sala *et al.* 1996).

Anthropogenic impacts on the biosphere often result in changes in resource availability, in the efficiency with which resources are used for growth, or in the dynamics of resource turnover (Field *et al.* 1992). In some cases, these impacts may change the response of NPP to biodiversity. If for example, anthropogenic nutrient deposition changes the relative availability of limiting nutrients (Schulze 1989), or if a change in climate eliminates one or more species, potentially available resources may go unused without an increase in biodiversity. On the other hand, a change in resources or species composition could also make it possible for a smaller number of species to capture the available resources or to use the available resources more efficiently. It is also likely that the response of NPP to changes in biodiversity will differ with different anthropogenic impacts and that, for any particular anthropogenic impact, the NPP/biodiversity relationship will vary among biomes. Developing the understanding necessary to predict changes in the response of NPP to biodiversity in ecosystems impacted by altered climate, elevated CO₂, nutrient deposition, oxidants or species introductions should be a central objective of future studies. The role of biodiversity in regulating production at one site in one year involves different mechanisms from those governing the role of biodiversity across the whole array of habitats within a biome, and it is unlikely that relationships among species are the same in the two contexts. Thus, the response of production to biodiversity almost certainly saturates more slowly when both site-to-site and within-site mechanisms are operating. The quantitative response is not

yet known, but it is possible that species complementarity through resource augmentation could lead to increased production with two to several species or genotypes per site. A conservative minimum estimate is that accounting for resource augmentation for each site and year doubles the biodiversity necessary to saturate ecosystem production. Thus, the combination of the mechanisms related to resource augmentation and temporal and spatial diversity should lead to increasing production until the total reaches on the order of 20 species and/or genotypes in the dominant life-form of primary producers. The uncertainty of this estimate is very large. In addition, the persistence of these dominant life-form primary producers may depend on a number of other species, including pollinators, dispersers, nitrogen fixers, decomposers, herbivores and pathogens.

6.2.1.5 Biomass and disturbance

The role of biodiversity in regulating standing biomass is poorly studied. In most biomes, the major control on standing biomass is the frequency of disturbance, including fire, severe weather, and pest and pathogen attacks (e.g. Bonan and Shugart 1989). Disturbance frequency regulates not only the size of the dominant plants but also the species present and, in some cases, the presence or absence of a major growth form, e.g. trees (Hughes *et al.* 1991). Effects of single species on disturbance frequency have been documented (D'Antonio and Vitousek 1992), and resistance to pests and pathogens is one of the best-known benefits of multi-crop agriculture.

Increasing biodiversity could potentially decrease the frequency or intensity of many types of disturbance. Effects of biodiversity on disturbance by pests and pathogens are relatively well known, at least for agriculture. Biodiversity could decrease fire frequency, especially in ecosystems where single species enhance flammability (D'Antonio and Vitousek 1992). While increased biodiversity would not reduce the frequency or intensity of severe weather, it could reduce the intensity of disturbance through interspecific or population differences in tolerance to the extreme weather.

To the extent that increasing biodiversity decreases the frequency and intensity of disturbance, it should lead to increased standing biomass. It is not feasible, at this point, to even speculate on the number of species required to saturate the long-term average standing biomass.

References

- Bonan, G.B. and Shugart, H.H. 1989. Environmental factors and ecological processes in boreal forests. *Annual Review of Ecology and Systematics* **20**: 1–28.
- Chabot, B.F. and Mooney, H.A. (eds) 1985. *Physiological Ecology of North American Plant Communities*. Chapman and Hall, New York.
- Chapin, F.S., III 1980. The mineral nutrition of wild plants. *Annual Review of Ecology and Systematics* **11**: 233–260.
- Chapin, F. S., III, and Shaver, G.R. 1989. Differences in growth and nutrient use among arctic plant growth forms. *Functional Ecology* **3**: 73–80.
- Chapin, F.S., III Walker, L.R., Fastie, C.L. and Sharman, L.C. 1994. Mechanisms of primary succession following deglaciation at Glacier Bay, Alaska. *Ecological Monographs* **64**: 149–175.
- D'Antonio, C.M. and Vitousek, P.M. 1992. Biological invasions by exotic grasses, the grass/fire cycle, and global change. *Annual Review of Ecology and Systematics* **23**: 63–87.
- Davis, S.D. and Mooney, H.A. 1986. Water use patterns of four co-occurring chaparral shrubs. *Oecologia* **70**: 172–177.
- Ewel, J.J., Mazzarino, M.J. and Berish, C.W. 1991. Tropical soil fertility changes under monocultures and successional communities of different structure. *Ecological Applications* **1**: 289–302.
- Field, C.B., Chapin F.S. III, Matson, P.A. and Mooney, H.A. 1992. Responses of terrestrial ecosystems to the changing atmosphere: a resource-based approach. *Annual Review of Ecology and Systematics* **23**: 201–235.
- Francis, C.A. 1986. *Multiple Cropping Systems*. Macmillan, New York.
- Grime, J.P. 1979. *Plant Strategies and Vegetation Processes*. John Wiley, Chichester.
- Hobbie, S., Jensen, D. and Chapin, F.S. III 1993. Global changes in resources and disturbance: predictions for biodiversity. In: Schulze E.-D. and Mooney H.A. (eds), *Ecosystem Function and Biodiversity*. 385–408. Springer-Verlag, Berlin.
- Hobbs, R.J. and Mooney, H.A. 1991. Effects of rainfall variability and gopher disturbance on serpentine annual grassland dynamics. *Ecology* **72**: 59–68.
- Hughes, R.F., Vitousek, P.M. and Tunison, T. 1991. Alien grass invasion and fire in the seasonal submontane zone of Hawaii. *Ecology* **72**: 743–746.
- Martinez-Ramos, M., Alvarez-Buylla, E., Sarukhán, J. and Piñero, D. 1988. Treefall age determination and gap dynamics in a tropical forest. *Journal of Ecology* **76**: 700–716.
- Naeem, S., Thompson, L.J., Lawler, S.P., Lawton, J.H. and Woodfin, R.M. 1994. Declining biodiversity can alter the performance of ecosystems. *Nature* **368**: 734–737.
- Sala, O. E., Lauenroth, W.K. and Burke, I.C. 1994. Carbon budgets of temperate grasslands and the effects of global change. In: Melillo, J.M. and Breymer, A. (eds). *Global Change: Effects on coniferous forests and grasslands*. John Wiley, Chichester (in press).
- Sala, O.E., Lauenroth, W.K., McNaughton, S.J., Rusch, G. and Zhang, X. 1996. Biodiversity and ecosystem function in grasslands. In: Mooney, H.A., Cushman, J.A., Medina, E., Sala, O.E. and Schulze E.-D. (ed.) *Functional Roles of Biodiversity: A global perspective*. John Wiley, New York (in press).
- Schulze, E.-D. 1989. Air pollution and forest decline in a spruce (*Picea abies*) forest. *Science* **244**: 776–783.
- Swift, M.J. and Anderson, J.M. 1993. Biodiversity and ecosystem function in agricultural systems. In: Schulze, E.-D. and Mooney, H.A. (eds), *Biodiversity and Ecosystem Function*. 15–41. Springer-Verlag, Berlin.
- Tilman, D. 1988. *Plant Strategies and the Dynamics and Function*

- of *Plant Communities*. Princeton University Press, Princeton, NJ.
- Tilman, D.** 1993. Species richness of experimental productivity gradients: How important is colonization limitation. *Ecology* **74**: 2179–2191.
- Tilman, D.** and Downing, J.A. 1994. Biodiversity and stability in grasslands. *Nature* **367**: 363–365.
- Tilman, D., May, R.M., Lehman, C.L. and Nowak, M.A.** 1994. Habitat destruction and the extinction debt. *Nature* **371**: 65–66.
- Vandermeer, J.H.** 1988. *The Ecology of Intercropping*. Cambridge University Press, Cambridge.
- Vitousek, P.M., Walker, L.R., Whiteacre, L.D., Mueller-Dombois, D. and Matson, P.A.** 1987 Biological invasion by *Myrica faya* alters ecosystem development in Hawaii. *Science* **238**: 802–804.
- Williams, M.E. and Levings, C.S., III** 1992. Molecular biology of cytoplasmic male sterility. *Plant Breeding Reviews* **10**: 23–51.

6.2.2 The soil system

6.2.2.1 Introduction

The widespread effects of human activities on soils are of global concern because of increased emissions of 'greenhouse' gases, accelerated erosion and desertification, and declining fertility in soils supporting some of the highest population densities in developing countries (World Resources Institute 1992-3). Human-induced soil degradation by wind, water and pollution amounts to about 24% of the inhabited land area of the globe (Oldeman 1994). Changes in climate, atmospheric CO₂ concentrations and UV radiation are affecting soils and vegetation in regions of the world remote from direct effects of human activities (IPCC 1992). Disruption of soil processes from atmospheric pollution, changes in landuse, management practices and intensive use of agrochemicals are also affecting freshwater and marine systems as a consequence of increased transfers of sediment, nutrients and toxins from land to water.

Losses of genetic and species diversity below ground resulting from human impacts on the biosphere are largely undocumented in comparison with estimates of extinction rates above ground. Biodiversity in soils, however, is not simply an attribute of the living biota. Unlike above-ground systems, the physical and biochemical properties of dead organic matter (litter and soil organic matter fractions) confer important functional attributes on soils which are integral to biogeochemical cycles. The structural and biochemical characteristics of soils vary both with depth in the profile and in relation to the parent materials, topographic variation, climate gradients and vegetation cover within and between systems. This spatial heterogeneity constitutes a mosaic of sinks and sources for surface water, sediment and trace gases which is important for stabilizing soil processes at aggregate, patch, plot, ecosystem and landscape scales.

The functional importance of biodiversity for the maintenance of soil fertility remains one of the most fundamental gaps in current understanding of terrestrial ecosystems (Swift and Anderson 1993; Anderson 1994). Indeed, the total diversity of the soil biota, as a starting point for this assessment, has not yet been determined for any natural system (Lee 1991). As a consequence of this dearth of comparable information on biodiversity in soils for the different biomes, this review has been developed in the style of a biome essay rather than a cross-biome synthesis as originally intended.

6.2.2.2 Lessons from agriculture

Human impacts on biodiversity. Most of the annual flux of carbon and nutrients in soils from tundra to tropical rain forest occurs in the top 5–10 cm of the profile despite the considerable variation in biomass and primary productivity above ground along this gradient. Structural characteristics of litter cover and the soil surface to a few millimeters depth partition the beneficial or destructive effects of rainfall (Papendick 1994). The animal and microbial communities occupying these critical soil interfaces are highly complex even in natural systems with low biodiversity of plant species. At the molecular and organism level, biodiversity in soils is very high. A single gram of temperate forest soil could contain 10⁹ individual cells comprising 4000–5000 bacterial types, of which less than 10% have been isolated and are known to science (Torsvik *et al.* 1990; Klug and Tiedje 1994). More than 500 species of soil invertebrates have been recorded from a beech (*Fagus sylvatica*) forest (Schaefer and Schauermann 1990) and new records are still being added to a list of 2500 species of fungi from a nature reserve covering a few hectares in southwest England (Hawksworth 1992). Species richness declines towards the poles but assumptions regarding the simplicity of communities at high latitudes generally ignore the complexity of below-ground systems. Even simple moss tussock communities in the Antarctic Peninsula have complex food webs linking over a hundred species of algae, protozoa, nematodes, tardigrades, collembola and mites plus unknown numbers of fungal and bacteria species (Davis 1981).

Significant loss of biodiversity can occur when natural habitats are modified or converted to intensive permanent cultivation (Paoletti *et al.* 1992; Anderson and Swift 1993; Freckman and Ettema 1993; Lavelle *et al.* 1994). The larger, surface-living invertebrates disappear first with the destruction of litter habitats which provide food and living space. Dead tree boles and branches containing many wood-decomposing invertebrates and fungi can be eliminated under intensive extractive forest management or plantation forestry (Gilot *et al.* 1992). Conversion of tropical forest to tree plantations or smallholder farming

systems can also result in changes in termite communities with the loss of highly diverse humivorous groups and an increase in wood/litter feeders which include damaging pest species (Wood *et al.* 1977). In New Zealand, improvement of temperate pastures with legumes and exotic grasses eliminated indigenous earthworm species and enabled European lumbricids to become established (Lee 1985). In contrast, European lumbricids maintained marginal populations in US prairies in relation to native *Diplocardia* species because of their intolerance of high summer temperatures (James 1991). However, these exotic earthworms have invaded many mesic habitats where there is a low diversity of indigenous species (Hendrix *et al.* 1992).

Communities of smaller invertebrates live within the highly complex microscopic structure of litter and soil habitats. Anderson (1978) showed that the diversity of mite (Cryptostigmata) species was closely related to microhabitat diversity in organic soils developed under a single tree species. Changes in litter quality or the introduction of plant species with faster decay rates reduces habitat complexity. Improvement of pasture quality to support higher stock densities reduces the thatch of litter on the soil surface and thus the habitat space for the associated micro-arthropod communities (Hutchinson and King 1980), but earthworms living within the mineral soil respond positively to increased grass and dung quality (Knight *et al.* 1992; James 1992).

Mechanical cultivation is highly destructive to most invertebrate groups. The microbiota (nematodes, protozoa, micro-fungi and bacteria) are the main groups surviving in intensively tilled soils (Hendrix *et al.* 1986; Freckman and Ettema 1993). Agrochemicals also reduce the taxonomic and genetic diversity of soil micro-organisms (Domsch *et al.* 1983; Atlas *et al.* 1991). Even so, total biodiversity in agricultural soils is likely to be greater than the total above-ground diversity of plants and animals in the natural systems from which they were derived. The adoption of zero or minimum tillage practices allows the resurgence of biodiversity in agricultural soils provided that sources of colonists are present in habit refugia around the field margins (Hendrix *et al.* 1986).

Ecosystem consequences of human impacts. Most soil organisms are small (<2 mm diameter) and manifest their specific effects at spatial and temporal scales orders of magnitude below those where process measurements are made in most ecological studies (Anderson 1988). As a consequence there is a poor understanding of the links between their proximate roles in biological transformations and processes operating at larger scales and over longer time intervals.

The roles of the soil biota can be described in terms of allogenic and autogenic processes proposed by Jones and Lawton (1995). The allogenic processes, such as carbon

and nitrogen mineralization, are direct products of soil organism metabolism. These are modified by changes in the quality of the resources they are processing as a consequence of changes in plant species composition, CO₂ and N enrichment of plants, or pollution. Autogenic processes involve the modulating effects of organisms where the consequences of their activities, such as removing litter, creating soil macropores or the release of prey from predation, influence mass or energy transfers much larger than their allogenic effects (Anderson 1995).

Microcosm studies have shown that different species and combinations of invertebrates and microorganisms have specific effects on the rates and products of carbon and nutrient fluxes. The feeding activities of collembola, mites, nematodes and protozoa have also been shown to change the composition and activities of bacterial and fungal communities in ways analogous to the effects of herbivores in above-ground communities (reviews by Anderson 1988; Verhoef and Brussaard 1990). The specific nature of allogenic and autogenic effects could be taken to support the 'Rivet Hypothesis' that the removal of each species deletes unique properties from community functions (Ehrlich and Ehrlich 1981; see Section 5.1). However, at an ecosystem level, the attributes of complexity in food webs are not apparent and fumigation treatments, which eliminate much of the biotic diversity in soils, usually show transient effects on soil processes; at least in the short term (Rovira 1976; Ridge 1976; Ingham *et al.* 1986). These results suggests that there is a high level of functional overlap in soil biological processes, with many organisms producing similar metabolic end products able to compensate for changes in community structure. On the other hand, microbial processes such as nitrogen fixation, which are carried out by a group of bacteria with intrinsically low diversity in soils, are susceptible to heavy metal contamination of soils (Brookes and Verstraete 1989). McGrath *et al.* (1988) have shown that the activity of *Rhizobium* associations with white clover (*Trifolium repens*) was drastically reduced by heavy metal concentrations from sewage sludge which were within legislative limits set by the European Community.

The activities of soil fauna are evident at the ecosystem level where functional groups are dominated by one or two species creating persistent artifacts (aggregates, burrows, incorporation of organic matter into soil) which have cumulative effects on soil properties (Anderson 1995). The elimination of earthworms, or the introduction of exotic species with different attributes to the indigenous community, has been shown to alter soil structure, aeration, surface water infiltration, the distribution of organic matter, pesticides and heavy metals, and total crop production (Lee 1985; Lavelle 1988; Clements *et al.* 1991). In Peru, the conversion of forest to improved pasture eliminated most of the soil macrofauna and populations of an exotic tropical

earthworm species, *Pontoscolex corethrurus*, then developed a biomass of 4 t/ha and dominated soil processes (Lavelle and Pashanasi 1989). Termites in semi-arid systems have similar key effects on soil structure and hydrology which can shift from beneficial to deleterious as a consequence of changes in climate or management. In the overgrazed grasslands of Ethiopia, scavenging of the little remaining grass and litter cover by termites leaves soil bare and susceptible to erosion (Wood 1991). Similarly, the bare ground around termite mounds in grassland fallows of West Africa can initiate erosion and land degradation when they reach high densities (Janeau and Valentin 1987). Conversely, the elimination of a single termite species in the Chihuahuan desert altered the soil water balance and resulted in shrubs replacing grass cover in experimental plots over a period of eight years (Elkins *et al.* 1986).

6.2.2.3 Soil organic matter

Components of diversity. Soil organic matter (SOM) contains on average twice the amount of carbon found in vegetation above ground and is a resource of extraordinary physical and biochemical complexity (Theng *et al.* 1989; Anderson 1991). Dead organic matter is essential to the functioning of most natural and derived soils not only as a complex habitat and resource base for a diverse biota, but also because it maintains the physical and chemical integrity of the system. Litter resource types (fruits, leaves, twigs, branches, coarse and fine roots) from species with different chemical compositions and decomposition rates regulate the rates of carbon and nutrient mineralization (Swift and Anderson 1993). Litter cover also protects the soil from wind and rain erosion, and influences water and heat transfer to the underlying soil (Lal 1994). During the process of decomposition, soil organic matter (SOM) is formed which can be chemically or physically stabilized by soil minerals to form different fractions with turnover rates ranging from years to centuries. The whole range of SOM fractions, operationally defined as fast, slow and passive, confer particular attributes on soil such as aggregate stabilization, complexing free aluminium, regulating soil moisture, forming ion exchange complexes and constituting sinks/sources of plant nutrients (Duxbury *et al.* 1989). There are, however, very different time scales over which these effects are manifested. Changes in litter and fast SOM fractions have rapid effects on soil physical processes and nutrient cycling but the slow and passive fractions have turnover rates ranging from decades to millenia. Consequently, the restitution of soil profile characteristics under natural vegetation cover following catastrophic disturbance can effectively operate outside the human time frame.

Ecosystem consequences of human impacts. The effects of changing resource diversity on soil properties fits the asymptotic model of Vitousek and Hooper (1993; see

Figure 5.2-1A) relating species richness to ecosystem functioning. Adding (or removing) resources until all the key resource types are represented has larger effects on a given process than further additions of representatives of those groups. For example, erosion control depends on the amount of litter cover for soil protection rather than the diversity of plant species making up the litter (Mbakaya *et al.* 1988). Similarly, the amount of soil organic matter depends upon the quality and quantity of resource inputs and not on vegetation diversity. Hence SOM accumulation in forests is related to the inherent fertility of the parent soil and not to tree species diversity.

Where resource types are the product of a keystone species the effects of changing diversity can be profound. Davies (1981) has described two Antarctic moss communities: a tall turf community dominated by two moss species and a moss carpet dominated by three species. The decomposition-resistant (low quality) stems of one moss in the tall turf contributed to SOM accumulation to a depth of 2 m under this community against only 0.2 m SOM accumulated under the moss carpet with more rapidly decomposing (high quality) species. Analogous effects on soil carbon pools are associated with changes in landuse between high quality broad-leaf woodlands and low-quality conifer plantations; or the introduction new keystone species with contrasting litter quality into communities with low diversity (Anderson 1991). In Hawaii, organic soils have developed under stands of a single tree species, *Metrosideros polymorpha* which produces a low-quality litter in response to limited N availability. The invasion of the monospecific stands by an introduced nitrogen-fixing tree, *Myrica faya*, which produces a rapidly decomposing litter, has changed the nutrient and organic matter balances of the ecosystem (Vitousek *et al.* 1987). The consequences of these changes for the biodiversity of soil organisms are unknown but are likely to be profound. More gradual increases in litter quality and SOM turnover are occurring over much of Europe where anthropogenic sources of N are saturating forest ecosystems leading to increased nitrate leaching and nitrous oxide emissions (Aber *et al.* 1989; Rosen *et al.* 1992). Conversely, increased C/N ratios in litter as a consequence of CO₂ enrichment of N-limited systems may be increasing carbon storage in SOM on a global scale (Allen 1990; Bazzaz 1990).

6.2.2.4 Functional importance of spatial complexity

Spatial components of biodiversity. Soils under undisturbed vegetation cover have high resilience to natural perturbations, such as storm events, cataclysmic litter inputs and extreme seasonality, so that losses of suspended solids or solutes are usually small in relation to the pools and fluxes within the system boundaries. The mass balance of carbon and nutrients in the system is maintained by transfers between sinks and sources which operate at

different scales from microsites to landscapes (Anderson 1995). Reciprocal processes, which stabilize the overall dynamics of the system, are manifest in soil organism populations (natality/mortality; emigration/immigration), nutrient cycling (mobilization/immobilization), carbon fluxes (plant growth/decomposition), water balances (runoff/infiltration) and soil development (erosion/weathering). These sink/source interactions are considered in other essays in this volume and are only briefly reviewed here.

The balance between processes of nitrogen mineralization/immobilization, and nitrification/denitrification, are important in regulating nitrate leaching and nitrous oxide emissions from soils. These N transfers occur between adjacent bacteria, on gradients within soil aggregates (Groffman *et al.* 1987; Parkin 1987), at the level of resource patches integrated by fungal hyphae on the forest floor (Rayner and Boddy 1988), in forest gaps (Vitousek and Denslow 1986) and between hill-slope and riparian zones of catchments (Peterjohn and Correll 1984; Gregory *et al.* 1991). Sinks and sources for methane similarly exhibit scaling related to aerobic and anaerobic regimes in soils (Crutzen 1991) from microsites within aggregates (King and Adamsen 1992), and between surface and underlying soil horizons (Whalen and Reeburgh 1990) through the patch scales associated with plant communities (Whalen *et al.* 1990) up to the landscape scale (Moore *et al.* 1990).

Hydrological processes are also buffered by spatial heterogeneity of surface water sources and sinks. In rain forest, high intensity storm events, combined with funnelled stemflow as a result of branching patterns of canopy emergents, may create saturated areas around the trunk bases and overland flow downslope from these areas. Exposed roots and buttresses, however, can act as effective barriers to downslope soil wash (Spencer *et al.* 1990). Van Hooff (1982) showed that splash erosion and overland flow in a deciduous woodland was determined by the differential palatability to earthworms of litter from the two tree species. Consumption of the more palatable litter in patches of one tree species in spring caused splash erosion, while patches of the less palatable species, where litter cover remained intact, formed sinks for surface water and sediment so that there were no net losses of sediment across the forest boundary. Soil loss rates are generally low under forest cover but severe erosion can occur in extensive plantations of teak (*Tectona grandis*) where ground cover vegetation is suppressed and the rapidly decomposing leaves give no soil protection from the high kinetic energy of canopy throughfall (Bell 1973).

Spatial heterogeneity of soil properties reduces the amplitude of sediment, solute and trace gas losses from terrestrial systems. Extreme events which exceed sink strengths at local scales may be contained with the patch mosaic sinks at ecosystem or landscape scales. Human activities have major impacts on the heterogeneity of soils

which affect terrestrial, aquatic and atmospheric processes.

Ecosystem consequences of human impacts. Changes in landuse resulting from traditional agricultural practices can increase spatial heterogeneity of ecosystems within the landscape as a consequence of habitat fragmentation. Further intensification of landuse reduces the patch heterogeneity of sources and sinks for trace gases and solutes, and increases the periodicity and amplitude of biogeochemical fluxes within the landscape (Burke and Lauenroth; see 6.2.4). As larger areas of arable agriculture, plantation forestry and pastures come under the same soil management practices and cropping cycles, trace gas fluxes and nutrient leaching can be synchronized across whole landscapes with knock-on effects for atmospheric and aquatic systems on regional and even wider geographic scales.

Extensive development of intensive agricultural practices has increased soil erosion by wind and water in many regions of Europe and North America (Lal 1994; Papendick 1994). The removal of hedgerows and buffer strips, levelling of field systems and intensive tillage have reduced sinks for transported material. Soil channelling and compaction also result in surface runoff exceeding the infiltration capacity and particle retention by the microtopography of inter-rill areas (Boardman 1991). Similarly, Hutsch *et al.* (1993) have shown that sink strengths for methane in agricultural systems are related to the use of inorganic fertilizer (decreased sink) and organic manures (increased sink). Uniform agricultural practices using inorganic fertilizers can therefore reduce sinks for methane across agricultural landscapes (Mosier *et al.* 1991). Atmospheric N deposition also reduces the sink strength of forest soils (Steudtler *et al.* 1989).

6.2.2.5 Summary and relevance to human activities

Soils contain high biological, biochemical and physical complexity which can be defined across all scales from the microscopic to landscape level. The biotic diversity below ground may be orders of magnitude higher than that above ground but total microbial diversity has not been fully documented in any system. Human activities reduce the diversity of species, resources and spatial heterogeneity through changes in land-use and the effects of pollutants but the functional importance of these changes are largely unknown. Processes dominated by a few species representing functional groups are at risk from the direct and indirect effects of human activities. Source/sink dynamics within systems buffer mineral element, trace gas and sediment fluxes. These processes become synchronized with increasing intensity of landuse and reduction of spatial heterogeneity. As a consequence the amplitude and periodicity of biogeochemical fluxes can override sinks within landscapes and result in net transfers between the atmosphere and adjacent systems which would otherwise

be accommodated within system boundaries. It is concluded that there is a high degree of uncertainty over the consequences of reducing biodiversity below ground to undefined threshold levels in any terrestrial systems.

References

- Aber, J.D., Nadelhoffer, K., Steudler, P. and Melillo, J.M. 1989. Nitrogen saturation in Northern forest ecosystems. *Bioscience* **39**: 378–386.
- Allen, L.H. 1990. Plant responses to rising carbon dioxide and potential interactions with air pollutants. *Journal of Environmental Quality* **19**: 15–34.
- Anderson, J.M. 1978. Inter- and intra-habitat relationships between woodland *Cryptostigmata* species diversity and the diversity of soil and litter habitats. *Oecologia* **32**: 341–346.
- Anderson, J.M. 1988. Spatiotemporal effects of invertebrates on soil processes. *Biology and Fertility of Soils* **6**: 216–227.
- Anderson, J.M. 1991. The effects of climate change on decomposition processes in grassland and coniferous forests. *Ecological Applications* **1**: 326–347.
- Anderson, J.M. 1994. Functional attributes of biodiversity in land use systems. In: Greenland, D.J. and Szabolcs, I. (eds), *Soil Resilience and Sustainable Land Use*. 267–290. CAB International, Wallingford.
- Anderson, J.M. 1995. Soil organisms as engineers: microsite modulation of macroscale processes. In: Jones, C.G. and Lawton, J.H. (eds), *Linking Species to Ecosystems*. 94–106. Chapman and Hall, New York.
- Atlas, R.M., Horowitz, A., Kritchovsky, M. and Bej, A.K. 1991. Response of microbial populations to environmental disturbance. *Microbial Ecology* **22**: 249–256.
- Bazzaz, F.A. 1990. The response of natural ecosystems to the rising CO₂ levels. *Annual Review of Ecology and Systematics* **21**: 167–196.
- Bell, T.I.W. 1973. Erosion in Trinidad teak plantation. *Commonwealth Forestry Review* **52**: 233–233.
- Boardman, J. 1991. Land use, rainfall and erosion risk on the South Downs. *Soil Use and Management* **7**: 34–38.
- Brookes, P.C. and Verstraete, W. 1989. The functioning of soil as an ecosystem. *Soil Quality Assessment. State of the Art Report on Soil Quality*. Report to Commission of the European Communities Directorate-General DG XII. Contract EV4A/0008/NL. 41.
- Clements, R.O., Murray, P.J. and Sturdt, R.G. 1991. The impact of 20 years' absence of earthworms and three levels of N fertilizer on a grassland soil environment. *Agriculture Ecosystems and Environment* **36**: 75–85.
- Crutzen, P.J. 1991. Methane's sinks and sources. *Nature* **350**: 380–381.
- Davis, R.C. 1981. Structure and function of two Antarctic terrestrial moss communities. *Ecological Monographs* **51**: 125–143.
- Domsch, K.H., Jagnow, G. and Anderson, T.H. 1983. An ecological concept for the assessment of side effects of agrochemicals on soil microorganisms. *Residue Review* **86**: 65–105.
- Duxbury, J.M., Scott Smith, M. and Doran, J.W. 1989. Soil organic matter as a source and sink of plant nutrients. In: Coleman, D.C., Oades, J.M. and Uehara, G. (eds), *Tropical Soil Organic Matter*. 33–68. University of Hawaii Press, Hawaii.
- Ehrlich, P.R. and Ehrlich, A.H. 1981. *Extinction. The causes and consequences of the disappearance of species*. Random House, New York.
- Ehrlich, P.R. 1991. Population diversity and the future of ecosystems. *Science* **254**: 175.
- Elkins, N.Z., Sabol, G.V., Ward, T.J. and Whitford, W.G. 1986. The influence of subterranean termites on the hydrological characteristics of a Chihuahuan desert ecosystem. *Oecologia* **68**: 521–528.
- Freckman, D.W. and Ettema, C.H. 1993. Assessing communities in agroecosystems of varying human intervention. *Agriculture, Ecosystems and Environment* **45**: 239–261.
- Gilot, C., Lavelle, P., Kouassi, Ph. and Guillaume, G. 1992. Biological activity of soils in *Hevea* stands of different ages. *Acta Zoologica Fennica*.
- Gregory, S.V., Swanson, F.J., McKee, W.A. and Cummins, K.W. 1991. An ecosystem perspective of riparian zones. *BioScience* **41**: 540–550.
- Groffman, P.M., Tiedje, J.M., Robertson, G.P. and Christiansen, S. 1987. In: Wilson, J.R. (ed.), *Advances in Nitrogen Cycling in Agricultural Systems*. 174–192. CAB International, Wallingford.
- Hawksworth, D.L. 1992. In: Solbrig, O.T., van Emden, H.M. and van Oordt, P.G.W.J. (eds), *Biodiversity and Global Change*. 83–93. International Union of Biological Sciences, Paris.
- Hendrix, P.F., Parmelee, R.W., Crossley, D.A., Coleman, D.C., Odum, E.P. and Groffman, P.M. 1986. Detritus food webs in conventional and no-tillage agroecosystems. *Bioscience* **36**: 374–380.
- Hendrix, P.F., Mueller, B.R., Bruce, R.R., Langdale, G.W. and Parmelee, R.W. 1992. Abundance and distribution of earthworms in relation to landscape factors on the Georgia Piedmont, USA. *Soil Biology and Biochemistry* **24**: 1357–1361.
- Hutchinson, K.J. and King, K.L. 1980. The effects of sheep stocking level on invertebrate abundance, biomass and energy in a temperate, sown grassland. *Journal of Applied Ecology* **17**: 369–387.
- Hutsch, B.W., Webster, C.P. and Powlson, D.S. 1993. Long term effects of nitrogen fertilization on methane oxidation in soil of the Broadbalk wheat experiment. *Soil Biology and Biochemistry* **25**: 1307–1315.
- Ingham, E.R., Trofymow, J.A., Ames, R.N., Hunt, H.W., Morley, C.R., Moore, J.C. and Coleman, D.C. 1986. Trophic interactions and nitrogen cycling in a semi-arid grassland soil. II. System responses to the removal of different groups of soil microbes or fauna. *Journal of Applied Ecology* **23**: 615–630.
- Intergovernmental Panel on Climate Change 1992. Houghton, J.T., Callander, B.A. and Varney, S.K. (eds), *Climate Change 1992: The supplementary report to the IPCC Scientific Assessment*. Cambridge University Press, Cambridge.
- James, S.W. 1991. Soil nitrogen, phosphorus and organic matter processing by earthworms in tallgrass prairie. *Ecology* **72**: 2101–2109.
- James, S.W. 1992. Localised dynamics of earthworm populations in relation to bison dung in North American tallgrass prairie. *Soil Biology and Biochemistry* **24**: 1471–1476.

- Janeau, J.L. and Valentin, C. 1987. Relations entre des termitières *Trinervitermes* spp. et la surface du sol: réorganisations, ruissellement et érosion. *Revue Ecologie et de Biologie du Sol* **24**: 637–647.
- Jones, C.G. and Lawton, J.H. (ed.) 1995. *Linking Species and Ecosystems; Fifth Cary Conference, Millbrook, New York, May 8–12, 1993*. Chapman and Hall, New York.
- King, G.M. and Adamsen, A.P.S. 1992. Effects of temperature on methane consumption in a forest soil and in pure cultures of the methanotroph *Methylomomas rubra*. *Applied and Environmental Microbiology* **58**: 2758–2763.
- Klug, M.J. and Tiedje, J.M. 1994. Responses of microorganisms to changing environmental conditions: chemical and physiological approaches. In: Guerrero, R. and Pedros-Alio, C. (eds), *Trends in Microbial Ecology*. 371–378. Spanish Society for Microbiology, Barcelona.
- Knight, D., Elliott, P.W. and Anderson, J. M. 1992. The role of earthworms in a managed, permanent pasture in South West England. *Soil Biology and Biochemistry* **24**: 1511–1519.
- Lal, R. 1994. Sustainable land use systems and soil resilience. In: Greenland, D.J. and Szabolcs, I. (eds), *Soil Resilience and Sustainable Land Use*. 41–67. CAB International, Wallingford.
- Lavelle, P. 1988. Earthworm activities and the soil system. *Biology and Fertility of Soil* **6**: 237–251.
- Lavelle, P., Gilot, C., Fragoso, C. and Pashanasi, B. 1994. Soil fauna and sustainable land use in the humid tropics. In: Greenland, D.J. and Szabolcs, I. (eds), *Soil Resilience and Sustainable Land Use*. 291–300. CAB International, Wallingford.
- Lavelle, P. and Pashanasi, B. 1989. Soil macrofauna and land management in Peruvian Amazonia (Yurimaguas, Loreto). *Pedobiologia* **33**: 283–291.
- Lee, K.E. 1985. *Earthworms: Their ecology and relationships with land use*. Academic Press, Sydney.
- Lee, K.E. 1991. The diversity of soil organisms. In: Hawksworth, D.L. (ed.), *The Role of Biodiversity in Agricultural Systems*. 73–88. CAB International, Wallingford.
- Mbakaya, B.S., Blackburn, W.H., Skovlin, J.M. and Child, R.D. 1988. Infiltration and sediment production of a bushed grassland as influenced by livestock grazing systems, Buchama, Kenya. *Tropical Agriculture* **65**: 99–105.
- McGrath, S.P., Brookes, P.C. and Giller, K.E. 1988. Effects of potentially toxic metals in soil derived from past applications of sewage sludge on nitrogen fixation by *Trifolium repens*. *Soil Biology and Biochemistry* **20**: 415–424.
- Moore, T., Roulet, N. and Knowles, R. 1990. Spatial and temporal variations of methane flux from sub-Arctic/northern boreal fens. *Global Biogeochemical Cycles* **4**: 29–46.
- Mosier, A.R., Schimel, D.S., Valentine, D., Bronson, K.F. and Parton, W.J. 1991. Methane and nitrous oxide fluxes in native, fertilized and cultivated grasslands. *Nature* **350**: 330–332.
- Oldeman, L.R. 1994. The global extent of soil degradation. In: Greenland, D.J. and Szabolcs, I. (eds), *Soil Resilience and Land Use*. 99–118. CAB International, Wallingford.
- Paoletti, M.G., Pimentel, D., Stinner, B.R. and Stinner, D. 1992. Agroecosystem biodiversity: matching production and conservation biology. *Agriculture, Ecosystems and Environment* **40**: 3–23.
- Papendick, R.I. 1994. Maintaining soil physical conditions. In: Greenland, D.J. and Szabolcs, I. (eds), *Soil Resilience and Sustainable Land Use*. 215–234. CAB International, Wallingford.
- Parkin, T.B. 1987. Soil microsites as a source of denitrification variability. *Soil Science Society America Journal* **51**: 1194–1199.
- Peterjohn, W.T. and Correll, D.L. 1984. Nutrient dynamics in an agricultural watershed: observations on the role of a riparian forest. *Ecology* **65**: 1466–1475.
- Rayner, A.D.M. and Boddy, L. 1988. *Fungal Decomposition of Wood; Its biology and ecology*. John Wiley, Chichester.
- Ridge, E.H. 1976. Studies on soil fumigation. II. Effects on bacteria. *Soil Biology and Biochemistry* **8**: 249–253.
- Rosen, K., Gundersen, P., Tegnhammar, L. Johansson, M. and Frogner, T. 1992. Nitrogen enrichment of Nordic forest ecosystems. *Ambio* **21**: 364–368.
- Rovira, A.D. 1976. Studies on soil fumigation. I. Effects on ammonium, nitrate and phosphate in soil and on the growth, nutrition and yield of wheat. *Soil Biology and Biochemistry* **8**: 241–247.
- Schaefer, M. and Schauman, J. 1990. The soil fauna of a beech forests – comparison between a mull and moder soil. *Pedobiologia* **34**: 299–314.
- Spenser, T., Douglas, I. Greer, T. and Sinun, W. 1990. Vegetation and fluvial geomorphic processes in South East Asian Tropical rain forests. In: Thornes, J.B. (ed.), *Vegetation and Erosion*. 451–469. John Wiley, Chichester.
- Stuedler, P.A., Bowden, R.D., Melillo, J.M. and Aber, J.D. 1989. Influence of nitrogen fertilization on methane uptake in temperate forest soils. *Nature* **341**: 314–316.
- Swift, M.J. and Anderson, J.M. 1993. Biodiversity and ecosystem function. In: Schulze, E.-D. and Mooney, H.A. (eds), *Biodiversity and Ecosystem Function*. 15–41. Springer-Verlag, Heidelberg.
- Theng, B.K.G., Tate, K.R. and Sollins, P. 1989. Constituents of organic matter in temperate and tropical soils. In: Coleman, D.C., Oades, J.M. and Uehara, G. (eds), *Tropical Soil Organic Matter*. 5–32. University of Hawaii Press, Hawaii.
- Torsvik, V., Goksoyr, J. and Daae, F.L. 1990. High diversity of DNS of soil bacteria. *Applied and Environmental Microbiology* **56**: 782–787.
- Van Hooff, P. 1982. Earthworm activity as a cause of splash erosion in a Luxembourg forest. *Geoderma* **31**: 195–204.
- Verhoef, H.A. and Brussaard, L. 1990. Decomposition and nitrogen mineralization in natural and agroecosystems: the contribution of soil animals. *Biogeochemistry* **11**: 175–211.
- Vitousek, P.M. and Denslow, J.S. 1986. Nitrogen and phosphorus availability in tree fall gaps of a lowland forest. *Journal of Ecology* **74**: 1167–1178.
- Vitousek, P.M. and Hooper, D.U. 1993. Biological diversity and terrestrial ecosystem biogeochemistry. In: Schulze, E.-D. and Mooney, H.A. (eds), *Biodiversity and Ecosystem Function*. 3–14. Springer-Verlag, Heidelberg.
- Vitousek, P.M., Walker, L.R., Whiteaker, L.D., Mueller-Dombois, D., Matson, P.A. 1987. Biological invasion by *Myrica faya* alters ecosystem development in Hawaii. *Science* **238**: 802–804.
- Whalen, S.C., Reeburgh, W.S. and Sanbeck, K.A. 1990. Rapid

methane oxidation in landfill cover soil. *Applied and Environmental Microbiology* **56**: 3405–3411.

Whalen, S.C. and Reeburgh, W.S. 1990. Consumption of atmospheric methane by tundra soils. *Nature* **346**: 160–162.

Wood, T.G. 1991. Termites in Ethiopia: the environmental implications of their damage and resultant control measures. *Ambio* **20**: 136–138.

Wood, T.G., Johnson, R.A., and Ohiagu, C.E. 1977. Populations of termites (Isoptera) in natural and agricultural systems in southern Guinea savannah near Mokwa, Nigeria. *Geo Ecol Trop* **1**: 139–148.

World Resources Institute 1992–1993. *Towards Sustainable Development. A guide to the global environment*. WRI, Washington, DC.

6.2.3 Effects of biodiversity on water distribution and quality in ecosystems

6.2.3.1 Introduction

Water is essential to all living organisms, and in turn the biosphere plays a crucial role in the transportation, transformation and redistribution of water on local and regional scales. In terrestrial ecosystems, vegetation plays the primary role in transferring water from the soil to the atmosphere; plants and animals also have significant effects on the movement of water into the soil. In terrestrial systems, living organisms often regulate the magnitude and rate of flow of water from one site to another; similar effects occur in some aquatic ecosystems. In both terrestrial and aquatic systems the biota can have measurable impacts on water quality (e.g. on composition of solutes, abundance and nature of particulates). Unfortunately there are few experimental studies exploring the links between biodiversity and water. Clearly, though, differences among organisms and communities in physiology, phenology and structure determine the type and magnitude of biotic effects. The text below summarizes some of the major influences of species and communities on water fluxes and water quality.

6.2.3.2 Distribution of water

In terrestrial ecosystems, precipitation landing in one place is either evaporated again into the atmosphere, absorbed or infiltrated into the soil, or transferred by surface flow as runoff to another spot on the landscape. At the landscape scale, the types, relative abundances, and relative spatial locations of ecosystem types affect the amount of water moving from one point to another. For example, diverse land-use and management practices in water catchments in South Africa have been shown to affect stream-flow behaviour differently by altering runoff surface and water storage capacity in different ways (Braune and Wessels

1981). Conversion of vegetation within a watershed from forest or shrubland to grassland is known to have both short- and long-term effects on stream flow out of the watershed, in both temperate and tropical systems (Knight *et al.* 1985; Heimsath 1993); these effects could be due both to differences in the balance between infiltration and run-off, and to differences in the water use of the different communities (see discussion of evapotranspiration, below). In stream ecosystems, the presence of tree species can influence the rate of water flow with consequent effects on hydrology, sedimentation and stream channel structure (Graf 1978; Blackburn *et al.* 1982). Similarly, the presence of coral reefs offshore, and of estuarine or coastal vegetation, moderates the energy of water and reduces erosive action along shorelines (Walsh 1967; Twilley 1988). Lagoons within 'closed' coral atolls experience different water circulation, nutrient dynamics and productivity than do waters adjacent to 'open' reefs (Birkeland 1987).

Biodiversity at the scale of functional groups or species also plays an important role in determining the distribution and rate of movement of water. In terrestrial systems, differences in canopy and stem architecture among plants result in differences in the amount of precipitation intercepted, the proportion of precipitation converted to stem-flow, and the proportion of precipitation that infiltrates the soil rather than running off. For example, in arid lands a vegetative cover of shrubs has a very different effect from one of grasses: a semi-arid grassland has relatively homogeneous, complete capture of precipitation leading to shallow infiltration, while a shrubland has bare areas with high runoff interspersed with other areas where stem-flow leads to deep percolation (Schlesinger *et al.* 1990). Among woody species in semi-arid systems, differences in, for example, stem angle and leaf display lead to differences in the impact energy of precipitation (throughfall), and in infiltration rates, etc. (Nulsen *et al.* 1986; Wood *et al.* 1987; Navar and Bryan 1990). The movement of water through lotic (flowing) systems may also be affected by species differences. Water flow in streams moving through coniferous forests is more frequently slowed by large logs in the stream bed, with resulting influences on water chemistry, temperature and invertebrate communities (Bilby and Likens 1980), because of the slow decomposition of conifer wood relative to that of deciduous hardwood (Molles 1982). Other organisms redistribute moisture in even more subtle ways: Keeley and Swift assert that oaks on coastal slopes in Mediterranean climates act to collect fog and dew, which significantly increases water availability at the site. Even single animal species can affect water distribution: for example, the presence or absence of beavers in northern forest ecosystems creates extremely different distributions of surface waters (Naiman *et al.* 1994).

6.2.3.3 Groundwater fluxes

The movement of water from the atmosphere and shallow soil layers to deeper portions of the soil profile is an important determinant of the structure and function of a terrestrial ecosystem, and also influences the 'loss' or leaching of nutrients from the surface layers of the soil. This flux to the groundwater, and removals from that groundwater which serve as sources of water elsewhere, is largely regulated at the functional group scale of plant diversity. Addition or removal of trees and phreatophytes (plants whose deep root systems reach the water table) has the capacity to alter the depth of the water table locally. For example, in Australia an introduced pathogen has killed trees and shrubs, reducing evapotranspiration and causing a rise in the water table (Shea *et al.* 1975). Deliberate removal of woody vegetation (to be replaced by seasonal agriculture) in Australia has resulted in a similar reduction of evapotranspiration, raising the water table, and salinization over large regions (McFarlane *et al.* 1993; Lyons *et al.* 1993). Reduced diversity of landscapes and of plant growth forms has reduced the systems' ability to absorb and buffer storms, so that peak flows after extreme precipitation events have increased (Nulsen *et al.* 1986; McFarlane *et al.* 1993). Species differences within a functional group can be significant: for example, the phreatophytic invader *Tamarix* has the ability to draw water from unsaturated alluvial soil, an ability missing in native phreatophytic trees of the southwestern USA (Busch *et al.* 1992). This difference affects the species' relative competitive abilities as well as their overall effect on soil and stream hydrology. Other examples of species' or functional group differences influencing flux to the groundwater come from the forestry and watershed management literature; for example, conversion of deciduous forest to conifers can reduce the flow of water to the groundwater (Schulze 1982), in part because interception of precipitation (and subsequent loss to evaporation) is greater (Swift *et al.* 1975). Hamilton and King (1983) reviewed the conflicting reports that changes in tropical forest cover did (or did not) alter groundwater percolation and streamflows.

Animal functional groups are important to groundwater fluxes as well: for example, the earthworms (which can be divided into different sub-groups by soil depth) are responsible for aeration and porosity in soils, which in turn affect the water storage capacity of the profile and the infiltration rates (Al Addan 1990; Joschko *et al.* 1992; Smettem 1992). Agricultural activities also have altered or reduced the soil macrofauna in many areas, changing the impacts of animals on the physical properties of soil profiles (including porosity; e.g. Abbott *et al.* 1979; Lobry de Bruyn 1990). In semi-arid and arid zones, where earthworms may be unimportant, termites and ants play a similar role (see Section 6.2.2). Plots of semi-desert where

ants and termites had been removed have demonstrated long-term decreases in infiltration and increases in runoff (Elkins *et al.* 1986; Whitford 1991).

6.2.3.4 Evapotranspiration

The transfer of water from the substrate to the atmosphere by vegetation is undoubtedly the single largest flux from biosphere to atmosphere (Schlesinger 1991). Carbon dioxide cannot be fixed into primary production without the loss of water molecules from the leaves of plants. At the functional group level, the phenology, root structure and physiology of plants have direct implications for the amount and timing of water transfer to the atmosphere via transpiration. For example, tilling and the resultant changes in *fynbos* vegetation (including a reduction of plant species diversity) resulted in greater moisture content in the soil during summer months (Davis 1992). Plant functional groups may influence water flux to the atmosphere even in aquatic systems. The presence of a surface aquatic macrophyte, the invasive water hyacinth, results in leafy cover over the lake surface, which decreases surface evaporation but greatly increases transpirational losses (due to the great surface area of mesophyll). The net balance between the two processes can alter water levels. In terrestrial systems, diversity of root morphology and depth (including the tendency of some species to form roots at or even above the soil surface) results in the extraction of soil moisture from different parts of the soil profile, and thus more complete exploitation of received precipitation (e.g., Patric 1961; Dodd *et al.* 1984; Knoop and Walker 1985; Sala *et al.* 1989; Golluscio and Sala 1993). Differences in the depth of rooting zones and thus of water use result in differences in the depth of carbonate deposition in arid land soils (Schlesinger *et al.* 1987). Diversity at the species level may also be important. Within a group of plants, individual species differ in their resistance to water loss, their efficiency of water uptake from the soil, and so on. Even genetic diversity can have measurable effects: in agricultural ecosystems, varietal differences in water use efficiency, stomatal resistance and the like are the focus of selection in some crop breeding programmes. Certainly at a landscape level, evaporation/transpiration from one ecosystem or patch can have an effect on microclimate (especially relative humidity) downwind. It has even been suggested that inputs of moisture by transpiration are significant enough to increase local probability of precipitation (Anthes 1984). Work in the Amazon Basin suggests that roughly half of local precipitation is derived from moisture transpired locally (the rest coming from oceanic air masses), and that forest vegetation also contributes by intercepting moisture that would not otherwise fall as precipitation; thus deforestation is expected to decrease local moisture availability considerably (Franken and Leopoldo 1984; Salati 1985).

Effects on the hydrological cycle may be indirect as well: climate models suggest that the effect of boreal forest in warming the soil (compared with bare soil or with tundra vegetation) regulates formation of permafrost, snow accumulation and persistence, and soil moisture (Bonan *et al.* 1992).

6.2.3.5 Filtration and assimilative capacity

Biological organisms also serve to alter water quality by performing various filtration, uptake or excretory processes, all of which affect the composition and concentration of various dissolved gases, solutes and particulates. Diversity at the landscape scale (that is, the types, relative abundances, and relative spatial locations of ecosystem types) affects the quality of water moving from one point to another. For example, the width of strips of native vegetation bordering a stream in an agricultural area will affect the sediment and nutrient loads in runoff reaching the stream (Peterjohn and Correll 1984), suggesting that the presence of belts of riparian vegetation in a largely agricultural landscape is important in limiting the eutrophying effects of agricultural runoff into freshwater ecosystems. Changes in landscape structure in dry tropical forest increase runoff, erosion and nutrient loss in runoff (Maass *et al.* 1988). Beaver activity determines the inundation of land in the Great Lakes region of North America, with consequent changes to nutrient cycling, sediment accretion, aeration and other properties of flowing water (Naiman *et al.* 1988). In shallow coastal marine areas, seagrass beds are known to serve as buffers, minimizing the sediment and nutrient loads that reach coral reefs from eutrophied waters (Ogden and Gladfelter 1983; Ogden 1988). Estuarine and floodplain vegetation is known to exert a strong influence on the chemical composition of water (e.g. Amazon River: Junk and Furch 1985; estuarine mangroves: Twilley 1988). At the level of functional groups and of species, a diversity of uptake mechanisms and metabolic pathways (in both plants and microbial assemblages) allows more complete and efficient processing of nutrients and pollutants. There is a burgeoning industry pursuing the use of wetland communities (both natural and 'constructed') for the treatment of water pollution (Tourbier and Pierson 1976). There is ample documentation of the effects of species-level differences on water quality in aquatic systems. For example, there were differences among tree species and among nutrients for the uptake of N and P from waste water 'processed' by cypress swamps in Florida (Ewel and Odum 1986), and the presence of floating macrophytes was an important additive effect. Introductions of non-native macrophytes can affect lake chemistry significantly (Lodge *et al.* 1988). Differences among species of mangroves result in differences in the decomposition of organic matter and thus shifts in the balance between particulate organic carbon and

dissolved organic carbon (Boto and Bunt 1981; Snedaker 1989). On a smaller scale, *Sphagnum* mosses are known for their ability to pump cations from surrounding water, thus regulating water pH and quality (Hutchinson 1975). Species effects may be significant in terrestrial systems too; where pollution has altered the abundance or the composition of trees, forested ecosystems have exhibited alterations of groundwater quality (Schulze *et al.* 1989; Last and Watling 1991).

6.2.3.6 Trophic cascades and other biotic influences on water quality

Consumption and trophic patterns of primary consumers and secondary consumers also represent the influences of biodiversity at the functional group/species level. In lakes without fishery exploitation, the fish assemblage will be dominated by large individuals; smaller, zooplanktivorous fish will be strongly regulated by predation. Then predation on zooplankton is light; these attain high densities and effectively regulate phytoplankton. With heavy fishery exploitation, though, the fish community becomes dominated by smaller individuals with varying levels of zooplanktivory. The net result is an increase in algal biomass, sometimes causing blooms and water quality problems (Carpenter *et al.* 1985; Carpenter and Kitchell 1993). A similar story involves the introduction of Nile Perch to Lake Victoria, resulting in the elimination of many native cichlid fishes, a disruption of local fishery patterns, an increase in algal blooms, and eventually increased erosion from surrounding landscapes due to altered patterns of fuelwood consumption for drying the larger fish (Ogutu-Ohwayo 1990; Witte *et al.* 1992). The composition of the fish community ultimately determines whether the system's productivity is limited by nitrogen or by phosphorus (Elser *et al.* 1988; Carpenter and Kitchell 1993).

Human activity (particularly nutrient enrichment) has apparently increased the incidence of toxic blooms of algae (e.g. red tides, flagellate outbreaks) in shallow seas. These species-level effects in turn have dramatic effects on water quality and on fisheries (higher trophic levels), as well as on the shellfish industry (Smayda 1990, 1992). Another example of a species-level impact is the invasion of zebra mussels into North American lakes and rivers, where the rapid population growth of this filter-feeding mollusc has affected food particle density and the abundance and diversity of native filter-feeding organisms (Nalepa and Schloesser 1992).

6.2.3.7 Summary and implications

Because of the great magnitude of the transpiration flux through vegetation, and because of the diversity of plant physiology and water use, changes in the diversity of vegetation at almost any scale can have dramatic effects on

the rate of movement of water from the soil into the atmosphere (with resulting impacts on soil and atmospheric water content). Diversity of the biota at the functional group level can also have significant impacts on the movement of water in the opposite direction, into the soil. And because water availability is such a basic constraint to primary productivity and other facets of ecosystem functioning, considerations of potential impacts should accompany any actions that could have the effect of altering vegetative cover or soil macro-organisms. In aquatic systems, organisms affect water quality more than distribution (although there are biotic influences on the hydrology and geomorphology of streams). In most cases a greater diversity of biological organisms leads to a higher water quality, as perceived by humans, and in this sense aquatic biota (from microbes to fish and macrophytes) perform valuable ecosystem services. While the appropriate comparisons have not yet been made, current understanding allows several predictions about the relative impact of biodiversity alterations on water distribution and quality in different ecosystem types:

- Effects of biodiversity changes on local water distribution are predicted to be greatest in arid and semi-arid systems, for several reasons: the low availability of water in general, the large effects of organisms in regulating infiltration and surface flow, and the relatively low diversity of functional groups and of species within functional groups. Similarly, the magnitude of biodiversity effects on water flow in aquatic systems will probably be in inverse proportion to the magnitude of water flow itself (i.e. greater in small streams than in large open-water seas).
- Biodiversity effects on groundwater flux (especially the presence or absence of phreatophytes in the vegetation) are predicted to be important in almost any terrestrial system where precipitation exceeds potential evapotranspiration and there is significant flow of water from the soil profile into the groundwater.
- Biodiversity effects on evapotranspiration at the landscape scale are probably more dependent on geography than on biome type. That is, the effects are predicted to be most significant where (1) climate allows the development of sufficient vegetation to maintain high rates of transpiration, and (2) regional geography results in local moisture supply being significant in relation to moisture transported by air masses from distant regions.
- An important question to be addressed is whether water quality is most affected by biodiversity where biomass (or some other index of the rate of biological

activity) is high relative to the volume of water. That is, one might argue that the chemistry of water in a large lake will be less sensitive to changes in biodiversity than in a small pond, or in the soil solution of a well-developed forest.

In summary, there is strong evidence that biological diversity at the level of functional groups has significant effects on major fluxes in the hydrological cycle (infiltration, percolation to the groundwater, evapotranspiration), with the magnitude of the flux usually being positively related to the number of functional groups represented. It is, however, premature to draw conclusions about the effects of different numbers of species within functional groups. Species-level differences in physiology can be more directly related to differences in their effects on water quality (which can be either positive or negative). We conclude that biological diversity plays a substantial role in the ecosystem services of water supply and filtration, so critical to human welfare.

References

- Abbott, I., Parker, C.A., and Sills, I.D.** 1979. Changes in abundance of large soil animals and physical properties of soils following cultivation. *Australian Journal of Soil Research* **17**: 343–353.
- Al Addan, F.** 1990. Biophysique du sol. Etude Quantitative de la Regulation, par le Travail Lombricien, des Propriétés Structurales en Milieu Méditerranéen. PhD, USTL, Montpellier.
- Anthes, R.A.** 1984. Enhancement of convective precipitation by mesoscale variations in vegetative covering in semiarid regions. *Journal of Climatology and Applied Meteorology* **23**: 541–554.
- Bilby, R.E. and Likens, G.E.** 1980. Importance of organic debris dams in the structure and function of stream ecosystems. *Ecology* **61**: 1107–1113.
- Birkeland, C. (ed.)** 1987. Comparison between Atlantic and Pacific tropical marine coastal ecosystems: community structure, ecological processes, and productivity. *UNESCO Reports in Marine Science* **46**.
- Blackburn, W.H., Knight, R.W. and Schuster, J.L.** 1982. Saltcedar influence on sedimentation in the Brazos River. *Journal of Soil and Water Conservation* **37**: 298–301.
- Bonan, G.B., Pollard, D. and Thompson, S.L.** 1992. Effects of boreal forest vegetation on global climate. *Nature* **359**: 716–718.
- Boto, K.G. and Bunt, J.S.** 1981. Tidal export of particulate organic matter from a Northern Australian mangrove system. *Estuarine, Coastal and Shelf Science* **13**: 247–250.
- Braune, E. and Wessels, H.P.P.** 1981. Effects of landuse on runoff from catchments and yield from present and future storage. In: Maaron, H. (ed.), *Workshop on the effect of rural land use and catchment management on water resources*. Department of Water Affairs, Pretoria **113**: 133–187.
- Busch, D.E., Ingraham, N.L. and Smith, S.D.** 1992. Water uptake in woody riparian phreatophytes of the southwestern United States: a stable isotope study. *Ecological Applications* **2**: 450–459.

- Carpenter, S.R., Kitchell, J.F. and Hodgson, J.R.** 1985. Cascading trophic interactions and lake productivity. *BioScience* **35**: 634–639.
- Carpenter, S.R. and Kitchell, J.F.** (eds) 1993. *The Trophic Cascade in Lakes*. Cambridge University Press, Cambridge.
- Davis, G.W.** 1992. Effects of tillage on heathland soil: disturbance of a natural mountain fynbos system in the southwestern Cape, South Africa. *Soil and Tillage Research* **24**: 29–45.
- Dodd, J., Heddle, E.M., Pate, J.S. and Dixon, K.W.** 1984. Rooting patterns of sandplain plants and their functional significance. In: Pate, J.S. and Beard, J.S. (eds), *Kwongan: Plant life of the sandplain*. 146–177. University of Western Australia Press, Nedlands.
- Elkins, N.Z., Sabol, G.V., Ward, T.J. and Whitford, W.G.** 1986. The influence of subterranean termites on the hydrological characteristics of a Chihuahuan desert ecosystem. *Oecologia* **68**: 521–528.
- Elser, J.J., Elser, M.M., MacKay, N.A., and Carpenter, S.R.** 1988. Zooplankton-mediated transitions between N- and P-limited algal growth. *Limnology and Oceanography* **33**: 1–14.
- Ewel, K.C. and Odum, H.T.** (eds) 1986. *Cypress Swamps*. University Presses of Florida, Gainesville.
- Franken, W. and Leopoldo, P.R.** 1984. Hydrology of catchment areas of Central-Amazonian forest streams. In: Sioli, H. (ed.), *The Amazon: Limnology and landscape ecology of a mighty tropical river and its basin*. 501–519. Dr W. Junk, Dordrecht.
- Golluscio, R.A. and Sala, O.E.** 1993. Plant functional types and ecological strategies in Patagonian forbs. *Journal of Vegetation Science* **4**: 839–846.
- Graf, W.L.** 1978. Fluvial adjustments to the spread of tamarisk in the Colorado Plateau region. *Geological Society of America Bulletin* **89**: 1491–1501.
- Hamilton, L.S. and King, P.N.** 1983. *Tropical Forested Watersheds: Hydrologic and soils response to major uses or conversions*. Westview Press, Boulder, Colorado.
- Heimsath, A.M.** 1993. A comparison of streamflow from agricultural and forested watersheds in the Middle Hills, Nepal. *Tropical Resources Institute News* **12**: 14–17.
- Hutchinson, G.E.** 1975. *A Treatise on Limnology*. Vol. III, *Limnological Botany*. John Wiley, New York.
- Joschko, M., Sochtig, W. and Larink, O.** 1992. Functional relationship between earthworm burrows and soil water movement in column experiments. *Soil Biology and Biochemistry* **24**: 1545–1543.
- Junk, W.J. and Furch, K.** 1985. The physical and chemical properties of Amazonian waters and their relationships with the biota. In: Prance, G.T. and Lovejoy, T.E. (eds), *Amazonia*. Key Environments Series. 3–17. Pergamon Press, Oxford.
- Keeley, J.E. and Swift, C.C.** 1995. Biodiversity and ecosystem functioning in mediterranean-climate California. In: Davis, G.W. and Richardson, D.M. (eds), *Mediterranean-type Ecosystems: Functions of biodiversity*. Ecological Studies Series. Springer-Verlag, Heidelberg.
- Knight, D.H., Fahey, T.J. and Running, S.W.** 1985. Water and nutrient outflow from contrasting lodgepole pine forests in Wyoming. *Ecological Monographs* **55**: 29–48.
- Knoop, W.T. and Walker, B.H.** 1985. Interactions of woody and herbaceous vegetation in a Southern African savannah. *Journal of Ecology* **73**: 235–253.
- Last, F.T. and Watling, R.** 1991. *Acid Deposition: Its nature and impacts*. The Royal Society of Edinburgh.
- Lobry de Bruyn, L.A.** 1990. *The role of ants and termites in modifying soil properties in naturally vegetated and agricultural environments*. PhD dissertation, University of Western Australia, Nedlands.
- Lodge, D.M., Barko, J.W., Strayer, D., Melack, J.M., Mittelbach, G.G., Howarth, R.W., Menge, B. and Titus, J.E.** 1988. Spatial heterogeneity and habitat interactions in lake communities. In: Carpenter, S.R. (ed.), *Complex Interactions in Lake Communities*. 181–208. Springer-Verlag, New York.
- Lyons, T.J., Schwerdtfeger, P., Hacker, J.M., Foster, I.J., Smith, R.C.G. and Xinmei, H.** 1993. Land-atmosphere interaction in a semiarid region: the bunny fence experiment. *Bulletin of the American Meteorological Society* **74**: 1327–1334.
- McFarlane, D.J., George, R.J. and Farrington, P.** 1993. Changes in the hydrological cycle. In: Hobbs, R.J. and Saunders, D.A. (eds), *Reintegrating Fragmented Landscapes: Towards sustainable production and nature conservation*. 146–186. Springer-Verlag, New York.
- Maass, J.M., Jordan, C. and Sarukhán, J.** 1988. Soil erosion and nutrient losses in seasonal tropical agroecosystems under various management techniques. *Journal of Applied Ecology* **25**: 595–607.
- Molles, M.C. Jr** 1982. Trichopteran communities of streams associated with aspen and conifer forests: long-term structural change. *Ecology* **63**: 1–6.
- Naiman, R.J., Johnston, C.A. and Kelley, J.C.** 1988. Alteration of North American streams by beaver. *BioScience* **38**: 753–763.
- Naiman, R.J., Pinay, G., Johnston, C.A. and Pastor, J.** 1994. Beaver influences on the long-term biogeochemical characteristics of boreal forest drainage networks. *Ecology* **75**: 905–921.
- Nalepa, T.F. and Schloesser, D.W.** 1992. *Zebra Mussels: Biology, impacts, and control*. Lewis Publishers, Boca Raton, Fla.
- Navar, J. and Bryan, R.** 1990. Interception loss and rainfall redistribution by three semi-arid growing shrubs in northeastern Mexico. *Journal of Hydrology* **115**: 51–63.
- Nulsen, R.A., Bligh, K.J., Baxter, I.N., Solin, E.J. and Imrie, D.H.** 1986. The fate of rainfall in a mallee and heath vegetated catchment in southern Western Australia. *Australian Journal of Ecology* **11**: 361–371.
- Ogden, J.C.** 1988. The influence of adjacent systems on the structure and function of coral reefs. *Proceedings of the 6th International Coral Reef Symposium* **1**: 123–129.
- Ogden, J.C. and Gladfelter, E.H.** (eds). 1983. Coral reefs, seagrass beds and mangroves: their interactions in the coastal zones of the Caribbean. *UNESCO Reprints in Marine Science* **23**.
- Ogutu-Ohwayo, R.** 1990. The decline of the native fishes of lakes Victoria and Kyoga (East Africa) and the impact of introduced species, especially the Nile perch, *Lates niloticus*, and the Nile tilapia, *Oreochromis niloticus*. *Environmental Biology of Fishes* **27**: 81–96.
- Patric, J.H.** 1961. The San Dimas large lysimeters. *Journal of Soil and Water Conservation* **16**: 13–17.
- Peterjohn, W.T. and Correll, D.L.** 1984. Nutrient dynamics in an

- agricultural watershed: observations on the role of a riparian forest. *Ecology* **65**: 1466–1475.
- Sala, O.E., Golluscio, R.A., Lauenroth, W.K., and Soriano, A.** 1989. Resource partitioning between shrubs and grasses in the Patagonian steppe. *Oecologia* **81**: 501–505.
- Salati, E.** 1985. The climatology and hydrology of Amazonia. In: Prance, G.T. and Lovejoy, T.E. (eds). *Amazonia*. Key Environments series. 18–48. Pergamon Press, Oxford.
- Schlesinger, W.H.** 1991. *Biogeochemistry: An analysis of global change*. Academic Press, San Diego.
- Schlesinger, W.H., Fonteyn, P.J. and Marion, G.M.** 1987. Soil moisture content and plant transpiration in the Chihuahuan desert of New Mexico. *Journal of Arid Environments* **12**: 119–126.
- Schlesinger, W.H., Reynolds, J.F., Cunningham, G.L., Huenneke, L.F., Jarrell, W.M., Virginia, R.A., and Whitford, W.G.** 1990. Biological feedbacks in global desertification. *Science* **247**: 1043–1048.
- Schulze, E.-D.** 1982. Plant life forms as related to plant carbon, water and nutrient relations. In: Lange, O.L., Nobel, P.S., Osmond, C.B., and Ziegler, H. (eds), *Encyclopedia of Plant Physiology. Physiological Plant Ecology*. Vol. 12B, *Water relations and photosynthetic productivity*. 615–676. Heidelberg, Berlin.
- Schulze, E.-D., de Vries, W., Hauhs, M., Rosen, K., Rasmussen, L., Tamm, C.O. and Nilsson, J.** 1989. Critical loads for nitrogen deposition on forest ecosystems. *Water, Air and Soil Pollution* **48**: 451–456.
- Shea, S.R. Hatch, A.B., Havel, J.J. and Ritson, P.** 1975. The effect of changes in forest structure and composition on water quality and yield from the northern Jarrah forest. *Proceedings of the Ecological Society of Australia* **9**: 58–73.
- Smayda, T.J.** 1990. Novel and nuisance phytoplankton blooms in the sea: evidence for a global epidemic. In: Granéli, E., Sundström, B., Edler, L. and Anderson, D.M. (eds), *Toxic Marine Phytoplankton*. 29–40. Elsevier, New York.
- Smayda, T.J.** 1992. Global epidemic of noxious phytoplankton blooms and food chain consequences in large ecosystems. In: Sherman, K., Alexander, L.M. and Gold, B.D. (eds), *Food Chains, Yields, Models, and Management of Large Marine Ecosystems*, 275–307. Westview Press, Boulder, Colorado.
- Smettem, K.R.J.** 1992. The relation of earthworms to soil hydraulic properties. *Soil Biology and Biochemistry* **24**: 1539–1543.
- Snedaker, S.C.** 1989. Overview of ecology of mangroves and information needs for Florida Bay. *Bulletin of Marine Science* **44**: 341–347.
- Swift, L.W., Swank, W.T., Mankin, J.B., Luxmoore, R.J., and Goldstein, R.A.** 1975. Simulation of evapotranspiration and drainage from mature and clearcut deciduous forests and young pine plantations. *Water Resources Research* **11**: 667–673.
- Tourbier, J. and Pierson P.W. Jr.** (eds). 1976. *Biological Control of Water Pollution*. University of Pennsylvania Press, Philadelphia.
- Twilley, R.R.** 1988. Coupling of mangroves to the productivity of estuarine and coastal waters. In: Jansson, B.O. (ed.) *Coastal-Offshore Ecosystem Interactions*. 155–180. Springer-Verlag, Berlin.
- Walsh, G.E.** 1967. An ecological study of a Hawaiian mangrove swamp. In: Lauff, G.H. (ed.), *Estuaries*. 420–431. AAAS Press, Washington, DC.
- Whitford, W.G.** 1991. Subterranean termites and long-term productivity of desert rangelands. *Sociobiology* **19**: 235–243.
- Witte, D., Goldschmidt, T., Goudswaard, P.C., Ligtoet, W., Oijen, M.J.P. and Wanink, J.H.** 1992. Species extinction and concomitant ecological changes in Lake Victoria. *Netherlands Journal of Zoology* **42**: 214–232.
- Wood, J.C., Wood, M.K. and Tromble, J.M.** 1987. Important factors influencing water infiltration and sediment production on arid lands in New Mexico. *Journal of Arid Environments* **12**: 111–118.

6.2.4 Atmospheric feedbacks

6.2.4.1 Introduction

The biosphere interacts with the atmosphere in various ways with respect to biodiversity and ecosystem functioning. As a source of atmospheric constituents the biosphere contributes significantly to the chemical composition of the atmosphere and thus has a strong influence on important atmospheric properties and, hence, on climate. Vice versa, changes of climate will have a strong feedback on ecosystem functioning and biodiversity, and thereby will influence biogenic emissions. Biogenic emissions of atmospheric constituents may be entirely dependent on a few species or a single functional group of species. As a consequence, particular ecosystem functions constitute a high environmental risk: minor changes in species composition will produce a direct feedback on atmospheric properties, which will then affect other aspects of ecosystem functioning and biodiversity. The term 'biodiversity risk' is used here for this pattern of biosphere/atmosphere interaction. As the biosphere is also the most important sink for numerous atmospheric constituents, the flux of injurious compounds from the atmosphere to the biosphere can reduce biodiversity and impair essential ecosystem functioning, which may then feed back into the atmosphere. The following text summarizes the biosphere/atmosphere interactions that can affect biodiversity and ecosystem functioning and/or constitute a high biodiversity risk.

6.2.4.2 Biogenic emissions and atmospheric properties

The biosphere is the most important source of several atmospheric trace constituents, including dimethylsulphide (DMS), carbonylsulphide (COS), methane (CH₄) and nitrous oxide (N₂O), as well as non-methane hydrocarbons such as terpenes and isoprene (Table 6.2-1). DMS is the major biogenic sulphur compound emitted by planktonic algae in marine environments (Barnard *et al.* 1982; Bates *et al.* 1987). In the atmosphere DMS is rapidly oxidized by OH radicals to form sulphate aerosols (Graedel 1979; Niki *et al.* 1983) which are the most important source of cloud

condensation nuclei (CCN) in the marine atmosphere and thus have a strong influence on the type and abundance of clouds over the oceans (Charlson *et al.* 1987). Since the growth of planktonic algae is highly dependent on environmental conditions, DMS emissions from the open oceans are considered a regulatory factor of the climate that can feed back on biodiversity and ecosystem functioning. Although many marine algae contain and release significant amounts of DMS (Keller *et al.* 1989), high rates of production and emission are restricted to a few classes of marine phytoplankton (mainly Dinophyceae and Prymnesiophyceae). As a consequence, high DMS concentrations in marine water ('hot spots') are superimposed on relatively constant concentration levels of 1–3 nM and result from blooms of certain species, e.g. *Phaeocystis poucheti* (Bates *et al.* 1987; Berresheim *et al.* 1989; Saltzman and Cooper 1989). Therefore, DMS emissions and, hence, CCN formation over the open oceans constitute a high biodiversity risk. DMS is also emitted from terrestrial ecosystems (Rennenberg 1991); however, it will not have a significant impact on cloud formation over the continents because of the high CCN formation by the oxidation of sulphur dioxide (SO₂) emitted by fossil fuel burning (Schwartz 1988; Wigley 1989).

The relatively long-lived biogenic sulphur compound COS and its atmospheric precursor CS₂ (Jones *et al.* 1983;

Hynes and Wine, 1989) represent the major sources of sulphur in the stratosphere (Crutzen 1976; Lazrus and Gandrun 1977; Inn *et al.* 1979; Khalil and Rasmussen 1984; Hofman 1990). Oxidation of COS in the stratosphere results in the production of sulphate aerosols (Lazrus and Gandrun 1977), which influence the Earth's radiation budget by scattering sunlight back into space and interfere with stratospheric ozone (Hofman 1990). Therefore, biogenic emission of COS and CS₂ contributes to climate as well as to the intensity and spatial distribution of UV-B radiation reaching the Earth's surface (Charlson *et al.* 1987) which will feed back on biodiversity and ecosystem functioning. In marine environments, COS and CS₂ emission is dominated by coastal environments that are considered highly vulnerable to anthropogenic disturbance (Aneja *et al.* 1979). Emission of COS from terrestrial ecosystems seems to be restricted to bare soils. COS released from vegetated soils is rapidly taken up and metabolized by vegetation and thus does not reach the atmosphere (Rennenberg 1991). Recent requirements for sulphur fertilization in agroecosystems due to the prolonged use of low-sulphur fertilizers, and the increasing cultivation of high-sulphur crops such as rape, may be linked to increasing biogenic emissions of COS (Hofman 1990) which now constitute a significant biodiversity risk.

Next to CO₂, CH₄ is presently thought to be the most

Table 6.2-1: Biogenic emissions affecting atmospheric properties.¹

Biome	DMS ²	COS ³	CH ₄ ⁴	N ₂ O ⁵	Terpenes ⁶	Isoprene ⁶
Mediterranean-type			+		+++	++
Tropical forest			+		++	++
Savannahs			+			
Arctic alpine			++		++	?
Coral reefs						
Islands						
Coastal systems	+	+++				
Temperate forest				++	++	++
Temperate grasslands			+++			
Agroecosystems		++	+++	++		
Lakes and rivers						
Open ocean	+++					
Boreal forests			++		++	++
Estuaries, lagoons and mangroves	+	+++				

1. The number of (+) indicates differences in the source strength of biomes for individual trace gases.

2. Barnard *et al.* 1982; Bates *et al.* 1987; Keller *et al.* 1989; Berresheim *et al.* 1989; Saltzman and Cooper 1989;

3. Aneja *et al.* 1979; Rennenberg 1991;

4. Heyer 1990; Schutz *et al.* 1991; Green 1992; Wassmann *et al.* 1993;

5. Papen and Rennenberg 1990; Bouwman *et al.* 1993; Papen *et al.* 1993;

6. Monson *et al.* 1991; Tingey *et al.* 1991.

important greenhouse gas (IPCC 1992) and is released into the atmosphere predominantly from biogenic sources (IPCC 1992). Biogenic CH_4 production is mediated by a single functional group of approximately 100 species of bacteria that require strictly anaerobic conditions (Heyer 1990). Therefore, biogenic CH_4 emission is restricted to anaerobic environments, i.e. natural and human-made wetlands such as rice paddy fields and the digestive tracts of ruminants and termites (IPCC 1992). Many other biomes may become transient sources of atmospheric CH_4 when temporarily flooded. The actual amount of methane emitted is not only dependent on CH_4 production, but also on CH_4 oxidation in aerobic zones of the corresponding environment: CH_4 oxidation by methylotrophic bacteria, a functional group of approximately 25 species (Green 1992), may consume as much as 80% of the CH_4 produced (Wassmann *et al.* 1993). In vegetated wetland soils, CH_4 is released into the atmosphere mainly via transport through the aerenchyma of the plants which may provide resistance to the CH_4 flux (Schutz *et al.* 1991). Thus, CH_4 emission from wetlands is determined by the balance of microbial populations and their interaction with vegetation. Because of the low number of species involved, this balance is highly vulnerable to disturbance at the ecosystem functioning and landscape diversity level.

Another important greenhouse gas is N_2O . It is accumulating in the atmosphere at an increasing rate (IPCC 1992) and may therefore become even more important in the future. Global N_2O production has almost doubled within the last 100 years by anthropogenic activities, and because of the long (150-year) residence time of N_2O in the atmosphere, the atmospheric N_2O concentration will only stabilize in about 250 years from now, even if N_2O production were to be maintained at the present level. As for CH_4 , a major part of the atmospheric N_2O is of biogenic origin (IPCC 1992): it is produced in aerobic soils by chemolithotrophic and heterotrophic nitrification and in anaerobic soils by denitrification (Papen and Rennenberg 1990; Bouwman *et al.* 1993), but may also originate from other processes so far not identified (Papen *et al.* 1993). As N_2O emission is dependent on the availability of substrates for these processes, biomes that are exposed to high loads of nitrogen by direct application of N-fertilizer (e.g. agroecosystems) or by its incidental input through the atmosphere via dry and wet deposition (e.g. temperate forests) are major sources of biogenic N_2O (IPCC 1992; Papen *et al.* 1993). In addition to interfering with ecosystem functioning and biodiversity by climate forcing, N_2O emission also constitutes a biodiversity risk, as chemolithotrophic nitrification is restricted to a small number of microbial species (Papen and Rennenberg 1990).

Volatile organic compounds, especially terpenes and isoprene, are produced and released into the atmosphere by

a large number of plant species (Monson *et al.* 1991; Tingey *et al.* 1991), especially by woody plants including Mediterranean shrubs, eucalypts and conifers which determine particular landscape patterns in several biomes (Table 6.2-1). This heterogeneous group of volatile compounds affects the chemical composition of the atmosphere by controlling the oxidation capacity of the troposphere (Chameides *et al.* 1988). Changes in the photo-oxidation capacity of the atmosphere will influence the abundance and the distribution of other radiative trace constituents such as ozone. Apparently, terpene emissions are dominated by *Pinus* species which constitute a functional group for the emission of these atmospheric trace gases (Tingey *et al.* 1991).

6.2.4.3 Fluxes of atmospheric constituents into the biosphere

The biosphere is not only a source, but also a sink of radiatively active trace gases and atmospheric pollutants. Depositions of atmospheric sulphur and nitrogen compounds of anthropogenic origin severely affect biodiversity and ecosystem functioning in temperate and boreal forests and grasslands, as well as in lakes and rivers, by acidifying of water and soils and unbalancing nitrogen and sulphur nutrition (Lauenroth and Preston 1984; Reuss and Johnson 1986; Schulze *et al.* 1989; Wellburn 1990; Pearson and Stewart 1993; Rennenberg and Polle 1994). In particular, the diversity and abundance of ectomycorrhizal fungi and lichens can be reduced in the presence of atmospheric sulphur and nitrogen compounds (Kozłowski 1985; McCool 1987). Air pollution by photochemical oxidants can cause severe species-specific damage in agroecosystems and horticulture (Guderian *et al.* 1985). Deposition of atmospheric pollutants also affects the diversity and functioning of microbial populations in the soil and, as a consequence, changes interactions between the soil and the atmosphere as feedback reactions. Acidification of forest soils eliminates chemolithotrophic nitrification, a significant source of atmospheric N_2O (Johnsrud 1978; Papen *et al.* 1993). Nitrogen input into forest soils reduces the oxidation of atmospheric methane and, thus, the sink strength of forest soils for this radiatively active trace gas (Keller *et al.* 1983; Steudler *et al.* 1989).

6.2.4.4 Climate change and biosphere/atmosphere interactions at the level of biodiversity and ecosystem functioning

The depletion of stratospheric ozone with the consequence of increasing UV-B radiation and the increase in radiatively active trace gases in the atmosphere with the consequence of global warming are considered to be the most important changes in climate presently occurring (German Bundestag 1989). Increasing UV-B radiation will have direct effects

on biosphere/atmosphere interactions at the level of biodiversity and ecosystem functioning. Impairment of photosynthesis, nitrogen metabolism and orientation of marine phytoplankton by enhanced UV-B radiation (Tevini 1994) may affect DMS emission into the marine atmosphere, and hence CCN formation, an important factor in the global climate. In particular, the generation of hot-spots of DMS emission connected with the blooming of a few classes of marine phytoplankton may be a sensitive process. Changes in marine phytoplankton will also affect marine food chains and thus the vertical flux of atmospheric CO₂ into the deep ocean layers (biogenic CO₂ pump). This will in turn have a severe impact on the atmospheric CO₂ concentration, and hence on climate. In terrestrial ecosystems, increasing UV-B radiation may affect not only biogenic emission from sensitive vegetation (Tevini 1994), but also the production and emission of radiatively active trace gases by nitrification in the upper soil (Hooper and Terry 1974; Endo *et al.* 1986). As biogenic emissions are temperature-dependent processes, global warming is expected generally to increase the biogenic production of atmospheric trace constituents, which will cause a significant negative feedback on global warming. Species-specific responses and interactions with ecosystem functioning have to be expected as a direct consequence of elevated atmospheric CO₂. Functional studies and model estimations indicate that changes in growth rates and biomass production due to elevated CO₂ levels are dependent on environmental factors such as nutrient supply and climate and differ between species (Jarvis 1989; Mooney *et al.* 1991; Woodward *et al.* 1991; Bazzaz and Fajer 1992; Gilford 1992; Bowes 1993; Korner 1993). These factors will also affect ecosystem functioning at increasing atmospheric CO₂ concentrations and, hence, the sink and source strength of the biosphere for atmospheric trace constituents.

6.2.4.5 Conclusions and management implications

The biosphere is an essential factor in determining the budget, abundance and distribution of the most important environmentally relevant trace gases in the atmosphere. As these atmospheric constituents play a central role in global climate, changes in the source or sink strength of the biosphere will strongly affect biodiversity and ecosystem functioning. In addition, the emission of atmospheric trace gases by, and their deposition in, the biosphere is itself an important ecosystem function, highly dependent on biodiversity. The prevention of changes in ecosystem functioning and biodiversity that will affect the composition of the atmosphere is likely to be one of the most important environmental policy issues of the immediate future. To support policy decisions in this direction, intensive research is required on biosphere/atmosphere exchange processes and their

interaction with ecosystem functioning and biodiversity. Studies on soil microbial/atmosphere interactions may be of particular significance in this respect.

References

- Aneja, V.P., Overton, J.H., Cupitt, L.T., Durham, L.J. and Wilson, L.E. 1979. Carbon disulphide and carbonyl sulphide from biogenic sources and their contribution to the global sulphur cycle. *Nature* **282**: 493–496.
- Barnard, W.R., Andreae, M.O., Watkins, W.E., Bingemer, H. and Georgii, H.W. 1982. The flux of dimethylsulfide from the oceans to the atmosphere. *Journal of Geophysical Research* **87**: 8787–8793.
- Bates, T.S., Cline, J.D., Gammon, R.H. and Kelley-Hansen, S.R. 1987. Regional and seasonal variations in the flux of oceanic dimethylsulfide to the atmosphere. *Journal of Geophysical Research* **92**: 2930–2938.
- Bazzaz, F.A. and Fajer, E.D. 1992. Plant life in a CO₂-rich world. *Scientific American* **266**: 68–74.
- Berreshein, H., Andreae, M.O., Ayers, G.P. and Gillet, R.W. 1989. Distribution of biogenic sulfur compounds in the remote southern hemisphere. In: Saltzman, E.S. and Cooper, W. J. (eds), *Biogenic Sulfur in the Environment*. 352–366. American Chemical Society, Washington, DC.
- Bouwman, A.F., Fung, I., Matthews, E. and John, J. 1993. Global analysis of the potential for N₂O production in natural soils. *Global Biogeochemical Cycles* **7**: 557–597.
- Bowes, G. 1993. Facing the inevitable: plants and increasing atmospheric CO₂. *Annual Review of Plant Physiology and Plant Molecular Biology* **44**: 309–332.
- Chameides, W.L., Lindsay, R.W., Richardson, J. and Kiang, C.S. 1988. The role of biogenic hydrocarbons in urban photochemical smog: Atlanta as a case study. *Science* **241**: 1473–1475.
- Charlson, R.J., Lovelock, J.E., Andreae, M.O. and Warren, S.G. 1987. Oceanic phytoplankton, atmospheric sulphur, cloud albedo and climate. *Nature* **326**: 655–661.
- Crutzen, P.J. 1976. The possible importance of COS for the sulfate layer of the stratosphere. *Geophysical Research Letters* **3**: 73–76.
- Endo, M., Minami, K., and Fukushi S 1986. Effects of the interception of near ultraviolet radiation on nitrifier activity and nitrification process in a fertilized andosol under field conditions. *Soil Science Plant Nutrition* **32**: 365–372.
- German Bundestag 1989. *Protecting the Earth Atmosphere. An International Challenge*. Universitäts-Buchdruckerei, Bonn.
- Gifford, R.M. 1992. Interaction of carbon dioxide with growth-limiting environmental factors in vegetation productivity: implications for the global carbon cycle. *Advances in Bioclimatology* **1**: 24–58.
- Graedel, T.E. 1979. Reduced sulfur emission from the open oceans. *Geophysical Research Letters* **6**: 329–331.
- Green, P.N. 1992. Taxonomy of methylotrophic bacteria. In: Murrell, J. C. and Dalton, H. (eds), *Methane and Methanol Utilizers*. 23–84.
- Guderian, R., Tingey, T.D. and Rabe, R. 1985. Effects of

- photochemical oxidants on plants. In: Guedrian, R. (ed.) *Air Pollution by Photochemical Oxidants*. 129-296. Springer-Verlag, Berlin.
- Heyer, J.** 1990. *Der Kreislauf des Methans*. Akademie-Verlag, Berlin.
- Hofman, D.J.** 1990. Increase in stratospheric background of sulfuric acid aerosol mass in the past 10 years. *Science* **248**: 996-1000.
- Hooper, A.B.** and Terry, K.R. 1974. Photoinactivation of ammonium oxidation in *Nitrosomonas*. *Journal of Bacteriology* **119**: 899-906.
- Hynes, A.J.** and Wine, P.H. 1989. OH-initiated oxidation of biogenic sulfur compounds: kinetics and mechanisms under atmospheric conditions. In: Satzman, E.S. and Cooper, W.J. (eds), *Biogenic Sulfur in the Environment*. 424-436. American Chemical Society, Washington, DC.
- Inn, E.C.Y., Vedder, J.F.** and Tyson, B.J. 1979. COS in the stratosphere. *Geophysical Research Letters* **6**: 191-193.
- Intergovernmental Panel on Climate Change** 1992. Houghton, J.T., Callandar, S.K. and Varney, S.K. (eds), *Climate Change 1992 - The Supplementary Report to the IPCC Scientific Assessment*. Cambridge University Press, Cambridge.
- Jarvis, P.G.** 1989. Atmospheric carbon dioxide and forests. *Philosophical Transactions of the Royal Society of London* **324**: 369-392.
- Johnsrud, S.C.** 1978. Heterotrophic nitrification in acid forest soils. *Holarctic Ecology* **1**: 27-30.
- Jones, B.M.R., Cox, R.A.** and Penkett, S.A. 1983. Atmospheric chemistry of carbon disulphide. *Journal of Atmospheric Chemistry* **1**: 65-86.
- Keller, M.D., Bellows, W.K.** and Guillard, R.R.L. 1989. Dimethyl sulfide production in marine phytoplankton. In: Saltzman, E.S. and Cooper, W.J. (eds), *Biogenic Sulfur in the Environment*. 167-182. American Chemical Society, Washington, DC.
- Keller, M., Goreau, T.J., Woffsy, S.C., Kaplan, W.A.** and McElroy, M.B. 1983. Production of nitrous oxide and consumption of methane by forest soils. *Geophysical Research Letters* **10**: 1156-1159.
- Khalil, M.A.K.** and Rasmussen, R.A. 1984. Global sources, lifetimes and mass balance of carbonyl sulfide (OCS) and carbon disulfide (CS₂) in the earth's atmosphere. *Atmos. Environ.* **18**: 1805-1813.
- Körner, Ch.** 1993. CO₂ fertilization: the great uncertainty in future vegetation development. In: Solomon, A.H. and Shugart, H.H. (eds), *Vegetation Dynamics and Global Change*. 53-70. Chapman and Hall, New York.
- Kozlowski, T.T.** 1985. SO₂ effects on plant community structure. In: Winner, W.E., Mooney, H.A. and Goldstein, R.A. (eds), *Sulfur Dioxide and Vegetation. Physiology, ecology, and policy issues*. 431-453. Stanford University Press, Stanford, Calif.
- Lauenroth, W.K.** and Preston, E.M. 1984. *The Effects of SO₂ on a Grassland. A Case Study in the Northern Great Plains of the United States*. Springer-Verlag, New York.
- Lazrus, A.L.** and Gandrun, B.W. 1977. Stratospheric sulfate at high altitudes. *Geophysical Research Letters* **4**: 521-522.
- McCool, P.M.** 1987. Effect of air pollutants on mycorrhizae. In: Schulte-Hostede, S., Darrall, N.M., Blank, L.W. and Wellburn, A.R. (eds), *Air Pollution and Plant Metabolism*. 356-365. Elsevier, London.
- Monson, R.K., Guenther, A.B.** and Fall, R. 1991. Physiological reality in relation to ecosystem- and global-level estimates of isoprene emission. In: Sharkey, T.D., Holland, E.A. and Mooney, H.A. (eds), *Trace Gas Emissions by Plants*. 185-207. Academic Press, San Diego.
- Mooney, H., Drake, B., Luxmoore, W., Oechel, W.** and Pitelka, L.F. 1991. Predicting ecosystem response to elevated CO₂ concentrations. *BioScience* **41**: 96-104.
- Niki, H., Maker, P.D., Savage, C.M.** and Breitenbach, L.P. 1983. An FTIR study of the mechanism for the reaction HO + CH₃SCH₃. *International Journal of Chem Kinet.* **15**: 647-654.
- Papen, H.** and Rennenberg, H. 1990. Microbial processes involved in emissions of radiatively important trace gases. In: *Transactions of the 14th International Congress of Soil Science*, Vol. II, Kyoto. 232-237.
- Papen, H., Hellmann, B., Papke, H.** and Rennenberg, H. 1993. Emission of N-oxides from acid irrigated and limed soils of a coniferous forest in Bavaria. In: Oremland, R.S. (ed.), *Biogeochemistry of Global Change. Radiatively active trace gases*. 245-260. Chapman and Hall, London.
- Pearson, J.** and Stewart, G.R. 1993. The deposition of atmospheric ammonia and its effects on plants. *New Phytologist* **125**: 283-305.
- Rennenberg, H.** 1991. The significance of higher plants in the emission of sulfur compounds from terrestrial ecosystems. In: Sharkey, T.D., Holland, E.A. and Mooney, H.A. (eds), *Trace Gas Emissions by Plants*. 217-260. Academic Press, San Diego.
- Rennenberg, H.** and Polle, A. 1994. Metabolic consequences of atmospheric sulphur influx into plants. In: Welburn, A. and Alscher, R. (eds), *Proceedings of the 3rd International Symposium on Air Pollution and Plant Metabolism*, Chapman and Hall, London, (in press).
- Reuss, J.O.** and Johnson, D.W. 1986. *Acid Deposition and the Acidification of Soils and Waters*. Springer-Verlag, New York.
- Saltzman, E.S.** and Cooper, D.J. 1989. Dimethyl sulfide and hydrogen sulfide in marine air. In: Saltzman, E.S. and Cooper, W.J. (eds), *Biogenic Sulfur in the Environment*. 330-351. American Chemical Society, Washington, DC.
- Schutz, H., Schröder, P.** and Rennenberg, H. 1991. Role of plants in regulating the methane flux to the atmosphere. In: Sharkey, T.D., Holland, E.A. and Mooney, H.A. (eds), *Trace Gas Emissions by Plants*. 29-63. Academic Press, San Diego.
- Schulze, E.-D., Lange, O.L.** and Oren, R. 1989. *Forest Decline and Air Pollution. A study of spruce (Picea abies) on acid soils*. Springer-Verlag, Berlin.
- Schwartz, S.E.** 1988. Are global cloud albedo and climate controlled by marine phytoplankton? *Nature* **336**: 441-445.
- Stuedler, P.A., Bowden, R.D., Melillo, J.M.** and Aber, J.D. 1989. Influence of nitrogen fertilization on methane uptake in temperate forest soils. *Nature* **341**: 314-316.
- Tevini, M.** 1994. UV-B effects on terrestrial plants and aquatic organisms. *Progress in Botany* **55**: 174-190.
- Tingey, D.T., Turner, D.P.** and Weber, J.A. 1991. Factors controlling the emissions of monoterpenes and other volatile organic compounds. In: Sharkey, T.D., Holland, E.A. and

- Mooney, H.A. (eds), *Trace Gas Emissions by Plants*. 93–119. Academic Press, San Diego.
- Wassmann, R., Papen, H. and Rennenberg, H. 1993. Methane emission from rice paddies and possible mitigation strategies. *Chemosphere* **26**: 201–217.
- Wellburn, A.R. 1990. Why are atmospheric oxides of nitrogen usually phytotoxic and not alternative fertilizers? *New Phytol.* **115**: 395–429.
- Wigley, T.M.L. 1989. Possible climate change due to SO₂-derived cloud condensation nuclei. *Nature* **339**: 365–367.
- Woodward, F.I., Thompson, G.B. and McKee, I.F. 1991. The effect of elevated concentrations of carbon dioxide on individual plants, populations, communities and ecosystems. *Annals of Botany* **67**: 23–38.

6.2.5 The influence of biodiversity on landscape structure

6.2.5.1 Introduction

Here, we explore how changes in biodiversity can affect landscapes and the way they function. A landscape can be defined scientifically as a heterogeneous area made up of a cluster of interacting ecosystems that is repeated in similar form throughout (Forman and Godron 1986). Although we usually think of landscapes as covering tens to hundreds of square kilometres, they can be of any size and can be defined hierarchically. At one scale we might recognize a riverine landscape consisting of clumps of trees, grassy patches, bank habitats, reed beds and so on. From a broader perspective this landscape is subsumed as a riverine landscape element in a larger landscape consisting of rivers, valleys, ridges and so on. From the perspective of an aquatic insect, the bank habitat is a landscape in itself, made up of small communities of different terrestrial and aquatic plants, bare patches and so on.

Landscape structure consists of the spatial layout of the different landscape elements and the linkages between them. The way a landscape functions is determined by the interactions between the spatial elements, the most important of these being mediated by flows of materials, energy and organisms. Landscape structure is primarily determined by the geomorphological and edaphic features of an area, but is also modified by the complex of interactions between the elements of the landscape itself. Changes in biological diversity that affect the exchange of material, energy or organisms between the elements have the potential to disrupt existing landscape structure and functioning.

The many different species found in a landscape are, of course, essential components of that landscape. Thus, any change in biodiversity affecting a large number of species is likely to affect landscape structure and functioning. The conversion of forests or grasslands to agriculture are examples of such changes in biodiversity. These types of land cover changes are well documented along with the

changes in ecosystem functioning (e.g. Waring and Schlesinger 1985). They usually involve major human activity to bring about the initial change and sometimes also to maintain the modified landscape. They will not be discussed further in this essay, but instead we will concentrate on the less deliberate anthropogenic modification of biodiversity, and on cases where changes in biodiversity in one element of the landscape lead to changes in other elements.

In assessing the impact on landscapes of changes in biodiversity it is important to keep in mind the chain of causality that we are discussing. This is shown in Figure 6.2-2a where some event, action or impact leads to a change in biodiversity and this subsequently causes changes in the landscape. However, it is often difficult to distinguish this chain from that in Figure 6.2-2b where the impact affects both biodiversity and landscape but with no strong causal connection between biodiversity and landscape in either direction, or from Figure 6.2-2c where the chain of causality is reversed. Further combinations of chains of causality can be described but these are the main three. In this summary we have sought examples that

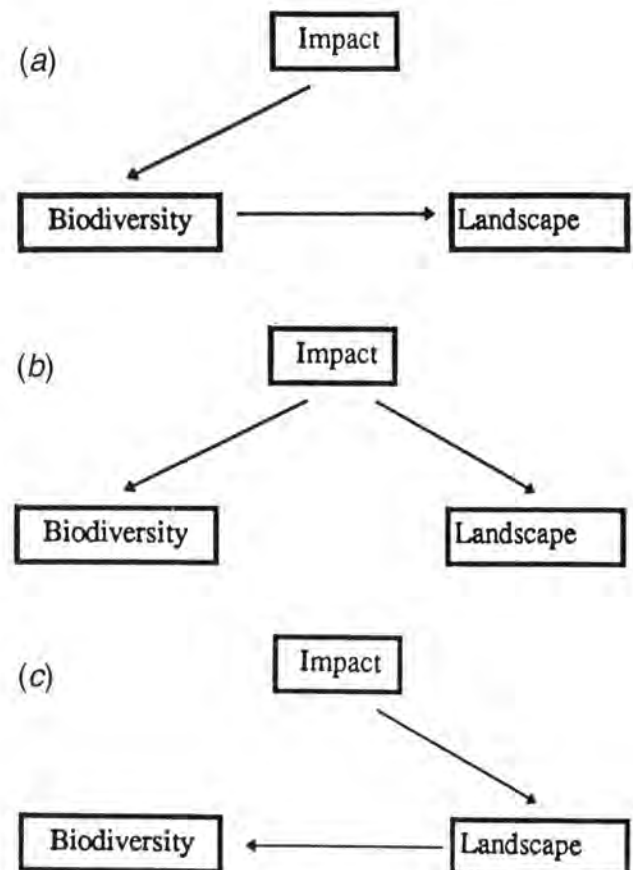

Figure 6.2-2: Chains of causality in assessing the impact of changes in biodiversity.

appear to be best described by Figure 6.2-2a but accept that in some cases other interpretations may be valid.

6.2.5.2 Specific systems

6.2.5.2.1 Arid systems. In arid ecosystems the redistribution and concentration of water, nutrients and sediments are important at several scales in achieving adequate growing conditions for plants. For example, in arid shrublands, each individual shrub is a 'fertile island' where nutrients and water are concentrated (Garcia-Moya and McKell 1970; Noy Meir 1985; Garner and Steinberger 1989; Friedel *et al.* 1990). Introduced herbivores, or changes in the concentration of domestic and native herbivores, around new watering points for example, can disrupt these fertile islands and lead to changes in biodiversity and eventually the structure of the surrounding landscape. Introduced species that occupy the transfer areas, such as shrubs and trees invading watercourses, can disrupt the concentration process and lead to the loss of other species.

The stripe process, which is found in many arid regions of the world (White 1971), is an example of the resource concentration process at a larger scale. In these systems vegetation is clumped in parallel, narrow bands and the soil between the bands of vegetation is usually almost bare. In heavy rainfalls water quickly runs off bare areas but is trapped in vegetated areas. These systems occur in landscapes with slopes of less than 0.6° and relatively impervious soil surfaces. Measurements have shown that the stripe process can effectively double the amount of water received in the stripes and the development pattern in stripes is species-dependent (Montaña *et al.* 1990). The pattern of stripes can develop initially either from the loss of surrounding vegetation in previously vegetated areas or from the spread of vegetation around an initial colonizer in previously bare areas (White 1971). The system can be disrupted by changed herbivory patterns that break the runoff surfaces (e.g. sheep tracks; Tongway and Ludwig 1990), by introduced species colonizing the runoff surfaces, or by grazing in the stripe vegetation.

At a larger scale the resource concentration process has been described as an 'erosion cell' (Pickup 1985). Arid lands are often a mosaic of erosion cells each consisting of erosional, transfer and sink areas. Changes in grazing patterns brought about by human activity can increase the susceptibility of land surfaces to erosion (e.g. by removing plant cover or by breaking up soil crusts), so initiating new erosional cells and thus altering landscape patterns.

6.2.5.2.2 Temperate and boreal forests and grasslands. In more mesic systems the concentration process described for arid systems is not as important. Instead, the main effect of changes in biodiversity is through the disruption of disturbance regimes leading to changes in the landscape patterns that result from disturbance.

Common examples involve fire. Any gain or loss of species that contributes to heavy fuel loads is likely to affect fire regimes and these changes in disturbance regime can lead to significant changes in landscapes. An example is the impact of introduced herbivores (sheep) to native pastures in temperate to semi-arid areas of eastern Australia. Increased grazing pressure has reduced the grass biomass (and possibly diversity) and, coupled with fire suppression activities by landowners, fire frequencies have been reduced. This has led to dramatic increases in the density of many shrubby species previously kept in check by fires, and the conversion of large areas from a mosaic of grass and shrublands to shrub thickets (Griffin and Friedel 1984).

Beavers (*Castor canadensis*) provide an example of the loss of a single species leading to major changes in landscapes (Hammerson 1994; Naiman *et al.* 1994). It has been estimated that in parts of North America the density of beavers was 0.8/km along streams of all sizes (Jenkins and Busher 1979) and that they were the major element in creating patches of 0.5 to 24 ha in forested landscapes (Remillard *et al.* 1987). They do so by creating ponds, affecting stream flow, opening the forest canopy, changing nutrient distribution and creating habitats favourable to some species (e.g. willows, waterfowl) and unfavourable to others (e.g. aspen, cottonwood, running-water invertebrates). Their loss leads to a reduction in landscape heterogeneity, although their influence on the landscape may persist for centuries. For example, beavers disappeared from England about 1000 years ago but their influence can still be traced in the distribution of fens and peat areas (Darby 1956).

Moose (*Alces alces*) and Alaskan snowshoe hares (*Lepus americanus*) also play a keystone role in the composition and structure of boreal forests, and their presence or absence can affect the distribution and abundance of many other species (see 6.1.6).

6.2.5.2.3 Tropical savannahs. The complex interactions leading to the unstable balance of trees and grasses in savannah systems have been summarized by Walker (1987). In the alternating wet and dry tropical systems, changes in biodiversity can affect landscape functioning both by changing nutrient concentrating processes and by changing the fire regime as described above. Also, the loss of a few species can lead to a significant flow-on of effects that results in changes in landscape structure. An example is the role of termite mounds in acting as sites for the establishment of tree clumps (Menaut and Cesar 1982). Abandoned termitaria provide higher nutrient concentrations, greater water availability and local protection from fire, and thus favour the establishment of tree seedlings over those of grasses. The number of such mounds can be reduced by domestic

stock, so reducing tree regeneration and changing the nature of the savannah landscape towards a grassland.

Large native herbivores, such as elephants (*Loxodonta africana*) and hippopotamuses (*Hippopotamus amphibius*) affect savannah structure directly (Cumming 1982). Elephants physically remove trees and both species create paths that can eventually lead to new erosional cycles. Hippopotamus trails have a major influence in drainage patterns and thus on wetland landscapes (Laws 1981). The loss of these large species and their replacement by smaller or domestic herbivores usually leads to an homogenization of the savannah landscape.

6.2.5.2.4 Wet tropics. In wet tropical systems it appears that landscape patterns are less affected by changes in biodiversity *per se*, and that the biological diversity of most functional groups is so high that the loss of one or a few species has little effect (Janzen 1981). Landscape pattern is a consequence of topography and small-scale events such as blow-downs. Human activity, such as shifting agriculture and land clearance, can have major effects on biodiversity and landscape patterns. Changes in landscape patterns (e.g. edge exposure and fragmentation) may have continuing effects such as edge die-back and blow-down (Lovejoy *et al.* 1984), but the changes in landscape patterns appear to be the direct consequences of the human actions and are not moderated by changes in biodiversity directly (i.e. the chain of causality is most likely as in Figure 6.2-2b or c).

There are examples of key species affecting rain forest patches in wet-dry tropical regions. In Australia water buffalo, a recent introduction from Asia, seek out small rain forest patches where they create large wallows that are invaded by grasses and herbaceous species, many of which are also introduced. The wallows are more susceptible to fire than the rain forest itself and carry the frequent fires from the surrounding drier woodlands into the rain forest patch (Russell-Smith and Dunlop 1987). This is leading to the loss of rain forest patches within the landscape.

6.2.5.2.5 Aquatic systems. Water is a dense and mobile medium which readily carries material, energy and organisms between components of aquatic 'landscapes' (here interpreted as the solid substrate beneath the water rather than structures in the water column itself). Water is the dominant linkage between elements of the landscape, and organisms are most likely to affect landscapes by acting as filters or barriers to the transport process. In coral reefs the diverse biota literally create the landscape where the existence of atolls and barrier structures is dependent on the diversity of coral and planktonic organisms responsible for substrate formation and for the continued nutrition of the living landscape (see 6.1.10).

The destruction of mangrove forests can lead to a loss of the filtering process that traps soil sediments in the surface flow from the landward side (Ogden 1988). Seagrass beds

perform a similar role in shallow coastal areas (Ogden and Gladfelter 1983). The loss of these species may allow large pulses of nutrients and sediment to be deposited on nearshore marine systems leading to major impacts on reef structure and diversity (D'Elia 1988). Sediments and nutrients in the outflow alter the competitive balance of the reef system by physically inhibiting coral growth and by encouraging algal growth in the higher nutrient conditions. This can lead to significant changes in landscape structure, which can be further accentuated by additional biotic interactions.

There has been concern recently about the impact on reef structure of outbreaks of the crown-of-thorns starfish (*Acanthaster planci*). Heavy grazing by this key species leads to dramatic short-term changes in the reef landscape, although it does appear that reefs eventually recover to more or less their previous condition. It has been argued that these outbreaks may be associated with the influx of additional nutrients to the reef (e.g. after shoreline clearance or heavy rains) which leads to plankton blooms, which in turn lead to increased survival of *Acanthaster* larvae (Birkland 1982). The outbreaks of crown-of-thorns starfish may be an extreme fluctuation in the complex control systems of coral reef structures where echinoid grazers control algal growth that would otherwise reduce coral recruitment and success (Mann 1982; Sammarco 1982). Any change in the populations of either the grazers or the algae (e.g. from nutrient inputs, hurricanes, overfishing or predators on the grazers) can set in chain a series of abiotic and biotic interactions leading to changes in biodiversity and landscape structure (Ogden and Lobel 1978; Wiebe 1988).

The role of sea otters (*Enhydra lutris*) in shaping the 'landscapes' of kelp communities has been well documented (see also 6.1.9). Otters feed on a range of benthic herbivores and in particular on sea urchins. In areas where otters were hunted to extinction, urchin populations exploded and overgrazing of the macroscopic algae led to a spatially heterogeneous community in which kelp was a minor component. Otters have been reintroduced into some areas and there is evidence of a shift towards a much less diverse community dominated by a single kelp species (Duggins 1980). The effect of otters on community is not only via their direct predation on herbivorous species but also via their discarded clam shells and their excavation of soft-bottom areas for clams. These activities leave more shells on the surface and these are a more favourable location for the establishment of kelp in soft-bottom environments (Kvitek *et al.* 1992). It is also possible that in the past the presence of otters led to high algal productivity which in turn supported the presence of sea-cows (*Sirenia* spp.). Sea-cows have a major effect on sea grass bed by their 'ploughing' feeding action. In the northern Pacific, Steller's sea-cow (*Hydrodamalis stelleri*) was also hunted

to extinction, so that the reintroduction of sea otters in this region may not lead to the recovery of communities or landscapes similar to those before the impact of over-exploitation (Dayton 1975; Mann 1982).

The loss of mangroves from shorelines also reduces the effectiveness of their filtering (or absorbing) the energy of wave action thus exposing coastlines to major landscape modification (see 6.1.11). There are many similar examples of where the loss of a few key filtering species from estuarine or sand-dune systems can lead to changes in landscape structure.

The water body of open oceans is patchy at various scales (Steele 1991). However, the patches tend to be associated more with physical phenomena, such as circulation cells, than with biotic phenomena. One possible exception is the effect of large floating mats of raft weed, such as *Sargassum*, which may decline due to pollution and cause changes in ocean structure (see 6.1.12).

In freshwater systems the vegetation of the riparian zone also has an energy-absorbing role. Streamside vegetation and fallen logs dissipate stream energy and trap sediment. The loss of these species either through direct human action such as clearing, or indirect action such as small changes in water flow and flooding patterns with dams or weirs causing changes in streamside and floodplain vegetation, can lead to major changes in the flow regime of the stream itself and to changes in its path (Naiman and Décamps 1990; Malanson 1993). In general, the loss of vegetative cover in mountainous topography will lead to wider, shallower valley systems with a more uniform gradient (Waring and Schlesinger 1985). The effect of the loss of large mammals on stream and wetland habitats has already been described for beavers and hippopotamuses.

6.2.5.3 Generalizations

It is often difficult to determine whether changes in landscapes are due to changes in biodiversity *per se* or to

the processes that led to the changes in biodiversity. Even when changes in landscape structure can be linked to a biotic factor, the changes are often set in course by the gain or loss of a single key species.

Table 6.2-2 summarizes the examples presented in this review. The examples are by no means comprehensive but we suggest that they are indicative of the relative importance of the different ways in which biodiversity is linked to landscape structure across different biomes. The mechanisms are defined as 'filtering or concentrating', where organisms act primarily as physical barriers or conduits in transferring materials between landscape elements; 'disturbance regimes' where organisms are instrumental in propagating energy (or sometimes materials) between landscape elements; and 'key species' where one or a few species can directly bring about changes to landscape elements that eventually lead to changes in landscape structure.

There are a few generalizations that may be made from this review. The role of key species in triggering changes that alter landscapes is common to all biomes. Sometimes the loss or invasion of the key species is accompanied by consequential changes in biodiversity and these are the basis of changes in landscape structure and functioning (e.g. sea otters in kelp forests); in others the impacts of the key species are concentrated more directly on the landscape (e.g. elephants and hippopotamuses) which, in turn, may lead to changes in biodiversity.

Nutrient (including water) concentration and filtering effects are most important in biomes with low concentrations of nutrients. Thus, we observe changes in landscapes in arid and savannah systems as a result of the disruption of the nutrient and water concentration processes and in coral reef communities changes in communities and landscape functioning when filtering systems break down and higher concentrations of nutrients reach the reef.

In higher productivity systems changes in disturbance regimes, and particularly fire regimes, tend to be more

Table 6.2-2: Summary of the examples cited in this chapter classified by the types of changes in biodiversity and by biomes. There is a question mark against the tick under tropical forests because this refers to rain forest patches embedded in a wet-dry tropical woodland.

	Arid	Savannah	Temperate forest and grasslands	Tropical forests	Aquatic (freshwater, estuarine and marine)
Altered material concentration or filtering	✓	✓			✓
Altered disturbance regimes		✓	✓		
Key species effects	✓	✓	✓	✓?	✓

important processes in modifying landscapes. In the most highly productive and diverse communities (i.e. tropical rain forests) changes in biodiversity appear to have little effect on landscapes. In these systems disturbances must be of large spatial or temporal scale in order to disrupt the nutrient and water cycles and thus have long-term effects on landscape structure.

References

- Birkland, C.** 1982. Terrestrial runoff as a cause of outbreaks of *Acanthaster planci* (Echinodermata, Asteroidea). *Marine Biology* **69**: 175–185.
- Cumming, D.H.M.** 1982. The influence of large herbivores on savannah structure in Africa. In: Huntley, B.J. and Walker, B.H. (ed.), *Ecology of Tropical Savannahs*. Ecological Studies No. 42. 217–245. Springer-Verlag, New York.
- Darby, H.C.** 1956. *The Draining of the Fens*. Cambridge University Press, Cambridge.
- Dayton, P.K.** 1975. Experimental studies of algal canopy interactions in a sea otter-dominated kelp community at Amchitka Island, Alaska. *Fisheries Bulletin* **73**: 230–7.
- D'Elia, C.F.** 1988. The cycling of essential elements in coral reefs. In: Pomeroy, L.R. and Alberts, J.J. (eds), *Concepts of Ecosystem Ecology*. Ecological Studies No. 67. 195–230. Springer-Verlag, New York.
- Duggins, D.O.** 1980. Kelp beds and sea otters: an experimental approach. *Ecology* **61**: 447–453.
- Forman, R.T.T.** and Godron, M. 1986. *Landscape Ecology*. John Wiley, New York.
- Friedel, M.H., Foran, B.D.** and Stafford Smith, D.M. 1990. Where the creeks run dry or ten feet high: pastoral management in arid Australia. *Proceedings of the Ecology Society of Australia* **16**: 185–194.
- Garcia-Moya, E.** and McKell, C.M. 1970. Contribution of shrubs to the nitrogen economy of a desert-wash plant community. *Ecology* **51**: 81–88.
- Garner, W.** and Steinberger, Y. 1989. A proposed mechanism for the formation of 'fertile islands' in the desert ecosystem. *Journal of Arid Environment* **16**: 257–262.
- Griffin, G.F.** and Friedel, M.H. 1984. Effects of fire on central Australian rangelands. II. Changes in tree and shrub populations. *Australian Journal of Ecology* **9**: 305–403.
- Hammerson, G.A.** 1994. Beaver (*Castor canadensis*): ecosystem alterations, management, and monitoring. *Natural Areas Journal* **14**: 44–57.
- Janzen, D.H.** 1981. Patterns of herbivory in a tropical deciduous forest. *Biotropica* **13**: 271–282.
- Jenkins, S.H.** and Busher, P.E. 1979. *Castor canadensis*. *Mammalian Species* No. 120: 1–8.
- Kvitek, R.G., Oliver, J.S., DeGange, A.R.** and Anderson, B.S. 1992. Changes in Alaskan soft-bottom prey communities along a gradient in sea otter predation. *Ecology* **73**: 413–428.
- Laws, R.M.** 1981. Experience in the study of large animals. In: Fowler, C.W. and Smith, T.D. (eds), *Dynamics of Large Mammal Populations*. 19–45. John Wiley, New York.
- Lovejoy, T.E., Rankin, J.M., Bierregaard, R.O. Jr, Brown, K.S. Jr, Emmons, L.M.** and Van der Voort, M.E. 1984. Ecosystem decay of Amazon forest remnants. In: Nitecki, M.H. (ed.), *Extinctions*. 295–325. University of Chicago Press, Chicago.
- Malanson, G.P.** 1993. *Riparian Landscapes*. Cambridge University Press, Cambridge.
- Mann, K.H.** 1982. *Ecology of coastal waters*. Studies in Ecology Vol. 8. University of California Press, Berkeley.
- Menaut, J.-C.** and Cesar, J. 1982. The structure and dynamics of a west African savannah. In: Huntley, B.J. and Walker, B.H. (eds), *Ecology of Tropical Savannahs*. Ecological Studies No. 42. 80–100. Springer-Verlag, New York.
- Montaña, C.** 1992. The colonisation of bare areas in two-phase mosaics of an arid ecosystem. *Journal of Ecology* **80**: 315–327.
- Montaña, C., Lopez-Portillo, J.** and Mauchamp, A. 1990. The response of two woody species to the conditions created by a shifting ecotone in an arid ecosystem. *Journal of Ecology* **78**: 789–798.
- Naiman, R.J.** and Décamps, H. (eds) 1990. *The Ecology and Management of Aquatic-Terrestrial Ecotones*. UNESCO, Paris and Parthenon Publishing Group, Carnforth.
- Naiman, R.J., Pinay, G., Johnston, C.A.** and Pastor, J. 1994. Beaver influences on the long-term biogeochemical characteristics of boreal forest drainage networks. *Ecology* **75**: 905–921.
- Noy-Meir, I.** 1985. Desert ecosystem structure and function. In: Evenari, M., Noy-Meir, I. and Goodall, D.W. (eds), *Ecosystems of the World 12A: Hot deserts and arid shrublands*. 93–103. Elsevier, Amsterdam.
- Ogden, J.C.** and Lobel, P.S. 1978. The role of herbivorous fishes and urchins in coral reef communities. *Environmental Biology of Fisheries* **3**: 49–63.
- Ogden, J.C.** and Gladfelter, E.H. (eds), 1983. *Coral Reefs, Seagrass Beds and Mangroves: Their interactions in the coastal zones of the Caribbean*. UNESCO Reprints in Marine Science No. 23.
- Ogden, J.C.** 1988. The influence of adjacent systems on the structure and function of coral reefs. *Proceedings, 6th International Coral Reef Symposium*, Vol. 1: 123–129.
- Pickup, G.** 1985. The erosion cell – a geomorphic approach to landscape classification in range assessment. *Australian Rangelands Journal* **7**: 114–121.
- Remillard, M.M., Gruending, G.K.** and Bogucki, D.J. 1987. Disturbance by Beaver (*Castor canadensis* Kuhl) and increased landscape heterogeneity. In: Turner, M.G. (ed.), *Landscape heterogeneity and disturbance*. Ecological Studies No. 64. 102–122. Springer-Verlag, New York.
- Russell-Smith, J.** and Dunlop, C. 1987. The status of monsoon vine forests in the Northern Territory: a perspective. In: *Australian Heritage Commission Special Publication Series 7(1) The Rainforest Legacy*. 227–288. Australian Government Publishing Service, Canberra.
- Sammarco, P.W.** 1982. Echinoid grazing as a structuring force in coral communities: whole reef manipulation. *Journal of Experimental Marine Biology and Ecology* **61**: 31–55.
- Steele, J.H.** 1991. Marine functional diversity. *Bioscience* **41**: 470–474.
- Tongway, D.J.** and Ludwig, J.A. 1990. Vegetation and soil

- patterning in semi-arid mulga lands of eastern Australia. *Australian Journal of Ecology* **15**: 23–34.
- Walker, B.H.** 1987. A general model of savannah structure and function. In: Walker, B.H. (ed.), *Determinants of Tropical Savannahs*. IUBS Monograph Series, No 3. 1–12. International Union of Biological Sciences, Paris.
- Waring, R.H.** and Schlesinger, W.H. 1985. *Forest Ecosystems: Concepts and management*. Academic Press, Orlando, Fla.
- Wiebe, W.J.** 1988 Coral reef energetics. In: Pomeroy, L.R. and Alberts, J.J. (ed.), *Concepts of Ecosystem Ecology*. Ecological Studies No. 67. 231–246. Springer-Verlag, New York.
- White, L.P.** 1971 Vegetation stripes on sheet wash surfaces. *Journal of Ecology* **59**: 615–622.

6.2.6 Biotic linkages and ecosystem functioning

6.2.6.1 Introduction

In this essay, biotic linkages are considered as an ecosystem functional property in their own right. Thus a major emphasis will be placed on discussing the roles of biodiversity in biotic linkages and community structure, specifically exploring how these are disrupted by human activities. In addition, an attempt will be made to discuss further how biotic linkages may in turn influence some of the other more conventional ecosystem properties (e.g. nutrient cycling, primary production, microbial activities) reviewed in Section 5 of the GBA. In this analysis, however, it is important to bear in mind the following caveat. The roles of biodiversity in biotic linkages and species interactions are difficult to assess since changes in species richness (i.e. deletions/additions) imply consequent changes in linkages and therefore it is difficult to assign causality for the observed effects unequivocally. An appropriate assessment, for the future, would require different approaches, such as assessing effects as a result of changes in the strength of interactions without changing species richness.

Occasionally, biological interactions may have discernible direct benefits to humans, as described in Box 6.2-1.

The biological activities of one individual invariably impinge upon the activities of other individuals of the same or different trophic levels, and the magnitude and direction of these effects are commonly referred to as biotic linkages or species interactions. Though activities occur at the level of the individual, typically the individual interactions are grouped according to their species designation (i.e. intra- or interspecific). According to their sign, these interactions can be classified into two broad groups – antagonistic and mutualistic — and can be further classified into many kinds of more specific interactions, most of which are described and treated in text books of ecology (e.g., Begon *et al.* 1993; Ricklefs 1993).

Most species are involved in several interactions with other species and each interaction can differ in its sign (antagonistic, mutualistic), magnitude (strong, weak),

specificity (ranging from complete specialism to generalism), and degree of dependence on interacting organisms (obligate, facultative). The multiple interactions of species imply that most communities consist of a pattern of interactions among their member species that we refer to as a community web (this differs from a food web, which focuses on trophic links among species). This implies that besides direct interactions there are complex indirect or non-linear interactions among species (e.g. a top predator that feeds on a polyphagous herbivore which in turn determines relative competitive interactions among plants). Effects, consequently, are usually non-linear. The impact of a single species on a community is therefore a complex function of the number of interactions, the signs and magnitudes of those interactions, and the number of indirect links with other species in the community. This complex function can be referred to as the average strength of a species interaction with its community, and this strength can range from strong in keystone species (see Terborgh 1986) to weak in relatively independent species. A more detailed discussion of the contrasts between direct and indirect interactions and non-linearities is given by Menge (1995) and in Box 5.2-1. Although there is still an ongoing debate about the relative importance of types of interactions, or of keystone species, and about the role of compensations among species within functional groups, particularly in terrestrial biomes (see reviews in Ricklefs and Schluter 1993), there is a consensus that biotic interactions play a crucial role in structuring communities. This is particularly highlighted in studies of coastal benthic communities, where experimental manipulation has been actively applied, leading to a mechanistic understanding of such details and to a clarification of the importance of biotic linkages and species interactions for community structure and composition (see a recent review in Menge 1995). However, there is still a major gap in the knowledge needed to assess to what extent community structure in turn affects ecosystem functioning. Here we attempt to review (1) how changes in biodiversity (largely due to human activities) in different biomes affect biotic linkages or species interactions and, to the extent that the scant information permits, (2) how this scales up to alterations of ecosystem functioning.

6.2.6.2 Human impacts

Human activities produce alterations of biodiversity that directly or indirectly affect the patterns of interactions and linkages of species to one another in communities. In Arctic and subalpine systems, overhunting and overharvesting of marine and terrestrial mammals is leading to population declines (6.1.1). When these animals are keystone or top predators (e.g. sea otters), the effects seem to alter dramatically the pattern of interactions and may propagate to the entire ecosystem. Likewise, herding

Box 6.2-1: Potential human benefits of the *Urania/Omphalea* coevolution.

The day-flying moth *Urania fulgens* and its host plants *Omphalea* spp. provide a remarkable example of the complex and fascinating ways in which elements of biodiversity (viewed at the species level in this case) operate in their natural settings, as well as the potential implications these seemingly obscure organisms may have for human society.

The adult moths migrate northwards and southwards between several localities in northern South America and southeastern Mexico. In many of these localities, with a certain periodicity, they undergo dramatic local population explosions. The caterpillars of this moth feed exclusively on the foliage of plants of the genus *Omphalea*, such as the vine *O. diandra* in Panama, or the 25 m tall tree *O. oleifera* in Mexico. During years of the moths' population explosions, these plants are heavily defoliated. If fed with the leaves of other plants, the caterpillars will not eat, and starve to death. In the Mexican populations this was found to be the case, consistently, even if the moths were fed with all the local species of the same family as *Omphalea* (Euphorbiaceae). The *Omphalea* plants, in turn, are rarely eaten by herbivores (either invertebrates or vertebrates in the Mexican situation) other than *Urania*. This high degree of mutual specialization indicates a long joint evolutionary history, of the type usually referred to as coevolution. In addition, it has been noted that the moths' migrations and the magnitude of their population explosions appear to occur with a certain periodicity – but the underlying mechanisms for this are not fully understood.

Such tight biotic interaction appears to be mediated by some peculiar metabolites (apparently toxic to many animals) that were unknown until very recently, and which are present in the plants' tissues and can be sequestered by the caterpillars without them, in turn, being affected. Specifically, it has been found that *O. diandra* produces and *U. fulgens* concentrates dihydroxymethyl-dihydroxypyrrolidine (DMDP). These remarkable compounds have been found to be quite promising in three aspects of relevance to humans. The first of them has to do with AIDS, due to their role in blocking the activity of the HIV virus. Secondly, DMDP suppresses enzymatic activity in *Callosobruchus* beetles. The beetles attack stores of beans in the tropics; and as a result of the differential effect of the chemical, humans can eat beans treated with DMDP (which the beetles would not have been able to eat). Thirdly, it has been found that DMDP also has some activity against cancer and diabetes. Such remarkable activities of these metabolites and the moths' ability to deal with them constitute promising avenues not only for the prospecting and development of new drugs, but also for the understanding and possible application of novel detoxifying mechanisms.

On the other hand, based on the understanding of the activity of the plants' toxic metabolites, some evidence suggests that the periodicity of the migrations and the magnitude of the moths' population explosions might be governed by the time it takes for the heavily defoliated plants to induce and relax the production and build-up of their toxic compounds.

Given the migratory habits of the moth and the great specialization of their ecological interaction with the *Omphalea* plants, this system highlights two points pertinent to biodiversity conservation: that conservation efforts should not be directed only to biodiversity components (e.g. species) *per se*, but also to their underlying ecological and evolutionary processes (such as biotic linkages) and to the global nature of the conservation/disruption of biodiversity. In this system, for example, perturbations in a given locality (say Mexico) may dramatically disrupt the ecological interactions and destroy a complex ecological process in another distant locality (say Panama) and vice versa.

practices or changes in reindeer abundance change lichen cover and vegetation structure (Andreev 1978). In tropical forests, habitat destruction (deforestation, forest fragmentation) and contemporary hunting (6.1.2) produce dramatic alterations of biodiversity components which are beginning to show consequences in biotic interactions such as pollination (Aizen and Feinsinger 1994) and herbivory (Dirzo and Miranda 1991). Temperate forest systems show a marked vulnerability to species introductions of

pathogenic pests such as the ones causing Dutch-elm disease and chestnut blight, or insects such as the gypsy moth (6.1.3). In arid lands, both importation of non-native plants and removal of native ones are occurring actively in association with forage improvement plans (6.1.4). Human activities are also leading to the decline of bat populations, which in turn affects the pollination pattern of *Agave* plants in North American deserts (Howell and Roth 1981). Introduction of mammals and other changes in grazing

regime cause marked alterations of the vegetation structure and composition and plant-plant interactions in savannahs (6.1.5), boreal forests (6.1.6) and temperate grasslands (6.1.7). Species introductions and habitat modification are argued potentially to disrupt biotic interactions such as pollination and dispersal (6.1.8). In aquatic biomes the removal or partial displacement of predators by overfishing, overcollecting or pollution, as well as the introduction of new species can produce considerable effects (particularly well documented in coastal systems – see 6.1.9) which can propagate to the rest of the ecosystem by means of the disruptions of biotic interactions.

From the point of view of the relevance of biodiversity with regards to biotic linkages, the effects of human activities can be assessed more simply in terms of species deletions or species additions.

6.2.6.3 Effects of removal of species on biotic linkages

The removal of a species from a community may cause further losses and therefore profoundly affect biotic linkages, or it may cause no further losses (although all the other persisting species may do so at different densities) thus leading, at least theoretically, to what Pimm (1986) calls the species deletion stability of systems. Within a web, species deletion stability may vary considerably, depending, among other things, on the species richness of the system, the trophic level from which the species are removed, and the degree of connectance of the species removed (connectance being the actual number of species interactions in a food web divided by the number of possible interactions (Pimm 1986). Studies of model communities suggest that species-rich communities (i.e. those with high connectance) are more sensitive to the loss of top predators while the loss of primary producers and consumers has less of an effect on community dynamics (Pimm 1986).

Field data show that most natural systems, regardless of species richness, appear to be changed after the removal of top predators or herbivores. This conclusion appears to hold for a wide variety of biomes including marine and freshwater systems (Pimm 1980), East African savannahs (McNaughton 1985), desert communities in North America (Brown 1985), and tropical forests (Terborgh 1988). In an excellent experimental study McNaughton (1977) found that the consequences of the removal of herbivores depended upon species richness: plant species composition changed more when a grazing herbivore, the African buffalo, was excluded from a species-rich grassland, than when the same herbivore was excluded from a species-poor one. No explicit experiments seem to be available to assess the consequences of the removal of plant species from species-poor and species-rich systems. Although species-rich systems might be expected to be more resistant to the loss of plant species, the occurrence of keystone plant

species such as *Ficus* spp. in highly diverse tropical forests (see Terborgh 1986), suggests that removal of certain plant species can indeed have profound effects on species composition and linkages in the rest of the web. In summary, the outcome of alterations in the web of interactions is very much dependent on the complexity of the web and the identity (e.g. keystone status) of the species.

6.2.6.3.1 Empirical evidence of the effects on ecosystem functioning. Apart from the alteration of biotic linkages and community structure due to species removals, consequences can be seen at the level of ecosystem processes. For example, the native moose, *Alces alces*, on Isle Royale, Lake Superior, Canada, feeds preferentially on early successional species, avoiding those of late successional stages (Pastor *et al.* 1993). Thus herbivory determines the structure and composition of these forests. By comparing browsed and unbrowsed plots, it has been shown that this herbivore significantly reduces nutrient availability and microbial activity and, in the longer term, primary production and successional trends.

A 12-year study by Brown and Heske (1990) showed that the removal of three seed-eating kangaroo rat species caused habitats to shift from desert to scrub to arid grassland. While not documented by the authors, such dramatic alterations in plant species composition should lead to considerable changes in the amount and chemistry of leaf litter, decomposition rates and nutrient cycling. Thus, seed predation appears largely responsible for determining the type of community in this system and therefore may control a wide range of ecosystem-level processes.

6.2.6.4 Effects of addition of species on biotic linkages

Food web theory argues that, on average, communities seem to be highly resistant to species introductions (Pimm 1986). Nevertheless, there seems to be good evidence to suggest that species richness affects the susceptibility of a community web to ecological invasion (introduction of non-native species). In general, it appears that species-rich tropical forests are very resistant to invasions (see 6.1.2). Diamond (1985) found that the rate of success of bird introductions on tropical and subtropical islands declines steeply with the species richness of the extant native avifauna. An extrapolation of these findings would suggest that temperate biomes (with lower species richness) should be more susceptible to species invasions. Data for insect introductions suggest a similar pattern (see a review in Pimm 1986), but prediction of the success of insect introductions from a knowledge of the community structure and diversity is still somewhat debatable. Other noticeable patterns involve the apparent susceptibility of islands to invasions (related in some instances to species diversity) and the

subsequent (in some cases devastating) effects of such invasions on the rest of the biotic linkages.

6.2.6.4.1 Empirical evidence of the effects on ecosystem functioning. Aside from the question of the role of species diversity in susceptibility to invasion, there remains the issue of the possible consequences of such additions to some ecosystem functions or properties. The following examples indicate such potential ecosystem consequences. The Argentine ant (*Iridomyrmex humilis*) has invaded extensive areas of the world causing considerable changes in the species interactions of the invaded systems. In the South African Cape Region it has radically altered the composition of the native ant fauna by replacing dominant species. Bond and Slingsby (1984) documented the consequences of this invasion for the mutualistic interactions between plants and seed-dispersing ants. They found that, compared to the native ant species, the Argentine ant was much slower to discover the seeds of an exclusively ant-dispersed plant, dispersed these seeds shorter distances, and failed to store them below ground where they would have gained protection from seed predators. Given the importance of ant seed dispersal in this system, the invasion of such an influential ant species has the potential substantially to alter community composition and ecosystem-level processes.

The inadvertent introduction of the house mouse to Marion Island in 1818 resulted in substantial alterations in decomposition and nutrient cycling on the island (Crafford 1990). This introduction was found to be particularly influential because the mice preferentially feed on the island's dominant detritus-feeding invertebrate, the endemic moth *Pringleophaga marioni*. Larvae of this moth are estimated to consume up to 50% of the primary production on the island. Such processing considerably enhances microbial activity and subsequent release of essential nutrients. Some experiments (Crafford 1990; Smith and Steenkamp 1990) have shown that the addition of just two moth larvae into litter stimulated mineralization of nitrogen ten-fold and phosphorus three-fold. Thus, these moth larvae appear to be the primary mediators of nutrient mineralization and introduction of an exotic predator has greatly altered ecosystem processes on this island.

6.2.6.5 Cross-biome comparison and ecosystem services

In an attempt to summarize the available information in a way that permits us to highlight the effects of human activities on biodiversity components, and the consequences of this on biotic linkages, we present a cross-biome comparison based on a distillation of several published accounts that provide information on (1) the kinds of biomes that are likely to be affected by the modification documented; (2) the interaction type; (3) the biotic hierarchical level at which it operates (e.g. gene, individual, population, species, community, ecosystem,

landscape, region, global); (4) the human activity responsible for the change; (5) the ecological effect, and (6) the human consequences. The working set consisted of 11 examples of mutualistic and antagonistic interactions which included cases applicable to specific biomes and cases applicable to all biomes (Table 6.2-3).

6.2.6.5.1 Pollination linkages. This review indicates that landscape modification in the form of partial deforestation and habitat fragmentation affects pollination linkages in a variety of terrestrial biomes, from temperate sandy meadows (Jennersten 1988) to tropical forests (Karr 1982). Thus it appears that pollination disruptions occur across most biomes except in aquatic ones, where biotic pollination *per se* is poorly represented. The alteration of this type of biotic interaction occurs largely due to the reduction of species or abundance of pollinators. The consequences of this disruption range from potential local extinction of plant species to reduced genetic variation in partly self-compatible outcrossers which thus depend to a larger extent on self-pollination (Jennersten 1988). The consequences of reduced genetic variation can in some cases scale up to ecosystem functions and affect a given service. For example, in agroecosystems, where single hybrids are planted over large areas, pests and pathogens can be devastating. The outbreak of *Helminthosporium maydis* on the CMS hybrid corn (Williams and Levings 1992) is an outstanding example of the consequences of reduction in biodiversity (genetic variance in this case) which affects biotic linkages and in turn affects an ecosystem function and service (the regulation of production).

6.2.6.5.2 Seed dispersal linkages. Deforestation and fragmentation lead to the loss/decline in abundance of some species of frugivores in tropical forests, which in turn have the potential to reduce biotic seed dispersal (Kattan 1992). The greater occurrence of plant modifications for biotic dispersal in terrestrial tropical and temperate deciduous forests (Howe and Smallwood 1982) suggests an expected trend of greater importance of this biotic linkage in such biomes than in more dry and aquatic ones. A similar trend could be expected in the case of defensive mutualisms, though appropriate information for cross-biome comparison is very limited. The expected consequences of reductions in such mutualisms as frugivory may include reductions in the reproductive capacity of highly dependent (specialized) plants, or reductions in genetic variability (similar to the case of pollination described above) though no information seems to exist regarding the ecosystem-functioning consequences.

6.2.6.5.3 Grazing linkages. Modifications of grazing regimes dramatically affect several ecosystem processes in a variety of both terrestrial and aquatic biomes (Table 6.2-3). Additions or deletions of top predators alter the abundance or occurrence of herbivores and this in turn may

Table 6.2-3: Effects of human activities on biodiversity components.

Interaction	Species	Human Activity	Effect	Potential consequence	Biodiversity hierarchy	Applicable biome	Source
Pollination	Several	Landscape modification (habitat fragmentation)	Reduction of pollinator efficiency	Inbreeding local extinction	Gene-landscape	Terrestrial	1, 2
Grazing	Ungulates	Simplification of herbivore guild, overgrazing	Change in vegetation structure and composition	Desertification	Spp.-landscape	all	3
Predation-grazing	Otters	Eliminate top predator	Overgrazing by urchins	Local extinction of algae	Gene-landscape	all	4
Predation-grazing	Nile perch	Addition of top predator	Loss of grazers	Spp. extinction collapse of fisheries	Spp.-landscape	all	5
Predation-grazing	Beaver	Deletion of keystone sp.	Loss or disturbance	Homogenization of habitat	Landscape	all	6
Predation-grazing	"	Addition of keystone sp. (Chile, Argentina)	Increased disturbance	Disruption of habitat	Landscape	all	7
Predation-grazing	Fish	Deletion of zooplankton grazers	Phytoplankton bloom	Ecosystem collapse	Gene-landscape	all	8
Dispersal	Birds	Deforestation fragmentation	Reduction of dispersal agents	Reduced reproductive potential of plants	Gene-spp.	Moist:wet >dry forests	9
Dispersal	Argentine ant	Introduction of exotic sp.	Excluded native ants	Reduced reproductive potential of plants	Extinction	Terrestrial	10
Predation	Mouse/moth	Addition of top predator	Extinction of prey (keystone detritivore)	Potential disruption of detritus pathway	Gene-ecosystem	all	11
Predation	Cats	Deletion of top predators in tropical rainforest	Mammalian herbivores increase	Overgrazing, excessive seed predation, change in vegetation structure and composition	Gene-spp.	all	12
Predation	Lamprey	Addition of top predator (building of dams)	Locks bring predator and prey together which results in extinction of prey (fish)	Collapse of fisheries	Gene-spp.	all	13

Sources: 1. Jennersten (1988); 2. Karr (1982); 3. B. Huntley (pers. comm.); 4. Estetes and Palmisano (1974); 5. Keenlyside (1991); 6. Nieman *et al.* (1988); 7. Lizarralde (1993); 8. D. Soto (pers. comm.); 9. Brooks and Dodson (1965); 10. Bond and Slingby (1984); 11. Crafford (1990); Smith and Steenkamp (1990); 12. Terborgh (1988); 13. O. Solbrig (pers. comm).

have a range of effects from modifications of vegetation structure to disruptions of detritus pathways. This type of ecosystem function consequence occurs in several forest biomes from boreal to tropical ones, as well as in aquatic ones. The introduction of exotic species affects trophic relationships and a number of biotic linkages (predation, herbivory, hierarchical competitive relationships) in non-linear ways and this type of effect is known for both aquatic and terrestrial biomes of several types. Some of the best-known examples are referred to in Table 6.2-3.

6.2.6.6 Conclusions

Although there is little specific documentation about the importance of biodiversity components affecting biotic linkages and then ecosystem processes, our review of the available information indicates that a common outcome of human impacts on biotic linkages is alteration of the stability of community structure (pattern of interactions) and composition (distribution and abundance of species). From our analysis, it appears that in low-diversity systems, the full set of species within functional groups is important. This is the case in boreal forests (Pastor *et al.* 1993) and temperate rocky intertidal shores (6.1.9), while it appears that in high-diversity systems (e.g. tropical forests, tropical rocky shores) the deletion of species can be compensated for by the other species in the available pool. However, compensation does not seem to occur when deletion of a whole functional group takes place, even in high-diversity systems (e.g. the deletion of the guild of understory herbivorous mammals in tropical forests; Dirzo and Miranda 1991).

The present assessment allowed us to consider the certainties and uncertainties of how changes in biotic interactions affect community stability (cf. Orians 1982). We conclude that stability changes occur when biotic interactions and linkages are altered through deletions, additions or other alterations of structure — and that the effects can range from reductions of genetic variability to landscape-level effects and from moderate to catastrophic. Effects are generally confined to within ecosystems or biomes and there is little evidence of them scaling up to geographically distant biomes. However, an example of the potential of the latter can be drawn from the case of across-biome migratory organisms such as birds or insects. Deforestation and habitat fragmentation in tropical forests affect several species of migratory birds, which in turn may affect biotic interactions involving these birds in temperate forests. The alterations of temperate forests may have similar effects in tropical forests.

Much of the available evidence demonstrates that changing biodiversity changes biotic interactions and links in communities, but this is evidence that is generally gathered *after* alterations have occurred. Effective prediction and management modelling is dependent upon

further research involving the experimental manipulation of species, through natural and planned experiments.

References

- Aizen, M.A. and Feinsinger, P. 1994. Forest fragmentation, pollination and plant reproduction in a chaco dry forest, Argentina. *Ecology* **75**: 330–341.
- Andreev, V.N. (ed.) 1978. *Seasonal and Weather-related Dynamics of Phytomass in the Subarctic Tundra*. Nauka, Siberian Section, Novosibirsk.
- Begon, M., Harper, J.L. and Townsend, C.R. *Ecology: Individuals, populations and communities*. Sinauer Associates, Sunderland, Mass.
- Bond, W.J. and Slingsby, P. 1984. Collapse of an ant–plant mutualism: the Argentine ant (*Iridomyrmex humilis*) and myrmecorous Proteaceae. *Ecology* **65**: 1031–1037.
- Brooks, J.L. and Dodson, S. I. 1965. Predation, body size, and composition of plankton. *Science* **150**: 28–35.
- Brown, J.H. 1985. Experiments on desert rodents. In: Case, T.J. and Diamond, J.H. (eds), *Community Ecology*, Harper and Row, New York.
- Brown, J. and Heske 1990. Control of a desert-grassland transition by a keystone rodent guild. *Science* **250**: 1705–1707.
- Crafford, J.E. 1990. The role of feral house mice in ecosystem functioning on Marion Island. In: Kerry, K.L. and Hempel, G. (eds), *Antarctic Ecosystems: Ecological change and conservation*, 359–364. Springer-Verlag, Berlin.
- Diamond, J.H. 1985. Introductions, extinctions exterminations and invasions. In: Case, T.J., and Diamond, J.H. (eds), *Community Ecology*, 65–79. Harper and Row, New York.
- Dirzo, R. 1987. Estudios sobre interacciones planta-herbívoro en Los Tuxtlas, Veracruz. *Revista de Biología Tropical* **37**: 119–131.
- Dirzo, R. and Miranda, A. 1991. Altered patterns of herbivory and diversity in the forest understory: A case study of the possible consequences of contemporary defaunation. In Price, P.W., Lewinsohn, T.M., Fernandes, W. and Benson, W.W. (eds), *Plant–Animal Interactions*, 273–287. John Wiley, New York.
- Estetes, J.A. and Palmisano, J.F. 1974. Sea otters: their role in structuring seashore communities. *Science* **185**: 1058–1060.
- Fellows, L.E. 1989. Botany breaks into the candy store. *New Scientist* **26**: 45–48.
- Fellows, L. E. and Nash, R. J. 1990. Sugar-shaped alkaloids. *Science Progress*, Oxford **74**: 245–255.
- Howe, H.F. and Smallwood, J. 1982. Ecology of seed dispersal. *Annual Review of Ecology and Systematics* **13**: 201–228.
- Howell, D.J. and Roth, B.S. 1981. Sexual reproduction in Agaves: the benefits of bats, the cost of semelparous advertising. *Ecology* **62**: 1–7.
- Jennersten, O. 1988. Pollination in *Dianthus deltoides* (Caryophyllaceae): effects of habitat fragmentation on visitation and seed set. *Conservation Biology* **2**: 359–366.
- Karr, J.R. 1982. Avian extinction in Barro Colorado Island, Panama: a reassessment. *American Naturalist* **119**: 220–239.
- Kattan, G.H. 1992. Rarity and vulnerability: the birds of the Cordillera Central in Colombia. *Conservation Biology* **6**: 64–70.

- Keenleyside, H.A.** (ed.) 1991. *Cyclid Fishes: Behaviour, ecology and evolution*. Chapman and Hall, London.
- Kite, G.C., Horn, J. M., Romeo, J.T., Fellows, L.E., Lees, D.C., Scofield, A.M. and Smith, N.G.** 1990. A homonojirimycin and 2,5-dihydroxymethyl-3,4-dihydroxypyrrolidine: alkaloidal glucosidase inhibitors in the moth *Urania fulgens*. *Phytochemistry* **29**: 103–105.
- Lizarralde, M.S.** 1993. Current status of introduced beaver (*Castor canadensis*) population in Tierra del Fuego, Argentina. *Ambio* **22**: 351–358.
- McNaughton, S.J.** 1977. Diversity and stability of ecological communities: a comment on the role of empiricism in ecology. *American Naturalist* **111**: 515–525.
- McNaughton, S.J.** 1985. Ecology of a grazing ecosystem: The Serengeti. *Ecological Monographs* **55**: 259–294.
- Menge, B.A.** 1995. Indirect effects in marine rocky intertidal interaction webs: patterns and importance. *Ecological Monographs* **65**: 21–74.
- Nieman, R.J.** 1988. Animal influences on ecosystem dynamics. *BioScience* **38**: 750–752.
- Pastor, R.M., Dewey, B., Naiman, R.J., McInnes, P.F. and Cohen, Y.** 1993. Moose browsing and soil fertility in the boreal forest of Isle Royale National Park. *Ecology* **74**: 467–480.
- Pimm, S.L.** 1986. Community stability and structure. In: Soulé, M.E. (ed.). *Conservation Biology*. 309–329. Sinauer Associates, Sunderland, Mass.
- Pimm, S.L.** 1980. Food web design and the effects of species deletions. *Oikos* **35**: 139–149.
- Ricklefs, R.F.** 1993. *The Economy of Nature*, 3rd edn, 319–357. W.H. Freeman, New York.
- Ricklefs, R.F. and Schluter, D.** 1993. *Species diversity in ecological communities: historical and geographical perspectives*. University of Chicago Press, Chicago.
- Smith, N.G.** 1983. Host plant toxicity and migration in the day-flying moth *Urania*. *Florida Entomologist* **66**: 76–84.
- Smith, V.R. and Steenkamp, M.** 1990. Climatic change and its ecological implications at a subantarctic island. *Oecologia* **85**: 14–24.
- Terborgh, J.** 1986. Keystone plant resources in the tropical forest. In: Soulé, M.E. (ed.), *Conservation Biology*. 330–344. Sinauer Associates, Sunderland, Mass.
- Terborgh, J.** 1988. The big things that run the world – a sequel to E.O. Wilson. *Conservation Biology* **2**: 402–403.
- Tyms, A.S., Berrie, E.M., Ryder, T.A., Nash, R.J., Hegarty, M.P., Taylor, M.A., Moberly, Davies, J.M., Bell, E.A., Jefferies, D.J., Taylor-Robinson, D. and Fellows, L.E.** 1987. Castanospermine and other plant alkaloid inhibitors of glucosidase activity block the growth of HIV. *Lancet* **20**: 1025–1026.
- Williams, M.E. and Levings, C.S.** 1992. Molecular biology of cytoplasmic male sterility. *Plant Breeding Reviews* **10**: 23–51.

indispensable activities in the circulation of matter, on which all larger organisms, including humans, depend (Hawksworth and Colwell 1992; Guerreo and Pedros-Alio 1993; Allsopp *et al.* 1995). Primary production, decomposition, nutrient recycling, trace gas production and the other processes considered in the preceding chapters either have a microbial component or are carried out only by microorganisms.

Microorganisms occupy a greater range of ecological niches than macroorganisms (Price 1988) and some groups were diverse as long ago as 3.5 billion years (Schopf 1993). They occur in all niches where life is thermodynamically possible, including many extreme environments in which no other life is found: high temperatures (80–110°C), high salinity (e.g. the Dead Sea, >320 g salt/litre), high pressure (deep ocean hydrothermal vents, >600 atm), very acid (below pH 2), low water activity (under 0.65 aw) and extreme cold (e.g. cryptoendoliths in Antarctica, with photosynthesis at –8°C) (Vestal and Hobbie 1988; Edwards 1990).

Microbial diversity does not represent a monophyletic group, but includes archaea, eubacteria, fungi, algae, protozoans and viruses. In practice, microorganisms are species either belonging to a phylum many members of which cannot be seen by the unaided eye, or where microscopic examination, and in many cases growth in culture, is essential for identification. Culturing, however, reveals only a biased subset of the species present in natural systems and may not accurately reflect either the actual composition or the activity of microbial communities (Hobbie and Ford 1993). New techniques (White *et al.* 1991) are beginning to rectify this problem in many ecosystems, including oceans (Giovannoni *et al.* 1990), coral reefs (Rowan and Powers 1991, 1992), hot springs (Ward *et al.* 1990; Barns *et al.* 1994) and hydrothermal vents (Hedrick *et al.* 1992). However, they are also uncovering whole groups of previously unknown organisms (DeLong *et al.* 1994, Olsen 1994: oceanic archaeobacteria; Sherr and Sherr 1991; ultraplankton). Perhaps fewer than 5% of microbial species have been discovered and named (Hawksworth 1991; Hawksworth and Ritchie 1993; Trüper 1992; see Section 3.1) and in many cases their precise ecological and biogeochemical roles are unclear (Hobbie and Ford 1993).

Our task is to describe how this dramatic and relatively unknown diversity influences a huge range of ecosystem processes and to elucidate how it might be threatened by anthropogenic activities.

6.2.7 Microbial diversity and ecosystem processes

6.2.7.1 Background

Microorganisms are crucial to the functioning of every ecosystem on Earth. They perform unique and

6.2.7.2 Important aspects of microbial diversity

Due to a limited set of morphological traits identifiable in microorganisms, microbiologists have commonly classified organisms according to detectable metabolic substrates and end products, by trophic categories, or by size. In some

ways, such functional groupings put us closer to an understanding of the roles of microbial diversity in ecosystem processes than for other groups of organisms. To say that functional group diversity is important to ecosystem processes is circular – known groups are classified as such *because* of their importance to the process at hand (Vitousek and Hooper 1993). The task is to discern what the important groups are and how they interact with each other and with abiotic controls.

6.2.7.2.1 Substrate-based groups. The functional diversity of microbes, particularly as defined by the substrates used for energy metabolism (both electron donors and -acceptors), is integral to our understanding of biogeochemistry. Substrate linkages between microbial functional groups form the basis of element cycling (e.g. N-fixers, heterotrophs, nitrifiers, denitrifiers: Meyer 1993; sulphate/sulphur reduction and sulphur/sulphide oxidation: Howarth and Stewart 1992; Meyer 1993). In some cases, as in oxic/anoxic sediment interfaces (Schlesinger 1991; Andrae and Jaeschke 1992), microbial mats, and hydrothermal vents (Hedrick *et al.* 1992), multi-organism redox cycles can be relatively localized and major transitions between groups take place over very short (millimetre) distances. At the other end of the scale, through trace gas production frequently due to metabolic redox reactions, microbes shaped the composition of the atmosphere and currently play a significant role in its maintenance (Hedrick *et al.* 1992; 6.2.4).

Vast complexity exists within the broadly defined redox groups. Within the wide range of aerobic heterotrophic microbes, the importance of further substrate specialization is frequently cited for carbon metabolism during degradation of plant material (e.g. specialists on lignin, cellulose, pectins; Garland and Mills 1991; Meyer 1993; Schimel 1994; Zak *et al.* 1994). Even within the group that decomposes lignin, however, metabolism of this recalcitrant plant compound is carried out by hundreds of species of fungi (even at a single site) and by bacteria of several genera (Meyer 1993). These can occur in succession and may be attacking different ligno-cellulose bonds, so we cannot necessarily assume 'redundancy'. Some transformations, such as nitrification and sulphate reduction, require multiple groups to complete the process (ammonium oxidizers and nitrite oxidizers, sulphate reducers and sulphur reducers, respectively). Some functional groups form consistent taxonomic groups (e.g. the nitroso-bacteria in ammonium oxidation) or at least share common metabolic constraints (sulphur-oxidizing bacteria). Others, such as denitrifiers, are very diverse with different substrate specificities and share only the use of either nitrate or nitrite as electron acceptors in a facultative anaerobic metabolism (Cook and Kelly 1992; Meyer 1993). Again, the importance of these functional groups is widely acknowledged in that loss of an entire group would lead to

loss of a process and potential disruption of the entire cycle. We know almost nothing, however, about whether or how diversity within groups might contribute to process rates, process stability, or the types of processes that are active. Though it is a common assumption (used in this assessment as well) that more diverse groups are less sensitive to disruption, this warrants empirical verification.

6.2.7.2.2 Size-based groups. Functional group classifications based on size are important particularly in aquatic food webs. The relatively recent discovery of nano- (2–20 μm), pico- (0.2–2.0 μm), and even femtoplankton (0.02–0.2 μm) has changed our understanding of energetics and nutrient cycling in both marine and freshwater systems (Sherr and Sherr 1991; Steinberg and Geller 1993). The classical aquatic food chain from diatoms to metazoans to small fish to large fish holds only for pieces of a more complex web. The size-class microbial groups are both taxonomically and trophically diverse, including photoautotrophic and heterotrophic prokaryotes and eukaryotes. Mixotrophs abound and feeding is based as much on the relative sizes of predator and prey as on classical trophic categories of primary producers, herbivores and predators (Sherr and Sherr 1991). Consequently, large fractions (20–60%) of primary production are cycled through 'microbial loops' with no link to macrofauna due to the energetic losses at trophic stages too small to be consumed by metazoans (Pomeroy and Wiebe 1988; Pomeroy 1991; Sherr and Sherr 1991).

In these loops, not unlike terrestrial ecosystems (e.g. Clarholm 1985; Jackson *et al.* 1989; Schimel *et al.* 1989), bacteria compete with primary producers (larger phytoplankton) for nutrients, rather than just serving as nutrient regenerators themselves, and grazing on bacteria is responsible for large amounts of nutrient regeneration (Pomeroy and Wiebe 1988; Pomeroy 1991; Goldman and Dennett 1992). The rapid nutrient recycling provided by the aquatic microbial loop leads to relatively stable primary production in oligotrophic systems. In such systems, the microbial pathway is favoured because low nutrient concentrations give a competitive advantage to smaller individuals (i.e. higher surface to volume ratios; Pomeroy 1991). As nutrient concentrations increase, as in seasonal lake turnovers or areas of oceanic upwelling, larger phytoplankton are favoured. These in turn are fed on by metazoans and those are subsequently eaten by fish. Due to the life-cycle constraints of metazoans, however, their growth frequently lags behind that of the blooming algae, whose populations become nutrient-limited and crash (Pomeroy 1991; Sherr and Sherr 1991). Thus, trophic diversity within the size-based groups leads to alternative pathways for nutrient and energy flow, and diversity among size-based groups results in different patterns of primary production (stable vs boom and bust) in response to the bottom-up controls of nutrient availability. Nutrients may

regulate the total productivity of some systems, but species characteristics (size, competitive abilities) regulate the relative amounts that flow to larger metazoans and fish. As with the redox functional groups, knowledge of the roles of individual microbial species is rare at best.

6.2.7.2.3 Species-specific interactions. When a single species has a strong effect on ecosystem processes, that species may be looked upon as a functional group with only one member. For example, for an exotic species to alter ecosystem processes, Vitousek (1986) lists the following criteria: that it must acquire or use resources differently from native species, that it must alter trophic structure, or that it must alter disturbance regime. The clearest cases of such effects for microbial species (whether invaders or not) are in species-specific interactions. The importance of individual microbial species is much better known for effects on economically important organisms, as for both mutualists and pathogens in agroecosystems, than for carbon and nutrient cycling in natural systems, particularly given the problems of identification discussed above. Microbial mutualists and pathogens, however, can have important ramifications in structuring natural ecosystems as well (e.g. N-fixing in primary succession and mycorrhizal associations: Vitousek and Walker 1989; Galloway 1992; Dhillion and Zak 1993; Read 1993; Schimel 1994; Chestnut blight (*Cryphonectria parasitica*), *Myxoma* virus, *Phytophthora cinnamomi*: Burdon 1993; Dobson and Crawley 1994; Castello *et al.* 1995). In cases with dramatic ecosystem level effects, both novel characteristics of the organisms involved and the specificity of the biotic interactions are relevant aspects of biodiversity.

6.2.7.2.4 Qualitative and stabilizing effects of diversity. Two important ways in which microbial diversity (and biodiversity in general) can affect ecosystem functioning are (1) qualitative effects, as with different functional groups (Chapin *et al.* 1994); and (2) stabilizing effects (cf. McNaughton 1977; Tilman and Downing 1994), as with diversity within functional groups. The sensitivity of ecosystem functioning to environmental change (anthropogenic or otherwise) becomes a question of the presence/absence of basic functional groups, the strength of control exerted on a given process or interaction, and the plasticity of organisms within groups to operate over a range of conditions. While many soil and aquatic bacteria are widespread, it is a myth that all microorganisms are distributed ubiquitously. Those that are restricted to special environments (e.g. isolated hot springs) or lack broad dispersal (many fungi, especially lichen-forming species) may not recolonize easily if they are lost from an ecosystem. Some of these, such as mycorrhizas, play key roles in the re-establishment of systems following disturbance (Perry *et al.* 1987, 1989; Dhillion and Zak 1993). At the same time, we have only very limited

knowledge of the identity and functional attributes of the myriad microbes found in even one gram of soil (see 6.2.2). Predictions of the strength of control are most easily and frequently based on abundances, though 'keystone' organisms/groups are often not recognizable on this basis. Predictability is a major problem, especially in microbial communities, as we often are not aware of species' roles as keystones until they are either lost from systems or introduced as invaders (Sherr and Sherr 1991; Bond 1993). For microbial groups whose members are cosmopolitan and whose activity depends on environmental conditions, ecosystem-level processes carried out by more diverse groups will probably continue as conditions change, but may be carried out by different organisms (Hobbie and Ford 1993). Of course, when conditions cross certain critical boundaries (as in going from aerobic to anaerobic), different organisms and processes may become active while others become inactive. The problem is the identification of the boundary conditions and rate changes through that spectrum of conditions and microbes. Thus, microbial diversity (and biodiversity in general) could be important in the sense that either (a) process rates are stabilized through a variety of environmental perturbations because of compensatory changes in community composition (cf. McNaughton 1977; Tilman and Downing 1994), or (b) process rates change as the species performing them change, due to differences in the functional properties of the organisms. In the first case, diversity is thought to be important for maintaining consistency (stability and/or resilience) in ecosystem properties/process; in the second case, it is seen as important for helping to create or maintain ecosystem heterogeneity through functional differences, (cf. Chapin *et al.* 1994; Schimel 1994). These seemingly contradictory statements point out the need to be precise about the expected ecosystem-level effects of diversity when addressing hypotheses on this topic.

The predictions may, in fact, not be contradictory, but just opposite ends of the perturbation spectrum. Shifts in dominance within a diverse extant community may stabilize processes over a relatively narrow range of environmental conditions; if changes are long enough or strong enough, however, and if appropriate organisms are present or can colonize, entirely different communities with different functional properties may become established (e.g. shifts in phytoplankton dominance with changes in nutrient availability).

6.2.7.3 Changes in biodiversity and microbial activity

Using the criteria of specificity of interactions, sensitivity to disturbance/change, and diversity within functional groups, we can recognize microbially mediated ecosystem processes sensitive to changes in biodiversity and those in which, in addition, anthropogenic forces have affected or may affect microbial diversity (Table 6.2-4). The biome

types (Chapter 6.1) in which occur both the anthropogenic forces and the microbial processes that are sensitive to those forces are also identified. In many cases, the reason for the biome listing is the prevalence of a particular type of disturbance; absence of a biome from the listing should not be taken to imply that it is necessarily resistant to that threat.

6.2.7.3.1 Biotic interactions. Species-specific biotic interactions, both mutualistic and pathogenic, are the most vulnerable to changes in microbial composition and diversity. The gain or loss of a microorganism involved in a mutualistic or pathogenic interaction can have consequences that range from subtle changes in competitive ability of the host species to the loss of populations or whole communities of macro-organisms. What makes an ecosystem process particularly susceptible to change, however, is difficult to predict. If only one or a few species of microorganisms are responsible for a mutualistic or pathogenic interaction of importance to an ecosystem process, the risk of changing that process given a loss of diversity is very high. If that species is widespread and disperses and colonizes easily, however, then the risk of actually losing it may be low. The most sensitive processes may be those controlled by highly specific interactions that are themselves sensitive to disturbance.

Nutrient-based mutualisms, especially those of mycorrhizas and nitrogen-fixers, are susceptible to eutrophication, acid precipitation and nutrient deposition, with major implications for forest health (Perry *et al.* 1989; Arnolds 1991; Vitousek 1994). Lichenized fungi are sensitive to a variety of chemical stresses (Galloway 1992) independent of biome type. These and other listed mutualisms are sensitive to physical disturbance (Pilz and Perry 1984; Perry *et al.* 1987) and to pollutants, such as acid and alkaline deposition (Adamson and Seppelt 1990; Lovett and Kinsman 1990; Richardson 1992), heavy metals (Zabowski *et al.* 1990; Richardson 1992), pesticides and radioisotopes (Haselwanter *et al.* 1988; Wood *et al.* 1990) in any system in which such anthropogenic stresses occur. In many systems (e.g. island and Mediterranean-type systems; D'Antonio and Dudley 1994; see 6.1.8), exotic species are frequently a problem, and these systems may suffer from addition of N-fixing species (e.g. Vitousek and Walker 1989; Table 6.2-4).

The zooxanthellae mutualists in corals and other marine organisms are sensitive to both natural and anthropogenic disturbances, including storm waves, freshwater pulses from flooding, nutrient loading, sedimentation and over-fishing (Holthus *et al.* 1989; Smith and Buddemeier 1992; Dollar and Tribble 1993; Richmond 1993; Hughes 1994). An important difference between these categories may be that many natural disturbances are episodic and allow recolonization, whereas many human disturbances are chronic and, while perhaps initially more subtle, can result

in long-term changes in viability of the mutualism and the health of the reef (Dollar and Tribble 1993; Hughes 1994; Richmond 1993). The role played by the zooxanthellae in ecosystem nutrient cycling and productivity is relatively well characterized compared to our understanding of how different microbial mutualists affect these processes (Cook and D'Elia 1987; Muscatine and Weis 1992; Falkowski *et al.* 1993). Indeed, it has only recently been discovered that the genetic diversity of algal symbionts, mostly classified within the genus *Symbiodinium*, is equivalent to the diversity between different orders of other microbes (Rowan and Powers 1991, 1992).

Arthropod gut microbiotas, while potentially sensitive due to the restricted number of microbes involved, may be less vulnerable because of lower degrees of host specificity (Martin 1991) than more closely allied mutualisms, such as the fungi of gall midges (Bisset and Borkent 1988) and algae in lichen thalli (Honegger 1992). This may be true in the case of trees able to form ectomycorrhizas with more than a single fungus, though variable environmental conditions and successional relationships could make this diversity important (Perry *et al.* 1989). Mycophagy is widespread in insects but the degree of specificity is frequently unclear (Hammond and Lawrence 1989). Disruption of a microorganism–arthropod mutualism or the sole food source of a fungus-feeding insect would be of particular significance if the arthropod was, for example, the pollinator of a predominant tree, i.e. held a keystone role.

Sensitive pathogenic interactions may be positive (e.g. biocontrol agents; Batra 1982) or negative (e.g. crop pathogens) from a human perspective, with exotic species introductions generally having the greatest visible impact (Dobson and Crawley 1994; Castello *et al.* 1995). Extreme cases can include destruction of dominant native trees by pathogens, with subsequent losses in macro-, meso- and microbiota (Podger and Brown 1989; Wills 1992). In agroecosystems, the genetic simplification of crop plants, rather than loss of microbial diversity itself, can result in adverse microbial outbreaks (Vanderplank 1982; Leonard and Fry 1989). Pathogenic interactions in natural communities may be equally important in determining ecosystem structure and functioning, but are often overlooked because of their subtlety and are much less extensively researched (Burdon and Leather 1990; Burdon 1993; Dobson and Crawley 1994).

6.2.7.3.2 Trace gas production. Microbial trace gas production can be sensitive to species interactions and is particularly important regionally and globally when land-use changes result in changes in rates of release to the atmosphere (Table 6.2-4). The oceanic production of dimethylsulphide (DMS) from relatively few species of phytoplankton plays an important role in atmospheric dynamics as the dominant natural source of sulphate

aerosols (6.2.4). Zooplankton grazing can dramatically increase rates of DMS release (Dacey and Wakeham 1986; Turner *et al.* 1988). The broad distribution of the species involved (Andreae and Jaeschke 1992), however, leads to controversy over whether or not disruption of this process due to species loss is likely in practice (6.2.4). Coastal systems have higher flux rates than pelagic systems and often suffer more intense disturbance from humans, both directly and indirectly through land-use transformations in adjacent terrestrial systems. While they have potential for greater changes in sulphur gas fluxes because of this, the relatively small area of these regions may make the inputs minor on a global scale (6.1.9; but see also 6.2.4).

Land-use transformations leading to increased methane release, such as livestock grazing and rice paddy management, are already responsible for part of the change in Earth's radiative balance (Watson *et al.* 1990). Methane production in temperate and tropical grasslands and agroecosystems is affected by management practices, while climate warming may affect methane production in saturated areas, particularly in northern ecosystems (Table 6.2-4). Changes in methane flux are due to impacts both on the microbial environment (e.g. inducing anoxic conditions necessary for the methanogen functional group, or increasing temperature) and on microbial interactions (e.g. by the bypassing, via plant aerenchyma, of diffusional and microbial (methane oxidizers) boundaries which normally impede transfer of methane to the atmosphere (see 6.2.4). While changes become globally significant only when extended over large areas, the extent to which landscape diversity *per se* contributes has not yet been fully explored.

6.2.7.3.3 Carbon and nutrient cycling. While microbial functional diversity is clearly important in the major nutrient and carbon transformations, the risk from biodiversity loss is scored as 'low' because many micro-organisms appear to be able to undertake these functions (Table 6.2-4). Successional relationships may, however, decrease some of the apparent redundancy. The extent to which this within-group diversity results in process heterogeneity (Schimel 1994) and/or the buffering of systems against changing environmental conditions or species loss, has yet to be determined for most of the processes involved in both terrestrial and aquatic systems. While nitrification is particularly susceptible to pH (Meyer 1993) and may be affected in certain areas by acid deposition, does this mean that the limits of a functional group have been exceeded or merely that pH exerts a direct control on the process? Changes in plant species composition, and thus litter quality, may occur in many biomes for a variety of reasons (e.g. climate change in Arctic, alpine and boreal systems: 6.1.1, 6.1.6; increased disturbance and therefore prevalence of more secondary successional species in tropical forests: 6.1.2; management regimes in grasslands: 6.1.7). This may change microbial

communities (Garland and Mills 1991; Zak *et al.* 1994), but it will probably not interrupt carbon and nutrient cycling. Extreme environments in which a minimal number of species fulfils each functional role could prove to be an important exception (e.g. Friedman *et al.* 1988; Table 6.2-4).

In one subcategory of carbon cycling — the microbial decomposition of hazardous wastes — microbial diversity is clearly important in dealing with the myriad toxic contaminants we have put into our natural and managed ecosystems (Aelion and Bradley 1991). Furthermore, diversity within communities, through co-metabolism, gene transfer via plasmids, provision of necessary co-factors and other mechanisms, is frequently necessary to degrade recalcitrant compounds (Weightman and Slater 1988). We do not know of threats to this diversity other than the inputs of xenobiotics themselves, which is happening in all biomes (Table 6.2-4). Community interactions such as those just listed may be important in other close microbial associations such as biofilms and microbial mats, but their potential for disruption, and the ecosystem consequences thereof, remain largely unexplored. The intentional release of genetically engineered micro-organisms poses yet another set of questions about the potential ecosystem-level effects of microbial diversity (Smit *et al.* 1992). See Section 10 for a further discussion of many of these issues.

In aquatic systems, microbes form the base of the food web leading to macrofauna. As previously described, microbial loops offer alternative pathways for primary production and nutrient transformations. In this case, trophic diversity within size-based functional groups (both plankton and metazoans) influences pathways of nutrient regeneration and carbon/energy flow, and has implications for fisheries (Pomeroy 1991; O'Brien *et al.* 1992; Steinberg and Geller 1993). Loss of phytoplankton productivity itself may not be currently under major threat from changes in microbial diversity (the major exception being cases of severe pollution which push environmental conditions beyond the bounds of most primary producers). However, both directly and through species interactions, nutrient loading can alter pathways of carbon cycling (e.g. Peterson *et al.* 1985, 1993), can result in plankton blooms leading to anoxia in extreme cases, and can also result in changes in species composition leading to outbreaks of noxious species such as red tide (6.1.9). Coastal and freshwater systems are particularly susceptible to such disturbances due to their proximity to terrestrial sediment, toxics and nutrient sources.

6.2.7.4 Conclusions

Despite our relative lack of knowledge in the face of the staggering diversity of microbes, we do know something about the importance of many microbial functional groups. We can begin to look at how microbial diversity affects

Table 6.2-4: Microbially mediated ecosystem processes and their sensitivity to the loss of biodiversity. See text for references.

Sensitivity ¹	Ecosystem functions	Interface ² and biome ³	Organisms	Ecosystem processes affected	Ecosystem processes involved	Human threats
High	Biotic interactions 1. Mutualisms	1,2,3 TeF, TrF, TrS	Mycorrhizas	Nutrient cycling, primary production physical disturbance	Nutrient and water uptake	Eutrophication, acid deposition,
		2,3,4 CoR, CoS, L&R, Med, TeF	N-fixers (nodule formers, cyanobacteria)	Nutrient cycling primary production	N-fixation	Eutrophication, physical disturbance, species introductions
		2,3,4 TeF, ArL	Lichens	Primary colonization, biogeochemical weathering	Photosynthesis, N-fixation	Acid deposition
		2,3,4 ArL	Cryptogamic crusts	Primary production, soil stabilization	N-fixation	Acid deposition, physical disturbances
		4 CoR	Corals	Primary and secondary production	Photosynthesis	Eutrophication, physical disturbances, sedimentation, over-fishing
		2 all	Arthropods/bacteria	Decomposition	Cellulose digestion	No known immediate threats
		2,3,4 AgE	Myriad	Primary and secondary production	Natural biocontrol and population control	Genetic simplification species introductions species losses
High	Trace gas production	1,3 AA, AgE, BoF, TeF, TeG, TrS	Methanogens/ methanotrophs	Radiative balance	Methane production and consumption	Land-use transformations e.g. grazing, rice paddies, N fertilization

High	Xenobiotic degradation	1,3 all	Myriad	Carbon cycling	Metabolism of recalcitrant/toxic substrates	Xenobiotics may both threaten diversity and select for novel organisms
Low/High	C and nutrient cycling	1,2,3,4,5	Microbes in extreme environments	Primary production, nutrient cycling, decomposition, soil structure		Physical and chemical disturbance – extent not known
Low/High	C and nutrient cycling	1,2,4 CoS, CoR, L&R, TrE	Phytoplankton	Primary production, secondary production, decomposition	Primary production	Severe pollution, eutrophication
Low	All other	1,2,3,4,5 AA, BoF, TeF, TeG, TrE, TrF	Myriad	Nutrient cycling, carbon cycling, soil formation	Decomposition, mineralization, nitrification, denitrification, immobilization primary production, ecosystem respiration. Soil organic matter synthesis and breakdown, etc.	Changes in plant species composition

-
1. 'Sensitivity' refers to potential for change/disruption of ecosystem processes due to change/loss of biodiversity; High = dependence on either a few species or very specific species interactions, or particularly subject to disruption. Low/high = in general assumed not to be sensitive but may be highly vulnerable in extreme environments or near-shore aquatic systems; Low = due to the lack of adequate information, generally assumed not to be sensitive.
 2. Interfaces: 1 = atmosphere/biotic; 2 = biotic/biotic; 3 = biotic/soil; 4 = biotic/hydrologic; 5 = soil/hydrologic.
 3. Biomes: AA = Arctic and Alpine; AgE = Agroecosystems; ArL = Arid Lands; BoF = Boreal Forests; CoR = Coral Reefs; CoS = Coastal systems; L&R = Lakes and Rivers; Med = Mediterranean-type; OpO = Open Oceans; TeF = Temperate Forests; TeG = Temperate Grasslands; TrE = Tropical Estuaries; TrF = Tropical Forests; TrS = Tropical Savannahs.

ecosystem-level processes, and how this may be threatened by human impacts, by using the criteria of specificity of interactions, sensitivity to disturbance, and diversity within functional groups. Some or all of the assumptions underlying these criteria may need further testing.

For carbon and nutrient transformations, the importance of microbial functional diversity is well known. However, these processes do not seem to be immediately threatened unless anthropogenic changes cross process-level thresholds by pushing the range of environmental conditions beyond either the ability of particularly sensitive and specific micro-organisms to operate (e.g. pH with nitrifiers; Meyer 1993) or the abilities of the microbial assemblages in that group to respond. This assumes that the species diversity within most functional groups related to carbon and nutrient cycling substantially buffers processes in changing conditions (Hobbie and Ford 1993). For this reason, we conjecture that microbial communities in extreme environments, in which a restricted number of species carry out each process step, are particularly susceptible to these changes. The role of diversity within functional groups, however, has barely been explored, not only for microbes but for most organisms and processes.

Biotic interactions, both mutualistic and pathogenic, belong to another category of microbial diversity that may substantially affect ecosystem-level processes and which is probably the one currently most threatened by anthropogenic activities. The sensitivity of mutualisms to disruption may be a function of both their specificity and the number of different species involved (again, within-functional group diversity), though ecosystem level impacts would be expected only where the interactions are widespread or in some sense 'keystone' in nature. Pathogenic interactions have the most dramatic effects on natural systems when either the host or the pathogen (or both) are introduced (Dobson and Crawley 1994).

For diverse functional groups, we need to look more closely at how changes in diversity affect the boundaries of processes (i.e. determine thresholds of functional change) as well as how such changes modulate the rates of those processes. For very specific biotic interactions or important element transfers carried out by few species, we need more information on their susceptibility to both physical or chemical disturbance. As McNaughton (1988) has previously observed, microcosm experiments which manipulate both species composition and diversity (e.g. Hairston *et al.* 1968) could provide useful insights both for microbial communities and for general principles on how diversity affects ecosystem properties.

References

- Adamson, E. and Seppelt, R.D. 1990. A comparison of airborne alkaline pollution damage in selected lichens and mosses at Casey Station, Wilkes Land, Antarctica. In: Kerry, K.R. and Hempel, G. (eds), *Antarctic Ecosystems*. 347–353. Springer-Verlag, New York.
- Aelion, C.M. and Bradley, P.M. 1991. Aerobic biodegradation potential of surface micro-organisms from a jet fuel-contaminated aquifer. *Applied and Environmental Microbiology* **57**: 57–63.
- Allsopp, D., Colwell, R.R. and Hawksworth, D.L. (eds) 1995. *Microbial Diversity and Ecosystem Function*. CAB International, Wallingford.
- Andreae, M.O. and Jaeschke, W.A. 1992. Exchange of sulphur between biosphere and atmosphere over temperate and tropical regions. In: Howarth, R.W., Stewart, J.W.B. and Ivanov, M.V. (eds.) *Sulfur Cycling on the Continents: Wetlands, terrestrial ecosystems, and associated water bodies*. 27–61. John Wiley, Chichester, UK.
- Arnolds, E. 1991. Decline of ectomycorrhizal fungi in Europe. *Agriculture, Ecosystems and Environment* **35**: 209–244.
- Barns, S.M., Fundyga, R.E., Jeffries, M.W. and Pace, N.R. 1994. Remarkable archaeal diversity detected in a Yellowstone National Park hot spring environment. *Proceedings of the National Academy of Sciences USA* **91**: 1609–1613.
- Batra, S.W.T. 1982. Biological control in agroecosystems. *Science* **215**: 134–139.
- Bisset, J. and Borkent, A. 1988. Ambrosia galls: the significance of fungal nutrition in the evolution of the Cecidomyiidae (Diptera). In: Pirozynski, K.A. and Hawksworth, D.L. (eds), *Coevolution of Fungi with Plants and Animals*. 203–225. Academic Press, London.
- Bond, 1993. Keystone species. In: Schulze, E.-D. and Mooney, H.A. (eds), *Biodiversity and Ecosystem Function*. 237–253. Springer-Verlag, Berlin.
- Burdon, J.J. 1993. The role of parasites in plant populations and communities. In: Schulze, E.-D. and Mooney, H.A. (eds), *Biodiversity and Ecosystem Function*. 165–179. Springer-Verlag, Berlin.
- Burdon, J.J. and Leather, S.R. (eds) 1990. *Pests, Pathogens and Plant Communities*. Blackwell Scientific Publications, Oxford.
- Castello, J.D., Leopold, D.J. and Smallidge, P.J. 1995. Pathogens, patterns, and processes in forest ecosystems. *BioScience* **45**: 16–24.
- Chapin, F.S., III, Reynolds, H., D'Antonio, C. and Eckhart, V. 1994. The functional role of species in terrestrial ecosystems. In: Walker, B. (ed), *Global Change in Terrestrial Ecosystems*. Cambridge University Press, Cambridge.
- Clarholm, M. 1985. Possible roles for roots, bacteria, protozoa and fungi in supplying nitrogen to plants. In: Fitter, A.H., Atkinson, D., Read, D.J. and Usher, M.B. (eds), *Ecology and Interactions in Soil: Plants, microbes and animals*. 355–365. Blackwell Scientific Publications, Oxford.
- Cook, C.B. and D'Elia, C.F. 1987. Are natural populations of zooxanthellae ever nutrient-limited? *Symbiosis* **4**: 199–212.
- Cook, R.B. and Kelly, C.A. 1992. Sulphur cycling and fluxes in temperate dimictic lakes. In: Howarth, R.W., Stewart, J.W.B. and Ivanov, M.V. (eds), *Sulfur Cycling on the Continents: Wetlands, terrestrial ecosystems, and associated water bodies*. 145–188. John Wiley, Chichester, UK.
- D'Antonio, C.M. and Dudley, T.L. 1994. Biological invasions as

- agents of change on islands versus mainlands. In: Vitousek, P.M., Adersen, H. and Loope, L.L. (eds), *Islands: Biodiversity and ecosystem function*. Springer-Verlag, Berlin.
- Dacey, J.W.H.** and Wakeham, S.G. 1986. Oceanic dimethylsulfide: production during zooplankton grazing on phytoplankton. *Science* **233**: 1314–1316.
- DeLong, E.F.**, Wu, K.Y., Prézelin, B.B. and Jovine, R.V.M. 1994. High abundance of Archaea in Antarctic marine picoplankton. *Nature* **371**: 695–697.
- Dhillon, S.S.** and Zak, J.C. 1993. Microbial dynamics in arid ecosystems: desertification and the potential role of mycorrhizas. *Revista Chilena de Historia Natural* **66**: 253–270.
- Dobson, A.** and Crawley, M. 1994. Pathogens and the structure of plant communities. *Trends in Ecology Evolution* **9**: 393–398.
- Dollar, S.J.** and Tribble, G.W. 1993. Recurrent storm disturbance and recovery: a long-term study of coral communities in Hawaii. *Coral Reefs* **12**: 223–233.
- Edwards, C.** (ed.) 1990. *Microbiology of Extreme Environments*. Open University Press, Milton Keynes, UK.
- Falkowski, P.G.**, Dubinsky, Z., Muscatine, L. and McCloskey, L. 1993. Population control in symbiotic corals. *BioScience* **43**: 606–611.
- Friedman, E.I.**, Hua, M. and Ooamp-Friedman, R. 1988. Cryptoendolithic lichen and cyanobacterial communities of the Ross Desert, Antarctica. *Polarforschung* **58**: 251–259.
- Galloway, D.J.** 1992. Biodiversity: a lichenological perspective. *Biodiversity and Conservation* **1**: 312–323.
- Garland, J.L.** and Mills, A.L. 1991. Classification and characterization of heterotrophic microbial communities on the basis of patterns of community-level sole-carbon-source utilization. *Applied and Environmental Microbiology* **57**: 2351–2359.
- Giovannoni, S.J.**, Britschgi, T.B., Moyer, C.L. and Field, K.G. 1990. Genetic diversity in Sargasso Sea bacterioplankton. *Nature* **345**: 60–63.
- Goldman, J.C.** and Dennett, M.R. 1992. Phagotrophy and NH_4^+ regeneration in a three-member microbial food loop. *Journal of Plankton Research* **14**: 649–663.
- Guerreo, R.** and Pedros-Alio, C. (eds) 1993. *Trends in Microbial Ecology*. Spanish Society for Microbiology, Barcelona.
- Hairston, N.G.**, Allan, J.D., Colwell, R.K., Futuyma, D.J., Howell, J., Lubin, M.D., Mathias, J. and Vandermeer, J.H. 1968. The relationship between species diversity and stability: an experimental approach with protozoa and bacteria. *Ecology* **49**: 1091–1101.
- Hammond, P.M.** and Lawrence, J.F. 1989. Mycophagy in insects. In: Wilding, N., Collins, N.M., Hammond, P.M. and Webber, J.F. (eds), *Insect-Fungus Interactions*. 275–324. Academic Press, London.
- Haselwanter, K.M.**, Berreck, M. and Brunner, P. 1988. Fungi as bioindicators of radiocesium contamination: Pre- and Post-Chernobyl activities. *Transactions of the British Mycological Society* **90**: 171–174.
- Hawksworth, D.L.** 1991. The fungal dimension of biodiversity: magnitude, significance, and conservation. *Mycological Research* **95**: 641–655.
- Hawksworth, D.L.** and Colwell, R.R. 1992. Microbial Diversity 21: biodiversity amongst micro-organisms and its relevance. *Biodiversity and Conservation* **1**: 221–226.
- Hawksworth, D.L.** and Ritchie, J.M. 1993. *Biodiversity and Biosystematic Priorities: Micro-organisms and invertebrates*. CAB International, Wallingford.
- Hedrick, D.B.**, Pledger, R.D., White, D.D. and Baross, J.A. 1992. *In situ* microbial ecology of hydrothermal vent sediments. *FEMS Microbiology Ecology* **101**: 1–10.
- Hobbie, J.E.** and Ford, T.E. 1993. A perspective on the ecology of aquatic microbes. In: Ford, T.E. (ed.), *Aquatic Microbiology: an Ecological Approach*. 1–14. Blackwell Scientific Publishers, Oxford.
- Holthus, P.F.**, Maragos, J.E. and Evans, C.W. 1989. Coral reef recovery subsequent to the freshwater kill of 1965 in Kaneohe Bay, Oahu, Hawaii. *Pacific Science* **43**: 122–134.
- Honegger, R.** 1992. Lichens: mycobiont-photobiont relationships. In: Reisser, W. (ed.), *Algae and Symbioses*. 255–275. Biopress, Bristol.
- Howarth, R.W.** and Stewart, J.W.B. 1992. The interactions of sulphur with other element cycles in ecosystems. In: Howarth, R.W., Stewart, J.W.B. and Ivanov, M.V. (eds), *Sulfur Cycling on the Continents: Wetlands, terrestrial ecosystems, and associated water bodies*. 67–84. John Wiley, Chichester.
- Hughes, T.P.** 1994. Catastrophes, phase shifts, and large-scale degradation of a Caribbean coral reef. *Science* **265**:
- Jackson, L.E.**, Schimel, J.P. and Firestone, M.K. 1989. Short-term partitioning of ammonium and nitrate between plants and microbes in an annual grassland. *Soil Biology and Biochemistry*. **21**: 409–416.
- Leonard, K.J.** and Fry, W.E. (eds), 1989. *Plant Disease Epidemiology: Genetics, resistance, and management*. Vol. 2. McGraw-Hill, New York.
- Lovett, G.M.** and Kinsman, J.D. 1990. Atmospheric pollution deposition to high elevation ecosystems. *Atmosphere and Environment* **24A**: 2767–2786.
- Martin, M.M.** 1991. The evolution of cellulose digestion in insects. *Transactions of the Royal Society of London, B* **333**: 281–288.
- McNaughton, S.J.** 1977. Diversity and stability of ecological communities: a comment on the role of empiricism in ecology. *American Naturalist* **111**: 515–525.
- McNaughton, S.J.** 1988. Diversity and stability. *Nature* **333**: 204–205.
- Meyer, O.** 1993. Functional groups of micro-organisms. In: Schulze, E.-D. and Mooney, H.A. (eds), *Biodiversity and Ecosystem Function*. 67–96. Springer-Verlag, Berlin.
- Muscatine, L.** and Weis, V. 1992. Productivity of zooxanthellae and biogeochemical cycles. In: Falkowski, P.G. and Woodhead, A.D. (eds), *Primary Productivity and Biogeochemical Cycles in the Sea*. 257–271. Plenum Press, New York.
- O'Brien, W.J.**, Hershey, A.E., Hobbie, J.E., Hullar, M.A., Kipphut, G.W., Miller, M.C., Moller, B. and Vestal, J.R. 1992. Control mechanisms of arctic lake ecosystems: a limnocorral experiment. *Hydrobiologia* **240**: 143–188.
- Olsen, G.J.** 1994. Archaea, Archaea, everywhere. *Nature* **371**: 657–658.
- Perry, A.D.M.**, Amaranthus, M.P., Borchers, J.G., Borchers, S.L. and Brainerd, R.E. 1989. Bootstrapping in ecosystems. *BioScience* **39**: 230–237.
- Perry, D.A.**, Molina, R. and Amaranthus, M.P. 1987.

- Mycorrhizae, mycorrhizospheres and reforestation: current knowledge and research needs. *Canadian Journal of Forest Research* **17**: 929–940.
- Peterson, B.J., Deegan, L., Helfrich, J., Hobbie, J.E., Hullar, M.A.J., Moller, B., Ford, T.E., Hershey, A.E., Hiltner, A., Kipphut, G., Lock, M.A., Fiebig, D.M., McKinley, V., Miller, M.C., Vestal, J.R., Ventullo, R.M. and Volk, G.** 1993. Biological responses of a tundra river to fertilization. *Ecology* **74**: 653–672.
- Peterson, B.J., Hobbie, J.E., Hershey, A.E., Lock, M.A., Ford, T.E., Vestal, J.R., McKinley, V.L., Hullar, M.A.J., Miller, M.C., Ventullo, R.M. and Volk, G.S.** 1985. Transformation of a tundra river from heterotrophy to autotrophy by addition of phosphorus. *Science* **229**: 1383–1385.
- Pilz, P.D. and Perry, D.A.** 1984. Impact of clearcutting and slash burning on ECM associations of Douglas-fir seedlings. *Canadian Journal of Forest Research* **14**: 94–100.
- Podger, F.D. and Brown, M.J.** 1989. Vegetation damage caused by *Phytophthora cinnamomi* on disturbed sites in temperate rainforest in western Tasmania. *Australian Journal of Botany* **37**: 443–480.
- Pomeroy, L.R.** 1991. Relationships of primary and secondary production in lakes and marine ecosystems. In: Cole, J., Lovett, G. and Findlay, S. (eds), *Comparative Analyses of Ecosystems: Patterns, mechanisms and theories*. 97–119. Springer-Verlag, New York.
- Pomeroy, L.R. and Wiebe, W.J.** 1988. Energetics of microbial food webs. *Hydrobiologia* **159**: 7–18.
- Price, D.** 1988. An overview of organismal interactions in ecosystems in evolutionary and ecological time. *Agriculture, Ecosystems and Environment* **24**: 369–377.
- Read, D.J.** 1993. Plant–microbe mutualisms and community structure. In: Schulze, E.-D. and Mooney, H.A. (eds), *Biodiversity and Ecosystem Function*. 181–209. Springer-Verlag, Berlin.
- Richardson, D.H.S.** 1992. *Pollution Monitoring with Lichens*. Naturalists' Handbook No.19. Richmond Publishing, Slough, UK.
- Richmond, R.H.** 1993. Coral reefs: present problems and future concerns resulting from anthropogenic disturbance. *American Zoologist* **33**: 524–536.
- Rowan, R. and Powers, D.** 1991. A molecular genetic classification of zooxanthellae and the evolution of animal–algal symbioses. *Science* **251**: 1348–1351.
- Rowan, R. and Powers, D.A.** 1992. Ribosomal RNA sequences and the diversity of symbiotic dinoflagellates (zooxanthellae). *Proceedings of the National Academy of Sciences, USA* **89**: 3639–3643.
- Schimel, J.P.** 1994. Ecosystem consequences of microbial diversity and community structure. In: Chapin, F.S., III and Korner, C. (eds), *Arctic and Alpine Biodiversity: Patterns, causes, and ecosystem consequences*. Springer-Verlag, Berlin.
- Schimel, J.P., Jackson, L.E. and Firestone, M.K.** 1989. Spatial and temporal effects on plant-microbial competition for inorganic nitrogen in a California annual grassland. *Soil Biology and Biochemistry* **21**: 1059–1066.
- Schlesinger, W.H.** 1991. *Biogeochemistry: An analysis of global change*. Academic Press, San Diego.
- Schopf, J.W.** 1993. Microfossils of the Early Archean apex chert: new evidence of the antiquity of life. *Science* **260**: 640–646.
- Sherr, E.B. and Sherr, B.F.** 1991. Planktonic microbes: tiny cells at the base of the ocean's food webs. *Trends in Ecology and Evolution* **6**: 50–54.
- Smit, E., Van Elsas, J.D. and Van Veen, J.A.** 1992. Risks associated with the application of genetically modified microorganisms in terrestrial ecosystems. *FEMS Microbiology Reviews* **88**: 263–278.
- Smith, S.V. and Buddemeier, R.W.** 1992. Global change and coral reef ecosystems. *Annual Review of Ecology and Systematics* **23**: 89–118.
- Steinberg, C.E.W. and Geller, W.** 1993. Biodiversity and interactions within pelagic nutrient cycling and productivity. In: Schulze, E.-D. and Mooney, H.A. (eds), *Biodiversity and Ecosystem Function*. 43–64. Springer-Verlag, Berlin.
- Tilman, D. and Downing, J.A.** 1994. Biodiversity and stability in grasslands. *Nature* **367**: 363–365.
- Trüper, H.G.** 1992. Prokaryotes: an overview with respect to biodiversity and environmental importance. *Biodiversity and Conservation* **1**: 227–236.
- Turner, S.M., Malin, G., Liss, P.S., Harbour, D.S. and Holligan, P.M.** 1988. The seasonal variation of dimethyl sulfide and dimethylsulfoniopropionate concentrations in nearshore waters. *Limnology and Oceanography* **33**: 364–375.
- Vanderplank, J.E.** 1982. *Host-Pathogen Interactions in Plant Disease*. Academic Press, New York.
- Vestal, J.R. and Hobbie, J.E.** 1988. Microbial adaptations to extreme environments. In: Lynch, J.M. and Hobbie, J.E. (eds), *Micro-organisms in Action: Concepts and applications in microbial ecology*. 193–206. Blackwell Scientific, Oxford.
- Vitousek, P.M.** 1986. Biological invasions and ecosystem properties: can species make a difference? In: Mooney, H.A. and Drake, J.A. (eds), *Ecology of Biological Invasions of North America and Hawaii*. 163–176. Springer-Verlag, New York.
- Vitousek, P.M.** 1994. Beyond global warming: ecology and global change. *Ecology* **75**: 1861–1876.
- Vitousek, P.M. and Hooper, D.U.** 1993. Biological diversity and terrestrial ecosystem biogeochemistry. In: Schulze, E.-D. and Mooney, H.A. (eds), *Biodiversity and Ecosystem Function*. 3–14. Springer-Verlag, Berlin.
- Vitousek, P.M. and Walker, L.R.** 1989. Biological invasion by *Myrica faya* in Hawaii: Plant demography, nitrogen fixation, ecosystem effects. *Ecological Monographs* **59**: 247–265.
- Ward, D.M., Weller, R. and Bateson, M.M.** 1990. 16S rRNA sequences reveal numerous uncultured micro-organisms in a natural community. *Nature* **345**: 63–65.
- Watson, R.T., Rodhe, H., Oeschger, H. and Siegenthaler, U.** 1990. Greenhouse gases and aerosols. In: Houghton, J.T., Jenkins, G.J. and Ephraums, J.J. (eds), *Climate Change: The IPCC Scientific Assessment*. 1–40. Cambridge University Press, Cambridge.
- Weightman, A.J. and Slater, J.H.** 1988. The problem of xenobiotics and recalcitrance. In: Lynch, J.M. and Hobbie, J.E. (eds), *Micro-organisms in Action: Concepts and applications in microbial ecology*. 322–347. Blackwell Scientific, Oxford.
- White, D.C., Ringel, D.B., Guckert, J.B. and Phelps, T.J.** 1991. Biochemical markers for *in situ* microbial community structure. In: Flierman, C.B. and Hazen, T.C. (eds), *Proceedings of the*

First International Symposium on Microbiology of the Deep Subsurface. 4-45 to 4-56. WSRC Information Services, Aiken, South Carolina.

Wills, R.T. 1992. The ecological impact of *Phytophthora cinnamomi* in the Stirling Range National Park, Western Australia. *Australian Journal of Ecology* **17**: 145–159.

Wood, W.F., Marsh, K.V., Buddemeier, R.W. and Smith, C. 1990. Marine biota as detection agents for low-level radionuclide contamination in Antarctica and the southern hemisphere oceans. In: Kerry, K.R. and Hempel, G. (eds), *Antarctic Ecosystems*. 372. Springer-Verlag, New York.

Zabowski, D., Zasoske, R.J., Little, W. and Ammirati, J. 1990. Metal content of fungal sporocarps from urban, rural and sludge-treated sites. *Journal of Environmental Quality* **19**: 372–377.

Zak, J.C., Willig, M.R., Moorhead, D.L. and Wildman, H.G. 1994. Functional diversity of microbial communities: a quantitative approach. *Soil Biology and Biochemistry* **26**: 1101–1108.

6.2.8 Agroecosystems

6.2.8.1 Introduction

Agroecosystems are ecosystems in which people have deliberately selected crop plants and livestock animals to replace the natural flora and fauna. These artificial systems vary enormously in the intensity of human intervention (Harwood 1979), from those with only low-intensity management (e.g. shifting cultivation, home gardens, nomadic pastoralism, traditional compound farms, rotational fallows and savannah mixed farming) to those of middle-intensity management (including multiple cropping, horticulture, improved pasture mixed farming and alley farming), and high-intensity management (intensive cereal cropping and crop rotations, orchards and plantations, and intensive livestock raising). Intensive cropping systems are often monospecific and usually composed of genetically uniform plant stands. Functioning in agroecosystems is determined by the production goals of the farmer which include economic, cultural and often aesthetic values as well as those of biological production. Dependent on the circumstances of the farmer, preference may be given to short-term maximization of specialized productivity or to the diversity, persistence and stability of production. These factors influence the way in which biodiversity is managed.

6.2.8.2 Impact of agricultural intensification on relevant biodiversity components

There is no simple quantitative index of agricultural intensification but increasing human intervention results in a deliberate reduction of the diversity of plant and vertebrate animal species. Continuing harvesting and the practices of plant, soil and pest management lower the diversity of associated plants, invertebrates and microbes (Swift *et al.* 1995). Many of the changes in ecosystem diversity and complexity associated with intensification

affect a variety of ecosystem functions. Modern intensive agriculture utilizes a narrow range of crop species and genetic varieties which have been bred for high yield, including response to inorganic fertilizers and resistance to selected pests and diseases (Vanderplank 1984; Fageria 1992). Less intensive systems commonly incorporate a wider range of species and genotypes which serve a variety of production goals and/or are used for differential exploitation of microhabitats, and for their resistance to diseases and pests (Ramakrishnan 1992). Decreased plant diversity often reduces the overall biomass and almost invariably the structural complexity of the ecosystem. Multi-strata high-biomass vegetation is replaced by single-canopy monocrops often incorporating varieties with a reduced proportion of non-grain biomass. Complex horizontal patterns of intercropping are succeeded by monocultural row cropping (Wolman and Fournier 1987). Decreases in the diversity of plant species lead to increased pest and disease problems. This is accompanied by a drop in the diversity of invertebrate consumers, predators and parasites (Altieri and Liebmann 1986) a feature further exacerbated by the use of pesticides. Substitution of annual for perennial vegetation reduces the extent of soil cover and produces periods when the soil is left bare. These selective influences produce decreases in the quantity and diversity of organic matter inputs and residues, the mineral nutrient content of which may be substituted by inorganic fertilizers. Decreases in organic inputs and removal or burning of residues also reduce soil cover. Above-ground changes are reflected below ground by decreased biomass, diversity and complexity of rooting systems, and particularly the absence of deep rooting which comes from exclusion of trees from the systems (Persson and McMichael 1991).

At the landscape scale, intensification of agriculture commonly includes an increase in the size of fields and progressive specialization in production goals leading to homogenization of the landscape both within farms and across substantial areas or even regions (Wolman and Fournier 1987). This entails a move away from farming systems with a diversity of different production systems, e.g. home gardens (gardens for fruit, vegetables, spices and medicines), a variety of specialized or species-diverse crop fields, including systems related to specific micro-environments (e.g. wetlands used for rice cultivation) and associated livestock production areas (including aquaculture in wetlands) (Okigbo and Greenland 1976). This homogenization reduces the complexity of the interface between units on the landscape and leads to reduced biological migration, habitat diversity (particularly of ecotones) and disruption of nutrient flows.

6.2.8.3 Ecosystem consequences of impacts

6.2.8.3.1 Productivity capacity, biomass and decomposition. The utilization of high-yielding varieties

has enabled farmers to exploit the full range of yield potential for many crops in many environments (Fageria 1992). Monocultures also can increase the efficiency of management by facilitating harvesting and simplifying marketing of the product. The narrowing of the genetic base for host resistance (particularly by dependence on a few 'major genes') produces an increased risk of yield loss through epidemic outbreaks in contrast to the 'chronic' status of disease in systems with a range of genotypes including those incorporating 'tolerance' characteristics and multiple-gene resistance (Vanderplank 1984). In some environments intercrops, tree-crop combinations and rotations show significant yield advantages over monocrops (Francis 1989; Vandermeer 1989). A component of this yield advantage is attributed to reduced pest and weed infestation due to enhanced natural biological control by natural predators (Altieri 1987). Reduced amounts and diversity of organic residues result in a reduced range of decomposition rates in intensive systems (Tian *et al.* 1992).

6.2.8.3.2 Soil structure and nutrients. The practices employed in clearing land for cultivation, subsequent tillage, the lowered diversity and complexity of rooting systems, and the decreased biomass and diversity of organic inputs to the soil, all act to reduce the diversity of soil organisms (Hendrix *et al.* 1990; Swift and Anderson 1992). These changes in below-ground diversity may extend to the elimination of keystone species or even entire functional groups. Some of the groups are general in distribution e.g. nitrogen-fixing bacteria, mycorrhizal fungi and predators of soil-borne pests, whilst others such as earthworms and termites are more environmentally restricted in their distribution. Clearing of vegetation and subsequent tillage leads to a decline in soil organic matter and the consequent loss of associated properties of nutrient storage, cation exchange and moisture-holding capacities (Greenland 1981). Decline in SOM is most rapid in tropical environments and also has more serious effects in the highly weathered soils of these areas which have low activity clays and thus little capacity to compensate for loss of the functions associated with SOM. Increased use of inorganic N, together with enhanced decomposition and nitrification rates, results in increased loss of N as NO_3 leachate or by volatilization or denitrification and soil acidification (Lowrance *et al.* 1983). The availability of high levels of inorganic N may also increase the nitrate to protein ratio in above-ground vegetation leading to enhanced susceptibility to pests and pathogens (Altieri 1987). Reduced vegetation and litter cover increases the risk of erosion (Boarden *et al.* 1990) and recorded rates of erosion in many environments now indicate losses of topsoil much in excess of the rates of renewal (Pimentel 1993). Increased biomass of livestock can result in soil compaction and changes in soil water regimes (Bochet 1983).

6.2.8.3.3 Water distribution, balance and quality. Decreased soil cover from canopy and litter together with a lack of contour barriers and deep-rooting plants results in decreased infiltration and increased water runoff (Hamilton and King 1983). Increased use of inorganic fertilizers across the landscape, associated with decreased capacity of the soil community to immobilize nutrients, and the absence of deep-rooting systems, leads to eutrophication of ground water (Lowrance *et al.* 1983). The same effects may be felt from disposal of high-N manures from intensive livestock production.

6.2.8.3.4 Atmospheric properties. Enlargement of the net area of agricultural land gives rise to increased CO_2 , CH_4 and NO_2 when the primary productivity of the subsequent cropping system is lower than that of the vegetation it replaces. This difference is most marked in agriculture based on annual cropping, but it may be significant even in fallow rotation systems where the biomass and persistence of vegetation is low due to shortening of the fallow period. Similarly continued burning of residues may or may not lead to net emission balances dependent on whether or not this is balanced by subsequent fixation of C and N. Additional changes in carbon equilibrium come from oxidation of soil organic matter in the absence of a sufficient input of organic matter to balance this loss (Bouwman and Sombroek 1990). Agroecosystems with higher plant biomass (e.g. those incorporating trees or with fallow biomass periods in the cropping cycle) can help to compensate for these imbalances. Clearing of natural vegetation, and drainage of wetlands for cultivation, may be a major source of CO_2 emission from oxidation of the large stocks of organic matter. Methane is generated from anaerobic decomposition in wetlands, and increases in the area of permanently or near-permanently flooded rice cultivation are thought to account for a significant proportion of the increase in net CH_4 emission (Schutz *et al.* 1990). Intermittently wet and dry systems produce less CH_4 but more CO_2 . Methane is also produced by anaerobic digestion in animal guts and increased specialization of ruminant production has contributed significantly to global CH_4 emission (Schutz *et al.* 1990). Increases in N_2O emissions have been linked to the stimulation of denitrification following intensified use of inorganic-N fertilizers (Bouwman and Sombroek 1990) and from expansion of the area of flooded cultivation.

6.2.8.3.5 Landscape and waterscape structure. Complex agroecosystems have substantial linkages between production units in the form of natural migrations of biota (e.g. of pest predators from fallow vegetation refuges to crop areas; livestock feeding in crop fields in the dry season) or of materials (e.g. transfer of nutrients and organic matter from livestock pens as

fertilizer to arable fields; cutting of fodder in fallow areas; Swift *et al.* 1989). Specialization in production and simplification of the landscape have increased the economic efficiency of many intensive agricultural systems resulting in highly productive and profitable agribusinesses. Homogenization of farming areas leads to changes in hydrological patterns such as increased and less stable flows of water across the landscape, particularly above ground (Hamilton and King 1983; Lowrance *et al.* 1983). This, together with a lack of windbreaks, increases the rates of erosion and disruption of nutrient cycles. These effects can be reduced by increased vegetational cover and use of appropriate soil conservation methods which also lead to improved diversity. When these factors are included in the economic cost of modern agriculture the economic and energetic efficiency advantage over more diverse systems or landscapes is substantially reduced (Pimentel and Pimentel 1979). Agricultural homogenization has an impact far beyond the field (ecosystem) scale by removing refuges and microhabitats for the migration of biota, and by creating a more exposed and harsher environment.

6.2.8.3.6 Biotic linkages and species interactions. The biotic and structural simplification that result from agricultural intensification necessarily reduces the variety of biotic linkages in the system, including those below ground (Edwards *et al.* 1988). Intensive agroecosystems are as a consequence unstable in many respects (e.g. open nutrient cycles, reduced capacity for biological pest control, greater susceptibility to climatic change, Edwards *et al.* 1990). These biological controls are substituted by industrially based regulators such as fertilizers, pesticides and mechanical management. The alternative to substitution is the redesign of agroecosystems to include greater biological diversity and complexity. Such systems (e.g. modern multiple cropping and agroforestry) have enhanced capacities for self-regulation of pests and diseases, tighter nutrient cycles and higher energetic efficiency (Altieri 1987; Swift *et al.* 1995).

6.2.8.3.7 Microbial activities. Agricultural intensification leads to changes in diversity, composition and abundance in all studied groups of micro-organisms. Effects on functioning are variable. The range of pathogenic interventions may be narrowed but the intensity may be increased; symbiotic functioning such as N-fixation and mycorrhiza may be diminished by the use of inorganic N and P fertilizers (eg. Ladha *et al.* 1992; Read *et al.* 1992) but nitrification may be enhanced. On the other hand, although total microbial biomass may decrease there is little evidence that general functioning such as decomposition or SOM dynamics are affected (Swift *et al.* 1995).

References

- Altieri, M.A. 1987. *Agroecology: The scientific basis of alternative agriculture*. IT Publications, London.
- Altieri, M.A. and Liebman, M. 1986. Insect, weed and plant disease management in multiple cropping systems. In: Francis, C.A. (ed.), *Multiple Cropping Systems*, 183–218. Macmillan, New York.
- Boarden, J., Foster, I.D.L. and Dearing, J.A. (eds) 1990. *Soil Erosion on Sloping Land*. John Wiley, Chichester.
- Bochet, J.J. 1983. *Management of upland watersheds*. FAO Conservation Guide No. 8. FAO, Rome.
- Bouwman, A.F. and Sombroek, W.G. 1990. Inputs to climatic change by soil and agriculture related activities; present status and possible future trends. In: Scharpenseel, H.W., Schomacker, M. and Ayoub, A. (eds), *Soils on a Warmer Earth*. Developments in Soil Science. 20. 15–30. Elsevier, Amsterdam.
- Edwards, C.A., Lal, R., Madden, P., Miller, R.H. and House, G. (eds) 1990. *Sustainable Agricultural Systems, Soil and Water Conservation Society*, Ankey.
- Edwards, C.A., Stinner, B.R., Stinner, D. and Rabatin, S. (eds) 1988. *Biological Interactions in Soil*. Elsevier, Amsterdam.
- Fageria, N.K. 1992. *Maximising Crop Yields*. Marcel Dekker, New York.
- Francis, C.A. 1989. Biological efficiencies in multiple-cropping systems. *Advances in Agronomy* 42: 1–42.
- Greenland, D.J. 1980. The nitrogen cycle in West Africa: agronomic considerations. In: Rosswall, T. (ed.), *Nitrogen Cycling in West African Ecosystems*, 73–81, SCOPE/UNEP, Stockholm.
- Hamilton, P.S. and King, P.N. 1983. Tropical Forested Watersheds: Hydrologic and soils response to major uses or conversions. Westview Press, Boulder, Colorado.
- Harwood, 1979. *Small Farm Development: Understanding and improving farming systems in the humid tropics*, Westview Press, Boulder, Colorado.
- Hendrix, P.F., Crossley, D.A., Blair, J.M. and Coleman, D.C. 1990. Soil biota as components of sustainable agroecosystems. In: Edwards, C.A., Lal, R., Madden, P., Miller, R.H. and Haise, G. (eds), *Sustainable Agricultural Systems*, 637–654. Soil and Water Conservation Society, Ankey.
- Ladha, J.K., George, T. and Bohlool, B.B. (eds) 1992. *Biological Nitrogen Fixation for Sustainable Agriculture*. Kluwer/IRRI, Dordrecht.
- Lowrance, R.R., Todd, R.L., Asmussen, L.E. and Leonard, R.A. (eds) 1983. *Nutrient Cycling in Agricultural Systems*. Special Publication 23. University of Georgia College of Agriculture, Athens.
- Okigbo, B.N. and Greenland, D.J. 1976. Intercropping systems in tropical Africa. In: Papendick, R.I., Sanchez, P.A. and Triplett, G.B. (eds), *Multiple Cropping*. 63–102, American Society of Agronomy, Madison, Wis.
- Persson, H. and McMichael, B.L. (eds) 1991. *Plant Roots and their Environment*. Elsevier, Amsterdam.
- Pimentel, D. (ed.) 1993. *World Soil Erosion and Conservation*. Cambridge University Press, Cambridge.
- Pimentel, D. and Pimentel, M. 1979. *Food, Energy and Society*. Edward Arnold, London.

- Ramakrishnan, P.S.** 1992. *Shifting Agricultural and Sustainable Development: An interdisciplinary study from North-Eastern India*. UNESCO-MAB Series, Paris, and Parthenon Publ., Carnforth.
- Read, D.J., Lewis, D.H., Fitter, A.H. and Alexander, I.J.** (eds) 1992. *Mycorrhizas in Ecosystems*. CAB International, Wallingford.
- Schutz, H., Seiler, W. and Rennenberg, H.** 1990. Soils and land use related sources and sinks of methane (CH₄) in the context of the global methane budget. In: Bouwman, A.F. (ed.), *Soils and the Greenhouse Effect*. 269–288. John Wiley, Chichester.
- Swift, M.J.** 1993. Maintaining the biological status of soil: a key to sustainable land management? In: Greenland, D.J., Knowland, J. and Szaboks, I. (eds) *Soil Resilience and Sustainable Land Use*. 235–248. CAB International, Wallingford.
- Swift, M.J. and Anderson, J.M.** 1992. Biodiversity and ecosystem function in agricultural systems. In: Schulze, E.D. and Mooney, H. (eds), *Biodiversity and Ecosystem Function*. 15–42. Springer-Verlag, Berlin.
- Swift, M.J., Frost, P.G.H., Campbell, B.M., Hatton, J.C.** 1989. Nitrogen cycling in farming systems derived from savannah: perspectives and challenges. In: Clarholm, M. and Bergstrom, L. (eds), *Ecology of Arable Land*. 63–76. Kluwer Academic Publishers, Dordrecht.
- Swift, M.J., Vandermeer, J., Ramakrishnan, P.S., Ong, C.K., Anderson, J.M. and Hawkins, B.** 1995. Biodiversity and agroecosystem function. In: Mooney, H.A. *et al.* (eds), *Biodiversity and Ecosystem Function*. SCOPE. John Wiley, Chichester (in press).
- Tian, G., Kang, B.T. and Brussaard, L.** 1992a. Biological effects of plant residues with contrasting chemical compositions under humid tropical conditions – decomposition and nutrient release. *Soil Biology and Biochemistry* **24**: 1051–1660.
- Vandermeer, J.** 1989. *The Ecology of Intercropping*. Cambridge University Press, Cambridge.
- Vanderplank, J.E.** 1984. *Disease Resistance in Plants*. Academic Press, Orlando, Fla.
- Wolman, M.G. and Fournier, F.G.A.** 1987. *Land Transformation in Agriculture*. SCOPE 32. John Wiley, Chichester.

6.3 Conclusions

6.3.1 Background

Understanding the role of biodiversity's elements in the functioning of ecosystems is a relatively new field of research endeavour. This science is crucial in its own right for learning about the evolution of biotic interactions, the structural and functional properties of ecosystems, and the degree of sensitivity of these properties to changes in underlying diversity. Understanding the functional role of biodiversity is also important in management applications. Valuable scientific principles and guidelines for making ecosystem management decisions are beginning to emerge in spite of the field's youth and the relatively small number of experimental studies from which we can draw. We can

expect much more to follow in the near future as these research areas gather momentum.

6.3.2 The importance of ecosystem approach

The ecosystem integrates both the physical and the biological environment, and thus changes in any of the elements of the ecosystem affect the quantity and quality of its functioning. These changes in functioning may themselves then affect the biological composition of the ecosystem, its physical characteristics, and its dynamics. From a very practical standpoint, it is the ecosystem, and the array of ecosystems over entire landscapes and regions, that provides a broad diversity of goods and services to human society. The ecosystem is the level of ecological organization that most closely corresponds to the primary targets of most management decisions. Therefore, understanding the functional consequences of changes in the underlying biodiversity assumes tremendous importance for managers and scientists alike.

6.3.3 Ecological goods and services

Of particular importance in understanding the role of changes in biodiversity in ecosystem functioning is the concept of ecological goods and services. Ecosystems obviously provide marketable commodities, e.g. food from fisheries and agroecosystems and timber from forests (Box 6.3-1). Ecosystems also provide a wealth of products from which marketable goods are made, e.g. taxol from the North American yew (*Taxus brevifolia*), or from which they can ultimately be synthesized, such as the precursor to taxol found in the commonly occurring European Yew (*Taxus baccata*) or the original sources of aspirin and

Box 6.3-1: Biodiversity's influence on yield.

Yield is one of the most important parameters to understand and manage sustainably in managed ecological systems. In agricultural systems, genetic diversity is very important for determining yield (Section 5.2.1). Although the highest known yields in terrestrial systems occur in species monocultures (6.2.1), substantial amounts of energy, fertilizer and pesticide are required to maintain these levels, and their long-term sustainability is difficult to ascertain. Moderate yields can be achieved without energy subsidies in managed mixed crops (6.2.8), suggesting that increased diversity at the species level can reduce the overall subsidies needed to maintain adequate, although not maximum, yields. Management that decreases animal diversity in pastures is correlated with increased yield of animal products (6.1.7). Loss of coastal habitat diversity can lead to lessening of production in unmanaged fisheries (6.1.9).

digitalis. Ecosystems further provide services for which there are obvious economic returns: ecotourism, whose popularity is growing world-wide, is one example, but the same principles hold for sport fishing and hunting, where the economic activities range from the purchase of licences to expenditures for travel and lodging.

Ecosystems also provide services that are more difficult to measure in economic terms, but which are nevertheless fundamentally important to our quality of life. For example, wetlands provide substantial capabilities to assimilate wastes and to purify the water that flows through them; microbial diversity can be important for the degradation of hazardous wastes; adequate functioning of the soil microbiota is partially responsible for the maintenance of soil fertility, while the contribution of intact forests in controlling soil erosion, particularly in mountainous regions, is well known. Although diminutions in these services can be shown to have social and economic costs, markets do not capture their full worth. They have thus been labelled 'free' services (Box 6.3-2). Our understanding of ecosystem functioning must be improved so as to enable society to maintain these 'free' services, as well as providing marketable goods and services. Building this understanding is an increasing challenge for managers and scientists.

6.3.4 Drivers of change

Human activities are now the dominant force in causing the alteration, redistribution and loss of biodiversity. The rate at which humans are altering the environment, the extent of that alteration, and the consequences of these changes for biological diversity are unprecedented in human history, and are now beginning to pose substantial threats to economic and cultural aspects of many societies. Depending on the circumstances, human activities may increase, maintain or diminish the diversity of species, genes or ecological communities in a given region and at a given time, but the general trend is an increasing loss of biodiversity at the global scale. Some of these changes, such as the erosion of genetic variability and the extinction of species, are truly irreversible: others are not, but the challenge of managing natural resources while maintaining adequate levels of biodiversity has increased markedly. Moreover, pressures on biological diversity are likely to increase still further as a consequence of human-induced climate change.

6.3.5 Factors affecting the functional sensitivities of ecosystems

Reductions in species diversity can reduce the ability of ecosystems either to resist stress from environmental factors or to recover from disturbance. For example, coral reefs, mangroves and kelp forests can buffer adjacent terrestrial systems from ocean waves, and thus the presence of coastal landscape diversity can mitigate the effects of

Box 6.3-2: Water quality and flood control: provision of 'free' services by ecosystems.

Biodiversity at both landscape level and species level influences water quality and quantity. For example, conversion of vegetation within a watershed from forest or shrubland to grassland increases stream-flow out of the watershed. Loss of the woody overstorey in riparian systems greatly increases water temperature, and reductions in the diversity and productivity of the herbaceous layer increase the velocity and erosive capacity of the stream-flow (6.1.7). Thus, landscape-level conversions, particularly those involving hydrological changes associated with clearing forested watersheds, can increase flows and the variance of flows, making flood control more difficult and expensive.

In aquatic ecosystems, even the addition of a single species can greatly affect water quality. For example, the accidental introduction of the zebra mussel into the Great Lakes greatly increased water clarity due to its tremendous filtering capacity and rapid population growth (Ludyanski *et al.* 1993). This increase in clarity, unfortunately, comes at the expense of many natural plankton communities, and thus affects fish populations.

storms that would otherwise produce substantial erosion (6.1.9; 6.1.10; 6.1.11). Experimental studies have shown that species-rich temperate grasslands exhibit smaller changes in plant biomass after drought than less rich areas (6.1.7). The existence of relatively undisturbed communities within a mosaic of different land uses can serve as sources of propagules, seeds and dispersing animals to recolonize areas that have been adversely affected by other stresses (6.1.1).

The sensitivity of ecosystem functioning to changes in biodiversity appears to be influenced in part by the number of species that contribute to processes in similar ways (6.2.2). For example, the functional consequences of species losses should be greatest for those systems that have few species – such as boreal forests, deserts and islands, because there are few species that can substitute for the deleted taxa, and thus the chance of adversely affecting an ecosystem process from even a single deletion is high (6.1.4; 6.1.6; 6.2.6; 6.2.7). For example, emissions of methane, nitrous oxide, dimethyl sulphide and volatile organic chemicals, each seem to depend on a limited number of taxonomic groups with functionally similar properties. It is not understood why this is the case, but it seems reasonable to presume that the marginal effect of losing any one of them would be high.

Conversely, ecosystems or processes with many functionally similar species should be better protected from such disruptions in the long term, because there are more species that respond differently to environmental stress. For example, a wide variety of organisms comprise the functional group of primary producers, and there is no good evidence that primary productivity in ecosystems depends strongly on the number of species, within reasonable limits (Box 6.3.3).

On short time scales, some degree of substitutability can be documented in particular cases (6.1.1). In a temperate grassland system, dominant species fully compensated for the removal of subordinate species, while the subordinate species only partially compensated for the removal of dominant species (6.1.7). Substitutability has some limitations, however. At the genetic level, populations may not be completely substitutable because of local adaptations. Thus, even for small areas, when a longer timescale is considered, our best understanding is that functional substitutability among species is limited, and it is unwise to assume that species are functionally redundant.

Ecosystems can vary tremendously in the number of functionally similar species they contain, and there is no consensus on what determines the number of functionally similar species in particular biomes. For example, marine ecosystems (open ocean, near coastal, estuarine) tend to have greater phyletic diversity among functionally similar species than do terrestrial ecosystems, due at least in part to their greater overall phyletic richness. Many tropical terrestrial ecosystems have large numbers of apparently

functionally similar species, especially when compared to their temperate analogues. Even within a climatic zone, historical factors can result in substantial variation in the number of functionally similar species, as is seen in the wide variation in numbers of flowering plant species in different zones of temperate deciduous forest and different Mediterranean ecosystems.

Each individual species may play many different functional roles, which are rarely fully understood. It is possible for an organism to have a suite of biological traits that confer on it a dynamic importance out of proportion to its abundance, i.e. it plays a keystone role in organizing structure and processes throughout an ecosystem. The effects of moose and reindeer on boreal and Arctic ecosystems; sea otters in northern California kelp forests; many parasitoids and parasites in biological control programmes; and the major grazers on grassland ecosystems, all provide well-documented examples. The full influence of such species is generally only seen and understood when it has been lost from the system. Our ability to predict *a priori* which species will have such effects is very poor, and they may occur in either species-poor or species-rich systems.

When changes in ecosystem composition and functioning do occur, they are often gradual. However, some systems, especially islands, lakes and agroecosystems, exhibit dynamic thresholds in their response to a major stress or disturbance that affects diversity. Others seem to be susceptible to chronic stress, and these tend to have very few species with functional similarities: e.g. boreal, Arctic and alpine systems.

Box 6.3-3: How does biodiversity influence productivity?

The relationship between biodiversity and primary productivity needs to be considered over both short and long time scales. On relatively short time scales and small spatial scales, the most important issue is whether reductions in species diversity will adversely impact productivity. Over longer time scales, the role of diversity in the maintenance of productivity in systems undergoing a variety of stresses becomes paramount.

In most biomes, primary productivity appears to be only weakly related to the number of plant species, as it usually peaks at relatively low species-richness levels (6.2.1; 6.1.2; 6.1.7). Diversity may play a role in the maintenance of productivity in the face of natural and human-induced change (e.g. disturbance, drought, climate change, toxins) (see 6.2.1; 6.1.2), and changes in landscape configuration can have large and long-lasting effects on regional productivity (e.g. banded vegetation systems, 6.2.5).

6.3.6 Invasions, introductions and species losses

International travel and trade, in addition to climatic variation, provide opportunities for the deliberate introduction or accidental invasion of species into new ecosystems. When a species enters an ecosystem in which it previously did not occur, it can either adversely disrupt ecosystem processes or have positive effects — such as providing biocontrol of pests or pathogens in agroecosystems. Microbial species introductions, particularly of plant pathogens, have had a large effect on ecosystem composition in both natural and managed systems, but these effects do not always have large observable effects on ecosystem processes (6.2.7). For example, the loss of chestnut from eastern deciduous forests in North America, due to the introduction of chestnut blight from Europe, was both rapid and dramatic, but there have been no discernible consequences for ecosystem functioning as other tree species seem to have fulfilled its original functional roles. On the other hand, introductions of new capabilities such as nitrogen fixation into ecosystems whose component species previously did not have this ability, typically have dramatic changes in

both composition and ecosystem functioning. The introduction of nitrogen-fixing trees into sites in Hawaii has led to a complete restructuring of the plant communities, with consequent changes in nutrient supply, fire frequency and water availability. Biotically impoverished systems whose major species have only limited genetic diversity, such as many production agroecosystems, are often very susceptible to the effects of introductions and invasions (5.2.1; 6.2.1; 6.2.6), with the introduction of pathogens being of primary concern.

Islands and ecosystems with relatively few component species, such as boreal forests, seem to be more susceptible to species invasions than species-rich biomes such as tropical forests, so it would be expected that invasion of species leading to disruption of ecosystem processes is more likely to occur in the former than in the latter (6.2.6). Freshwater ecosystems in all climatic zones also seem to be especially sensitive to invasions and introductions (6.1.13). In general, areas of ecosystems that have been subjected to disturbance or stress from other environmental factors, such as fire, drought, overgrazing or extensive clearing, can provide open habitat and resources that allow invaders to become established. Whether or not introduced species will spread from their original entrance depends on the particulars of their biology, and the biology of the native species they encounter. Apart from these generalizations, there is very little ability to predict *a priori* the effects of accidental or deliberate introductions, suggesting that considerable prudence be exercised.

6.3.7 Transformation and fragmentation of populations and ecosystems

The net effect of human activities may possibly be an increase in the overall diversity of ecosystem types around the world, some of which are extremely important to societal well-being. Human activities are, for example, directly responsible for creating agroecosystems. However, these increases in the diversity of ecosystem types have come at the expense of impoverishment of a great number of natural communities, and the reduction of at least some ecosystem services.

Some fragmentation of existing ecological communities is inevitable, except in areas that have been specifically protected. In nearly all cases, the fragmentation of existing communities reduces the diversity of native species in their natural habitats. Human impacts, in particular habitat loss, fragmentation and over-exploitation, tend to reduce severely the size of many biological populations, and this increases the risk that a population will be lost, ultimately leading to species' extinction. Even when the species does not become extinct, its loss from a local region or a major reduction in its population can have significant consequences for human livelihoods and ecological services. The species most likely to be lost are large

predators and other species with large body sizes and area requirements. Also likely to be lost are species with less ability to disperse among and colonize habitat patches. Species likely to survive fragmentation will be those best adapted to patchy and frequently disturbed environments, especially early successional and easily dispersed species. Fragmentation is thus expected to result in ecosystems dominated by such 'weedy' species. Such systems have characteristically higher losses of nutrients, nitrogen and carbon; higher litter quality and therefore faster decomposition rates; simpler spatial structure; and less overall protection from herbivory than the original communities that preceded them.

No biome is functionally resistant to landscape-scale changes in diversity, particularly those changes due to anthropogenic alterations. The large-scale conversion of ecosystems in landscapes tends to have long-lasting effects on system processes independently of whether the particular ecosystems were originally of high or low diversity. For example, the large-scale transformation of forested ecosystems to pastureland, grasslands and agriculture has been an important contributor to the increase in atmospheric carbon dioxide over the last several hundred years. The first phase of this transformation occurred in the developed countries of the Northern Hemisphere, but in recent decades tropical conversion of forested ecosystems to grassland has become the main contributor. During the 1980s, conversion of tropical forest to grassland contributed approximately 1.6 gigatons of carbon per year to the atmosphere, in addition to the 5.5 gigatons of carbon per year released by fossil fuel combustion. This was slightly offset by regrowth of temperate and boreal forests, which sequestered about 0.5 gigatons per year during the same time period. Improved management of forested ecosystems and reforestation in both the temperate and tropical regions can continue to sequester carbon from the atmosphere and move it to longer-lived soil pools, thus reducing the rate at which greenhouse gases are added to the atmosphere.

The interactions among different ecosystems determine a landscape's functional sensitivity to changes in diversity. Landscape-scale functions are affected by changes in diversity at lower hierarchical levels either when the changes in diversity affect the strength of the spatial interaction, or when the changes in diversity affect the strength of sources or sinks of the materials being transferred. There are characteristic differences in these aspects of ecosystem 'connectedness': e.g. ocean systems have high connectedness compared to terrestrial systems, therefore changes in one place may ultimately have effects far away. In many terrestrial systems, the connectedness of landscape components is determined by water flow, and thus both topography and vegetation play major roles in determining landscape-level functional responses. However,

even in terrestrial systems, atmospheric or climatic stress or disturbance, or processes that produce feedbacks to the atmosphere, operate through a medium that provides high connectedness. The acidification of soil and surface water in forested landscapes; changes in soil microflora; and loss of nitrogen from previously nitrogen-limited forests as a consequence of acid precipitation in North America and Europe, demonstrate that landscape-level functional changes can occur in terrestrial systems because of atmospheric stress.

Within reasonable bounds, we cannot consider transformations of ecological communities to have only local effects. In marine systems, changes in geographically distant ecosystems may greatly affect one another through, for example, larval transport or the transport of pollutants by currents (6.1.12). Even in terrestrial ecosystems, migratory animals and the atmosphere provide similar linkages between distant ecosystems. Fragmentation of temperate forests in North America can, for example, affect the survivorship of tropical-temperate migratory birds, which are important seed dispersal and biological control agents in neotropical areas. Changes in forested watersheds can have obvious effects on water flow and quality far downstream. Current rates of forest conversion will also reduce potential or actual sustainable economic benefits due to soil and water conservation services, recreation and tourism, and non-timber products.

6.3.8 Goods and services at risk

The transformation, fragmentation and loss of habitats has had many different effects on the provision of ecological goods and services. The massive creation of new agroecosystems has obviously resulted in the ability to increase food production dramatically. At the same time, it has led to the impoverishment of natural communities and can reduce the ability of ecosystems to maintain productivity in the face of environmental fluctuation. Substantial alteration in soil fertility can be driven by changes in plant species composition and microbial functional groups which are required for the cycling of important plant nutrients. The loss of particular plant species and loss of critical communities, such as forested watersheds, can reduce the ability of ecosystems to control soil erosion and retain water. Conversion from forest or shrubland to grassland dramatically increases stream-flow, and if this occurs in the upper reaches of watersheds, can increase the need for additional water control measures through dams. Thus, degradation and conversion of forested watersheds can result in significant economic costs due to increased flooding and sedimentation.

The rapid transformation of forested ecosystems without regard for appropriate management of water resources, has had serious consequences for human health (Box 6.3-4). Deforestation led to major malaria outbreaks in the western Amazon, due to the creation of new habitats for mosquito

Box 6.3-4: How do disruptions in biodiversity influence human health?

Disruptions in biodiversity can affect disease transmission either through their influence on vectors of disease, or more directly on their influence on the disease-causing organisms themselves. Changes in landscape diversity, due to agriculture, have resulted in the the spread of human diseases. For example, the introduction of slash-and-burn agriculture into wet tropical Africa resulted in an increase in malaria which in turn increased the occurrence of sickle-cell anaemia (5.2.1). Physically damaged reefs are often invaded by the dinoflagellate *Gambierdiscus toxicus*, which is responsible for ciguatera in humans (6.1.10). Unidentified precursors in the dinoflagellate are transformed into toxins which accumulate in food chains leading to table fish.

Other direct or indirect effects on health can come from biodiversity's influence on particular ecosystem processes. Changes in plant species composition can result in changes in the emissions of volatile organic compounds by plants which can lead, along with industrial pollutants, to increases in tropospheric ozone that can indirectly affect human health (6.2.4). Rooting depth changes as a result of replacing species when forests are converted to agricultural systems. These changes in rooting depth affect the amount of water percolating through the soil and may increase the levels of nitrate in ground water (6.1.4; 6.1.7).

vectors, and also to the increased colonization of the region by susceptible human populations. However, management of vector habitats, when coupled with other public health measures, dramatically reduced the incidence of the same disease in the southern United States.

Increases in the extent and yield of rice agroecosystems have provided food for vast numbers of people. At the same time, the increases in rice cultivation and livestock husbandry have been major contributors to the increased methane concentrations in the atmosphere, and thus to concerns over greenhouse warming. It is likely, although less certain, that increases in the use of nitrogenous fertilizer in the tropics in order to enhance agricultural productivity are also contributing to rising atmospheric concentrations of nitrous oxide, a very powerful greenhouse gas, in the atmosphere (Box 6.3-5).

Transformation of parts of ecosystems that then acquire substantial economic value often requires intensive management in other parts of the ecosystem. Fire control in forest ecosystems provides one example. Fire control in

many forests provides substantial benefits for adjacent property owners, and for hunting and recreation. However, because fire control completely alters the frequency of naturally occurring fires, it also can have the unintended side-effect of contributing to the buildup of fuel, possibly leading to more intense fires which have adverse effects on plant regeneration and wildlife habitat, and threaten human habitation. Prescribed burning can partially mitigate these potential adverse consequences, but can itself be expensive. Fire control thus illustrates the need to balance carefully the costs and benefits of maintaining diversity in ecological communities.

Over-exploitation in extracting materials and goods from converted or degraded ecosystems, such as poorly managed cropping and timber harvesting, while providing food and wood, also tends to disrupt some ecosystem services by decreasing the ability of the ecosystems to retain nutrients, water and topsoil. These effects are due directly to the mechanical effects of extracting the desired materials, along with the longer-term biogeochemical effects of removing carbon, nitrogen and nutrients from the systems. Over the long term, reductions in soil carbon and soil fertility, and increases in overland flow and sedimentation rates, are often the result (Box 6.3-6). Increased fertilizer and pesticide subsidies are then often required to maintain adequate agricultural yields, resulting in increased direct costs.

The introduction of non-native species, and over-exploitation of resources, has been especially problematic in grassland ecosystems. In arid and semi-arid regions, the introduction of cattle, sheep and other non-native grazers, subsequent overgrazing, over-use of fire, and the introduction and spread of alien plant species, can result in desertification because the new species lack the adaptations of the natural communities for using water efficiently in the face of the original herbivores.

6.3.9 Implications

Understanding the functional role of biological diversity is important scientifically, but as our analysis makes clear, it also is important from a managerial and policy perspective. Changes in biodiversity will, to the best of our current knowledge, have important implications for sustainable resource management, and for the continued provision of ecological goods and services. Our analyses suggest that these implications may be particularly important for longer time scales, especially for those ecosystem processes and goods such as primary productivity and crop yields that do not depend strongly on diversity over short time scales. As the need for sustainable management of ecological goods and services increases, the maintenance of these processes becomes more important over long time scales, and the importance of considering biodiversity as a component to be managed also increases. Ecosystems can be managed so as to maintain goods and services that might otherwise be lost, if

Box 6.3-5: How does biodiversity influence atmospheric composition and climate?

The influence of biodiversity on air quality is not generally thought to be strong in comparison with direct anthropogenic effects. However, there is some relationship between the actual composition of ecosystems and landscapes and air quality. Because different plant species emit different volatile organic compounds, species composition can affect the concentration of tropospheric ozone, in conjunction with industrial pollutants (6.2.4). Certain ecosystems within a landscape serve as particularly efficient sinks for pollutants (6.1.3).

Biodiversity at a species or ecosystem level plays a stronger role in the relative strength of sources and sinks of trace gases. Some species and systems are particularly high sources of trace-gas emissions, such as DMS, CH₄, N₂O, and NO; (6.1.2; 6.1.6; 6.2.4; 6.2.8). Methane (CH₄) is one of the most important greenhouse gases and its production is restricted to a single group of bacteria species that require anaerobic conditions, they are found especially in wetlands and in the digestive tracts of ruminants and termites (6.1.2; 6.1.7; 6.2.4). For DMS, microbial species interactions such as grazing can have a strong influence on emission rates (6.2.4; 6.2.7), but the sensitivity to anthropogenic disturbance is not known. Other microbial species provide important sinks for CH₄ and NO.

The changes in atmospheric concentrations of some trace gases can be related in part to alterations in landscape-level diversity and human activities. One of the sources of the net addition of CO₂ to the atmosphere is land-cover conversion (i.e. change in landscape diversity) notably in the direction of tropical evergreen > tropical deciduous > temperate forests (6.1.2). Net additions of CH₄ can largely be attributed to human activities enhancing the extent of rice paddy soils, livestock, and other sources rather than one particular change in landscape diversity.

In temperate forests, changes in species composition can affect atmospheric interactions and local weather through changes in evapotranspiration and albedo (6.1.3). In desert and grassland systems, the amount of water transpired – and hence the local climate – depends very strongly on the particular complement of species present and the way in which they partition water (6.2.3). In marine systems, planktonic algae emit considerable amounts of dimethylsulphide (DMS), which subsequently have a strong influence on cloud formation (6.1.9; 6.1.12; 6.2.4).

Box 6.3-6: How is biodiversity related to soil fertility, soil erosion and the control of hazardous waste?

Soil fertility is related to soil parent material, litter type and the presence of basic microbial species richness. Therefore, within an ecosystem, species composition certainly matters, and changes in species diversity can therefore lead to changes in soil fertility. Substantial alterations in soil fertility can be driven by changes in plant species composition (6.1.6), both within and among ecosystems. Unfortunately, few data are available on microbial richness in soils, or the interactions among plant species richness per se, litter quality, soil biota and soil fertility. We know that different microbial functional groups are required for the cycling of important plant nutrients. However, at present we have little knowledge of the comparative roles of microbes within functional groups (6.2.7).

Biodiversity can affect rates of soil erosion in a variety of ways. At the species level, individual plant species, due to their growth form and canopy architecture, can play a crucial role in controlling soil erosion (6.2.5). Particularly in arid and semi-arid regions, then, reducing the diversity of plant species can accentuate soil losses through erosion. Landscape diversity resulting mainly from land-use patterns can also affect erosion rate directly (6.1.2; 6.1.4; 6.1.7). These changes largely come about through land-cover conversion, especially the transformation of forested systems to agricultural uses or pastures, but they can also come about through the intensification of agricultural management. Both changes generally have the effect of lowering the water and soil retention capabilities of the landscape, leading to increased soil erosion. Coastal forested wetlands play an important role in controlling shoreline erosion (6.1.11).

Microbial diversity can be very important for the degradation of xenobiotic compounds (i.e. hazardous wastes). It is important both for dealing with the myriad toxic compounds entering the environment in all biomes and also in cases in which microbial community interactions, such as co-metabolism, are necessary to break down a single compound (6.2.7). These phenomena can be exploited to identify specific organisms, or groups of organisms, that possess traits that could be harnessed on larger scales either to mitigate the effects of accidental contamination, or to reduce hazardous waste production in industrial processes

the appropriate components of biodiversity are maintained (Box 6.3-7). Changes in biodiversity can have direct and indirect effects on atmospheric composition, management of water, and human health. Thus, management caution in reducing diversity is indicated for both species-rich and species-poor systems, when it is important to sustain the provision of goods and services over long time scales.

Box 6.3-7: Appropriate management can enhance ecosystem services

Carbon sequestration can be enhanced by managing landscape diversity. Conversion to grassland, the most common type of forest conversion in the tropics, contributes the largest amounts of carbon emissions in those areas. Returning agricultural land to forest, or managing agricultural land more effectively to enhance soil carbon sequestration, can lead to lower emissions of trace gases, and can slow the rate at which excess carbon dioxide is added to the atmosphere.

Forest fragmentation profoundly affects biotic interactions which constitute important ecosystem services. A clear example of this is biotic pollination (6.2.6). Reducing the degree of fragmentation, perhaps by providing sufficient corridors for dispersal, might be able to maintain an acceptable level of pollination while allowing some harvesting of resources.

Acknowledgements

We thank the many contributors and reviewers of Sections 5 and 6 for their dedication to the task of producing balanced and credible assessments and their patience and persistence during numerous revisions. We are particularly grateful to the John D. and Catherine T. MacArthur Foundation during the critical initial phases and, subsequently, UNEP for their support of this work through awards to the Scientific Committee on Problems of the Environment (SCOPE). We extend special recognition to Veronique Plocq-Fichelet, Executive Director of SCOPE, for her exceptional assistance and to Anne Schram for her continuing optimism and efficiency during the protracted and intense process of preparing these Sections.

7

Inventorying and Monitoring

N.E. STORK, M.J. SAMWAYS

Lead Authors:

N.E. Stork, M.J. Samways (Chapter 7.0); N.E. Stork, M.J. Samways, D.A. Bryant (Chapter 7.1); M.J. Samways, N.E. Stork, J. Cracraft, H.A.C. Eeley, M. Foster, G. Lund, C. Hilton-Taylor (Chapter 7.2); N.E. Stork, K. Sherman (Chapter 7.3); N.E. Stork (Chapter 7.4)

Contributors:

D.A. Bryant, J. Cracraft, K. Sherman (Chapter 7.0); J. Cracraft; H.A.C. Eeley, S. Grant, N. Manokaran, N.A. Mawdsley, K. Sherman (Chapter 7.1); B. Beehler, M.I. Chatounovski, R. Daniels, S. Droege, J. Edwards, D. Evans, L.-A. Hayek, J. Larson, D. Linden, N. Manokaran, R. McDiarmid, O. Phillips, J. Robertson-Vernhes, E. Rodenburg, K. Sherman, J. Soberón, B.R. Striganova (Chapter 7.2); D. Bryant, B. Collette, H.A.C. Eeley, J. Harrison, J. Robertson-Verhnes, K.D. Singh (Chapter 7.3); H.A.C. Eeley, D.L. Hawksworth, M.J. Samways (Chapter 7.4)

CONTENTS

Executive Summary	457	7.2.3 Project planning	477
7.0 Introduction	459	7.2.3.1 Standardization	477
7.0.1 Inventorying and monitoring	459	7.2.3.2 Validation and calibration	477
7.0.1.1 Definitions	459	7.2.3.3 Voucher collections and accompanying data	477
7.0.1.2 Contexts	459	7.2.3.3.1 The importance of voucher specimens	477
7.0.2 Section outline	460	7.2.3.3.2 Important considerations regarding voucher specimens	478
7.0.3 Summary	461	7.2.3.3.3 Essential collecting permits	478
References	461	7.2.3.4 Statistical analysis	479
7.1 Why inventory and monitor biodiversity?	461	7.2.3.5 Use of existing data	480
7.1.1 Introduction	461	7.2.4 Baseline data	480
7.1.2 The rationale for inventorying and monitoring biodiversity at different spatial and temporal scales	462	7.2.4.1 Biotic data	480
7.1.3 The rationale for inventorying and monitoring biodiversity at different biological levels	463	7.2.4.1.1 Non-taxonomic baseline data	480
7.1.3.1 At the genetic level	463	7.2.4.1.2 Other baseline biotic data	481
7.1.3.2 At the population level	466	7.2.4.2 Abiotic data	481
7.1.3.3 At the species level	466	7.2.4.3 Human-related data	481
7.1.3.3.1 Species turnover in ecosystems	467	7.2.5 Genetic inventorying and monitoring	482
7.1.3.4 At the ecosystem and landscape levels	468	7.2.6 Population inventorying and monitoring – some general considerations	482
7.1.4 The rationale for inventorying and monitoring biodiversity inside and outside protected areas	469	7.2.6.1 Population inventorying and monitoring	482
7.1.4.1 Management effectiveness in protected areas	470	7.2.6.2 Population size and density	483
7.1.4.2 Status of identified features in protected areas	470	7.2.6.3 Population structure and demographic variables	483
7.1.4.3 Threats to protected areas	471	7.2.6.4 Population equilibrium	483
7.1.4.4 Use and socio-economic benefits of protected areas	471	7.2.6.5 Population analysis	484
7.1.4.5 Inventorying and monitoring outside protected areas	472	7.2.7 Fauna population inventorying and monitoring – some methods	485
7.1.5 Summary	472	7.2.7.1 Mark–recapture	485
References	472	7.2.7.2 Radio tracking	485
7.2 Scales, planning and approaches to inventorying and monitoring	475	7.2.7.3 Remote sensing of populations	485
7.2.1 Introduction	475	7.2.7.4 Territory mapping, point counts and transects	485
7.2.2 Scales of measurement	476	7.2.8 Perspectives and approaches to single-species inventorying and monitoring	486
7.2.2.1 Spatial scale	476	7.2.8.1 High-impact species	486
7.2.2.1.1 Local assessments	476	7.2.8.1.1 Keystone species	486
7.2.2.1.2 Regional assessments	476	7.2.8.1.2 Exotic invasives	486
7.2.2.1.3 Global assessments	476	7.2.8.2 Indicator species	487
7.2.2.2 Temporal scale	476	7.2.8.3 Conservation-focus species	490
7.2.2.3 Taxon-specific, taxonomically comprehensive and site-based perspectives	477	7.2.8.3.1 Umbrella and flagship species	490
		7.2.8.3.2 Threatened species	491
		7.2.8.4 Species with value to humans	492
		7.2.8.5 Typical or representative species	492
		7.2.9 Perspectives and approaches to multi-species inventorying and monitoring	493
		7.2.9.1 Multiple-taxa inventories	493

7.2.9.2 Intensive site inventories	493	7.3.4.1 Global Terrestrial Observing System (GTOS)	528
7.2.9.3 Rapid inventories	493	7.3.4.2 IOC's Global Ocean Observing System (GOOS)	529
7.2.9.4 Global inventories	495	7.3.4.3 Global Climate Observing System (GCOS)	530
7.2.10 Ecosystem and landscape inventorying and monitoring	495	7.3.5 Inventorying and monitoring for conservation	530
7.2.10.1 Monitoring landscapes	495	7.3.5.1 The Ramsar Convention	530
7.2.10.2 Monitoring healthy ecosystems	495	7.3.5.2 CITES	530
7.2.10.3 Forest inventories	496	7.3.5.3 Species Survival Commission (IUCN)	531
7.2.10.4 Remote sensing	496	7.3.5.4 World Conservation Monitoring Centre (WCMC)	531
7.2.10.4.1 Passive systems	497	7.3.5.5 Red Data Books and Red Lists (IUCN)	531
7.2.10.4.2 Active systems	499	7.3.5.6 Stud Books and the International Species Inventory System	531
7.2.10.5 Monitoring in marine environments and ecosystems	500	7.3.6 Co-ordinating the inventorying and monitoring of genetic resources	532
7.2.10.5.1 Introduction	500	7.3.6.1 The Food and Agriculture Organization of the United Nations (FAO)	532
7.2.10.5.2 Large marine ecosystems	501	7.3.6.2 The Consultative Group on International Agricultural Research (CGIAR)	532
7.2.10.6 Monitoring freshwater ecosystems	501	7.3.7 Sites for inventorying and monitoring biodiversity	533
7.2.11 Long-term monitoring of ecosystems	503	7.3.8 Global co-ordination: GIMP	534
7.2.12 Summary	503	7.3.9 Summary	535
References	508	References	535
7.3 Integrated approaches	517	7.4 Capacity building	538
7.3.1 Introduction	517	7.4.1 Introduction	538
7.3.2 Co-ordinating inventorying efforts	518	7.4.2 Development of institutional capacity	539
7.3.2.1 Integrated strategies	518	7.4.3 Human resources and training	540
7.3.2.1.1 National efforts	518	7.4.3.1 Local peoples and volunteers	540
7.3.2.1.2 International efforts	519	7.4.3.2 Development of a professional scientist cadre	540
7.3.3 Co-ordinating monitoring of biodiversity	523	7.4.4 Conclusions	541
7.3.3.1 Vegetation cover and land use	523	7.4.5 Summary	541
7.3.3.1.1 The Food and Agriculture Organization of the United Nations	523	References	542
7.3.3.1.2 CORINE	525		
7.3.3.2 Soils	526		
7.3.3.3 Marine Station Networks	527		
7.3.3.4 Large Marine Ecosystems	528		
7.3.4 Integration with programmes monitoring physical variables	528		

EXECUTIVE SUMMARY

Accelerating rates of biodiversity loss and the signing of international agreements, such as the Convention on Biological Diversity and *Agenda 21*, have called for the world's biodiversity to be inventoried and monitored. Yet, to date, so few organisms have been collected and named and their distributions recorded that the scale of the task is enormous.

Biodiversity inventorying is the surveying, sorting, cataloguing, quantifying and mapping of entities such as genes, individuals, populations, species, habitats, biotopes, ecosystems and landscapes or their components, and the synthesis of the resulting information for the analysis of patterns and processes. Monitoring consists of repeated inventorying over time and space and hence it measures change. This Section examines how the task of inventorying and monitoring of biodiversity can be achieved.

Data from inventorying and monitoring are essential for identifying key issues for policy and management goals. They can be used to assess priorities for conservation, for land use, for environmental impact assessments, and for informing policy-makers and the general public on the state of biodiversity. Biodiversity inventories and monitoring also provide the essential biological information for many biological sciences including systematics and population biology, ecology, and for many applied sciences, such as biotechnology, soil science, agriculture, forestry and fisheries sciences, conservation and environmental sciences.

A number of considerations are important prior to investment in inventorying and monitoring. How well these are considered will reflect on the statistical and biological validity and reliability, and comparability of the resulting data. In turn, these will determine the usefulness of the programmes concerned. For example, the temporal and geographical scale of operation need to be considered with other components of the sampling design. Particular consideration has to be given to deciding which taxa to examine (e.g. keystone, indicator, threatened, umbrella, flagship, agricultural, medical or commercial species) or what level (e.g. genes, species, population, ecosystem).

Historical collections of organisms provide extremely important baseline information on how the range, abundance and form of species may change over time. These and voucher collections are essential for the identification and verification of field data and provide a permanent record.

As such, they are a vital resource for many fields of the biological sciences.

The methods for carrying out inventories at the population, species, ecosystem and landscape level are described. Population surveys are important in understanding how that population is changing in the face of anthropogenic disturbance. Species inventories will remain perhaps the largest part of inventorying and are of value in the selection of protected and threatened areas and of ecologically and economically sensitive areas. The success of inventorying depends on natural history collections and the contribution of systematists. New techniques to analyse and disseminate systematic information are being devised.

Repeated inventorying and modelling of the resulting information provide means of monitoring biodiversity at all levels. Techniques such as censusing are important for estimating population size and hence rarity/threatened status of species. Remote sensing coupled with ground truthing is used to monitor vegetation cover, land use, forest loss and other aspects of biodiversity change at the biotope and ecosystem level. The constantly moving and three-dimensional nature of the aquatic environment (and the marine in particular) presents special monitoring problems. At present, very little monitoring of biodiversity is undertaken in some countries.

Long-term research sites and programmes provide essential information on how biodiversity changes, and are important in distinguishing anthropogenic and natural change.

Biological organisms are not restricted by political boundaries and therefore if nations are to meet national and international agreements to inventory and monitor biodiversity there needs to be sharing of scientific expertise, facilities and information. The scale of inventorying and monitoring required exceeds the capacity and infrastructure of even the most scientifically advanced nations. Inventorying and monitoring efforts can therefore be enhanced by collaboration between nations and agencies. If natural history institutions and other establishments concerned with inventorying and monitoring are to become more effective, they need to be better resourced, their collections better maintained and a new cadre of professional researchers and technicians trained and funded.

Although a number of organizations have addressed the problem of lack of coordination by proposing programmes

such as DIVERSITAS and Systematics Agenda 2000, these are, as yet, largely only programmes on paper. If these and other programmes are to become plans for action and then implemented then they need to be integrated into a Global

Inventorying and Monitoring Programme which will link with others, such as GTOS, GCOS and GOOS which monitor changes in physical parameters of the Earth.

7.0 Introduction

7.0.1 Inventorying and monitoring

7.0.1.1 Definitions

Inventorying is the surveying, sorting, cataloguing, quantifying and mapping of entities such as genes, individuals, populations, species, habitats, biotopes, ecosystems and landscapes or their components, and the synthesis of the resulting information for the analysis of processes. The presence/absence, relative abundance, and patterns of variation of these biological entities span spatial scales from nanometres to countries, continents, ocean basins and the entire biosphere.

No inventory is ever complete as there will always be additions of new entities and new variation (through immigration, birth or mutation) and disappearances of entities (through emigration, death or extinction) as well as changes in abundances. Inventories, the result of inventorying, are more than simply lists of names and numbers; they also involve the extensive application of systematics, ecology, biogeography and management. Inventories give a snapshot of the state of biodiversity and identify key variables and bioindicators. Inventories also provide baseline information for the assessment of change, and they apply to all ecosystems from fully natural to intensively managed.

Monitoring consists of intermittent (regular or irregular) surveillance to ascertain the extent of compliance with a predetermined standard or degree of deviation from an expected norm (Hellawell 1991). Goldsmith (1991) points out that monitoring is usually goal-orientated and designed to reveal changes in a particular parameter or parameters. It is repeated at intervals (mostly regular) and often provides a baseline for recording changes in the future. Monitoring of biological diversity aims to develop a strategic framework for predicting the behaviour of key variables in order to improve management, increase management options and provide an early warning of system change. Success in monitoring depends on the factors listed below (di Castri *et al.* 1992; Solbrig 1991; and see Chapter 7.1):

- being clear on the spatial and temporal scales of investigation and management;
- having a keen awareness of the time scale of a project and its feasibility within that time frame;
- using an appropriate taxon or various taxa to provide the information needed to illustrate pertinent changes;
- using methodologies, including statistics, that are appropriate and efficient to the study or management site, while also providing comparable results from other sites locally, regionally or globally;

- standardizing data collections and statistical analyses;
- maintaining voucher collections of the subject organisms;
- using existing data where they are valid; and
- ensuring that not only appropriate biotic, but also abiotic and human variables are recorded and put into the appropriate statistical framework.

7.0.1.2 Contexts

It is important to establish the linkages between science and management. Inventories provide the basic science while monitoring measures *change* and guides management. Such management is dynamic, as it responds to the monitoring output from inherently dynamic ecosystems.

Inventorying and monitoring have previously been encompassed by such terms as surveying and describing. For example, in *A Biological Survey for the Nation* (NRC 1993) the term 'survey' is used to include the 'inventorying, mapping and monitoring of biotic resources; performing basic and applied research on species, groups of species, populations and ecosystems; and providing ... scientific support and technical assistance...'. But today inventorying is coming to mean something more precise and with greater scientific underpinning.

Recent international agreements and strategies have recognized the need to inventory and monitor biological diversity and have called on countries to initiate inventorying and monitoring programmes.

- Article 7 of the United Nations Convention on Environment and Development requires signatory parties to 'identify components of biodiversity important for conservation and sustainable use... and monitor, through sampling and other techniques, the components of biological diversity identified'. It also calls for signatories to 'identify processes and categories of activities which have or are likely to have significant adverse impacts on the conservation and sustainable use of biological diversity, and monitor their effects' and to 'maintain and organise ... data derived from identification and monitoring activities' (Johnson 1993). This will involve a combination of the assembly of existing data, generation of new data, and organization to ensure that the resulting information is both usable and easily accessible (Glowka *et al.* 1994). However, the Biodiversity Convention does not require signatory nations to provide a *full* inventory of all the components of their biological diversity but only to identify biodiversity components that are important for conservation and sustainable use.

- Chapter 15.5 of *Agenda 21* calls on signatories to 'undertake country studies or use other methods to identify components of biological diversity important for its conservation and the sustainable use of biological resources ...' and to 'promote, where appropriate, the establishment and strengthening of national inventory ... related to biological resources at the appropriate level'. Chapter 15.6 calls for the development of 'methodologies with a view to undertaking systematic sampling and evaluation on a national basis of the components of biological diversity identified by means of country studies' and to 'initiate or further develop methodologies and begin or continue work on surveys at the appropriate level on the status of ecosystems and establish baseline information on biological and genetic resources, including those in terrestrial, aquatic, coastal and marine ecosystems, as well as inventories undertaken with the participation of local and indigenous people and their communities' (Johnson 1993).
- The *Global Biodiversity Strategy* (WRI/IUCN/UNEP 1992) recommends that an early warning network be established to 'monitor potential threats to biodiversity and mobilize action against them' [Action 4].
- A global strategy addressing marine biodiversity (Norse 1993) suggests the establishment of a global monitoring network on ecological processes to provide information for management and to provide warning of 'undesirable changes'.
- Inventory and monitoring efforts are also central to the activities described in *Guidelines for Country Studies on Biological Diversity* (UNEP 1993). Country Studies provide an information base from which nations can develop biodiversity action plans, as requested by the Biodiversity Convention. Numerous other planning documents make the same point.

7.0.2 Section outline

Because of the interdependence of inventorying and monitoring the two subjects are treated together. We deal with biological diversity at various levels and from various perspectives, and discuss aspects of inventorying and monitoring for each. The Section is divided into four chapters.

(1) Why inventory and monitor biodiversity?

- Decisions for investigating the global loss of biodiversity are dependent on science-based analyses of the changing states of species groups, populations, communities and the ecosystems they inhabit.

This chapter discusses the need for inventorying and monitoring the world's biological diversity at different biological levels. In particular, it outlines the necessity for scientific research and guidance for policy and management decisions.

(2) Scales, planning and approaches to inventorying and monitoring

- Assessments of the changing demographics of biodiversity around the globe require comparable and quantifiable biological and environmental data related to the causes and effects of the changes.

This chapter outlines approaches to inventorying and monitoring, and the variables that are to be taken into account prior to such an undertaking. It identifies those issues that are critical to the success of inventorying and monitoring efforts and addresses the important issue of spatial and temporal scales of analysis. Additional considerations prior to any investigation, such as collection of voucher specimens and the standardization of methods, are discussed.

- The time, effort and funds required to inventory and monitor global biodiversity will need to be based on the most cost-effective and efficient scientific methodologies presently available.

This extensive and technical chapter also discusses the methods for compiling inventories and for monitoring different levels of biological diversity (and is complemented by the methods already described in Section 2). It also considers the taxa and ecological indicators that might be used as foci for research and management. There is detailed discussion on points and areas that are making particularly important contributions to biodiversity assessment using new technologies. Where well-established and traditional methodologies are mentioned, references are given to direct the reader to the appropriate, useful literature.

(3) Integrated approaches

- National, regional and international collaborative efforts that are multidisciplinary and multisectorial will improve the effectiveness and efficiency of the inventorying and monitoring effort.

This chapter investigates national and international efforts to co-ordinate inventorying and monitoring. Such co-ordination is essential if resources, including time, money and personnel are to be used to the full. Good co-ordination also prevents certain geographical areas from being neglected, while also avoiding repetitive efforts being made in others. The integration of inventorying and monitoring

of biological diversity with that of physical variables is addressed, as is the co-ordination of inventorying and monitoring for conservation.

(4) Capacity-building

- Presently the scientific, technical and support infrastructure required for improving global biodiversity assessments requires augmentation in staff and facilities, particularly in developing countries where the biological and economic losses will be greatest if global biodiversity continues to become degraded in the absence of focused mitigating actions.

This chapter discusses the urgent need to build human and institutional capacity for inventorying and monitoring. In particular, it examines ways of developing physical infrastructure and human resources.

7.0.3 Summary

- Recent international agreements and strategies have called for increased inventorying and monitoring of biodiversity.
- Inventorying is the surveying, sorting, cataloguing, quantifying and mapping of entities such as genes, individuals, populations, species, habitats, biotopes, ecosystems and landscapes or their components, and the synthesis of the resulting information for the analysis of patterns and processes.
- Monitoring is the intermittent (regular or irregular) surveillance to ascertain the extent of compliance with a predetermined standard or degree of deviation from an expected norm.

References

- di Castri, F., Robertson Vernhes, J. and Younès, T.** 1992. Inventorying and monitoring biodiversity. *Biology International Special Issue No. 2*. IUBS, Paris.
- Glowka, L., Burhenne-Guilmin, F. and Synge, H.** 1994. *A Guide to the Convention of Biological Diversity*. Environmental Policy and Law Paper No. 30. IUCN, Gland and Cambridge.
- Goldsmith, F.B. (ed.)** 1991. *Monitoring for Conservation and Ecology*. Chapman and Hall, London.
- Hellawell, J.M.** 1991. Development of a rationale for monitoring. In: Goldsmith, F.B. (ed.), *Monitoring for Conservation and Ecology*. 1–14. Chapman and Hall, London.
- Johnson, S.P. (ed.)** 1993. *The Earth Summit: The United Nations Conference on Environment and Development (UNCED)*. Graham and Trotman/Martinus Nijhoff, London.
- Norse, E.A. (ed.)** 1993. *Global Marine Biodiversity: A strategy for building conservation into decision making*. Island Press, Washington, DC.

NRC 1993. *A Biological Survey for the Nation*. National Academy Press, Washington, DC.

Solbrig, O.T. (ed.) 1991. *From Genes to Ecosystems: A research agenda for biodiversity*. IUBS, Paris.

United Nations Environment Programme 1993. *Guidelines for Country Studies on Biological Diversity*. UNEP, Nairobi.

WRI/IUCN/UNEP 1992. *Global Biodiversity Strategy*. World Resources Institute, Washington, DC.

7.1 Why inventory and monitor biodiversity?

7.1.1 Introduction

Biodiversity inventorying and monitoring provide fundamental and essential biological information used by many basic scientific disciplines (e.g. systematics, population biology, behaviour, ecology and other fields of comparative biology) and many applied sciences (e.g. biotechnology, soil science, agriculture, forestry and fisheries sciences, conservation and environmental sciences) (see Box 7.1-1).

Scientists know enough about the overall distribution of threats to biodiversity to be able to guide the allocation of resources to support biodiversity assessments and recommend direction for sustainable resource use. Experience shows that where resources are wisely and systematically used to inventory and monitor biodiversity, challenges can be met. An example is the application of adaptive management strategies which hold promise for achieving sustainable use of fishery resources and the maintenance of biological diversity. Risk assessments that consider availability of resource abundance and productivity have become an integral part of scientific advice to managers. Among the relatively new fisheries for which access and fishing effort have been controlled from the start of fishing, leading to sustainable biomass yields, are those of the Falklands Islands and the bottom fisheries of the northwest shelf system of Australia.

The identification and monitoring of biological diversity are regarded as being essential for supporting Articles 8, 9 and 10 of the Convention on Biological Biodiversity (Glowka *et al.* 1994) which consider the *in situ* and *ex situ* conservation of biological diversity and sustainable use of its components. Glowka *et al.* (1994) point out that the results of identification and monitoring projects are important for:

- developing strategies, plans and programmes [Article 6(a)];
- integrating conservation and sustainable use into sectorial and cross-sectorial plans, programmes or policies [Article 6(b)];
- undertaking environmental impact assessment [Article 14(a) and (b)]; and

Box 7.1-1: The use of inventories and monitoring data in basic and applied sciences (*based on: NRC 1993*).

Inventorying and monitoring of biological diversity provide information that may be used:

- to provide a basis for the scientific research necessary for understanding the world in which we live (both inside and outside protected areas),
- to define the current and future options available for meeting human needs, and
- to guide immediate and long-term management, policy and decision-making.

Areas in which inventories and monitoring activities are important include:

- providing information for determining and conserving biological diversity;
- providing information necessary for the sustainable management of natural resources;
- identifying economically valuable products from wild species (bioprospecting);
- maintaining or increasing the productivity of agricultural systems through the identification of (i) new varieties or new species of use to humans and (ii) beneficial and harmful organisms;
- improving human health through the identification of pest organisms and beneficial organisms;
- understanding ecosystem processes so that the ecological services essential for human survival can be maintained;
- defining the impact of human activities on biodiversity so as to help reduce undesirable effects on the environment;
- understanding the potential effects and impact of climate change and other forms of natural environmental change;
- determining the aesthetic benefits of diversity so as to preserve the quality of human life.

- negotiating access agreements, including benefit-sharing [Article 15(7)].

Actions affecting biodiversity and natural resources are often based on inadequate information. There are three main reasons for this:

- the data necessary for informed decision-making are unavailable, incomplete or unreliable;
- the data are not presented in a format that policy-makers and managers can use, and
- the data are incorrectly interpreted.

Given the limited funds available for data collection, analysis of *which* information is useful to decision-makers (defining the audience and determining their needs) is critical for knowing what should be inventoried and monitored (see Chapters 7.2 and 7.3). Various models exist that help put such information into a framework useful for

decision-makers. For example, one of the best known, the pressure–state–response model helps to conceptualize what questions need to be addressed by inventory and monitoring programmes (Figure 7.1-1).

Monitoring questions framed around the pressure–state–response model include:

- What are the pressures on the system in question?
- Which factors affecting biodiversity are changing, or have changed, over time?
- Are policies to manage a given species/population/ecosystem working?
- At what rate is the pressure operating?

7.1.2 The rationale for inventorying and monitoring biodiversity at different spatial and temporal scales

Inventorying and monitoring need to be carried out at different geographical scales, from local to global,

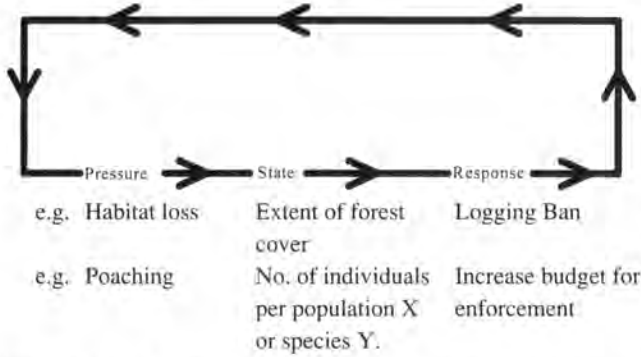

Figure 7.1-1: Pressure–state–response model. An inventory can determine the *state* of a particular system at a given time (e.g. the number of individuals in population, the number of species in an area, or the type and extent of biotope types within a region). Inventories can also document *pressures* on given elements of diversity, but these are often only visible over time. Monitoring is critical for determining and defining pressures on a given element, changes in the state of that element and *responses* both to existing pressures and to management and policy interventions.

depending on the problems that are being addressed (see Chapter 7.2). Examples are given in Box 7.1-2.

Two major areas where monitoring is applicable across varying geographical scales are: (1) The assessment of the effectiveness of biodiversity management. For national, regional or park programmes designed to preserve or increase biodiversity or to optimize biodiversity in systems managed for other goals (e.g. plantations), monitoring is a way of documenting whether the stated goals were, or are

being, achieved. (2) The need for an early-warning system of impending adverse change. The objective here is to develop a monitoring system that is sensitive to unusual changes in biodiversity before they become too critical.

Similarly, the kinds of problems that are being examined, the level of assessment, and the groups of organisms or perturbations to ecosystems will determine the time scale for inventorizing and monitoring. For some questions it may be appropriate to carry out inventories on a daily basis to monitor daily changes, whereas for others it may be necessary to carry out inventories every year, every ten years, or longer.

7.1.3 The rationale for inventorizing and monitoring biodiversity at different biological levels

7.1.3.1 At the genetic level

Biochemical and molecular data are increasingly useful for assessing and managing regional diversity in natural populations. A conceptual framework for developing conservation strategies is emerging from the recently developed field of ‘conservation genetics’, and numerous genetic techniques are available for characterizing wild and cultivated populations or populations managed in captivity (Hillis and Moritz 1990; Avise 1994). Molecular methods can be used to survey genetic variability at three levels of organization:

- individual organisms within populations;

Box 7.1-2: Examples of uses of information from the inventorizing and monitoring of biodiversity at different spatial scales.

Site/local level

Mining and manufacturing industries that are environmentally sensitive use maps of specific areas to determine the precise and optimal location of activity to minimize disruption of important ecosystems.

Sub-national level

State government agencies use information on protected areas and ownership, species distribution and natural vegetation cover to determine gaps in protected area coverage and to propose new areas for protection (Csuti 1994; Rebelo and Siegfried 1990).

National level

Ministries and government agencies in many countries monitor population changes within their fisheries to set annual catch levels to avoid over-exploitation (e.g. Elst 1993).

Regional and continental

Agencies use information on species distribution, threat and other biodiversity data to prioritize where to allocate conservation funding (e.g. Olson and Dinerstein 1994).

Global

The World Trade Monitoring Unit of the World Conservation Monitoring Centre, a non-governmental organization, uses data on international trade of wild species to monitor compliance with the CITES treaty.

Box 7.1-3: The use of genetic surveys: examples of research questions at different levels (adapted from: Hillis and Moritz 1990; Baverstock and Moritz 1990; Avise 1994).

Individuals within populations

- How much genetic variation is present in the population?
- What are the parentage/kinship relationships among individuals?
- What form of mating systems exist in the population?
- Is there evidence for inbreeding and reason to suspect that individuals may be suffering from inbreeding depression?
- For sex-linked markers, what is the gender of an individual?
- Can the genetic effects of sex-biased dispersal be detected?
- What are the geographic origins of migratory individuals?

Populations and species

- Are there genetically distinct evolutionary lineages within a species?
- What is the degree of genetic subdivision among populations?
- What are the biogeographic correlates of genetic subdivision?
- What is the degree of gene flow between populations?

Among-species comparisons

- What are the phylogenetic relationships among species?
- What is the extent of genetic differentiation among species?
- Are species limits correctly understood?
- Can individuals or populations be distinguished from closely related species?
- What are the relative ages of divergence among species?
- What are the adaptive components of morphological traits among species?

- the species-level and populations within species;
- among-species comparisons.

Some typical questions addressed at each level are summarized in Box 7.1-3. At the first level, genetic surveys can identify individuals that may have suffered reductions in genetic variability because of large reductions in population size. Reduced levels of genetic variability can often lead to inbreeding depression, especially in species whose life-history patterns have historically produced large population sizes. Inbreeding depression may be due to the homozygosity of recessive deleterious genes or to a reduction in genetic variability itself, and may be important in small populations (see Section 4.2). Inbreeding, for example, can lead to the loss of disease resistance or to the inability of the populations to adapt to changing environments. All of these disruptive effects can make small populations more vulnerable to extinction.

Geographic surveys are important for identifying appropriate groups of genetically similar populations for conservation or management. In migratory species, such as sea turtles and salmon which home to natal areas to breed, genetic methods can be used to identify the origins of individuals from threatened breeding areas that are harvested or caught incidentally in high-seas drift-net fisheries. In devising a conservation strategy for a

threatened species, it is important to conserve not just a few representatives of a species, but also to preserve a wide range of the species' genetic variability. Often regional groups of populations represent unique adaptations to local habitats that merit conservation. Locally adapted gene complexes, however, can be disrupted by inadvertent introductions of foreign genes by translocations of individuals, and this can lead to outbreeding depression (see Section 4.2). Identification of genetically distinct groups is especially important in the *ex situ* management of captive populations in zoological gardens or of artificially propagated semi-wild populations.

At the species level, genetic data can be important for identifying morphologically cryptic species which may go unrecognized or which may be inappropriately mixed with genetically unrelated populations. The systematics of many commercially important plants and animals are still poorly understood. Such information can be used, for example, to search for genes in closely related species that may be used to increase production or to enhance disease resistance. Phylogenetic studies of cultivated species and their wild relatives are important for identifying the closest relatives of domesticated strains in order to preserve important genetic resources. The effective enforcement of international agreements on the trade in rare and threatened species (such as CITES) will also require better information on species limits and identifications (Pain 1994). Genetic data may also

Box 7.1-4: Monitoring of genetic variation.**Genetic variation and endangered species**

The New Zealand kakapo, *Strigops habroptilus*, is a large, nocturnal, flightless parrot. Once widespread across New Zealand, populations became confined to two areas, the Fiordland and Stewart Island. Approximately 45 individuals inhabited Stewart Island, including 18 females, while the Fiordland population comprised only 5 male birds. In 1982, in an effort to protect the species, 22 individuals were moved to Little Barrier Island, an area free of predators (Triggs *et al.* 1989). It is now important to maintain genetic variation both within and between these populations if the kakapo is to survive and respond to future environmental changes. Using blood samples from a number of individuals from each population, allozymic variation was examined. All three populations were found to be passing through a genetic bottleneck, likely to cause both loss of heterozygosity and allelic diversity within the Stewart Island and Little Barrier Island populations and genetic differentiation between them (Triggs *et al.* 1989), while the all-male Fiordland population is destined for early extinction. However, from the findings it was also possible to suggest a management strategy for the kakapo, including the reciprocal transfer of one young bird per generation between the populations, to maintain them as a single effective genetic unit and reduce inbreeding. Monitoring of the level of genetic variation within each population, and genetic differentiation between populations, will be necessary to gauge the success of this plan. It should be pointed out, however, that genetic bottlenecks are not the only problem facing the kakapo. Predation of these relatively vulnerable birds by small, introduced mammals may be an even greater threat (Prowlesland *et al.* 1992).

The only surviving genus (*Sphenodon*) of one group of iguana-like reptiles, which flourished during the Triassic Period, inhabits several islands along the coast of New Zealand. Although populations of the genus were protected in 1895 by legislation, the significance to conservation of genetic and morphological patterns of variability among the individuals was not fully recognized until recently. The extinction of 10 of 40 populations over the last century was considered to be of no great importance by managers, because the other populations were widespread and reasonably stable. Contrary to the perceived genetic uniformity of these populations, a genetic analysis of 24 populations (Daugherty *et al.* 1990) detected evidence for two species. One species was further subdivided into two subspecies with several populations in each subspecies, but the other was represented by only 300 individuals at a single locality and may have not otherwise have been afforded protection from extinction.

Genetic variation and the development of domestic livestock breeds

An enormous amount of animal diversity is represented by the different breeds of domestic livestock (see Sections 2.2 and 3.1). With careful inventorying and monitoring, this diversity may be exploited to improve the characteristics and production of breeds. For example, the Sahiwal dairy breed of cattle, from Pakistan, was introduced into Australia to confer tick resistance on Friesian herds. The Finnish Landrace sheep has been crossed with the Dorset Horn to produce ewes which, when mated with Suffolk rams, produce good meat lambs. Dairy cattle from Europe and North America have been crossbred with the Zebu cattle of India and South America to increase milk yields (WCMC 1992). New genetic mutations, occurring within an established breed, may also be exploited. For example, in 1931 a mutation produced a very hairy fleece on a New Zealand Romney lamb. The fleece produced when this gene was homozygous was perfect for carpet manufacture and sparked the development of both a new industry in the area and a new breed of sheep, the Drysdale (WCMC 1992).

Genetic markers for tracing the origins of individuals

Genetic markers have been used to identify the origins of individuals on the high seas that are homing to threatened spawning areas. Chum salmon are one of seven species of salmon in the North Pacific Ocean that spawn in freshwater streams from where young fish swim into the ocean and migrate in a large gyre around the North Pacific. Research agencies in Japan, Russia and the United States joined in a standardized study to estimate allele frequencies for several allozymes in chum salmon spawning areas located around the rim of the North Pacific and have used these genetic baseline data to identify the continents of origin of salmon caught in international waters (Winans *et al.* 1994).

In a study of loggerhead sea turtles (*Caretta caretta*) caught incidentally by drift nets on the high seas, Bowen *et al.* (1995) used nucleotide sequence variability in mitochondrial DNA to determine the origins of the turtles. The only known beach-spawning areas of loggerhead turtles are in Australia and Japan even though juveniles apparently traverse the entire Pacific Ocean and feed in waters off Mexico. Their statistical analyses of the mitochondrial genotypes showed that juveniles collected in mid-Pacific drift nets and off Mexico originated from both Japan and Australia. Such results confirm the importance of protecting mid-ocean juveniles in their migrations to distant feeding areas.

be of value in policing the purported 'captive breeding' of species of high economic value. Many of the appropriate genetic technologies are discussed in Section 2.

The degree of relationship between pairs of diploid species can also be inferred from the analysis of chromosome pairing in their hybrids. Differences in chromosome number and morphology are generally indicative of strong barriers to gene exchange. Phylogenetic relationships can also be inferred from the appearance and behaviour of chromosomes at meiosis. Genetic data are also important for genetic engineering. For example, by synthesizing naturally occurring polyploid species it can be shown how such polyploids may have evolved from their putative diploid ancestors.

Box 7.1-4 illustrates examples of the importance of monitoring at the genetic level.

7.1.3.2 At the population level

Many of the above genetic arguments relate also to inventorying and monitoring at the population level. The monitoring of population dynamics can result in the development of sound conservation strategies for particular systems, and produces generalizations of potentially wide applicability (Soulé and Kohm 1989). Such monitoring must be long-term if it is to generate data that will enable detection of a signal (such as declining population size) over the noise (or random fluctuations) inherent in most systems. Conservation recommendations based on short-term studies often have to be reconsidered in the light of subsequent information. For example, rare events such as a drought or an epidemic may be the key to the long-term population dynamics of a species (Soulé and Kohm 1989).

The identification and monitoring of populations provide important information for the characterization of rarity and threat status. The new *IUCN Red List Categories* (IUCN 1994) include population status and rate of decline among the criteria for categorizing species as 'Critically Endangered', 'Endangered' or 'Vulnerable'. Using quantitative methods for such characterizations provides a formalized objective procedure that can be repeated and compared and, most importantly, allows for consistent monitoring of threatened status. Nevertheless, qualitative assessments based on the evaluations of experts can also be useful in determining the degree to which a population may be threatened. When surveys are repeated over time, population trends can be assessed, which is one of the tenets of the new IUCN Categories of Threat (see Section 13.4.3).

Demographic information is also important in determining Minimum Viable Population (MVP) and Population Viability Analysis (PVA), two approaches for dealing with the problems of small population size. The MVP is the population size that provides a given probability of persistence of the population for a given amount of time (e.g. a 95% expectation of persistence without loss of fitness for several centuries), while the PVA

is the probability that a population will persist for some designated period. These methods are further discussed in 7.2.6.5 and in Section 4.4 (see also Fiedler and Jain 1992 for some practical applications).

Population inventorying and monitoring provide information for determining sustainable harvests and yields. Harvesting is essentially a consumer-prey relationship where humans are the consumers. Humans harvest a vast range of life forms (e.g. molluscs, fish, trees, game animals, herbs) and, in most cases, exploitation involves the complete removal of the individual. Less commonly, parts or products of the organisms are harvested (e.g. leaves, fruits, resins, wild honey, bird feathers). Analyses of harvest and yield involving individuals may be quantitatively similar to those involving organism parts or products, because partial harvest may often affect individual survival and demographic traits. Models of sustainable harvesting require both time series of population abundance (relative or absolute) and estimates of demographic parameters (Clark 1981; Walters 1986; Getz and Haight 1989; Royama 1992). Substantial yields are most difficult to sustain if a population is fluctuating. It is important also that models are not based on unrealistic ideals such as assumptions of a constant environment. Details of population methodologies are discussed in 7.2.6 and 7.2.7.

7.1.3.3 At the species level

Scientific information resulting from species inventories supports a wide range of activities. For example:

- For a nation, knowing the identity and geographical distribution of its species is perhaps the most important information available in its attempts to preserve and use its biodiversity. This knowledge comes primarily from inventories of various kinds and provides basic knowledge for day-to-day management decisions regarding natural resources.
- Species inventories across global, regional or national levels are important for establishing patterns of diversity and identifying areas of endemism (see Section 3.3), two primary components in evaluating areas for protected status.
- At more local levels, species inventories are required elements for meeting management objectives for protected areas (UNEP 1993), including maintaining ecosystems and biological diversity, conserving genetic resources, monitoring change, providing for sustainable economic uses such as hunting, fishing, recreation, tourism and forestry, and facilitating education and research.
- New taxa and new biological material of described

taxa collected during the inventory process are essential for clarifying species identifications and relationships (Mound and Gaston 1993). Inventories of small invertebrates or microorganisms often contain a high proportion of undescribed species.

- Inventory activities result in the accumulation of scientific specimens, tissues and other biological material, preserved or living, which help to build the natural history collections of museums, botanical gardens and zoos and provide a basis for scientific studies and conservation management well into the future. Tissues and other living material increase the holdings of gene and tissue banks, seed banks, culture collections and other institutions concerned with genetic resources.
- Studies of specimens collected during inventories yield data useful for resolving the phylogenetic relationships of species, which, in turn, are essential for building predictive classification systems and permit the estimation of character diversity for comparison of biotas (Williams *et al.* 1995). These relationships can be used to help prioritize areas for conservation or other land management decisions (e.g. Vane-Wright 1993).
- Scientific reports, papers, distributional lists and systematic monographs, produced following systematic analysis of natural history collections, may in turn form the basis for many products useful to a general audience, including pamphlets, field guides and photographic guides.
- Information from species inventories may be used in biogeographical analyses to understand patterns of diversity, the processes that have produced the Earth's biological variety and present-day distributions and to predict how biodiversity may change with altered environments. Biogeographical information may also assist in discovering the origins of agricultural pests and diseases, leading to the identification of their natural predators and parasitoids.
- Inventories provide ecologists with data about the presence or absence of species in an area, basic information which is essential for them to begin to understand community structure, function and processes.
- Inventories and the collections they produce also expand the scientific study of the region in question. Information from specimens and from field notes can be incorporated into Geographic Information Systems (GIS) to provide a more sophisticated basis for resource

management. Furthermore, information associated with specimens, including behavioural and ecological data, provides an essential record available to all scientists that were not part of the inventory process itself.

- Species inventories provide the foundation for future industrial applications, particularly those associated with bioprospecting (Reid *et al.* 1993). Likewise, the discoveries that result from inventories can support agricultural and forestry programmes.
- Finally, inventories contribute to the education and training of scientists, and therefore help build biodiversity science capacity. Moreover, in the long run inventories invariably contribute to general public education about biodiversity and conservation.

Although the advantages of inventorying biodiversity are clear to many scientists and non-scientists, some workers have questioned the relevance of some of the products (in particular species lists) to practical problems of conservation (Renner and Ricklefs 1994). Their concern is that such efforts may undermine rather than support the scientific discipline of systematics. This is, however, a minority view. Box 7.1.5 illustrates some examples of the usefulness of inventories at the species level.

7.1.3.3.1 Species turnover in ecosystems. Changes in species diversity occur naturally over time in all communities and ecosystems. Human disturbance may change the rate and/or direction of these changes. However, because the dominant organisms in many ecological systems are long-lived, many important changes in communities and ecosystems are too slow for us to sense directly and only long-term monitoring can reveal such important changes (Hellawell 1991; NRC 1993). Species-based monitoring programmes can document natural patterns of change (positive or negative), or lack of change, to establish a baseline for understanding the impact of natural disturbance on species composition and abundance in ecosystems. Once a baseline has been established, it can be used to detect changes in biodiversity (variations from the norm) that result either directly or indirectly from human disturbance. Monitoring can also be used in a predictive manner to test anticipated change, for example as a function of global warming models (Solbrig 1991). Thus, by knowing how different species respond to different stresses, we can predict the extent of local species extinction and replacement and, therefore, ecosystem change (Soulé and Kohm 1989). It is also important that we identify such changes early enough for corrective actions to be taken while multiple options are still available. With reduction in the number of options, the expense of remedial action increases.

Details of species inventorying and monitoring are discussed in Sections 7.2.8 and 7.2.9.

Box 7.1-5: Inventorying of biodiversity at the species level; the value of new species.**Viral resistance in wild maize**

In the late 1970s, plant systematist Rafael Guzman discovered a species of perennial teosinte, or wild corn, in the Sierra de Manantlán mountain cloud forests of southwestern Mexico. This species, later named *Zea diploperennis*, was found to be resistant to the seven major viral diseases that infect its cultivated relative, *Z. mays* (Iltis 1988). Furthermore, *Z. diploperennis* was found to have the same chromosome number as *Z. mays* and it has been possible to transfer some of the viral resistance to cultivated corn. Four new commercial lines have already been produced and, considering that corn is one of the three most important crops world-wide, with an annual value of nearly US\$60 billion, this find is estimated to have a potential annual value of US\$4.4 billion. This example emphasizes the importance of plant inventories and systematic research in agricultural productivity.

Utilizing the biodiversity of tropical forests

One strategy for the future preservation of large tracts of tropical forest might be to set up 'extractive reserves' like those of the Brazilian Amazon. Currently the two main products of such areas are rubber and brazil nuts. Inventorying the many plant products used by indigenous peoples may enable these species to be supplemented by others, making extractive reserves more economically viable (Prance 1990). In Amazonia, new products that can be harvested or extracted without felling might include copaiba balsam, from trees of the genus *Copaifera*. Used locally as a medicine and scent, copiba balsam has been used abroad in varnishes and may also have a future in the cosmetics industry. Similarly, the large, oily seed of the androbia tree, *Carapa quianensis*, may be useful for cosmetics. Palm trees may be exploited for their fruits, their nut oil or fibres from their leaves. Nuts of the babassu palm, *Orbignya phalerata*, may be used as fuel and for making charcoal. Many cosmetics have already been produced using ingredients from tropical forests. A more unusual example, however, has been the recent marketing of Ben & Jerry's Homemade Ice Cream flavour, Rainforest Crunch.

Tomato cultivation

In December 1962, whilst on an expedition in the Peruvian Andes, botanists Hugh Iltis and Don Ugent collected a 'tangled, yellow-flowered, sticky-leaved, ratty-looking, wild tomato' (Iltis 1988). The fruits of this plant were small and green-and-white striped. Some of the seed was sent to tomato geneticist Charles Rick, at the University of California, Davis, to grow. After fourteen years of research Professor Rick identified the plant as a new species and named it *Lycopersicon chmielewskii*. When crossed with a commercial variety of tomato (*L. esculentus*) several strains (or hybrids) with larger fruit and improved colouring were produced. More importantly, the fruits of the crossbred plants had a greatly increased content of soluble solids, including fructose, glucose and other sugars. The value to the tomato industry of the genes from this one new species is estimated to be US\$8 million per year (Iltis 1988).

Rattans

Following timber, rattans (Palmae) are the second most important source of export earnings from tropical forests. The trade in rattan products accounts for more than US\$1 billion annually (Plotkin 1988). China, Indonesia, India, Malaysia, the Phillipines, Sri Lanka and Thailand all support major rattan industries, providing employment for at least 0.5 million people. The international market uses rattans in the manufacture of cane furniture, while domestic markets use rattan in mats, baskets, traps, dyes and medicines. Since 90% of the rattan used in industry comes from the wild, this exploitation has contributed to a decline in the major commercial rattan species as well as those valuable to local markets. Most of the 600 species of rattan are native to South and Southeast Asia; 104 of these may be found in the Malay Peninsula alone, 38% of these being endemic. Of these 104 species, 98 are categorized as threatened or endangered. Research is now under way to investigate the taxonomy and silviculture of Malaysian rattans to bring some of them into cultivation, in an effort to lessen the pressure on wild species and to increase the economic benefits derived from this industry (Plotkin 1988).

7.1.3.4 At the ecosystem and landscape levels

Inventorying ecosystems and monitoring changes in their character and processes are essential for distinguishing short-term variation from long-term patterns (Chernoff 1986). Ecosystem monitoring is important for management and policy making in many ways, including:

- understanding ecosystem processes;
- understanding the effects of landscape fragmentation, habitat destruction and other forms of disturbance;
- distinguishing where population trends are due to

natural fluctuations as opposed to anthropogenic factors;

- predicting the possible effects of global climate change;
- predicting the ecological changes that may follow the extinction of one or more key species or taxonomic groups;
- measuring changes in Earth cover and land use and the impacts of these on biodiversity.

Land usage can change rapidly, particularly in agricultural and urban landscapes (Forman and Gordon 1986). Also, ecosystem limits can extend or shrink over time even within protected areas. The problem of 'shifting mosaics', especially within protected areas, can be better understood with information on the distribution of different biotope and ecosystem types from remote sensing (see Section 7.2.10.4). The dynamic characteristics of a watershed, for example, are best inferred through this process and the resultant maps provide information on features such as changes in levels of water bodies and river courses. Likewise, the extent of littoral vegetation on beaches, soil binders in sand dunes, and mangrove vegetation along

estuarine shorelines, all of which are important in regulating soil erosion, can be represented and monitored by remote sensing.

Within the nearshore areas, and extending around the margins of global landmasses, species in coastal ecosystems are being subjected to increased stress from toxic effluents, habitat degradation, excessive nutrient loadings, harmful algal blooms, emergent disease fallout from aerosol contaminants, and episodic losses of marine resources from pollution effects and over-exploitation (see Section 6.1.9). The long-term sustainability of biodiversity of resource species in coastal ecosystems as sources for healthy economies appears to be diminishing. A growing awareness of problems such as these has accelerated efforts to assess, monitor and mitigate the stresses on coastal ecosystems (Sherman 1994).

Box 7.1-6 illustrates the importance of monitoring in marine ecosystems. Details of ecosystem and landscape monitoring are given in 7.2.10, while monitoring of the rehabilitation of degraded ecosystems is discussed in Section 11.3.2.2.

7.1.4 The rationale for inventorizing and monitoring biodiversity inside and outside protected areas

There are two aims of monitoring in protected areas: (1) to provide managers with the information they require for

Box 7.1-6: Monitoring in marine ecosystems.

A critical feature of marine ecosystem monitoring strategies is the development of a consistent long-term database for understanding interannual changes and multi-year trends in biomass yields. For example, during the late 1960s when there was intense fishing within the Northeast US Continental Shelf ecosystem, marked alterations in fish abundances were observed. The finfish biomass of economically important species (e.g. cod, haddock, flounders) declined by approximately 50%. This was followed by increases in the biomass of small elasmobranchs (dogfish and skates), and led to the conclusion that the overall carrying capacity of the ecosystem for finfish did not change (Anthony 1993; Collie 1991). However, the excessive fishing effort on the more highly valued species allowed for the lower-valued elasmobranchs to increase in abundance. Management of the marine fisheries will need to take these kinds of species dominance shifts into account in developing strategies for long-term economic sustainability of the fisheries.

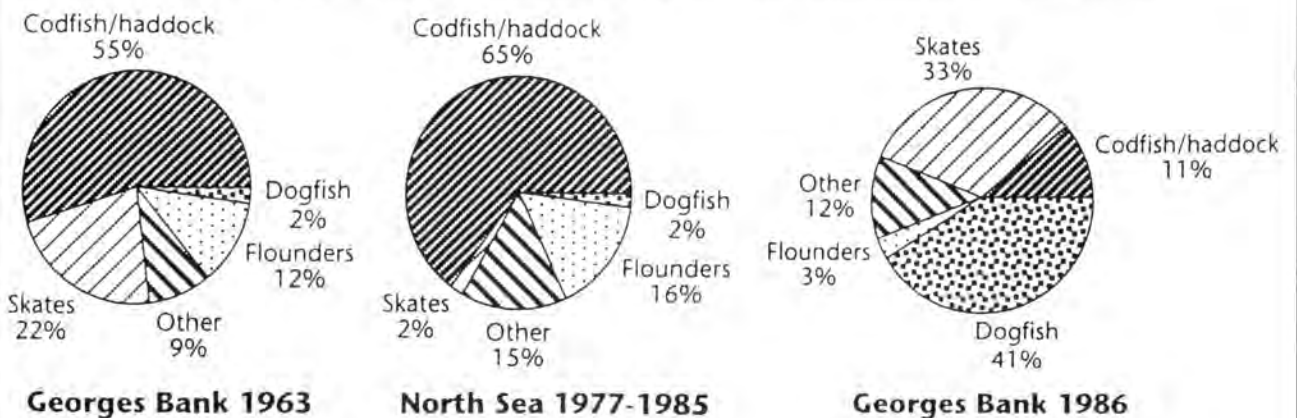

Species shift and abundance of small elasmobranchs (dogfish and skates) on Georges Bank in the North-east Continental Shelf ecosystem of the United States compared with the North Sea ecosystem (adapted from Anthony 1988).

effective management, and (2) to provide information as part of national and international monitoring programmes.

The first requires each protected area to have a programme that identifies the monitoring needs and the resources available. It also specifies the type of monitoring activity, and where and when it should be carried out. The second objective requires guidance and support from the appropriate national and international authorities, specifying which programmes to follow and identifying appropriate methodologies (Lucas 1992). Although these stipulations were formulated for protected areas, they are equally applicable to many areas without protection.

7.1.4.1 Management effectiveness in protected areas

There is no global review of management effectiveness, but experience and reviews of protected areas in South America and the Caribbean suggest that monitoring the effectiveness of management is extremely important. The need for long-term monitoring is therefore clear. Protected areas have a legal designation and, usually, a set of management objectives set out either in legislation or in a management plan. Programmes are needed to monitor the degree of implementation of these objectives and the effectiveness of management practice, in order for action to be taken to correct both inappropriate management and action that is having unforeseen results. It may be sensible also to have the involvement of independent advisors who assist monitoring activity or carry out periodic 'peer' review.

Monitoring in protected areas assists the development of management strategies (Spellerberg 1991). For example,

data from aerial photographs and visitor surveys were used to quantify changes and provide a database for long-term monitoring of Rondane National Park in Norway (Fry *et al.* 1992).

Protected area experts meeting at the Fourth World Congress on National Parks and Protected Areas identified four criteria important in the assessment of management effectiveness:

- clear management objectives,
- availability of resources to implement the objectives,
- achievement of objectives, and
- monitoring of implementation of objectives.

It is also necessary to develop and adopt internationally accepted guidelines for assessing management effectiveness. Once developed, the agreed methods/guidelines need to be tested further, disseminated, and their implementation encouraged.

7.1.4.2 Status of identified features in protected areas

Most protected areas are established to conserve key features, whether these are species, biotopes, ecosystems or landscapes. There is a need to monitor the status of these features using appropriate methods so as to manage them effectively. An example of such monitoring programmes is that of the Kruger National Park in Box 7.1-7.

Box 7.1-7: Monitoring of one of the world's largest game parks: the Kruger National Park, South Africa (from: Kruger National Park 1994).

The mission of scientific work in the national park is to develop and promote a thorough understanding of the Kruger National Park ecosystems, and to provide high-quality scientific knowledge skills and resources, in order to facilitate and verify rational management of the national park. This is achieved through three main objectives.

To establish inventories of the components of the ecosystem

The inventory work is far advanced and attention is mostly focused on the next step – determining the function and interrelations of these components. However, new species are constantly found, especially among the small life-forms.

To develop an understanding of the functioning and inter-relationships of the components of the ecosystem, including their dynamics in space and time

The Kruger National Park is one of the largest conservation areas on the African continent and comprises about 2 million ha with a very rich biological diversity. To monitor changes in such a system calls for either considerable manpower or very specialized techniques. Researchers have developed innovative techniques, for example, to census animals, monitor vegetation changes and assess water requirements.

To evaluate and study, where necessary, human-induced and natural influences and problems on the ecosystem

The objective is to study and prescribe remedial methods. These are often *ad hoc* projects developed to cope with particular situations. One such study was to find a practical way of vaccinating free-ranging animals. A solution was found, consisting of an aerial (helicopter) method, using discardable dart syringes.

Table 7.1-1: The number of Protected Areas (PAs) in tropical regions and the percentage with species inventories (I) (based on limited field observations, partial surveys of the area, and systematic surveys), together with percentage having comprehensive species inventories (C) (based on systematic surveys only) shown in parentheses (from: Murray et al. 1992; see also Stohlgren et al. 1995).

(a) PLANTS

Region	No. PAs ¹	Higher Plants		Trees	
		I	C	I	C
Africa	2543	1.6	(0.6)	1.2	(0.4)
Asia	3599	2.2	(0.4)	1.3	(0.3)
Latin America ²	2413	1.1	(0.3)	0.3	(0.0)
Pacific	160	9.4	(7.5)	1.3	(0.0)
Combined	8715	1.8	(0.6)	1.0	(0.2)

(b) ANIMALS

Region	No. PAs ¹	Mammals		Birds		Reptiles		Amphibians		Fish		Butterflies	
		I	C	I	C	I	C	I	C	I	C	I	C
Africa	2543	4.3	(0.3)	3.8	(0.9)	1.2	(0.2)	0.7	(0.0)	0.1	(0.0)	0.1	(0.0)
Asia	3599	3.3	(0.3)	4.8	(0.8)	1.0	(0.1)	0.7	(0.1)	0.1	(0.0)	0.0	(0.0)
Latin America ²	2413	1.4	(0.1)	1.7	(0.3)	1.1	(0.1)	0.7	(0.1)	0.0	(0.0)	0.0	(0.0)
Pacific	160	6.3	(5.6)	9.4	(9.4)	5.0	(4.4)	0.0	(0.0)	0.0	(0.0)	0.0	(0.0)
Combined	8715	3.1	(0.3)	3.7	(0.9)	1.1	(0.2)	0.7	(0.1)	0.0	(0.0)	0.0	(0.0)

1. All categories of Protected Area.

2. Including Mexico, Central and South America and Caribbean.

The development of improved monitoring programmes in protected areas is important. However, not only do many protected areas lack monitoring programmes, but many also do not have even basic species inventories. In a study of literature relating to 8 715 protected areas in tropical forest countries, WCMC was able to locate inventories of major taxonomic groups for only 5% of the sites (Table 7.1-1).

7.1.4.3 Threats to protected areas

Many protected areas are under threat. The majority of 135 national parks, in more than 50 countries surveyed in 1982, reported threats of one nature or another (Machilis and Tichnell 1985). More recent surveys show no improvement in the situation, and it is important therefore that such threats to protected areas – and the effects of those threats – be identified and monitored.

7.1.4.4 Use and socio-economic benefits of protected areas

Protected areas provide a range of services and benefits to humans (see Section 13). Important information for the management of these areas is provided by monitoring programmes which address what resources are used,

either consumptively or non-consumptively, and what services are provided. Variables can then be identified and used to monitor both the health of the resource and its value (usually economic or social). One of the easier value variables to monitor is visitation, but it may be necessary to monitor a much wider range of variables to assess more completely the value of protected areas to society.

For example, a report has recently been prepared for the Great Barrier Reef Marine Park Authority which assessed the economic and financial values of the Great Barrier Reef during 1991–2 (Driml 1994). Crudely summarized, tourism is estimated to be worth A\$682 million, commercial fishing A\$128 million, recreational fishing and boating A\$94 million and research A\$19 million, for a total of A\$923 million. This research was extended to cover a number of other areas, and the total value of tourism and recreation in six major protected area complexes was estimated as over A\$1.9 billion. This is clearly a substantial input to the economy of the regions concerned, underlining the importance of understanding the value of these areas (see Section 12). This value is, of course, also augmented by a

range of intangible benefits, such as maintaining local to global processes intact.

The IUCN Commission on National Parks and Protected Areas is currently reviewing mechanisms for assessing and monitoring the true value of protected areas, with the aim of developing a methodology that can be adopted more widely.

7.1.4.5 Inventorying and monitoring outside protected areas

Those natural areas not designated as protected face the pressure of being converted to other land uses such as cash-crop production. A major portion of a nation's forests, for example, are generally earmarked as timber-production areas (Harris 1984). Sound management of these areas requires that an inventory be carried out to ascertain what resources are available and in what quantities, and that the inventory is repeated at regular intervals, for example every ten years, to provide information on sustainable management of the resources. An example of the importance of such resource inventorying and monitoring is shown in Box 7.1-8. Inventorying and monitoring in such national programmes are almost always targeted at timber species, and, in some cases, at non-timber species such as rattans.

The global level of primary productivity to support the present annual yield of fishery resources has been reached (94 million metric tons). It is likely that substantial unmanaged increases in fishery biomass yields will be obtained by fishing down the food web from fishes, causing losses in biodiversity at the species abundance level (Pauly and Christensen 1995). The need for monitoring these changes at the global level in relation to cascade effects throughout the food web of marine ecosystems is recognized as an important contribution to the sustainable management of fisheries (Beddington, 1995).

7.1.5 Summary

- Inventorying and monitoring are used to assess the status of biodiversity and indicate changes at all levels, from genes to ecosystems and landscapes. Such changes can, for example, signal improvements or deterioration in management and sustainable utilization. Species inventories are important in the selection of protected and threatened areas, endemic areas, and ecologically and economically important yet sensitive areas. Modelling of the results of monitoring studies can provide predictions that anticipate species changes with changing environmental conditions.
- Inventorying of biodiversity is the fundamental starting point for its conservation, sustainable use and management. A knowledge of the presence and abundance of organisms in a given area, from local to regional or global scales, is crucial for the

preservation, management and utilization of national and global biotic resources. Inventorying of genes, populations, species, biotopes, ecosystems and landscapes tells us what is there, and, to some extent, their relationships. It also can tell us what is useful and what is threatened.

- Inventorying has an essential spatial component: it tells us where biodiversity is found. This is important for establishing the origins of both harmful and beneficial organisms. Such *beneficials* may be anything from pollinators and biocontrol agents, to potential new crops and medicinal animals, plants, fungi and microorganisms.
- Monitoring is a step beyond inventorying and refers to assessing how, and to what extent, biodiversity *changes* over time. Monitoring is essential for the continued management of biodiversity.
- Monitoring deciphers natural from significant human-induced changes and provides guidelines for managing ecosystems for optimal sustainability. With increasing ecosystem disturbance and landscape fragmentation, it is vital to monitor both short-term changes (days to months) and long-term changes (years to centuries).
- Monitoring of protected areas is crucial for the continual updating of information on the state of the wealth of biodiversity within them. Monitoring of human-utilized areas is also crucial to determine whether that utilization is optimal.

References

- Anonymous** 1973. *Forestry and Forest Industries Development: Malaysia. A National Forest Inventory of West Malaysia 1970-1972*. FO:DP/MAL/72/009 Technical Report 5. United Nations Development Programme, FAO, Rome.
- Anonymous** 1974. *Forestry and Forest Industries Development: Malaysia. An Inventory of Mixed Dipterocarp Forests of Sarawak 1969-1972*. FO:DP/MAI/72/009 Technical Report 2. United Nations Development Programme, FAO, Rome.
- Anthony, V.C.** 1993. The state of groundfish resources off the northeastern United States. *Fisheries* **18**: 12-17.
- Avise, J.C.** 1994. *Molecular Markers, Natural History and Evolution*. Chapman and Hall, New York.
- Baverstock, P.R. and Moritz, C.** 1990. Sampling design. In: Hillis, D.M. and Moritz, C. (eds), *Molecular Systematics*, 13-24. Sinauer Associates, Sunderland, Mass.
- Beddington, J.** 1995. The Primary Requirements. *Nature* **374**: 213-214.
- Bowen, B.W., Abreu-Grobois, F.A., Balazs, G.H., Kamezaki, N., Limpus, C.J. and Ferl, R.J.** 1995. Trans-Pacific migrations of

Box 7.1-8: Malaysia: forest resources inventory.

Prior to 1962, no national forest inventory data were available within Peninsular Malaysia. To overcome this lack of essential planning data, the Forest Department initiated a Forest Resources Reconnaissance Survey (FRRS), designed to assess the extent, distribution and nature of the forest resource on all forested lands. This survey was undertaken to provide data, particularly with regard to controlling harvesting of the forests. In 1965, it was expanded to provide additional data on forest resources and development potential as required by the National Land Capability Classification (LCC). Under the FRRS:

- forest lands were classified into broad forest types;
- the distribution and extent of the forest types were recorded;
- the commercial volume of timber per unit area for each type of forest was estimated.

The survey was completed in 1969. It involved the preparation of forest resource maps on an administrative district basis, based on aerial photo interpretation and sufficient quantitative survey on the ground. As a consequence of the ground survey, new tree species were found that were previously not known to occur in Peninsular Malaysia, and tree species were found in places where they were not known to exist before.

The FRRS led to the first national forest inventory of Peninsular Malaysia (1970–2), a project that was supported by the UNDP and FAO as part of the development programme for the forestry and forest industries sector of Malaysia, which consisted primarily of reviewing and complementing the results of the country-wide forest resources survey, with a view to preparing a forest development plan for Peninsular Malaysia. The inventory involved field sampling of main commercial species and species groups in 384 random cluster sample plots laid out throughout Peninsular Malaysia (Anonymous 1973). Each sample, which included 12 separate enumeration plots, totalled 36.4 ha in area. Trees of 305 mm diameter at breast height were enumerated. Mangrove forests were excluded from the survey.

The national forest inventory was repeated in 1981–2 when the most important commercial species of rattan were included in the survey, and again in 1991–2. As part of the development programme for the forestry and forest industries sector of Malaysia, an inventory of the mixed dipterocarp forests of the state of Sarawak on the island of Borneo was carried out between 1969 and 1972 (Anonymous 1974). As with the inventory in Peninsular Malaysia, the main commercial timber species and species groups were enumerated in a total of 503 samples.

Tree flora of Malaysia

The tree flora of Peninsular Malaysia has been documented in four volumes, written by 15 authors and edited by Whitmore (1972, 1973) and Ng (1978, 1989). This work covers over 3000 tree species reaching 90 cm girth, including the gymnosperms and all 99 families of flowering plants with tree species in the region. Herbarium collections at the Forest Research Institute in Malaysia, and at Singapore, were the main source of the studies, with reference to collections in Europe on critical matters.

Throughout the work, keys are based on leaves and twigs as far as possible as these are all that are usually available for identification. The bias towards use in the forest is also shown by the full descriptions of the bole, bark and crown of the living tree, notes on its distribution and ecology, and on its seedlings, saplings, silviculture and economic uses.

Work has started on the tree flora of the Malaysian states of Sabah and Sarawak on the island of Borneo.

Rattan flora of Peninsular Malaysia, Sabah and Sarawak

Based on both herbarium studies and extensive field work, the rattan flora of Malaysia has been documented by Dransfield (1979, 1984, 1992).

the loggerhead turtle (*Caretta caretta*) demonstrated with mitochondrial DNA markers. *Proceedings of the National Academy of Sciences USA* 92: 3731–3734.

Clark, C.W. 1981. Bioeconomics. In: May, R.M. (ed.), *Theoretical Ecology: Principles and applications*, 2nd edn. 387–418. Blackwell Scientific Publications, London.

Chernoff, B. 1986. Systematics and long-range ecological research. In: Ke Chung Kim, K. and Knutson, L. (eds), *Foundations for a National Biological Survey*. 29–45. Association of Systematics Collections, Lawrence, Kansas.

Collie, J.S. 1991. Adaptive strategies for management of fisheries resources in large marine ecosystems. In: Sherman, K.,

- Alexander, L.M. and Gold, B.D. (eds), *Food Chains, Yields, Models and Management of Large Marine Ecosystems*. 225–242. Westview Press, Boulder, Colorado.
- Csuti, B. 1994. Gap Analysis: mapping biodiversity for conservation and management. *Endangered Species Update* **11**: 1–4.
- Daugherty, C.H., Cree, A., Hay, J.M. and Thompson, M.B. 1990. Neglected taxonomy and continuing extinctions of tuatara (*Sphenodon*). *Nature* **347**: 177–179.
- Dransfield, J. 1979. *A Manual of the Rattans of the Malay Peninsula*. Malayan Forest Records No. 29. Forest Department, Kuala Lumpur.
- Dransfield, J. 1984. *The Rattans of Sabah*. Sabah Forest Records 13. Forest Department, Sabah, Sandakan.
- Dransfield, J. 1992. *The Rattans of Sarawak*. Royal Botanic Gardens, Kew and Sarawak Forest Department, Kuching, Sarawak.
- Driml, S. 1994. *Protection for Profit. Economic and financial values of the Great Barrier Reef World Heritage Area and other protected areas*. Great Barrier Reef Marine Park Authority Research Publication No. 35.
- Elst, R. van der. 1993. *A Guide to the Common Sea Fishes of Southern Africa*. Struik, Cape Town.
- Feidler, P.L. and Jain, S.K. (eds) 1992. *Conservation Biology: The theory and practice of nature conservation, preservation and management*. Chapman and Hall, New York.
- Forman, R.T.T. and Gordon, M. 1986. *Landscape Ecology*. John Wiley, New York.
- Fry, G.L., Norris, S., Gjelland, M and Dahle, E. 1992. The use of geographic information systems in National Park Management: the Rondane National Park case study. In: Willison, J.H.M., Bondrup-Nielson, S., Drysdale, C., Herman, T.B., Munro, N.W.P and Pollock, T.L. (eds), *Science and the Management of Protected Areas*. 481–484. Elsevier, London.
- Getz, W.M. and Haight, R.G. 1989. *Population Harvesting: Population models of fish, forest and animal resources*. *Monographs in Population Biology No. 27*. Princeton University Press, Princeton, NJ.
- Glowka, L., Burhenne-Guilmin, F. and Synge, H. 1994. *A Guide to the Convention on Biological Diversity*. IUCN, Gland, Switzerland.
- Harris, L.R. 1984. *The Fragmented Forest*. University of Chicago Press, Chicago.
- Hellawell, J.M. 1991. Development of a rationale for monitoring. In: Goldsmith F.B. (ed.), *Monitoring for Conservation and Ecology*. 1–14. Chapman and Hall, London.
- Hillis, D.M. and Moritz, C. 1990. *Molecular Systematics*. Sinauer Associates, Sunderland, Mass.
- Iltis, H.H. 1988. Serendipity in the exploration of biodiversity. What good are weedy tomatoes? In: Wilson, E.O. (ed.), *Biodiversity*. 98–105. National Academic Press, Washington DC.
- International Union for Conservation of Nature and Natural Resources 1994. *IUCN Red List Categories*. IUCN, Gland.
- Kruger National Park. 1994. *Aspects of Environmental Research in Kruger National Park*. Prepared for the CNPPA Africa Regional Working Session, 11–17 October 1994.
- Lucas, P.H.C. 1992. *Protected Landscapes: A guide for policy-makers and planners*. Chapman and Hall, London.
- Machilis, G.E. and Tichnell, D.L. 1985. *The State of the World's Parks*. Westview Press, Boulder, Colorado.
- Mound, L.A. and Gaston, K.J. 1993. Conservation and systematics – the agony and the ecstasy. In: Gaston, K.J., New, T.R. and Samways, M.J. (eds), *Perspectives on Insect Conservation*. 185–195. Intercept, Andover, UK.
- Murray, M.G., Green, M.J.B. and Walter, K.S. 1992. *Status of Plant and Animal Inventories for Protected Areas in the Tropics*. A Contribution to the ODA Strategy Programme for Research on Forestry and Agroforestry implemented by the Oxford Forestry Institute under its Forestry Research Programme. WCMC, unpublished report.
- National Research Council 1993. *A Biological Survey for the Nation*. National Academy Press, Washington, DC.
- Ng, F.S.P. (ed.) 1978. *Tree Flora of Malaya. Vol. 3*. Longman, Kuala Lumpur.
- Ng, F.S.P. (ed.) 1989. *Tree Flora of Malaya. Vol. 4*. Longman, Kuala Lumpur.
- Olson, D. and Dinerstein, E. 1994. *Assessing the Conservation Potential and Degree of Threat Among Ecoregions of Latin America and the Caribbean: A proposed landscape ecology approach*. The World Bank, Washington, DC.
- Pain, S. 1994. Witness for the deceased. *New Scientist* **143**: 21–25.
- Pauly, D. and Christensen, V. 1995. Primary production required to sustain global fisheries. *Nature* **374**: 255–257.
- Plotkin, M.J. 1988. The outlook for new agricultural and industrial products from the tropics. In: Wilson, E.O. (ed.), *Biodiversity*. 106–116. National Academy Press, Washington DC.
- Prance, G. 1990. Fruits of the rainforest. *New Scientist* **125**: (1699): 42–45.
- Prowlesland, R.G., Lloyd, B.D., Best, H.A. and Merton, D.V. 1992. Breeding biology of the *Kakapo strigops habroptilus* on Stewart Island, New Zealand. *Ibis* **134**: 361–373.
- Rebello, A.G. and Siegfried, W.R. 1990. Protection of Fynbos vegetation: ideal and real-world options. *Biological Conservation* **54**: 15–31.
- Reid, W., McNeely, J., Tunstall, D., Bryant, D. and Winograd, M. 1993. *Biodiversity Indicators for Policy-Makers*. World Resources Institute, Washington, DC.
- Renner, S.S. and Ricklefs, R.E. 1994. Systematics and biodiversity. *Trends in Ecology and Evolution* **9**: 78.
- Royama, T. 1992. *Analytical Population Dynamics*. Chapman and Hall, London.
- Sherman, K. 1994. Sustainability, biomass yields, and health of coastal ecosystems: an ecological perspective. *Marine Ecology Progress Series* **112**: 277–301.
- Solbrig, O.T. (ed.) 1991. *From Genes to Ecosystems: A research agenda for biodiversity*. International Union of Biological Sciences, Paris.
- Soulé, M.E. and Kohm, K.A. (eds) 1989. *Research Priorities for Conservation Biology*. Island Press, Washington, DC.
- Spellerberg, I.F. 1991. *Monitoring Ecological Change*. Cambridge University Press, Cambridge.
- Stohlgren, T.J., Quinn, J.F., Ruggiero, M. and Waggoner, G.S. 1995. Status of biotic inventories in US national parks. *Biological Conservation* **71**: 97–106.

- Triggs, S.J., Powlesland, R.G. and Daugherty, C.H.** 1989. Genetic variation and conservation of Kakapo (*Strigops habroptilus*: Psittaciformes). *Conservation Biology* **3**: 92–96.
- United Nations Environment Programme** 1993. *Guidelines for Country Studies on Biological Diversity*. UNEP, Nairobi.
- Vane-Wright, R.I.** 1993. Systematics and the conservation of biodiversity: global, national and local perspectives. In: Gaston, K.J., New, T.R. and Samways, M.J. (eds), *Perspectives on Insect Conservation*. 197–211. Intercept, Andover.
- Walters, C.** 1986. *Adaptive Management of Renewable Resources*. Macmillan, New York.
- Whitmore, T.C. (ed.)** 1972. *Tree Flora of Malaya. Vol. 1*. Longman, Kuala Lumpur.
- Whitmore, T.C. (ed.)** 1973. *Tree Flora of Malaya. Vol. 2*. Longman, Kuala Lumpur.
- Williams, P.H., Gaston, K.J. and Humphries, C.J.** 1995. Do conservationists and molecular biologists value the differences between organisms in the same way? *Biodiversity Letters* **2**: 67–78.
- Winans, G.A., Aebersold, P.B., Urawa, S. and Varnavskaya, N.V.** 1994. Determining continent of origin of chum salmon (*Oncorhynchus keta*) using genetic stock identification techniques: status of allozyme baseline in Asia. *Canadian Journal of Fisheries and Aquatic Science* **5** (Suppl. 1): 95–113.
- World Conservation Monitoring Centre** 1992. *Global Biodiversity: Status of the world's living resources*. Chapman and Hall, London.
- Husch 1978). Existing methods may need to be adapted to the new conditions posed by the problem being addressed. However, although efficiency may be increased by using such particular methods, comparability may be sacrificed. Even if there are no immediate plans to compare results with those from other localities, the use of standard methods will ensure future comparability.

Choice of methods is best made from a problem-solving perspective:

- clearly define the problem, its spatial scale and whether the approach is systematic, ecological or managerial;
- outline the goals – including the needs of both clients and users;
- identify the types of biological information required and the scale and intensity of measurement;
- determine the statistical precision needed;
- be clear on the time needed to achieve the goals, and
- determine whether resources (material, financial and human) are sufficient.

7.2 Scales, planning and approaches to inventorying and monitoring

7.2.1 Introduction

How species-rich are the montane forests of Ecuador? How many species of birds inhabit Royal Chitawan National Park in Nepal? To what degree are the trees of the humid lowland forest of Papua New Guinea patchily distributed on a local scale? Can the present species composition of commercial catches support sustainable fisheries within the South China Sea ecosystem? The answers to these questions require the setting of clearly defined goals, the collection of existing and new field data and a statistical framework with which to analyse the information collected. An understanding of the ecological dynamics of the locale or the region then helps to interpret the results. This chapter discusses *approaches* to the inventorying and monitoring of biodiversity, including scales of measurement, project planning and baseline data, at the various levels: genetic, population, species, biotope, landscape and global.

Many techniques and sampling methodologies are currently available for inventorying and monitoring (e.g. UNEP 1986; Goldsmith 1991; Spellerberg 1991; Heyer *et al.* 1994), reflecting the varying nature of organisms, peculiarities of different ecosystems and the diverse approaches of researchers towards the various goals.

When planning inventory and monitoring programmes, it is important to match the method with the precise aim (see

Framed in concrete terms, the types of questions that are asked when developing a monitoring programme may be:

- What is the size and location of the area that is to be sampled?
- Over what time period is it intended to assess biodiversity, e.g. every 1, 5 or 10 years?
- What should be the level of measurement to detect trends? For example, is the aim to detect a 20% change over 5 years, or a 30% change over 2 years?
- What percentage of the time detects significant changes when otherwise there was none (i.e. what will be the alpha level)?
- What percentage of the time detects no population change when in fact there was one (i.e. what will be the beta level)?
- What additional measures of population change should be incorporated (e.g. survivorship, fecundity, turnover)?
- What is the increase in human impact on the system, community or population over the next 1, 5 or 10 years?

One extremely important consideration is the cost-effectiveness of sampling and analysis in inventorying and monitoring (see Margules and Austin 1991). In general, costs increase with the geographical scale of a project, and at the regional or global level (see 7.2.2.1) costs may be one of the most important factors in developing an inventorying or monitoring programme.

7.2.2 Scales of measurement

7.2.2.1 Spatial scale

7.2.2.1.1 Local assessments. All inventorying and monitoring programmes require an acute awareness of spatial scale, which is determined by the question in hand. Local assessments, for example, are usually driven by local needs and resources. The breadth of questions that can be addressed and the number of alternative methodologies that may be deployed often make the design of local assessments difficult and complex. Methods range from compiling simple checklists to comprehensive programmes which track changes in all the major components of local ecosystems. It is therefore critically important to define precisely the scales and goals *before* beginning any undertaking (Samways 1993). Examples of local inventories include sampling within individual biotopes or ecosystems in parks, protected areas, watersheds, lakes, wetlands, agricultural fields and their surrounds, tree plantations, rivers, estuaries and coastlines.

7.2.2.1.2 Regional assessments. Regional assessments include, for example, studies of one or more ecosystems, large river systems, political entities (states, provinces or countries) or continents, ocean basins, seas and large marine ecosystems. Regional inventories may be assembled from analyses of the results of local inventories. At this level, similar constraints to those of global projects may apply. Factors such as the regional infrastructure will be important in defining procedures. For example, in developed nations, the infrastructure of roads and human communities lends itself to inventories being carried out by networks of local workers. In contrast, in developing nations an entire programme, often in remote regions, may have to be conducted by a small centralized staff. This limitation of personnel in tropical and Southern Hemisphere regions, which contain the greater part of all terrestrial biodiversity, is a major limiting factor to biodiversity conservation and utilization. The problems of science capacity and human resources urgently need to be addressed (see Chapter 7.4).

7.2.2.1.3 Global assessments. Global assessments are generally constrained simply by the vastness of the sample area, and as a result the resolution is generally lower than at regional or local levels. A combination of broad-scale and point-sampling methods is used. Broad-scale sampling generally requires the use of remote-sensing methods (see 7.2.10.4) and measures at the levels of the biotope and

landscape, while point-sampling involves measuring a representative selection of localized sampling points. Data from a series of points, when coupled with remote sensing, may provide information that can be extrapolated for global coverage. The limitation is the ability to visit and sample enough points to resolve adequately the global patterns of interest. Information from point sampling is also needed to substantiate data from remote-sensing activities. The point-based method would be appropriate to a programme that depends on an international network of teams, whereas a remote-sensing effort can be carried out by the staff of a single institution based at a central location, with the help of local people familiar with the area.

Other global assessments take a different approach and focus on well-known taxa (see 7.2.9.4), such as birds (ICBP 1992), and plot areas of conservation interest for that group. A goal of some systematists is to use the results of inventorying efforts to compile a global inventory of the species of each group. However, a complete inventory has not yet been achieved for any major group of organisms as new species continue to be found, even for the most well-known groups, such as birds and primates.

7.2.2.2 Temporal scale

The time needed to 'complete' an inventory and how often it will be necessary to conduct monitoring surveys will depend on what is being measured, how the results will be applied, what resources are available to carry out the study, and political and economic stability in the subject area.

Most local inventory efforts are intensive, in that investigators will attempt to assemble as complete a collection of the target species and groups as possible. In contrast, the alternative approach of rapid assessment of species diversity, sometimes using recognizable but unnamed taxa (so-called RTUs), is relatively non-intensive. Such assessments are mostly for immediate conservation or resource management needs or actions (see 7.2.9.3).

Choosing an appropriate time frame over which monitoring will take place is crucial to the success of the exercise. If this is not done there may then be a deficiency of data, making statistical inference difficult and results and management options open to question.

Long-term monitoring, over many years and decades, can provide considerable insight into rhythmic versus stochastic patterns and successional events and will yield a much more complete inventory (e.g. Dallmeier 1992; Owen 1991; Woiwod 1991). The time of year when starting and ending a sampling programme may be crucial, as organisms are responsive to these seasonal changes, even in the tropics (Wolda 1992). It should be clear whether the primary focus of a study is spatial or temporal, or both. Spatial studies may be done at one time of year with intensive comparable sampling. Temporal studies are much

more demanding, in that to be meaningful, they often have to be done over many years (Dempster 1975).

Long-term monitoring is not just about measuring declines in biodiversity. It also has an extremely valuable role in measuring *improvements* in biodiversity conservation, sustainable utilization and human development.

Large-scale experiments, consistent with the size of harvesting methods, are essential as a step towards adaptive management. Testing the response of biodiversity to an array of experimentally produced resource extraction levels, with monitoring of the results, constitutes an alternative to the monitoring of current harvesting techniques. Assessment of experimental results provides a fast way to adaptive management and thus may prevent the further erosion of biodiversity.

7.2.2.3 *Taxon-specific, taxonomically comprehensive and site-based perspectives*

Certain problems require a focus on certain organisms, for example trends in butterfly populations (Pollard and Yates 1993). Other problems relate to the broader assessment of the biodiversity of all organisms within a specific geographical area, their processes and interactions; an example is the ongoing assessment of all organisms living within the Guanacaste Reserve of Costa Rica (see Box 7.2-5).

For both the taxon- and site-based approaches, decisions must be made as to which species will be assessed (see 7.2.8), how biodiversity will be estimated and how these measures will be interpreted (Reid *et al.* 1993).

7.2.3 Project planning

7.2.3.1 *Standardization*

Inventory and monitoring programmes are greatly enhanced when the results can be compared with those from other sites and times. Comparisons improve scientific research and economic planning and allow different organizations to optimize their efforts through shared results, experiences and decisions. The International Union of Forestry Research Organizations (IUFRO), for example, has developed a set of international guides for monitoring forests (Päivinen *et al.* 1994). These guides list minimum data to be recorded in the course of field surveys and remote sensing activities, in order to maximize the sharing of information.

The validity of such evaluations hinges on the use of methodologies that produce comparable data sets, such as those of Majer *et al.* (1994). Besides an inventory or monitoring programme meeting the goals of an individual site, it may also provide meaningful comparisons with other sites through standardization of sampling and analytical techniques. For example, methods used to sample marine turtles in the Pacific Ocean should be equally suitable for sampling those animals in the Atlantic

Ocean. Likewise, point counts of birds in temperate deciduous forests should be the same as those used in tropical forests. Using the same standardized terminology also greatly increases the comparability of the information collected (Banks *et al.* 1987). To date, global standards exist only for the few oceanic taxa that have co-ordinated global projects and the Man and the Biosphere monitoring sites. However, various international groups are now standardizing techniques for measuring and monitoring the diversity of particular groups of organisms, e.g. amphibians (Heyer *et al.* 1994).

Standardization of sampling methods and data analysis can also allow data from diverse studies to be applied to regional and global problems for which they were not originally intended. However, there may have to be a decision, when new technologies become available, whether comparisons over time are still possible using the old and new approaches.

Standard techniques may be difficult to apply because of limited resources. It is essential that the agreed standard methods are appropriate for different levels of resource availability (see Stork 1994). Gadagkar *et al.* (1990), for example, successfully used a range of cheap standardized sampling methods to look at insect diversity in different forest types in India. Some key strategies for inventorying species are outlined in Box 7.2-1.

7.2.3.2 *Validation and calibration*

There is often little information on the accuracy or completeness with which different sampling methods measure biodiversity, particularly for species-rich groups such as insects and microorganisms. Furthermore, there is often uncertainty as to how efficient one method is in comparison with others for particular organisms in different areas or even in the same area at different times. The calibration of such methods is essential if the meaning of the samples taken is to be properly understood (Solbrig 1991; Samways 1994; Hammond 1994). Intensive and long-term studies of sites provide opportunities for the comprehensive testing and calibration of methods. Perhaps the ultimate intensive site study is the All Taxa Biodiversity Inventory (ATBI) proposed by Janzen and Hallwachs (see Box 7.2-5). Until such highly intensive programmes are funded, investigators need to take advantage of more limited opportunities to evaluate particular methods. For example, different methods of measuring woody plant diversity can be evaluated in 50 hectare plots that have been censused completely (Hubbell and Foster 1983; Condit 1995).

7.2.3.3 *Voucher collections and accompanying data*

7.2.3.3.1 *The importance of voucher specimens.*

Vouchers are collections of organisms that are maintained to provide the permanent, physical documentation of

Box 7.2-1: Key strategies for species inventories (*adapted from: Coddington et al. 1991*).

- Use proven collecting methods for different taxonomic groups in order to standardize techniques with previous and future workers.
- Keep the number of collecting methods for each group to the minimum necessary, but maximize the independence among methods.
- Minimize the complexity of sampling: keep ecological area classifications as simple as possible.
- Use general protocols that work in plot-based or plotless sampling.
- Keep the sampling unit general, simple and comparable: time spent sampling is perhaps the best unit of measure.
- The sample unit (e.g. time spent sampling) must be adjusted to permit adequate numbers of species and individuals per species to be collected: sample unit must be small enough to permit among-sample comparisons.
- Large samples should be assembled from smaller replicate samples.
- Data collected should permit variation to be estimated and analysed, especially with respect to site, the individual investigator, time of day, season or year and sampling method.
- Samples of species and individuals per species should be sufficient to construct species abundance distributions that can be used to estimate species diversity.
- Ideally, sampling should be sufficient to produce confidence intervals on estimates.
- Inventory teams should consist of more than one investigator collecting each target taxon.

species identifications and associated data resulting from inventories (Meester 1990; Miller and Nagorsen 1992). Such collections provide the means of verifying previous identifications and validating observations. In short, they provide essential scientific credibility (Miller 1993; Goodman and Lanyon 1994; Miller and Scudder 1994; Cotterill 1995). Voucher collections are particularly important for inventory data where the taxonomy and identifications of the species are uncertain.

Standards for collecting and storing voucher specimens are generally taxon-specific (see, for example, Bridson and Forman 1992, for plants). They relate to the minimum number of specimens required of each sex, age group and morph for each taxon. Specimens preserved as voucher material must meet certain quality requirements in terms of condition and preparation (Herholdt 1990; Escalante-Pliego 1993), and should be housed according to rigid standards of specimen maintenance in designated specimen repositories.

7.2.3.3.2 Important considerations regarding voucher specimens. Investigators should consider collecting voucher specimens for all species except those that are globally or locally threatened or whose collection is prohibited. Although such prohibitions are unquestionably important for protecting desirable and charismatic

organisms that attract both amateur and professional collectors, they can have adverse scientific implications. Blanket prohibitive legislation in some geographical areas poses a serious threat to the gathering of knowledge about biodiversity, as, for example, with dragonflies in Germany, where it is illegal to collect and preserve any specimens (Eislöffel *et al.* 1993).

The rich natural history collections in many temperate and tropical countries are often the result of the serendipitous activities of enthusiastic amateurs. Legislation restricting collecting may threaten the fountainhead of such amateur enthusiasm, particularly in the young of all nations. In cases where collecting is forbidden or facilities are not available, specimens should be documented with photographs or recordings of vocalizations. In some groups of animals (e.g. birds and Orthoptera) vocalizations are important and useful taxonomic characteristics. For example, acoustic recordings were made in France of a bush cricket that is now extinct (Samways 1989). Photographic records are also effective in identifying individual animals in the case of sea mammals, especially whales.

7.2.3.3.3 Essential collecting permits. Where required, *bona fide* collecting permits must be obtained before

making a voucher collection. The collection, acquisition, possession, transport and deposition of specimens of many taxa are regulated either locally, nationally or internationally. Ironically, although habitat loss and landscape degradation, as well as over-exploitation for commercial purposes, are the greatest threats to wildlife, it is scientific collecting that is often most closely regulated. In some cases, however, collecting is a genuine threat, particularly as species become increasingly rare and soar in commercial deadstock value. Such is the case with many butterflies, such as the Corsican swallowtail, *Papilio hospiton* (New and Collins 1991).

7.2.3.4 Statistical analysis

Prior to any biological investigation, it is essential to determine the statistical analyses that will be used to interpret the data. Inventories that require some measure of abundance might employ either qualitative measurement (e.g. rare, common, abundant) or quantitative measurements. Qualitative measures are usually simpler and less rigid but are neither repeatable nor statistically analysable and are therefore rarely suitable for effective monitoring (Morrison and Marcot 1994; Päävinen *et al.* 1994).

Two factors affect the amount of information obtainable from a biodiversity sample: sample size and the amount of variation in the data. Quantitative measures at the interval, rather than nominal or ordinal, level usually require more labour and are data-intensive, but they provide a stronger basis for statistical inference, population and community modelling and prediction. In quantitative biodiversity studies, the statistical sample size is the number of individuals, populations, species, quadrats, cores, nets, biotopes or localities sampled. However, ultimately it is the actual number of individuals of each species that is often the variable of interest. The numbers and kinds of samples are a means of estimating this. In scientific investigations, sample sizes must be large enough to be biologically representative and meaningful. As samples tend to under-record rare taxa, the investigator should obtain a sample that reliably reproduces the population characteristics as distinct from sampling error effects. It is also important to bear in mind the power and robustness, as much as applicability, of the statistical analyses.

Observer bias, which is the distortion that may occur between different observers when individuals are fatigued, ill-trained or unequally experienced, should be avoided. Each observer should have comparable training and any inter-observer differences identified. Biases, particularly to a particular taxon or life stage, also occur when one particular sampling method is used (Southwood 1978). A range of collecting methods, or so-called 'sampling package', may be necessary to sample all the target taxa (Coddington *et al.* 1992; Stork 1994).

A biologically representative sample for most biodiversity

purposes is best achieved through random sampling. A random sample is obtained by an unrestricted process that disposes all individuals in the target population or community the same chance of being sampled. Random techniques avoid biases and increase reliability (see Hayek 1994a, b). This method is acceptable for most biodiversity studies (Hayek 1994a, b). However, random sampling *per se* may miss locally endemic or very rare species, which are often of great conservation interest.

In restricted random sampling, such as stratified or cluster sampling, the target population is divided into relatively homogeneous groups according to factors that influence variability in that population (e.g. sex, habitat and life-history stage). Sampling units (e.g. quadrats, cores, biotopes and microhabitats) from which individuals are sampled, are distributed among those groups. Within each group, however, the individuals are sampled randomly with no restrictions. The purpose of restricting the selection process is to maximize the information obtained while minimizing the cost. Such a procedure is also more likely to capture most of the variations in the sampled area. Usher (1991) and Owen and Rosentreter (1993) provide details on how to design random or stratified random sampling monitoring programmes and also how to avoid the problems of autocorrelation.

Before any new inventory or monitoring programme starts, especially where comparative spatial and temporal data are to be analysed, it is essential to consult some well-tried texts. Possibilities include Elliott (1977); Krebs (1989); Ludwig and Reynolds (1988); Magurran (1988); Soberón and Llorente (1993); Päävinen *et al.* (1994) or Cochran (1977); Lund and Thomas (1989); Schreuder *et al.* (1993) depending on the type of project. It is important, however, to bear in mind that biodiversity management and conservation are not simply about numbers of species and their relative proportions, but also about processes. Statistical analyses really only give numerical credibility to descriptive aspects of biodiversity conservation. Nevertheless, diversity measures and multivariate clustering techniques give a useful classificatory description of an otherwise incomprehensible welter of data. They are a starting point for quantifying biodiversity. It is important, therefore, also to assess qualitative biodiversity, that is the identity of species represented as points in, for example, a rank-abundance curve. Two localities may have equal species richness and evenness, yet one may be home to fairly widespread and eurytopic species, while the other may support many localized, genetically interesting, narrow endemics (Samways 1994; Holloway 1994).

After the initial descriptive data have been analysed, it is then necessary to redefine more precisely the conservation goals and the next steps to be used. For example, experimental verification may be needed (Ludwig and Reynolds, 1988), or aspects of the data then used for

selecting reserve areas (e.g. Spellerberg 1992; Usher 1986) or for initiating a management programme which would then be reassessed in the same or a different way at a later date to see how successful the management has been.

7.2.3.5 Use of existing data

Inventories of biodiversity may be able to make use of existing material (literature, databases, museum specimens) which often document the presence of a species in time and space and may decrease the area or extent of sampling required to document particular aspects of biodiversity. These records also provide a historical perspective, which has important conservation implications in knowing the rate and extent of species increase (especially exotic invasions; e.g. New 1994) or decline (e.g. Marshall and Haes 1988). For example, the decline of freshwater molluscs in Pennsylvania was demonstrable from specimens collected over many decades (NRC 1993). However, existing materials are generally insufficient for complete documentation of the biodiversity of an area or taxon because of the geographic or temporal unevenness of the samples, imprecision of the geographic information and/or incompleteness of information on abundance and habitat. Also, changes in scientific nomenclature and technical terms may occasionally distort the quality of the information generated from these sources. They do, however, permit the identification of gaps in the coverage to which future survey work may be best directed. Lund and Thomas (1995) provide guidance for evaluating existing information for databases.

7.2.4 Baseline data

Baseline data are fundamental units of basic inventory information that are crucial for biodiversity conservation planning and management. They usually include: (1) the presence and/or abundance of species or other units; (2) other dependent biotic data (e.g. plant cover for macroarthropods); (3) the appropriate influential abiotic variables, and (4) human variables. Biotic and abiotic data are the building blocks that make possible meaningful interpretations about spatial and temporal patterns in the distribution of biodiversity and the degree to which these are determined by natural and human-influenced environmental variation. When properly selected and carefully sampled and appropriately statistically analysed (see 7.2.3.4) the data can illustrate patterns of biodiversity.

As the goals and scales of inventorying and monitoring programmes may change with time, the baseline data collected should be sufficiently robust to accommodate such changes. Provided the data represent a robust sample of the system under study, baseline data can calibrate methods of Rapid Biodiversity Assessment (see 7.2.9.3) and, where samples are adequate, can also help evaluate the status of rare and threatened species and levels of

endemism (in Chapter 3.3). Although genetic data are the most discriminating elements of biodiversity, they are of limited use in rapid surveys.

Ideally, baseline data should be relevant across a wide range of environments and should be readily measurable in a repeatable way by different observers. Throughout ecosystems and landscapes, key data will include historical (evolutionary) elements together with those of the present day. In practical terms, the baseline data of most value are those that relate to changes in resources and respond to system perturbation or disturbance (Pimm 1991). Also it is valuable to know which species are resistant to or resilient against such perturbations. Thus, taxonomic and functional biotic data relate to abiotic data such as climate, weather, soil chemistry, pollutants and available nutrients.

7.2.4.1 Biotic data

7.2.4.1.1 Non-taxonomic baseline data. Baseline studies may use of recognizable taxonomic units (RTUs), which may or may not equate to named species but are visibly recognizable as entities. Such RTUs are useful for comparative, localized studies but have distinct disadvantages in biodiversity conservation (see 7.2.9.3, and the discussion by Beattie and Oliver 1994; also Stork 1995). Other rapid means of inventorying an area or biota include the use of functional attributes. Plant functional attributes (PFAs) are readily observable features of vegetation that are considered significant for growth, physiology and survival (for example pollination mechanisms, seed dispersal mechanisms, rooting systems). Certain minimum attribute sets of PFAs (Gillison 1981) can be used in specific combinations to describe individuals in a way that facilitates the detection of within-species variability. While PFAs are independent of species, they provide an additional ecological dimension to taxonomic richness. They represent variation but make no assumptions about 'guild' structures or life-history strategies, which for the most part are poorly known. Ratios of numbers of species to numbers of unique PFA assemblages or *modi* may indicate comparative levels of environmental adaptation across sets of species. While this is a relatively widely accepted and straightforward procedure for plants, it does not seem to be used for animal, fungal or microbial groups.

Other non-taxonomic baseline data include broad vegetation structure, for example mean canopy height, crown cover or projective foliage cover, basal area and visible strata or layers (Päivinen *et al.* 1994). These may be modified by so-called physiognomic attributes such as leaf size or tree buttressing. Often descriptive life forms are recorded, such as trees, shrubs or lianas. Alternatively, very specific life forms, classified according to the position of the perennating organ during the most unfavourable season,

may be used (Raunkiaer 1934; see Section 2.3). This approach may be extended to many finer categories (Mueller-Dombois and Ellenberg 1974) but these are rarely used in practice.

For vegetation, certain life-history categories may be recorded, such as seed dispersal, breeding systems and phenology (such as seasonal flushing of flowers and leaves, or other visible growth rhythms). For animals, non-taxonomic baseline data include feeding guilds and different life-history stages such as larval and adult forms as well as breeding systems. The degree to which these are necessary baseline data for inventory of biodiversity again depends on the scale and purpose.

The species (and sometimes the subspecies or other evolutionarily significant unit (ESU) (Moritz 1994; Vogler and DeSalle 1994)) is the usual currency for baseline studies. But while species richness and abundance can give a useful approximation of the taxonomic characteristics of biodiversity for localities and regions, they do not necessarily permit meaningful ecological comparisons to be made between continents or regions with different taxa. For such scales, higher-order taxonomic ranks (orders, families and genera) may be more appropriate. Even then, comparisons may be misleading, especially where certain genera contain many species and others are monospecific. For this reason, other taxonomically based measures may be used, such as 'taxic' diversity, a measure of taxonomic richness based on the proportion of species per genus (or family). These proportions, particularly when relating to endemic species, have great significance for identifying hotspots of endemism for conservation (Vane-Wright *et al.* 1991; Williams *et al.* 1991).

7.2.4.1.2 Other baseline biotic data. Monitoring at the population or species level may also be directed at variables of the biotope or landscape that are known or assumed to be important to the species of interest rather than at the population itself (Joubert 1983). Such factors can be monitored by a variety of techniques, including remote sensing of the cover types required by a species (Noss 1990). Once there are sufficient long-term data, species, biotopes and landscapes can be modelled so that any change detected in land condition can be used to predict the likely changes in the species. The monitoring of biotope and landscape variables, however, does not obviate the need to monitor populations, as the presence of suitable environmental conditions is no guarantee that the species of interest is present. Populations may vary considerably in density due to biotic factors, while landscape carrying capacity remains constant. Conversely, inferences based only on biotic variables such as population density can be misleading, as for example when concentrations of socially subordinate individuals occur in areas of marginal habitat (Noss 1990).

7.2.4.2 Abiotic data

Animals, plants, fungi and microorganisms are rarely distributed by chance alone. For the most part their distribution in time and space is governed by a set of key environmental factors. Typically these are elements of light (solar radiation), water and nutrients. The importance of these variables typically varies according to the geographical scale. For example, at the global level solar radiation has a major influence, but this decreases with scale to a point where, at a very local level, water and nutrients may dominate or interactions with other living things assume greater significance.

Typical baseline data for inventory purposes include climate variables, especially mean annual rainfall, rainfall seasonality (usually expressed as coefficient of variation or percentage of monthly rainfall), mean annual (screen) temperature (Williams 1987; Unwin and Corbet 1991), minimum temperature of the coldest month, and maximum and minimum temperature. Mist may also play a significant role, especially in upper mountainous regions or in certain desert or semi-arid conditions (Louw and Seely 1982). However, as yet there is no generally accepted method for recording mist interception.

The assessment and monitoring of a range of physical variables may be required for the effective conservation of biological diversity (e.g. Callow and Petts 1992). These factors can illustrate the proximate and ultimate causes behind changes in diversity and can help explain the behaviour of systems, especially when direct measures are difficult to come by.

7.2.4.3 Human-related data

Human population levels and human activities are the causes (and may also be the cure) of many adverse trends in biodiversity. Many human-related variables that both threaten and enhance biodiversity should be taken into consideration during a monitoring programme. Policy-makers are particularly interested in such monitoring programmes because they can identify practices which can be influenced through policy decisions. Human-related variables that may be monitored include:

- The status and trends in human population density (population density has a strong inverse correlation with biodiversity). For example, in the absence of complete and standardized forest inventory data, the United Nations Food and Agriculture Organization used human demographic information to estimate change in global tropical forest over the 1980s (FAO 1995).
- Types of human influence and changes that have influence in specific areas. For example: what are the major sources of pollution (e.g. cities, manufacturing

plants, farming) in the area of interest? What are the pollutants? Is the pollution changing, and, if so, in what way? What is its importance to local or regional biodiversity? What levels and types of pollution are acceptable for the benefit of industry, on the one hand, and natural communities, on the other?

- Extent and trends of infrastructure. For example: opening of new road networks to areas with previous limited human access; highways which create barriers to the dispersal of some plants and animals yet provide roadside habitats for others; dams which inhibit the migration of some animals yet provide new harvesting potential or habitats for others.
- Increasingly intensively managed and/or developed land. For example, trends in deforestation, draining of wetlands, irrigation of arid and semi-arid landscapes, conversion of grasslands to farming or managed pasture systems, conversion of wild forests to plantation systems. Also, improved situations, such as creation of farmland habitat islands for natural enemies of crop pests (Thomas *et al.* 1992), the decrease in spatial use of herbicides to increase biodiversity (Chiverton and Sotherton 1991), and the general use of conservation headlands (Dover 1991).
- Changes in agricultural practices. For example: deeper ploughing, use of fertilizers, pesticides and herbicides, eradication of hedgerows, revegetation of bunds. Yet other aspects may improve biodiversity, such as the planting of hedges, use of conservation headlands and islands in agricultural land and the conversion to traditional meadows of mixed plants in some temperate areas.
- Harvesting pressure exerted on wild resources. For example: overharvesting has caused several fisheries to collapse, yet others that have been sustainably harvested continue to thrive.
- Effectiveness of policies in meeting management goals (good policies and practices may be continued, poor ones discarded and the ineffective refined).
- Socio-political and economic data, such as information on institutional capacity and funding available for conservation, may also be useful in determining conservation needs and in measuring management performance.
- Effectiveness of sustainable utilization of wildlife resources (e.g. Munthali and Mughogho 1992).

7.2.5 Genetic inventorying and monitoring

Loss of genetic diversity is a critical problem, particularly with respect to domesticated organisms (see Sections 2.2 and 3.1) and the potential benefits from bioprospecting (Reid *et al.* 1993) (see Section 13). However, the potential scale for monitoring genetic diversity is vast. Indeed, Annex 1 of the UN Convention on Biological Diversity highlights the importance of the identification and monitoring of described genomes and genes of social, scientific or economic importance (Glowka *et al.* 1994). Reid *et al.* 1993 (Box 7.2-1) identify a number of critical indicators of genetic diversity and domesticated species diversity for management and policy decision-making.

Virtually all problems addressed by genetic surveys involve assaying for genetic variants (or 'markers') and investigating their qualitative and quantitative distribution among individuals within populations or species (Awise 1994). Genetic surveys begin with tissue samples. These may be adjunct to standard inventories and again it is important to have voucher specimens relating to all tissue samples collected. For those studies in which tissues such as blood are obtained from organisms that cannot be collected as vouchers, other means of verifying identity are needed such as photographs, measurements, descriptions or records contained in a zoological botanical institution. An important rider, however, is that it is essential that the museum specimen is biochemically amenable to genetic analysis. For example, selected soft invertebrates should be preserved in 90% ethyl alcohol rather than in formalin.

Many methodologies are now available for assessing genetic variation, and these are discussed in detail in Section 2.2.

7.2.6 Population inventorying and monitoring – some general considerations

7.2.6.1 Population inventorying and monitoring

The general term 'population surveying' has been used, in two ways: (1) in terms of the intrinsic rate of increase, population size at equilibrium and abundance of individuals of different ages and sex at any particular time or place (inventorying); and (2) with reference to the changes over time and space (i.e. dynamics) which includes natality, mortality, immigration, emigration and changes in gene frequencies (monitoring).

The assessment of temporal and spatial differences in these parameters, as well as the biotic or abiotic causes of such differences, can lead to a better understanding of the population dynamics of a species. Thus, population surveys that provide an estimate of demographic parameters may be more informative than those focusing on population size, because they provide insight into the dynamics of the population and allow for the formulation of predictive models.

Both population inventorying and monitoring can be carried out for a limited time over a limited area, or may be applied to many sites, several times, or over a long period. Each monitoring programme, or combination of programmes, will serve different purposes and require a different effort, degree of scientific expertise, time and cost. The techniques applied in a population study will depend on the biological features of the population, the available resources and time, and the questions being asked. The manner in which the basic data are obtained is highly taxon-specific (e.g. for birds see Koskimies and Visnen (1986), Bibby *et al.* (1992); for amphibians see Heyer *et al.* (1994); for plants see Kershaw (1973), Greig-Smith (1983)).

7.2.6.2 Population size and density

It is seldom possible to census an entire population (i.e. to count all individuals directly) and it is often cheaper and preferable to estimate population size from sample data. The density of individuals is estimated over a manageable area and the results extrapolated to a larger area. However, it should be remembered that the dynamics of densities may give misleading impressions of the dynamics of population sizes (Gaston and McArdle 1993). Estimates of population size and density can be either absolute or relative.

Relative estimates provide information on population size or density relative to the unit of sampling effort. Examples include sightings per kilometre walked, counts per day in the field, or individuals per cubic metre of water sampled. Many standard sampling and analytical techniques exist which can be implemented cheaply by well-trained non-professionals (Southwood 1978; Krebs 1989). Such methods are particularly good for surveying or monitoring conspicuous or well-known groups such as birds and butterflies, but it should be noted that relative measures are valuable only in a comparative sense, that is, in comparisons between populations, time periods or species.

Absolute methods are intended to estimate the true number of individuals of a population in a given area of interest at a given time and are often presented as density estimates. Absolute methods provide numbers that are useful in themselves or in comparisons. For plants or sessile animals (if individuals can be distinguished) it is possible in principle to census or to obtain good estimates of density or abundance by straightforward techniques in which one simply marks or records the presence of individuals using a random or stratified sampling design (Kershaw 1973; Greig-Smith 1983). In mobile species, absolute estimates of density often require more sophisticated techniques such as mark-recapture (see 7.2.7.1; Seber 1973; Southwood 1978; Begon 1979; Krebs 1989). Most absolute methods are labour-intensive; for example, recapture of up to 80% or more of the marked organisms may be required to lower standard errors to

acceptable levels. Such methods also require that the investigator be trained in the handling and marking of animals and in the use of the mathematical and statistical techniques associated with the methods.

Another method for estimating density and abundance of populations is 'distance sampling' in the form of line transect, point transect and cue-count data (see Buckland *et al.* 1993; and 7.2.7.4).

7.2.6.3 Population structure and demographic variables

Population size or density is a manifestation of the demographic processes occurring in the population, that is, immigration and births which increase population size and emigration and deaths which decrease it. Data on such demographic parameters thus complement information on population size. Demographic data are most useful if categorized by age, size, sex, genotype, reproductive status, or other relevant variables (Caswell 1989). The assignment of an individual to a category (e.g. genotypes or sex) sometimes involves the use of special techniques. One example of the techniques now available to decipher dynamic demographic parameters among wild populations is skeletochronology, which includes measures of growth rates, age at sexual maturity, cyclicity of growth, etc. (Balinière *et al.* 1992).

Estimates of group-specific fecundity and mortality are fundamental to the understanding and management of populations. Most models of population management include birth rates and death rates (often with variance estimates), as well as population equilibrium values as variables. Immigration and emigration are equivalent to fecundity and mortality when considering the dynamics of a single population. When several populations are being studied, those parameters must be considered separately because of their significance for population viability, metapopulation structure and the potential for inbreeding effects and genetic drift (Caughley 1994) (see Section 4).

7.2.6.4 Population equilibrium

When per capita birth and death rates change with population density, at least within a certain range of density values, population size may reach equilibrium. That is, at some densities, birth and death rates are roughly the same and population size, usually expressed as a density, does not change. The population equilibrium is not a demographic trait in itself, but rather an expression of how the demographic parameters (per capita birth and death rates) respond to factors such as varying resource availability, predator pressure and environmental deterioration.

A measure of population equilibrium is an important tool when managing populations for conservation or for economic purposes (particularly when individuals are introduced to or removed from a region). This state is sometimes equated to the habitat carrying capacity for the

species. It is difficult to determine equilibrium levels from measures of demographic parameters, because estimates of growth rates from several sites or times are required before systematic and significant decrements with density can be detected. Consequently, population equilibrium levels are often estimated empirically as the average population size over a long period.

7.2.6.5 Population analysis

There is a general theoretical framework for the analysis of population status and dynamics and thus analytical tools are fairly standard for many kinds of organisms, provided that data on population size, frequencies of individuals in different categories (e.g. age, size, genotype, sex), as well as category-specific fecundity, mortality and immigration rates, are available. Linear models of population attributes are the most popular analytical tools, but non-linear models tend to be more realistic in the context of population harvesting and management for conservation (Soulé 1987; Getz and Haight 1989; Royama 1992).

To understand population patterns in space and time, estimates of population size and demographic parameters from several sites, or from a single site at different times, can be compared. Studies of population trends require only population size estimates, although sometimes the grouping of data (e.g. into juvenile or reproductive, male or female, etc.) is useful. Providing enough estimates of population size are obtained, population trends can be assessed either descriptively, by plotting the data over time, or formally, using time-series statistical techniques (Royama 1992). A reliable and standardized protocol for estimating population size should be adopted before a survey is initiated (see Pollard and Yates 1993) because modification of a technique over the course of a survey (even if it improves the procedure) makes comparison of the data obtained virtually impossible.

Studies that examine some aspect of population dynamics or provide a basis for the management of a population should measure population parameters several times. If life-table data taken at different times are available, a matrix modelling approach can be used as an analytical tool, either by itself or as part of simulation analyses that take into account environmental stochasticity or different perturbation regimes (Groenendaal *et al.* 1988). Repeated estimation of demographic parameters also allows for the estimation of variances, which are of great theoretical importance (Goodman 1987). However, the field is complex and still in need of a more rigorous mathematical approach.

Two approaches to the study of populations were introduced in Chapter 7.1: the Minimum Viable Population (MVP) and the Population Viability Analysis (PVA). The MVP considers the genetics and dynamics of small populations, with particular attention to the implications of

limited gene pools and demographic stochasticity, for the survival of the species (Soulé 1987; Section 4.2). Determination of the MVP includes factors that are extrinsic to the species such as environmental uncertainty (variability) and natural catastrophes, as well as intrinsic factors such as demographic and genetic uncertainty (Mace and Lande 1991). In large, natural populations environmental uncertainty and natural catastrophes appear to be the most critical factors, whereas in small, natural populations all four factors may be important (Soulé and Kohm 1989).

PVA was developed to consider the complex interaction of factors influencing extinction. It uses population data and growth models (including MVP) to estimate the probability that a population will persist for some designated period (see Section 4.2). PVAs should consider ecological data such as density dependence, spatial structure, low density thresholds, species interactions and mechanisms of ecosystem interactions and should incorporate forecasting methods (Boyce 1992). For example, an environmental perturbation may reduce the population size and induce both detrimental demographic and genetic changes, which in turn can reduce the number of patches occupied by the population. These connections are often hard to evaluate explicitly or to predict. However, a number of models for population persistence have been developed, which seek to integrate these various factors (Mace and Lande 1991; Mace and Stuart 1994). VORTEX (Lacy and Kreeger 1992) is one such model which has been used successfully by the Species Survival Commission's Captive Breeding Specialist Group.

Soulé and Kohm (1989) suggest that an increase in the sophistication of PVA will depend on progress in four major areas relating to the study of population dynamics and persistence:

- the development of an integrated model of population persistence that simultaneously tracks the effects of variation in demographic parameters and in the frequency and amplitude of environmental, catastrophic and genetic variation;
- the expansion of such a model to incorporate geographical structure (i.e. a metapopulation model);
- the examination of the relationship between levels of environmental variability and their impact on the variability of key demographic parameters for a variety of representative species, and
- the examination of the geographical patterns of environmental variability itself.

Target species for MVP analysis or PVA are generally those at immediate risk of extinction, although other

species, including some that are not in danger, could be useful for experimental research and analysis, based on other criteria. Work on such species expands the empirical basis of conservation-orientated population surveys (Boyce 1992). However, it should be remembered that all MVP analyses are based on some model of the population in question and that all models contain some unrealistic assumptions. The researcher must determine the degree to which model assumptions are met in a particular case and devise an improved model where necessary. Mechanical application of published models to other cases is likely to generate faulty conclusions.

With PVA it is important also to be able to model 'catastrophes' and/or model towards a pre-determined range of outcomes and to get a better indication of those factors which are especially sensitive to change, i.e. those factors in which a small change will have a gross effect on the outcomes.

7.2.7 Fauna population inventorying and monitoring – some methods

7.2.7.1 Mark-recapture

This technique is occasionally used for various animals, and is based on capturing a large proportion of the population, marking them, releasing them and recapturing them. This gives only a rough estimate of population size as it requires so many practical, logistical and statistical assumptions (Begon 1979). Nevertheless, the technique has provided some valuable information on populations of butterflies (Pollard and Yates 1993) and birds (Elliot *et al.* 1976; Piper and Schultz 1989). Other mark-recapture techniques such as bird ringing have been extremely useful, principally for establishing migratory routes, but also for monitoring changes in population levels. The Ringing Scheme of the British Trust for Ornithology ringed over 19 million birds between 1909 and 1987, with 400 000 recoveries (Baillie 1991).

7.2.7.2 Radio tracking

A variation on the mark-recapture technique involves the capture of individuals which are then fitted with a small radio transmitter (e.g. on a collar or harness) to allow the species to be radio-tracked. This technique has been used to monitor the movements of large mammal species such as leopard (Smith 1977; Bothma and le Riche 1984) and elephant (Norton and Lawson 1985; Norton and Henley 1987; De Villiers *et al.* 1991) and on some large bird species, particularly threatened raptors such as the Cape Vulture and California Condor (Boshoff *et al.* 1984; Wallace 1993).

7.2.7.3 Remote sensing of populations

Fixed point or ground-based photography is one of the simplest forms of remote sensing (for a full description see

7.4.3.1). Repeated photographs taken from the same point over time allow a species to be monitored in a non-destructive manner. Measurements can be made, for example, of changes in the biomass of a plant species or of the activities at a bird nest or animal den. Shantz and Turner (1958) used repeat ground photography to describe vegetation change in Africa (see also Hoffman 1993).

Aerial photography from kites, balloons and aircraft provides images at relatively low cost with high spatial resolution, high geometric accuracy and good stereo images (Budd 1991). Multi-temporal photographs have, for example, been used very successfully to monitor changes in the density of large woody invasive plant species on the Langeberg mountain range in South Africa (Thompson 1993).

Elephant populations can be monitored by means of low-level aerial photographs (Gwynne and Croze 1980) which, when repeated at regular intervals, can determine the age structure of the population being monitored. This may, in turn, be used to determine the biomass density and health of the population, and as a basis for making deductions about recruitment and population growth. This method is, however, dependent on growth-form curves which have to be obtained from post-mortem studies (Gwynne and Croze 1980).

Yonzon *et al.* (1991) studied the red panda habitat in Nepal. They digitized and overlaid information from maps of land cover, land use, elevation and aspect favourability to give a core habitat map. Then core areas at risk were identified by overlaying a map of land cover and use within 500 m of core habitats. The technique showed that 60% of the core habitat was at risk from human pressure such as grazing and firewood collection.

Inventorying and monitoring vegetation cover is the most practical way of tracking biodiversity at regional and global levels. In the absence of complete geo-referenced species data, we continue to rely on assumptions based on known habitat requirements, historical occurrence data and the current distribution of vegetation types. For example, the 1990 *Countryside Survey of Great Britain* (Barr *et al.* 1993) maps vegetation cover and land use, providing information that can be used to assess change from previous surveys and a baseline from which to monitor future change. Although aerial photography and other remote sensing techniques have been used to survey extensive areas and stratification, the ground survey still provides the most useful data.

7.2.7.4 Territory mapping, point counts and transects

Territory, or spot mapping is useful for estimating the numbers of pairs of birds or animals present in an area during the breeding season without having to capture the species (see Baillie 1991). An excellent example of the use of this technique is the British Common Birds Census which was started in 1962. This census, which is conducted

by volunteers, provides annual indices of the population levels of terrestrial breeding birds in the United Kingdom (Baillie 1991). This monitoring project is also linked to the Nest Record Scheme which has monitored annual changes in bird breeding performance since 1939 (Baillie 1991).

Point counts and transects provide very similar types of information and do not require the capture of individuals. For point counts, individuals of species are counted from fixed points during a specified time interval, whereas for transects observers are required to walk along a particular route recording all the individuals of species on either side of the line walked. Several transect methods have been developed including unlimited distance transects, strip transects, fixed-distance line transects and variable-distance line transects (Baillie 1991). A number of assumptions are built into these techniques (e.g. that all birds on the transect line are detected and that the species does not move away or hide in response to the observer). However, despite these limitations they still provide very useful monitoring data as is shown by various projects to count birds (Järvinen and Väisänen 1975) and butterflies (Pollard 1991; Pollard and Yates 1993).

Since its inception in 1976, the Butterfly Monitoring Scheme has provided information on the changes in numbers of butterflies at well over 100 sites in Britain (Pollard 1991; Pollard and Yates 1993). The information obtained includes the patterns of population fluctuations, the length and timing of flight periods, local distributions and migratory movements. These data have been used by conservation agencies to monitor populations of rare and threatened butterflies and, in some cases, to assess the effectiveness of management measures implemented for their conservation. An unexpected bonus of the monitoring project has been an increased interest in butterflies and their requirements, both by the individuals who monitor them and by conservation organizations. Thus, the very process of monitoring may have contributed to butterfly conservation (Pollard and Yates 1993).

7.2.8 Perspectives and approaches to single-species inventorying and monitoring

When May (1990) wrote, 'without taxonomy to give shape to the bricks, and systematics to tell us how to put them together, the house of biological science is a meaningless jumble', he was making an unequivocal declaration that the identity of species and their relationships is a key to understanding the world around us. That understanding of species then provides a sound basis for biodiversity conservation and management. Species are the unmistakable bricks of biodiversity and yet they have various perspectives that are not easily categorized into a unitary scheme. What follows are some perspectives on species groupings pertinent to biodiversity conservation, utilization and management.

7.2.8.1 High-impact species

Some species have more influence on ecosystems than others. Their impact and abundance may change over time, with other species replacing them in their influential position. Two groups are particularly relevant to biodiversity conservation; keystone species and exotic invasives.

7.2.8.1.1 Keystone species. These play a pivotal role in ecosystems (see Powers and Scott Mills 1995; Box 5.2-1), yet very few have actually been demonstrated in undisturbed ecosystems (but see Paine 1969). Nevertheless, species of palm and fig trees, for example (of about 2000 species in the flora), maintain almost all the vertebrate frugivores in a Peruvian rain forest for three months of the year when other tree species are not in fruit (Soulé and Kohm 1989).

One of the aims of inventorying and monitoring is to identify and assess the dynamic impact of keystone species as ecosystems are altered directly or indirectly by humans. Keystone species need not be harmful but may also be beneficial in modified ecosystems, but this is a field almost devoid of research and is one that needs addressing.

7.2.8.1.2 Exotic invasives. These are newly-appearing species either in natural or human-influenced ecosystems. They may be almost any type of organism which becomes, for example, a new pathogen, vector, weed or invasive animal. Several texts have been devoted to this topic (e.g. Groves and Burdon 1986; Drake *et al.* 1989; Macdonald *et al.* 1989; New 1994; see also Section 11.2).

Monitoring the spread and impact of these invasives is a crucial component of biodiversity conservation. It is estimated, for example, that 900 plant species in the Cape Floristic Kingdom are threatened with extinction, partly as a result of alien tree invasions (Richardson *et al.* 1992). An estimated 1000 additional myrmecochorous plant species in the same region could be threatened if the already established alien ant *Iridomyrex humilis*, which does not bury plant seeds, continues to replace native seed-dispersing ant species (Macdonald 1992). Despite considerable research on invasive biota (see Groves and Burdon 1986; Macdonald *et al.* 1986; Drake *et al.* 1989; di Castri *et al.* 1990), too few studies of successful invaders and related unsuccessful ones have been compared for cogent generalizations to be made about the determinants and effects of success (Soulé and Kohm 1989).

Predictive climatic mapping is proving valuable for predetermining to where a new invasive might spread. Tribe and Richardson (1994) for example (see Figure 7.2-1), used the ecoclimatic program CLIMEX, to determine the possible range expansion of the invasive European wasp, *Vespa germanica*, into South Africa. CLIMEX also proved useful for predicting the spread of various other invertebrate pests (Sutherst *et al.* 1995).

Potentially all ecosystems can suffer the ravages of exotic invasives. The Tasman Sea, for example, is seeing

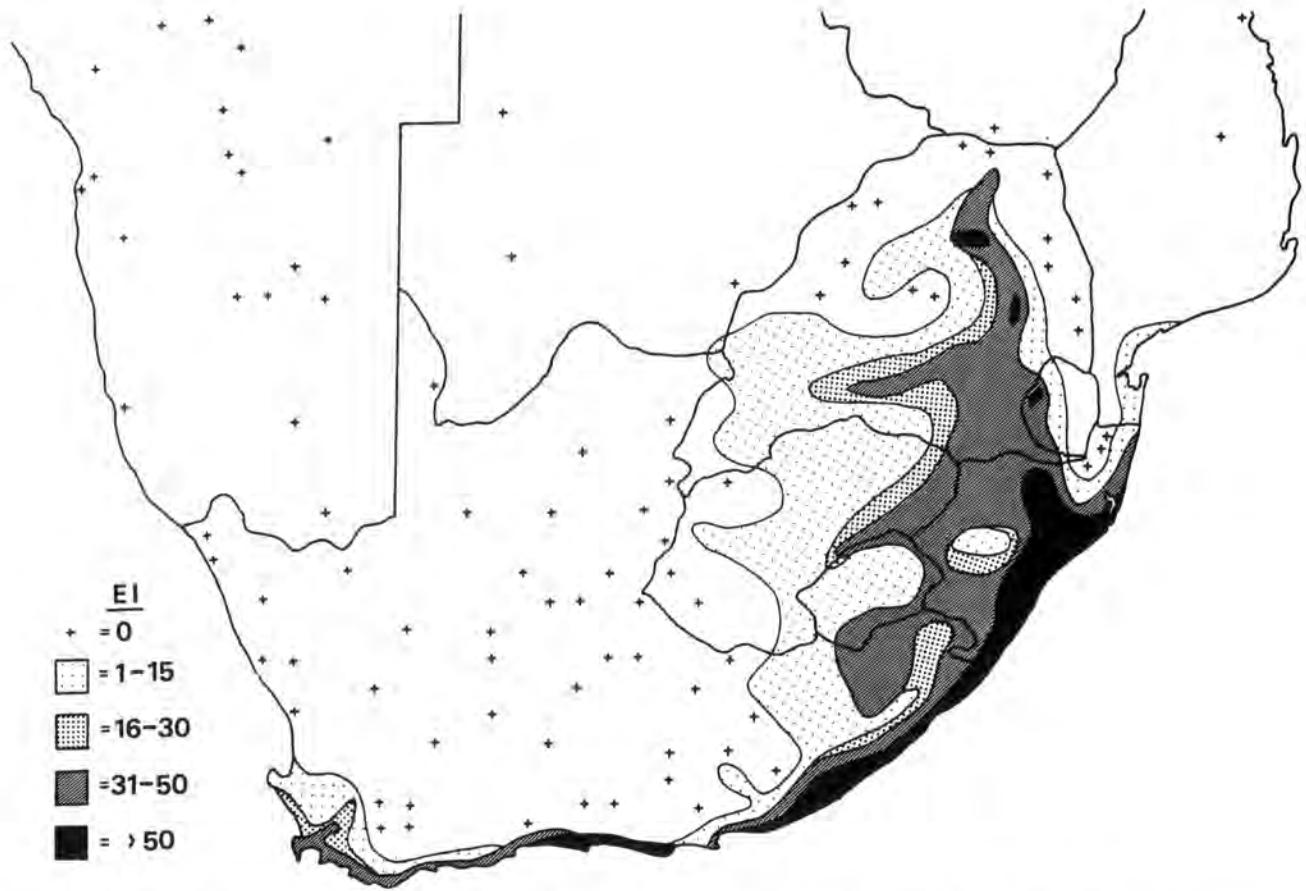

Figure 7.2-1: The relative suitability of different parts of southern Africa for *Vespa germanica*. Suitability was assessed by ecoclimatic matching. Crosses indicate localities that are unsuitable for *V. germanica* (Ecoclimatic Index = 0). Increasing suitability is indicated by progressively darker shading. (From: Tribe and Richardson 1994.)

an invasion of the sea-star *Asterias amurensis* (Buttermore *et al.* 1994). Often these invasives can be tramp species circumnavigating the globe. *I. humilis* (from southern South America) and *V. germanica* (from Europe), for example, have not only invaded South Africa but also Australia and New Zealand (New 1994).

7.2.8.2 Indicator species

Certain species flag changes in biotic or abiotic conditions. It is important to inventory these sensitive species because *they themselves* can become the important *monitors*. Which ones are selected depends on the monitoring question being posed. Indicator species reflect the quality and changes in environmental conditions as well as aspects of community composition (details in Soulé and Kohm 1989; Noss 1990; Hawksworth and Richie 1993; Kremen *et al.* 1993; Samways 1994). Species of amphibians, molluscs, birds, chironomid flies, fungi, corals and other marine invertebrates may all be useful indicators. Changes in distributions, abundances and demographic characteristics (e.g. population sex and age structure) of such species may indicate impending adverse changes in an ecosystem as a whole. However, indicator species are often chosen for monitoring simply because they represent

a particular use, ecosystem or management concern (Soulé and Kohm 1989) or are easily sampled, sorted and identified. The need to identify indicators that are appropriate for the task in hand is important and urgent. Also, the species chosen should provide standards of consistency and precision about changes in a community. They must also be reliable enough that changes and trends are unambiguously detected (National Research Council 1993).

Useful attributes of indicator species that are applicable to a wide range of organisms in a variety of ecosystems include (modified from Brown 1991):

- high taxonomic and ecological diversity (many species in each locale or system);
- close association with and identification of the conditions and responses of other species;
- high ecological fidelity;
- relatively high abundance and damped fluctuations (i.e. they are always present and are easy to locate in the field);

- narrow endemism or, if widespread, well differentiated (either locally or regionally);
- well known taxonomy and easy identification;
- good background information (e.g. on genetics, behaviour, biochemistry, ecology, biogeography);
- large random samples encompassing all species variation are possible;
- functional importance within the ecosystem is understood;
- predictable, rapid, sensitive, analysable and linear response to disturbance. Some populations of indicator species, however, may behave spontaneously as a response to an environmental change, for example spiders, locusts and tsetse flies in Africa (e.g. Rogers 1995).
- How many indicator species must be monitored to assess the health of a protected area?
- Which species serve as major mobile links between subsets of species within a community and or between communities? Do non-obvious but important linking species exist?
- Which characteristics of ecosystems are best monitored with indicator species?
- How do keystone and indicator species respond to natural environmental variability and fragmentation and to human-generated environmental variability and fragmentation?
- Can we, in harvested systems, maintain species that depend on the keystone species to provide structural components (e.g. large logs on the forest floor, large standing trees)?

The indicator-species approach has been criticized for its questionable assumptions, methodological deficiencies and sometimes biased application (Landres *et al.* 1988; Noss 1990), but nevertheless it still has great value for monitoring certain changes that take place relative to the specific biodiversity question being asked.

Various authors have discussed the use of indicators to monitor the effects of anthropogenic pollutants on the environment (e.g. Bianchi and Colwell 1986; Kozuharov 1986; Salanki 1986). Pollutants upon entering an environment influence an ecosystem through their effects on various types of organisms, from microbes to higher plants and animals. Generally, pollutants retard growth and reproduction and shorten the life-span of individuals. They also affect the age structure, sex proportions and size of the whole population. Some species decrease in numbers and eventually disappear, while others may become more abundant and expand their ranges. Both responses lead to changes in the structure of the community, which are usually easy to detect and provide valuable signals (National Research Council 1993).

Critical questions regarding the roles and uses of both keystone and indicator species in biodiversity monitoring include (adapted from Soulé and Kohm 1989):

- What are the characteristics of keystone and indicator species?
- What protocols should be used to identify keystone and indicator species for known ecosystems? Can such species be designated objectively?
- How many keystone species occur in different kinds of communities or ecosystems?
- *Sentinels*: sensitive species introduced into atypical conditions as early-warning devices (canaries in coal mines).
- *Detectors*: species occurring naturally in the area of interest which may show measurable responses to environmental change (e.g. changes in age-class, decrease in population size, changes in behaviour). Heathlands are indicators of nutrient-poor acid soils and some vascular plant species may be used as indicators of woodland type.
- *Exploiters*: species whose presence indicates the probability of disturbance or pollution (for example in aquatic habitats, the presence of many tubificid worms and/or red chironomid larvae indicates polluted conditions).
- *Accumulators*: species which accumulate (bioaccumulation) chemicals in their tissues (lichens, woodlice).

Biodiversity indicators are useful for defining and presenting the data that decision-makers require. A minimum set of biodiversity indicators relevant for decision-makers operating at local to global scales is given in Box 7.2-2.

Biological indicators can be used in ecological evaluations, especially for communities indicating areas of conservation interest (Spellerberg 1992). Indicator species are also used in environmental assessments and in the preparation of environmental sensitivity maps. The different kinds of biological indicators can be grouped under the following headings (Spellerberg 1992):

Box 7.2-2: Biodiversity indicators for management and policy decision-making (from: Reid *et al.* 1993).**Wild species* and genetic diversity**

- Species richness (number, number per unit area or volume, number per habitat type).
- Species threatened with extinction (number or percentage).
- Species threatened with extirpation (number or percentage).
- Narrowly endemic species (number or percentage).
- Narrowly endemic species threatened with extinction (number or percentage).
- Species risk index.
- Species with stable or increasing populations (number or percentage).
- Species with decreasing populations (number or percentage).
- Threatened species in protected areas (number or percentage).
- Endemic species in protected areas (number or percentage).
- Threatened species in ex situ collections (number or percentage).
- Threatened species with viable ex situ populations (number or percentage).
- Species used by local residents (number or percentage).
- The number of species already lost/extinct from the area.

Community diversity

- Percentage of area dominated by wild species.
- Rate of change from dominance of wild species to domesticated species.
- Percentage of area dominated by wild species occurring in patches greater than 1000 km².
- Percentage of area in strictly protected status.

Domesticated species-diversity

- Accessions of crops and livestock in ex situ storage (number or percentage).
- Accessions of crops regenerated in the past decade (percentage).
- Crops (livestock) grown as a percentage of number 30 years before.
- Varieties of crops/livestock grown as a percentage of number 30 years before.
- Coefficient of kinship or parentage of crops.

- *Bioassay organisms*: selected organisms sometimes used as laboratory reagents to detect the presence and/or concentration of pollutants (some species of trout make suitable bioassay organisms).

Lichens are particularly useful and well documented as bioindicators for a range of environmental pollutants and ecological changes, as listed in Box 7.2-3.

Williams (1993) using terrestrial arthropods, evaluated the effectiveness of restoration of riparian woodlands, and provides an example of monitoring improving conditions (see Figure 7.2-2).

7.2.8.3 Conservation-focus species

As biodiversity conservation is a pragmatic science with a management component, it is important to note those

species that flag conservation efforts. In rough terms, and not exhaustive ones, there are two general categories: umbrella and flagship species, and threatened species.

7.2.8.3.1 Umbrella and flagship species. *Umbrella species* are those whose occupancy area (plants) or home range (animals) are large enough and whose habitat requirements are wide enough that, if they are given a sufficiently large area for their protection, will bring other species under that protection. Many of the world's nature or game reserves were created principally for large mammals or birds and have inadvertently become reserves for other species with smaller ranges, particularly invertebrates (Owen-Smith 1983). Nevertheless, these umbrella species can not be used as an exclusive 'catch-all' for all other species (Prendergast *et al.* 1993). It is important also to note that umbrella species such as

Box 7.2-3: Lichens as bioindicators.

Environmental pollutants

- *Acid rain* (Farmer *et al.* 1992; Gauslaa 1995)
- *Ammonium eutrophication* (de Bakker 1989; Brown 1992)
- *Chlorinated hydrocarbons* (Villeneuve *et al.* 1988)
- *Heavy metal contamination* (Garthy 1993; Lawrey 1993; Gordon *et al.* 1995; Glenn *et al.* 1995)
- *Oil spills* (Brown 1972, 1973)
- *Sulphur dioxide air pollution* (Bisset and Farmer 1994; Hawksworth and MacManus 1989; Hawksworth and Rose 1970)
- *Radionuclides* (Ackay and Kesercioglu 1990; Baeza *et al.* 1994; Benson *et al.* 1983; Biazrov 1994; Rissanen 1992; Steinnes and Njastad 1993)

Climate Change

- *UV radiation* (Fahselt 1993; Galloway 1993; Quilot *et al.* 1994; Wynn-Williams 1994)
- *Water levels* (Gregory 1976; Hale 1984; Wessels and Büdel 1989)

Ecological continuity

- *Deciduous woodland* (Rose 1976, 1992; Etayo-Salazar and Gómez-Bolea 1992)
- *Coniferous forest* (Tibell 1992)
- *Fire* (Eldridge and Bradstock 1994; Wetmore 1983; Wolseley and Aguirre-Hudson 1991; Wolseley *et al.* 1995)
- *Stability of surfaces* (Lawrey 1991; Adamo *et al.* 1993; Sonesson *et al.* 1994)

Further Reading: Henderson (1995); Nash and Wirth (1988); Richardson (1992)

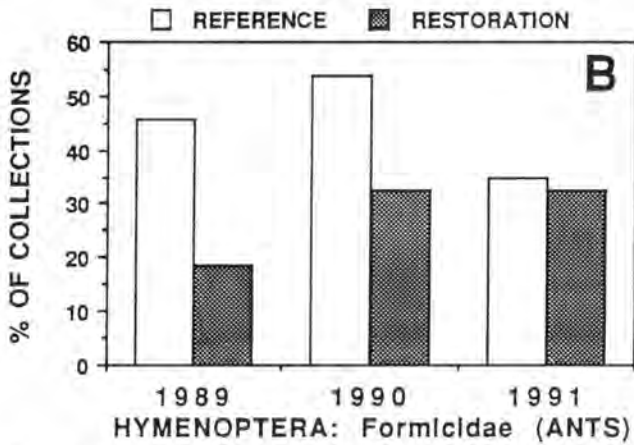

Figure 7.2-2: Over time a restored riparian woodland became more similar to a naturally-occurring riparian reference site in terms of ants in the samples (collections) studied. This illustrates the important role of monitoring improving environmental conditions. (From: Williams 1993.)

cougars, grizzly bears, large cats and pachyderms have already been removed from large areas of their former habitats and may therefore be inappropriate for protecting other species.

Some habitat types may also act as umbrellas and these can be wider than those provided by large vertebrates. In South Africa, for example, the extraordinarily rich plant species in the Cape (The Cape Floral Kingdom) serve as an umbrella for many specialist invertebrates. The relationship between the plants and the invertebrates, however, is not straightforward and highlights the risk of using umbrellas at face value where specialist management may be required (Wright 1993).

Flagship species are popular, charismatic species that serve as symbols and rallying points to stimulate conservation awareness and action. At the larger scale these include animals such as condors, pandas, rhinos, large cats and large primates, while at the smaller scale they include orchids, cacti and invertebrates such as large butterflies and stick insects (Yen 1993). Flagship species may serve as both indicators and/or umbrella species and also provide a highly visible reminder of the progress of a particular conservation management plan.

7.2.8.3.2 Threatened species. Threatened species are species that are rare, often genetically impoverished, of low fecundity, dependent on patchy or unpredictable resources, extremely variable in population density, persecuted, or otherwise prone to extinction in human-dominated landscapes (Terborgh and Winter 1980; Davis *et al.* 1986; Pimm *et al.* 1988; Noss 1990; WCMC 1992; Smith *et al.* 1993). As the number of threatened species increases world-wide, the identification and monitoring of these species has become critical for their conservation. The inherent rarity and ecological characteristics of these species can make them difficult to monitor. There is a vast

literature dealing with this subject and many publications provide case studies and discuss ways to plan and execute monitoring programmes (see Soulé and Wilcox 1980; Morse and Henfin 1981; Synge 1981; Soulé 1986; Palmer 1987; Kesseli 1992; Owen and Rosentreter 1993; Cropper 1993; Given 1994).

The IUCN Red List represents species that are recognized as globally threatened with extinction. The threatened species categories used in the Red List provide the most widely used system for describing the threatened status of species. The current categories have been in place now for nearly 30 years and highlight species under higher extinction risk. These categories have been used increasingly to set priorities for conservation and this change in emphasis has prompted a revision of the category definitions over the past six years (Mace and Stuart 1994). The new *IUCN Red List Categories* (IUCN 1994) require specific approaches to assessing the threatened status of species. They aim to provide an explicit, objective framework that can be applied consistently and widely to classify species according to their extinction risk, to facilitate comparisons across different taxa, to provide a clearer understanding of how species were classified, and to be useful in planning conservation actions. For further discussion of these see Section 13.4.3, especially Box 13.4-2.

The three categories, Critically Endangered, Endangered and Vulnerable are defined on the basis of quantitative criteria that can be applied to any taxonomic unit at or below the species level (Mace and Stuart 1994; IUCN 1994). Meeting any one of the criteria qualifies a taxon for listing at that level of threat. In the absence of high quality data, species may be assigned to categories on the basis of estimates, inference or projection, providing this can be reasonably supported (Mace and Stuart 1994). The categories provide an assessment of the likelihood of extinction under current circumstances. Extinction is seen as a probabilistic or chance process and this listing in higher risk categories implies a higher expectation of extinction. It should be noted that the status of a taxon will depend also on the scale at which it is assessed, whether globally, regionally, or nationally (Mace and Stuart 1994; IUCN 1994). The criteria are most appropriate when applied at the global level and the categorization of a taxon may be different when they are applied at the regional or national level. IUCN is currently drawing up guidelines for the use of national Red List categories (IUCN 1994).

Although the classification of threatened species may be important for identifying areas for protection, there are several disadvantages to using national statistics for monitoring. Most importantly, national statistics respond slowly to changes in the threatened status of species. Furthermore, the signs of national dynamics in threatened species can be ambiguous. For example, if the total number

of threatened species decreases this may indicate either an improvement or a deterioration species may be no longer threatened or they may be extinct!

Similarly, a country with many threatened species may or may not be managing its resources efficiently; is it doing a bad job in protecting its biodiversity because many of its species are threatened or is it doing a good job because it is the last stronghold of so many threatened species?

Threatened species may be inherently rare, that is, they have a low abundance and/or a small range (Gaston 1994), but this does not mean that rare species are necessarily threatened. Species that are naturally rare may be adapted to exploiting a changing environment.

Endemic species are those with restricted distributions (see section 3.3). An endemic species is not necessarily rare or restricted to a small range (Gaston 1994). This is dependent on the area over which endemism is measured. Although plant endemics have been recognized and investigated extensively, less attention has been given to endemic animal taxa (but see Cracraft 1991). Endemic species are, however, increasingly recognized as being an important focus for conservation attention as the threats to narrow-ranged species become more apparent. Furthermore, endemic species are the major components of hot-spots of diversity, and form the basis for selecting priority conservation areas (e.g. Vane-Wright *et al.* 1991; Pearson and Cassola 1992). See section 3.3 for further details on endemic species.

There tends to be a natural bias toward monitoring species already threatened, as emphasized by the large number of *Red Data Books* (RDBs) and the 'Red Lists' (see 7.3.5.5). This approach is neglectful of the many species that are currently common enough not to feature in the 'red books'. Thus there is an essential need to monitor healthy ecosystems so as to keep a check on community structure, especially in view of gradual global changes which may precipitate an unexpected plunge in species richness and abundance. Nevertheless, 'red books' have an important role and the rate of new entries provides an important warning signal.

In their most simple form, *Red Data Books* (Lucas and Syngé 1978; IUCN 1990) are simply lists of the elements of our biodiversity that are known to be rare, threatened or declining. They indicate existing or potential losses of species and populations and where appropriate propose remedial conservation action (Ferrar 1989). They also serve an important monitoring function by setting out to answer the general question, 'How are we doing in conserving species?' (Ferrar 1989). At continental and regional scales RDBs often provide the first approximation to the monitoring of biodiversity (Huntley 1988). These RDBs when repeated for a second time provide the first iteration of a monitoring cycle by setting out to compare the changed conservation status of a species after time. This is

often only partially successful as the detail of information in the original lists is often inadequate, and hence changes in the conservation status of a species are often due to the acquisition of more accurate information (Ferrar 1989). Despite this, the mere publication of an RDB leads to critical review and improvement. For example, the 1976 RDB on South African birds was cited in more than 150 papers within eight years of its publication (Huntley 1988).

It is important to distinguish between monitoring for species that are globally threatened, as listed in the WCMC databases, and national *Red Data Books*. As species change categories on the global List they are moving much closer to (or rarely and optimistically, away from) total extinction. *Red Data Books*, on the other hand, are national research and policy documents and often contain species that may be common elsewhere. For example, the field cricket, *Gryllus campestris*, is listed as 'Endangered' in Britain (Shirt 1987) but can be quite common locally in continental Europe.

7.2.8.4 Species with value to humans

A major first step in biodiversity conservation and sustainable utilization is the inventorying of species of direct human value. As this is the essence of biodiversity management in agriculture, horticulture, aquaculture, forestry, veterinary science and medicine, it is covered in considerable detail in Sections 11 and 13. Monitoring these natural species resources is crucial before they are lost forever. Sometimes recently-discovered individuals may be among the last of the species. For example, the bark of the rare tree *Homolanthus nutans*, from the Falealupo Rain Forest Reserve in the Solomon Islands, was recently found to have potentially important anti-viral properties, particularly against Yellow Fever virus.

7.2.8.5 Typical or representative species

One of the most neglected areas of biodiversity conservation is the preservation of once widespread and typical areas. For example, a few hundred years ago the prairie was an extensive and characteristic ecosystem, yet today it is reduced to just a few fragments.

All the above categories of species are 'special' in one way or another. However, biodiversity is about the variety of life in its entirety. In this respect, Usher (1986) makes a strong case for conserving 'typicalness' of species as well as landscapes. In other words, it is important not to forget 'all the other' typical or representative species in a community, besides the 'special' ones (e.g. Eyre and Rushton 1989). This is forcefully brought home when there is a major change in rarity status. The Rocky Mountain grasshopper, for example, went from being an extremely widespread and abundant species to becoming extinct in 30 years (Lockwood and DeBrey 1990). Similarly, the carrion-feeding beetle *Nicrophorus americanus*, once widespread in 32 states of the USA is now endangered and recorded

from only two widely separated localities (Amaral and Morse 1990; Hafernik 1992).

7.2.9 Perspectives and approaches to multi-species inventorying and monitoring

7.2.9.1 Multiple-taxa inventories

Many inventorying efforts target multiple taxa and these have the advantage of providing a broader understanding of the biological diversity of a region. However, such inventories are restricted in their taxonomic scope by the availability of systematic expertise, logistical support or financial resources. In some areas of the world, major inventorying efforts involving numerous taxonomic specialists are increasingly rare, even though they can add substantially to our biological knowledge of those regions. An introductory appraisal of multi-species inventories, at least for invertebrates, is given by Majer (1987).

Nevertheless, there exist areas where the multi-taxa approach has been used successfully for several decades. Methods of making multi-taxa inventories, for example, were developed in soil zoology. The majority of quantitative methods for the extraction of soil invertebrates are based on the separation of different size groups, which occupy different spatial niches in the soil environment: nanofauna, microfauna, mesofauna, macrofauna. Each size group includes different taxa. For example, the nanofauna includes Protozoa, Rotifera and Nematoda; the mesofauna includes Enchytraeidae, Collembola and Acari; and the macrofauna includes Lumbricidae, Myriapoda and Isoptera. Methods of sampling invertebrates migrating along a soil surface also include representatives of many different taxonomic groups (Gilyarov and Striganova 1987).

Characteristic assemblages can be used with geographical data and models to estimate future distributions and areas for conservation. For example, recent inventories in Western Australia have attempted to compare the geographical patterns in species composition of several ecologically very different groups of organisms, including plants, birds, reptiles and land snails. Noting differences, McKenzie *et al.* (1989, 1991) combined the quadrat cross-species records of these groups into a single matrix and then classified each species into sub-sets according to their patterns of congruence in the same quadrats. These sub-sets were analysed separately to derive compositional gradient models (that related to climatic and geomorphic attributes) for reserve system design.

7.2.9.2 Intensive site inventories

Much inventorying is and has been focused at single sites, and as such the resulting faunal and floral lists are valuable tools for ecologists and environmentalists. In spite of this, no single site in the world has ever been fully inventoried. Box 7.2-4 describes the proposed approaches and methods of one All Taxa Biodiversity Inventory (ATBI) (Janzen and

Hallwachs 1994). The ATBI concept has been criticized by some because an inventory that surveys all taxa cannot be undertaken at this time due to the lack of systematic expertise for many groups of organisms, especially the small and cryptic ones. Furthermore, such ATBIs will be time-consuming and expensive, will require extensive input from many experts and may be possible at only a limited number of sites (see Wheeler 1995; Wheeler and Cracraft 1995). Nevertheless, a relatively comprehensive inventory of most of the taxa at a localized study site is feasible in principle and one such effort is now being planned for Costa Rica (see Box 7.2-4).

7.2.9.3 Rapid inventories

Traditionally, inventories have involved relatively intensive sampling, accompanied by the collection of voucher specimens. However, in recent years increased attention has been given to short-term inventories that can provide rapid information on species richness to help set conservation priorities. Rapid biodiversity assessments (RBAs) (Beattie and Oliver 1994) are most commonly applied to site-based problems and seek to inventory a selection of focal taxa to provide a measure of the richness or uniqueness of the site or area. RBAs are commonly undertaken as part of environmental assessments made in anticipation of large-scale development projects. They may also play an ongoing role in conservation assessments when time is short.

RBAs generally use visual encounter surveys (VESs), the assumptions and methods of which are described by Crump and Scott (1994). VESs cannot produce highly accurate estimates of the densities of animals such as birds and mammals unless coupled with a mark-recapture analysis. A further methodological limitation of VES is their inability to sample all biotopes or microhabitats equally. Depending on the goals of the study and the target taxa, the design of a VES may employ random walks, quadrats, patches or transects as the basis for sampling (see Crump and Scott 1994 for details). For some target organisms, 'vouchers' such as tape recordings or photographs can supplement visual recordings.

The primary ingredient in the success of rapid assessments is the employment of field personnel who have a very high degree of expertise with field surveying and identification. Because of their central reliance on visual identifications, rapid assessments involve only those groups of organisms that are relatively well known and easily identifiable in the field, particularly birds, mammals and flowering plants. Rapid methodologies can also be employed to inventory for bioindicators or for local populations of focal species. This might be particularly appropriate for flagship, threatened or large species (for example cats, whales and other marine mammals, primates and some invertebrate groups such as butterflies).

Box 7.2-4: All Taxa Biodiversity Inventory (ATBI) (*from: Janzen and Hallwachs 1994*).

An All Taxa Biodiversity Inventory (ATBI) is a species-level, total inventory (from viruses to big trees) of a large site, which documents:

- which species are present and how to tell them apart;
- where they can be found on the site;
- how to obtain them;
- their natural history (chemistry, behaviour, food, husbandry, population fluctuations, migrations, seasonality, genetics).

All of this information is electronically managed, analysed and displayed in diverse user-tailored formats. The site must be formally conserved and administered, and easily accessible to society.

An ATBI is conducted by national human resources and institutions, with international collaboration. Concurrent with its inventory actions, an ATBI plans and promotes the actual development and use of its wildland biodiversity information products. The goal is to set up wildland biodiversity for many users and many sustainable uses (e.g. education, ecotourism, biodiversity prospecting, agriculture, government planners, scientists, ecosystem managers, conservation managers and environmental monitoring). Of particular interest to biodiversity scientists, an ATBI generates a known universe against which to calibrate a plethora of inventory sampling procedures, a gigantic biodiverse 'miner's canary' with which to monitor the impact of environmental change and the only kind of site in which taxonomy will not be an impediment to studies of interactions.

An ATBI site should be sufficiently large and biologically complex to contain at least half of a nation's or major region's species (hundreds of thousands of species in at least 50 000–100 000 ha (500–1000 km²)). The site should contain many habitats, one or more major ecosystems, a watershed, a major elevation gradient and representative disturbed as well as undisturbed habitats. It must have formal protection status and be accessible to society.

The basic working unit of an ATBI is a Taxonomic Working Group (TWIG) – the set of taxonomists, parataxonomists, technicians and other collaborators responsible for the inventory of a given higher taxon (e.g. nematodes, fungi, Hymenoptera, vertebrates, Coleoptera). As many as 35 TWIGs might be involved in an ATBI. A TWIG contains the in-country biological expertise for a taxon plus a pool of international taxonomists. Each TWIG will determine its own inventory protocols, sampling procedures, stop rules, interim taxonomies and sampling thoroughness within the available time, budget, taxonomic expertise, administration, inter-TWIG interactions, site traits and interactions with biodiversity user groups.

The TWIGs are complemented by groups dedicated to networking through the Internet, in-country science capacity-building, educational outreach, international taxonomic training, development of biodiversity use, and public participation. The process of an ATBI will be strongly influenced by the users of its products as well as its science. The basic information from an ATBI is in the public domain, and the host nation will develop both public and proprietary uses for this information.

The first ATBI will cost as much as US\$100 million, primarily for infrastructure, taxonomy, information management and human resources, with a lesser cost for subsequent ATBIs. Additional resources for post-ATBI specimen and information maintenance and further development will be required to maximize information use. The overall outcome of an ATBI is that conserved wildlands are valued, developed and maintained as a national resource, and that biodiversity understanding moves forward rapidly and locally. An ATBI is an investment of local, national and international scientific, managerial and industrial resources in the non-damaging development of wildland biodiversity.

The government of Costa Rica and the Instituto Nacional de Biodiversidad (INBio) are conducting an ATBI of the 110 000 hectare Guanacaste Conservation Area. This project, termed INBITTA in Spanish and intended to be a pilot project for the tropics, will inventory about 60% of the nation's biodiversity. Its initiation is funded by the INBio, the Norwegian government (NORAD), the US National Science Foundation and the government of Costa Rica. GEF/World Bank funds are sought for the two years of Phase I beginning in 1996. The national ATBI commission contains representatives from those Costa Rican entities that deal extensively with wildland biodiversity.

A rapid methodology is feasible and efficient in that the focal taxa are readily inventoried over a short duration. A second advantage is that they are inexpensive relative to conventional systematic inventories. However, RBAs do not serve as a substitute for scientifically rigorous inventories. The future scientific merit of RBAs is limited in that the reliability of the information collected will often depend on the reputation of the observer rather than on the enduring scientific value associated with voucher specimens that were sampled in a rigorous manner. RBAs are further constrained to sampling only a very small component of the diversity of a region and, because they focus mainly on vertebrates, plants and other readily visible organisms, they may overlook many diverse and unique groups (see Trueman and Cranston 1994). One of the main problems with RBAs is that they say little about important, critical conservation taxa (i.e. the rare phylogenetic, remote, endemic or threatened ones). The interest in a rapid method to identify and inventory priority conservation sites led to the creation of Conservation International's Rapid Assessment Programme (Tangley 1992) and The Nature Conservancy's Rapid Ecological Assessment (Sobrevilla and Bath 1992; Iremonger and Sayer 1994). Box 7.2-5 describes Conservation International's approach to rapid assessments.

7.2.9.4 Global inventories

In many ways, inventories for conservation, environmental impact, or monitoring of change can only be effectively carried out at present using inventory data for a few well-known groups of organisms such as birds and large mammals. As Prendergast *et al.* (1993) and Williams and Gaston (1994) have shown, management decisions based on data for a limited range of organisms of only low or moderate diversity can be misleading. There is, therefore, an urgent need rapidly to increase our knowledge of the world's biota and its distribution. Since, as discussed above, it is not possible at this stage to complete a global

inventory for all organisms, it is essential that a few target taxa are selected for such action. Recent meetings of the directors of Major Entomological Systematic Facilities have agreed such a course of action, with groups such as papilionid and hesperiid butterflies and termites being suggested as the first of a series of focal taxa for the so-called All Biota Taxonomic Inventory (ABTI). The intention is to invest heavily in the inventorying and systematics of these groups so that, with a much more complete understanding of their identities, phylogenetic relationships and distribution, they can be used more in local, regional and global assessments (see Wheeler 1995).

7.2.10 Ecosystem and landscape inventorying and monitoring

7.2.10.1 Monitoring landscapes

Landscapes contain all levels of the biological hierarchy, from ecosystems to species and genes, that are targeted for biodiversity inventories and conservation (Noss and Harris 1986). Landscapes may also include agricultural, forestry, protected and ecologically sensitive areas, which interact considerably (Forman and Godron 1986) and upon which humans have a major influence (Naveh and Lieberman 1990). Inventories of habitats and ecosystems, such as types of forest or large marine ecosystems, can be made at the landscape level. At the regional level, therefore, biodiversity inventories that target landscapes are important as these are composites of alpha, beta and gamma diversities (Noss 1983; see Section 2.3).

7.2.10.2 Monitoring healthy ecosystems

It is sometimes said in casual parlance that ecosystems 'collapse' but this is a dramatization, since ecosystems are continually changing, albeit sometimes in major ways, in response to various types, intensities, and frequencies of disturbance. The disturbance may be natural (Pickett and White 1985) or anthropogenic (see Section 5.3.1). Whatever the cause, any ecosystem may show resistance to

Box 7.2-5: Conservation International's Rapid Assessment Programme.

The interest in a rapid method to identify and inventory priority conservation sites led to the creation of Conservation International's Rapid Assessment Programme (RAP) (Tangley 1992). RAP is a biological inventory programme designed to meet the information needs necessary to catalyse conservation action and give a regional focus to biodiversity protection. The purpose of RAP is to quickly collect, analyse and disseminate information on poorly known areas that are potentially important sites for biodiversity conservation. RAP works by assembling teams of leading field biologists, including host country scientists, to generate preliminary, on-the-ground assessments of the biological value of focal areas. Team members examine an area's biological diversity, its degree of endemism, the uniqueness of its environments and the degree of risk of extinction of its most threatened species.

RAP methodology is designed to provide this critical scientific information quickly and at lower cost than long-term inventory research. This methodology provides a model tool in setting priorities for conservation activity world-wide. It may help also to provide countries with the information and technical assistance needed for the development of national biodiversity strategies.

change (i.e. the impact is too localized or too minor to change the ecosystem) and it may show various degrees of resilience (i.e. ability to return to its former state) (Pimm 1991). Studies of resilience do not ignore natural succession.

Restoration ecology is a major growing field of research and management that is expected to continue to expand in importance (Jordan *et al.* 1987; Soulé 1989). Restoration, however, is a last resort and is far more expensive than maintaining an ecosystem intact in the first place. There must be critical assessment and monitoring of an area to see whether it is simply being 're-greened' or whether an original ecosystem is indeed being reconstituted.

Maintaining a 'healthy' ecosystem does not always mean lack of anthropogenic intervention. Indeed, certain agroecosystems are 'healthy' in the sense that there is maintenance of good soil structure, diversity of soil organisms and minimal impact on surrounding, possibly natural, ecosystems. Monitoring is important in these systems to ensure their continued integrity. The field of restoration ecology is growing rapidly, especially in temperate areas. Monitoring these improvements, especially in the tropics and Southern Hemisphere, is going to be a central feature of biodiversity conservation in years to come (see Figure 7.2-3).

7.2.10.3 Forest inventories

A recent method of inventorying in complex tropical moist forests is through the establishment of large-scale plots. Hubbell and Foster (1983) established a 50 ha plot (1000 m × 500 m) on Barro Colorado Island, Panama, to investigate the organization and dynamics of tropical rain forest. The plot was divided into 20 m × 20 m quadrats that were further subdivided into 5 m × 5 m sub-quadrats, and all woody stems of 1 cm diameter and larger at breast height were tagged, measured for diameter, identified and mapped. The plot is recensused at five-year intervals, and

recruitment into the minimum diameter class, and mortality, are recorded.

A similar 50 ha plot was established in Pasoh Forest Reserve in Peninsular Malaysia (Manokaran *et al.* 1990, 1992) and another is being established in Sarawak, Malaysia. The Pasoh plot provided interesting information: 820 species of woody plants were recorded in the 50 ha plot (Kochummen *et al.* 1990), this being almost one-third of the total number of tree species found in Peninsular Malaysia. See Box 7.1-8 for a more detailed discussion of the Malaysian forest resources inventory.

These large-scale plots, besides providing information on population structures of individual tree species and on tree dynamics, are supporting other studies. For example, population structures of certain palm species are being investigated at Pasoh, and a collaborative project that has just been initiated between British and Malaysian scientists will investigate the diversity of epiphytic plants, the arthropod community, fungi, herbaceous ground flora, and other palm flora in the 50 ha plot. The plot at Barro Colorado Island has been and is supporting such studies as well.

7.2.10.4 Remote sensing

Of the many ways to describe vegetation diversity, the most common are extent, structure, composition, biomass/production, and condition. Each of these can be measured on the ground, but they may be interpreted more effectively from various forms of remote sensing. Maximizing the amount of vegetal information extracted from remote sensing may help to reduce the time spent in the field. We use remote sensing (Lund 1988) to:

- extract direct and indirect information including vegetation type, crown widths, area, vegetation heights, volume, land use, distances between objects, and spectral classes;
- classify and map such things as soils and vegetation;
- co-ordinate and integrate data collection activities by defining areas of responsibilities;
- create sampling frames and sample units;
- navigate to plots and project areas;
- provide sources of information for extrapolating field observations;
- store and document information in the form of annotations on imagery;
- report and analyse results of inventories including inputs to GIS;

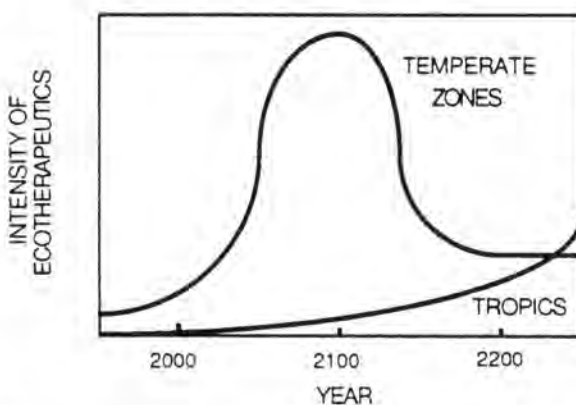

Figure 7.2-3: Speculative curves suggesting the intensity of habitat rehabilitation and related activities that might be expected in the future in the temperate zones (upper curve) and tropics (lower curve) (from: Soulé 1989).

- develop bases from which to monitor and update changes, and
- create aids for training, briefings and information transfer.

We use field plots (Päivinan *et al.* 1994) to:

- collect data not available from mapping/monitoring platforms and sensors;
- provide a basis for model building;
- calibrate remote sensing, and
- use in accuracy assessment of remote sensing projects.

Any broad vegetation type that is structurally homogeneous and distinct, such as forest or grassland, is readily inventoried with remote sensing. Using maps and remotely sensed data, with verification from careful ground truthing, it is possible to draw limits around vegetation types, and thus remote sensing can be used successfully to identify the frequency, boundaries, sizes and shapes of various landscape components (Scott *et al.* 1993). Interpretation of the products obtained from aerial photographs or remote sensing requires considerable expertise and manpower, as does the verification of that information by ground truthing. Without adequate ground truthing, however, remotely sensed data can be misleading, because patches smaller than the resolution of the imagery are missed, successional stages are not easily distinguished and gradual ecotones are not perceived (Scott *et al.* 1993). Furthermore, because vegetation in general is a product of the local soil condition, rainfall pattern, temperature and elevation, information on these abiotic factors enhances the predictability of remotely sensed information (Meher-Homji 1971).

When viewed from above, remotely sensed images are like maps spread over a table, with most elements of the landscape clearly drawn. Inventorying the distribution of biodiversity on such a map with appropriate methods is a challenge. Sampling points and grids arrayed across an area have been used effectively for inventorying biodiversity at the landscape level. The number and spacing of points, and the size and array of grids, depend upon the size of the landscape being sampled.

Remote sensing systems may be either passive or active and may be mounted on a flying platform (helicopters, fixed-winged aircraft, satellites) or hand-held and used on the ground. Passive remote sensing systems are those that detect energy that originates from a source away from the sensor. These include aerial photography, multispectral scanners and many satellite-based systems. Active systems

send out a pulse of energy that is reflected back from the target area, examples being synthetic aperture radar and laser altimeters or profilers (see Lund *et al.* in press).

7.2.10.4.1 Passive systems. Passive systems include optical or electro-optical sensors. Optical 'scanners' are hand-held cameras and those mounted in aerial or space platforms. Photography taken from the ground, especially from field-plot locations, is useful for documenting conditions on the plot that are difficult to quantify on a form in the field. Vegetation attributes that may be interpreted from ground photography include species composition, structure, biomass and health or condition. Takao (1992) has developed a camera system that can take stereo photographs in a 360 degree circle around the plot centre. From these one can make detailed measurements of the vegetation. Field photos taken from the same location over time provide a good means of monitoring changes in vegetation (Tappan *et al.* 1994). Aerial photography is the most widely used form of optical remote sensing imagery for vegetation surveys. Modern camera systems and films provide imagery of high resolution over a broad range of scales, and record reflected energy in the visible and near infrared portions of the spectrum.

Unlike aerial cameras, electro-optical systems are not limited by the sensitivity of chemical reactions that occur when reflected light strikes the film to create an image. Information from electro-optical systems may be recorded in analogue or digital format. Video systems capture data in analogue form, but most electro-optical systems convert the intensity of incoming energy directly to digital data. Although generally of lower spatial resolution than aerial photography, electro-optical sensor data have advantages for natural resource applications. Image analysts can directly manipulate the digital imagery using computer-based systems to rectify, classify, enhance and display the imagery (Myhre *et al.* 1991; Bobbe *et al.* 1993).

Multispectral or electro-optical systems can be configured to record information from the ultra violet through the visible, near, middle and thermal infra red to the microwave portion of the spectrum. The middle and thermal infrared portions of the spectrum are important for identifying and assessing the condition of vegetation. With some sensors, especially those that operate in the several parts of the spectrum, an indication of the composition and the condition of the vegetation may be obtained. Imagery taken in different seasons can also help in species identification. To determine structure and biomass, we often need high-resolution, stereo remote-sensing coverage. In general, however, the higher the resolution the more costly is the imagery.

Satellite-based systems

Digital imagery from remote sensors carried aboard Earth-orbiting satellites provides information on extensive areas.

Meteorological satellites provide information for specialized natural resource applications. Geo-synchronous satellites provide synoptic low resolution coverage on an hourly basis. Imagery from the Advanced High Resolution Radiometer (AVHRR) carried aboard the United States National Oceanic and Atmospheric Administration (NOAA) series of satellites has been used in assessing forest fuel condition and for developing national vegetation cover maps for several parts of the world. AVHRR imagery has a nominal resolution of 1.1 km at nadir and daily coverage. A 'scene' covers approximately 1750 km × 6000 km.

Multi-date AVHRR data are valuable for basic mapping, land-cover change detection, and documentation of trends in vegetation conditions over time. The data can be acquired as often as every day and can be used to develop near cloud-free composites based on several consecutive days of imagery. Furthermore, compiled over a one-year interval, these products can be used to identify phenological characteristics of vegetation and would be useful in the development of spectral classifications in monitoring programmes (Giri and Shrestha, in press).

The United States Landsat and French SPOT (Système Probatoire d'Observation de la Terre) satellites provide easily accessible imagery with global coverage. Circling the Earth in near-polar sun-synchronous orbits, the sensors aboard these satellites acquire imagery at a consistent solar time during each daylight pass. Repeat vertical coverage is available from a single Landsat satellite on an approximate 16-day cycle. When multiple satellites in the same series are operating, the orbits are such that the repeat frequency of vertical coverage is proportionally increased.

The current Landsat satellites (4 and 5) carry the Multispectral Scanner (MSS) and the Thematic Mapper (TM). Both instruments are mechanical scanners that employ a rotating mirror to acquire data in the cross-track direction. A full scene of Landsat data is 185 km × 185 km. The Thematic Mapper has a resolution of 30 m in six bands of reflected energy extending from the blue portion of the spectrum to the middle infrared and an emissive thermal infrared band with a resolution approximately 120 m. Thematic mapper data have been available since 1982. There have been many successful examples of using Landsat TM to help in the mapping of vegetation cover down to forest condition and type. The mapping of old growth vegetation, forest type and structure in the Pacific Northwest Region of the United States is one example (Steffenson and Wilson 1993). Landsat TM has also been used to monitor subtle changes in vegetation such as that reported on the Mark Twain National Forest in the US (Platt *et al.* 1993).

The Multispectral Scanner has a resolution of 80 m in four spectral bands in the green, red and near infrared portions of the spectrum. Multispectral scanner data have been available since 1972. The current Landsat 5 is the last satellite in the series to carry a multispectral scanner

instrument. Although of significantly lower resolution than the Thematic Mapper, MSS data are available for more than 20 years starting in 1972, making the data especially suitable for evaluating landscape change.

The French SPOT satellites carry two High Resolution Visible (HRV) instruments. Unlike the instruments carried aboard the Landsat satellites, the HRVs are solid-state instruments that image the entire swath of the flight path simultaneously. Each of these sensors aboard SPOT 1, 2 (in orbit) and 3 can acquire imagery in the green, red, and near infrared portions of the spectrum. SPOT 4, scheduled for launch in the middle of the decade, will add a mid infrared band to the SPOT HRVs. A full scene of SPOT imagery is 60 km × 60 km. SPOT multispectral imagery has a resolution of 20 m. The SPOT HRVs can also be programmed to record panchromatic imagery with 10 m resolution. These sensors may be pointed off nadir parallel to the spacecraft ground track, and thus enable the acquisition of additional imagery to previous satellite overpasses and stereo imagery (SPOT Image 1989).

Videography

Videography, especially in the form of airborne video, is a relatively recent addition to the spectrum of remote-sensing systems available for natural resource applications. It uses normal, domestic video cameras and cassettes: the equipment and tapes are inexpensive and no processing is required.

Aerial video is a cheap and effective way of imaging forest conditions for monitoring and measurement activities. Video systems are less sensitive to the problems of exposure common to film camera systems and the resulting imagery is also readily captured for use on computers. Evans (1992) demonstrated the usefulness of global positioning systems (GPS; see Section 9.3) with aerial videography and recommended the use of a gyro-stabilized camera mount to negate the effect of aircraft attitude variations. Bobbe (1992) discusses the use of real-time differential GPS with airborne videography and digitized video data using manual methods. Bobbe *et al.* (1993) discuss similar procedures using a multispectra video camera.

Aerial video can be used for visualization and for detailed analysis of forest attributes (Evans and Beltz 1992). One scheme could employ video as a sampling tool to assess large areas for specific information associated with forest health. This type of survey could be linked directly to information collected at field monitoring plots. Ground plots would be established at a uniform density across all forest lands. These field plots would be located with GPS units, and the GPS co-ordinates for the plots would be used for video mission planning and execution to ensure accurate overflights of the plot locations.

Video imagery would provide inexpensive and fairly detailed information about the canopy structure for field plots and all areas along transects between the plots. Stereo

pairs from video can be used to generate three-dimensional anaglyphs for visualization of canopy characteristics. Digital measurement of information on trees and stands from video may also be possible by use of photogrammetric techniques. Information derived from these analysis techniques can help researchers evaluate current conditions and changes in the forest canopy of field plots over time.

Video systems have lower resolutions than comparable photographic systems and currently lack the calibration necessary for precision photogrammetric applications. They are well suited for many natural resource applications requiring sample or small area coverage. They are also cost-effective for locating features such as isolated groups of insect-damaged trees within a larger survey area. System operators can evaluate video data during acquisition and change mission parameters as necessary. Improvements in camera design and the advent of higher definition recording formats such as Super VHS and HI-8 video have increased the resolution and utility of video systems for natural resource applications. Image analysts can manually interpret video imagery using a high resolution monitor and a playback unit with freeze-frame capability. For enhancement and geo-referencing, the analogue data in individual video frames can be captured as digital data using a video 'frame-grabber'. The relatively low cost of video systems make them a good candidate for many monitoring applications (Myhre *et al.* 1991).

Airborne electro-optical remote sensing systems cover a broad range of capabilities. Airborne systems support working requirements and serve as test beds to evaluate new sensor designs. Nixon *et al.* (1985) showed the utility of multi-band videography to assess vegetal condition and species.

One must recognize that the data from many current airborne digital remote sensing systems are difficult and expensive to register to ground co-ordinates. In addition specialized software and knowledge may be necessary to extract useful information from these data. Nevertheless, airborne systems have an extremely wide range of capabilities and the potential for providing solutions to many unique requirements. Table 7.2-1 provides some comparisons of the use of passive satellite/airborne systems.

Digital cameras

The use of digital cameras is very new in vegetation survey applications. The camera records images on a hard disk integrated with the camera and these are then transferred via an SCSI or parallel connection to the computer or directly to the computer's hard disk by the same connections. Preliminary results by Bobbe *et al.* (1994) indicate that digital camera systems mounted on aerial platforms can provide good quality imagery under a variety of conditions. Digitized photographs from the ground can be used in fractal analysis to help evaluate the health and vigour of the vegetation (Mizoue and Masutani 1993).

7.2.10.4.2 Active systems. Active remote sensing includes radar and lasers. Radar can provide area coverage whereas lasers provide point data.

Radar

A radar system makes use of reflected radio signals, and the all-weather capability of synthetic aperture radar (SAR) systems makes them ideal for use in tropical forest regions with frequent cloud coverage. Radar imagery can be collected from satellite and aircraft platforms. The European Space Agency's ERS-1 remote sensing satellite and the proposed Canadian RADARSAT have view areas of 50 × 50 km to 500 × 500 km. RADARSAT will have a resolution of about 25 m × 28 m and will be useful for monitoring severe changes in forest cover for areas greater than 100 ha. JERS-1, the Japanese Earth Resources Satellite, also has a radar system with similar characteristics and providing global coverage.

Airborne SAR can be used to complement Landsat TM and SPOT for information on geomorphology and vegetation texture, particularly in stereo. It is also useful for detecting changes in vegetation at larger scales (Ahern 1994). Short wavelength radar may penetrate upper vegetation layers potentially to provide information about forest understorey diversity and also about the ground. Some studies have shown that radar data may have utility in forest volume (Wu 1990) and biomass (Dobson *et al.* 1992; Hussin *et al.* 1992) assessments. However, these types of predictive measurements may be dependent on terrain characteristics (van Zyl 1993). Other work has shown that radar imagery could have utility in species group separation (Leckie 1990).

Used in combination with aerial videography and other remote sensor data and ground data, radar has the potential to provide a wealth of information on forest biodiversity. Aerial video and high-resolution radar can supply information at the stand and plot level for detailed characterizations of the forest canopy. Ideally radar systems should be capable of data collection in short wavelengths with the anticipated application of detection of multi-storeyed characteristics within tropical forests. An aerial video system (colour or multi-spectral) could be flown with the radar. This detailed information will be invaluable for forest health or condition monitoring (Brokaw and Mallory 1995).

Lasers

Lasers operate by sending out a short burst of light timed to determine how long the light takes to travel to a target. This time can be converted into distance (Carr 1993). Hand-held lasers have been used to measure distances to trees, from which heights can be calculated. Laser profilers mounted in aircraft can be used to measure heights of vegetation above the terrain (Ritchie and Weltz 1992). When coupled with

Table 7.2-1: Recommended uses for remotely sensed data sources for vegetation (from: Lachowski 1990).

Data Source	AVHRR	Landsat		SPOT		Photography		Video
		MSS	TM	MS	PAN	1:24K	1:12K	
Basal area	0	3bc	2-3bc	2-3bc	0	2-3b	1-2b	1-2b
Canopy cover	3b	2-3bc	1-3bc	1-3bc	0	1-3b	1-2b	1-2b
DBH (size class)	0	2-3bc	1-3bc	1-3bc	0	1-3b	1-2b	1-2b
Species	0	3abc	2-3abc	2-3abc	0	1-3b	1-2b	1-2b
Existing vegetation	3b	2-3abc	1-3abc	1-3abc	0	1-3b	1-2b	1-2b
Vegetation height	0	0	0	0	0	1-3	1-2	1-2b
Vegetation density	3b	2-3c	1-3c	1-3c	1-3c	1-3	1-2	1-2
Snag condition	0	0	0	0	0	2-3	1-2	1-2
Forest/non-forest	3b	1-3c	1-3	1-3c	1-3c	1-3	1-2	1-2
Hardwood/conifer	3b	1-3bc	1-3c	1-3c	1-3c	1-3	1-2	1-2
Structure (forest)	0	0	2-3bc	2-3bc	1-3bc	2-3	1-2	1-2
Insect/disease occurrence	0	3b	2-3b	1-3b	2-3b	2-3b	1-2b	1-2b
Fire occurrence	0	2-3b	1-3b	1-3b	1-3b	1-3	1-2	1-2
Forage production	3ab	2-3bc	1-3bc	1-3b	2-3b	2-3b	1-2b	1-2b
Range condition	3ab	2-3bc	1-3bc	1-3b	2-3b	2-3b	1-2b	1-2b
Range cover type	0	3bc	2-3bc	2-3b	0	2-3b	1-2b	1-2b

AVHRR – Advanced High Resolution Radiometer; MSS, MultiSpectral Scanner; TM, Thematic Mapper; SPOT, Système Probatoire d'Observation de la Terre; MS, Multispectral Scanner; PAN, Panchromatic.

Where recommend level of use is:

0 Not recommended for creation of data layer

1 Recommended for small area project where great detail is required (e.g. riparian mapping)

2 Recommended for medium area projects where broader classifications are useful (e.g. district or forest)

3 Recommended for very large area mapping projects where little detail is needed (e.g. state or country).

a Used with terrain data (slope, aspect, elevation)

b Used with field-collected data

c Used with photo-interpretation.

airborne videography and global positioning systems on a sample basis, vegetation structure and biomass can be determined.

7.2.10.5 Monitoring in marine environments and ecosystems

7.2.10.5.1 Introduction. The marine environment is the only uninterrupted, internally moving, three-dimensional environment. Therefore, in principle, every organism can reach all parts of the oceanic environment (Lasserre 1992). As a result, the approach to monitoring both populations and species biodiversity is quite different from that in terrestrial ecosystems. One of the difficulties encountered is that, due to the movement of water, no single observation can be repeated on exactly the same water body.

Ecosystems are generally represented as aggregations of interdependent species living together in communities in response to environmental factors and processes. Quantification of the diversity of ecosystems around the globe is highly dependent on the spatial scale of interest –

there is no single measure of the global diversity of ecological systems. Two standard approaches for characterizing ecological systems are the designation of 'biogeographic regions' and 'ecoregions'. Both approaches consider factors such as the environment, the species composition and the relationships among species. A system of 'ecoregions of the continents' is used to demarcate ecologically similar areas of land (ecoregions) in order to predict changing ecological states or conditions. In the oceans, 95% of the annual biomass yields, major losses of habitats, and stresses on biodiversity from overfishing and pollution, occur within 49 large marine ecosystems (see Box 7.2-6). Most coastal countries support the concept of systematic surveys of marine resource species and their environments. However, the utilization of the collections made and the analyses completed are often limited to commercially important 'target' species. Augmentation of these efforts with the application of more comprehensive and integrative efforts would provide a valuable contribution to an understanding of the dynamic variability

in biomass yields and the sustainability of biodiversity of species inhabiting coastal ecosystems.

The high-diversity coastal ecosystems contain many pelagic and/or benthic species that range widely over several orders of magnitude in both size and abundance (e.g. whales and picoplankton). Thus the monitoring of these species is logistically a complex problem. Larger species tend to be more mobile, their home ranges are more extensive and individuals can exert considerable control over their location. In contrast, small organisms are unable to control their distribution in space by their behaviour, but in many species their reproductive rates are rapid enough for them to exploit fine-scale events. This gives rise to the problem of discriminating between population responses to coarse-scale events, such as those generated by interannual and decadal variations in climate and those that are caused by shorter term variations induced by ocean weather. The nature of marine organisms is that they change trophic level as they grow. Consideration should be given to sampling the different stages in monitoring surveys aimed at assessing changes in the health of estuaries which serve as nursery grounds for many species. For example, marine reserves such as the Great Barrier Reef in Australia are important conservation areas for a variety of marine biodiversity in contrast to adjacent unmanaged ocean areas (Kelleher 1993).

7.2.10.5.2 Large marine ecosystems. The focus for conservationists monitoring marine organisms has largely been on individual large species such as whales, dolphins, turtles and, to a lesser extent, some of the larger sharks (di Castri *et al.* 1992). However, there have been numerous large-scale, long-term monitoring studies of Large Marine Ecosystems – regions of ocean space encompassing coastal areas from river basins and estuaries on out to the seaward boundary of continental shelves and the seaward margins of coastal current systems (see Box 7.2-6). Although these studies have focused largely on the functioning of the ecosystems, many of the projects have monitored selected marine species, particularly the fluctuations of economically important species in response to over-exploitation and environmental factors (AAAS 1993).

In the Benguela Current Ecosystem, off the southwest coast of Africa, long-term fluctuations in the abundance levels of pilchard, horse-mackerel, hakes, anchovy and other species have been monitored for many years (Crawford *et al.* 1989). In this system the fluctuations are attributed largely to changes in the oceanographic environment, brought about by phenomena such as the El Niño Southern Oscillation (see Lasserre 1992). The effect of the fisheries on changes in species abundance has been found to be secondary (Shelton *et al.* 1985; Crawford *et al.* 1989). Changes in the abundance of species such as pilchards have led to detectable effects in the abundance levels of dependent predator species, particularly marine

bird populations, and to 'flips' in species dominance, such as anchovy replacing pilchard (Crawford *et al.* 1989). Similar fluctuations in abundances, and flips in species composition, have been shown in numerous other Large Marine Ecosystems (see Walters 1992). Some of these have also been attributed to environmental changes, while others are attributed to excessive fishing (e.g. off the northeast coast of the USA) and nitrate enrichment resulting from elevated levels of agricultural contaminant inputs from neighbouring landmasses (e.g. in the Baltic Sea).

Changes within these Large Marine Ecosystems are monitored using several standardized and intercalibrated modules, including bottom-trawl surveys for fish and benthos; plankton surveys for indexing biodiversity changes within the water column; acoustic surveys for monitoring pelagic fish; and the use of designated 'biological indicator' species for monitoring pollution effects within the ecosystem. These monitoring efforts are augmented by oceanographic measurements and catch records from commercial and recreational fishing efforts.

7.2.10.6 Monitoring freshwater ecosystems

Freshwater ecosystems (FWEs) include lakes, reservoirs and river basins and represent the basic sources of freshwater on Earth. The majority are anthropologically modified by, for example, the building of dams (for energy generation and irrigation purposes), creation of reservoirs, and pollution by industrial and agricultural waste containing heavy metals, oil-hydrocarbons, detergents, phenols, pesticides and other toxicants. Examples of how such additions may affect species in freshwater ecosystems are given in Figure 7.2-4.

Negative changes in hydrological and hydrochemical conditions in FWEs include accidental introductions of non-indigenous freshwater species resulting in decreasing biodiversity and accelerating the extinction of rare and endemic species. The abundance and variability of many species and populations of salmonid and coregonid fishes and the numbers of intra-specific forms of these fishes in Europe have been decreasing. The anadromous sturgeon, *Acipenser sturio*, has disappeared in the basins of the Baltic Sea as have some other species of fishes in European rivers. Populations of acipenserid fishes in Siberian rivers have decreased. The decimation of populations and extinctions of many endemic species of cichlid fishes resulting from the introduction of the Nile perch, *Lates niloticus*, is well known (Barel *et al.* 1985; Witte *et al.* 1992).

Monitoring biodiversity in freshwater ecosystems has been addressed most directly with respect to several kinds of species assemblages. Examples include: the cichlids of the African Great Lakes (especially those of Lake Victoria); the salmonids (including salmonines, coregonines and thymallines) particularly of the Laurentian Great Lakes, the Alpine lakes of Europe and the river-lake-ocean waters of

Box 7.2-6: Global projection of Large Marine Ecosystems

Large Marine Ecosystems (LMEs) are regions of ocean space encompassing coastal areas from river basins and estuaries to the seaward boundary of the continental shelves and seaward margins of coastal current systems. They are relatively large regions, characterized by distinct bathymetry, hydrography, productivity and trophically linked populations (Sherman and Alexander 1986; Sherman *et al.* 1990). In the oceans 95% of the annual biomass yields, major losses of marine habitats and stresses on biodiversity from overfishing and pollution occur inside the 49 LMEs.

Inventorying and monitoring projects are under way in a few LMEs. To meet the objectives of the Global Biodiversity Convention, monitoring and assessment efforts will need to be expanded to encompass all LMEs with special priority given to the most highly productive ones in Asia (e.g. South China Sea, East China Sea) and Africa (Canary Current, Benguela Current, Red Sea and Somalia Current LMEs) where the human population increases of coastal nations are in need of the living resources produced within the LMEs as a source of nutrition. Several of the more developed nations have established time-series programmes to monitor and assess the changing population levels of key resources and environments within LMEs in the Northern Hemisphere. The opportunity for providing technical assistance and capacity-building to the lesser developed countries for implementing, inventorying and monitoring of marine species supporting fisheries in LMEs of the Southern Hemisphere is now being supported by international agencies, including the Global Environmental Facility, the World Bank, UNDP and UNEP, as a contribution to the objectives of the Biodiversity Convention.

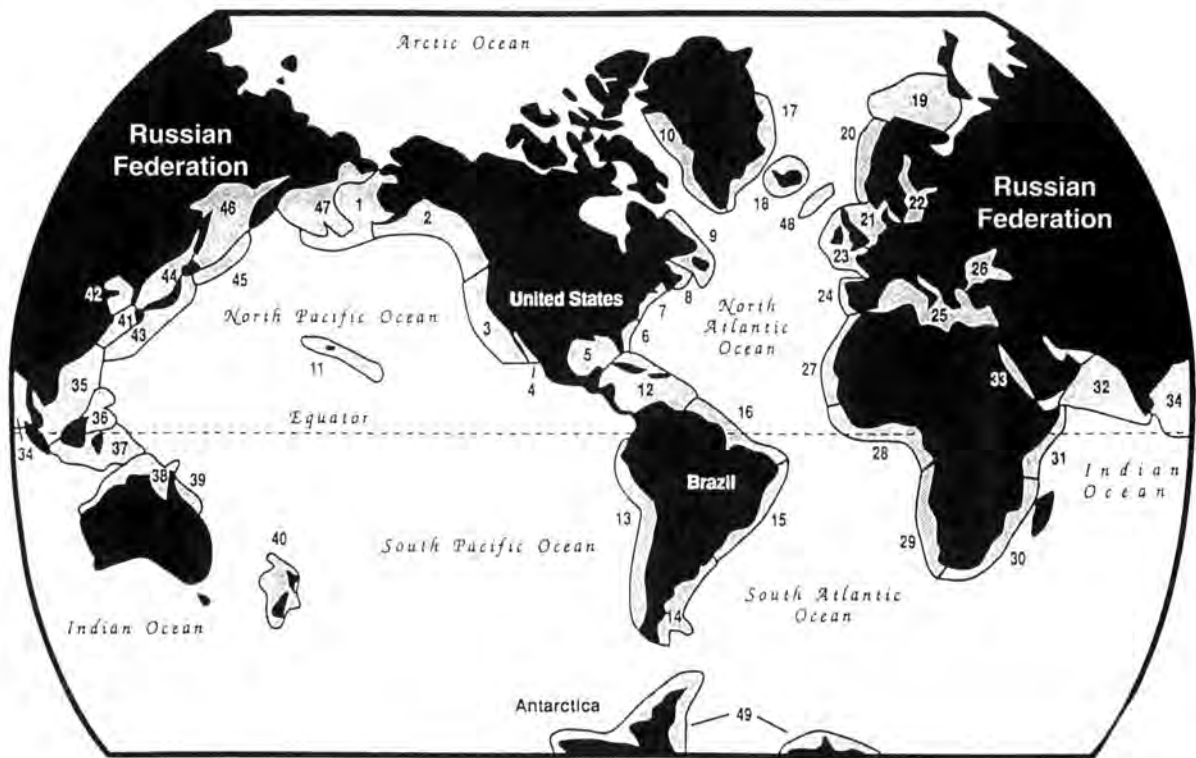

- | | | | |
|-----------------------------------|----------------------------|-------------------------------|-----------------------|
| 1. Eastern Bering Sea | 14. Patagonian Shelf | 27. Canary Current | 40. New Zealand Shelf |
| 2. Gulf of Alaska | 15. Brazil Current | 28. Guinea Current | 41. East China Sea |
| 3. California Current | 16. Northeast Brazil Shelf | 29. Benguela Current | 42. Yellow Sea |
| 4. Gulf of California | 17. East Greenland Shelf | 30. Agulhas Current | 43. Kuroshio Current |
| 5. Gulf of Mexico | 18. Iceland Shelf | 31. Somali Coastal Current | 44. Sea of Japan |
| 6. Southeast US Continental Shelf | 19. Barents Sea | 32. Arabian Sea | 45. Oyashio Current |
| 7. Northeast US Continental Shelf | 20. Norwegian Shelf | 33. Red Sea | 46. Sea of Okhotsk |
| 8. Scotian Shelf | 21. North Sea | 34. Bay of Bengal | 47. West Bering Sea |
| 9. Newfoundland Shelf | 22. Baltic Sea | 35. South China Sea | 48. Faroe Plateau |
| 10. West Greenland Shelf | 23. Celtic-Biscay Shelf | 36. Sulu-Celebes Seas | 49. Antarctica |
| 11. Insular Pacific - Hawaiian | 24. Iberian Coastal | 37. Indonesian Seas | |
| 12. Caribbean Sea | 25. Mediterranean Sea | 38. Northern Australian Shelf | |
| 13. Humboldt Current | 26. Black Sea | 39. Great Barrier Reef | |

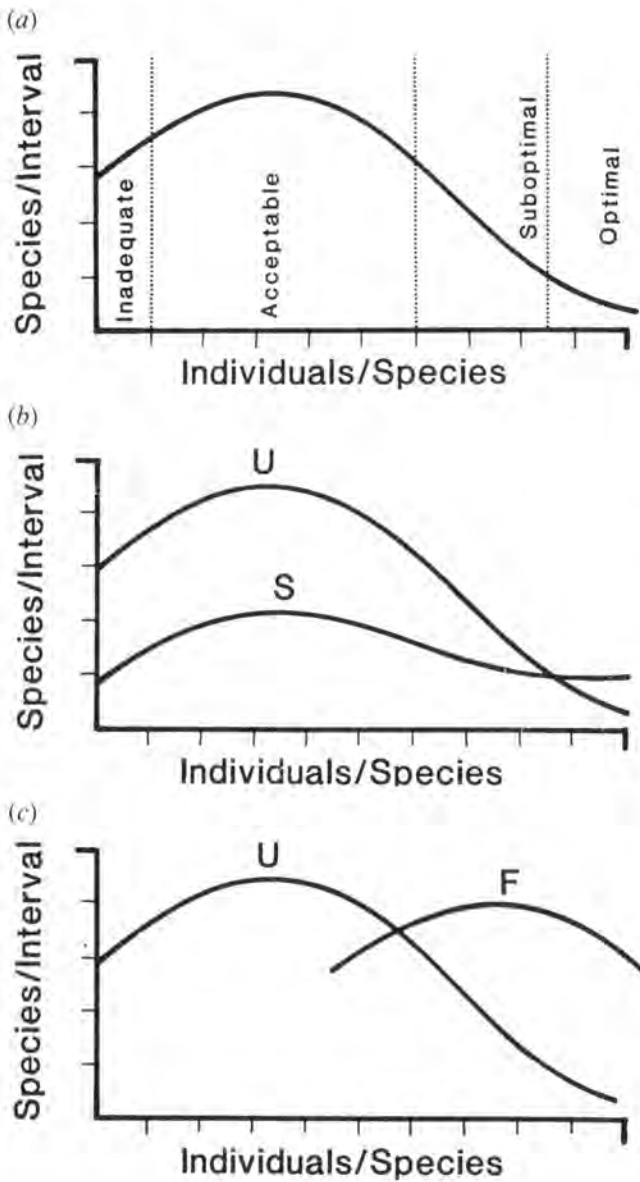

Figure 7.2-4: Canonical distribution of species abundances as represented by stream organisms (based on Patrick 1971). The scale for individual/species is an octave (exponential) scale. (a) Probable life conditions for species in a healthy community (based on Cairns 1971). (b) Effect of toxic or oxygen demanding stress on species distribution; U = unstressed, S = stressed. The number of species of moderate abundance is reduced. (c) Effect of moderate fertilization on species distribution; U = unfertilized, F = fertilized. Abundance of many species increases. (From Cairns and Pratt 1993.)

the North Pacific coast; and the darters, or benthic percids, of eastern North American waters. These taxonomically complex families tend to be particularly vulnerable to pollution.

Within such species assemblages, and especially within the salmonids, phenomena at different biodiversity levels interrelate reciprocally and systemically so that the conceptual boundaries between the levels are quite indistinct. Genetically, salmonids are polyploid so that each organism appears to have a redundancy of genetic

information. Populations within species differentiate behaviourally more than they do physiologically or anatomically. Thus, any basis for designating a set of populations as a species depends as much on ethological and ecological criteria as on chemogenetic and physico-anatomical criteria. There are continuing revisions of specific and generic categories and a recognition that rapid changes, as in the salmonid taxonomic complex, do not permit a permanent categorical formalization of the relevant taxonomic criteria.

For further information on monitoring in freshwater ecosystems see Adraanse *et al.* (1994), Callow and Petts (1992), Dumont *et al.* (1994), Jorgensen (1980), Ten Brink *et al.* (1991) and Welcome (1985).

7.2.11 Long-term monitoring of ecosystems

It is essential that long-term monitoring is carried out if we are clearly to identify human-made changes from 'natural' changes (Woiwod 1991). The United States National Science Foundation supports long-term ecological research (LTER) sites containing terrestrial, lake, stream and wetland ecosystems. Fifteen of the sites are in the United States, including two in Alaska, two are in Antarctica and one is in Puerto Rico. Each site conducts long-term ecological research which includes biodiversity assessments of selected groups of organisms and extensive associated research on ecosystem ecology (see Box 7.2-7).

The measurement of long-term trends and the establishment of early-warning networks will require continuity of commitment by funding agencies that may be alien to the current fashion for (on average) three-year project time spans.

The value of long-term monitoring is well illustrated by the British Butterfly Monitoring Scheme (Pollard and Yates 1993). Figure 7.2-5, for example, shows that some species such as the dark green fritillary may be declining and therefore more in need of conservation than other species. Unquestionably, long-term monitoring is now an essential requisite in biodiversity conservation, not only to track declines but also to 'see how we are doing' with improving environmental conditions.

Long-term research at more than 40 forest plots around the world shows that mature

tropical forests are changing more rapidly now than in the past. The rate of turnover of tropical trees, recruitment into and death from a population, has apparently increased (Phillips and Gentry 1994; Pimm and Sugden 1994). This phenomenon has implications for tropical biodiversity and the global carbon cycle and is discussed in Box 7.2-8.

7.2.12 Summary

- The approaches and methods adopted for inventorying and monitoring depend on the level of

Box 7.2-7: The US Long-Term Ecological Research Sites.

The Long-Term Ecological Research (LTER) programme of the National Science Foundation (NSF) supports a network of 18 research sites in Alaska, Puerto Rico, the Antarctic, and the continental USA. The sites are located on protected areas where continuity of research can be assured. Five are located at US Forest Service experimental stations, and others are on protected land belonging to universities, agricultural research stations, the US Fish and Wildlife Service, the US Bureau of Land Management and private conservation organizations.

Under the LTER programme, the NSF provides research support for scientists working in co-operation with the respective land-managing agencies and organizations. The goal of the programme is to promote long-term, interdisciplinary research. At all LTER sites, species inventories provide a sound taxonomic base for accompanying ecological research. Areas of research include nutrient cycling, plant productivity, population dynamics, and changes in plant distribution as a result of climate change and direct human manipulations. The programme supports a broad spectrum of research projects, from master's scale research to large-scale multidisciplinary, multi-institution projects on landscape ecology and global change. Extensive computer facilities allow electronic communication, data sharing and modelling.

Long-term, interdisciplinary studies provide answers to questions that can be answered no other way. For example, experiments at the Cedar Creek LTER in Minnesota demonstrated the importance of biodiversity on plant production following the major drought of 1988. Areas previously manipulated to contain high plant diversity maintained higher plant production during the drought and recovered more rapidly than did less diverse areas.

In another example, the Sevilleta LTER in New Mexico evaluates the influence of climate dynamics on rodent populations, plant biodiversity and plant production. The studies documented that population increases of the deer mouse (*Peromyscus maniculatus*) were responsible for the recent fatal Hanta virus epidemic in the southwest. Analyses of tissues from mice collected over many years are being used to determine when the new virus became established and to help understand the factors responsible for the epidemic.

Three sites focus on lakes (North Temperate Lakes in Wisconsin, the Arctic Tundra site at Toolik Lake in Alaska and the McMurdo Dry Valley Lakes site in the Taylor Valley, Antarctica). Two sites focus on marine systems (an ice edge marine site at Palmer Station, Alaska and a barrier island site at Virginia Coast Reserve) and 11 sites include some research on streams. At the North Temperate Lakes site, studies of species richness and turnover are under way on the fishes and plankton, as are metapopulation investigations of the zooplankton in a lake district with many adjacent lakes. Since 1975 at the arctic tundra site, physical, chemical and biological measurements have been taken at the deepest station at Toolik Lake at weekly intervals throughout the ice-free period (June, July, August) to monitor for long-term change due to natural or anthropogenic causes.

Across the network, biodiversity studies include surveys and time series on selected groups that allow analyses of species richness and turnover including invasions, extirpation and extinctions. At present, biodiversity studies at the LTER sites are expanding to link with population, community, ecosystem and landscape-level ecological studies. All sites collect long-term data in five core areas; primary production, disturbance, populations and community ecology, biogeochemical cycling and organic matter accumulation. The programme also works to generalize results and analyses at regional levels.

In the next decade, the LTER network plans to broaden its scope to develop multidisciplinary science and public education programmes, develop a multi-agency effort to add sites for wider representation of key biomes and portions of major gradients, create synthesis centres at selected LTER sites and facilitate the advancement of current ecological science and innovative research technologies. The programme has also begun to undertake a major expansion of its international activities, including: assisting in the establishment of networks for long-term ecological research in other countries; creating programmes between US and foreign LTER sites and networks; developing and operating a communication and data sharing system among an international network of sites, and facilitating the establishment of a global system of environmental research sites.

diversity being assessed and the geographical scale of the analysis. It is therefore essential that the goals of a project are clear and relate to the problem being considered. The value of biodiversity findings depends on the relevance and importance of the goals set and the thoroughness of the execution of the

project, as well as its accuracy. The feasibility and accuracy of inventorying and monitoring programmes also depend on the availability of adequate resources. The accurate interpretation of biodiversity information also requires an understanding of the ecological dynamics of the geographical area.

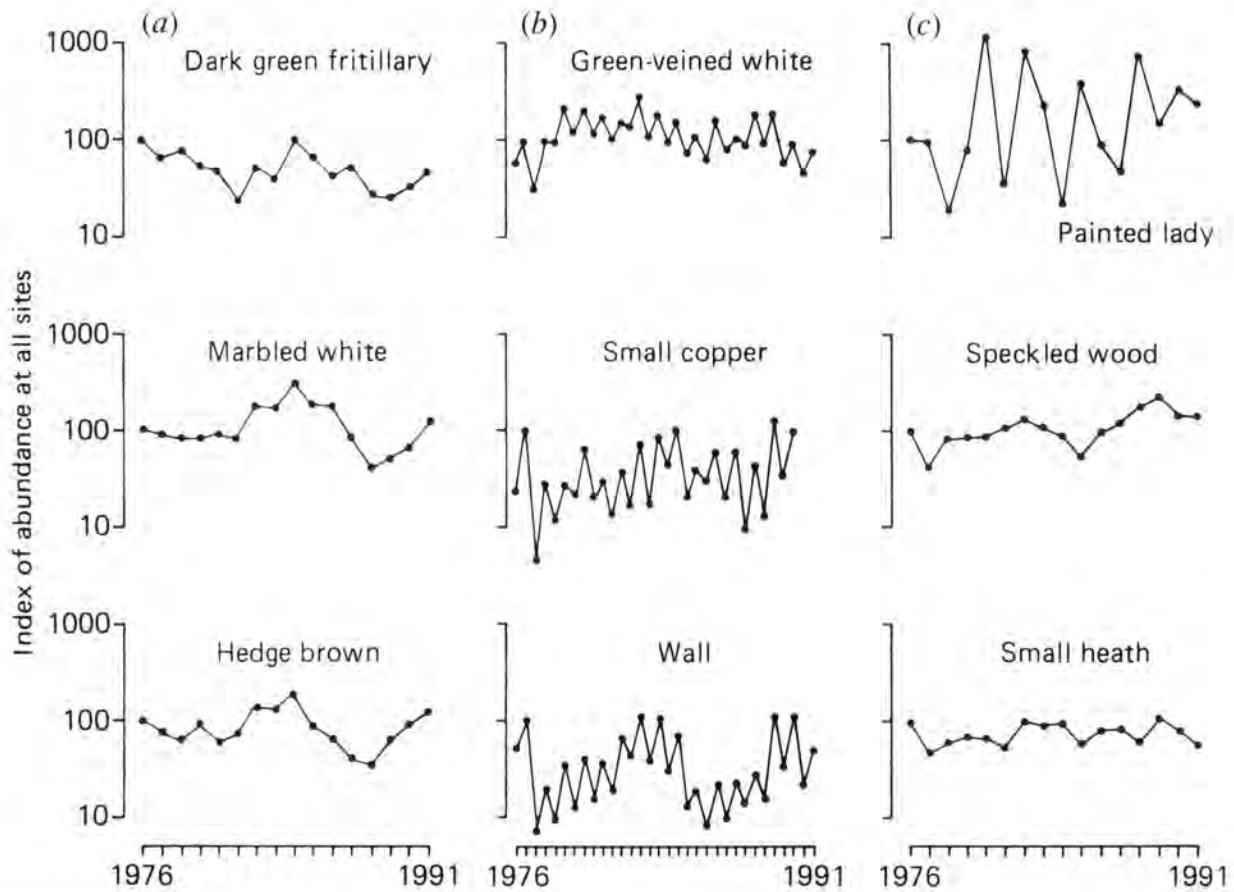

Figure 7.2-5: Fluctuations in abundance of nine butterfly species, 1976–91, based on collated index values from all sites in the British Butterfly Monitoring Scheme. (a) Species with one generation per year. (b) Species with two distinct generations. (c) Species with overlapping generations, given a single annual index. Note the logarithmic scale. (From: Pollard and Yates 1993.)

- Targets for inventoring and monitoring include genes, populations, species, communities, biotopes and ecosystems, particularly those of great scientific interest, those that provide comparisons between areas, keystone species, those that register environmental change, those that are economically important, and those in special need of protection. Variables used to monitor species can be compositional (e.g. abundances, cover values, densities, biomass), structural (e.g. dispersion, range, population structure, biotope variables) or functional (e.g. demographic processes, metapopulation dynamics, population genetics, growth rates).
- Historical collections of organisms provide extremely important baseline information on how a species has changed its range, abundance and form over time. Other existing data may also provide useful historical or even spatially comparative information.
- Species inventories must use standardized methods wherever possible and use recognized sampling protocols that sample the appropriate species adequately but not excessively. This makes the data and the analysis comparable with other studies in other areas. Standardization also allows for later validation and calibration of findings from one time or place to the next. In this respect, sampling protocols and standards such as those produced by Heyer *et al.* (1994) are needed for target taxa. A statistical framework for the analysis of biodiversity information is also essential and should be planned prior to data collection. This then provides meaningful and efficient fact gathering and interpretation.
- Voucher collections are essential for verification of field data and to provide a permanent historical record. In this sense natural history collections are a vital source of baseline data for inventoring and monitoring.
- The methods employed in inventoring and monitoring vary according to the level of biodiversity and the geographical scale of the study, and may include checklists of species, relative abundances, population densities or complete counts of

Box 7.2-8: Increasing turnover in tropical forests: a new threat to biodiversity. (After: Phillips and Gentry 1994.)

Tree turnover in forests is naturally a highly stochastic process. Periods of relative quiescence alternate with pulses of mortality and recruitment as trees fill new gaps. Effective monitoring of turnover rates through time requires long-term observations from many forest plots. Thanks to the cumulative efforts of tropical foresters and ecologists over half a century, tree turnover rates are known from at least 42 mature forest sites.

Plotting these rates against the mid-year of inventory shows that the two are correlated: the more recently inventoried the forest is, the greater its turnover rate (see figure below). However, there is clearly great variation from site to site, and it is possible that ecologists have tended to choose intrinsically more dynamic forests recently. To eliminate this possibility, Phillips and Gentry also analysed all sites that each have at least three successive inventories, allowing a comparison of turnover rates across two different, successive periods. These sites are well distributed geographically (nine in the neotropics, eight in Southeast Asia, two in Africa, and two in Australia). Of these 21 sites, tree turnover rates increased in 17 (i.e. turnover in the second period was greater than in the first), and decreased at only four. Moreover, ranking all sites by the absolute magnitude of change shows that only one decreased substantially (see table below). Non-parametric statistical tests show there is less than 1 in 100 probability of obtaining these results by chance alone. Finally, in eight of nine sites where data on both tree growth rates and tree turnover are known, the relative amount of tree growth increased from the first period to the second. In other words, increased tree turnover is apparently associated with increased productivity.

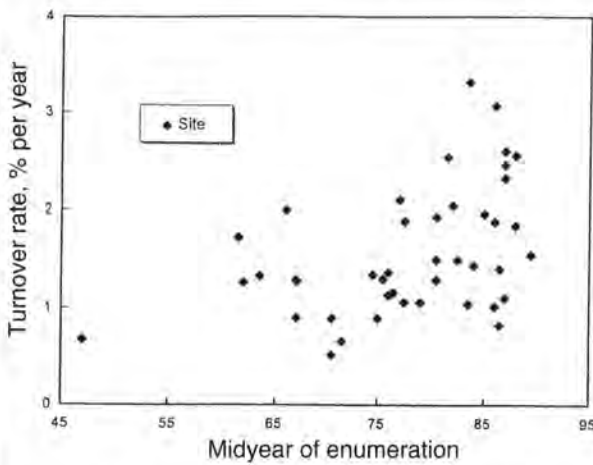

Tropical forest turnover vs time; 42 sites, Pearson's correlation coefficient $r = 0.443$, $p < 0.01$.

Unfortunately, even the database of sites with at least three inventories is far from ideal. For one, there are still not enough sites monitored closely enough for long enough to quantify the increase in turnover. For another, the sample is not yet large enough to eliminate completely a number of possible confounding local factors. Still, the consistent pattern of increased turnover suggests that regional or global environmental change is a much more likely cause, possibly as an indirect result of human activities. One regional cause may be deforestation adjacent to the sites. Although many of the increasing sites are quite isolated, in other cases deforestation close by may alter local climates and contribute to an increase in tree death. This explanation can be tested where simultaneous datasets on local climatic conditions exist, and where time-series of satellite images are available to gauge regional deforestation. However, there is only one factor known to be functionally related to plant productivity that is also known to have changed at all sites in concert with the increased turnover: atmospheric CO_2 concentrations. A global tropical forest carbon 'fertilization effect' is an attractive explanation, but a hard one to test directly.

Tropical forests are critical stores of carbon and biodiversity, and increasing turnover is likely to affect both. As trees die and replace each other faster, fast-growing light-demanding trees and vines may gain a relative advantage. Fast-growing plants have less dense wood than slow-growing trees, so mature tropical forests could ultimately act as sources, rather than sinks, of atmospheric carbon. Faster turnover may create more heterogeneous forest environments, and hence actually enhance local species richness. However, larger scale biodiversity levels could decline, with extinctions possible among the slowest growing shade-tolerant tree species and among other life-forms with life cycles tied to these trees.

It is still too early to determine just how important the impact of increasing turnover on biodiversity will be. Because of background spatial and temporal variation in forest structure, detecting even a strong effect on tree species composition will require painstaking identification of new and dying trees over long periods – a tough proposition given the shortage of suitably trained taxonomists. Climbing vines and lianas could be particular beneficiaries in high-turnover forests, yet they are almost universally ignored in permanent plots, so detecting change in the growth, survival or floristic composition of climbers will be very difficult.

However, some common-sense predictions can be made of the impact of increasing turnover on tropical biodiversity. In the short term it should be a minor factor compared to deforestation and the wholesale depletion of top

predators and vertebrate seed dispersers. But in the longer term, by altering the process by which the forest renews itself, increased turnover may threaten many species in the surviving blocks of tropical forest. It is possible that even large areas of forest may be inadequate for biodiversity conservation without simultaneously controlling atmospheric CO₂.

Turnover of trees > 10 cm diameter, in mature tropical forests with three or more inventories; where dyn = mean of measured mortality and recruitment, during *x* (first inventory period), and *y* (second inventory period).

Site	Plot area (ha)	Number of inventories	Timespan (years)	<i>x</i> ; <i>y</i>	<i>dyn_x</i>	<i>dyn_y</i>	ln (<i>dyn_y</i>) - ln (<i>dyn_x</i>)	Rank [absolute change]
Tambopata, Peru, upland	1	5	11.67	79-87; 87-91	1.07	2.74	0.94	1
Manu, Peru, alluvial	0.94	4	15.5	74-84; 84-90	1.53	2.81	0.60	2
Anangu, Ecuador, alluvial	1	3	8.5	82-85; 85-90	2.05	3.63	0.57	3
Manu, Peru, upland	0.3	3	15	74-84; 84-89	1.81	3.08	0.53	4
Bukit Lagong, Malaysia	2	14	36	49-63; 71-85	1.04	1.49	0.36	5
Yanamomo, Peru	1	4	9.75	83-89; 89-93	2.18	3.05	0.34	7
Kade, Ghana, alluvial	1	6	25	68-82; 82-93	1.66	2.26	0.31	8
Tambopata, Peru, alluvial	1	3	7.75	83-87; 87-91	2.11	2.83	0.29	9
Sungei Menyala, Malaysia	2	14	38	47-61; 71-85	1.59	2.13	0.29	10
Gajabuih, Indonesia	0.9	7	7	80-84; 84-87	2.80	3.51	0.23	11
La Selva, Costa Rica	4, 4, 4.4	3	15.5	69-82; 82-85	2.02	2.50	0.21	12
San Carlos de Rio Negro, Venezuela	1	3	10.33	75-80; 80-86	1.17	1.40	0.18	13
Queensland, metamorphic	0.2	4	12	69-76; 76-81	0.79	0.90	0.13	14
Anangu, Ecuador, upland	1.1	3	8.5	82-85; 85-90	1.75	1.96	0.12	15
Kade, Ghana, upland	1	6	25	68-82; 82-93	1.43	1.56	0.09	17
Queensland, granite	0.41	12	37.2	52-69; 69-89	0.50	0.54	0.08	18
Pinang Pinang, Indonesia	1	7	6.25	81-84; 84-87	1.34	1.43	0.07	19
Mersing, Malaysia	0.6, 0.6, 0.6, 0.6, 0.6.	5	21	64-74; 74-85	1.28	1.26	-0.02	21
Sepilok, Malaysia, alluvial	1	4	9.16	57-61; 61-66	1.76	1.70	-0.03	20
Lambir, Malaysia	0.6, 0.6, 0.6, 0.6	5	20.33	66-76; 76-86	1.44	1.31	-0.10	16
Sepilok, Malaysia, upland	1.81	5	12	56-62; 62-68	1.33	0.94	-0.34	6

Data updated June 1994.

individuals. Methods should also take into account behavioural, developmental and seasonal variation in abundances. Techniques for monitoring species are highly diverse. Censuses are important for some large and conspicuous organisms, and mark-recapture techniques may be an important means of estimating population size. Similarly, territory mapping, point counts, and transects can be valuable, particularly over a long time-period.

- Population surveys focus either on population size or on demographic aspects of population structure, the latter being particularly important in

understanding how a population is changing in the face of anthropogenic disturbance. There are many methods for estimating population size, and these are chosen according to the organism and level of accuracy required, although none of the methods is entirely satisfactory. Nevertheless, in the case of large mammals fairly accurate estimates of population size over time are often essential for their optimal management. Furthermore, for all organisms an estimation of population size is important for determining rarity or threat status. For very small populations, it is very important that their minimal viable population (MVP) be

estimated, as well as the chances of the population persisting, using population viability analysis (PVA). An important aspect of population monitoring relates to harvestable organisms. Monitoring and modelling determine optimal and sustainable utilization rates. *Red Data Books* and atlases also provide valuable long-term information on changes in rarity status.

- Remote sensing systems have become an important means of monitoring key aspects of vegetation diversity relative both to wildlife and to human populations. Each type of imagery, however, has its own uses, advantages and disadvantages. The large-scale distribution of vegetation can be determined from satellite imagery. Seasonal and multispectral imagery is useful for determining composition and condition of the overstorey. Structure and biomass usually require some height estimates and these can be obtained from stereo imagery, radar or laser profilers. Rapid updates of the condition of small areas can be done with airborne videography or digital cameras. Global positioning units are useful in linking remote sensing and field plots with a Geographic Information System. Remote sensing's quick areal coverage at relatively low cost, may, however, require supplementary information obtained on the ground.
- At the large scale, the marine environment is internally moving and three-dimensional, and presents special monitoring problems. Also at the larger scale, biotopes and ecosystems are inventoried and monitored and such ecological units are sometimes designated a name on the basis of their dominant species. Monitoring of species plays a major role in assessing changes to ecological systems over time, and thus plays a key role in management and biodiversity protection. At the broadest level, biodiversity inventories target landscapes, which are the composites of alpha, beta and gamma diversities. At this level, monitoring biodiversity and its components provides information on land-use dynamics and also on how to manage large marine ecosystems and freshwater systems.
- The inventorying of biota in protected areas, and the monitoring of their status over extended periods of time is very important. Such long-term sites, both inside and outside protected areas, will continue to provide valuable information for biodiversity conservation and management.

References

- American Association for the Advancement of Science** 1993. *Large Marine Ecosystems: Stress, mitigation, and sustainability*. AAAS Press, Washington, DC.
- Ackay, H. and Kesercioglu, T.** 1990. A systematic study of the West Anatolia Turkey lichens related to the Chernobyl USSR fallout. *Doga Muhendislik ve Cevre Bilimleri* **14**: 28–38.
- Adamo, P., Marchetiello, A. and Violante, P.** 1993. The weathering of mafic rocks by lichens. *Lichenologist* **25**: 285–297.
- Adraanse, M., van de Kraats, J., Stoks, P.G. and Ward, R.C.** 1994. *Monitoring Tailor-made. An international workshop on monitoring and assessment in water management*, September 1994. 20–23. Beekbergen, The Netherlands.
- Ahern, F.** 1994. The tropical forest initiative: analyzing the data. *Remote Sensing of Canada* **22**: 2–3.
- Amaral, M. and Morse, L.** 1990. Reintroducing the American burying beetle. *Endangered Species Technical Bulletin* **15**: 3.
- Avise, J.C.** 1994. *Molecular Markers, Natural History and Evolution*. Chapman and Hall, New York.
- Baeza, A., Miro, C., Paniagua, J.M., Navarro, E., Rodriguez, M.J. and Sanchez, F.** 1994. Natural and artificial radioactivity levels in Livingston Island (Antarctic regions). *Bulletin of Environmental Contamination and Toxicology* **52**: 117–124.
- Baillie, S.R.** 1991. Monitoring terrestrial breeding bird populations. In: Goldsmith, F.B. (ed.), *Monitoring for Conservation and Ecology*, 112–132. Chapman and Hall, London.
- Baglinière, J.L., Castanet, J., Conand, Fr. and Meunier, Fr. J.** (eds) 1992. *Tissus durs et âge individuel des vertébrés*. ORSTOM/INRA, Paris.
- de Bakker, A.J.** 1989. Effects of ammonia emissions on epiphytic lichen vegetation. *Acta Botanica Neerlandica* **38**: 337–342.
- Banks, R.C., McDiarmid, R.W. and Gardner, A.L.** 1987. *Checklist of Vertebrates of the United States, the US Territories, and Canada*. US Department of the Interior, Fish and Wildlife Service, Resource Publication.
- Barel, C.D.N., Dorit, R., Greenwood, P.H., Fryer, G., Hughes, N., Jackson, P.B.N., Kanawabe, H., Lowe-McConnell, R.H., Witte, F. and Yamaoka, K.** 1985. Destruction of fisheries in African lakes. *Nature* **315**: 19–20.
- Barr, C.J., Bunce, R.G.H., Clarke, R.T., Fuller, R.M., Furse, M.T., Gillespie, M.K., Groom, G.B., Hallam, C.J., Hornung, M., Howard, D.C. and Ness, M.J.** (eds) 1993. *Countryside Survey 1990 Main Report*. Department of the Environment, UK.
- Beattie, A.J. and Oliver, I.** 1994. Taxonomic minimalism. *Trends in Ecology and Evolution* **9**: 488–490.
- Begon, M.** 1979. *Investigating Animal Abundance: Capture-recapture for biologists*. Edward Arnold, London.
- Benson, E.A.H., Lei, T.T., Svoboda, J. and Taylor, H.W.** 1983. Fallout and natural radioactivity in the Canadian northern environment. In: Wein, R.W., Riewe, R.R. and Methven, I.R. (eds), *Resources and Dynamics of the Boreal Zone*. 465–479. Association of Canadian Universities for Northern Studies, Ottawa.
- Bianchi, M. and Colwell, R.R.** 1986. Microbial indicators of environmental water quality: the role of microorganisms in the assessment and prediction of changes in the marine

- environment induced by human activities. In: Salanki, J. (ed.), *Biological Monitoring of the State of the Environment: Bioindicators*. IUBS Monograph Series No. 1. 5–15. IRL Press, Oxford.
- Biazrov, L.G.** 1994. The radionucleotides in lichen thalli in Chernobyl and East Urals areas after nuclear accidents. *Phyton* **34**: 85–94.
- Bibby, C.J., Burgess, N.D. and Hill, D.A.** 1992. *Bird Census Techniques*. Academic Press, New York.
- Bied-Charreton, M.** (in press). Presentation of the Programme AFRICOVER and FAO's remote sensing and GIS activities; In: *Proceedings – AFRICAGIS '95*, 6–10 March 1995, Abidjan, Côte de Ivoire.
- Bisset, C. and Farmer, A.** 1994. The use of critical load maps to assess the effects of sulphur dioxide pollution control policies on nature conservation sites in Britain. *Journal of Environmental Planning and Management* **37**: 145–153.
- Bobbe, T.J.** 1992. Real-time differential GPS for aerial surveying and remote sensing. *GPS World*, July/August: 18–22.
- Bobbe, T.J., Reed, D. and Schramek, J.** 1993. Georeferenced airborne video imagery, natural resource applications on the Tongass. *Journal of Forestry* **91** (8): 34–37.
- Bobbe, T.J., Hoppus, M.L. and Evans, D.T.** 1994. The evaluation of a small format digital camera for aerial surveys. In: Greer, J. (ed.), *Proceedings of the Fifth Biennial USDA Forest Service Remote Sensing Application Conference*, 11–15 April 1994, Portland, Oregon. 278–282 American Society for Photogrammetry and Remote Sensing, Bethesda, md.
- Boshoff, A.F., Robertson, A.S. and Norton, P.M.** 1984. A radio-tracking study of an adult Cape Griffon vulture *Gyps coprotheres* in the south-western Cape Province. *South African Journal of Wildlife Research* **14**: 73–78.
- Bothma, J. du P. and Le Riche, A.N.** 1984. Aspects of the ecology and behaviour of the leopard *Panthera pardus* in the Kalahari Desert. *Koedoe* (Suppl.) **27**: 259–279.
- Boyce, M.S.** 1992. Population viability analysis. *Annual Review of Ecology and Systematics* **23**: 481–506.
- Bridson, D.B., and Foreman, L.** 1992. *The Herbarium Handbook*, revised edition. Royal Botanic Gardens, Kew.
- Brokaw, N.V.L. and Mallory, E.P.** 1995. Plot studies and vegetation mapping in Northwest Belize. In: *SI/MAB Proceedings, Measuring and Monitoring Forest Biological Diversity: The international network of biodiversity plots*, 23–25 May 1995. Smithsonian Institution, Washington, DC. (in press).
- Brown, D.H.** 1972. The effect of Kuwait crude oil and a solvent emulsifier on the metabolism of the marine lichen *Lichina pygmaea*. *Marine Biology* **12**: 309–315.
- Brown, D.H.** 1973. Toxicity studies of the components of an oil-spill emulsifier using *Lichina pygmaea* and *Xanthoria parietina*. *Marine Biology* **18**: 291–297.
- Brown, D.H.** 1992. Impact of agriculture on bryophytes and lichens. In: Bates, J.W. and Farmer, A.M. (eds), *Bryophytes and Lichens in a Changing Environment*, 259–283. Clarendon Press, Oxford.
- Brown, K.S.** 1991. Conservation of neotropical environments: insects as indicators. In: Collins, N.M. and Thomas, J.A. (eds), *The Conservation of Insects and their Habitats*. 350–404. Academic Press, London.
- Buckland, S.T., Anderson, D.R., Burnham, K.P. and Lake, J.L.** 1993. *Distance Sampling: Estimating abundance of biological populations*. Chapman and Hall, London.
- Budd, J.T.C.** 1991. Remote sensing techniques for monitoring land-cover. In: Goldsmith, F.B. (ed.), *Monitoring for Conservation and Ecology*. 33–59. Chapman and Hall, London.
- Buttermore, R.E., Turner, E. and Morrice, M.G.** 1994. The introduced northern Pacific sea-star *Asterias amurensis* in Tasmania. *Memoirs of the Queensland Museum* **36**: 21–25.
- Cairns, J.Jr** 1971. Factors affecting the number of species in fresh-water protozoan communities. In: Cairns, J.Jr (ed.), *The Structure and Function of Fresh-Water Microbial Communities*. Research Division Monograph 3. 219–248. Virginia Polytechnic Institute and State University, Blacksburg, Va.
- Cairns, J.Jr and Pratt, J.R.** 1993. A history of biological monitoring using benthic macroinvertebrates. In Rosenberg, D.M. and Resh, V.H. (eds), *Freshwater Biomonitoring and Benthic Macroinvertebrates*. 10–27. Chapman and Hall, New York.
- Callow, N. and Petts, G.E.** (eds) 1992. *The Rivers Handbook: Hydrological and ecological principles*. Blackwell Scientific Publications, Oxford.
- Carr, B.** 1993. How to use laser technology to measure tree heights and survey stand boundaries. In: Lund, H.G., Landis, E. and Atterbury, T. (eds), *Stand Inventory Technologies 92. Proceedings of the Stand Inventory Technologies – an international multiple resource conference*, 13–17 September 1992, 249–258, Portland, Oregon. American Society for Photogrammetry and Remote Sensing, Bethesda, Md.
- di Castri, F., Hansen, A.J. and Debussche, M.** (eds) 1990. *Biological Invasions in Europe and the Mediterranean Basin*. Kluwer Academic Publishers, Dordrecht.
- di Castri, F., Robertson Vernhes, J. and Younès, T.** (eds) 1992. Inventorying and monitoring biodiversity: a proposal for an international network. *Biology International Special Issue* **27**: 1–28.
- Caswell, H.** 1989. *Matrix Population Models: Construction, analysis and interpretation*. Sinauer Associates, Sunderland, Mass.
- Caughley, G.** 1994. Directions in conservation biology. *Journal of Animal Ecology* **63**: 215–244.
- Chiverton, P.A. and Sotherton, N.W.** 1991. The effects on beneficial arthropods of the exclusion of herbicides from cereal crop edges. *Journal of Applied Ecology* **28**: 1027–1039.
- Cochran, W.G.** 1977. *Sampling techniques*, 3rd edn. John Wiley, New York.
- Coddington, J., Hammond, P.M., Oliveri, S., Robertson, J., Sokolov, V., Stork, N.E. and Taylor, E.** 1991. Monitoring and inventorying biodiversity from genes to ecosystems. In: Solbrig, O. (ed.), *From Genes to Ecosystems: A recent agenda for biodiversity*. 83–117. IUBS, Paris.
- Coddington, J.A., Griswold, C.E., Silva, D., Pearandra, E. and Larcher, S.F.** 1992. Designing and testing sampling protocols to estimate biodiversity in tropical ecosystems. In: Dudley, E.C. (ed.), *The Units of Evolutionary Biology: Proceedings of the International Congress of systematic and evolutionary biology*. Dioscorides Press, College Park, Md.
- Condit, R.** 1995. Research in large, long-term tropical forest plots. *Trends in Ecology and Evolution* **10**: 18–22.

- Cotterill, F.P.D.** 1995. Systematics, biological knowledge and environmental conservation. *Biodiversity and Conservation* **4**: 183–205.
- Cracraft, J.** 1991. Patterns of diversification within continental biotas: hierarchical congruence among the areas of endemism of Australian vertebrates. *Australian Systematic Botany* **4**: 211–227.
- Crawford, R.J.M., Shannon, L.V. and Shelton, P.A.** 1989. Characteristics and management of the Benguela as a large marine ecosystem. In: Sherman, K. and Alexander, L.M. (eds), *Biomass Yields and Geography of Large Marine Ecosystems*. AAAS Selected Symposium 111. 169–219. Westview Press, Boulder, Colorado.
- Cropper, S.** 1993. *Management of Endangered Plants*. CSIRO Publications, Melbourne.
- Crump, M.L. and Scott, N.J.Jr** 1994. Visual Encounter Surveys. In: Heyer, W.R., Donnelly, M.A., McDiarmid, R.W., Hayek, L.C. and Foster, M.S. (eds), *Measuring and Monitoring Biological Diversity: Standard methods for amphibians*. 84–92. Smithsonian Institution Press, Washington, DC.
- Dallmeier, F.** (ed.) 1992. *Long-term Monitoring of Biological Diversity in Tropical Areas: Methods for establishment and inventory of permanent plots*. MAB Digest 11. UNESCO, Paris.
- Davis, S.D., Droop, S.J.M., Gregerson, P., Henson, L., Leon, C.J., Villa-Lobos, J.L., Syngé, H. and Zantovska, J.** 1986. *Plants in Danger: What do we know?* IUCN, Gland.
- Dempster, J.P.** 1975. *Animal Population Ecology*. Academic Press, London.
- De Villiers, P.A., Pietersen, E.W., Hugo, T.A., Meissner, H.H. and Kok, O.B.** 1991. Method of sampling food consumption by free-ranging elephant. *South African Journal of Wildlife Research* **21**: 23–27.
- Dobson, M.C., Ulaby, F.T., LeTon, T., Beaudoin, A., Kasischke, E.S., Christensen, N.** 1992. Dependence of radar backscatter on coniferous forest biomass. *IEEE Trans. Geosc. and Remote Sensing* **30** (2): 412–415.
- Dover, J.W.** 1991. The conservation of insects on arable farmland. In: Collins, N.M. and Thomas, J.A. (eds), *The Conservation of Insects and their Habitats*. 293–318. Academic Press, London.
- Drake, J.A., di Castri, F., Groves, R.H., Kruer, F.J., Mooney, H.A., Rejmanek, M. and Williamson, M.** (eds) 1989. *Biological Invasions: A global perspective*. John Wiley, Chichester.
- Drichi, P.** 1994. The inception of monitoring woody biomass resources in Uganda–Jinja Peri-urban area as case study. In: Singh, A. (ed.), *UNEP and IUFRO International Workshop in cooperation with FAO on developing large environmental data bases for sustainable development*, 14–16 July 1993. Grid Information Series, No. 22. 235–243. UNEP, Nairobi.
- Dumont, H.J., Green, J. and Masundire, H.** 1994. Studies on the ecology of tropical zooplankton. *Developments in Hydrobiology* **92**. Kluwer, Dordrecht.
- Eislöffel, F., Niehuis, M. and Weitzel, M.** 1993. *Rote Liste der Bestandsgefährdeten Libellen (Odonata) in Rheinland-pfalz*. Ministerium für Umwelt, Mainz.
- Eldridge, D.J. and Bradstock, R.A.** 1994. The effect of time since fire on the cover and composition of cryptogamic soil crusts on a eucalypt shrubland soil. *Cunninghamia* **3**: 521–527.
- Elliott, J.M.** 1977. *Some Methods for the Statistical Analysis of Samples of Benthic Invertebrates*. Freshwater Biological Association, Ambleside, UK.
- Elliot, C.C.H., Waltner, M., Underhill, L.G., Pringle, J.S. and Dick, W.J.A.** 1976. The migration system of the curlew sandpiper, *Calidris ferruginea*, in Africa. *Ostrich* **47**: 191–213.
- Escalante-Pliego, P.** (ed.) 1993. *Curación Moderna de Colecciones Ornitológicas*. American Ornithologists' Union, Washington, DC.
- Etayo Salazar, J. and Gómez-Bolea, A.** 1992. Estabilidad ecológica por medio de bioindicadores liquénicos en robledales de los Pirineos atlánticos. *Folia Botanica Miscellanea* **8**: 61–75.
- Evans, D.L. and Beltz, R.** 1992. Aerial video for support of forest inventory. In: *Proceedings of the 3rd Biennial Workshop on Color Aerial Photography and Videography in the Plant Sciences*, 192–198, Orlando, Fla. American Society for Photogrammetry and Remote Sensing, Bethesda, Md.
- Eyre, M.D. and Rushton, S.P.** 1989. Quantification of conservation criteria using invertebrates. *Journal of Applied Ecology* **26**: 159–171.
- Fahselt, D.** 1993. UV absorbance by thallus extracts of umbilicate lichens. *Lichenologist* **25**: 415–422.
- Food and Agriculture Organization** 1995. *Forest Resources Assessment 1990: Global Synthesis*. FAO Forestry Paper 124. FAO, Rome.
- Farmer, A.M., Bates, J.W. and Bell, J.N.** 1992. Ecophysiological effects of acid rain on bryophytes and lichens. In: Bates, J.W. and Farmer, A.M. (eds), *Bryophytes and Lichens in a Changing Environment*. 284–313. Clarendon Press, Oxford.
- Ferrar, A.A.** 1989. The role of Red Data Books in conserving biodiversity. In: Huntley, B.J. (ed.), *Biotic Diversity in Southern Africa*. 136–147. Oxford University Press, Cape Town.
- B, R.T.T. and Gordon, M.** 1986. *Landscape Ecology*. John Wiley, New York.
- Franklin, J.F., Bledsoe, C.S. and Callahan, J.T.** 1990. Contributions of the long-term ecological research program. *BioScience* **40** (7): 502–508.
- Gadagkar, R., Chandrashekara, K., and Nair, P.** 1990. Insect species diversity in the tropics: sampling methods and a case study. *Journal of the Bombay Natural History Society* **87**: 337–353.
- Galloway, D.J.** 1993. Global environmental change: lichens and chemistry. *Bibliotheca Lichenologica* **53**: 87–95.
- Garthy, J.** 1993. Lichens as bioindicators for heavy metal pollution. In: Markert, B. (ed.), *Plants as Biomonitors: Indicators for heavy metals in the terrestrial environment*, 193–263. VCH, Weinheim, Germany.
- Gaston, K.** 1994. *Rarity*. Chapman and Hall, London.
- Gaston, K.J. and McArdle, B.H.** 1993. All else is not equal: temporal population variability and insect conservation. In: Gaston K.J., New T.R. and Samways, M.J. (eds), *Perspectives on Insect Conservation*. Intercept, Andover, UK.
- Gauslaa, Y.** 1995. The Lobarion, an epiphytic community of ancient forests threatened by acid rain. *Lichenologist* **27**: 59–76.
- Getz, W.M. and Haight, R.G.** 1989. *Population Harvesting*. Monographs in Population Biology No. 27. Princeton University Press, Princeton, NJ.

- Gillespie, A.J.R.** 1992. Tropical forest inventories: status and trends. In: *American Forestry – An evolving tradition*. Proceedings of the Society of American Foresters National Convention, 25–27 October 1992, Richmond, Va. 67–71. Society of American Foresters, Bethesda, Md.
- Gillison, A.N.** 1981. Towards a functional vegetation classification. In: Gillison, A.N. and Anderson, D.J. (eds), *Vegetation Classification in Australia*. 30–41. CSIRO, Australian National University Press, Canberra.
- Gilyarov, M.S. and Striganova, B.R.** 1987. *Quantitative Methods in Soil Zoology*. Nauka, Moscow.
- Giri, C.P. and Shrestha, S.** (in press). Land cover assessment and monitoring at UNEP/EAPAP: a RS and GIS approach. In: *Proceedings expert consultation on forest resources monitoring systems*, 27 February–3 March 1995. FAO/RAPA, Bangkok, Thailand.
- Given, D.R.** 1994. *Principles and Practice of Plant Conservation*. Timber Press and Chapman and Hall, New York.
- Glenn, M.G., Gómez-Bolea, A. and Lobello, R.** 1995. Metal content and community structure of cryptogam bioindicators in relation to vehicular traffic in Montseny Biosphere Reserve (Catalonia, Spain). *Lichenologist* **27**: 291–304.
- Glowka, L., Burhenne-Guilmin, F. and Synge, H.** 1994. *A Guide to the Convention on Biological Diversity*. IUCN, Gland.
- Goldsmith, B.** (ed.) 1991. *Monitoring for Conservation and Ecology*. Chapman and Hall, London.
- Goodman, D.** 1987. The demography of chance extinction. In: Soulé M.E. (ed.), *Viable Populations for Conservation*. 11–34. Cambridge University Press, Cambridge.
- Goodman, S.M. and Lanyon, S.M.** 1994. Scientific collecting. *Conservation Biology* **8**: 314–315.
- Gordon, C.A., Herrera, R. and Hutchinson, T.C.** 1995. The use of a common epiphytic lichen as bioindicator of atmospheric inputs to two Venezuelan cloud forests. *Journal of Tropical Ecology* **11**: 1–26.
- Gregory, K.J.** 1976. Lichens and the determination of river channel capacity. *Earth Surface Processes* **1**: 273–285.
- Greig-Smith, P.** 1983. *Quantitative Plant Ecology*. Blackwell Scientific, London.
- Groenendael, J.M. van, de Kroon, H. and Caswell, H.** 1988. Projection matrices in population biology. *Trends in Ecology and Evolution* **3**: 264–269.
- Groves, R.H. and Burdon, J.J.** (eds) 1986. *Ecology of Biological Invasions*. Cambridge University Press, Cambridge.
- Gueye, S.** 1993. Concise description of the Senegal forest inventory situation. Abstract. In: Nyssönen, A. (ed.), *Proceedings of FAO/ECE meeting of experts on global forest resources assessment in cooperation with the support of FINNIDA (Kotka II)*. 3–7 May 1993, Kotka, Finland. Research Paper 469. Finnish Forest Research Institute, Helsinki.
- Gwynne, M.D. and Croze, H.** 1980. The concept and practice of ecological monitoring over large areas of land: the systematic reconnaissance flight (SRF). In: *UNEP, The Global Environment Monitoring System*. GEMS PAC Information Series No. 1.
- Hafernik, J.E.J.** 1992. Threats to invertebrate biodiversity: implications for conservation strategies. In: Fielder, P.L. and Jain, S.K. (eds), *Conservation Biology: The theory and practice of nature conservation, preservation and management*. 172–195. Chapman and Hall, New York.
- Hale, M.E.** 1984. The lichen line and high water levels in a freshwater stream in Florida. *The Bryologist* **87**: 261–265.
- Hammond, P.M.** 1994. Practical approaches to the estimation of the extent of biodiversity in speciose groups. *Philosophical Transactions of the Royal Society London, B* **345**: 119–136.
- Hawksworth, D.L. and McManus, P.M.** 1989. Lichen recolonization in London under conditions of rapidly falling sulphur dioxide, and the concept of zone skipping. *Botanical Journal of the Linnean Society* **100**: 99–109.
- Hawksworth, D.L. and Ritchie, J.M.** 1993. *Biodiversity and Biosystematic Priorities: Microorganisms and invertebrates*. CAB International, Wallingford.
- Hawksworth, D.L. and Rose, F.** 1970. Qualitative scale for estimating sulphur dioxide in England and Wales using epiphytic lichens. *Nature* **227**: 145–148.
- Hayek, L.C.** 1994a. Research design for quantitative amphibian studies. In: Heyer, W.R., Donnelly, M.A., McDiarmid, R.W., Hayek, L.C. and Foster, M.S. (eds), *Measuring and Monitoring Biological Diversity: Standard methods for amphibians*. 21–39. Smithsonian Institution Press, Washington, DC.
- Hayek, L.C.** 1994b. Research design for quantitative amphibian studies. In: Heyer, W.R., Donnelly, M.A., McDiarmid, R.W., Hayek, L.C. and Foster, M.S. (eds), *Measuring and Monitoring Biological Diversity: Standard methods for amphibians*. 313–323. Smithsonian Institution Press, Washington, DC.
- Hedberg, C.** 1994. Development of a large scale forest national database of Uganda. In: Singh, A. (ed.), *UNEP and IUFRO International workshop in cooperation with FAO on developing large environmental data bases for sustainable development*. 14–16 July 1993. Grid Information Series No. 22. 226–234. UNEP, Nairobi.
- Henderson, A.** 1995. Literature on air pollution and lichens XLI. *Lichenologist* **27**: 225–234 [literature compilation produced twice a year; part I issued in 1974].
- Herholdt, E.M.** (ed.) 1990. *Natural History Collections: Their management and value*. Transvaal Museum, Special Publication 1.
- Heyer, W.R., Donnelly, M.A., McDiarmid, R.W., Hayek, L.C. and Foster M.S.** (eds) 1994. *Measuring and Monitoring Biological Diversity: Standard methods for amphibians*. Smithsonian Institution Press, Washington, DC.
- Hoffman, M.T.** 1993. The potential value of historical ecology to environmental monitoring. In: Marais, C. and Richardson D.M. (eds), *Monitoring Requirements for Fynbos Management*. FRD Programme Series No. 11. 69–86. Foundation for Research Development, Pretoria.
- Holloway, J.D.** 1994. The relative vulnerabilities of moth higher taxa to habitat change in Borneo. In: Foray, P.L., Humphries, C.J. and Vane-Wright, R.I. (eds), *Systematics and Conservation Evaluation*. The Systematics Association Special Volume No. 50. 197–205. Oxford University Press, Oxford.
- Hubbell, S.P. and Foster, R.B.** 1983. Diversity of canopy trees in a neotropical forest and implications for conservation. In: Sutton, S.L., Whitmore, T.C. and Chadwick, A.C. (eds), *Tropical Rain Forest: Ecology and management*. 24–41. Blackwell Scientific Press, Oxford.

- Huntley, B.J.** 1988. Conserving and monitoring biotic diversity: some African examples. In: Wilson E.O. and Peter F.M. (eds), *Biodiversity*. 248–260. National Academy Press, Washington, DC.
- Husch, B.** 1978. *Planning a Forest Inventory*. FAO Forestry Series 4. Forestry and Forest Products Studies 17. FAO, Rome.
- Hussin, Y.A., Reich and R.M., Hoffer, R.M.** 1992. Affect of polarization of radar backscatter in relation to slash pine stand biomass using aircraft SIR-B data. In: *Proceedings ASPRS/ASCM/RT 92 Technical Papers Volume 5 – Resource Technology 92*. 192–198. American Society for Photogrammetry and Remote Sensing, Bethesda, Md.
- International Council for Bird Preservation** 1992. *Putting Biodiversity on the Map: Priority areas for global conservation*. ICBP, Cambridge, UK.
- International Union for Conservation of Nature and Natural Resources** 1990. *1990 IUCN Red Data Book*. IUCN, Gland.
- IUCN** 1994. *IUCN Red List Categories*. IUCN, Gland.
- Iremonger, S. and Sayer, R.** 1994. *Rapid Ecological Assessment: Bladen Nature Reserve, Belize*. The Nature Conservancy, Latin America and Caribbean Program, Arlington, Va.
- Janzen, D.H. and Hallwachs, W.** 1994. *All Taxa Biodiversity Inventory (ATBI) of Terrestrial Systems. A generic protocol for preparing wildland biodiversity for non-damaging use*. Draft Report of a National Science Foundation Workshop, 16–18 April 1993, Philadelphia, Pa.
- Järvinen, O. and Väisänen, R.A.** 1975. Estimating relative densities of breeding birds by the line transect method. *Oikos* **26**: 316–322.
- Jordan, W.R. III, Gilpin, M.E. and Aber, J.D.** (eds) 1987. *Restoration Ecology: A synthetic approach to ecological research*. Cambridge University Press, Cambridge.
- Jorgensen, S.E.** 1980. *Lake Management*. Pergamon Press, Oxford.
- Joubert, S.C.J.** 1983. A monitoring programme for an extensive national park. In: Owen-Smith R.N. (ed), *Management of Large Mammals in African Conservation Areas*, 201–212. Haum, Pretoria.
- Kelleher, G.** 1993. Sustainable development of the great barrier reef on a large marine ecosystem. In: Sherman, K., Alexander, L.M. and Gold, B.D. (eds), *Large Marine Ecosystems: Stress, mitigation and sustainability*. 272–279. AAAS Press, Washington, DC.
- Kershaw, K.A.** 1973. *Quantitative and Dynamic Plant Ecology*, 2nd edn. Edward Arnold, London.
- Kesseli, R.V.** 1992. Population biology and conservation of rare plants. In: Jain, S.K. and Botsford, L.W. (eds), *Applied Population Biology*. 69–90. Kluwer Academic Publishers, Dordrecht.
- Kochummen, K.M., LaFrankie, J.V. and Manokaran, N.** 1990. Floristic composition of Pasoh Forest Reserve, a lowland rain forest in Peninsular Malaysia. *Journal of Tropical Forest Science* **3**: 1–13.
- Koskimies, P. and Väisänen, R.A.** 1986. *Monitoring Bird Populations: A manual of methods applied in Finland*. Finnish Museum of Natural History, University of Helsinki, Helsinki. [English version 1991].
- Kozuharov, S.I.** 1986. Plants as bioindicators. In: Salanki, J. (ed.) *Biological Monitoring of the State of the Environment: Bioindicators*. 17–25. IUBS Monograph Series No. 1. IRL Press, Oxford.
- Krebs, C.J.** 1989. *Ecological Methodology*. Harper and Row, New York.
- Kremen, C., Colwel, R.K., Erwin, T.L., Murphy, D.D., Noss, R.F. and Sanjayan, M.A.** 1993. Terrestrial arthropod assemblages: their use in conservation planning. *Conservation Biology* **7**: 796–808.
- Lachowski, H.** 1990. *Report to the Remote Sensing Steering Committee*. Remote Sensing Working Group Notes. Unpublished Report. Salt Lake City, Utah: Nationwide Forestry Applications Program. Integration of Remote Sensing.
- Lacy, R.C. and Kreeger, T.** 1992. *VORTEX Users Manual. A stochastic simulation of the extinction process*. Captive Breeding Specialist Group, Species Survival Commission, IUCN, Apple Valley, Minnesota.
- Landres, P.B., Verner, J. and Thomas, J.W.** 1988. Ecological uses of vertebrate indicator species: a critique. *Conservation Biology* **2**: 316–328.
- Lasserre, P.** 1992. The role of biodiversity in marine ecosystems. In: Solbrig, O.T., van Emden, H.M and van Oordt, P.G.W.J. (eds), *Biodiversity and Global Change*. 105–130. IUBS, Paris.
- Lawrey, J.D.** 1991. The species-area curve as an index of disturbance in saxicolous lichen communities. *Bryologist* **94**: 377–382.
- Lawrey, J.D.** 1993. Lichens as monitors of pollutant elements at permanent sites in Maryland and Virginia. *Bryologist* **96**: 339–341.
- Leckie, D.G.** 1990. Synergism of synthetic aperture radar and visible/infrared data for forest type discrimination. *Photogramm. Engr. and Remote Sensing* **56** (9): 1237–1246.
- Lockwood, J.A. and De Brey, L.D.** 1990. A solution for the sudden and unexplained extinction of the Rocky Mountain Grasshopper (Orthoptera: Acrididae). *Environmental Entomology* **19**: 1194–1205.
- Louw, G.N. and Seely, M.K.** 1982. *Ecology of Desert Organisms*. Longman, New York.
- Lucas, G. and Syngé, H.** 1978. *The IUCN Plant Red Data Book*. IUCN, Gland.
- Ludwig, J.A. and Reynolds, J.F.** 1988. *Statistical Ecology: A Primer on Methods and Computing*. John Wiley, New York.
- Lund, H.G.** 1986. *A Primer on Integrating Resource Inventories*. General Technical Report WO–49. US Department of Agriculture, Forest Service, Washington, DC.
- Lund, H.G.** 1988. From here to there (or anywhere?). In: Greer, J.D. (ed.), *Proceedings of the Second Forest Service Remote Sensing Applications Conference: Remote sensing for resource inventory, planning, and monitoring*. 11–15 April 1988, Slidell, Louisiana and NSTL, Mississippi. 38–47. American Society for Photogrammetry and Remote Sensing, Bethesda, Md.
- Lund, H.G.** 1993. Great expectations and the year 2000 global assessment. In: Nyyssönen, A (ed.), *Proceedings, FAO/ECE meeting of experts on Global Forest Resource Assessment*, 3–7 May 1993, Kotka, Finland. Research Paper 469. 150–153. Finnish Forest Research Institute, Helsinki, Finland.
- Lund, H.G.** 1995. The far side of integrating resource inventories – people and politics. In: Köhl, M., Bachmann, P., Brassel, P.

- and Preto, G. (eds), *The Monte Verita' Conference on Forest Survey Designs. 'Simplicity versus Efficiency' and assessment of non-timber resources*, 2–7 May 1994, Monte Verita, Ascona, Switzerland. 11–26. Swiss Federal Institute for Forest, Snow and Landscape Research, Birmensdorf.
- Lund, H.G. and Thomas, C. E.** 1989. *A Primer on Stand and Forest Inventory Designs*. General Technical Report WO-54. US Department of Agriculture; Forest Service, Washington, DC.
- Lund, H. G. and Thomas, C. E. (Coords.)** 1995. *A primer on Evaluation and Use of Natural Resource Information for Corporate Data Bases*. General Technical Report WO-62. US Department of Agriculture, Forest Service, Washington, DC.
- Lund, H.G. and Wigton, W.H.** (in press). A primer for designing multiple resource inventory and monitoring programs in the tropics. In: *Proceedings, AIFM International Conference on multiple resource inventory and monitoring of tropical forests*, 21–24 November 1994, Kuala Lumpur, Malaysia. ASEAN Institute of Forest Management, Seremban, Malaysia.
- Lund, H.G., Evans, D.L. and Linden, D.S.** (in press). Scanned, zapped, timed and digitized – advanced technologies for measuring and monitoring vegetation. In: *IUFRO Symposium – measuring and monitoring biodiversity in tropical and temperate forests*. 28 August–3 September 1994, Chaing Mai, Thailand.
- Lund, H.G., Rudis, V. and Stolte, K.** (in press). Plots, pixels, and partnerships: potential for modelling, mapping and monitoring biodiversity. In: *Proceedings, SI/MAB International Workshop measuring forest biodiversity*, 23–25 May 1995, Smithsonian Institution, Washington, DC.
- McKenzie, N.L., Belbin, D.L., Margules, C.R. and Keighery, G.J.** 1989. Selecting representative reserve systems in remote areas: a case study of the Nullarbor region, Australia. *Biological Journal of Linnean Society* **20**: 115–135.
- McKenzie, N.L., Robinson, A.C. and Belbin, D.L.** 1991. Biogeographic survey of the Nullarbor district, Australia. In: Margules, C.R. and Austin, M.P. (eds), *Nature Conservation: Cost Effective Biological Surveys and Data Analysis*. 109–126. CSIRO Division of Wildlife and Ecology, Canberra.
- Macdonald, I.A.W.** 1992. Global change and alien invasions: Implications for biodiversity and protected area management. In: Solbrig, O.T., van Emden, H.M. and van Oordt, P.G.W.J. (eds), *Biodiversity and Global Change*. 197–207. IUBS, Paris.
- Macdonald, I.A.W., Kruger, F.J. and Ferrar, A.A.** (eds) 1986. *The Ecology and Control of Biological Invasions in Southern Africa*. Oxford University Press, Cape Town.
- Macdonald, I.A.W., Loope, L.L., Usher, M.B. and Hamman, O.** 1989. Wildlife conservation and the invasion of nature reserves by introduced species: a global perspective. In: Drake, J.A. et al. (eds), *Biological Invasions: A global perspective*. 257–280. John Wiley, Chichester.
- Mace, G.M. and Lande, R.** 1991. Assessing extinction threats: toward a reevaluation of IUCN threatened species categories. *Conservation Biology* **5**: 148–157.
- Mace, G. and Stuart, S.** 1994. Draft IUCN Red List Categories, Version 2.2. Species Nos. **21–22**: 13–24.
- Magurran, A.E.** 1988. *Ecological Diversity and its Measurement*. Croom Helm, London.
- Magnuson, J.J.** 1990. Long-term ecological research and the invisible present. *BioScience* **40** (7): 495–523.
- Magnuson, J.J., Benson, B.J. and McLain, A.S.** 1994. Insights on species richness and turnover from long-term ecological research: Fishes in north temperate lakes. *American Zoologist* (in press.)
- Majer, J.D.** 1987. *The Role of Invertebrates in Conservation and Biological Survey*. Department of Conservation and Land Management of Western Australia, Perth.
- Majer, J., Recher, H.F. and Postle, A.C.** 1994. Comparison of arthropod species richness in eastern and western Australian canopies: a contribution to the species number debate. *Memoirs of the Queensland Museum* **36**: 121–131.
- Mamo, A., King, G., St-Pierre, L. and Tilimo, S.** 1994. Woody biomass inventory and strategic planning in Ethiopia. In: *Proceedings GIS '94*, February 1994. 93–115. Vancouver, British Columbia.
- Manokaran, N., LaFrankie, J.V., Kochummen, K.M., Quah, E.S., Klahn, J.R., Ashton P.S. and Hubbell, S.P.** 1990. *Methodology for the fifty hectare research plot at Pasoh Forest Reserve*. Research Pamphlet No. 104. Forest Research Institute Malaysia, Kepong.
- Manokaran, N., LaFrankie, J.V., Kochummen, K.M., Quah, E.S., Klahn, J.F., Ashton P.S. and Hubbell, S.P.** 1992. *Stand table and distribution of species in the 50-ha research plot at Pasoh Forest Reserve*. FRIM Research Data No. 1. Forest Research Institute Malaysia, Kepong.
- Margules, C.R. and Austin, M.P.** (eds) 1991. *Nature Conservation: Cost effective biological surveys and data analysis*. CSIRO Division of Wildlife and Ecology, Canberra.
- Marshall, J.A. and Haes, E.C.M.** 1988. *Grasshoppers and Allied Insects of Great Britain and Ireland*. Harley, Colchester, UK.
- May, R.M.** 1990. Taxonomy as destiny. *Nature* **347**: 129–130.
- Meester, J.** 1990. The importance of retaining voucher specimens. In: Herholdt, E.M. (ed.), *Natural History Collections: Their management and value*. 123–127. Transvaal Museum Special Publications, No. 1.
- Meher-Homji, V.M.** 1971. Ecological climatography and vegetation cartography. In: Mishra, R. and Das, R.R. (eds), 26–42. *Proc. School of Plant Ecology*.
- Mgeni, A.S.** 1990. Forest resources assessments in Tanzania: current inventory and monitoring methods applied, problems and possible futurology. In: Lund, H.G. and Preto, G. (eds), *Proceedings, Global Natural Resource Monitoring and Assessments: Preparing for the 21st century*, 24–30 September 1989. 546–556. American Society for Photogrammetry and Remote Sensing, Bethesda, Md.
- Miller, E.H.** 1993. Biodiversity research in museums: a return to basics. In: Fenger, M.A., Miller, E.H., Johnson J.F. and Williams, E.J.R. (eds), *Our Living Legacy: Proceedings of a Symposium on Biological Diversity*. 141–173. Royal British Columbia Museum, Victoria.
- Miller, E.H. and Nagorsen, D.W.** 1992. Voucher specimens: an essential component of biological surveys. In: Ramsey, L.R. (ed.), *Methodology for Monitoring Wildlife Diversity in British Columbia Forests*. 11–15. British Columbia Ministry of Environment, Wildlife Branch, Victoria.
- Mizoue, N. and Masutani, T.** 1993. Application of fractal dimension to quantifying form of tree crowns. In: *Proceedings*

- of the IUFRO Conference on Advancement in forest inventory and forest management sciences, 20–25 September 1993. 133–138. Forestry Research Institute, Seoul, Korea.
- Moritz, C.** 1994. Defining 'Evolutionarily Significant Units' for Conservation. *Trends in Ecology and Evolution* **9**: 373–375.
- Morrison, M.C.** and Marcot, B.G. 1994. An evaluation of resource inventory and monitoring program used in national forest planning. *Environmental Management* **19**: 147–156.
- Morse, L.E.** and Henifin, M.S. (eds) 1981. *Rare Plant Conservation: Geographical data organization*. New York Botanical Garden, New York.
- Mueller-Dombois, D.** and Ellenberg, H. 1974. *Aims and Methods of Vegetation Ecology*. John Wiley, New York.
- Munthali, S.M.** and Mughogho, D.E.C. 1992. Economic incentives for conservation: bee keeping and Saturniidae caterpillar utilization by rural communities. *Biodiversity and Conservation* **1**: 143–154.
- Myhre, R.J.,** Graham, L. and Sumpter, C. 1991. Airborne videography – a potential tool for resource managers. In: *Proceedings of Resource Technology 90*. 12–15 November, 1990, Washington, DC. 591–594. American Society for Photogrammetry and Remote Sensing, Bethesda, Md.
- Nash, T.H. III** and Wirth, V. (eds). 1988. *Lichens, Bryophytes and Air Quality* [Bibliotheca Lichenologica 30.] J. Cramer, Berlin.
- Naveh, Z.** and Lieberman, A.S. 1990. *Landscape Ecology: Theory and application*, student edn. Springer-Verlag, New York.
- New, T.R.** 1994. *Exotic Insects in Australia*. Gleneagles, Adelaide.
- New, T.R.** and Collins, N.M. 1991. *Swallowtail Butterflies: An Action Plan for Their Conservation*. IUCN, Gland.
- Nixon, P.R.,** Escobar, D.E. and Menges, R.M. 1985. Use of multiband video system for quick assessment of vegetal conditions and discrimination of plant species. *Remote sensing of the Environment* **17**: 203–208.
- Norton, P.M.** and Henley, S.R. 1987. Home range and movements of male leopards in the Cedarberg Wilderness Area, Cape Province. *South African Journal of Wildlife Research* **17**: 41–48.
- Norton, P.M.** and Lawson, A.B. 1985. Radio tracking of leopards and caracals in the Stellenbosch area, Cape Province. *South African Journal of Wildlife Research* **15**: 17–24.
- Noss, R.F.** 1983. A regional landscape approach to maintain diversity. *BioScience* **33**: 700–706.
- Noss, R.F.** 1990. Indicators for monitoring biodiversity: a hierarchical approach. *Conservation Biology* **4**: 355–364.
- Noss, R.F.** and Harris, L.D. 1986. Nodes, networks and MUMs: preserving diversity at all scales. *Environmental Management* **10**: 299–309.
- Noss, R.F.** 1990. Indicators for monitoring biodiversity: a hierarchical approach. *Conservation Biology* **4**: 355–364.
- Nottrott, R.W.,** Franklin, J.F. and Vande Castle, J.R. 1994. *International networking in long-term ecological research*. LTER Publication No. 17. LTER Network Office, Seattle, Wash, USA (in press).
- National Research Council** 1993. *A Biological Survey for the Nation*. National Academy Press, Washington, DC
- Obeid, S.M.H.** and Hassan, A.A.E. 1992. *Sudan Resource Assessment and Development (SRAAD) First Interim Report*. Forest National Corporation, Khartoum, Sudan.
- Owen, J.** 1991. *The Ecology of a Garden*. Cambridge University Press, Cambridge.
- Owen, J.** and Rosentreter 1993. Monitoring rare perennial plants: techniques for demographic studies. *Natural Areas Journal* **12**: 32–38.
- Owen-Smith, R.N.** (ed.) 1983. *Management of Large Mammals in African Conservation Areas*. Haum, Pretoria.
- Paine, R.T.** 1969. A note on trophic complexity and community stability. *American Naturalist* **103**: 91–93.
- Päivinen, R.,** Lund, H.G., Poso, S. and Zawila-Niedzwiecki, T. (eds) 1994. *IUFRO International Guidelines for Forest Monitoring*. IUFRO World Series Report 5. International Union of Forestry Research Organizations, Vienna.
- Palmer, M.E.** 1987. A critical look at rare plant monitoring in the United States. *Biological Conservation* **39**: 113–127.
- Patrick, R.** 1971. Diatom communities. In: Cairns, J.Jr (ed.), *The Structure and Function of Fresh-Water Microbial Communities*. 151–164. Research Division monograph 3. Virginia Polytechnic Institute and State University, Blacksburg, Va.
- Pearson, D.L.** and Cassola, F. 1992. World-wide species richness patterns of tiger beetles (Coleoptera: Cicindelidae); indicator taxon for biodiversity and conservation studies. *Conservation Biology* **6**: 376–391.
- Phillips, O.L.** and Gentry, A.H. 1994. Increasing turnover through time in tropical forests. *Science* **257**: 954–958.
- Pickett, S.T.A.** and White, P.S. (eds) 1985. *The Ecology of Natural Disturbance and Patch Dynamics*. Academic Press, San Diego.
- Pimm, S.L.** 1991. *The Balance of Nature?* University of Chicago Press, Chicago.
- Pimm, S.L.,** Jones, H.L. and Diamond, J. 1988. On the risk of extinction. *American Naturalist* **132**: 757–785.
- Pimm, S.L.** and Sugden, A.M. 1994. Tropical diversity and global change. *Science* **257**: 933–934.
- Piper, S.E.** and Schultz, D.M. 1989. Type, dimensionality and size of Longtailed Wagtail territories. *Ostrich* (Suppl.) **14**: 123–131.
- Platt, B.,** Schanta, M., Lachowski, H., Maus, P., Landrum, V. and Johnson, J. 1993. Forest plan monitoring: the role of remote sensing and GIS on the Mark Twain National Forest. In: Lund, H.G., Landis, E. and Atterbury, T. (eds), *Stand Inventory Technologies 92. Proceedings of the Stand Inventory Technologies – An international multiple resource conference*, 13–17 September 1992, Portland, Oregon. 342–348. American Society for Photogrammetry and Remote Sensing, Bethesda, Md.
- Pollard, E.** 1991. Monitoring butterfly numbers. In: Goldsmith, F.B. (ed.), *Monitoring for Conservation and Ecology*. 87–111. Chapman and Hall, London.
- Pollard, E.** and Yates, T.J. 1993. *Monitoring Butterflies for Ecology and Conservation*. Chapman and Hall, London.
- Powers, M.E.** and Scott Mills, L. 1995. The Keystone cops meet in Hilo. *Trends in Ecology and Evolution* **10**: 182–184.
- Prendergast, J.R.,** Quinn, R.M., Lawton, J.H., Eversham, B.C. and Gibbons, D.W. 1993. Rare species, the coincidence of diversity hotspots and conservation strategies. *Nature* **365**: 335–337.

- Quilot, W., Fernandez, E. and Hidaigo, M.E.** 1994. Photoprotection mechanisms in lichens against UV radiation. *British Lichen Society Bulletin* **75** (Winter 1994): 1–5.
- Raunkiaer, C.** 1934. *The Life Forms of Plants and Statistical Plant Geography. The collected papers of C. Raunkiaer.* Oxford University Press, Oxford.
- Reid, W.V., Laird, S.A., Elmez, R.G., Sittenfeld, A., Janzen, D.H., Gollin, M.A. and Juma, G.** (eds) 1993. *Biodiversity Prospecting.* WRI, Washington, DC.
- Richardson, D.H.S.** 1992. *Pollution Monitoring with Lichens.* Naturalists' Handbooks 19, Richmond Publishing Co., Slough, UK.
- Richardson, D.M., Macdonald, I.A.W., Holmes, P.M. and Cowling, R.M.** 1992. Plant and animal invasions. In: Cowling, R.M. (ed.), *The Ecology of Fynbos: Nutrients, fire and Diversity.* 271–308. Oxford University Press, Cape Town.
- Rissanen, K.** 1992. Lichens and plants obtained from permanent study plots in northern Finland as bioindicators for radioactive fallout. In: Tikkanen, E., Varmela, M. and Katermaa, T. (eds), *Proceedings of the Symposium on the State of the Environment and Environmental Monitoring in northern Fennoscandia and the Kola Peninsula.* 6–8 October 1992, Rovaniemi, Finland. *Arktisen Keskuksen Julkaisuja* 4. 320–322. Arctic Centre, University of Lapland, Rovaniemi, Finland.
- Ritchie, J.C. and Weltz, M.A.** 1992. Using airborne laser to measure vegetation properties. In: *Proceedings ASPRS/ASCM/RT 92 Technical Papers Volume 4 – Remote Sensing and Data Acquisition.* 395–404. American Society for Photogrammetry and Remote Sensing, Bethesda, Md.
- Rogers, D.J.** 1995. Remote sensing and the changing distribution of tsetse flies in Africa. In: Harrington, R. and Stork, N.E (eds), *Insects in a Changing Environment.* 177–193. Academic Press, London.
- Rose, F.** 1976. Lichenological indicators of age and environmental continuity in woodlands. In: Brown, D.H., Hawksworth, D.L. and Bailey, R.H. (eds), *Lichenology: Progress and problems.* The Systematics Association, Special Volume 8: 279–307. Academic Press, London.
- Rose, F.** 1992. Temperate forest management: its effects on bryophyte and lichen floras and habitats. In: Bates, J.W. and Farmer, A.M. (eds), *Bryophytes and Lichens in a Changing Environment.* 211–233. Clarendon Press, Oxford.
- Royama, T.** 1992. *Analytical Population Dynamics.* Chapman and Hall, London.
- Rudis, V.A.** 1991. *Wildlife Habitat, Range, Recreation, Hydrology, and Related Research Using Forest Inventory and Analysis Surveys: a 12-year compendium.* General Technical Report SO-84. US Department of Agriculture, Forest Service, Southern Forest Experiment Station, New Orleans, La.
- Salanki, J.** (ed.) 1986. *Biological Monitoring of the State of the Environment: Bioindicators.* IUBS Monograph Series No. 1. IRL Press, Oxford.
- Samways, M.J.** 1989. Insect conservation and landscape ecology: a case-history of bush crickets (Tettigoniidae) in southern France. *Environmental Conservation* **16**: 217–226.
- Samways, M.J.** 1993. A spatial and process sub-regional framework for insect and biodiversity conservation research and management. In: Gaston, K.J., New, T.R. and Samways, M.J. (eds), *Perspectives on Insect Conservation.* 1–27. Intercept, Andover, UK.
- Samways, M.J.** 1994. *Insect Conservation Biology.* Chapman and Hall, London.
- Schreuder, H.T., Gregoire, T.G. and Wood, G.B.** 1993. *Sampling Methods for Multiresource Forest Inventory.* John Wiley, New York.
- Seber, G.A.F.** 1973. *The Estimation of Animal Abundance.* Griffin, London.
- Shantz, H.L. and Turner, B.L.** 1958. Photographic documentation of vegetational changes in Africa over a third of a century. Report No. 169. *University of Arizona, College of Agriculture.*
- Shelton, P.A., Boyd, A.J. and Armstrong, M.J.** 1985. The influence of large-scale environmental processes on neritic fish populations in the Benguela Current system. *California Cooperative Oceanic Fish Investment Report* **26**: 72–93.
- Sherman, K. and Alexander, L.M.** (eds) 1986. *Variability and Management of Large Marine Ecosystems.* AAAS selected symposium 99. Westview press, Boulder, Colo.
- Sherman, K., Alexander, L.M. and Gold, B.D.** (eds) 1990. *Large Marine Ecosystems: Patterns, Processes and Yields.* AAAS Press, Washington, DC.
- Shirt, D.B.** (ed.) 1987. *British Red Data Books: 2. Insects.* Nature Conservancy Council, Peterborough, UK.
- Smith, R.M.** 1977. Movement patterns and feeding behaviour of the leopard *Panthera pardus* in the Rhodes Matopos National Park, Rhodesia. *Arnoldia (Rhodesia)* **8**: 1–15.
- Smith, F.D.M., May, R.M., Pellew, R., Johnson, T.H. and Walter, K.R.** 1993. How much do we know about the current extinction rate? *Trends in Ecology and Evolution* **8**: 375–378.
- Soberón, J. and Llorente, J.** 1993. The use of species/accumulation functions for the prediction of species richness. *Conservation Biology* **7**: 480–488.
- Sobrevilla, C. and Bath, P.** 1992. *Evaluación ecológica rápida: un manual para usuarios de America Latina y el Caribe.* Edición Preliminar. Arlington, Va.
- Solbrig, O.T.** (ed) 1991. *From Genes to Ecosystems: A research agenda for biodiversity.* IUBS, Paris.
- Sonesson, M., Osborne, C. and Sandberg, G.** 1994. Epiphytic lichens as indicators of snow depth. *Arctic and Alpine Research* **26**: 159–165.
- Soulé, M.E.** (ed.) 1986. *Conservation Biology: The science of scarcity and diversity.* Sinauer Associates, Sunderland, Mass.
- Soulé, M.E.** (ed.) 1987. *Viable Populations for Conservation.* Cambridge University Press, Cambridge.
- Soulé, M.E.** (ed.) 1989. Conservation biology in the twenty-first century: summary and outlook. In: Western, D. and Pearl, M. (eds), *Conservation In the Twenty-First Century.* 297–303. Oxford University Press, New York.
- Soulé, M.E. and Kohm, K.A.** (eds) 1989. *Research Priorities for Conservation Biology.* Island Press, Washington, DC.
- Soulé, M.E. and Wilcox, B.A.** (eds) 1980. *Conservation Biology: An evolutionary-ecological perspective.* Sinauer Associates, Sunderland, Mass.
- Southwood, T.R.E.** 1978. *Ecological Methods with Particular Reference to the Study of Insect Populations,* 2nd edn. Chapman and Hall, London.
- Spellerberg, I.F.** 1991. *Monitoring Ecological Change.* Cambridge University Press, Cambridge.

- Spellerberg, I.F.** 1992. *Evaluation and assessment for Conservation*. Chapman and Hall, London.
- SPOT Image.** 1989. *The catalogue of SPOT products and services*. Centre National d'Etudes Spatiales (CNES), France.
- Steffenson, J.R.** and Wilson, A.E. 1993. Existing vegetation mapping and vegetation zone and plant association group models. In: Lund, H.G., Landis, E. and Atterbury, T. (eds), *Stand Inventory Technologies 1992. Proceedings of the Stand Inventory Technologies: An international multiple resource conference*. 13–17 September 1992, Portland, Oregon. 63. American Society for Photogrammetry and Remote Sensing, Bethesda, Md.
- Steinnes, E.** and Njastad, O. 1993. Use of mosses and lichens for regional mapping of Cs fallout from the Chernobyl accident. *Journal of Environmental Radioactivity* **21**: 65–73.
- Stork, N.E.** 1994. Inventories of biodiversity: more than a question of numbers. In: Forey, P.L., Humphries, C.J. and Vane-Wright, R.I. (eds), *Systematic and Conservation Evaluation*. The Systematics Association Special Volume No. 50. 81–100. Oxford Science Publications.
- Stork, N.E.** 1995. Measuring and inventorying arthropod diversity in temperate and tropical forests. In: Boyle, T. (ed.), *Measuring and Monitoring Biodiversity in Tropical and Temperate Forests*. CIFOR, Bogor, Indonesia (in press).
- Sutherst, R.W.,** Maywald, G.F. and Skarratt, D.B. 1995. Predicting insect distributions in a changed climate. In: Harrington, R. and Stork, N.E. (eds), *Insects in a Changing Environment*. 59–91. Academic Press, London.
- Swanson, F.J.** and Sparks, R.E. 1990. Long-term ecological research and the invisible place. *BioScience* **40** (7): 502–508.
- Synge, H.** (ed.) 1981. *The Biological Aspects of Rare Plant Conservation*. John Wiley, Chichester.
- Takao, G.** 1992. Photogrammetric measurement of stand disposition and each tree's dbh with a rotatory camera. In: *Proceedings of the Symposium on Integrated Forest Management Information System*, 13–18 October 1991. 88–397. Japan Society of Forest Planning Press, Tokyo.
- Tangley, L.** 1992. *Mapping Biodiversity: Lessons from the field I*. Conservation International, Washington, DC.
- Tappan, G.,** Wood, E., Hadj, A. and Bodian, A. 1994. *Monitoring Natural Resource Changes in Senegal: Preliminary evidence from field studies*. Draft Report. EROS Data Center, Geological Survey, Sioux Falls, SD.
- Ten Brink, B.J.E.,** Hosper, S.H. and Collijn, F. 1991. A quantitative method for description and assessment of ecosystems: the AMOEBA-approach. *Marine Pollution Bulletin* **23**: 265–270.
- Terborgh, J.** and Winter, B. 1980. Some causes of extinction. In: Soulé, M.E. and Wilcox, B.A. (eds), *Conservation Biology: An evolutionary-ecological perspective*. 119–133. Sinauer Associates, Sunderland, Mass.
- Thomas, M.B.,** Wratten, S.D. and Sotherton, N.W. 1992. Creation of 'island' habitats in farmland to manipulate populations of beneficial arthropods: predator densities and species composition. *Journal of Applied Ecology* **29**: 524–531.
- Thompson, M.W.** 1993. Photographic and landsat monitoring. In: Marais, C. and Richardson, D.M. (eds), *Monitoring Requirements for Fynbos Management*. FRD Programme Series No. 11. 87–97. Foundation for Research Development, Pretoria.
- Tibell, L.** 1992. Crustose lichens as indicators of forest continuity in boreal coniferous forests. *Nordic Journal of Botany* **12**: 427–450.
- Tribe, G.D.** and Richardson, D.M. 1994. The European Wasp, *Vespula germanica* (Fabricius) (Hymenoptera: Vespidae), in Southern Africa and its potential distributions as predicted by ecoclimatic mapping. *African Entomology* **2**: 1–6.
- Trueman, J.** and Cranston, P. 1994. *An Evaluation of some Methods of Rapid Biodiversity Assessment for Estimating Arthropod Diversity*. The Department of the Environment, Sport and Territories, Canberra.
- United Nations Environment Programme.** 1986. *The Handbook of Ecological Monitoring*. R.Clark (ed.). Clarendon Press, Oxford.
- Unwin, D.M.** and Corbet, S.A. 1991. *Insects, Plants and Microclimate*. Naturalists' Handbook 15. The Richmond Publishing Co., Slough, UK.
- Usher, M.B.** 1986. Wildlife conservation evaluation: attributes, criteria and values. In: Usher, M.B. (ed.), *Wildlife Conservation Evaluation*. Chapman and Hall, London.
- Usher, M.B.** 1991. Scientific requirements of a monitoring programme. In: Goldsmith, F.B. (ed.), *Monitoring for Conservation and Ecology*. 15–32. Chapman and Hall, London.
- Vane-Wright, R.I.,** Humphries, C.J. and Williams, P.H. 1991. What to protect? Systematics and the agony of choice. *Biological Conservation* **55**: 235–254.
- Villeneuve, J.P.,** Fogelqvist, E. and Cattini, C. 1988. Lichens as bioindicators for atmospheric pollution by chlorinated hydrocarbons. *Chemosphere* **17**: 399–403.
- Vogler, A.P.** and DeSalle, R. 1994. Diagnosing units of conservation management. *Conservation Biology* **8**: 354–363.
- Wallace, M.** 1993. California Condor status report. *Vulture News* **28**: 8–10.
- Walters, C.J.** 1992. Perspectives on adaptive policy design in fisheries management. In: Jain, S.K. and Botsford, L.W. (eds), *Applied Population Biology*. 249–262. Kluwer Academic Publishers, Dordrecht.
- World Conservation Monitoring Centre** 1992. *Global Biodiversity: Status of the world's living resources*. Chapman and Hall, London.
- Welcomme, R.L.** 1985. *River Fisheries*. FAO Fisheries Technical Paper 262. FAO, Rome.
- Wessels, D.C.J.** and Büdel, B. 1989. A rock pool lichen community in northern Transvaal, South Africa: composition and distribution patterns. *Lichenologist* **21**: 259–277.
- Western, D.** and Grimsdell, J.J.R. 1979. *Measuring Distribution of Animals in Relation to the Environment*. Handbooks on Techniques in African Wildlife Ecology No. 2. African Wildlife Leadership Foundation, Nairobi.
- Wetmore, C.M.** 1983. Lichen survival in a burned oak savanna. *The Michigan Botanist* **22**: 47–52.
- Wheeler, Q.D.** 1995. Systematics, the scientific basis for inventories of biodiversity. *Biodiversity and Conservation* **3**.
- Wheeler, Q.D.** and Cracraft, J. 1995. Taxonomic preparedness: Are we ready to meet the biodiversity challenge? In: Reaka-Kudla, M.L., Wilson, D.E. and Wilson, E.O. (eds), *Biodiversity*

- II. Understanding and protecting our natural resources.* Joseph Henry Press and National Academy Press, Washington, DC (in press).
- Williams, G.** 1987. *Techniques and Fieldwork in Ecology*. Bell and Himan, London.
- Williams, K.S.** 1993. Use of terrestrial arthropods to evaluate restored riparian woodlands. *Restoration Ecology* **1**: 107–116.
- Williams, P.H.** and Gaston, K.J. 1994. Measuring more of biodiversity: can higher-taxon richness predict wholesale species richness? *Biological Conservation* **67**: 211–217.
- Williams, P.H., Vane-Wright, R.I.** and Humphries, C.J. 1993. Measuring biodiversity for choosing areas. In: LaSalle, J. and Gauld, I.D. (eds), *Hymenoptera and Biodiversity*. 309–328. CAB International, Wallingford.
- Witte, F.T., Goldschmidt, J., Van Oijen, W.M., Govidswaard, K., Witte-Maas, E.** and Bouton, N. 1992. The destruction of an endemic species flock. Quantitative data on the decline of the haplochromine cichlids of Lake Victoria. *Env. Biol. Fish.* **23**: 1–28.
- Woiwod, I.P.** 1991. The ecological importance of long-term synoptic monitoring. In: Firbank, L.G., Carter, N., Darbyshire, J.F. and Potts, G.R. (eds), *The Ecology of Temperate Cereal Fields*. 275–304. Blackwell Scientific Publications, Oxford.
- Wolda, H.** 1992. Trends in abundance of tropical forest insects. *Oecologia* **89**: 47–52.
- Wolseley, P.A.** and Aguirre-Hudson, B. 1991. Lichens as indicators of environmental change in the tropical forests of Thailand. *Global Ecology and Biogeography Letters* **1**: 170–175.
- Wolseley, P.A., Moncrieff, C.** and Aguirre-Hudson, B. 1995 [1994]. Lichens as indicators of stability and change in the tropical forests of Thailand. *Global Ecology and Biogeography Letters* **4**: 116–123.
- Wright, M.G.** 1993. Insect conservation in the African Cape Fynbos, with special reference to endophagous insects. In: Gaston, K.J., New, T.R. and Samways, M.J. (eds), *Perspectives on Insect Conservation*. 97–110. Intercept Press, Andover, UK.
- Wu, S.-T.** 1990. Assessment of tropical forest stand characteristics with multipolarized SAR data acquired over a mountainous region in Costa Rica. *IEEE Transactions on Geoscience and Remote Sensing* **28** (4): 752–755.
- Wynn-Williams, D.D.** 1994. Potential effects of ultraviolet radiation on Antarctic primary terrestrial colonizers: Cyanobacteria, algae and cryptogams. In: Weiler, C.S. and Penhale, P.A. (eds), *Ultraviolet Radiation in Antarctica: Measurements and biological effects*. Antarctic Research Series 62. 243–257. American Geophysical Union, Washington, DC.
- Yen, A.L.** 1993. The role of museums and zoos in influencing public attitudes towards invertebrate conservation. In: Gaston, K.J., New, T.R. and Samways, M.J. (eds), *Perspectives on Insect Conservation*. 213–229. Intercept Press, Andover, UK.
- Yonzon, P., Jones, R.** and Fox, J. 1991. Geographic information systems for assessing habitat and estimating population of red pandas in Langtang National Park, Nepal. *Ambio* **20**: 285–288.
- van Zyl, J.J.** 1993. The effect of topography on radar scattering from vegetated areas. *IEEE Transactions on Geoscience and Remote Sensing* **31** (1): 153–160.

7.3 Integrated approaches

7.3.1 Introduction

Informed decisions concerning the implementation of measures to address losses in global biodiversity can only be made on the basis of sound, scientifically based options. Most species data presently available at the population, community, ecosystem and landscape levels are difficult to synthesize because of their spatially fragmented character, lack of comparability and inaccessibility. To overcome these problems, more coherent and integrative species assessments based on standardized intercalibrated temporal and spatial inventorying and monitoring efforts are needed.

Although many countries are attempting to make inventories of their biota, few appear to have cohesive programmes. Often the responsibility for national inventories rests on poorly resourced national museums and herbaria, and on a handful of individuals. Few countries have co-ordinated and planned programmes of action. For many countries the lack of even basic inventory data prevents studies of populations of species and the monitoring of biodiversity at the species level or below. The scale of the task of preparing checklists, systematic revisions and user-friendly keys to the biota is daunting for all but a few of the most species-poor and economically well-resourced countries. Because the task seems so huge and unending, and the economic benefits so vague or apparently non-existent, few governments provide adequate resources. Even in Europe no country has completed a full inventory. Often, which groups have been inventoried will have been determined by the expertise available. For example, although groups such as harvestmen, mutillid wasps, aphids, butterflies and dragonflies have been well inventoried in South Africa, little is known about millipedes, mosses, fungi or protozoa.

It is clear from Section 8 and from previous chapters in this section that the inventorying and monitoring of biological diversity at national, regional and global levels requires substantial systematic and ecological infrastructure, economic input and human resources. Such requirements exceed the capabilities of even the most scientifically advanced nations. Thus, there is a need to share and co-ordinate expertise and capacity, particularly for the inventorying and monitoring of diverse and poorly-known groups such as invertebrates and microorganisms, and to agree priorities for future programmes.

International co-ordination of effort is also essential because the processes and patterns of biodiversity are not restricted by political, social or economic boundaries. Integration is essential if resources (time, money and personnel) are not to be wasted. Without such co-ordination, some areas will be left unresearched and others will be analysed repeatedly using different and incompatible methodologies.

This chapter explores the present state of integration between different programmes for the inventorying and monitoring of biodiversity.

7.3.2 Co-ordinating inventorying efforts

7.3.2.1 Integrated strategies

There have been no attempts to co-ordinate efforts to inventory the world's biota, and some groups of organisms have received a disproportionate amount of attention (May 1988). A much better balance should be sought in the future, and groups such as terrestrial and deep-sea invertebrates and microorganisms should receive much more attention from systematists. Initiatives designed to promote co-ordinated biological studies at the international level, such as the International Biological Programme (IBP) (1962–72), have helped to create a baseline understanding of natural systems. In particular, the IBP introduced the mathematics of systems analysis into ecology, to help make sense of the complex functioning of natural systems and the dynamics of biodiversity (Worthington, in UNESCO 1993). However, this initiative and others such as The World Conservation Strategy (1976–77) and the Sustainable Biosphere Initiative (1991), failed to address directly the problems of inventorying and monitoring.

Agenda 21 calls for inventorying and monitoring programmes to be incorporated into most of the international conventions (e.g. Biodiversity, Global Climate Change, Deforestation, Desertification). Given the increasing demands for information, and reductions in research budgets, we must start to integrate and co-ordinate our inventorying and monitoring programmes. Lund (1986) and Lund and Wigton (in press) provide guidance on designing integrated inventories.

7.3.2.1.1 National efforts. Most nations have established inventory programmes for forests, soils and agricultural lands. Some of these involve the use of permanent plots for monitoring change. For example, natural forest inventories have been carried out at regular intervals in Malaysia, in collaboration with FAO, to obtain information that would allow for an orderly development of the forest industry (see Box 7.1-8). Some nations, including the Sudan (Obeid and Hassan 1992), Ethiopia (Mamo *et al.* 1994), Uganda (Drichi 1994; Hedberg 1994), Senegal (Gueye 1993) and Tanzania (Mgeni 1990), have initiated multiple resource inventories across several landscapes (e.g. forested, agricultural and range lands). Such surveys, with very minor modifications, can provide estimates of change in vegetation biodiversity.

In Sudan, for example, the reforestation and anti-desertification project (SRAAD) was established to reverse the processes of desertification and declining soil productivity which have led to a reduction of agricultural production and income of traditional farmers

in Western Sudan. A pilot multi-agency effort was launched in November 1989, through USAID and the Government of Sudan, and was completed in February 1990. Advanced technologies such as Landsat imagery, global positioning systems and geographic information systems (GIS) were used in conjunction with traditional resource inventory and mapping techniques. Products included image base maps at scales of 1:100 000 and 1:250 000, vegetation type maps, and multiple resource inventory and socio-economic data entered into GIS. Data were collected with the aim of meeting local, national and global needs (Anon. 1990; Lund *et al.* 1991; Obeid and Hassan 1992).

In the last few decades several countries, including Australia and Canada, have made major advances in their biotic inventories, and more recently, countries such as the USA, Mexico and Costa Rica have commenced national inventory programmes. The National Biological Survey of the USA (now the National Biological Service) (NRC 1993), established in 1993, is responsible for the co-ordination of inventorying and monitoring of biodiversity for the USA. Other agencies of the USA government are also supporting national inventorying of biota. The US Department of Agriculture Forest Service and the National Resources Conservation Service (formerly the Soil Conservation Service) have been monitoring the forests and agricultural lands of the USA since the 1930s. In the southern region of the country, data sets are available that represent a baseline of plots revisited during five surveys made over the past 60 years. The information is used to assess changes in the timber resources and associated biota of the region (Rudis 1991). The national inventory of forests includes an estimated 400 000 one acre field plots and 6.5 million photographic plots across the landscape (Lund *et al.* in press).

Arguably the most impressive advances have taken place in Mexico and Costa Rica through the formation of CONABIO and INBio, respectively (see Boxes 7.3-1 and 7.3-2). The approaches taken by these two countries are different, reflecting their different scientific and cultural heritages. Both approaches are built on the skills and enterprise of local peoples. However, as in almost all national efforts they are still dependent, to some degree, on expertise from other nations. Costa Rica, for example, has few taxonomists and is reliant on the collaboration of overseas scientists. Indeed, one of the major drawbacks of these national approaches is they can all too easily stretch the international pool of specialists. If there is just one world authority on a particular group of fungi, for example, then it may be a full-time job for several years for that person to work just on the relevant group of fungi in Costa Rica. This would mean that there may be no available expert for this group for any other part of the world.

7.3.2.1.2 International efforts

DIVERSITAS

At the international level, one initiative to promote co-operation in the inventorying and monitoring of biodiversity is included as part of the DIVERSITAS programme of IUBS, SCOPE and UNESCO (di Castri and Younès 1991; di Castri *et al.* 1992a, b). This programme, launched in 1991, arose out of the recognition that a conceptual framework and direction was badly needed for the rapidly growing numbers of studies on biodiversity.

DIVERSITAS has four main themes, including the inventorying and monitoring of overall biodiversity, and the genetic diversity of wild relatives of cultivated species. This programme covers all levels of biological diversity, from genes to ecosystems, incorporating both marine and terrestrial systems and involving a variety of scientific disciplines – genetics, physiology, population biology, ecology and taxonomy (Solbrig 1991; di Castri *et al.* 1992a). It is currently under review. In practice, no agenda for inventorying has yet resulted from DIVERSITAS, although several important actions have been taken. The

original concept of inventorying and monitoring (Coddington *et al.* 1991; di Castri *et al.* 1992a, b) proposed that a few sites be very *intensively* studied for all organisms and that at a larger number of sites a range of selected target taxa be more *extensively* inventoried. DIVERSITAS promoted the use of the UNESCO Man and the Biosphere Reserve network (see below) as the focal sites for inventory programmes since inventory studies have either been carried out or are in progress at many of them. The *intensive* theme has since been expanded by Janzen and Hallwachs (1994) as the All Taxa Biological Inventory (Box 7.2-4).

Several countries, such as Brazil, Russia, China, Japan, France and the USA, have started their own DIVERSITAS activities (Longino 1994; Barbault 1994; Zhao 1994; Sokolov *et al.* 1994) but the work plans of these different programmes have not yet been co-ordinated.

One of the greatest problems for inventorying is the lack of adequate local, regional and international resources for systematics. Two recent initiatives, Systematics Agenda 2000 and BioNET-International (discussed below), seek to address these problems.

Box 7.3-1: Mexico's CONABIO.

In March 1992, the Mexican National Commission for the Knowledge and Use of Biodiversity (CONABIO) was created by the Mexican Government. Its mission is to promote and co-ordinate the biodiversity efforts performed by many Mexican universities, research centres, NGOs and government agencies. CONABIO has a mandate to advance the inventory of the Mexican biota. This long-term task must begin with a compilation of the information that is held in museums and herbaria, and this has been initiated by supporting projects for the computerization and networking of national museum collections, by agreeing with foreign museums on the repatriation of information on Mexican specimens, and by field work in selected areas. CONABIO now holds 80 databases with more than half a Gygabyte of georeferenced data from the labels attached to specimens collected in Mexico. The information covers vertebrates, invertebrates and plants. A very significant part of these databases comes from more than 40 foreign museums and herbaria. CONABIO follows closely the model of the Australian ERIN (Environmental Resources Information Network) regarding custodianship of the data by the original sources. As agreements with the source institutions proceed, information will be added to the Gopher (WWW homepage is under construction) maintained by CONABIO.

This information, together with maps and socioeconomic data, is being organized in a single information system, which will be the factual basis of the Biodiversity Strategy that Mexico, as a signatory of the Convention on Biological Diversity, must complete. CONABIO intends to use the information to support both academic and research activities and to advise government agencies and NGOs in matters relating to monitoring, ecological planning, restoration activities, evaluation of environmental impact assessments and so on. To do this most of the data held must be made available to the public, requiring an agreed set of policies from the suppliers of the information regarding access, copyright, costs, acknowledgements, updating and so on.

CONABIO is also supporting projects on the training of parataxonomists (an adaptation of the pioneer experience of INBio), the sustained use of tropical species (butterflies, hardwoods, resins), the eradication of invading species, and public awareness. Over its almost three years of existence, 770 project proposals have been submitted to CONABIO. Through a process of external peer review nearly 200 have been selected for support. Most of CONABIO's funds come from donations of the Federal Government to a private fund which channels resources to the selected projects. The Mexican Government has committed an annual budget of about US \$6 million to CONABIO's fund. About 15% of these resources are spent in administration and the rest in projects.

As an advisory body, CONABIO has participated in the assessment of environmental impact studies, in the negotiation of contracts between pharmaceutical companies and Mexican universities and indigenous groups, and in multinational negotiations.

Box 7.3-2: Costa Rica's national biodiversity institute (INBio).

Created in 1989, INBio is a non-governmental non-profit institution dedicated to the conservation of wildland biodiversity through facilitating its non-destructive intellectual and economic uses by national and international society (Reid *et al.* 1993). It is focused on biodiversity inventory, prospecting, information management and information dissemination. INBio's activities are largely concentrated in Costa Rica's National System of Conservation Areas, a network of government-owned parks and protected areas that covers 25% of the country and contains an estimated 500 000 species (Sittenfeld and Elmez 1992; Sittenfeld and Villers 1993). INBio's national inventory and biodiversity prospecting are well under way for plants and insects, and rapidly broadening to other taxa (see Box 7.2-4, ATBI and the Guanacaste Conservation Area, Costa Rica).

The inventory is conducted in large part by parataxonomists, explicitly trained lay paraprofessionals who bring specimens and other information to INBio from their biodiversity offices in or near the Conservation Areas (Wille 1993; Janzen *et al.* 1993). The field work of the parataxonomists is guided by the INBio inventory managers, who do taxonomy in co-ordination with national and international taxonomic specialists. Reference collections, field guides and electronic identification services are being established. Detailed information on species ranges and natural histories is accumulating rapidly. Information on identities, distributions and natural history is being put in the public domain through Internet and publications. The local abilities at inventory and information management developed through the INBio process are being shared with other tropical countries through on-site workshops. Collaborative agreements for biodiversity inventorying have been developed between INBio and various tropical countries and biodiversity institutions.

INBio's biodiversity prospecting programme seeks out potential users of biodiversity and facilitates the contracted flow of Costa Rican wildland biodiversity research samples and information to the commercial research and development process. The returns contribute to the management income for the conserved wildlands and may eventually make a serious contribution to Costa Rica's economy (Reid *et al.* 1993). The current focus of biodiversity prospecting is on discovery of chemicals from plants, insects and microorganisms for use in the pharmaceutical and medical industries. However, expansion is envisaged in other areas, including organisms as sources of genes for biotechnology, biological control and pesticides. These aims are illustrated by two successive two-year contracts between INBio and the pharmaceutical company Merck & Co. to prospect for biologically active compounds from a limited number of plants, insects and other organisms. The samples, collected by INBio within the government-owned Conservation Areas, are managed under agreement with the Ministry of Natural Resources, Energy and Mines (MIRENEM) and processed in INBio's laboratory. Merck & Co. paid INBio US \$1.3 million for each contract, in return for sample collection, identification, data management, and personnel training: 10% of these funds (and 50% of any royalties) go to MIRENEM for classical conservation, while the remainder is spent on biodiversity development at INBio and in the Conservation Areas. A similar five-year contract is now in progress between INBio, Cornell University and Bristol Meyers Squibb. Wild organisms discovered to have domestic potential then become new crops and livestock (e.g. Coghlan 1994).

BioNET International

BioNET-International was initiated by the inter-governmental CAB-International in 1993 to help generate biosystematic self-reliance in the developing world (Jones and Cook 1993). BioNET aims to mobilize and pool existing biosystematic resources within developing countries and to increase and sustain these through the transfer of skills, knowledge, scientific expertise and other resources from developed country institutions.

BioNET is envisaged as a series of interlinked, sub-regional Technical Co-operation Networks in developing countries (known as Locally Organized and Operated Partnerships or LOOPS), supported by a consortium of expert institutions from developed countries (BIOCON) and a central technical secretariat (TECSEC) (Jones and Cook 1993). BioNET originally had particular concern for arthropods, nematodes and microorganisms (Jones and

Cook 1993), but has since expanded to include other invertebrates (Jones 1994). Other groups may be included in the future depending upon regional needs (Jones and Cook 1993). Four priority areas have been identified for the initial focus of the LOOPS:

- information and communication services;
- training of personnel;
- rehabilitation of collections and the establishment of new resources, and
- the development and application of new resources.

In June 1994, the first LOOP was established in Europe (EuroLOOP). This group currently includes 60 institutions

representing 22 countries, including three international institutes based in Europe. The first sub-regional LOOP, an association of seven Caribbean states known as CARINET, was formed in December 1993. Each member country has its own National Co-ordinating Institute and from these a Network Co-ordinating Institute has been chosen to coordinate the LOOP. It is expected that four other LOOPS in East Africa (EAFRINET), Southeast Asia (ASEANET), the South Pacific (PACINET) and Southern Africa (SAFRINET) will be developed in the near future (Jones and Cook 1993, 1995).

Systematics Agenda 2000: Charting the Biosphere

Systematics Agenda 2000: Charting the Biosphere (SA2000) is a programme of discovery and research proposed by a consortium of three international societies of systematic biologists; the American Society of Plant Taxonomists, the Society of Systematic Biologists and the Willi Hennig Society, in co-operation with the Association for Systematic Collections (SA2000 1994a, b). This ambitious scientific initiative aims to document and synthesize knowledge about global species diversity within the next two to three decades.

The first mission of SA2000 (Box 7.3-3) recognizes that current efforts to inventory global biological resources are inadequate. Its five priority goals are designed to increase our overall knowledge of global species diversity and to expand systematic information about groups of organisms that are particularly important for society. Missions 2 and 3 (Box 7.3-3) recognize the need for better information on the phylogenetic relationships of important species groups and an efficient system for information storage and retrieval so that this information may be utilized more productively. Expected benefits from SA2000 include:

- an increased number of usable species resources;
- an improved database to help conservationists and biological resource managers preserve as well as utilize their nations' species diversity;
- knowledge to guide the selection of new and improved food crops and medicines, and
- baseline data for monitoring global climate and ecosystem change, rates of species extinction, ecosystem degradation and the spread of exotic, disease-causing and pest organisms.

SA2000 has proposed a co-ordinated action plan to increase training in systematics, to help countries establish the capacity to survey and inventory their biological diversity, and to build collection-based infrastructures including museums, herbaria, and repositories for microorganisms and genetic resources. The action plan focuses on six main initiatives (SA2000 1994b):

- establishing and enhancing systematic research centres housing collections in all countries committed to understanding, preserving and using their biodiversity;
- supporting institutions that educate systematists and train support staff;
- expanding the number of research positions in basic and applied systematics;
- developing co-operative international research and educational links among systematic institutions world-wide;
- creating electronic communication linkages among these same institutions, with outreach to society, and
- supporting comparative systematic research that is taxon-based and world-wide in scope.

SA2000 recognizes the need for national, scientific systematic research centres, such as CONABIO (Mexico) and INBio (Costa Rica) (Boxes 7.3-1 and 7.3-2), staffed by professional systematists with taxon-based expertise. Some may be built on existing centres, while others will be newly created. Each centre will also require a collection of organisms. To prevent duplication of collections or expertise, SA2000 suggests that systematists with a global knowledge of particular taxa be funded through international centres to conduct research at sites around the world. Co-operative research, database linkages and partnerships between institutions are regarded as essential.

IOPI and SPECIES 2000

Co-operation to produce products of wide utility to biosystematics and biodiversity studies is also reflected by the International Organization for Plant Information (IOPI), established in 1991, which aims to produce a checklist of the world's vascular plant species through a co-ordinated effort involving numerous specialists and institutions. This augers well for the SPECIES 2000 Global Master Species Database programme adopted by the IUBS 25th General Assembly in September 1994, the detailed planning for which is in progress with CODATA.

MARBID

Within 49 Large Marine Ecosystems (LMEs) (see 7.2.10.5.2) world-wide populations and communities of fish, plankton, marine mammals and birds are being monitored by coastal nations. The principal focus is on fish communities as renewable living resources contributing substantially to the nutritional needs and economies of coastal countries. In the recognition that fish surveys are now conducted systematically throughout the extent of

Box 7.3-3: The missions and goals of Systematics Agenda 2000 (From: Systematics Agenda 2000. 1994a, b).

Mission 1: To discover, describe and inventory global species diversity

- to survey marine, terrestrial and freshwater ecosystems to achieve a comprehensive knowledge of global species diversity;
- to determine the geographic and temporal distributions of these species;
- to discover, describe and inventory species living in threatened and endangered ecosystems;
- to target groups critical for maintaining the integrity and function of the world's ecosystems, for improving human health and for increasing the world's food supply, and
- to target the least-known groups of organisms.

Mission 2: To analyse and synthesize the information derived from this global discovery effort into a predictive classification system that reflects the history of life

- to determine the phylogenetic relationships among the major groups of organisms, thus providing a conceptual framework for basic and applied biology;
- to discover the phylogenetic relationships of groups of species that are critical for applied biology, targeting species that are important for human health and food production, as well as for conservation of the world's ecosystems;
- to discover the phylogenetic relationships of groups of species that are of critical importance for the basic biological sciences, such as those having broad relevance for experimental science and those critical for maintaining the integrity and function of ecosystems, and
- to develop more powerful techniques and methods for systematic data analysis.

Mission 3: To organize the information derived from this global programme into an efficiently retrievable form that best meets the needs of science and society

- to develop systematic, biogeographic and ecological databases of species information based on species housed in the world's natural history collections;
- to integrate data from specimens housed in systematic collections with information contained in GIS databases, thus providing a means to monitor past and present effects of global change on species distributions and extinction;
- to develop linkages among databases for the efficient retrieval of all available information about species and the places in which they occur;
- to develop and implement an information system that can be accessed efficiently by a broad international user community;
- to develop data dictionaries of taxonomic names, geographic localities and other information basic to all systematics databases;
- to develop data products, including guides, keys, electronic floras and faunas and monographic works, and
- to develop mechanisms for maintaining and updating databases and information networks including continuing hardware and software support.

many of the LMEs, the US National Marine Fisheries Service (NMFS) has initiated a Marine Biodiversity Database (MARBID). The NMFS has large numbers of databases on the distribution of species based on fish surveys conducted during the past 120 years, and information on species has been computerized for data collected during the past 30 years. These databases include information on marine and estuarine organisms from a large number of taxonomic groupings (e.g. fish, plankton, benthos, birds, mammals), and are linked to a newly developed system of visual outputs of distribution and abundance patterns designed to provide managers of marine resources with readily usable information to aid in the implementation of resource sustainable practices (Collette and Vecchione 1995; Mickevich 1995).

CENPLANK

The Centre for Plankton Collection, Sorting and Identification (CENPLANK) of Szczecin and Gdynia, Poland, is an international project that has been in continuous operation for the past two decades. The objective of the project is focused on long-term changes in the states of coastal marine ecosystems using plankton as a means of inventorying and understanding variability in the species biodiversity and abundance levels of ichthyoplankton (fish eggs and larvae) and zooplankton components of large marine ecosystems. Countries participating in the project are the United States, Poland, Canada and the United Kingdom. On an annual basis, an average of 5000 plankton samples are collected from the Gulf of Alaska, East Bering Sea, California Current, Gulf of Mexico, the Southeastern US Coast, Northeastern US Coast and Baltic Sea. They are sorted to species, enumerated and entered into an extensive marine ecosystem data archive. The samples are collected from research vessels, and vessels of opportunity within the spatial extent of several of the large marine ecosystems, using plankton nets of varying sizes. Continuous plankton recorder systems are deployed in collaboration with the Sir Alister Hardy Foundation for Ocean Studies in Plymouth, UK. The project has processed 80 000 plankton samples and has in its archives one of the most extensive enumerations of plankton biodiversity in the world. In 1995, the project is entering its twenty-first year of plankton sample collection, identification, archiving and analysis (Ejsymont and Dutkiewicz 1994).

7.3.3 Co-ordinating monitoring of biodiversity

Monitoring change in biodiversity is almost non-existent for many countries and rarely is it linked to programmes for inventorying biodiversity. The exceptions to these are annual bird counts and sometimes vegetation surveys for a few countries. One of the most comprehensive programmes for monitoring is that in the UK (Box 7.3-4), although even here the range of taxa involved is rather small. In many

ways monitoring of biodiversity is more co-ordinated and advanced in the marine area because of the lack of clear national boundaries. Several important collaborative initiatives in both terrestrial and marine systems are considered below.

7.3.3.1 Vegetation cover and land use

7.3.3.1.1 The Food and Agriculture Organization of the United Nations. The 1990 Forest Resources Assessment (FRA 1990) of the FAO presents a global analysis of the distribution of forest ecosystems in 1990, as well as changes during 1980–90. The study was conducted for three separate regions: temperate forests in developed countries (UN-ECE/FAO 1993), tropical forests in developing countries and non-tropical forests of developing countries (FAO 1993). The resolution at which this analysis was undertaken also permits the analysis of the extent and change of forest cover at the sub-national and national levels.

The FRA 1990 assessment of the tropical zone was made using two complementary approaches. The first was based on a statistical analysis of existing, reliable forest inventory data from different countries. The output consists of country-by-country results in a standardized format for the reference years 1980 and 1990, a database including all source information (FORIS) and a model for producing the standard results. The second approach made use of multi-date observations of forest cover using high resolution satellite images for 1980 and 1990 at statistically chosen sample locations. The survey covered 10% of the tropics.

The remaining studies, covering temperate forests in the developed countries and non-tropical forests in the developing countries, are based solely on the compilation of national forestry statistics. This introduces problems of data comparability due to differences in the base years inventoried from country to country and in the methods and definitions used. In order to overcome some of these problems and to standardize national-level data to two base years (1980 and 1990), the assessment of tropical forests incorporated demographic evolution and ecological zoning to model forest cover change (FAO 1993).

All three regional studies are limited by the accuracy of the underlying national data used. Data availability, timeliness and quality varied considerably from country to country (WRI 1994; and see below). To model cause and effect of deforestation, FRA 1990 compiled three geo-referenced data-sets for the tropical countries depicting (1) the forest extent around 1980 using available national maps, (2) eco-floristic zones, and (3) sub-national boundaries with time series of population data. The World Conservation Monitoring Centre has also put together maps of tropical moist forest distribution based on a variety of national and sub-regional forest cover and vegetation maps. However, many of these are outdated or of questionable

Box 7.3-4: A summary of the extent of terrestrial biodiversity monitoring in the UK (From: the Biodiversity UK Biodiversity Action Plan. Anonymous 1994; Note: All figures are approximate).

Total coverage

Institute of Terrestrial Ecology (ITE) Land Cover Map	25 land cover types
ITE Biological Records Centre schemes	5 000 taxa
British Trust for Ornithology (BTO) <i>Breeding Bird Atlas</i>	250 taxa
BTO <i>Wintering Bird Atlas</i>	200 taxa
<i>British Lichen Society Atlas</i>	750 taxa

Sample coverage

Department of the Environment (DOE)/ITE Land use/Countryside Survey	90 508 1 km squares
Northern Ireland Countryside Survey	620 25 ha squares
Bristol University Badger Survey	2 700 1 km squares
Botanical Society of the British Isles (BSBI) Monitoring Scheme	350 10 km sq/1000 tetrads
BTO Key Squares Survey	350 10 km sq/1000 tetrads

Regional

Phase I Habitat Survey	89 surveys
National Parks	10 parks
Environmentally Sensitive Areas	19 ESAs

Site-based

Environmental Change Network	9 sites
Butterfly Monitoring Scheme	100 sites
Constant Effort Sites	90 sites
Rothamsted Insect Survey (Moths)	70 sites
Rothamsted Insect Survey (Aphids)	24 sites
Joint Nature Conservation Committee (JNCC) Seabird Monitoring Programme	150 sites
Common Bird Census	250 sites
Waterways Bird Survey	100 sites
National Bat Colony Survey	350 sites
Wintering Wildfowl and Waders	50 taxa
Nest Record Scheme	30 000 nests
De Montford University, Amphibian Survey	150 sites
JNCC Invertebrate Site Register	10 000 sites
National Otter Surveys	7000 sites
Red and Grey Squirrels in State Forests	1000 10 km squares
Rare Plants in Great Britain	300 taxa
Rare Breeding Birds Panel	100 taxa

quality (Hammond *et al.* 1993). No map exists for the temperate forests of the world.

Subject to availability of funds FAO now intends, in co-operation with other interested organizations, to assess forest cover on an annual basis, combining a 10% sampling scheme with coarse resolution wall-to-wall remotely sensed imagery and to build up a spatially referenced picture of tropical forest cover for the world (Singh pers. comm.).

Within the framework of the FRA, a systematic review was made of the current national capacity for monitoring forest change. The findings can be summarized as follows:

- There is considerable variation among regions (see Table 7.3-1) with respect to completeness and quality of information, with Asia faring better than tropical America and the latter being better than tropical Africa.
- There is considerable variation in the timeliness of the information. On average, the data are ten years old, which is a potential source of bias in the assessment of change!
- Some countries have carried out more than one assessment. However, these countries have not used

appropriate techniques, such as Continuous Forest Inventory (CFI) design, for the assessment of change.

- Only a few countries have reliable estimates of actual plantations, harvest and utilization, although such estimates are essential for national forestry planning and policy-making.
- No country has carried out a national forest inventory containing information that can be used to generate reliable estimates of the total woody biomass or biodiversity.
- It is unlikely that the state and change information on forest cover area, biomass and biodiversity could be made available on a statistically reliable basis at the regional or global level within the next 10 or 20 years, unless a concerted effort is made to enhance the country capacity in forest inventory and monitoring.

These findings establish that forest resource assessments are among the most neglected aspects of forest resource management, conservation and development in the tropics. For the follow-up of FRA 1990, the most important requirements are (1) continuation of the FRA 1990 sampling approach to provide deforestation trends, and (2) extension of the sampling to cover all the forests of the world, both tropical and temperate, in developing and developed countries. It has been the main finding of the FAO global report, currently in preparation, that information on change produced from national statistics is not adequate to meet the needs of policy-makers and scientists.

Several other organizations are using remote sensing techniques to map forest or land cover digitally at global or regional levels. These include the International Geosphere Biosphere Programme (IGBP), the US Geological Survey (global land cover), the Commission of the European Community's TREES project (tropical moist forests), NASA's PATHFINDER programme (wall-to-wall map of tropical moist forests on three dates), FAO's AFRICOVER project (Africa, land cover) and The Woods Hole Research Center (South American land cover) (ENRIC 1994; Bied-Charreton (in press); Stone *et al.* 1994). With the exception of the South America map, these projects are either ongoing or at the planning stages. Mapping land cover at the national level is more advanced. A number of countries, for example India, Thailand, Indonesia and Brazil, are using high resolution imagery to inventory and monitor changes in their national land cover (WRI 1994).

The PATHFINDER project covers only the tropical moist forests with high resolution satellite data. The classification is simple, including forest and non-forest as

the main categories. The TREES, IGBP, US Geological Survey and Woods Hole efforts rely on low resolution (AVHRR) imagery. This lacks the accuracy of high resolution imagery (for example it is difficult to distinguish forests from certain crop types or to look at fragmentation except at the coarsest level). None of these projects will distinguish between the various classes of forest transitions essential for assessing levels of biodiversity losses. Supplementary ground information is an essential component as satellite imagery can not be used to derive detailed data on vegetation phenology, or to distinguish accurately between natural and plantation forests and between degraded and undegraded areas. Information of this sort will not be available through any of the mapping efforts listed above. As of August 1994, FAO's sampling efforts excepted, no data are forthcoming that will give either a statistically reliable estimate of the world's remaining forests and other vegetation types or how quickly natural vegetation is being converted, fragmented and otherwise degraded, regionally or globally.

7.3.3.1.2 CORINE. The CoORDination of INformation on the Environment system, CORINE, was set up in 1985 to gather, co-ordinate and improve the consistency of information on the state of the environment in the European Communities. This aim is being achieved through the development of 'procedures for the collection, standardization and exchange of data in the community, as well as the establishment of a geographical information system, to provide policy-related information on the community environment' (CEC 1989). CORINE uses the ARC/INFO GIS programme and is held jointly in Birkbeck College, London, and the Directorate General for the Environment in Brussels. The system contains a geographic base including information on coastlines, national boundaries, administrative regions, water patterns, slopes and settlements. Projects for which data are being gathered include water quality, air, biotopes, coastal erosion, land cover, marine environments, soil erosion, water resources and land quality.

As part of the biotopes project, an inventory has been set up within the CORINE system of all the sites considered worthy of conservation at the community level on the basis of their floral and faunal characteristics. The criteria for site selection include the presence of vulnerable species of plants or animals, the presence of vulnerable habitats, the richness of the site for a particular taxonomic group and the richness of the site for a syntaxon of phytosociological units. The information is currently only in a provisional state and the data vary in their consistency and completeness. Recently, attention has been drawn to the fact that the vegetation classification used by CORINE ignores some important habitats. In Britain these include hay meadows, water meadows, snowbeds and sea lochs, and as a consequence these areas may lose their protected

Table 7.3-1: State of forest inventory and monitoring capacity in the tropics at the end of 1990

(Source: FORIS database of the FAO 1990 Forest Resources Assessment Project.)

Region	Number of countries under assessment	Number of countries with forest resources data at national level							
		Forest area information (number of assessments and reference years)				Other data recorded			
		No assessment	One assessment before 1981	One assessment 1981–1990	More than one assessment	Forest conservation and management	Forest plantations	Volume and biomass	Forest harvesting and utilization
Africa	40	3	23	12	2	4	8	2	4
Asia and Pacific	17	0	1	6	10	10	8	7	7
Latin America and Caribbean	33	0	15	9	9	11	8	9	4
Total	90	3	39	27	21	25	24	18	15

status by the European Union's new Habitats Directive (Pearce 1995). However, around 5 200 registered sites are currently contained within the CORINE database and these are expected to increase to between 8 000 and 9 000 in the future. Some of these sites already have protected status but others do not. CORINE also holds information on designated areas – sites that are recognized by national legislation as being under formal protection for the purpose of nature conservation. To date this includes about 12 000 sites but again the number is expected to change as existing data are validated and new information becomes available.

The CORINE system also holds mapped information on the distribution of vegetation types at a scale of 1:3 million. This map was published in 1988 and recognizes over 100 vegetation classes. However, it depicts only climax and plagioclimax vegetation, not the actual existing vegetation types (CEC 1989). In addition, the system keeps data on soils, climate (including rainfall, temperature humidity and snow cover), air (atmospheric emissions and air quality), water (freshwater quality and bathing water quality) and socio economic data (including air traffic and nuclear power stations). For the Mediterranean region only it also contains information on land resources (soil erosion risk and land quality), coastal erosion, seismic risk and stream discharge.

7.3.3.2 Soils

Soils are the critical life-support surfaces on which all terrestrial biodiversity depends. There is an urgent need for

a global review of the distribution of soil types and changes in their status (e.g. desertification, salinization). Soil loss results in the loss of terrestrial biodiversity and can also severely affect aquatic biodiversity through the silting up of rivers, lakes, swamps and delta areas.

Soils contribute to biological diversity together with other environmental factors such as near-surface climatic conditions, landforms, surface and subsurface hydrology and the spatial and temporal variation in geomorphological processes. Soils are highly diverse in form and many different soil types can occur in a small area. The macro- and micro-fauna and the micro-biota in soil are an inherent part of the biological diversity of any area.

Modification of the biological diversity in soils under various forms of land use is an important area of enquiry. Mono-cropping of arable lands, with high inputs of mineral fertilizers and chemical control of diseases and pests, decreases the diversity of species both above and below ground, or at least makes them inactive (e.g. rhizobia, mycorrhiza). On the other hand, long-term mixed farming by smallholders who utilize the local variation of physiographic conditions can increase the diversity of cultivated and domesticated species. These so-called landraces are a valuable asset of traditional farming communities and the study of such diversity deserves more systematic attention.

Research on the relation between land use and biological diversity is at a very early stage. It is, however, important to realize that soils are providers, storers and generators of biodiversity.

7.3.3.3 Marine Station Networks

Logistically, it has been relatively easy to promote international co-operation in the inventorying and monitoring of marine biodiversity. This is essentially because many countries have, over the years, set up stations to study marine biology and have a common scientific tradition which predisposes them to co-operative programmes and networking (Lasserre *et al.* 1994; see Section 8.7). They are ideally placed in terms of their facilities, expertise, long data sets and geographical location to make a major contribution to inventorying and monitoring biodiversity (Grassle *et al.* 1991).

Although the coverage of the world coastline is incomplete, and the collecting effort and taxonomic extent of existing studies have been very uneven, many marine stations have published inventories describing the distribution patterns of marine species. A major challenge is to build up this co-ordination, taking account of the multiple habitat requirements, and the possible very wide distributions, of many marine organisms (planktonic larval life and many invertebrates and fishes), as well as the ocean-wide migrations of tuna, turtles, seabirds, seals and whales. Another challenge is that of studying the dynamics of marine biodiversity as the ecological processes concerned operate on very long time scales (Lasserre 1993; see Section 8.7).

On a regional scale, examples of networks include:

- **MARS:** Europe has a particularly long tradition in marine biology, and many marine stations have celebrated their centenary. In 1990, 11 European marine stations, established the Marine Research Stations (MARS) network, whose membership has subsequently been enlarged to approximately 80 stations. Collaborative biodiversity research is intended to include observational and experimental studies of ecosystems and extensive studies of diversity along Atlantic latitudinal gradients from Spitzbergen to the Canary Islands and along Mediterranean longitudinal gradients from Gibraltar to Haifa. This will facilitate the investigation of changes such as those recorded in seaweeds and the macrobenthos in the English Channel and related to temperature fluctuations of approximately 0.5 °C (Southwood 1980).
- **CARICOMP:** The Caribbean Coastal Marine Productivity (CARICOMP) programme is a regional network of 21 marine laboratories in 16 countries for the investigation of marine biodiversity. It began in 1985 with the support of UNESCO's Coastal-Marine Programme (COMAR), in response to a widely perceived need for regional understanding of the

long-term dynamics of coastal ecosystems upon which increasing human impact was superimposed. A methods manual was written in 1990 containing standardized protocols for monitoring the structure and function of the Caribbean's coastal ecosystems – as well as key physical time-series variables. In 1991, a Data Management Centre was established at the University of the West Indies in Kingston, Jamaica, and a basic set of monitoring equipment was distributed to all participants. Data collection according to the protocols began in 1993. Close communication will also enable the Centre to warn the network of regional phenomena such as coral bleaching, plankton blooms and major storms, that may require special observations.

7.3.3.4 Large Marine Ecosystems

Large Marine Ecosystems (LMEs) were defined in 7.2.10.4 as regions of ocean space encompassing coastal areas from river basins and estuaries on out to the seaward boundary of continental shelves and the seaward margins of coastal current systems. They are relatively large regions, in the order of 200 000 km² or larger, characterized by distinct bathymetry, hydrography, productivity, and trophically dependent populations (see Box 7.2-6). The theory, measurement and modelling relevant to monitoring the changing states of LMEs are discussed in reports on ecosystems with multiple steady states, pattern formation and spatial diffusion within ecosystems (e.g. AAAS 1986, 1989, 1990, 1991, 1993; Beddington 1986; Mangel 1991; Levin 1993).

The designation and management of LMEs is an evolving scientific and geopolitical process (Morgan 1988; Alexander 1989; AAAS 1993). However, sufficient progress has been made to permit useful comparisons to be made among various processes influencing large-scale changes in ecosystem status, health and biomass yields (Bax and Laevastu 1990; Bakun 1993). One recent finding is a marked decline in biodiversity among principal fish stocks of the Black Sea – believed to be partly due to the introduction of a 'foreign' species of ctenophore which causes severe predation on the early life-stages of both fish and their prey (Mee 1992). A second area of concern for scientists engaged in LME studies is the influence of changes in the gene pool of wild stocks from inadvertent releases of cultured stocks.

Among the LMEs being assessed, monitored and managed from a more holistic perspective are:

- the Yellow Sea Ecosystem: largely managed by the People's Republic of China (Tang 1989);
- the multi-species fisheries of the Benguela Current Ecosystem: South Africa (Crawford *et al.* 1989);

- the Great Barrier Reef Ecosystem and the Northwest Australian Continental Shelf Ecosystem: Australia (Bradbury and Mundy 1989; Kelleher 1993; Sainsbury 1988), and
- the Antarctic Marine Ecosystem under the Commission for the Conservation of Antarctic Marine Living Resources (CCAMLR): 21 nations (Scully *et al.* 1986; Sherman and Ryan 1988).

Movement towards ecosystem-level assessment, monitoring and management is emerging also for the North Sea (North Sea Task Force 1991), the Barents Sea, the Black Sea (Hey and Mee 1993) and the Northern California Current Ecosystem (Bottom *et al.* 1989).

The broad-spectrum approach to LME research and monitoring provides a conceptual framework for collaboration in process-orientated studies conducted by the National Science Foundation-NOAA sponsored, GLOBAL Ocean Ecosystems dynamics (GLOBEC) programme of the United States and the International GLOBEC programme (GLOBEC 1991). Developing LME monitoring strategies are compatible also with the proposed Global Ocean Observing System (see below), especially those modules focused on living marine resources and ecosystem health (IOC 1993).

Efforts are under way to place a greater emphasis on the linkage between scientific and societal needs and the utility of long-term, broad-scale coastal ocean assessment and monitoring aimed at improving the long-term sustainability of marine resource species. The basis for the linkage was emphasized in the UNCED declarations on the oceans and the ratification of the Biodiversity Convention. The scientific framework in support of these UNCED initiatives is now emerging from a series of regional efforts aimed at the integration of research, monitoring and assessments conducted to mitigate stresses on coastal ecosystems caused by toxic effluents, habitat degradation, nutrient loadings, harmful algal blooms, aerosol contaminants and losses of living resources from pollution and over-exploitation.

Biodiversity studies can contribute more towards the achievement of marine sustainability and the restoration of degraded biodiversity when they are conducted within a multidisciplinary scientific framework and focused on populations, habitats and ecosystems of large spatial scales. The driving forces of variability in biodiversity and biomass yields are currently being examined in several LMEs, along with observations on the changing states of 'health' of these systems (Sherman 1994). Marine resource problems underscored by UNCED, particularly as they affect human population requirements for nutritional well-being and national economies in coastal nations of Africa, South America and Southeast Asia, are being addressed. Post UNCED, LME-scale programmes for advancement

toward biodiversity sustainability, ecosystem health and economically viable biomass yields are being implemented for several LMEs adjacent to developing nations. The programmes are being supported by international agencies, as part of an effort to couple recent advances in ecological monitoring, management and stress mitigation strategies from the more developed countries with the less developed coastal countries around the margins of the ocean basins.

The GEF, in collaboration with NOAA, IOC, UNEP, FAO, the UK Natural Environment Research Council (NERC), the Sir Alister Hardy Foundation for Ocean Science and scientists from national marine resource agencies of several of the more developed countries (including Belgium, Canada, Denmark, France, Germany, the Netherlands, Norway and the United Kingdom) is assisting developing nations to implement coastal ecosystem assessment, monitoring and mitigation programmes, aimed at providing a scientific basis for improving the prospects for the long-term sustainable development of marine resources (Sherman *et al.* 1992). Two of these programmes are in the advanced planning stage: one for the Gulf of Guinea Ecosystem, brings together five countries of the region (see Box 7.3-5), while the second is being developed jointly by marine specialists from China and Korea for the Yellow Sea large marine ecosystem (Wu and Qui 1993).

7.3.4 Integration with programmes monitoring physical variables

7.3.4.1 Global Terrestrial Observing System (GTOS)

The Global Terrestrial Observing System (GTOS) is a joint initiative by the Food and Agriculture Organization (FAO), the World Meteorological Organization (WMO), the United Nations Environment Programme (UNEP), UNESCO and the International Council of Scientific Unions (ICSU), aimed at improving our understanding of the ways in which terrestrial systems respond to global change. By integrating and expanding existing monitoring sites and systems, GTOS aims to provide a co-ordinated, permanent, observational framework with adequate spatial coverage and temporal continuity to produce data to enable us:

- to detect and understand the impacts of national, regional and global change on terrestrial and freshwater ecosystems;
- to assess the responses of ecosystems to such changes and their role in causing them;
- to quantify and map all changes from local to global scales;
- to assess the consequences of changes for land use, biodiversity, biogeochemical cycles and climate change, and

- to develop, calibrate, validate and operate models from local to global scales (Norse 1994).

GTOS will also support the integrated assessment of changing socio-economic forces and ecosystem responses.

The mechanism proposed for GTOS is a four-level hierarchical observation system (Norse 1994). Level IV will be the least complex, but geographically most extensive, consisting of around 10 000 small (about 1 ha) sites which are to be established globally. These will monitor, at 5–10 year intervals, a few standardized, easily and cheaply measured variables (e.g. soil carbon) using both site visits and remote sensing. Level III will consist of approximately 1000 sites including existing national ecological and monitoring sites and agricultural research stations, selected to represent the major biomes, agro-ecological regions and farming systems. These will provide data on phenology, net primary production and other dynamic variables at sub-annual intervals. Level II sites will also represent major biomes, agro-ecological regions and farming systems. There will be approximately 100 sites, consisting mainly of existing major research centres, which will study a wider range of variables and monitor these more frequently (e.g. the continuous monitoring of fluxes of CO₂ in water). There will be 10–20 Level I sites, including a range of Level II, III and IV sites drawn from recent or ongoing international experiments. These will monitor changes in large-scale processes (e.g. soil transport and the movement of biota).

GTOS should meet both the practical needs of planners and policy-makers and the more comprehensive

requirements of the research community. It will provide a global framework for national ecosystem monitoring schemes, a method for relating local monitoring activities to global processes, and permanent ground truthing stations for the remote sensing of changes in vegetation distribution and related shifts in biological processes (Norse 1994).

Many of the sites and some regional and global ecosystem monitoring networks are already established. This, together with recent advances in data integration and communication systems, should enable GTOS to be 80% operational within five years (Norse 1994).

The Royal Geographical Society in London is developing a Geographical Observation Programme (GOP) to establish five or six permanent field stations to monitor global environmental change, and to provide a platform for local and regional environmental monitoring, research, training and education priorities. GOP will adopt global protocols where they exist and will integrate with GTOS.

7.3.4.2 Global Ocean Observing System (GOOS)

Set up by UNESCO's Intergovernmental Oceanographic Commission, the Global Ocean Observing System (GOOS) is a permanent international system for gathering, processing and analysing oceanographic observations from the open ocean and from coastal and shelf seas. GOOS products will describe and predict the state of the world ocean at regular intervals and will be available to all nations. The system will operate on three geographical scales. Globally, GOOS will provide the observations system and data delivery necessary to produce consistent data sets for ocean-atmosphere coupled with modelling and other global

Box 7.3-5: The Gulf of Guinea Large Marine Ecosystem (LME) Biodiversity Project.

The countries bordering the Gulf of Guinea are presently inhabited by 150 million people. By the year 2000, the number of people may increase to approximately 300 million. The nutritional needs of these people can be met in part from the marine resources produced within the Gulf of Guinea LME. The ecosystem is rich: approximately 1 million metric tons (1 mmt) of fish are caught annually. The economies of the coastal countries are being diversified to accelerate economic growth, employment opportunities and the raising of living standards. However, at present the near-coastal areas of the ecosystem are under growing environmental stress. It is essential to provide a more balanced approach to economic development and the sustainability of marine resources and coastal habitats. The evolving growth of petrochemical, fertilizer, paper products and metals industries has led to significant levels of coastal pollution. To provide a regional framework for mitigating stresses on the ecosystem, the Global Environment Facility, in collaboration with UNDP, UNIDO, UNEP, NOAA and FAO, is supporting a project to conserve marine biodiversity and control water pollution and sustain biomass yields of the Gulf of Guinea LME. The project, to be initiated in late 1995, consists of a core effort to conserve biodiversity by assessing, monitoring and mitigating the stresses on the LME.

The project components will include monitoring the biodiversity of fish and plankton, and ecosystem health. This information will be linked to an over-arching management protocol for linking stress mitigation to economic development. Participating countries include the Côte d'Ivoire, Ghana, Nigeria, Cameroon and Benin. Collaborating scientists, economists and natural resource managers from several of the more industrialized countries (e.g. USA, UK, Germany, Norway, Sweden, Denmark and France) will participate in expediting the transfer of technological advances in ecosystem monitoring and management practices.

products. The main benefits will accrue through the study, monitoring, understanding and prediction of global climate change and global climate monitoring. These global data will be interfaced with regional and national activities, including data gathering, modelling and special applications. The main benefits at these levels will be improved operational and design data for marine industries services and environmental management.

GOOS will gather data by remote sensing, sea-surface and sub-surface instrumentation. If the models used to explain future change are to show adequate precision, the long-term monitoring of the ocean will need to integrate physical, chemical and ecological data. To detect change, it is necessary to have long time series. Monitoring programmes, such as the Continuous Plankton Recorder, will be continued. However, surrogate measures of biological communities, such as acoustics, optical counting and image recognition, need to be developed and calibrated against classical sampling to make appropriate time/space scale measurements in real time. GOOS will provide data from its ecosystem health and living marine resource modules that will contribute to the assessment and monitoring of changes in the biodiversity of fish, shellfish and plankton species groups and ocean conditions.

The development of GOOS requires the testing and operating of many existing and new technological systems in a global suite conveying data on a strict timetable to super-computers which assimilate and analyse the data and then provide descriptions and forecasts of the state of the ocean and coastal seas. Global scientific programmes at present under way or planned include: the World Ocean Circulation Experiment, the Tropical Ocean Global Atmospheric Project and the Joint Global Ocean Fluxes Study. These provide the basis for the design of GOOS. Work is needed in equipment specification, testing and trials development of operational procedures, procurement of equipment and services, and progressive merging and testing parts of the whole system. Equipment, vessels, satellites and personnel will be dedicated to the GOOS by participating nations and will remain under national control.

7.3.4.3 Global Climate Observing System (GCOS)

The Global Climate Observing System (GCOS) was established jointly by the International Council of Scientific Unions, the World Meteorological Organization, UNESCO's Intergovernmental Oceanographic Commission and UNEP to develop an effective system to monitor the world's climate, detect climate change and predict climatic variation and change (Spence 1994). It is recognized that an integrated and comprehensive approach is necessary, incorporating all climate system components: the global atmosphere, the world oceans, the land surface, the cryosphere and the biosphere. The proposed Initial Operational System for GCOS includes:

- existing essential observational components for climate;
- necessary improvements which can be immediately identified and implemented, and
- a comprehensive data system.

All these elements should be operational over the next decade and five advisory panels (covering atmosphere, oceans, land/ecosystem, data and space-based observations) have been established to consider how best to implement the Initial Operating System (Spence 1994). The importance of integrating GCOS with existing research programmes (such as the World Climate Research Programme and the International Geosphere Biosphere Programme) and operational activities (such as World Weather Watch, the Global Atmosphere Watch and the Integrated Global Ocean Services System), as well as with developing programmes such as GTOS and GOOS (see 7.3.4.1 and 7.3.4.2), is also recognized.

Contributing to the establishment of GCOS, a baseline upper-air network of weather observing stations is being developed, alongside a reference surface network. Both of these will optimize the geographical coverage, reliability and quality of records (Spence 1994). GCOS is also co-operating with ocean programmes to increase the numbers and coverage of drifting buoys providing surface observations, and has helped to ensure the continuation of the Tropical Ocean Global Atmosphere Programme as a source of climate data for research and operational prediction.

Ultimately, GCOS will provide an international mechanism for the co-ordination of climate observations and will contribute to capacity-building and training projects for climatic research in participating countries (Spence 1994).

7.3.5 Inventorying and monitoring for conservation

A number of existing international agreements are concerned with inventorying and monitoring ecosystems and species for their safe use and conservation, some of which are discussed here.

7.3.5.1 The Ramsar Convention

The Ramsar Convention (1971) is an international treaty that provides a framework for the co-ordinated designation and conservation of internationally important wetland habitats. As of 1994, 81 states were Contracting Parties to the convention and 654 Ramsar wetlands had been designated, covering an area of over 43 million hectares (Navid 1994). This convention has generally been very successful.

7.3.5.2 CITES

The Convention on International Trade in Endangered Species of Wild Fauna and Flora (CITES) (1973) provides an international legal framework that aims to control, reduce

or eliminate the international trade in threatened species whose numbers and conditions suggest that further removal of individuals would be detrimental to species' survival (Favre 1989). It includes Appendix I which lists those species that are in danger of extinction and banned from international commercial trade, and Appendix II that lists species which might become endangered and for which trade must be effectively regulated. One hundred and thirteen countries are now parties to the convention (WCMC 1992), all of which submit annual reports of their trade in listed species to the Convention Secretariat. From these reports, global levels of trade in species may be assessed and monitored in relation to the state of populations in the wild. CITES also provides information on trends in trade and in routes of trade over the short and long term. CITES has had mixed success, and issues such as the ivory trade have been hotly debated (see also Sections 13.3.5 and 13.6.4).

7.3.5.3 Species Survival Commission (IUCN)

Established in 1949, IUCN's Species Survival Commission (SSC), which now has approximately 3500 members in 135 countries (WCMC 1992), has been very successful. Its aim is to promote action to arrest the loss of the world's biological diversity and to restore threatened species to safe and productive population levels, and it provides an excellent forum through which amateurs and professionals can make a direct contribution. The SSC is divided into 95 Specialist Groups which cover different taxonomic groups, geographical areas or subject areas. The taxon-based Specialist Groups are responsible for reviewing the status and requirements of their taxon and for producing Action Plans for their effective long-term conservation.

7.3.5.4 World Conservation Monitoring Centre (WCMC)

The World Conservation Monitoring Centre (WCMC) was founded in 1988, jointly by the World Conservation Union (IUCN), the United Nations Environment Programme (UNEP) and the World Wide Fund for Nature (WWF), having previously been the IUCN Conservation Monitoring Centre. Its aim is to support conservation and sustainable development by providing technical services and authoritative information on global conservation issues. WCMC's global database includes information on national parks and protected areas, threatened plant and animal species and habitats of conservation concern. WCMC also undertakes research into the status, management and utilization of these resources. This information may then be provided to such groups as scientific institutions, conservation and development organizations, governments, commercial businesses and the media.

7.3.5.5 Red Data Books and Red Lists (IUCN)

The IUCN *Red Data Books*, produced by the SSC in collaboration with WCMC, are a range of authoritative

volumes providing information on the current status and conservation requirements of globally threatened species (see 7.2.8.3.2). For each taxon identified as threatened, the *Red Data Books* give an assessment of its distribution, population status, habitat and ecology and potential conservation measures. The volumes are divided on a taxonomic or geographical basis. To date, along with national volumes, *Red Data Book* publications include: *Dolphins, Porpoises and Whales of the World* (Klinowska 1991), the *ICBP/IUCN Threatened Birds of the Americas* (Collar *et al.* 1992), *Threatened Birds of Africa and Related Islands* (Collar and Stuart 1985), *Threatened Primates of Africa* (Lee *et al.* 1988), *IUCN Invertebrate Red Data Book* (Wells *et al.* 1983), the *IUCN Amphibia-Reptilia Red Data Book* (Groombridge 1982), the *IUCN Plant Red Data Book* (Lucas and Syngé 1978) and *Plant Red Data Book of Rodrigues* (Strahm 1989).

The *Red Lists* for threatened animals are published, generally on a two-year cycle, by WCMC in collaboration with IUCN-SSC and Birdlife International. These volumes provide a global inventory of species or subspecies that are known to be, or are suspected of being, extinct or threatened with extinction in the wild. The information is supplied by the SSC Specialist Groups, national *Red Data Books*, and scientists and naturalists working in the field. The 1994 *Red Data List* contains information on a total of nearly 6000 species (WCMC 1993). However, the species represented are not evenly distributed among taxa. Provisional assessments cover all birds, just over 50% of mammals (but many insectivores, rodents and microbats are not included), 20% of reptiles, 12% of amphibians and under 10% of fish. A small proportion of invertebrate species are also included, mainly dragonflies, butterflies and molluscs (WCMC 1993).

7.3.5.6 Stud Books and the International Species Inventory System

These systems have been designed for monitoring the genetic resources of vertebrates in captivity and facilitate the co-operation of different institutions in management plans for species. Stud books present an international register, listing all the captive individuals of a taxon, to help prevent inbreeding and improve the success of captive breeding programmes. Official stud books are recognized by the IUCN and the International Union of Directors of Zoological Gardens and are co-ordinated through the *International Zoo Yearbook* and the CBSG. In 1991 there were 104 recognized international stud books and five international registers. Since 1984 the stud book system has been supplemented by the International Species Inventory System (ISIS), a global network designed to help the management of zoological collections and to enable zoos to meet their increasing conservation responsibilities (see Section 8.6). ISIS maintains a centralized computer

database of census, demographic, genealogical and laboratory data for wild species held in captivity. The coverage for North America, Europe and Australasia is good but that of Asia, Africa and Latin America needs improvement (see Section 8.6).

7.3.6 Co-ordinating the inventorying and monitoring of genetic resources

Co-ordinated efforts to inventory and monitor genetic variation and resources have so far focused on taxa of economic or aesthetic value, mainly domestic or agricultural species and their wild relatives. Furthermore, until recently efforts were largely aimed at plant genetic resources with animal resources being largely ignored (WCMC 1992). Several groups play an important role in co-ordinating efforts at the genetic level and these are discussed below.

7.3.6.1 The Food and Agriculture Organization of the United Nations (FAO)

FAO has played a major role in research and conservation of forest genetic resources, stimulating many different programmes and initiatives. FAO's Global System for the Conservation and Utilization of Plant Genetic Resources was set up in 1983 to co-ordinate the conservation and use of genetic resources primarily for food and agricultural production (Glowka *et al.* 1994) and includes two major developments:

1. The International Undertaking on Plant Genetic Resources, which aims to ensure the unrestricted exploration, collection, conservation, evaluation and utilization of plant genetic resources, of present and future economic importance, for plant breeding and scientific purposes (Cossalter *et al.* 1993; Glowka *et al.* 1994).
2. The Commission on Plant Genetic Resources (CPGR), which is an international forum of over 125 countries, including representatives of donors and users of plant genetic resources, technology and funds which discusses matters related to plant genetic resources and monitors the implementation of the International Undertaking (Cossalter *et al.* 1993; Glowka *et al.* 1994).

Through the CPGR, international agreements have been, or are being, negotiated in three areas. First, to provide guidelines for the collection and transfer of plant genetic resources. Second, to promote the use of biotechnology for the conservation and sustainable use of plant genetic resources. Third, to place the collections and *ex situ* plant genetic resource bases of different states and institutions under FAO auspices to be held in trust for the global community (Glowka *et al.* 1994).

The Global System also includes the World Information and Early Warning System, a network of *ex situ* collections under the jurisdiction of the FAO and a developing network of *in situ* conservation areas (Glowka *et al.* 1994).

The FAO Panel of Experts on Forest Gene Resources is a statutory body which guides the FAO's activities in this area. It meets every three years and compiles and updates a list of tree species needing priority action in exploration, collection, evaluation, utilization and both *in situ* and *ex situ* conservation (Cossalter *et al.* 1993; Palmberg-Lerche 1994).

The Fourth International Technical Conference on plant genetic resources is scheduled to be organized by FAO in 1996 to examine information on the State of the World's Plant Genetic Resources and discuss an Action Programme on Plant Genetic Resources. Prior to this, a number of regional and sub-regional workshops will be held, covering both crop and forest genetic resources (Palmberg-Lerche 1994). Among the subjects discussed will be the results of a series of questionnaires on the status of crop plant and forest genetic resources sent to all Member States.

By 1994, contractual agreements have been made between FAO and national institutes in several countries to further the assessment, management, monitoring and conservation of the genetic resources of a number of species, including the heart-of-palm (*Bactris* spp.), medicinal forest plants, agroforestry species and rattans (Palmberg-Lerche 1994).

7.3.6.2 The Consultative Group on International Agricultural Research (CGIAR)

Founded in 1971 jointly by the World Bank, FAO and UNDP, CGIAR is a consortium of donor countries, foundations and development banks which supports a network of 16 International Agricultural Research Centres (IARCs) and 227 seed banks in 99 countries (see Section 8.8.4). Most of the IARCs are concerned with the development of crop varieties and conservation of germplasm collections, some of which provide international bases for specific crops.

Both CGIAR and the IARC network have been active in the international co-ordination of activities concerning plant genetic resources (WCMC 1992). Perhaps the most important IARC in this respect is the International Plant Genetic Resources Institute (IPGRI). Originally established in Rome in 1974 as the International Board for Plant Genetic Resources and renamed in 1992, IPGRI has had a co-ordinating role in setting priorities and creating a network of national programmes and regional centres for the conservation of plant germplasm. With the assistance of IPGRI, 90% or more of the known landraces of crops such as wheat, corn, oats and potatoes and an estimated 510 000 accessions, are held by the IARCs and seed banks. IPGRI also has links with over 500 institutes in 106 countries (WCMC 1992).

On a national and regional level, many institutions play an important role in the collection, conservation and investigation of plant genetic resources. These include the Sub-Saharan National Tree Seed Centres of Burkina Faso, Kenya, Rwanda and Zimbabwe; The Plant Genetic Resources Centre in Ethiopia; the ASEAN-Canada Forest Tree Seed Centre in Thailand; CATIE in Costa Rica; Brazil's national research organization for agriculture and forestry, and National Genetic Resources Centre, and the International Centre for Agricultural Research in the Dry Areas in Syria (Cossalter *et al.* 1993). Furthermore, several regional forest genetic resources networks and programmes are now operating, covering areas of Africa, Southeast Asia and Central America and providing international co-ordination and support (Cossalter *et al.* 1993).

7.3.7 Sites for inventorying and monitoring biodiversity

Throughout the world there are many areas that have some degree of protection or other, and many have been designated as national parks or reserves. In addition, other sites have been established for ecological or environmental research. Although many of these are in areas that are of some importance with respect to their biodiversity, or are environmentally sensitive, others have less significance and have been established, at least in part, for non-biological reasons. With limited resources for conservation of biodiversity and increasing demand for lands for development, governments are faced with having to establish priorities for the conservation of land. A number of methods have been developed to help in this prioritization: all are dependent on systematic information from biological inventories (see 7.1.4).

A number of the initiatives discussed above utilize specific sites for inventorying and monitoring and it is clear that there needs to be some sharing of resources and integration of programmes. Probably the most important global system of sites is the Man and the Biosphere network organized by UNESCO. The programme appears to be well positioned to make significant contributions as a resource base for biodiversity assessment, both nationally and internationally, in connection with the marine station networks. Indeed, there exists a significant potential to build a functional international network for biodiversity research related to management from the coastal Biosphere Reserves. MAB intends to contribute to the collaborative efforts designated to detect the responses of marine and coastal ecosystems to global change; to contribute to collaborative research projects on sustainable development at the land-sea boundary; and, in general, to link biosphere reserves to other international marine networks. EuroMAB is undertaking a joint project to create a Biosphere Reserve Integrated Monitoring Network (BRIM) in conjunction with US MAB. Other recently created Biosphere Reserve networks include the Ibero-American Programme (MAB-

CYTED) devoted to biodiversity, the China Biosphere Reserves Network (CBRN-MAB), the Northern Science Network promoting co-ordinated research in Biosphere Reserves, and the MAB-GEF network on Biodiversity conservation in Biosphere Reserves of Central Europe. The activities concentrate on (1) inventorying and monitoring biodiversity, (2) conserving and sustainably using biodiversity, and (3) communication and policy information for decision-makers (Box 7.3-6). However, even with this programme there are large gaps in coverage. For example, there are few biosphere reserves in South America and Africa in the 'hot-spots' or megadiversity countries. If this network is to be used as a base for co-ordinated inventorying and monitoring then it will need to be considerably expanded to included sites in areas such as the southern Guianas, the upper Amazon lowlands, the Zaire Basin and New Guinea.

As has already been stressed in Chapter 7.2, long-term study sites, such as the LTER system in the USA, are essential if monitoring changes are to be effective.

7.3.8 Global co-ordination: GIMP

It is clear from the preceding parts of this chapter that many aspects of inventorying and monitoring are poorly addressed as a result of lack of resources, direction or co-ordination. This problem may be overcome either by expanding the role of existing organizations or by the establishment of an international programme with the specific role of co-ordinating and increasing the effectiveness of inventorying and monitoring efforts. In Box 7.3-7 an outline is suggested for the remit of a Global Inventorying and Monitoring Programme that might address the issues involved. Such a programme should include a periodic global assessment that:

- is all-encompassing, i.e. includes integrated and continuous estimates of grasslands, forests, agricultural lands, wetlands, etc;
- provides biodiversity estimates as they apply to food, fuel, shelter, employment and the environment;
- includes environmental and social considerations in addition to economic factors as noted above;
- reflects the latest technology, data acquisition and sharing, and display, and presents facts so that people can understand and authorities can make rational policy decisions: this would include maps showing: (1) distribution of the Earth's resources, (2) current Earth cover, (3) where pressures exist and predictions of where they will occur in the future, and (4) where opportunities exist for meeting human needs (Lund 1993).

Such a structure might facilitate the links needed between programmes such as GTOS, GCOS, GOOS, DIVERSITAS and Systematics Agenda 2000.

In developing the GIMP, it is our vision that:

1. Each participating country will have the capacity and tools to inventory its resources, provide information for decisions, and monitor the impacts of land and resource management.

Box 7.3-6: UNESCO's Man and the Biosphere Programme and the Biosphere Reserve Network.

UNESCO's Man and the Biosphere (MAB) Programme was launched in 1971 to improve the links between people and the biosphere. Some 110 countries co-ordinate their national contributions under MAB National Committees. MAB's priority themes for 1996–2001 are:

- conserving biodiversity and ecological processes;
- exploring approaches to land-use planning and sustainable management of natural resources in regional landscapes;
- formulating and communicating information on sustainable resource management and promoting corresponding environmentally sound behaviour, and
- building up human and institutional capacities for land-use planning and sustainable resource management.

The idea of co-ordinating studies of natural systems at national, regional and international levels was inherent in the setting up of the International Biosphere Reserve Network, the backbone of the MAB programme. Biosphere Reserves are alternative types of protected areas with a combination of functions including *in situ* conservation of natural and semi-natural areas, sustainable management of natural resources for local people, scientific research and monitoring, and environmental education and training. As of June 1995 there are 324 biosphere reserves located in 82 countries.

The strategic plan for Biosphere Reserves refers specifically to actions for the inventorying and monitoring of flora and fauna. One effort to promote such work has been the preparation of a directory of contacts and environmental databases for Biosphere Reserves in Europe and North America (EuroMAB 1993). Of the 175 Biosphere Reserves in this directory, over 88% had undertaken a biological inventory and possessed collections of local fauna and flora; 86% also monitored climatic parameters, 76% monitored various data on vegetation and 76% monitored wildlife population dynamics. These high figures fall considerably for Biosphere Reserves in some other parts of the world, where the reserves range from long-established sites with good inventories of flora and fauna and monitoring programmes, to new sites which have not had the time to develop such activities, to those that do not possess the capacity to collect such data.

At the regional level, a number of sub-networks of Biosphere Reserves exist, and these undertake inventorying and monitoring of biodiversity as part of their activities.

- The *Observatoire du Sahara et du Sahel* monitors desertification in 20 countries of the Sahara and Sahel region of Africa, emphasizing the human uses of biological resources (OSS, 1994).
- The Ibero-American Network of Biosphere Reserves organized under CYTED (*Programa Ibero-americano de Ciencia y Tecnología para el Desarrollo*) involves 19 countries of Latin America and the Caribbean plus Portugal and Spain and specifically addresses the inventorying and monitoring of biodiversity in the Biosphere Reserves of these countries (Halfiter 1992).
- The Biosphere Reserves Integrated Monitoring system set up for 175 Biosphere Reserves in 32 countries in Europe and North America (EuroMAB) is a compilation of existing inventorying and monitoring activities in these sites that facilitates collaboration among participating scientists (EuroMAB 1993).

As a complement to the terrestrial element of the Biosphere Reserve Network and the growing number of Biosphere Reserves that encompass both terrestrial and marine parts, UNESCO also operates a COstal and MARine programme (COMAR) for scientific research and training in coastal and marine systems (see 7.3.3.3).

Box 7.3-7: Global Inventorying and Monitoring Programme (GIMP).

Priorities for a Global Inventorying and Monitoring Programme would be:

1. To establish and co-ordinate targets and timetables for systematics including making priorities for taxa, revisions, field guides and collection databasing.
2. To establish and co-ordinate rigorous standards for sampling and analysis of all groups of organisms for both inventorying and monitoring.
3. To establish and co-ordinate a network of areas for inventorying and monitoring at different levels of intensity, linking these with existing site networks (e.g. GTOS, GCOS, GOOS) to maximize the utility of data.
4. To establish and co-ordinate priorities for training at all levels (e.g. curator, information technologist, researcher, technician, parataxonomist, paraecologist, volunteer).

2. The international community will have current data for global assessments and research.
3. The information at the country level and international levels will be compatible.
4. National agencies and international groups will play a major role in achieving this vision by sharing the use of talents and resources through a co-ordinated programme that provides needed data, fills gaps and eliminates duplication.

7.3.9 Summary

Informed decisions concerning the mitigation of losses of global biodiversity can best be made when based on sound, scientifically based options. Many of the scientific data on biodiversity are difficult to synthesize because of their fragmentary character, limited comparability and inaccessibility.

Carefully planned standardization and calibrated temporal and spatial inventorying and monitoring efforts are required by the global community of nations in shared international efforts focused on regional efforts to mitigate the loss of global biodiversity.

If inventorying and monitoring of the biodiversity of regions or nations is to be increased to the levels demanded by international agreements such as the Biodiversity Convention and Agenda 21 or by scientific programmes such as DIVERSITAS (IUBS/UNESCO) or Systematics Agenda 2000, then this will require a vast increase in systematic and ecological infrastructure and human resources. Such capacity and infrastructure exceeds the capabilities of even the most advanced nations. In addition, biodiversity is not restricted by political boundaries and there is therefore a need to share expertise and resources.

Few countries have clear programmes to make inventories of their fauna and flora and the tools to identify

organisms. If museums, herbaria and other institutions charged with the task of providing the systematics services for inventorying are to carry out these tasks then they need to be much better resourced, their collections better maintained, and a new cadre of professional researchers and technicians trained and funded. The same is also true for the monitoring of biodiversity. Indeed, in many countries monitoring of biodiversity is almost non-existent.

References

- Alexander, L.M.** 1989. Large marine ecosystems as global management units. In: Sherman, K. and Alexander, L.M. (eds.), *Biomass Yields and Geography of Large Marine Ecosystems*. AAAS Selected Symposium 111. 339–344. Westview Press, Boulder, Colorado.
- American Association for the Advancement of Sciences** 1986. *Variability and Management of Large Marine Ecosystems*. AAAS Selected Symposium 99. Westview Press, Boulder, Colorado.
- AAAS** 1989. *Biomass Yields and Geography of Large Marine Ecosystems*. AAAS Selected Symposium 111. Westview Press, Boulder, Colorado.
- AAAS** 1990. *Large Marine Ecosystems: Patterns, processes and yields*. AAAS Press, Washington, DC.
- AAAS** 1991. *Food Chains, Yields, Models, and management of Large Marine Ecosystems*. Westview Press, Boulder, Colorado.
- AAAS** 1993. *Large Marine Ecosystems: Stress, mitigation, and sustainability*. AAAS Press, Washington, DC.
- Anonymous** 1990. *Sudan Reforestation and Anti-desertification (SRAAD) Pilot Project Procedures Handbook*. The Forests National Corporation, Khartoum, the U.S. Geological Survey, USDA Forest Service and the Sudan Survey Department. United States Agency for International Development.
- Anonymous** 1991. *Systematic Biology Research*. UK House of Lords Select Committee on Science and Technology, 1st Report, HL Paper 22–I. HMSO, London.
- Anonymous** 1994. *Biodiversity. The UK Action Plan*. HMSO, London.

- Bakun, A.** 1993. The California Current, Bengueia Current and Southwestern Atlantic Shelf ecosystems: a comparative approach to identifying factors regulating biomass yields. In: Sherman, K., Alexander, L.M. and Gold, B.D. (eds.), *Large Marine Ecosystems: Stress, mitigation and sustainability*. 199–221. AAAS Press, Washington, DC.
- Barbault, R.** 1994. Biodiversity dynamics and environment. *Biology International* **28**: 18–22.
- Bax, N.J.** and Laevastu 1990. Biomass potential of large marine ecosystems: a systems approach. In: Sherman, K., Alexander, L.M. and Gold, B.D. (eds), *Large Marine Ecosystems: Stress, mitigation and sustainability*. 188–205. AAAS Press, Washington, DC.
- Beddington, J.R.** 1986. Shifts in resource populations in large marine ecosystems. In: *Variability and Management of Large Marine Ecosystems*. AAAS Selected Symposium 99. 9–18. Westview Press, Boulder, Colorado.
- Bibby, C.J.**, Collar, N.J., Crosby, M.J., Heath, M.F., Imboden, Ch., Johnson, T.H., Long, A.J., Stattersfield, A.J. and Thirgood, S.J. 1992. *Putting Biodiversity on the Map: Priority areas for global conservation*. ICBP, Cambridge.
- Bottom, D.L.**, Jones, K.K., Rodgers, J.D. and Brown, R.F. 1989. *Management of Living Resources: A research plan for the Washington and Oregon continental margin*. National Coastal Resources Research and Development Institute, Newport, Oregon. NCRI-T-89-004.
- Bradbury, R.H.** and Mundy, C.N. 1989. Large-scale shifts in biomass of the great Barrier Reef ecosystem. In: Sherman, K. and Alexander, L.M. (eds), *Biomass Yields and Geography of Large Marine Ecosystems*. 143–167. AAAS Selected Symposium 111. Westview Press, Boulder, Colorado.
- CEC (Commission of the European Communities) Directorate General for the Environment, Nuclear Safety and Civil Protection** 1989. *CORINE Database Manual Version 2.2*. Compiled by Whimbrel Consultants CORINE Central Team, CDXI, CEC, Brussels (eds.). Laboratory of Land Management, K.U.L. University, Belgium.
- Coddington, J.**, Hammond, P.M., Olivieri, S., Robertson, J., Sokolov, V., Stork, N.E. and Taylor, E. 1991. Monitoring and inventorying biodiversity from genes to ecosystems. In: Solbrig, O. (ed.), *From Genes to Ecosystems: A research agenda for biodiversity*. 83–117. IUBS, Paris.
- Collar, N.** and Stuart, S.N. 1985. *Threatened Birds of Africa and Related Islands*. ICBP/IUCN Red Data Book. IUCN, Gland, Switzerland and Cambridge.
- Collar, N.J.**, Gonzaga, L.P., Krabbe, N., Nieto Madroño, Na Injo, L.G., Parker, T.A. III and Wegge, D.C. 1992. *Threatened Birds of the Americas*. The ICBP/IUCN Red Data Book Part 2, 3rd edn. ICBP, Cambridge.
- Collette, B.** and Veccione, M. 1995. Interactions between fisheries and systematics. *Fisheries* **20**: 20–25.
- Cossalter, C.**, Thompson, L., Tompsett, P. and Vercoe, T. 1993. *Forest Genetic Resources – An agenda for action*. Consultants' synthesis report to CIFOR, IPGRI and ICRAF on Forestry/Agroforestry Genetic Resources.
- di Castri, F.** and Younès, T. 1990. *Ecosystem Function of Biodiversity*. Biology International Special Issue No. 22, IUBS, Paris.
- di Castri, F.**, Robertson Vernhes, J. and Younès, T. 1992a. The network approach for understanding biodiversity. *Biology International* **25**: 3–9
- di Castri, F.**, Robertson Vernhes, J. and Younès, T. (eds) 1992b. *Inventorying and Monitoring Biodiversity*. Biology International Special Issue No. 27. IUBS, Paris.
- Coghlan, A.** 1994. Costa Rican tree roots out plantation pests. *New Scientist* **16 Apr**: 8.
- Crawford, R.J.M.**, Shannon, L.V. and Shelton, P.A. 1989. Characteristics and management of the Benguela as a large marine ecosystem. In: Sherman, K. and Alexander, L.M. (eds), *Biomass Yields and Geography of Large Marine Ecosystems*. 169–219. AAAS Selected Symposium III. Westview Press, Boulder, Colorado.
- Drichi, P.** 1994. The inception of monitoring woody biomass resources in Uganda–Jinja Peri-urban area as a case study. In: Singh, A. (ed.), UNEP/IUFRO International Workgroup in cooperation with FAO on Developing Large Environmental Data Bases for Sustainable Development, 14–16 July 1993, Nairobi, Kenya. Grid Information Series No. 22. 235–243. UNEP, Nairobi.
- Ejsymont, L.** and Dutkiewicz, D. 1994. *Report of the 20th Annual Meeting of the Advisory Committee of the Plankton Sorting and Identification Center*, 14–16 June 1994, Morski Institute and Sea Fisheries Institute, Poland.
- Environment and Natural Resources Center (ENRIC)** 1994. *A Source Book on Tropical Forest Mapping and Monitoring Through Satellite Imagery: The status of current international efforts*. Datex, Arlington, Virginia.
- EuroMAB** 1993. *ACCESS. A directory of contacts, environmental data bases and scientific infrastructure on 175 Biosphere Reserves in 32 countries*. Department of State Publication 10059. Bureau of Oceans and Environmental and Scientific Affairs, Springfield, Illinois.
- Favre, D.S.** 1989. *International Trade in Endangered Species: A guide to CITES*. Martinus Nijhoff, Dordrecht.
- Food and Agriculture Organization**, Forest Resources Division, 1993. *Forest Resources Assessment 1990: Tropical Countries*. FAO, Rome.
- GLOBEC (GLOBAL Ocean ECOSYSTEMS Dynamics)** 1991. *Report No. 1. Initial Science Plan*. February 1991. Joint Oceanographic Institutions, Washington, DC.
- Glowka, L.**, Burhenne-Guilmin, F. and Synge, H. 1994. *A Guide to the Convention on Biological Diversity*. IUCN, Gland.
- Grassle, J.F.**, Lasserre, P., McIntyre, A.D. and Ray, G.C. 1991. *Ecosystem Function of Marine Biodiversity*. Biology International Special Issue No. 23. IUBS, Paris.
- Groombridge, B.** (ed.) 1982. *The IUCN Amphibia – Reptilia Red Data Book*. IUCN, Gland.
- Gueye, S.** 1993. Concise description of the Senegal forest inventory situation. Abstract. In: Nyssönen, A. (ed.), Proceedings of FAO/ECE meeting of experts on global forest resources assessment in cooperation with UNEP and with the support of FINNIDA (Kotka II), 3–7 May 1993, Kotka, Finland. Research paper 469. Finnish Forest Research Institute, Helsinki.
- Halffter, G.** (ed.) 1992. *La Diversidad Biológica de Iberoamérica I*. *Acta Zoologica Mexicana*. Volumen especial 1992.

- Hammond, A., Tunstall, D., Bryant, D. and Lanou, L.** 1993. *Environmental Information in the Bank: Assessment and recommendations*. World Bank internal document, World Bank, Washington DC [draft].
- Hedberg, C.** 1994. Development of a large-scale forest national database of Uganda. In: Singh, A. (ed.), UNEP/IUFRO International Workgroup in cooperation with FAO on Developing Large Environmental Data Bases for Sustainable Development, 14–16 July 1993. Nairobi, Kenya. Grid Information Series No. 22. 226–234. UNEP, Nairobi.
- Hey, E. and Mee, L.D.** 1993. Black Sea. The ministerial declaration and important step. *Environmental Pollution Law* **2315**: 215–217, 235–236.
- IOC (Intergovernmental Oceanographic Commission).** 1993. *Report of the IOC Blue Ribbon Panel for a Global Ocean Observing System (GOOS). The case for GOOS*. IOC/INF-915 Corr. Paris, 23 February 1993. SC-93/WS3.
- Janzen, D.H. and Hallwachs, W.** 1994. *All Taxa Biodiversity Inventory (ATBI) of Terrestrial Systems. A generic protocol for preparing wildland biodiversity for non-damaging use*. Report of a NSF Workshop, 16–18 April 1993, Philadelphia, Pennsylvania.
- Janzen, D.H., Hallwachs, W., Jimenez, J. and Elmeiz, R.G.** 1993. The role of the parataxonomists, inventory managers and taxonomists in Costa Rica's national biodiversity inventory. In: Reid, W.V., Laird, S.A., Elmeiz, R.G., Sittenfield, A., Janzen, D.H., Gollin, M.A. and Juma, G. (eds), *Biodiversity Prospecting*. 223–254. WRI, Washington DC.
- Jones, T.** 1994. Announcement of the Establishment of EuroLOOP. TECSEC, CAB International, June 1994.
- Jones, T.** 1995. BioNET-INTERNATIONAL Southern Africa LOOP (SAFRINET), A feasibility Study. TECSEC CAB INTERNATIONAL Feb 1995.
- Jones, T. and Cook, M.A.** 1993. Proceedings of the First BioNET INTERNATIONAL Consultation, London, June 1993. CAB International.
- Kelleher, G.** 1993. Sustainable development of the great Barrier reef on a large marine ecosystem. In: Sherman, K., Alexander, L.M. and Gold, B.D. (eds), *Large Marine Ecosystems: Stress, mitigation and sustainability*. 272–279. AAAS Press, Washington, DC.
- Klinowska, M.** 1991. *Dolphins, Porpoises and Whales of the World: The IUCN Red Data Book*. IUCN, Gland, Switzerland and Cambridge, UK.
- Lasserre, P.** 1993. The role of biodiversity in marine ecosystems. In: Solbrig, O.T., van Oordt, P. and van Emden, H. (eds), *Biological Diversity and Global Change*. 105–130. IUBS Monograph Series, Paris.
- Lasserre, P., McIntyre, A.D., Ogdon, J., Ray, G.C. and Grassle, J.F.** 1994. *International Marine Biodiversity Programme: Marine Laboratory Networks for the Study of Biodiversity Function and Management of Marine Ecosystems. Biology International Special Issue* IUBS, Paris (in press).
- Lee, P.C., Thornback, J. and Bennett, E.L.** 1988. *Threatened Primates of Africa: The IUCN Red Data Book*. IUCN, Gland.
- Levin, S.A.** 1993. Approaches to forecasting biomass yields in large marine ecosystems. In: Sherman, K., Alexander, L.M. and Gold, B.D. (eds), *Large Marine Ecosystems: Stress, mitigation and sustainability*. 36–39. AAAS Press, Washington, DC.
- Longino, J.T.** 1994. How to measure arthropod diversity in a tropical rainforest. *Biology International* **28**: 3–13.
- Lucas, G. and Synge, H.** 1978. *The IUCN Red Data Book*. IUCN, Gland.
- Lund, H.G.** 1986. *A Primer on integrating resource inventories*. General Technical Report. WO-49. US Department of Agriculture, Forest Service.
- Lund, H.G. (ed.)** 1993. Proceedings for the *ad hoc* federal agency meeting on international vegetative cover mapping, assessment and monitoring, 5 August 1993, Washington, DC. USFS, Washington, DC.
- Lund, H.G., Evans, D.L. and Linden, D.S.** 1995. Scanned, zapped, timed, and digitized – advanced technologies for measuring and monitoring vegetation diversity. In: IUFRO Symposium Measuring and Monitoring Biodiversity in Tropical and Temperate Forests, 28 August–3 September 1994, Chaing Mai, Thailand (in press).
- Lund, H.G., Jasumback, T., Allison, R. and Falconer, A.** 1991. Taking back the desert. *GGPS World* **2** (6): 24–31.
- Lund, H.G. and Wigton, W.H.** 1995. A primer for designing multiple resource inventory and monitoring programs in the tropics. In: Proceedings AIFM International Conference on Multiple Resource Inventory and Monitoring of Tropical Forests, 21–24 November 1994, Seremban, Malaysia. Asean Institute of Forest Management, Kuala Lumpur, Malaysia (in press).
- Mamo, A., King, G., St-Pierre, L. and Tilimo, S.** 1994. Woody biomass inventory and strategic planning in Ethiopia. In: Proceedings GIS, Vancouver, British Columbia, February 1994. 93–115.
- Mangel, M.** 1991. Empirical and theoretical aspects of fisheries yield models for large marine ecosystems. In: Sherman, K., Alexander, L.M., and Gold, B.D. (eds), *Food Chains, Yields, Models, and Management of Large Marine Ecosystems*. 243–261. Westview Press, Boulder, Colorado.
- May, R.M.** 1988. How many species are there on Earth? *Science* **241**: 1441–1449.
- Mee, L.** 1992. The Black Sea in crisis: a need for concerted international action. *Ambio* **21** (4): 1278–1286.
- Mgeni, A.S.** 1990. Forest resources assessments in Tanzania: current inventory and monitoring methods applied, problems and possible futurology. In: Lund, H.G. and Preto, G. (eds), *Proceedings Global Natural Resource Monitoring and Assessment: Preparing for the 21st century*, 24–30 September 1989. Venice, Italy. 546–556. American Society for Photogrammetry and Remote Sensing, Bethesda, Md.
- Mickevich, M.F.** 1995. *The U.S. Marine Biodiversity Data Base of NOAA/NMFS*. Project Document Description. Office of Resource and Environmental Information, Washington, DC.
- Morgan, J.R.** 1988. Large marine ecosystems: an emerging concept of regional management *Environment* **29** (10): 4–9; 26–34.
- National Research Council (NRC).** 1993. *A Biological Survey for the Nation*. National Academy Press, Washington, DC.
- National Science Board Task Force on Global Biodiversity** 1989. *Loss of Biological Diversity: A global crisis requiring international solutions*. National Science Foundation, Washington, DC.

- Navid, D.** 1994. The legal development of the Convention on Wetlands: getting it right, or the importance of proper legal drafting. 1–4. *Ramsar Newsletter Special Issue* April 1994.
- Norse, D.** 1994. Global Terrestrial Observing System (GTOS). *The Globe* **22**: 6–7.
- NSIF [North Sea Task Force].** 1991. Scientific activities in the framework of the North Sea Task Force. North Sea Environment Report No 4. North Sea Task Force, Oslo and Paris Commission, International Council for the Exploration of the Sea, London.
- Obeid, S.M.H. and Hassan, A.A.E.** 1992. *Sudan Resource Assessment and Development (SRAAD) First Interim Report*. Forest National Corporation, Khartoum.
- OSS** 1994. *Projet de constitution d'un réseau d'observatoires de surveillance écologique à long terme*. IARE, Montpellier.
- Palmberg-Lerche, C.** 1994. *FAO programmes and activities in support of the conservation and monitoring of genetic resources and biological diversity in forest ecosystems*. Invited paper, Symposium on measuring biological diversity in tropical and temperate forests. Chaing Mai, Thailand, 28 August–2 September, 1994.
- Pearce, F.** 1995. Vulnerable habitats 'vanish' from Europe's agenda. *New Scientist* **145** (1968): 8.
- Reid, W.V., Laird, S.A., Elmez, R.G., Sittenfeld, A., Janzen, D.H., Gollin, M.A. and Juma, G.** (eds) 1993, *Biodiversity Prospecting*. WRI, Washington, DC.
- Rudis, V.A.** 1991. Wildlife habitat, range, recreation, hydrology, and related research using forest inventory and analysis surveys: a 12-year compendium. Gen. Tech. Rep. SO-84. US Department of Agriculture, Forest Service, Southern Forest Experiment Station, New Orleans, La
- Sainsbury, K.J.** 1988. The ecological basis of multispecies fisheries, and management of a demersal fishery in tropical Australia. In: Guiland, J.A. (ed.), *Fish population dynamics*, 2nd edn. John Wiley, New York.
- Scully, R.T., Brown, W.Y. and Manheim, B.S.** 1986. The Convention for the Conservation of Antarctic Marine Living Resources: a model for large marine ecosystem management. In: Sherman, K. and Alexander, L.M. (eds), *Variability and Management of Large Marine Ecosystems*. AAAS Selected Symposium 99. Westview Press, Boulder, Colorado.
- Sherman, K.** 1994. Sustainability, biomass yields, and health of coastal ecosystems: an ecological perspective. *Marine Ecology Progress Series* **112**: 277–301.
- Sherman, K., Jaworski, N. and Smayda, T.** (1992) *The Northeast Shelf Ecosystem: Stress, Mitigation and Sustainability, 12–15 August 1991, Symposium Summary*. US Department of Commerce, NOAA Tech. Mem. NMFS-F/NEC-94
- Sherman, K. and Ryan, A.F.** 1988. Antarctic maine living resources. *Oceanus* **31** (2): 59–63.
- Sittenfeld, A. and Elmez R.G.** 1992. Building partnerships to save tropical biodiversity: the INBio-Merck agreement. *Network* **18**: 4.
- Sittenfeld, A. and Villers, R.** 1993. Exploring and preserving biodiversity in the tropics: the Costa Rican case. *Current Opinion in Biotechnology* **4**: 280–285.
- Smart, M.** 1994. The developing role of Ramsar's Monitoring Procedure. *Ramsar Newsletter* **18**: 2.
- Sokolov, V.E., Striganova, B.R., Reshemikov, Y.S. Chernov, Y.I. and Shatunosky.** 1994. Russian National Biodiversity Conservation Programme. *Biology International* **28**.
- Solbrig, O.T.** (ed.) 1991. *From Genes to Ecosystems : A research Agenda for biodiversity*. IUBS, Paris.
- Southwood, A.J.** 1980. The Western English Channel – an inconsistent ecosystem. *Nature* **285**: 361–366.
- Spence, T.** 1994. Global Climate Observing System. *The Globe* **22**: 2–4.
- Stone, T., Schlesinger, P., Houghton, R., and Woodwell, G.** 1994. A map of the vegetation of South America based on satellite imagery. *Photogrammetric Engineering and Remote Sensing* **60** (5): 541–551.
- Strahm, W.** 1989. *Plant Red Data Book for Rodrigues*. Koeltz Scientific Books, Koenigstein.
- Systematics Agenda 2000** 1994a. *Charting the Biosphere*. SA2000.
- Systematics Agenda 2000** 1994b. *Charting the Biosphere: Technical Report*.
- Tang, Q.** 1989. Changes in the biomass of the Yellow Sea ecosystems. In: Sherman, K. and Alexander, L.M. (eds), *Biomass Yields and Geography of Large Marine Ecosystems*. AAAS Selected Symposium 111. Westview Press, Boulder, Colorado.
- United Nations Economic Commission for Europe (UNECE) and Food and Agriculture Organisation of the United Nations (FAO)** 1993. *The Forest Resources of the Temperate Zones*. Volume 1: *General Forest Resource Information*. UNECE/FAO, Geneva.
- UNESCO** 1984. Action plan for Biosphere Reserves. *Nature and Resources* **20** (4): 1–12.
- UNESCO** 1993. *The Biosphere Conference 25 years later*. UNESCO, Paris.
- WCMC** 1992. *Global Biodiversity: Status of the Earth's Living resources*. Chapman and Hall, London.
- WCMC** 1993. *IUCN Red List of Threatened Animals*. B. Groombridge (ed.). WCMC, Cambridge.
- Wells, S.M., Pyle, R.M. and Collins, N.M.** (eds) 1983. *The IUCN Invertebrate Red Data Book*. IUCN, Gland.
- Wille, C.** 1993. Riches from the rain forest. *Nature Conservancy* January/February: 11–17.
- WRI** 1994. *World Resources 1994–95*. Oxford University Press, New York.
- Wu, B. and Qui, J.** 1993. Yellow Sea Fisheries: from single and multi-species management towards ecosystems management. *J. Oceanogr. Huanghai and Bohai Seas*, **11**: 13–17.
- Zhao, S.** 1994. Biodiversity Study in China. *Biology International* **28**: 23–28.

7.4 Capacity building

7.4.1 Introduction

It is clear from this and other Sections of the GBA that if scientists are to attain a better understanding of the distribution and magnitude of biodiversity and are to provide better information on changes in biodiversity for management and sustainable use, then considerable

development of capacity for inventorying and monitoring will be required (see Box 7.4-1). Such problems are addressed in Articles 15.7–15.11 of *Agenda 21*:

- Article 15.7 promotes technical and scientific cooperation in the field of conservation of biological diversity and the sustainable use of biological and genetic resources. It notes that special attention should be given to the development of and strengthening of national capabilities, by means of human resource development and institution-building, including the transfer of technology and/or the development of research and management facilities, such as herbaria, museums, gene banks and laboratories related to the conservation of biodiversity.
- Article 15.7 also promotes national efforts with respect to surveys, data collection, sampling and evaluation, and the maintenance of gene banks.
- Article 15.9 addresses the scientific and technological means of implementation (quoted earlier).
- Article 15.10 addresses human resource development: (a) increase the number and/or make more efficient use of trained personnel in scientific and technological fields and (b) maintain or establish programmes for scientific and technical education and training of managers and professionals, especially in developing countries.
- Article 15.11 addresses capacity building with respect to strengthening existing institutions and/or establishing new ones responsible for the conservation of biological diversity and considers the development of mechanisms such as national biodiversity institutes or centres.

(summarized from Johnson 1993)

Capacity building for the inventorying and monitoring of biodiversity involves four areas in particular: physical infrastructure, human resources, communication, and availability of information. This chapter of the GBA provides an overview of the problems associated with the first two. The third and fourth areas are discussed in Section 9.

7.4.2 Development of institutional capacity

In Section 7.2 the importance of storing and maintaining collections of specimens for all organisms in museums, herbaria and other natural history institutions was stressed as such collections provide the firm base for most

inventorying and monitoring efforts. Section 8 notes that although in many countries there are well established institutions and organizations concerned with the inventorying and monitoring of biodiversity, such as museums, herbaria and botanic gardens, many of these are old, poorly equipped and poorly staffed. For these countries and those without such facilities the development and enhancement of institutional capacity for inventorying and monitoring is essential.

In addition to the strengthening of the infrastructure in such traditional areas as natural history institutions, other kinds of facilities are becoming increasingly more important. In particular, laboratories need to be adequately equipped for genetic surveys and for monitoring of biodiversity.

Many countries are faced with the need to develop their capacity to carry out genetic surveys. Establishing a laboratory for such and staffing it with trained personnel need not be excessively expensive relative to other scientific endeavours and relative to the possible scientific benefits. Older laboratory spaces can often be converted to accommodate molecular research. The initial costs of laboratory facilities will depend largely on the range of molecular techniques that will be required, and once the laboratory is established, the major costs will be for personnel and consumable supplies (Hillis and Moritz 1990; Zimmer *et al.* 1993; Suh *et al.* 1993; Avise 1994).

The growth of genetic surveys for enquiry into and management of biodiversity will necessitate a parallel growth in collections specifically designed to preserve tissues and their macromolecules. The facilities of many traditional natural history collections are being expanded to meet this need. This is critical because the scientific value of these genetic resources is enhanced when preserved with traditional voucher specimens. Like more traditional biological collections, tissue facilities also require constant curatorial attention.

Most countries have some infrastructures in place for conducting inventories and for establishing monitoring programmes, such as national forest survey units. These can be strengthened to help collect biodiversity information (Lund *et al.* in press). It is essential that funding be provided to strengthen these institutions.

The diversity of the biota in countries with tropical forests adds complexity to the practice of inventorying, but the problems encountered are generally financial rather than technical. Tropical foresters, for example, know how to design and implement an effective inventorying and monitoring programme (see, for example, Box 7.1-8, Malaysian Forest Inventory), but infrastructure limitations can make inventories excessively expensive relative to the budgets available for information gathering (Gillespie 1992). Unstable governments further jeopardize the success of long-term monitoring programmes.

Box 7.4-1: Capacity-building for inventorying and monitoring.

Increased inventorying and monitoring is needed for:

- collecting and housing specimens of plants, fungi, animals and microorganisms in natural history institutions;
- maintaining germplasm of crops and breeding populations of animals;
- understanding the status of pests of agricultural, medical and veterinary importance;
- understanding the threatened status of rare and threatened organisms;
- mapping the distribution of organisms and monitoring changes in their distribution;
- monitoring the state of protected and non-protected areas;
- monitoring changes in the patterns and intensity of land use, and
- monitoring levels of pollution.

Other problems with large area or ecosystem inventories include lack of funds, lack of access to some parts of the world and lack of equipment. Critical factors in carrying out such biodiversity inventories include access, availability of information on existing data (e.g. maps, air photograph, past reports), access to technology and equipment (and especially replacement and repair) and training. Lund (1995) provides additional practical guidance in working with people to maximize data collection opportunities and to strengthen infrastructure capacity building.

7.4.3 Human resources and training

7.4.3.1 Local people and volunteers

Although there is clearly a lack of human resources in several aspects of inventorying and monitoring, there are opportunities for lateral thinking. The development of formerly untrained local people as 'parataxonomists' dedicated to the conservation and use of biodiversity in Costa Rica is one very good example. Such empowerment of local people is critical to the management of biodiversity and is often the cheapest and most effective method of achieving the goals of inventorying and monitoring. It is widely argued that the conservation of nature in general is best achieved through the involvement of local people (Janzen *et al.* 1993).

Non-governmental organizations and volunteers sometimes can play a critical role. In Britain for example, the British Trust for Ornithology (BTO) carries out an annual bird census throughout Britain, manned entirely by amateur bird enthusiasts. BTO's monitoring of bird populations over recent years has played an important part in detecting changes in biodiversity in Britain (Anonymous 1994).

Similarly, many inventorying and monitoring projects are supported in the field and laboratory through the

assistance of volunteers provided by organizations such as Earthwatch and youth development organizations such as Raleigh International. With the expansion of ecotourism throughout the developing world, the possible assistance of tourists and other volunteers to help in inventorying and monitoring needs further investigation.

The involvement of non-professionals or local people is enhanced by the development and implementation of simple techniques and simple tools; here butterfly nets and field guides are of more relevance than complicated extraction methods and detailed systematic revisions.

7.4.3.2 Development of a professional scientist cadre

The use of local people and volunteers for inventorying and monitoring should, however, supplement rather than substitute for trained graduate and postgraduate biologists with skills in systematics, ecology and related sciences.

The ability to identify organisms is essential to almost all aspects of biology. Many important organizations have noted the dramatic decline in numbers of systematists and the huge shortfall in skilled professional scientists if inventorying and monitoring is to be carried out at a satisfactory level in the future (Anon. 1991; Coddington *et al.* 1991; National Science Board 1989; di Castri *et al.* 1992a, b; SA2000 1994). The situation has become increasingly acute, first in universities and subsequently in many other developed country institutions, and is now a world-wide problem. Numerous organizations and task forces, such as the National Science Board Task Force on Global Biodiversity of the US National Science Foundation (1989) and the UK House of Lords Select Committee on Science and Technology (Anon. 1991) have concluded that effective management of the problem of declining global

biological diversity is severely hampered by the shortage of systematic biologists to identify, document and classify organisms (SA2000 1994).

In the UK, the number of scientists undertaking taxonomic or biosystematic research dropped from 552 in 1980 to 514 in 1990 (Anonymous 1991). The age spectrum of those still in post was also a matter for concern. In 1990, 63% were over 46 years old and only 8% under 35 years. The number of biosystematists in universities has halved each decade (Claridge and Ingrouille 1992). Gaston and May (1992) point out that if the same demographic trends were found in a newly discovered lemur, specimens would be brought into a zoo and a captive breeding programme initiated. The decline in the numbers of biological systematists in universities results in a consequent scarcity of relevant undergraduate and postgraduate programmes.

Systematics Agenda 2000 (1994) makes proposals for addressing this situation, for example by funding graduate students to work with the older existing specialists before they retire to ensure that their skills and knowledge are not lost.

Training merits special attention, and the use of biological systematists employed in museums and other institutions as specialist lecturers and supervisors of graduate students is to be encouraged. Short courses can be of immense value in imparting particular skills, and in training parataxonomists. The training of the professionals necessary to provide the skills base for biodiversity assessments world-wide is long-term. Following the completion of a PhD programme, in most groups of organisms, an aspiring specialist needs time to become thoroughly familiar with a wider complex literature, and experience a greater range of material: this is a lengthy process. Janzen (1993) estimated the cost of producing a trained taxonomist at US\$500 000 over ten years. Replenishing the human resource requires consideration in the development of national biodiversity action plans if they are ever to be effectively implemented.

To remedy the problem of the lack of skilled professionals in systematic biology in developing countries, it is imperative that local natural history institutions be strengthened and that linkages with institutions in the developed nations be established. Several developed countries have established programmes to assist the training of systematists, for example, the US has established Partnerships for Enhancing Expertise in Taxonomy (PEET) (Box 7.4-2).

Similarly, there is a shortage of skilled professionals for monitoring biodiversity. It is therefore important to build on existing structures to increase human resources in this field. The FAO Forest Resource Assessment for example, which has been built on the existing forest inventory programmes in many countries, and ongoing fisheries surveys conducted from research vessels of most coastal

nations, could be used to carry out broader biodiversity inventories of terrestrial and marine organisms.

In the UK the 'Darwin Initiative' has been established to help in training scientists in developing countries in many areas of biodiversity including inventorying and monitoring.

7.4.4 Conclusions

To maximize the resources and talents available for large area inventorying and monitoring in developing and emerging nations, those nations should consider:

- adopting a centralized or semi-centralized approach in the short term, to be matched by the international development community so as to establish an operational monitoring capability for remote sensing land cover within the national resource management agencies;
- involving national resource management agencies in the monitoring programme both as regards classification and validations and accuracy assessment;
- providing unrestricted access to the results of biodiversity surveys and supplying the output in a variety of media.

Donor organizations should:

- set an example by following international standards and guides, and by harmonizing data and making it available to the international community;
- work to establish inventory, assessment and monitoring activities that are compatible with each other;
- promote country capacity building, by helping nations develop to inventory and monitoring capabilities that will meet not only national needs but also international needs: this will be achieved through sharing of equipment, data acquisition, methodology training and on-site technical assistance on data base management, and through technology transfer;
- provide technical help in species identification and classification, image processing, analysis, vegetation mapping and use of geographic information systems, and
- provide guidance and expertise in field sampling efforts for vegetation resource inventory and monitoring.

7.4.5 Summary

- If inventorying and monitoring of the biodiversity of regions or nations is to be increased to the levels

Box 7.4-2: Human and informational capacity development: Partnerships for Enhancing Expertise in Taxonomy (PEET).

Recognizing the need to develop expertise for identifying and inventorying the Earth's biota, the US National Science Foundation has launched a new programme, Partnerships for Enhancing Expertise in Taxonomy (PEET). PEET aims to develop scientists who are experts in those taxonomic groups – such as microorganisms, fungi and most invertebrates – that are relatively under-studied but are critical elements of food chains and ecosystems. The high proportion of unrecognized, undescribed species in these groups limits research and progress in many areas of the biological sciences. PEET also supports the production of electronic databases about these under-studied groups, in order to produce knowledge bases with broad accessibility to the scientific community.

Each five-year PEET project includes three components:

- Taxonomic research on organisms that are little studied or for which taxonomic expertise is limited or vanishing, such as fungi, nematodes, molluscs, insects, bacteria and protists.
- Training of at least two student taxonomists (at the undergraduate, graduate, and/or postdoctoral levels) as experts on the organisms under study: emphasis is placed on including experts-in-training from biodiversity-rich developing countries.
- Preparation of computerized resources, such as specimen databases, artificial intelligence systems, computer-aided image analysis, and interactive keys.

PEET will help to reverse the loss of systematic expertise – caused by such factors as the retirement of taxonomic specialists, shifts in academic recruitment and staffing, and reduction in graduate training programmes in systematics – that is needed to characterize biodiversity and aid in its rational use.

demanding by international agreements such as the Convention on Biological Diversity and *Agenda 21* or by scientific programmes such as DIVERSITAS (IUBS/UNESCO) or Systematics Agenda 2000, then this will require a major increase in systematic and ecological infrastructure and human resources. Such capacity and infrastructure at present exceeds the capabilities of even the most advanced nations. In addition, biodiversity is not restricted by political boundaries and expertise and resources need to be shared.

- Few countries have clear programmes to make inventories of their own biota, or the tools to identify the organisms involved. If natural history institutions charged with the task of providing the taxonomic services for inventorying are to carry out these tasks then they need to be much better resourced, their collections better maintained, and a new cadre of professional researchers and technicians trained and funded.
- Similarly, few countries have adequate programmes to monitor biodiversity, whether in protected or non-protected areas. Additional resources are required to develop human and physical capacity for such monitoring.

References

- Anon.** 1991. *Systematic Biology Research*. UK House of Lords Select Committee on Science and Technology, 1st Report, HL Paper 22-I. HMSO, London.
- Anon.** 1994. *Biodiversity. The UK Action Plan*. HMSO, London.
- Avise, J.C.** 1994. *Molecular Markers, Natural History and Evolution*. Chapman and Hall, New York.
- Claridge, M.F.** and Ingrouille, M. 1992. Systematic biology and higher education in the UK. In: *Taxonomy in the 1990s*. 39-48. The Linnean Society, London.
- Coddington, J., Hammond, P.M., Oliveri, S., Robertson, J., Sokolov, V., Stork, N.E.** and Taylor, E. 1991. Monitoring and inventorying biodiversity from genes to ecosystems. In: Solbrig, O. (ed.), *From Genes to Ecosystems: A recent agenda for biodiversity*. 83-117. IUBS, Paris.
- di Castri, F., Robertson Vernhes, J.** and Younès, T. 1992a. The network approach for understanding biodiversity. *Biology International*, **25**: 3-9.
- di Castri, F., Robertson Vernhes, J.** and Younès, T. (eds) 1992b. *Inventorying and Monitoring Biodiversity*. Biology International Special Issue No. 27. IUBS, Paris.
- Gaston, K.J.** and May, R.M. 1992. Taxonomy of taxonomists. *Nature* **356**: 281-282.
- Gillespie, A.J.R.** 1992. Tropical forest inventories: status and trends. In: *American Forestry – An evolving tradition*. Proceedings of the Society of American Foresters National Convention, 25-27 October 1992, Richmond, Va. 67-71. Society of American Foresters, Bethesda, Md.

- Hillis, D.M. and Moritz, C. (eds)** 1990. *Molecular Systematics*. Sinauer Associates, Sunderland, Mass.
- Janzen, D.H.** 1993. Taxonomy: universal and essential infrastructure for development and management of tropical wildland biodiversity. In: Sandland, O.T. and Schei, P.J. (eds), *Proceedings of the Norway/UNEP Expert Conference on biodiversity, Trondheim, Norway*. 100–113. NINA, Trondheim.
- Janzen, D.H., Hallwachs, W., Jimenez, J. and Elmez, R.G.** 1993. The role of the parataxonomists, inventory managers and taxonomists in Costa Rica's national biodiversity inventory. In: Reid, W.V., Laird, S.A., Elmez, R.G., Sittenfield, A., Janzen, D.H., Gollin, M.A. and Juma, G. (eds), *Biodiversity Prospecting*. 223–254. WRI, Washington, DC.
- Johnson, S.P. (ed.)** 1993. *The Earth Summit: The United Nations Conference on Environment and Development (UNCED)*. Graham and Trotman/Martinus Nijhoff, London.
- Lund, H.G.** 1995. The far side of integrating resource inventories – people and politics. In: Köhl, M., Bachmann, P., Brassel, P. and Preto, G. (eds), *The Monte Verita' Conference on Forest Survey Designs. "Simplicity versus Efficiency" and Assessment of Non-Timber Resources*, Monte Verita, Ascona, Switzerland. 11–26. Swiss Federal Institute for Forest, Snow and Landscape Research. 2–7 May 1994. Birmensdorf, Switzerland.
- Lund, H.G., Rudis, V., and Stolte, K. (in press)**. Plots, pixels, and partnerships: potential for modelling, mapping and monitoring biodiversity. In: *Proceedings, SI/MAB International workshop measuring forest biodiversity*. 23–25 May 1995. Smithsonian Institution, Washington, DC.
- National Science Board Task Force on Global Biodiversity** 1989. *Loss of Biological Diversity: A global crisis requiring international solutions*. National Science Foundation, Washington, DC.
- Systematics Agenda 2000**. 1994. Produced by Systematics Agenda 2000. A Consortium of the American Society of Plant Taxonomists, the Society of Systematic Biologists, and the Willi Hennig Society, in co-operation with the Association of Systematics Collections, New York.
- Suh, Y., Blake, J.A. and Braun, M.J.** 1993. Equipping and organizing comparative molecular genetics laboratories. In: Zimmer, E.A., White, T.J., Cann, R.L. and Wilson, A.C. (eds), *Molecular Evolution: Producing the biochemical data*. Methods in Enzymology 224: 3–22. Academic Press, New York.
- Zimmer, E.A., White, T.J., Cann, R.L. and Wilson, A.C. (eds)** 1993. *Molecular Evolution: Producing the biochemical data*. Methods in Enzymology 224. Academic Press, New York.
-

8

The Resource Base for Biodiversity Assessments

D.L. HAWKSWORTH

Lead Author:

D.L. Hawksworth

Contributors:

*B. Aguirre-Hudson, B. Barlow, B. Boom, T. Cullen, M.N. Dadd, J. Engels,
N.R. Flesness, D. Gordon, J. Hall, J. Hanson, G. Hinkle, P.K. Holmgren, S. Lanou,
P. Lasserre, G. Pattison, D. Smith, M.L. Sogin, H. Sugawara, D. Sumithraarachchi,
P. Wyse Jackson*

CONTENTS

Executive Summary	549	8.7 Marine stations	577
8.0 Introduction	551	8.7.1 Marine stations and the marine realm	577
8.1 Historical considerations	551	8.7.2 Marine stations as biodiversity observatories	577
8.2 Protected area systems	552	8.7.3 Existing networks	577
8.3 General biological reference collections	554	8.8 Genetic resource collections	578
8.3.1 Introduction	554	8.8.1 What are genetic resource collections?	578
8.3.2 Distribution and dimensions of biological reference collections	555	8.8.2 Management of genetic resource collections	578
8.3.3 Preservation methods	564	8.8.3 Types of genetic resource collection	579
8.3.4 Accessibility of biological reference collections	564	8.8.4 Content of existing genetic resource collections	579
8.3.5 Collection health	565	8.8.4.1 Plant genetic resources	579
8.3.6 Costs of biological reference collections	565	8.8.4.2 Livestock	588
8.4 Information resources	565	8.8.4.3 Fungi and other microorganisms	588
8.4.1 Libraries	565	8.8.5 Constraints	590
8.4.2 Electronic media	566	8.8.6 The development of genetic resource collections	590
8.4.3 Directories of biodiversity information	566	8.8.6.1 Plants	590
8.4.4 Catalogues, indexes and registers for described species	567	8.8.6.2 Livestock and other animals	591
8.4.5 Identification aids	568	8.8.6.3 Fungi and other microorganisms	591
8.5 Living plant collections	568	8.9 Sequence databanks	591
8.5.1 Types of living plant collection	568	8.10 Human resources	593
8.5.2 Botanic garden and arboretum collections	568	8.10.1 The magnitude of the resource	593
8.5.2.1 What is a botanic garden?	568	8.10.1.1 Biosystematists	593
8.5.2.2 The extent, distribution and resources of botanic gardens	571	8.10.1.2 'Amateurs'	594
8.5.2.3 Botanic garden networks and linkages	572	8.10.1.3 Parataxonomists	594
8.5.2.4 What plants are in botanic garden collections?	572	8.10.1.4 Indigenous peoples	595
8.5.2.5 Conservation programmes	573	8.10.2 The deployment of the resource	595
8.5.2.6 Further sources of information	573	8.10.2.1 Geographic deployment	595
8.5.3 National plant collections	573	8.10.2.2 Subject deployment	595
8.6 Zoological gardens, insectaries and aquaria	576	8.10.3 Productivity and working practices	596
		8.10.3.1 Productivity	596
		8.10.3.2 Improving working practices	597
		Conclusions	598
		References	598
		Acknowledgements	605

EXECUTIVE SUMMARY

A wide variety of protected areas, scientific collections, living collections, genetic resource collections, information and human resources is necessary for biodiversity assessments at all levels. In general, these resources are in need of significant enhancement if nations are to be able to meet the obligations of the Convention on Biological Diversity.

- The number of protected sites is substantial, with no fewer than 8715 located in the tropics.
- Fewer than 5% of protected sites have been thoroughly inventoried for even one major group of the biota, and this restricts their value for the understanding and conservation of biodiversity.
- Biosystematic reference collections are the material basis for biodiversity assessments; they include anchors for the application of scientific names ('type collections') and a wealth of information relevant to inventory production and distributional studies.
- While there are some 2.5 billion specimens in such collections world-wide, most are in Europe and North America. They are generally undersourced and the data in them are difficult to access.
- The major documentation of biodiversity is located in developed countries: the number of pertinent periodicals alone is almost 13 000, and few libraries hold more than a fraction of these.
- Electronic services and delivery systems (on-line and CD-ROM) can facilitate access and document supply for post-1970 works, but vital earlier literature is not available in such formats.
- An estimated 1600 botanic gardens together hold over 4 million accessions which represent about 80 000 species of plants, i.e. about 30% of the known species and 25% of the estimated species on Earth.
- Extensive collections of cultivars exist, also mainly in developed countries.
- There are more than 2000 zoos, insectaries and aquaria world-wide, roughly two-thirds of which are in developed countries: 500 of these collectively hold 5900 species.
- Marine stations are widely distributed, and include a considerable number in the tropics. These are linked by a number of active regional networks.
- Genetic resource collections – repositories of living organisms, generally in a dormant or other phase where they are not actively growing – consist predominantly of species currently used by humans.
- Plant germplasm collections amount to some 4.32 million accessions. They represent some 6000 species, but about 3 million of the accessions relate to only about 100 species.
- In microbial groups, genetic resource collections are often the only practical source of species for research and evaluation purposes, and some permanently preserved cultures maintained in such collections can also be the 'types' of scientific names.
- The 482 collections of living cultures of fungi and other microorganisms collectively hold 786 328 strains representing the 3100 valid bacterial species, about 17% of the known fungi, and relatively smaller proportions of algae, protozoa and viruses.
- Molecular data are increasingly used in the objective assessment of biodiversity, and the sequence data generated are made available by particular centres for world-wide consultation on the Internet.
- Molecular libraries have a particular value for the retention of sequences of uncultured or unculturable bacteria and other microorganisms for which the sequence 'fingerprint' is often all that is known.
- The human resource required for biodiversity assessments includes biosystematists, 'amateurs', parataxonomists and indigenous peoples.

- While there may be 20 000–30 000 biosystematists world-wide, the number involved in the description of newly discovered species is about 7000, mostly based in Europe and North America, and has an age profile indicative of a declining population.
 - There is a major mismatch between the number of described species in different groups and that of the specialists working on them. The mismatch is even more striking when estimated rather than described species are considered.
 - The rate of description of new species has remained almost constant for the last 25 years. At the current rates of description it would take 575 years (i.e. until 2570) to describe the remaining unnamed 11.9 million species on Earth – *provided* that much of the workforce was redeployed to work on the most species-rich groups.
 - Progress on major floristic and faunistic projects, and biosystematic revisions, is slowed by current working practices and limited access to data. Lists of accepted species names in all groups, compilations of data in reference collections, improved bibliographic services, and simplified nomenclatural procedures would facilitate this work.
-

8.0 Introduction

This Section assesses the variety of resources and infrastructure available for biodiversity assessments including conservation, with a particular emphasis on those concerned with inventorying and monitoring and with the examination of the magnitude and distribution of biodiversity. In addition to discussing the nature and range of the resources available, the Section also considers their extent and adequacy for the tasks now to be addressed. Further details in Sections 2, 7 and 13 complement this assessment and are cross-referenced as appropriate in the text.

8.1 Historical considerations

The human, institutional and collection resources required for the assessment of the magnitude and distribution of biodiversity at its various levels are extremely diverse. Many of the key resources have, however, come to be concentrated in Europe and North America as a result of the history of exploration of Earth's biodiversity, although increasing numbers of countries in other regions have made significant progress in developing their own collection resources, for example Australia, Brazil, Costa Rica, India, Indonesia, Japan, Kenya, People's Republic of China, South Africa and Zimbabwe.

The tradition of collecting and documenting life on Earth has a long history from Egyptian times onwards. Accounts of medicinal and food plants appear in Aztec and Mayan codices and Chinese herbals; printed accounts with descriptions started to appear in the late fifteenth century; and in the first quarter of the sixteenth century, numerous herbals were produced in Europe. Initially these focused on plants of pharmacological value, but extended in the mid-sixteenth century to more general surveys, and by the end of the century a wide range of imaginatively illustrated treatments based on species in particular regions or systematic groups was available in Europe (Arber 1953; Burdet 1985).

The pace of collection and documentation accelerated through the periods of great exploratory voyages in the seventeenth and eighteenth centuries, and reached its zenith in the late nineteenth century. Sea captains were often also charged with collecting material and it became the norm for major seafaring expeditions to include a naturalist amongst their number: for example Sir Joseph Banks on Cook's *Endeavour* voyage which included much of the South Pacific in the years 1768–71, and Charles Darwin on HMS *Beagle* in 1831–36 (Tourtellot 1987). There were also spectacular overland expeditions, for example the exploration of the area between the Mississippi and the Pacific coast of North America by M. Lewis and W. Clark in 1804–6 and the celebrated voyages of Alexander von Humboldt in tropical America in 1799–1804.

Collections were generally brought back to the then European colonial powers, where major museums, collections of dried plants ('herbaria') and botanic gardens were founded and grew dramatically. Publications based on the collections were also produced almost exclusively in those countries.

This pattern has meant that the key reference collections and publications relating to the earliest periods of naming of the biota of the world are concentrated in Europe. Substantial collections have been developed subsequently in Australia, India, South Africa and especially the USA, and while these contain an immense amount of material relevant to biodiversity assessments (see 8.3.4 and Tables 8.3-1, 8.3-2), these do not include material from the first explorations – including the name-bearing 'type' specimens that anchor the application of the names of species. While this presents difficulties for countries in retrieving information directly related to the assessment of their biodiversity, it also has to be remembered that institutions able to store collections and publish on them did not exist in much of the world in the first period of expansive exploration. However, there are important institutions in other regions which do have major natural history collections, such as those in Bogor, Calcutta, Guangzhou and Nairobi, but it should be noted that maintaining collections, and paper materials, in tropical situations requires particular care as under warm and humid conditions they are more vulnerable to damage by termites and other insects and by mould fungi (Fosberg and Sachet 1965).

Species distributions do not conform to national boundaries, and as name-bearing types are the standards for the communication and application of scientific names, ease of access is an important consideration. Examining the locations of the name-bearing type specimens of newly published species gives a good idea of current practices in assembling reference collections. To locate such specimens it is usually necessary to look at the original publications of the names. However, in the case of the fungi, the *Index of Fungi* has since 1991 indicated the institutions where the primary name-bearing type material of newly described fungi has been deposited. Of 5573 newly described fungi, the name-bearing types of 2273 (41%) were deposited in collections other than those in the country of origin of the material (Hawksworth and Kirk 1995). For other groups, standard indices of names (Box 8.1-1) do not include such data so it is unclear to what extent this is a general problem. Where material is deposited in the country of origin, duplicates are also regularly deposited in the major world reference collections and a good argument can be made for continuing this practice in order to facilitate authoritative identifications and biosystematic research (Holloway 1983).

Box 8.1-1: Principal catalogues and indices of names of living species (all groups of organisms, excluding works dealing with fossils only).

'Algae' [incl. cyanobacteria]

Dawson (1962), De Toni (1889–1924), Drouet and Daily (1956), Vanlangingham (1967).

Bacteria [excl. cyanobacteria]

International Journal of Systematic Bacteriology (1980) on, Skerman, McGowan and Sneath (1989).

Bryophytes [anthocerotous, mosses, liverworts, etc.]

Bonner (1962 on), van der Wijk, Margadant and Florschütz (1959–69).

Flowering plants and ferns

Christensen (1906–65), Jarrett (1985), *Index Kewensis* (1895 on), *Kew Index* (1986 on).

Fungi [incl. lichen-forming fungi, slime moulds, and yeasts]

Deighton (1969), Hawksworth (1972), *Index of Fungi* (1940 on), Kirk (1985), Lamb (1963), Petrak (1930–44, 1950), Saccardo (1882–1931, 1972), Zahlbruckner (1921–40).

Viruses

Virus Identification Data Exchange (VIDE).

Animals [all groups covered by the International Code of Zoological Nomenclature] Neave (1939–93), Sherborn (1902–33), *Zoological Record* (1865 on).

8.2 Protected area systems

As countries plan their implementation of the Convention on Biological Diversity, the importance and relevance of protected area systems that encompass representative habitat types, conserve key biological resources, and allow for sustainable development initiatives has been reinforced. Protected areas, mainly established over the last 50 years, have varying degrees of legal protection and infrastructural support in terms of staff, equipment and budget, and collectively represent an important mechanism by which national investments in biodiversity can be assessed and monitored (McNeely 1993, 1994).

A major review of protected area systems has been prepared by McNeely *et al.* (1994), while more recent

statistics are provided by IUCN (1994a). This latter report, jointly prepared with the World Conservation Monitoring Centre (WCMC), shows that there are currently 9832 protected areas, covering more than 9.25 million km² – about 8.2% of the land on Earth. Protected sites are found in most of the biogeographical provinces defined by Udvardy (see Sections 2.3 and 13.4.2), and in all the major biome types, although their distribution is far from even politically or biologically. For a summary of the status of protected area systems, refer to IUCN (1992, 1994a), McNeely (1994), McNeely *et al.* (1994) and see Section 13.4.2.

Protected areas are classified by IUCN (1994b) under six broad management categories (see Box 8.2-1; Box 13.4-1).

Box 8.2-1: 1994 IUCN protected areas management categories.

- Category I** Strict Nature Reserve / Wilderness Area: protected area¹ managed mainly for science or wilderness protection.
- Category Ia** Strict Nature Reserve: protected area managed mainly for science.
- Category Ib** Wilderness Area: protected area managed mainly for wilderness protection.
- Category II** National Park: protected area managed mainly for ecosystem protection and recreation.
- Category III** Natural Monument: protected area managed mainly for conservation of specific natural features.
- Category IV** Habitat/Species Management Area: protected area managed mainly for conservation through management intervention.
- Category V** Protected Landscape/Seascape: protected area managed mainly for landscape/seascape conservation and recreation.
- Category VI** Managed Resource Protected Area: protected area managed mainly for the sustainable use of natural ecosystems.

1. A protected area is defined in the new *Guidelines for Protected Area Management Categories* (IUCN 1994b) as: an area of land and/or sea especially dedicated to the protection and maintenance of biological diversity, and of natural and associated cultural resources, and managed through legal or other effective means.

These range from strict nature reserves, managed primarily for scientific research and/or environmental monitoring, to managed resource protected areas, established for the long-term protection and maintenance of biological diversity, as well as providing for the sustainable flow of natural products and services to meet community needs. Within these six generic categories are hundreds of country-specific designations of protected areas, many of which have the potential to provide locations for research and monitoring activities. In addition, there are three international initiatives, namely the World Heritage Convention, UNESCO Man and the Biosphere Programme, and Ramsar Convention, and regional agreements such as ASEAN (Association of Southeast Asian Nations) and the African Convention on the Conservation of Nature and Natural Resources by which natural sites can be designated as being of global and regional importance. Such sites are usually designated for special protection under national arrangements and classified under the IUCN system accordingly (for further details on these see Section 7.3).

The Man and the Biosphere (MAB) Programme, which was launched by UNESCO in 1976 as a global programme of international scientific co-operation dealing with people-environment interactions over the entire range of bioclimatic and geographic situations of the biosphere (Robertson-Vernhes 1993), is of particular interest because of its scale. One of the central tenets of the MAB Programme is the establishment of a global network of biosphere reserves to cover all of the world's major ecosystems, and by January 1994 there were 324 biosphere reserves in 82 countries, covering some 2 115 000 km². The past role and future objectives of this programme were discussed during an International Conference on Biosphere Reserves in Seville, Spain in 1995, which adopted ten key directions as the foundations of the new 'Seville Strategy' to develop its three main functions of conservation, development and logistical support (Seville Strategy for Biosphere Reserves, 1995). This is discussed further in Section 7.3 (also see Box 7.3-6).

At the national and provincial level, considerable progress has been made in completing protected area systems, so that they are representative of major landforms, habitats or ecosystems. For example, in south and south-east Asia the protected sites network has increased by more than 500 new protected areas covering some 130 000 km² since 1982 (McNeely *et al.* 1994); and Canada's federally approved 'Green Plan' has established a target of setting aside 12% of the country as protected space, and completion of the national parks system by the year 2000 (Environment Canada 1991). However, out of the total 8641 protected areas designated, 56% are found in temperate regions of the world (North America 1410, Europe 2245, East Asia 1162), and only 26% in tropical regions. If analysed by surface area similar percentages are

obtained (McNeely *et al.* 1994; see also Section 13.4.2.1.1).

In addition to state administered protected areas, other sites are protected by a range of other measures. These include private or community-based protected areas, private land management agreements and covenants, and sites recognized by local people as having long-term heritage or sacred significance (e.g. Gadgil 1991). In New Zealand, for example, there are about 2000 sites in these categories, many of considerable value for biodiversity conservation, protected as covenants under the Queen Elizabeth II National Trust through voluntary management agreements (Given 1994).

By comparison with terrestrial areas, marine protected areas lag behind in concept, legislation, management and public awareness. The Law of the Sea has given responsibility to each coastal nation for resource conservation within its Exclusive Economic Zone (up to 200 miles from the shore). These coastal-marine ecosystems comprise approximately 30% of the Earth's surface, including 40% of the ocean (Ray and Gregg 1991), yet the world list of National Parks and Protected Areas jointly compiled by IUCN and WCMC (1990), lists only 2200 coastal and strict marine nature reserves, national parks, natural monuments, managed nature reserves/wildlife sanctuaries and protected landscapes. Moreover, fewer than 13% of these were solely marine protected areas (Ray and McCormick-Ray 1994).

It is difficult to assess objectively the effectiveness of the protected area systems as a resource because of the limited documentation available on the organisms present within them. In 1992, the World Conservation Monitoring Centre carried out a study on the Status of Plant and Animal Inventories for Protected Areas in the Tropics (WCMC 1994). Based on a preliminary search of information held at WCMC, the survey revealed that only 5% of the protected areas in the tropics had been inventoried for one or more groups of organisms. The best-recorded groups, in descending order, were birds, mammals, flowering plants, reptiles, amphibians, freshwater fish and butterflies. The study concluded that protected areas in tropical regions are poorly described in terms of their plants and animals, and that the majority of inventories that do exist are of a preliminary not a comprehensive nature. This situation is not peculiar to the tropics: even in Europe and North America no single site has yet been fully inventoried for all organisms present (see Section 7.1.4.2 and Table 7.1-1). This is the aim of the All-Taxa Biodiversity Inventory (ATBI), to be carried out in conjunction with site-based protocols for setting up very large blocks of wildland biodiversity for non-damaging development (Janzen and Hallwachs 1994; see also Section 7.2.9.2 and Box 7.2-5).

The lack of knowledge as to what is already included in protected areas represents a serious limitation in current

attempts to assess the effectiveness of the system both in terms of the species protected and whether or not they are being safeguarded. However, there are two encouraging trends in support of protected area initiatives, particularly in the context of biodiversity assessments. The first is the identification of key data sources and the collation of such materials, particularly through GIS systems (see Sections 7 and 9). This is being accompanied by a move to make such materials more accessible, such as making data sets available through Internet. The second is a process being engaged in by many protected area agencies to identify the type and level of detail of information on indicators which would allow for effective management, monitoring, and non-damaging use (see sections 7 and 13). At the global level, this is resulting in the development of generic data models to collect and manage biodiversity information at the site level (e.g. INBio and Guanacaste ATBI site in Costa Rica; see homepage <http://www.inbio.ac.cr/GCA.ATBI>). Organizations such as the World Conservation Monitoring Centre (WCMC) and the Intergovernmental Oceanographic Commission of UNESCO (IOC 1993), are beginning to give

attention to this development, the former for terrestrial protected areas, the latter for coastal and marine ecosystems.

In addition to protected areas, systems of permanent plots for periodic inventorying are also important for biodiversity assessments. These have been developed, for example, for forests, through the Smithsonian Institution and Man and the Biosphere Programme (Dallmeier 1995; Dallmeier and Comiskey 1995; see also Sections 7.2.2.2 and 7.2.9), and some US initiatives such as the Forest Health Monitoring (FHM), Forest Survey Inventory (FIA), National Resources Inventory (NRI) Plots and remote sensing programmes as discussed by Lund *et al.* (in press).

8.3 General biological reference collections

8.3.1 Introduction

Biological reference collections, and their associated libraries and staff, are the major tools necessary for basic investigation and assessment of biodiversity. Cotterill (1995), for example, considers that 'The preservation of specimens in natural history collections is the essential part of the process which builds and maintains biological knowledge'. Pressure on collections, however, has resulted

Box 8.3-1: Examples of specimens in natural science collections (Duckworth *et al.* 1993: 20).

baculi/phalli	plaster field jackets; complete dioramas with historical, artistic and scientific value)
blood components	
casts/molds/peels	
cell suspensions	
cleared and stained specimens	
cloned probes	
dissected organs and other dissected tissues	
DNA/RNA (including sequence gels)	
dried/tanned skins	
dry shells or echinoderms	
educational collections	
eggs and nests	
embryos/larvae	
endo- and ectoparasites	
exhibit collections	
exsiccata	
fossils	
freeze-dried specimens	
frozen tissues	
frozen tissue extracts	
frozen whole specimens	
genomes (plasmid, phage)	
herbarium sheets	
horns/antlers	
inherently toxic specimens	
isolated proteins	
karyotypes	
large specimens (e.g. blue whale skull; large fossils in	
	micromounts
	mummified specimens
	non-recent, sub-fossil material
	paraffin blocks
	pinned specimens
	polished sections
	powder diffraction mounts
	radioactive specimens
	reference sample collections (hair, feathers)
	scats
	sectioned teeth
	seeds
	shell structures
	single crystal mounts
	skulls and skeletons
	specimens in fluid (geological, biological)
	specimens in packets or boxes
	specimens or specimen parts on scanning electron microscope stubs
	specimens or specimen parts on microscope slides
	stomach contents
	stuffed specimens
	thin sections
	tree rings and wood samples
	type specimens
	zymograms

in a 'second biodiversity crisis' (McGinley 1993), namely the inundation of museums and other institutions by collections arising from field surveys in a period when their budgets are being reduced or pinned (Culotta 1992).

Biological reference collections constitute the material basis for biodiversity assessments. Such collections comprise permanently preserved specimens, and many other items such as slides made from specimens, recordings and photographs (see Box 8.3-1) maintained in museums, universities, botanic gardens and similar institutions, or by individual scientists. Such collections serve as proof or supporting evidence for the identity of a particular organism, and for the existence of that entity at a certain location at a particular point in time. The collections are 'anchors' for all future reference to that entity's occurrence, include the vouchers for the application of scientific names (i.e. name-bearing 'type' specimens), and provide the means for checking the identity of that entity in the future. Additionally, the advent of computerized information handling and manipulation, coupled with molecular technology, means that such reference collections will become strongly supplemented with extensive and permanent recorded observations, images and genetic data.

The value of biological reference collections is considered further in Section 2.1, while in this Section the focus is on the assessment of limitations in relation to their distribution, dimensions, preservation methods and cost-effectiveness.

8.3.2 Distribution and dimensions of biological reference collections

A consequence of the broad range of preserved non-living materials that comprise biological reference collections (Box 8.3-1; Duckworth *et al.* 1993: 20) is that a great deal of thought needs to go into policies for acquiring such material and for resourcing the long-term maintenance necessary.

Duckworth *et al.* (1993) estimate that there are some 2.5 billion specimens in preserved biological reference collections world-wide. The distribution of these is grossly skewed, the vast majority being located in developed countries in temperate regions. The distribution and dimensions of the plant and fungal collections are depicted in Table 8.3-1, and a parallel indication of zoological resources is presented as Table 8.3-2. However, it is

Table 8.3-1: Number of Plant and Fungal Biosystematic Reference Collections (PFBRC) and specimens world-wide (abridged from Holmgren *et al.* 1990).

Country	PFBRC	Number of specimens	Country	PFBRC	Number of specimens
Afghanistan	1	10 000	Kuwait	1	20 000
Bahrain	-	-	Lao, People's Democratic Republic	-	-
Bangladesh	1	80 000	Lebanon	1	68 000
Brunei Darussalam	1	7 000	Malaysia	7	419 960
Bhutan	1	5 000	Mongolia	2	100 000
Cambodia	-	-	Myanmar	5	39 000
China, People's Republic of	306	15 482 843	Nepal	1	170 000
China, Republic of	12	652 704	Oman	1	5 000
India	52	3 629 629	Qatar	-	-
Indonesia	6	1 663 500	Pakistan	9	495 500
Iran	5	438 000	Philippines	9	288 182
Iraq	9	155 630	Saudi Arabia	3	65 000
Israel	6	654 500	Singapore	2	614 000
Japan	47	7 315 894	Syria	-	-
Jordan	-	-	Sri Lanka	2	132 000
Kazakhstan	3	305 000	Tajikistan	1	145 000
Kyrgyzstan	1	250 000	Thailand	4	166 600
Korea, Democratic People's Republic	-	-	Turkey	22	525 553
Korea, Republic of	8	515 000	Turkmenistan	3	135 684
			United Arab Emirates	1	3 000

Table 8.3-1 – contd

Country	PFBR	Number of specimens	Country	PFBR	Number of specimens
Uzbekistan	4	1 045 000	Poland	28	3 630 721
Vietnam	3	221 000	Portugal	20	1 638 300
Subtotal	540	35 823 179	Romania	14	2 001 443
EUROPE			Russian Federation	40	10 188 103
Albania	—	—	San Marino	—	—
Andorra	—	—	Slovak Republic		
Armenia	10	398 131	(see Czechoslovakia)		
Austria	20	7 244 260	Slovenia		
Azerbaijan	1	600 000	(see Yugoslavia)		
Belarus	1	190 000	Spain	47	2 853 262
Belgium	12	3 204 518	Sweden	13	12 310 000
Bosnia-Herzegovina			Switzerland	15	10 631 500
(see Yugoslavia)			Ukraine	17	2 217 360
Bulgaria	3	394 727	United Kingdom	557	18 067 968
Croatia			Yugoslavia (former)	9	668 070
(see Yugoslavia)			Subtotal	1149	149 255 312
Cyprus	1	4 000	NORTH AND CENTRAL AMERICA		
Czech Republic			Antigua and Barbuda	—	—
(see Czechoslovakia)			Bahamas	—	—
Czechoslovakia	63	7 716 252	Barbados	1	4 000
Denmark	4	2 753 812	Belize	1	4 220
Estonia	5	556 900	Canada	110	6 806 570
Finland	20	4 476 935	Costa Rica	4	215 200
France	59	20 261 100	Cuba	15	299 210
Georgia	6	1 297 000	Dominica	—	—
Germany	60	15 465 800	Dominican Republic	3	100 000
Greece	5	422 000	El Salvador	3	27 635
Hungary	8	1 825 424	Grenada	—	—
Iceland	2	229 000	Guatemala	4	44 623
Ireland	18	821 000	Haiti	1	7 216
Italy	56	9 109 057	Honduras	2	170 000
Latvia	6	337 000	Jamaica	2	459 000
Liechtenstein	—	—	Mexico	52	2 191 211
Lithuania	3	204 000	Nicaragua	3	175 000
Luxembourg	1	35 000	Panama	3	58 200
Macedonia, The former			Saint Kitts and Nevis	—	—
Yugoslav Republic of			Saint Lucia	—	—
(see Yugoslavia)			Saint Vincent	—	—
Malta	1	10 000	and the Grenadines		
Moldova, Republic of	2	220 000	Suriname	1	21 000
Monaco	—	—	Trinidad and Tobago	1	45 000
Netherlands	15	4 674 669	United States	645	60 647 714
Norway	7	2 598 000	Subtotal	851	71 275 799

Country	PFBR	Number of specimens	Country	PFBR	Number of specimens
SOUTH AMERICA			Egypt	7	532 000
Argentina	43	3 876 554	Equatorial Guinea	—	—
Bolivia	4	56 000	Eritrea	—	—
Brazil	88	3 200 433	Ethiopia	3	69 500
Chile	10	319 168	Gabon	1	15 000
Colombia	23	658 165	Gambia	—	—
Ecuador	10	258 000	Ghana	5	92 052
Guyana	2	47 800	Guinea	—	—
Paraguay	3	42 500	Guinea-Bissau	—	—
Peru	11	439 982	Kenya	2	550 000
Uruguay	6	173 000	Lesotho	2	16 000
Venezuela	15	626 700	Liberia	1	7 000
Subtotal	215	9 698 302	Libya	2	47 000
AUSTRALASIA AND PACIFIC			Madagascar	2	80 000
Australia	38	5 312 600	Malawi	3	70 000
Fiji	1	25 000	Mali	—	—
France (New Caledonia)	1	60 000	Mauritania	—	—
Marshall Islands	—	—	Mauritius	1	21 000
Micronesia, Federa States of	—	—	Morocco	2	120 000
New Zealand	16	1 269 487	Mozambique	5	86 132
Papua New Guinea	4	314 093	Namibia	1	55 000
Solomon Islands	1	29 000	Niger	1	—
Vanuatu	1	6 000	Nigeria	7	174 225
Samoa	—	—	Rwanda	—	—
Subtotal	62	7 016 180	Sao Tome and Principe	—	—
AFRICA			Senegal	2	118 000
Algeria	1	350 000	Seychelles	1	500
Angola	3	70 000	Sierra Leone	4	64 857
Benin	1	1 500	Somalia	1	10 000
Botswana	3	12 500	South Africa	34	2 477 148
Burkina Faso	—	—	Sudan	3	30 500
Burundi	1	16 000	Swaziland	—	—
Cameroon	4	62 000	Tanzania, United Republic of	4	111 750
Cape Verde	—	—	Togo	1	16 000
Central African Republic	1	—	Tunisia	1	5 000
Comoros	—	—	Uganda	4	70 967
Chad	—	—	Zaire	3	175 000
Côte d'Ivoire	2	40 000	Zambia	4	86 500
Congo	2	40 300	Zimbabwe	4	374 200
Djibouti	—	—	Subtotal	129	6 067 631
			WORLD TOTAL	2946	279 136 403

Table 8.3-2: Museums and their zoological reference collections world-wide (Source: Bartz, B., Opitz, H and Richter, E. 1992. *Museums of the World, 4th revised and enlarged edition. K.G. Saur, München*).

Country	Natural History (in general)	Zoology (includes Zoos and Aquaria)	Biology	Birds	Insects	Mammals	Molluscs	Shells
ASIA								
Afghanistan	1	-	-	-	-	-	-	-
Bahrain	-	-	-	-	-	-	-	-
Bangladesh	-	-	-	-	-	-	-	-
Brunei Darussalam	-	-	-	-	-	-	-	-
Bhutan	-	-	-	-	-	-	-	-
Cambodia	-	-	-	-	-	-	-	-
China, People's Republic of	6	-	1	-	-	-	-	-
China, Republic of	1	-	-	-	-	-	-	-
India	9	15	2	-	-	1	-	-
Indonesia	-	1	1	-	-	-	-	-
Iran	1	1	-	-	-	-	-	-
Iraq	1	-	-	-	-	-	-	-
Israel	2	3	2	-	1	1	-	-
Japan	23	3	-	-	5	-	-	1
Jordan	-	-	-	-	-	-	-	-
Kazakhstan	-	-	-	-	-	-	-	-
Kyrgyzstan	-	-	-	-	-	-	-	-
Korea, Democratic People's Republic	-	-	-	-	-	-	-	-
Korea, Republic of	1	1	-	-	-	-	-	-
Kuwait	1	-	-	-	-	-	-	-
Lao, People's Democratic Republic	-	-	-	-	-	-	-	-
Lebanon	1	-	-	-	-	-	-	-
Malaysia	-	1	-	-	-	-	-	-
Mongolia	1	-	-	-	-	-	-	-
Myanmar	1	-	-	-	-	-	-	-
Nepal	-	-	-	-	-	-	-	-
Oman	-	-	-	-	-	-	-	1
Qatar	-	-	-	-	-	-	-	-
Pakistan	5	2	-	-	-	-	-	-
Philippines	3	1	-	-	1	-	-	1
Saudi Arabia	-	-	-	-	-	-	-	-
Singapore	-	-	-	-	-	-	-	-
Syria	-	-	-	-	-	-	-	-
Sri Lanka	1	-	-	-	-	-	-	-
Tajikistan	-	-	-	-	-	-	-	-
Thailand	2	-	-	-	1	-	-	-
Turkey	2	-	1	-	-	-	-	-

Country	Natural History (in general)	Zoology (includes Zoos and Aquaria)	Biology	Birds	Insects	Mammals	Molluscs	Shells
Turkmenistan	—	—	—	—	—	—	—	—
United Arab Emirates	—	—	—	—	—	—	—	—
Uzbekistan	1	—	—	—	—	—	—	—
Vietnam	—	—	—	—	—	—	—	—
Subtotal	63	28	7	0	8	2	0	3
EUROPE								
Albania	1	—	—	—	—	—	—	—
Andorra	—	—	—	—	—	—	—	—
Armenia	—	—	—	—	—	—	—	—
Austria	6	4	2	3	—	—	—	—
Azerbaijan	—	—	—	—	—	—	—	—
Belarus	1	—	—	—	—	—	—	—
Belgium	1	4	1	5	—	—	—	1
Bosnia–Herzegovina (see Yugoslavia)	—	—	—	—	—	—	—	—
Bulgaria	5	—	—	—	—	—	—	—
Croatia	4	2	—	1	—	—	—	1
Cyprus	—	—	—	—	—	—	—	—
Czech Republic (see Czechoslovakia)	—	—	—	—	—	—	—	—
Czechoslovakia	30	3	2	1	1	1	—	—
Denmark	—	1	1	2	—	—	—	—
Estonia	—	—	—	—	—	—	—	—
Finland	5	5	—	1	—	—	—	—
France	44	6	—	4	1	—	1	—
Georgia	2	—	—	—	—	—	—	—
Germany	51	12	2	10	2	—	—	—
Greece	2	1	—	—	—	—	—	—
Hungary	5	—	—	—	—	—	—	—
Iceland	2	1	—	—	—	—	—	—
Ireland	—	3	—	—	—	—	—	—
Italy	44	18	—	8	3	1	1	—
Latvia	—	—	—	—	—	—	—	—
Liechtenstein	—	—	—	—	—	—	—	—
Lithuania	—	—	—	—	—	—	—	—
Luxembourg	1	—	—	—	—	—	—	—
Macedonia, The former Yugoslav Republic of (see Yugoslavia)	—	—	—	—	—	—	—	—
Malta	1	—	—	—	—	—	—	—

Country	Natural History (in general)	Zoology (includes Zoos and Aquaria)	Biology	Birds	Insects	Mammals	Molluscs	Shells
Panama	2	—	—	1	—	—	—	—
Saint Kitts and Nevis	—	—	—	—	—	—	—	—
Saint Lucia	—	—	—	—	—	—	—	—
Saint Vincent and the Grenadines	—	—	—	—	—	—	—	—
Suriname	1	—	—	—	—	—	—	—
Trinidad and Tobago	—	—	—	—	—	—	—	—
United States	156	12	3	8	3	—	1	—
Subtotal	187	19	7	11	4	2	2	0
SOUTH AMERICA								
Argentina	30	5	2	—	—	—	—	—
Bolivia	—	—	—	—	—	—	—	—
Brazil	9	4	—	4	—	—	—	1
Chile	6	—	2	—	1	—	—	—
Colombia	4	4	—	—	—	—	—	—
Ecuador	2	1	—	—	—	—	—	—
Guyana	—	—	—	—	—	—	—	—
Paraguay	2	1	—	—	—	—	—	—
Peru	1	—	—	—	—	—	—	—
Uruguay	2	1	—	—	—	—	—	—
Venezuela	2	—	—	3	—	—	—	—
Subtotal	58	16	4	7	1	0	0	1
AUSTRALASIA AND PACIFIC								
Australia	1	1	—	—	1	—	—	1
Fiji	—	—	—	—	—	—	—	—
France (New Caledonia)	—	—	—	—	—	—	—	—
Marshall Islands	—	—	—	—	—	—	—	—
Micronesia, Federal States of	—	—	—	—	—	—	—	—
New Zealand	2	2	—	—	1	—	—	—
Papua New Guinea	1	4	—	—	—	—	—	—
Solomon Islands	—	—	—	—	—	—	—	—
Vanuatu	—	—	—	—	—	—	—	—
Samoa	—	—	—	—	—	—	—	—
Subtotal	4	7	0	0	2	0	0	1
AFRICA								
Algeria	1	—	—	—	—	—	—	—

Table 8.3-2 – contd

Country	Natural History (in general)	Zoology (includes Zoos and Aquaria)	Biology	Birds	Insects	Mammals	Molluscs	Shells
Angola	2	–	–	–	–	–	–	–
Benin	1	–	–	–	–	–	–	–
Botswana	–	–	–	–	–	–	–	–
Burkina Faso	–	–	–	–	–	–	–	–
Burundi	1	–	–	–	–	–	–	–
Cameroon	–	–	–	–	–	–	–	–
Cape Verde	–	–	–	–	–	–	–	–
Central African Republic	1	–	–	–	–	–	–	–
Comoros	–	–	–	–	–	–	–	–
Chad	1	–	–	–	–	–	–	–
Côte d'Ivoire	–	–	–	–	–	–	–	–
Congo	1	–	–	–	–	–	–	–
Djibouti	–	–	–	–	–	–	–	–
Egypt	–	3	–	2	6	2	1	1
Equatorial Guinea	–	–	–	–	–	–	–	–
Eritrea	–	–	–	–	–	–	–	–
Ethiopia	–	1	–	–	–	–	–	–
Gabon	–	–	–	–	–	–	–	–
Gambia	–	–	–	–	–	–	–	–
Ghana	–	–	–	–	–	–	–	–
Guinea	–	–	–	–	–	–	–	–
Guinea-Bissau	–	–	–	–	–	–	–	–
Kenya	1	–	–	–	–	–	–	–
Lesotho	–	–	–	–	–	–	–	–
Liberia	–	–	1	–	–	–	–	–
Libya	1	–	–	–	–	–	–	–
Madagascar	–	1	–	–	1	–	–	–
Malawi	–	–	–	–	–	–	–	–
Mali	–	–	–	–	–	–	–	–
Mauritania	–	–	–	–	–	–	–	–
Mauritius	1	–	–	–	–	–	–	–
Morocco	1	1	–	1	–	1	–	–
Mozambique	1	–	–	–	–	–	–	1
Namibia	3	–	–	–	–	–	–	–
Niger	–	–	–	–	–	–	–	–
Nigeria	–	1	–	–	–	–	–	–
Rwanda	–	–	–	–	–	–	–	–
São Tome and Principe	–	–	–	–	–	–	–	–
Senegal	1	–	–	–	–	–	–	–
Seychelles	1	–	–	–	–	–	–	–

Country	Natural History (in general)	Zoology (includes Zoos and Aquaria)	Biology	Birds	Insects	Mammals	Molluscs	Shells
Sierra Leone	-	-	-	-	-	-	-	-
Somalia	-	-	-	-	-	-	-	-
South Africa	2	3	-	1	1	1	-	-
Sudan	2	-	-	1	-	-	-	-
Swaziland	-	-	-	-	-	-	-	-
Tanzania, United Republic of	5	-	-	-	-	-	-	-
Togo	-	-	-	-	-	-	-	-
Tunisia	-	-	-	-	-	-	-	-
Uganda	2	3	-	-	-	-	-	-
Zaire	-	-	-	-	-	-	-	-
Zambia	-	-	-	-	-	-	-	-
Zimbabwe	1	1	1	-	-	-	-	-
Subtotal	30	14	2	5	8	4	1	2
TOTAL	688	179	37	77	33	11	8	15
WORLD TOTAL 1048								

difficult to assess the value of these collections on a regional or global basis without a database of their actual holdings.

The efficient description of global biodiversity, and the ability to compare material from many regions when assessing whether or not a species has previously been described, requires major concentrations of material which are only likely ever to be maintainable in a few places in the world. All the world's major collections comprise material accrued over extended periods of time, commonly 100 years or more. Such collections cannot be built up rapidly, and presuppose commitments to long-term financing, appropriately trained personnel, and a high degree of communication with the major collections in other countries (Holloway 1983). Nevertheless, significant holdings are being built up in less developed regions; for example, the Natural History Museum of Zimbabwe now holds 5.3 million specimens representing at least 58 200 different species (Cotterill *et al.* 1993).

The value, size and cost of maintenance of biological reference collections has been questioned by some workers in relation to the data that can be obtained from them (Clifford *et al.* 1990), and substantive counter-arguments have been published (Chalmers *et al.* 1990). However, the collections are widely dispersed through numerous institutions and countries, and their value as an overall resource for biodiversity assessments is less than optimal, for the following reasons.

- Collections are rarely located close to the most biodiversity-rich areas where the need for them is greatest in order to support inventorying and monitoring programmes.
- Most collections comprise only certain groups of organisms, those of particular applied or research interests, or material from one country or region.
- Major cities often have several different institutions with collections, each separately financed, controlled by different authorities, and with independent policies.
- The label data they contain are in most cases difficult to access except on a systematic basis as they are rarely computerized and stored in a database and are therefore not readily retrievable by country, locality or ecology.
- Acquisitions policies tend to be inclusive rather than selective which, while appropriate for some collections, can lead to an exponential growth in material, especially of commoner species, which may be too costly to maintain satisfactorily in the longer term.
- Curatorial resources are generally inadequate for the task so that the quality of the collections is

deteriorating through time, and locating specimens and making them available for examination on or off site may be impractical.

- Identifications have not always been revised in line with current research.
- Collections do not always have links with local universities to enable them to optimize their use for education and research.

The methods of preservation (8.3.3), accessibility (8.3.4), and curation standards (8.3.5) of collections are especially important issues, and are therefore highlighted below.

8.3.3 Preservation methods

The diversity of materials held in biological reference collections (Box 8.3-1) requires a range of specialized skills, knowledge and technology to ensure their preservation in a manner that does not reduce their scientific value. This extends to the nature of the materials on or in which specimens are contained or mounted, for example the quality of the paper, glue, slide-sealants and insect mounting pins. Particular care must be taken to ensure that the characters necessary for the confirmation of the identity of the material are adequately preserved. For example, specimens of larger fungi are of limited value if they are preserved in liquids that do not retain the original colour of the fruit-bodies. In the case of microscopic preparations, slide mountants must be stable and carefully prepared so as not to evaporate and render the material almost valueless after ten or more years.

In addition to the manner in which the individual specimens are prepared, the overall storage conditions of the collections must also be adequate. Ideally, this requires the maintenance of low relative humidity and a constant temperature to minimize the probability of the growth of spoilage moulds, and the maintenance of physical security against weather, insects and vertebrate pests (Fosberg and Sachet 1965). Preservation and storage methods have been thoroughly reviewed by Duckworth *et al.* (1993), who include an extensive bibliography. For botanical collections, the various practices are documented by Bridson and Forman (1992).

The methods of preservation also have implications for the usability of specimens for DNA extraction. Appropriately preserved collections are sources for DNA samples (Thomas 1994a) which can yield data relevant to conservation biology, evolution, and medicine as well as biological systematics (Thomas 1994b). For example, studies on DNA extracted from deer ticks in museum collections in the US showed that the Lyme disease bacterium was present in the country for several decades before it was officially recognized (Persing *et al.* 1990).

However, not all material preserved by traditional methods will be suitable for DNA extractions. Examinations of mushroom species of the genus *Agaricus* collected at intervals from 1902 revealed that long chains of DNA begin to deteriorate after between two and six years and that breakdown was almost complete after 33 years of museum storage, although sometimes specimens which had been stored for an equal length of time responded differently. These differences were attributed to temperature fluctuations and other aspects of treatment (Haines and Cooper 1993).

An alternative is to preserve tissue samples separately so that they can be used for DNA studies at a later date. The practice of taking tissue samples is now widely used for birds, and it is estimated that about one-third of the world's bird species have so far been sampled in this way (Arctander and Fjelds  1994; Fjelds  pers. comm.): maintenance at -70°C has been recommended (Thomas 1994b). The extension of this practice will facilitate the future development of DNA libraries (see 8.9). In addition, the DNA-Bank-Net international initiative has been set up recently to represent the interests of a range of institutions interested in collecting and storing plant material for subsequent DNA extraction and utilization, and recommends the maintenance of plant DNA extracts by cryopreservation at -196°C (Adams and Adams 1992).

8.3.4 Accessibility of biological reference collections

Despite improvements in travel and communications, a large proportion of the maintained and documented collections remains accessible only with difficulty to those who most need the information they contain, particularly scientists in the countries from which the specimens were obtained. The databasing of information associated with collections is accelerating, but for the largest collections significant progress is unlikely to occur without special funding for projects designed not only to improve access to the data but also to facilitate the repatriation of information to the countries of origin of the specimens.

As collections do become computerized, they are increasingly making information available world-wide through information servers on the Internet (e.g. Cornell University, gopher address muse.biol.cornell.edu.70; ERIN). Data on around 2 million museum specimen records are now available on the Internet (Miller 1993). The Association of Systematics Collections in the United States has developed a series of data-sharing and transfer guidelines for natural history institutions housing specimen-based databases. These guidelines (Association of Systematic Collections 1993) are flexible, and provide a framework for action within the context of the requirements of countries that have ratified the Convention on Biological Diversity. The number of application systems suitable for the manipulation of name-based data is

expanding, and these are listed on TAXACOM (e-mail address: taxacom@cmsa.berkeley.edu) from time to time.

8.3.5 Collection health

Various factors need to be taken into account in assessing the adequacy of the curation of biological reference collections. The Smithsonian Curation Standards and Profiling System (McGinley 1993), originally developed for entomological collections, has much to commend it as a means of assessing the state of curation of collections generally. This system recognizes ten levels of curation (Box 8.3-2) and, based on the numbers of storage units, a Collection Health Index can be calculated as the sum of units of levels 3 + 6–10 (inclusive) divided by the total number of units. Curation up to level 6, and ideally 7, is necessary for collections to contribute in a substantive way to biodiversity assessments. However, not even all the major world collections presently operate at level 7.

Box 8.3-2: Smithsonian Curation Standards and Profiling Systems (after McGinley 1993).

- LEVEL 1. Conservation problem.
- LEVEL 2. Specimens unidentified, inaccessible.
- LEVEL 3. Specimens unidentified, accessible.
- LEVEL 4. Specimens identified but not integrated into collections.
- LEVEL 5. Specimens identified but curation incomplete.
- LEVEL 6. Specimens identified and properly curated.
- LEVEL 7. Data capture: species level inventory.¹
- LEVEL 8. Data capture: specimen label data captured.
- LEVEL 9. Data capture: research data captured.
- LEVEL 10. Scientific voucher material (including name-bearing types).

1. A list of the scientific names of the species represented.

8.3.6 Costs of biological reference collections

Costs for the care of biological reference collections vary greatly from place to place and among different kinds of collections. There have been only a few attempts to quantify the costs, one of them being in a report published on the systematic botany resources in the United States (Payne *et al.* 1979). There, it was estimated that the cost of a well-prepared, identified, accessioned and inserted herbarium specimen was between US\$6.45 and US\$7.68. It should be borne in mind that these figures were valid about 15 years ago [c. 1980], and they do not include the often considerable costs of collecting the specimens in the first place. However, estimates vary greatly depending on the purpose of the collections and the type of specimens. For instance,

estimates of total collection costs vary from US\$18 per plant specimen in an ethnobotanical study (Halloy 1994b) to US\$26 per plant accession for a collecting trip in South America (Halloy 1990); A\$52.5 has been quoted as the mean cost for the collection and curation of a botanical specimen in Australia (Nielsen and West 1994); and £20 per museum specimen treated, conserved and stored, including staff and materials costs, has been quoted for the UK (Howie 1986). Fossils and large mammals may cost one or two orders of magnitude more than other types of material. However, when, spread over the useful 'life' of specimens, which extends forward indefinitely, this initial cost is not high compared with annual maintenance costs.

More generally, *Systematics Agenda 2000* (1994) estimated that the cost of the current annual global level of research and infrastructural support for systematic biology, including support for collections, is about US\$500 million.

The economic cost-benefits of investments in biological reference collections are difficult to quantify, but the ability of the world to reap the benefits of a greater understanding of biodiversity will be in some direct proportion to the investment in its documentation and study. The costs of establishing, maintaining and increasing accessibility to specimens and data held in reference collections will be an integral component of proposals to realize the full potential of Earth's biodiversity resource, although there is still debate as to whether support for the service roles of collections could be to the detriment of the vitality of systematics as a scientific discipline (Renner and Ricklefs 1994a, b; but see also Minelli 1994; Beattie 1994; Cotterill *et al.* 1994; Rejmánek *et al.* 1994; Pine 1994).

8.4 Information resources

8.4.1 Libraries

With few exceptions, the great library and document collections of the disciplines that contribute to biodiversity are in the developed world. They exist within the museums, learned societies, research institutions, and botanical and zoological gardens of Europe, North America and Asia. Historically, these collections owe their existence to the determination of the societies in which they are located to fund their continued existence. By their very nature, collections of paper-based information require large amounts of space, secure buildings, trained staff and controlled temperature/humidity conditions or controls that avoid extremes. The countries that have been able to provide these conditions have restricted their locations to the great cities of the developed world. For new information, electronic media mean that dependence on paper materials will become of decreasing importance.

The conditions that led to the world's major biological document collections being in the developed world are still pertinent, although in recent years, major libraries have

been started in the developing world. The institutes of the Consultative Group for International Agricultural Research (CGIAR) provide a good example: adequate funding has enabled a large library on livestock to be set up at the International Livestock Centre for Africa (ILCA) in Addis Ababa, and one on Insect Physiology and Ecology (ICIPE) has been established in Nairobi (Fisher *et al.* 1990). Advances in technology, for example the suites of abstracts and other data on CD-ROM (see below) and also on-line services, have meant that it is now less important for extensive library holdings to be duplicated in many centres, especially as this technology can be linked to rapid document-delivery services.

The critical importance of new technology delivery systems is apparent from the number of journal titles potentially containing information relating to biodiversity. A search of ULRICH'S International Periodical Directory on-line (DIALOG file 480, Bowker) gives 12 982 titles for the words 'biology', 'botany', 'agriculture' and 'zoology' and their variants. An extensive search of the same database to select titles that indicate that they would contain articles on 'biodiversity' retrieved over 2400 titles. Such numbers strain the budget of even well-funded libraries, and also occupy huge amounts of space. Libraries are finite in space, and the expansion of journal titles forces on them the labour-intensive business of near-constant stock disposal exercises. This policy is deleterious when applied to biosystematic literature, which has an extended shelf-life, original descriptions and inventory lists being of lasting significance. Indeed, it is the location of and access to literature from the nineteenth and early twentieth centuries, representing major periods of documentation of tropical biotas, that is especially difficult for researchers from developing countries.

8.4.2 Electronic media

The publishing of whole databases on CD-ROMs has enabled users of biological information around the globe to have access to large bibliographic files in a relatively inexpensive and user-friendly format (see Section 9). At the time of writing, a vast range of relevant titles is available in CD-ROM format, including the CAB ABSTRACTS database (and subsets thereof), *Biological Abstracts* (BIOSIS) and *Index Kewensis*. The discs themselves are small and light, apparently long-lasting and not palatable to insects, and while the costs are high for databases that need to recover the costs of data compilation, these can be funded by donor agencies. The equipment needed to use them is a PC equipped with a CD-ROM drive, and it is expected that most PCs will be fitted with the drive as standard within a few years.

In addition to bibliographic databases and indices, primary titles are now appearing in CD-ROM format. For example, the Compact International Agricultural Research

Library is a 17-disc CD-ROM set covering selected materials from 20 international agricultural research centres located in 16 countries. It covers documents published between 1962 and 1986. Some journal titles are now available in parallel formats with the printed copy, giving a more easily transported and durable copy of the information to the world, as in the case of the *Florida Entomologist* and the *International Journal of Systematic Bacteriology*.

Systematic databases for a range of different taxonomic groups are now also available on floppy discs, such as the *Bacterial Nomenclature Up-to-Date* issued once a year by the DSM-Deutsche Sammlung von Mikroorganismen und Zellkulturen GmbH, and many others available through the Internet. However, they vary enormously in the scope, quality and completeness of the information provided, and are not free from inconsistencies and disparities caused, for example, by the use of different systematic treatments of the same group. A co-ordinated effort is required to standardize the content of and access to this information, and this has led to the idea of the preparation of a world species checklist under the programme *Species 2000* (Bisby 1994; see also 8.4.4 and Section 2.1).

The phenomenal growth of the Internet, the world-wide link-up of computer networks and users, continues the trend set by CD-ROM in making possible the bringing of information to the user rather than the other way round. E-mail users across the world can send messages to each other at very low cost, and can also attach text files. Technically, the results of a CD-ROM or on-line search can be transferred between e-mail addresses, although this may contravene intellectual property (copyright) legislation (see Section 9). The number of users with access to the Internet expanded at the rate of 10% per month during 1993, and currently stands at around 29 million. The Biodiversity Information Network (BIN) on Internet, operated from Brazil (Canhos *et al.* 1992), has been developed to end the isolation of many workers in the field. The possibilities of new forms of accessibility, and also their cost-effectiveness, mean that it will increasingly be a question not of the technology limiting the delivery of information into developing countries that will be the bottleneck (Miller 1994), but rather the costs of putting the required material into machine-readable formats. Some of the problems and misconceptions relating to biodiversity information are analysed by Allkin and Winfield (1993), Fortuner (1993), and Shetler (1973). Careful planning, quality control and sustained management are prerequisites for effective computer-based information systems.

8.4.3 Directories of biodiversity information

For assistance in locating sources of information on species, their habitats and genetic resources, as well as international catalogues and indexing services (see also 8.4.4), various annotated directories are available. The

directories of plant germplasm collections list the germplasm holdings of specific crops and food plants in institutes around the world including root and tuber crops, cereals, vegetables, industrial crops, tropical and subtropical fruits and tree nuts, temperate fruits and tree nuts and forages. The information in many of the directories serves to aid scientists and policy-makers in steering them to more detailed sources of information, and helps them to make contact with other individuals working in the area of interest (see Box 8.4-1).

8.4.4 Catalogues, indexes and registers for described species

The fundamental element in communicating about organismal biodiversity is the names of the organisms themselves. Therefore catalogues must be produced not only of all the described species names, but also of their correct names according to the appropriate nomenclatural Code (8.10.3) and according to the latest research into their relationships and position in the taxonomic phylogenetic system. The lack of a comprehensive synthesis means that it is impossible to provide an answer, with any degree of certainty, to the question 'How many species are known on Earth?' The difficulties encountered in arriving at the working figure for known species of 1.75 million are discussed in Section 3.1.2.2.

The main compilations of names (Box 8.1-1) comprise a mixture of catalogues (mostly from the last century) and on-going indices, but these do not exist for all groups of organisms. In addition, detailed catalogues for particular groups are published occasionally. At present, with the exception of bacteria published since 1980, a person describing a new species is under no obligation to register that name with any authority. The International Registration Authorities for the 'cultivar' names of cultivated plants operate only as a voluntary system, and no Authorities exist for many genera. However, registration has been approved for names in all 'botanical' groups from the year 2000, subject to details of the mechanisms to be drawn up by the International Association for Plant Taxonomy (Greuter *et al.* 1994), and the concept is also under discussion for the next edition of the Code concerning names in zoology (Hawksworth *et al.* 1994). The establishment of funding mechanisms will be crucial to the realization of comprehensive registration systems.

The current compilations of names, and also registers of names, are nomenclatural devices rather than a continuously updated list of scientifically accepted species with the 'correct' name. It is such global master species databases that are the real need of those involved in the inventorying, description, communication and regulation of biodiversity and its uses. This type of information does exist for many (but not all) groups, but it is uncoordinated and scattered though a variety of databases located in

Box 8.4-1: Selected directories useful for biodiversity information.

1. Guarino, L., Rao, V.R. and Reid, R. (eds) 1995. *Collecting plant genetic diversity: Technical Guidelines*. CAB International, Wallingford
2. International Plant Genetic Resources Institute (IPGRI), *Directories of Germplasm Collections Series*. IPGRI, Rome
3. IUCN-The World Conservation Union, 1988. *A Directory of Neotropical Wetlands*. IUCN, Cambridge
4. IUCN-The World Conservation Union, 1989. *Directory of Asian Wetlands*. IUCN, Gland, Switzerland
5. IUCN-The World Conservation Union, 1990. *IUCN Red List of Threatened Animals*. IUCN, Cambridge (additional red lists available)
6. IUCN-The World Conservation Union, 1991. *Directory of African Wetlands*. IUCN, Gland, Switzerland and WCMC, Cambridge
7. IUCN-The World Conservation Union, 1992. *Protected Areas of the World: A Review of Actual Systems*, vols 1-4. IUCN, Gland
8. Sugawara, H., Ma, J., Miyazaki, S., Shimura, J. and Takishima, Y. 1993. *World Directory of Collections of Cultures of Microorganisms*, edn 4. WFCM World Data Center on Microorganisms, Saitama, Japan
9. World Conservation Monitoring Centre, 1990. *Directory of Wetlands of International Importance*. IUCN, Cambridge
10. World Conservation Monitoring Centre, 1993. *Ecologically Important Areas of Africa*. World Bank, Washington, DC
11. World Conservation Monitoring Centre and Royal Botanic Gardens, Kew, UK, 1990. *World Plant Conservation Bibliography*. Royal Botanic Gardens, Kew and WCMC, Cambridge
12. World Resources Institute and International Institute for Environment and Development, 1993. *Directory of Country Environmental Studies*. WRI, Washington, DC

different countries (Bisby 1993). With advances in computing and communications technology, it is now technically feasible to consider putting the many existing data sets together so as to prepare a draft single master-species database covering all groups of organisms.

That such a major compilation could now be achievable is indicated by two recent events: first, the production of a list of 28 041 generic names for non-fossil botanical groups

prepared with the help of over 200 plant systematists (Greuter *et al.* 1993); and second, the establishment of a mechanism to produce a list of the accepted species of the world's vascular plants (Burnett 1994).

In recognition of the international need for a global synthesis of the organisms now known on Earth, in September 1994 the 25th General Assembly of IUBS unanimously agreed to include the production of a global master species database in its scientific programme. Preparation of a costed proposal for the project 'Species 2000: A world species index' is now under way with the support of CODATA and IUMS. This database would be one of the crucial tools needed by the Clearing House Mechanism to be established under the Convention on Biological Diversity (see Section 9). Once it was established, the database could be updated through links to the proposed on-going registration systems for newly proposed names (see above).

8.4.5 Identification aids

The range of available field guides, keys and other identification aids is a major constraint to the assessment of biodiversity. Further, these need to be in local languages and well illustrated to be of optimal value to reserve managers and other non-specialists charged with inventorying and monitoring activities. With the major exception of field guides to birds, and in some cases also other vertebrates and flowering plants,¹ even countries in Europe (Sims *et al.* 1988) and North America lack a comprehensive set of such works.

Several useful ideas for the preparation of user-friendly identification keys have resulted from the work of the 'Aids to Identification in Difficult Groups of Animals and Plants' (AIDGAP) project, an initiative of the Field Studies Council, Great Britain, the main objective of which is to 'promote alternative ways of presenting aids to identification'. The project highlighted the need for the extensive use of illustrations, which improve the accuracy of identifications, conspicuous characters, and the testing of identification keys before publication (Tilling 1987). However, this was attempted with only a limited number of groups, and these were chosen from well-studied and documented organisms. Further information on different presentation methods, e.g. single- and multi-access keys, were outlined by Tilling (1984), but both types have their advantages and disadvantages. New initiatives such as computer-based identification aids will play an increasing role, such as those prepared in CD-ROM format by the Expert-Center for Taxonomic Identification (ETI), Amsterdam (see also Section 2.1).

1. On-line information on these on subject and countries can be obtained from the Natural History Books Service Catalogue, available on <http://www.nhds.co.uk>

8.5 Living plant collections

8.5.1 Types of living plant collection

Living plant collections comprise those held in botanic gardens, national collection gardens, special plant collections, parks, special amenity collections, roadside plantings and arboreta. They are important in the assessment of biodiversity because the extent of morphological, genetic and chemical variation within plant species can often be adequately researched only by examination of living material from a range of locations. They also have a significant role in conservation biology and in practical conservation. In some cases they may also serve as genetic resource collections, as relatively secure *ex situ* locations for threatened or valuable species, and sometimes even species which are extinct in the wild. Unlike biological reference collections, living plant collections have a continuous turnover, as species are lost and newly collected ones are introduced (Buttel 1992; Halloy 1995). Two general concerns that apply to all living plant collections are: (1) that the genetic variation within the species is often grossly under-represented, and (2) that those genotypes best suited to the conditions of cultivation may be selected for (Hurka 1994; Given 1994).

8.5.2 Botanic garden and arboretum collections

8.5.2.1 What is a botanic garden?

Botanic gardens, in the sense of collections of living plants grown for some educational, economic, medicinal or scientific purpose, have played a significant role in many civilizations and cultures over the ages. However, there is no universally accepted or entirely satisfactory definition of a botanic garden (Heywood 1987; WWF and IUCN-BGCS 1989), and this complicates the making of assessments as to their overall adequacy or contributions. Most botanic gardens are broadly based botanical resource centres that undertake work in a variety of botanical disciplines of which conservation is an important part, and Heywood (1987) proposed a subdivision into categories related to their origins and functions: for example, European Medicinal, European Classical, Colonial Tropical, and Civic and Municipal. However, the following characteristics are shared by most gardens.

- They maintain documented living plant collections.
- They are open to the public and provide educational information on their collections for visitors.
- They undertake scientific or horticultural research.
- Their plant collections are labelled.
- Their collections are amassed for purposes other than decoration and amenity, and are often of documented wild origin, valuable for scientific and conservation purposes.

Table 8.5-1: Number of botanic gardens world-wide (Information compiled by Botanic Gardens Conservation International).

Country	Number of Botanic Gardens	Number of taxa ¹ reported in cultivation	Country	Number of Botanic Gardens	Number of taxa ¹ reported in cultivation
Afghanistan	—	—	Congo	—	—
Albania	1	2 000	Costa Rica	2	7 000
Algeria	3	—	Côte d'Ivoire	1	1 200
Andorra	—	—	Croatia	10 (2 planned)	11 667
Angola	2	—	Cuba	8	6 250
Antigua and Barbuda	—	—	Cyprus	—	—
Argentina	10	21 537	Czech Republic	26	47 977
Armenia	3	4 300	Denmark	8	49 250
Azerbaijan	2	2 910	Djibouti	—	—
Australia	63	101 752	Dominica	1	750
Austria	11	40 240	Dominican Republic	1	—
Bahamas	—	—	Ecuador	2	500
Bahrain	—	—	Egypt	6	7 550
Bangladesh	3	700	El Salvador	1	3 500
Barbados	2	—	Equatorial Guinea	—	—
Belarus	—	16 096	Eritrea	—	—
Belgium	16	19 803	Estonia	3	10 212
Belize	1	—	Ethiopia	1	—
Benin	1	—	Fiji	2	—
Bolivia	3	—	Finland	8	22 262
Bosnia–Herzegovina (see Yugoslavia)	—	—	France	66	173 050
Botswana	—	—	(Guadeloupe)	2	100
Brazil	23	16 820	(Martinique)	3	—
Brunei Darussalam	—	—	(Réunion)	4	—
Bulgaria	9	3 000	(French Guiana)	2	—
Burkina–Faso	—	—	Gabon	1	40
Burundi	1	—	Georgia	5	13 800
Buthan	—	—	Germany	74	398 970
Cambodia	—	—	Ghana	3	1 000
Cameroon	2	—	Greece	4	3 500
Canada	18	62 648	Grenada	1	—
Cape Verde	1	—	Guatemala	1	550
Central African Republic	—	—	Guinea–Bissau	—	—
Chad	—	—	Guyana	2	300
Chile	9	21 767	Haiti	1	—
China, People's Republic of	68	26 993	Honduras	2	—
China, Republic of	2	2 421	Hungary	17	28 850
Colombia	13	3 000	Iceland	2	6 500
Comoros	—	—	India	68	84 819
			Indonesia	5	69 840

Table 8.5-1 – contd

Country	Number of Botanic Gardens	Number of taxa ¹ reported in cultivation	Country	Number of Botanic Gardens	Number of taxa ¹ reported in cultivation
Iran	3	250	Mozambique	2	2 200
Iraq	1	230	Myanmar	2	–
Ireland	8	36 500	Namibia	1	–
Israel	7	8 000	Nepal	1	2 300
Italy	48	120 232	Netherlands	39	175 129
Jamaica	4	1 557	New Zealand	17	28 231
Japan	59	74 899	Nicaragua	1	–
Jordan	–	–	Niger	–	–
Kazakhstan	8	13 942	Nigeria	5	–
Kenya	5	710	Norway	6	14 900
Kuwait	–	–	Oman	–	–
Kyrgyzstan	3	10 160	Pakistan	5	430
Korea, Democratic People's Republic of	1	3 140	Panama	1	–
Korea, Republic of	5	9 300	Papua New Guinea	4	6 700
Latvia	2	17 150	Paraguay	1	–
Lebanon	–	–	Peru	6	–
Lesotho	–	–	Philippines	9	16 829
Liberia	–	–	Poland	25	55 691
Libya	1	400	Portugal	6	14 304
Liechtenstein	–	–	(Azores)	1	–
Lithuania	5	8 397	(Macau)	1	–
Luxembourg	–	–	(Madeira)	2	–
Macedonia, The former Yugoslav Republic of	7	2 341	Qatar	–	–
Madagascar	2	5 000	Romania	10	35 200
Malawi	4	130	Russian Federation	62	145 312
Malaysia	9	3 722	Rwanda	1	175
Maldives	–	–	Saint Kitts and Nevis	–	–
Mali	–	–	Saint Lucia	–	–
Malta	1	8 000	Saint Vincent and the Grenadines	1	–
Marshall Islands	–	–	Samoa	1	–
Mauritania	–	–	San Marino	–	–
Mauritius	2	880	São Tome and Principe	–	–
Mexico	35	7 050	Saudi Arabia	2	–
Micronesia, Federal States of	–	–	Senegal	3	1 300
Moldova, Republic of	2	11 500	Seychelles	1	–
Monaco	1	7 000	Sierra Leone	1	–
Mongolia	1	–	Singapore	1	3 000
Morocco	2	1 200	Slovak Republic	8	20 300
			Slovenia	3	9 000
			Solomon Islands	1	150

Country	Number of Botanic Gardens	Number of taxa ¹ reported in cultivation	Country	Number of Botanic Gardens	Number of taxa ¹ reported in cultivation
South Africa	17	27 203	(Bermuda)	1	–
Spain	8	25 900	(Cayman Islands)	1	–
(Balearic Is.)	1	–	(Gibraltar)	1	–
(Canary Is.)	3	–	(Hong Kong)	4	1 200
Sri Lanka	6	7 125	(St Helena)	1	5 000
Sudan	1	150	(British Virgin Is.)	1	–
Suriname	1	–	United States	250	443 856
Swaziland	–	–	(Hawaii)	19	–
Sweden	9	42 190	(Puerto Rico)	4	3 150
Switzerland	22	90 020	(US Virgin Is.)	1	6 500
Syria	–	–	Uruguay	1	500
Tajikistan	5	12 258	Uzbekistan	4	6 940
Tanzania, United			Vanuatu	–	–
Republic of	3	–	Venezuela	7	1 003
Thailand	5	–	Vietnam	3	–
Togo	1	–	Yugoslavia (former)		
Trinidad and Tobago	1	–	(Serbia & Bosnia–		
Tunisia	1	–	Herzegovina)	11	–
Turkey	6	8 815	(Montenegro)	2	–
Turkmenistan	1	5 000	Zaire	3	2 500
Uganda	2	3 320	Zambia	–	–
Ukraine	33	63 024	Zimbabwe	4	3 250
United Arab Emirates	–	–			
United Kingdom	61	218 627	TOTAL	1 573	

i.e. Number of taxa reported in cultivation in the Botanic Gardens.
1. Includes species, subspecies, varieties and cultivars.

Most botanic gardens do not have sufficient technical resources to be able to achieve much effective conservation and research into biodiversity. Nevertheless, their developing role in conservation and education has provided many with a new rationale for existence and the last decade has been a renaissance period for the international botanic garden community.

In 1989, *The Botanic Gardens Conservation Strategy* (WWF and IUCN-BGCS 1989) was published to outline the role of botanic gardens in living resource conservation and in the implementation of the World Conservation Strategy. This strategy is now used by many institutions to help guide their development. Complementary to the strategy, a series of technical publications is being produced by organizations such as Botanic Gardens Conservation International and the Center for Plant

Conservation, USA to guide specific aspects of botanic garden conservation programmes. Manuals for botanic gardens have been published or are in preparation on the subjects of *ex situ* conservation, seed banking, reintroductions and species recovery, the Convention on International Trade in Endangered Species of Wild Flora and Fauna (CITES), environmental education and plant data management.

8.5.2.2 The extent, distribution and resources of botanic gardens

There are almost 1600 botanic gardens and arboreta worldwide, although this number is dependent on how such gardens are defined (8.5.2.1). While the majority of these gardens are located in Europe and North America (see Table 8.5-1), there are relatively few countries in the world without any botanic gardens. The early European botanic gardens were centres for the study of properties of plants used in medicine and pharmacy (Heywood 1987, 1990). In

the last twenty years, many new botanic gardens and arboreta have been created, primarily for the conservation, management and utilization of plant diversity and for environmental education. Many older botanic gardens established before this century, especially those created by the major European colonial powers in many tropical countries and regions, were founded to introduce and grow plants of economic importance. Some of these gardens, for example those in Brazil, the Caribbean, India, Indonesia, Singapore and Sri Lanka, are now being redeveloped or reorganized to undertake new roles in the conservation of plant genetic resources as part of their mission. Other well-established botanic gardens in many countries are reviewing their purposes and facilities through the preparation of new strategic and corporate plans, mission statements and collections policies, and in general, most botanic gardens have now put more emphasis on the conservation of native plants than on introduced plants.

There is a serious geographical imbalance of botanic gardens in the world. In Europe and North America there are many more botanic gardens than in developing regions of the world: 431 were listed for North America alone by Watson *et al.* (1993). Furthermore, most botanic gardens in developing countries are amongst the most poorly resourced and many lack sufficient trained or experienced staff. Nevertheless, BGCI currently estimates that there are in the region of 800 botanic gardens active in some significant form in biodiversity conservation, although the extent and effectiveness of each varies enormously, from those involved in small-scale local actions to those undertaking major international programmes.

8.5.2.3 Botanic garden networks and linkages

An important feature of the botanic garden scene between 1985 and 1995 has been the extent to which networks of closely co-operating botanic gardens have been developed. In 1987, IUCN established the Botanic Gardens Conservation Secretariat (BGCS) to unite and promote the role of botanic gardens in plant conservation. In 1990, BGCS became independent (as Botanic Gardens Conservation International (BGCI)) and has grown to include over 400 member institutions in more than 80 countries.

During the same period several important national and regional botanic garden networks have been established or developed. Botanic gardens are further linked through the International Association of Botanical Gardens (IABG), founded in 1956 and a commission of IUBS. IABG has active regional divisions in Latin America, East Asia and Europe. National botanic garden organizations exist in many countries such as Australia, Brazil, China, Colombia, Cuba, France, Indonesia, Japan, Republic of Korea, Mexico, Netherlands, the Russian Federation, South Africa, Spain and Portugal. Although these networks have arisen

from a great diversity of origins there is now close co-operation between them.

The American Association of Botanical Gardens and Arboreta (AABGA) acts as an umbrella organization for North American public gardens and is increasingly considering biodiversity conservation as part of its mission. In addition, in the USA a national network of botanic gardens active in plant conservation operates through the Center for Plant Conservation (CPC), based at the Missouri Botanical Garden, St Louis. CPC includes over 20 leading gardens and manages a national collection of rare and endangered native plants conserved *ex situ*. In 1993 and 1994, BGCI signed co-operative agreements with other major organizations such as IABG and AABGA to help draw together the leading botanic garden networks.

8.5.2.4 What plants are in botanic garden collections?

The total number of accessions of taxa held in botanic gardens is not less than 3.2 million (cf. Table 8.5-1). Allowing for unregistered collections, BGCI estimates that there are currently more than 4 million living plant accessions maintained in botanic gardens, representing in the region of 80 000 species. This represents about 30% of the known species of flowering plants and ferns and 25% of those estimated for the world (Table 3.1-2). Many species are not represented by a sufficient range of accessions to reflect adequately the genetic variation within the species in their normal ecological context (see 8.5.1). The limited genetic diversity held of native species and uncertainty over optimal horticultural practices can contribute to failures to maintain them (Hall and Rycroft 1979).

The international database maintained by BGCI has already documented holdings of 250 000 accessions and includes records from over 350 institutions, representing about 30 000 species (Leadley *et al.* 1993).

Documentation of garden collections is, however, still inadequate in many institutions. A BGCI survey carried out in 1993 on plant recording methods in botanic gardens revealed that only 76 (7.3%) definitely had computerized systems in operation, although that could be an underestimate as only 117 responded to the survey. However, many others intimated that they planned to computerize their recording systems within the next few years. Most botanic gardens also have poor knowledge of and access to technical assistance in computerization although a number of standard plant recording software systems are now available to them, as well as an agreed international standard for data exchange, the International Transfer Format for Botanic Garden Plant Records (BGCI 1993).

The plant groups best represented in botanic garden collections are those of horticultural or other economic interest such as carnivorous plants, orchids, palms, cacti

and other succulents, woody legumes, ferns, cycads, bulbous plants, bromeliads and conifers. Many botanic gardens place particular emphasis on growing and maintaining, thematic collections of such groups as medicinal and aromatic plants, economic plants, particularly fruit trees and their wild relatives, ornamentals, plants of ethnobotanical or historical interest, alpinists and temperate or tropical trees. A list of botanic gardens specializing in medicinal plants or with special collections of them is given by Heywood (1991a).

Data held by BGCI indicate that the floras of many major tropical and sub-tropical continental countries, such as Brazil, Colombia, Indonesia and Zaire, as well as others, especially in Africa and South America, are poorly represented in botanic garden collections. Better represented are the floras of Europe, North America, temperate South America and Asia, Australia and New Zealand and South Africa. In most of these regions as much as 30% of their rare and endangered flora is known to be represented in cultivation by at least a few individuals per species. Also well represented are the endemic floras of many oceanic island groups, especially Macronesia, the Mascarene Islands and Hawaii.

A recent trend is for botanic gardens to focus on and give priority to the cultivation of the native flora of their own region, particularly those that are threatened, which will add significantly to the scientific value as well as the conservation value of the resource. However, the long-term future of threatened cultivated species may be less secure due to lack of genetic diversity in the small samples of natural populations, as well as problems of cultivation (Hall and Ryofft 1979).

8.5.2.5 Conservation programmes

The diverse range of botanic gardens world-wide has allowed the emergence and development of a wide range of conservation programmes, resources, skills and experience, although many of these are still in very early stages of development (He Shan-an *et al.* 1990; Heywood 1992, 1993a). Their *ex situ* conservation activities include:

- Maintenance of living collections which include representatives of many rare and endangered species.
- Gene banks, especially seed storage facilities.
- Specialized nurseries and horticultural centres.
- Propagation and bulking up of material for re-introduction programmes.
- Micropropagation and tissue culture.

In addition, some botanic gardens have important non-living reference collections associated with them and a

considerable number are focal points for systematic research, contributing to the understanding of biodiversity through floristic and biosystematic study. The BGCI database lists 721 botanic gardens with associated herbaria containing, between them, over 80 million specimens. Botanical research in many other pertinent fields can be undertaken, including ethnobiology, horticulture, conservation biology, population biology, ecology, molecular botany and genetics.

Botanic gardens also have a role in protecting ecosystems. Over 500 botanic gardens either contain areas of natural vegetation or have such areas directly under their control. This provides opportunities to undertake extensive *in situ* conservation action. Many of these gardens, and other institutions, work with protected area managers or agencies to contribute to the management of *in situ* plant resources.

8.5.2.6 Further sources of information

Further information on botanic gardens and their role as a resource for the assessment of biodiversity and its conservation is provided in the following publications: Akeroyd *et al.* (1994), Akeroyd and Wyse Jackson (1995), WWF and IUCN-BGCS (1989), Bramwell *et al.* (1987), Bramwell and Heywood (in press), Butler *et al.* (1992), Chauvet and Delmas (1991), Falk (1990), Falk and Holsinger (1991), Froggatt and Oates (1993), Given (1994), Hamann (1992), He *et al.* (1990), Hernandez-Bermejo *et al.* (1990), Heywood (1991b), Heywood *et al.* (1990), Heywood and Wyse Jackson (1991), Larsen *et al.* (1989), Richardson *et al.* (1991), Suhirman *et al.* (1994), WCMC (1992), Willison and Greene (1994), Willison and Wyse Jackson (1992).

8.5.3 National plant collections

National plant collections are samples of plants of particular genera, or other groups of species, grown in a particular country which are brought together in private or public gardens. They constitute a data gathering, cataloguing and exchange facility network of small plant collections acting as a support web. They are very diverse in composition and location, and can be an additional research resource. Although large numbers of collections remain in private hands, others are held by botanic gardens, nurseries, corporations, colleges and universities. In addition to the intrinsic and historic value of such collections, they often contain plants that are endangered in their natural habitat, and therefore it is important that these plants are conserved. National collections may, in conjunction with other bodies, assist with re-introductions to the wild.

Well established nationally and internationally is the UK National Council for the Conservation of Plants and Gardens (NCCPG), with over 600 collections, covering 13 000 species and 39 000 cultivars (Greenoak 1994). Similar initiatives have been established in Australia

Table 8.6-1: Number of zoological institutions world-wide (Data from Global Zoo Directory, ISIS and Andrzejewski & Weigle, 1993).

Country	Number of Zoos and Aquaria	Number of species registered (ISIS)	Country	Number of Zoos and Aquaria	Number of species registered (ISIS)
Afghanistan	1	–	Côte d'Ivoire	1	–
Albania	–	–	Croatia	–	–
Algeria	2	–	Cuba	5	–
Andorra	–	–	Cyprus	1	–
Angola	–	–	Czech Republic	15	114
Antigua	–	–	Denmark	13	532
Argentina	10	–	Djibouti	–	–
Australia	68	1 207	Dominica	–	–
Austria	17	291	Dominican Republic	1	–
Azerbaijan	1	–	Ecuador	3	–
Bahamas	4	–	Egypt	2	–
Bangladesh	1	–	El Salvador	1	–
Barbados	2	–	Equatorial Guinea	–	–
Belarus	–	–	Eritrea	–	–
Belgium	11	732	Estonia	1	277
Belize	1	–	Ethiopia	3	–
Benin	–	–	Fiji	–	–
Bolivia	4	–	Finland	1	149
Bosnia–Herzegovina	–	–	France	63	663
Botswana	–	–	Gabon	–	–
Brazil	57	–	Gambia	–	–
Brunei	2	–	Georgia	3	–
Bulgaria	4	–	Germany	115	2 116
Burkina Faso	–	–	Ghana	2	–
Burundi	–	–	Greece	2	–
Bhutan	–	–	Grenada	1	–
Cambodia	–	–	Guatemala	3	–
Cameroon	1	–	Guinea	–	–
Canada	102	1 710	Guinea–Bissau	–	–
Cape Verde	–	–	Guyana	1	–
Central African Republic	–	–	Haiti	–	–
Chad	–	–	Honduras	2	–
Chile	7	–	Hungary	7	175
China, People's Republic of	137	–	Iceland	–	–
China, Republic of	3	199	India	69	–
Colombia	7	246	Indonesia	17	–
Comoros	–	–	Iran	1	–
Congo	2	–	Iraq	1	–
Costa Rica	1	–	Ireland	2	338

Country	Number of Zoos and Aquaria	Number of species registered (ISIS)	Country	Number of Zoos and Aquaria	Number of species registered (ISIS)
Israel	7	203	Nepal	1	—
Italy	32	68	Netherlands	18	1 381
Jamaica	1	—	New Zealand	24	304
Japan	176	383 (from 5 collections)	Nicaragua	2	—
Jordan	—	—	Niger	—	—
Kazakhstan	3	—	Nigeria	7	—
Kenya	4	—	Norway	3	—
Korea, Democratic Republic of	2	—	Oman	1	—
Korea, Republic of	4	—	Pakistan	5	—
Kuwait	1	—	Panama	1	—
Kyrgyzstan	—	—	Papua New Guinea	0	—
Lao, People's Democratic Republic of	—	—	Paraguay	3	—
Latvia	1	305	Peru	3	—
Lebanon	1	—	Philippines	1	—
Lesotho	—	—	Poland	12	385
Liberia	2	—	Portugal	4	417
Lybia	2	—	Qatar	1	—
Liechtenstein	—	—	Romania	6	—
Lithuania	2	—	Russian Federation	21	499
Luxembourg	0	—	Rwanda	—	—
Macedonia, The former Yugoslav Republic of	—	—	Saint Vincent and the Grenadines	—	—
Madagascar	3	—	Saint Lucia	1	—
Malawi	1	—	Saint Kitts and Nevis	—	—
Malaysia	5	—	Samoa	—	—
Maldives	—	—	San Marino	—	—
Mali	1	—	São Tome and Principe	—	—
Malta	1	—	Saudi Arabia	2	266
Marshall Islands	—	—	Senegal	1	—
Mauritania	—	—	Seychelles	—	—
Mauritius	2	—	Sierra Leone	—	—
Mexico	20	223	Singapore	3	217
Micronesia, Federal States of	—	—	Slovak Republic	2	—
Moldova, Republic of	1	—	Solomon Islands	—	—
Monaco	2	—	Somalia	—	—
Mongolia	—	—	South Africa	26	526
Morocco	3	—	Spain	18	636
Mozambique	3	—	Sri Lanka	1	—
Myanmar	1	—	Sudan	1	—
Namibia	1	—	Suriname	1	—
			Swaziland	—	—
			Sweden	14	111
			Switzerland	30	50

Table 8.6-1 – contd

Country	Number of Zoos and Aquaria	Number of species registered (ISIS)	Country	Number of Zoos and Aquaria	Number of species registered (ISIS)
Syria	–	–	(Hong Kong)	2	–
Tajikistan	1	–	United States	643	6 806
Tanzania, United Republic of	2	–	Uruguay	5	–
Thailand	8	172	Uzbekistan	2	–
Togo	–	–	Vanuatu	–	–
Trinidad and Tobago	2	–	Venezuela	16	–
Tunisia	2	–	Vietnam	2	–
Turkey	4	–	Yemen	–	–
Turkmenistan	1	–	Yugoslavia, former	13	–
Uganda	1	–	Zaire	3	–
Ukraine	8	–	Zambia	2	–
United Arab Emirates	2	–	Zimbabwe	1	47
United Kingdom	–	–	TOTAL	1 996	

(Australian National Plant Conservation Network, ANPC; Ornamental Plant Collection Association, OPCA), France (Conservatoire des Collections Végétales Spécialisées, CCVS), North America (Center for Plant Conservation; North American Plant Preservation Council; North American Plant Collection Consortium) and more recently in New Zealand, associated with the Royal New Zealand Institute of Horticulture. These organizations produce, on a regular basis, catalogues containing information on size (number of species and cultivars), locations and accessibility of collections (NCCPG 1994).

8.6 Zoological gardens, insectaries and aquaria

Zoological gardens, aquaria and insect-exhibiting facilities, like botanic gardens, have historically had a range of purposes in different cultures and countries but are now developing a unified role in conservation and education. This is exemplified by the publication, in 1993, of *The World Zoo Conservation Strategy* (IUDZG/CBSG (IUCN/SSC)), which outlines the ways in which zoos and aquaria can contribute to the conservation of the Earth's wildlife and biodiversity and their role in the implementation of the World Conservation Strategy. In particular, zoos maintain *ex situ* many animals which are highly endangered in the wild and the captive specimens may represent an important part of the remaining gene pool of these species. Co-ordinated breeding programmes, with the long-term aim of supplementing wild populations, or re-introducing populations, will play an increasing role in zoo strategy. *Ex situ* living collections of

invertebrates, fish and tetrapods established for conservation purposes also have value as a resource for the study of the biodiversity of the species maintained, at both the genetic and organismal levels (see Section 13.4.3.3 for further analysis of *ex situ* conservation in zoos).

World-wide, there are probably more than 2000 zoological gardens, aquaria and insect-exhibiting facilities: 1996 are noted in Table 8.6-1, and further information on 1787 of these is included in the *Global Zoo Directory* (1993). Of these, roughly 1000 mostly publicly owned facilities have joined national or regional zoological associations. Approximately 800 of these routinely reply to the annual surveys of the *International Zoo Yearbook*, are typically professionally managed, and constitute most of the informally 'recognized' zoos of the world. Nearly 500 are now actively linked as members of the global International Species Information System (ISIS) network – which is expanding at about 40 institutions per year. Through ISIS, member facilities share detailed biological information on hundreds of thousands of specimens.

These zoological gardens and other facilities hold a combined live animal population of more than 700 000 tetrapods (201 000 of which are now registered in detail through ISIS). The facilities also hold an estimated 600 000 fish, and an unknown number of invertebrates. Collections registered with ISIS contain 341 species of amphibians, 1275 species of reptiles, 3101 species of birds, and 1189 species of mammals.

Based on the recent *Global Zoo Directory* (1993), the more developed regions of the world (North America, Europe,

Australasia, Japan) have 1157 zoological facilities – roughly two-thirds of the total, with Latin America, Asia outside Japan, and Africa having a total of 630 presently known. Africa, whose megafauna has pride of place in many zoo collections, has only about 30 zoos. While statistics are not yet available, zoos in the developing regions probably exhibit proportionately more native wildlife, rather than exotics. This is often beneficial – developing local awareness and pride in the local or national fauna, which many people might otherwise never see.

Assessment and monitoring of their collective holdings and the status of captive populations is accomplished in three ways – through the *International Zoo Yearbook* (IZY), the International Species Information System (ISIS), and ‘studbooks’ (see Section 7.3.5.6). IZY provides articles on zoological science management, and surveys some 878 zoos annually – tabulating information on the inventory and captive breeding of notable species. ISIS is an international non-profit membership network, with 499 member facilities at present (from 54 countries on six continents) which share detailed biological information via computers on more than 200 000 living specimens and more than 550 000 of their ancestors, covering 5800 species. Nearly 400 taxa are monitored even more intensively by the same number of volunteer studbook-keepers, who assemble and publish the most complete data possible for their taxon.

8.7 Marine stations

8.7.1 Marine stations and the marine realm

Marine stations are seaside laboratories with a long history of biological and ecological research. In contrast to other major biodiversity resources, marine stations are relatively evenly distributed among tropical, temperate and cold latitudes and between the major coastal ecosystems. Their common culture and traditions, which have predisposed them to co-operative programmes (Lasserre *et al.* 1994), combined with the ease of accessibility of their biological research materials, have encouraged a tradition of high quality descriptive and experimental research.

The marine stations of the world have great potential as an infrastructure for programmes in research, training and education, and conservation of marine biological diversity. Marine stations are usually closely tied to academic institutions or museums with long-standing traditions in the study of marine organisms, in the training of scientists and managers, in communication and exchange with other marine stations, and in environmental impact assessments. Many are government supported with strong mandates in resources management.

There are five areas of research in which marine stations have made a unique contribution: (1) the use of marine organisms as models in developmental biology, molecular biology and genetics, biotechnology, neurobiology and pharmacology; (2) the long history of inventorying and

monitoring all types of marine organisms, forming a firm basis on which to build a comprehensive study of biogeographic gradients in biological diversity; (3) the special facilities that have been developed to study aspects of biodiversity experimentally, ranging from the molecular level to experiments on natural communities in the marine environment; (4) evaluating fish stocks and assisting in developing strategic policies to strengthen the fishing economy in developing countries; and (5) providing the infrastructure both to respond rapidly to unexpected events and to study the biological effects of longer-term environmental change.

8.7.2 Marine stations as biodiversity observatories

The marine stations are ideally placed for inventorying and monitoring marine and coastal biodiversity in terms of their facilities, expertise, long data sets and geographical location (Grassle *et al.* 1991). Outside the deep sea sediments, which support an immensely rich biota (Grassle 1991; 3.1.2.2), the coastal zone has been the major source of novel discoveries in marine biodiversity since the end of the nineteenth century. Historically, marine research stations have played a very important role in such discoveries and many marine stations have published inventories which describe the distribution patterns of marine species to some degree. Most of them have reference collections of local marine fauna and flora, and many of them are well equipped to study delicate forms of pelagic organisms (including gelatinous plankton, picoplankton, ciliates, bacteria and viruses) and benthic taxa (bacteria, ciliates and fungi, meiofauna and macrofauna and the larval stages of all kinds of marine species).

The continuity of research in the vicinity of marine stations has led to the assembly of long-term data sets which form a critical baseline against which human impact may be assessed (Lasserre *et al.* 1994). These data sets are a critical resource for monitoring marine biodiversity, and cataloguing, standardizing and comparing them is a key challenge being undertaken by marine station networks.

8.7.3 Existing networks

A number of regional networks have been formed to co-ordinate biodiversity research in marine stations. These networks, discussed in detail in Section 7.3.3.3, aim to cover the coastal ecosystems by a chain of marine observatories which would exchange their long-term time-series data and develop initiatives to encourage a better use of existing data sets. The objectives are to:

- identify the long-term data sets available in marine stations in order to establish which processes, communities, and variables are best represented, and to highlight where there is a paucity of data that

would recommend the initiation of collections of other long-term data sets;

- design comparative studies that combine the information contained in these data sets to answer relevant questions that transcend the local scenario of the data sets;
- identify constraints to the comparability of these data sets to: (a) modify and standardize sampling procedures; and (b) recognize the methods best suited to compare different data sets;
- develop initiatives to encourage use of existing data sets (e.g. foster an adequate forum for comparative analyses of the data sets, promote intercalibration exercises, improve the availability of the data sets).

8.8 Genetic resource collections

8.8.1 What are genetic resource collections?

A genetic resource collection is a repository of samples of living material of animals, plants, fungi or microorganisms, generally in a dormant or other phase in which they are not actively growing, which have been assembled for use in breeding and for other purposes. The collections encompass stores of gametes, pollen, seeds, spores, tissue cultures and embryos maintained in long-term storage facilities. Material that does not lend itself to such 'dormant' storage can be maintained in field gene banks, as in the case of some cultivated plants (IPGRI 1993; Eberhart *et al.* 1991). Although botanic and zoological gardens and similar types of collections largely maintain material that is actively growing and reproducing ('living collections', 8.5 and 8.6), these institutions are increasingly also housing 'dormant' material.

Although DNA extracts, DNA or RNA sequences, or even a genetic map, could be considered genetic resources, at present they cannot be used to reconstitute the whole organism from which they were derived and are therefore considered separately in this Section (8.3.3 and 8.9).

The organisms in genetic resource collections are predominantly representatives of taxa currently farmed, cultivated or cultured by humans, or the wild relatives of these taxa. In the case of fungi and other microorganisms, because of the difficulties of making fresh isolations from nature, genetic resource collections are a major, and in some cases the only, source of material both for biodiversity studies and for screening for potentially exploitable properties. In the case of bacteria, and from 1993 also certain eukaryotes (such as fungi and microalgae), living strains permanently preserved in such collections also serve as the name-bearing type specimens.

When living organisms are domesticated, cultured,

cultivated or husbanded, people assume responsibility for sheltering them to some degree from the natural evolutionary forces of natural selection and genetic drift. Since the rates of unwanted selection and genetic drift depend on the number of generations per unit time, dormancy, enhanced by cryopreservation techniques, is a vital component of the management of genetic resource collections in keeping these rates low. This is particularly so since the distinct breeds, landraces, strains and cultivars which have been created by artificial selection are usually able to interbreed with each other and, if they escape from collections, can interbreed with their natural relatives, losing some or all of their special characteristics and reverting to the wild (when they are known as feral) or becoming weeds (see also Section 3.1.4). Genetic resource collections are thus especially important as the only practical option for the long-term maintenance of domesticated genetic diversity.

8.8.2 Management of genetic resource collections

Genetic resource collections are assembled to ensure the conservation of genetic diversity, to provide a source of material for its characterization and evaluation and to make it available for distribution and utilization. They also provide a source of material for the characterization and evaluation of the variation present within a species or genus. It is therefore essential that adequate stocks are conserved, and that these are regularly monitored and updated, both to ensure this availability into the foreseeable future and to maintain the genetic integrity of the material.

In all cases, both taxa and individual accessions must be clearly defined and separately catalogued. Relevant information about the origin of individual accessions and their properties needs to be documented and made available with the germplasm accessions. The samples are most appropriately characterized on the basis of known DNA sequence information rather than phenotype information. This provides both a more comprehensive coverage of existing diversity, and may also provide the means to avoid duplication (redundancy) of germplasm collections. In this context, especially in the case of microbial collections, the use of molecular markers, such as those obtained from DNA fingerprinting and RFLP techniques (see Section 2.2), is very valuable, as has been shown for the collection of cassava germplasm by Beeching *et al.* (1993; see also Section 10.1.1.1), and provides a powerful approach for investigating the genetic basis of variation between different varieties and for manipulating complex genomes.

Genetic resources can be conserved *in situ* (maintained in their original habitat and reproducing within the environment in which they evolved and continue to do so) or *ex situ* (maintained outside their habitats, stored in a reproductively dormant condition). If *in situ*, they may be

Box 8.8-1: The Consultative Group on International Agricultural Research (CGIAR): the agricultural research centres network (data from CGIAR 1992).

- *Centro Internacional de Agricultura Tropical* [International Centre for Tropical Agriculture] (CIAT): Germplasm holdings of *Phaseolus* spp. (44 558 accessions); *Manihot esculenta* (5532), and tropical pastures (2001).
- *Centre for International Forestry Research* (CIFOR): Germplasm holdings of woody species.
- *Centro Internacional de Mejoramiento de Maíz y Trigo* [International Maize and Wheat Improvement Centre] (CIMMYT): Germplasm holdings of maize (11 150 accessions), wheat (73 794) *Triticale* (13 268), barley (7991) and rye (194).
- *Centro Internacional de la Papa* [International Potato Centre] (CIP): Germplasm holdings of potato (5455 accessions), sweet potato (5753), and other Andean roots and tubers (468).
- *International Centre for Agricultural Research in Dry Areas* (ICARDA): Germplasm holdings of cereals (47 907 accessions), food legumes (20 091) and forages (19 771).
- *International Centre for Research in Agroforestry* (ICRAF): Germplasm holdings of agroforestry species such as *Grevillea robusta*, *Pentaclethra* spp. *Sesbania* spp. and *Milletia* spp.
- *International Crops Research Institute for Semi-Arid Tropics* (ICRISAT): Germplasm holdings of sorghum (33 108 accessions), millets (29 254), chickpea (16 442), pigeonpea (11 910) and groundnut (13 158).
- *International Institute of Tropical Agriculture* (IITA): Germplasm holdings of sweet potato (1000 accessions), cassava (1704), yams (2250), *Musa* spp. (440), taro (60), wild *Vigna* (1620), soybean (1500), cowpea (15 185), rice (12 355), Bambara groundnut (2000), etc.
- *International Livestock Centre for Africa* (ILCA): Germplasm holdings of browse plants (1629 accessions), grasses (2863), and legumes (6860).
- *International Network for the Improvement of Banana and Plantain* (INIBAP): Germplasm holdings of *Musa* spp. (1032 accessions).
- *International Plant Genetic Resources Institute* (IPGRI) [formerly International Board for Plant Genetic Resources (IBPGR)]: an autonomous international scientific organization whose mandate is to advance the conservation and use of genetic resources.
- *International Rice Research Institute* (IRRI): Germplasm holdings of *Oryza sativa* (74 000 accessions), *O. glaberrima* (2300), wild species and species hybrids (1900), and taxa related to *Oryza* (20).
- *West Africa Rice Development Association* (WARDA): Germplasm holdings of rice (8500 accessions).

artificially maintained as in the case of farmers' fields or managed to some degree as in the case of protected areas (see Section 13.4).

8.8.3 Types of genetic resource collection

Plant genetic resource collections include seed samples, spore samples, pollen samples, field-grown material ('field gene banks') for clonally propagated species such as tuber crops or those with recalcitrant seeds (seeds which do not lend themselves to desiccation and storage at low temperatures) (Table 13.4-4) and *in vitro* collections, as embryos, tissues or cell suspensions (National Research Council 1993; Hintum 1994).

Animal genetic resource collections include embryos and semen under cryogenic storage, groups of living animals kept under supervision in an exclusive area, or networks of breeding groups linked by administrative measures, legal restrictions and financial incentives, such as pedigree registers (Table 13.4-4).

Genetic resource collections of microbial groups comprise cultures of algae, bacteria, fungi (including lichen-forming species and yeasts), protozoa and viruses, as

well as material derived from them in the form of cDNA, plasmids, vectors, cell lines, and genetically engineered organisms. These collections have historically been referred to as 'culture collections', but as their role is identical to that of other genetic resource collections it is most appropriate to consider them as particular categories of genetic resource collections (Hawksworth 1995a).

8.8.4 Content of existing genetic resource collections

8.8.4.1 Plant genetic resources

World-wide, over 150 major crop gene banks are held by international, regional and national institutions, both public and private. Leading international germplasm collections for the major food crops have been established mainly in the International Agricultural Research Centres (IARCs) by the Consultative Group on International Agricultural Research (CGIAR) (Box 8.8-1). Collectively, these centres hold the largest *ex situ* collection in the world with some 510 000 accessions (about 10% of the total holdings), but this is believed to correspond to approximately 35% of all accessions held in *ex situ* collections (FAO 1994). Regional gene banks include the Nordic Gene Bank and the Southern

Table 8.8-1: World plant genetic resource collections (Source: FAO – World Information and Early Warning System on plant ex-situ collections; 11 October 1994).

Country	Number of collections ¹	Number of accessions	Number of species	Country	Number of collections ¹	Number of accessions	Number of species
Afghanistan	1	2 965	18	Côte d' Ivoire	8	21 787	90
Albania	8	16 543	114	Croatia	1	15 336	2
Algeria	4	985	69	Cuba	8	12 408	307
Andorra	–	–	–	Cyprus	1	11 863	33
Angola	–	–	–	Czech Republic	21	53 391	344
Antigua and Barbuda	–	–	–	Denmark	4	3 213	17
Argentina	29	26 318	179	Djibouti	–	–	–
Armenia	–	–	–	Dominica	–	–	–
Azerbaijan	–	–	–	Dominican Republic	3	2 024	126
Australia	33	94 768	547	Ecuador	11	35 780	190
Austria	11	6 908	158	Egypt	1	8 914	27
Bahamas	–	–	–	El Salvador	1	561	39
Bahrain	–	–	–	Equatorial Guinea	–	–	–
Bangladesh	5	10 673	94	Eritrea	–	–	–
Barbados	–	–	–	Estonia	2	1 546	11
Belarus	–	–	–	Ethiopia	3	58 170	1 297
Belgium	15	13 936	678	Fiji	4	943	31
Belize	1	80	23	Finland	4	4 855	29
Benin	9	2 453	61	France	52	190 761	1 003
Bolivia	6	12 429	47	(Guadeloupe)	1	310	16
Bosnia–Herzegovina	2	31	1	Gabon	1	91	16
Botswana	2	3 390	9	Georgia	–	–	–
Brazil	47	151 365	1 027	Germany	34	189 897	4 401
Brunei Darussalam	–	–	–	Ghana	5	2 987	106
Bulgaria	5	39 340	223	Greece	13	13 774	249
Burkina Faso	2	859	77	Grenada	–	–	–
Burundi	–	–	–	Guatemala	3	2 724	61
Bhutan	3	40	7	Guinea–Bissau	1	899	27
Cambodia	1	2 155	1	Guyana	–	–	–
Cameroon	5	2 329	88	Haiti	–	–	–
Canada	20	212 061	1 008	Honduras	7	4 257	647
Cape Verde	–	–	–	Hungary	28	76 827	439
Central African Republic	–	–	–	Iceland	–	–	–
Chad	1	69	6	India	70	344 725	637
Chile	5	3 790	79	Indonesia	15	26 828	96
China, People's Republic of	28	172 113	298	Iran	1	19 392	158
China, Republic of	8	47 151	292	Iraq	2	1 143	56
Colombia	23	91 198	1 046	Ireland	10	3 730	38
Comoros	–	–	–	Israel	6	26 417	266
Congo	4	634	8	Italy	32	76 998	379
Costa Rica	12	15 177	814	Jamaica	4	795	50
				Japan	29	103 960	541

Country	Number of collections ¹	Number of accessions	Number of species	Country	Number of collections ¹	Number of accessions	Number of species
Jordan	—	—	—	Niger	—	—	—
Kazakhstan	—	—	—	Nigeria	8	51 970	118
Kenya	9	54 227	422	Norway	6	1 181	48
Kiribati, Republic of	1	14	1	Oman	2	238	48
Kuwait	—	—	—	Pakistan	5	22 354	112
Kyrgyzstan	—	—	—	Panama	4	1 538	56
Korea, Democratic People's Republic of	—	—	—	Papua New Guinea	8	5 656	126
Korea, Republic of	15	115 837	39	Paraguay	1	1 571	16
Latvia	1	1 907	5	Peru	22	34 244	271
Lebanon	—	—	—	Philippines	11	145 422	304
Lesotho	—	—	—	Poland	20	78 659	750
Liberia	3	1 707	4	Portugal	10	17 429	206
Libya	1	2 313	34	Qatar	—	—	—
Liechtenstein	—	—	—	Romania	10	42 643	269
Lithuania	2	2 266	7	Russian Federation	2	276 804	255
Luxembourg	—	—	—	Rwanda	2	6 168	9
Macedonia, The former Yugoslav Republic of (see Yugoslavia)	—	—	—	Saint Kitts and Nevis	—	—	—
Madagascar	3	4 046	29	Saint Lucia	1	58	1
Malawi	6	11 421	45	Saint Vincent and the Grenadines	—	—	—
Malaysia	8	31 225	80	Samoa	1	138	18
Maldives	—	—	—	San Marino	—	—	—
Mali	1	248	4	Sao Tome and Principe	—	—	—
Malta	—	—	—	Saudi Arabia	—	—	—
Marshall Islands	—	—	—	Senegal	3	1 011	7
Mauritania	—	—	—	Seychelles	1	369	23
Mauritius	1	195	30	Sierra Leone	3	1 848	25
Mexico	21	189 819	268	Singapore	—	—	—
Micronesia, Federal States of	—	—	—	Slovak Republic	13	14 836	127
Moldova, Republic of	—	—	—	Slovenia	2	447	3
Monaco	—	—	—	Solomon Islands	1	1 130	15
Mongolia	—	—	—	Somalia	1	94	1
Morocco	7	3 115	106	South Africa	9	19 794	1 192
Mozambique	3	1 872	8	Spain	32	71 042	639
Myanmar	1	0	1	Sri Lanka	8	11 781	113
Namibia	1	1 515	3	Sudan	3	5 178	81
Nepal	6	8 042	60	Suriname	—	—	—
Netherlands	20	71 884	702	Swaziland	—	—	—
New Zealand (Niue Island)	4 1	28 914 94	60 5	Sweden	5	23 618	313
Nicaragua	2	2 207	48	Switzerland	17	14 283	314
				Syria	6	98 425	406
				Tajikistan	—	—	—
				Tanzania, United Republic of	8	2 510	101

Table 8.8-1 – contd

Country	Number of collections ¹	Number of accessions	Number of species	Country	Number of collections ¹	Number of accessions	Number of species
Thailand	18	32 404	196	United States	81	519 726	5 920
Togo	2	333	13	(Puerto Rico)	1	4 000	1
Tonga	1	8	1	Uruguay	4	1 256	291
Trinidad and Tobago	2	2 315	16	Uzbekistan	–	–	–
Tunisia	4	504	61	Vanuatu	1	664	6
Turkey	4	24 824	351	Venezuela	6	15 356	66
Turkmenistan	–	–	–	Vietnam	24	21 493	149
Tuvalu	1	140	5	Yemen	4	4 229	60
Uganda	5	11 483	58	Yugoslavia (former)	8	7 246	52
Ukraine	–	–	–	Zaire	3	18 830	64
United Arab Emirates	–	–	–	Zambia	6	5 901	42
United Kingdom	30	106 205	1 944	Zimbabwe	1	2 886	2
(Cayman Islands)	–	–	–	TOTAL	1 224		

¹Note: Number of collections is not necessarily equivalent to number of gene banks in a given country.

African Development Community (SADC) Gene Bank while examples of national gene banks are those of CENARGEN (Brazil), CSIRO (Australia), the National Bureau of Plant Genetic Resources (India), the Plant Genetic Resources Centre (Ethiopia), the M.I. Vavilov Institute of Plant Industry (Russia) and the United States Plant Germ Plasm System (Plucknett *et al.* 1987, Appendix 2).

The CGIAR International Agricultural Research Centres concentrate on land races and cultivars of particular crops and their wild relatives while the storage of seed and other propagules of wild plants is the primary focus of most botanic garden gene banks. There are also some specialist seed banks, such as the one for taxa of the *Brassica* family (Heywood 1992).

The extant world plant germplasm collections together hold some 4.51 million accessions, but these are mainly of agricultural crop cultivars and landraces (Table 8.8-1). While this number may at first appear large, about 3 million of the accessions relate to only around 100 species (Holden *et al.* 1993), most housed at the specialist CGIAR International Centers (Plucknett *et al.* 1987). They do not therefore represent an adequate sample of even the world's utilized plants. A more detailed breakdown of some of the accessions and their coverage is given in Table 3.1-6.

Recognition that the sheer size of a germplasm collection could militate against its use led Frankel (1984) to propose the notion that it could be pruned to form a 'core collection'. This can be defined as 'a limited set of accessions derived from an existing germplasm collection, chosen to include as much as possible of its genetic diversity'. A review of 'core collections' is given by Hodgkin *et al.* (1995).

The current system of germplasm collections (mainly seed banks) does not provide an adequate representation of the world's flora. Fewer than 1% of the world's plant species comprise more than 60% of the accessions (Halloy 1990). If the number of species of utility to humans is considered, the situation is also far from satisfactory. As an illustration of this, the Plant Resources Project of South-East Asia (PROSEA) records over 8000 species in its basic list of species used by humankind in that area (Lemmens *et al.* 1989) and assuming that similar percentages of the floras of other regions are similarly employed, Heywood (1993b) has extrapolated a figure of 25 000–30 000 species for the tropics as a whole. In addition, several thousand species are used by humans in temperate regions of the world and many thousands of species are grown for ornament in parks, in public and private gardens, and as street trees. Up to 25 000 species have been used in traditional medicines. Huxley and Westley (1989) consider that 2000 woody species are of value to humans. Vietmeyer (1990) estimated that around 20 000 species are edible by humans world-wide, of which 3000 are regularly used. If this figure is accepted, it would mean that existing gene banks contain a mere 0.5% of the species actually used by humans as food. Addressing this situation in an adequate way would be an enormous undertaking, especially as so many accessions are necessary, at least in the case of crop varieties, to reflect adequately the genetic variation in domesticated species. For example, although there are 333 413 accessions of rice *Oryza sativa* (WCMC 1992), they still do not cover all the land races that the International Rice Research Institute (IRRI) would ideally wish to safeguard. Just how much genetic variation in wild species

Table 8.8-2: World animal genetic resource collections. This table presents the numbers of indigenous breeds of the main mammalian livestock species (ass, water buffalo, cattle, goat, horse, pig and sheep: WCMC 1992; Hall and Ruane 1993) with an indication from an incomplete survey of the literature by SJGH, of the nature of the genetic resource collections for these species in the respective countries. Note that water buffalo and cattle are combined, and ass and horse. Poultry includes waterfowl and turkeys. An entry in the table indicates that in the respective country there is some conservation activity for one or more indigenous breeds. Abbreviations:

- G Government station conserving, evaluating or multiplying
- N Other government organization or large NGO concerning itself with indigenous breeds (includes universities, charities, environmental organizations)
- P Established and long-term conservation mainly in private sector
- B Breed society normally operating herdbook, flockbook, studbook or pedigree register
- I Legal or financial inducement or restriction aimed at supporting indigenous breed
- F Feral population either protected or not
- C Cryogenic conservation of semen and/or embryos

Country	Number of collections	Poultry	Cattle	Sheep	Goats	Pigs	Equids
Afghanistan	22						
Albania	21						
Algeria	16			G			
Andorra	0						
Angola	9						
Antigua and Barbuda	0						
Argentina	11		GBF				
Armenia	11						
Australia	43	F	GB	GB	F	BF	F
Austria	16		BC	BC			BC
Azerbaijan	19						B
Bahamas	1						
Bahrain	2						
Bangladesh	17						
Barbados	1						
Belarus	7		C				
Belgium	17		BC		B	B	B
Belize	1						
Benin	5		G				
Bhutan	4						
Bolivia	5		GBC				
Bosnia-Herzegovina	5						
Botswana	9		G	G	G		
Brazil	66		GPBC	GPBC	GC	GP	GPB
Brunei Darussalam	0						
Bulgaria	65						
Burkina Faso	7		C				

Table 8.8-2 – contd

Country	Number of collections	Poultry	Cattle	Sheep	Goats	Pigs	Equids
Burundi	0						
Cambodia	6						
Cameroon	13		G	G			
Canada	22	N	NIC				BF
Cape Verde	0						
Central African Republic	0						
Chad	16						
Chile	3						
China, People's Republic of	236	N		GPI			
China, Republic of	4						
Colombia	15		GPBC				
Comoros	0						
Congo	0						
Costa Rica	3						
Cote d'Ivoire	2						
Croatia	10	BC	B		B	B	B
Cuba	7						
Cyprus	7			F			
Czech Republic	28	N	NC	NC	NC	NC	NC
Denmark	12		BC	B	B	BC	BC
(Faeroe Islands)	3		NC	N			
Djibouti	1						
Dominica	3						
Dominican Republic							
Ecuador	3		G				F
Egypt	30			G		G	
El Salvador	0						
Equatorial Guinea	0						
Eritrea							
Estonia	10		GB				B
Ethiopia	33			G			
Fiji	1						
Finland	10	P	NBC	NBC	BC	BC	BC
France	126	N	BIFC	GBFC	BC	NBC	NBC
Gabon	0						
Gambia	5		N				
Georgia	18		GC	GC			
Germany	78	NP	NBIC	NBC	BC	NBC	NBC
Ghana	6						
Greece	39	N	N	N			NB
Grenada	0						

Country	Number of collections	Poultry	Cattle	Sheep	Goats	Pigs	Equids
Guatemala	1		P				
Guinea	3		G				
Guinea-Bissau	5						
Guyana	0						
Haiti	0						
Honduras	1						
Hungary	25	G	GC	G		G	GBC
Iceland	6	N	NC	NI		NI	B
India	171		NPB		G		N
Indonesia	28	P					
Iran	55						
Iraq	16						
Ireland	13		GBC	B	B	B	BC
Israel	12						
Italy	119		BIC	B	B	B	GB
Jamaica	5						
Japan	21	P	NB		P		P
Jordan	3						
Kazakhstan	31		B				
Kenya	24		NB				
Korea, DP Republic of	7						
Korea, Republic of							
Kuwait	0						
Kyrgyzstan	11						
Lao, People's Democratic Rep.	2						
Latvia	5		B				
Lebanon	5						
Lesotho	2						
Liberia	4						
Libya	7			G			
Liechtenstein	0						
Lithuania	7		B			P	
Luxembourg	0		BC	B		BC	B
Macedonia, ex Yugo. Rep.	4						
Madagascar	5						
Malawi	4						
Malaysia	8						
Maldives	0						
Mali	21						
Malta	3						
Marshall Islands	0						

Table 8.8-2 – contd

Country	Number of collections	Poultry	Cattle	Sheep	Goats	Pigs	Equids
Mauritania	10						
Mauritius	0						
Mexico	14						
Micronesia, Federal Rep. of	0						
Moldova, Republic of	1						
Monaco	0						
Mongolia	14						
Morocco	36			G			
Mozambique	6						
Myanmar	6						
Namibia	9						
Nepal	24						
Netherlands	37		NBC	NB	NB	NB	NBC
New Zealand	25		NBC	GNBF	PF	NBF	NPBF
Nicaragua	1						
Niger	15		G				
Nigeria	32						
Norway	20	N	NBC	NBC	NBC	NBC	NB
Oman	7						
Pakistan	96		NI				
Panama	0						
Papua New Guinea	1						
Paraguay	1						
Peru	7						
Philippines	17						
Poland	57	N	GBC	NBC		NB	NB
Portugal	56		BC	B	B	B	NB
Qatar	0						
Romania	40	N	BC	B		GB	
Russian Federation	99	N	GBC			B	N
Rwanda	2						
Saint Kitts and Nevis	0						
Saint Lucia	0						
Saint Vincent and Grenadines	0						
Samoa	0						
San Marino	0						
São Tome and Principe	0						
Saudi Arabia	11						
Senegal	14		G	G			
Seychelles	1				F		

Country	Number of collections	Poultry	Cattle	Sheep	Goats	Pigs	Equids
Sierra Leone	4						
Singapore	0						
Slovak Republic			BC			B	
Slovenia	8		BC	BC			
Solomon Islands	0						
Somalia	20						
South Africa	46		GB	G			
Spain	111	N	BC	B	B		B
Sri Lanka	12						F
Sudan	51		GN	N			
Suriname	0						
Swaziland	1		P				
Sweden	19	N	BIC	BI	I		B
Switzerland	29		NBC	NB	NBC	NBC	NBC
Syria	16						
Tajikistan	14						
Tanzania, United Republic of	14		N				
Thailand	10						
Togo	5						
Trinidad & Tobago	0						
Tunisia	13						
Turkey	55						
Turkmenistan	11						
Uganda	16						
Ukraine	31		GBC			B	
United Arab Emirates	0						
United Kingdom	160	NP	NPBIFC	NPBFC	NPBFC	NPBC	NPBC
United States of America	130	NF	GNBC	NPBF	NF	NPBF	NPB
Uruguay	3		N	N			
Uzbekistan	19		B				
Vanuatu	0						
Venezuela	9		G				
Vietnam	18						
Yemen	36						
Yugoslavia	85		BC	B		B	B
Zaire	13						
Zambia	1		G				
Zimbabwe	7		GB				

Notes: For the pairs Czech and Slovak Republics, Democratic People's Republic of Korea and Republic of Korea, Eritrea and Ethiopia, the numbers of native breeds are for the two countries combined and the genetic resource collections are detailed for each country separately. The entry for France includes French overseas territories

This table has been compiled from the following sources: Alderson (1990), Basile (1992), Burke (1988), Chapuis *et al.* (1994), Clarke and Dzieciolowski (1991), Coblenz (1990), Corbet and Harris (1991), Crawford (1990a,b), Groombridge (1992), Hall and Ruane (1993), Henson (1992), Hodges (1992), Hone (1990), Katyega (1987), Loftus and Scherf (1993), Macfarlane (1993), Melgar *et al.* (1985), Ministère de l'Agriculture et de la Pêche (1992), Mukai *et al.* (1989), Muñoz and Tejon (1986), O'Uigin and Cunningham (1990), Rege and Lipner (1992), Rodríguez and Martínez (1992), Simon and Buchenauer (1993), Weiner (1990).

should be stored is a matter that has not yet been resolved.

Although 528 botanic gardens and arboreta report having a seed bank, many are poorly constituted and are probably little more than a seed handling facility without a capacity for more than short-term seed storage. Many seed facilities in botanic gardens still operate only to allow them to participate in the international seed exchange scheme between botanic gardens. In a survey undertaken between 1985 and 1990 by BGCS, 144 botanic gardens reported having a low-temperature seed storage facility. Guidelines for the management of seed collections by botanic gardens are being prepared by the Center for Plant Conservation and ANZECC.

Pollen, unlike seed, is not a conventional means of germplasm storage and the main use of stored pollen has been in plant breeding to facilitate hybridization between plants that flower at different times.

Information on plant tissue culture collections is often incorporated with those of microbial collections and included in microbial databases (see 8.8.4.3). In 1992, 29 botanic gardens were known to have opened tissue culture units. These units are being used both for plant propagation and for tissue storage. Many new tissue culture facilities are being opened annually in botanic gardens. A network of such facilities operates, linked by the *Botanic Gardens Micropropagation Newsletter*, which is published twice a year by the Royal Botanic Gardens, Kew, in association with BGCI. The International Plant Propagation Society founded in 1951 also publishes material on micropropagation. An analysis of botanic garden seed lists in recent years indicated that 432 (of 600 from 25 countries) contained wild-collected seeds.

8.8.4.2 Livestock

Of the species of mammals, other vertebrates and invertebrates kept by humans (Mason 1984; WCMC 1992), only about 40 species are important in their daily existence and very few are represented in genetic resource collections. Large sectors of animal husbandry do not have any such collections. Many local breeds of dog are endangered (e.g. Brisbin 1989) and there are no genetic resource collections backing up the farming of deer and other game species (Boyazoglu and Hetényi 1994). There are only a few genetic resource collections of local wild populations of salmon (*Salmo salar*) from different rivers in Norway and Iceland, and farmed stocks are cryogenically conserved in national sperm banks (Gausen 1993). Conservation of old honeybee (*Apis* spp.) stocks seems to be practised only by the prohibition of the keeping of other varieties within defined areas; bees of the old European black type are protected in this way in Australia (Ruttner 1976), and the Bashkir bee in the Russian Federation likewise (Petrov 1980). At least one

strain of laboratory mice is conserved as frozen embryos (AICR 1991).

In several countries one or more of the indigenous breeds of livestock are represented in genetic resource collections, organized in ways which reflect the livestock traditions of that country. Hardly any such collections include material from other countries. The only exceptions are stocks of semen or embryos, belonging to livestock development companies or organizations, which are imported for the development of local breeds. These stocks are therefore not to be seen as fostering genetic conservation *per se*, but rather as functioning in a parallel manner to the CGIAR institutes for crop plants (see Table 8.8-2 and Table 3.1-8 which summarizes the *World Watch List for Domestic Animal Diversity*, published by FAO/UNEP (1993), which lists 2800 breeds for seven domestic livestock species).

8.8.4.3 Fungi and other microorganisms

Microbial collections include strains which are important for both biosystematics and human utilization. However, they must expand their scope considerably if they are adequately to represent all microbial groups. At present the World Data Centre for Microorganisms (WDCM), established under the aegis of the World Federation for Culture Collections (WFCC) and sponsored by UNEP, UNESCO and RIKEN, holds a database on 786 328 microorganism strains held by 482 collections from 58 countries: 44% are fungi (including yeasts), 43% bacteria, 2% viruses, 1% live cells and 10% others (i.e. plasmids, plant cells and algae; Smith and Hawksworth in press; Sugawara *et al.* 1993; Table 8.8-3). Further, 35% of all strains are held by only ten collections.

As, with a few exceptions, cultures of bacteria have to be deposited in collections as a requirement for valid publication of the name (Lapage *et al.* 1992), we have by definition almost 100% coverage for the 3100 known species. However, that figure has to be seen in the context of the huge numbers of bacteria that are undescribed and uncultured (Table 3.1-2). In the case of the fungi, it has been estimated that in 1990 the collections registered with the World Data Centre for Microorganisms collectively held about 11 500 species, around 17% of those then described, and fewer than 1% of those estimated to occur (Hawksworth 1991a). The proportion of described species in culture collections is likely to decrease with time as of the 1700 or so fungi newly described each year, about 70% are not cultured.

Extensive genetic variation occurs within fungi and other microorganisms. Biological species occur within many already cultured fungal 'species' (Brasier 1987; see Section 3.1), and numerous genetic variants are known of others – over 3000 in the case of the sexually reproducing *Neurospora crassa* (Fungal Genetics Stock Center 1988).

Table 8.8-3: Microbial genetic resources collections world-wide (Source: Database of World Data Center on Microorganisms, Riken, Japan; Data 6 May 1994).

Country	No. of collections	No. of names ¹ (Bacteria)	No. of names ¹ (Fungi)	Country	No. of collections	No. of names ¹ (Bacteria)	No. of names ¹ (Fungi)
AFRICA				Italy	9	352	230
Egypt	1	0	0	Netherlands	8	1 047	8 548
Kenya	1	15	1	Norway	2	0	0
Nigeria	3	7	2	Poland	5	319	210
Senegal	2	5	1	Portugal	1	0	0
South Africa	3	41	0	Romania	1	41	22
Uganda	1	0	0	Russian Federation	9	1 044	1 724
Zimbabwe	2	30	17	Slovenia	1	0	0
Subtotal	13	84	17¹	Spain	4	601	550
ASIA				Sweden	2	723	1 464
China, Republic of	13	1 177	931	Switzerland	1	483	19
India	12	413	1 583	United Kingdom	25	3 808	4 505
Indonesia	14	62	58	Yugoslavia (former)	2	7	1
Iran	1	178	50	Subtotal	138	8 977²	13 343³
Israel	2	18	0	NORTH AMERICA			
Japan	23	2 470	3 970	Canada	28	945	3 575
Jordan	1	6	0	Guatemala	1	44	78
Korea, Republic of	2	0	0	Mexico	10	350	279
Malaysia	3	207	58	United States of America	31	3 751	6 758
Pakistan	1	0	0	Subtotal	70	4 323	8 942
Philippines	8	102	322	SOUTH AMERICA			
Singapore	2	114	115	Argentina	7	435	118
Sri Lanka	4	65	44	Brazil	44	1 055	1 508
Thailand	59	254	474	Chile	1	2	24
Turkey	2	181	83	Colombia	1	1	0
Subtotal	147	3 666	5 485	Venezuela	1	66	0
EUROPE				Subtotal	54	1 392	1 592
Austria	1	0	0	AUSTRALASIA			
Belgium	5	29	1 570	Australia	50	1 402	2 202
Bulgaria	3	1 306	186	New Zealand	9	943	802
Czech Republic	15	1 453	1 488	Papua New Guinea	1	1	0
Denmark	2	139	1	Subtotal	60	1 902	2 588
Finland	2	93	139	TOTAL			
France	14	2 432	788	482	9 671¹	19 392¹	
Germany	14	2 263	2 559				
Greece	4	96	297				
Hungary	6	583	343				
Ireland	2	108	105				

1. Totals do not allow for synonymy and also include infraspecific taxa.

2. Accurate information known only from Zimbabwe.

3. Subtotal excludes the names of bacteria and fungi in the collections from the countries of the former Soviet Union.

A parallel situation occurs in clonal (mitosporic) fungi, and bacteria; for example, some 1500 serological variants of *Salmonella* are held by the International *Salmonella* Center and 6000 of *Escherichia coli* in the *E. coli* Genetic Stock Centre (Bachmann 1988).

An increasing amount of data pertinent to bacterial systematics and collections in particular are now available through electronic networks and databases; Canhos *et al.* (1993) list eight electronic networks, nine information resources, and 23 computerized databases (see 8.4).

The World Federation for Culture Collections (WFCC) coordinates the activities of culture collections. The WDCM was established within this framework, and presently holds on-line information on the strains maintained. Detailed information on these strains is offered to the public through catalogues, published periodically by most of the major culture collections (Sugawara *et al.* 1993). There are other organizations at regional and international levels, such as the European Culture Collection Organization (ECCO), Microbial Strain Data Network (MSDN), and the Microbial Resource Centres (MIRCENs), information about these can be found in Hawksworth and Kirsop (1988) and Smith and Hawksworth (in press).

8.8.5 Constraints

The major constraints to the formation, adequate management and use of genetic resources collections, as discussed in more detail in Cohen *et al.* (1991), are:

- Shortage of trained people to collect and classify.
- Poor understanding, in many cases, of the genetics and population biology of the taxa in question.
- Lack of basic biological knowledge on species and their variability.
- Lack of appropriate techniques for long-term preservation.
- Lack of secure funding and funding mechanisms, especially in the long term.
- Poor awareness of the strategic and long-term value of genetic resource collections among policy makers, researchers and potential users.
- Increasing social and political barriers to collection and exchange, as expressed by variety rights and patents, and legislation to restrict movements of species across borders
- Poor social awareness of conservation issues.

8.8.6 The development of genetic resource collections

8.8.6.1 Plants

Future priorities for assembling plant genetic resource collections include:

- Assessment of the biodiversity already available within existing collections and identification and prioritization of missing or under represented species, geographic regions and environments.
- Development of improved management methods for long-term secure conservation, including the maintenance of genetic integrity.
- Use of existing collections as part of sustainable development.
- Determination of which segments of biodiversity are best conserved *in situ* in wildland areas.

Although collections of some of the world's major crops are extensive, and relatively secure, the situation for many other crop and tree gene pools is far less satisfactory. For example, Clement (1991) stressed the need for further research in the field of perennial crops – principally fruit trees – domesticated or semi-domesticated by indigenous people of Western Amazonia. Whilst well-known species, such as cassava (*Manihot esculenta*), pineapple (*Ananas comosus*), rubber (*Hevea* spp.), papaya (*Carica papaya*), cacao (*Theobroma cacao*), and brazil-nut (*Bertholletia excelsa*) have *ex situ* and *in situ* collections, many others are little known outside the region, but contain significant genetic diversity and are unrepresented in the collections. For a major review of tropical forests and their crops, see Smith *et al.* (1992).

There are still gaps in the range of accessions of both land races and wild relations of crop species, and in many collections not all accessions are well documented. Valuable collections are not always adequately regenerated or multiplied, and Buttel (1992) considers that a large proportion of genetic resources in crop seed banks are dead – a statement in need of critical evaluation. Material may also not be available because of insufficient quality or quantity, and unwarranted replication of accessions between and within collections can hinder their effectiveness. Greater international co-ordination of botanic garden seed banks is required as well as information on their holdings which are still inadequately known.

Also, there is a need for further research into the technology of germplasm conservation and experimental testing of techniques. Conservation efforts have barely begun for a wide range of species (IPGRI 1993). Genetic diversity needs to be measured, both in the field and in germplasm already conserved, and further research is

needed to design optimum conservation strategies (Center for Plant Conservation 1991; Brown and Schoen 1994).

8.8.6.2 *Livestock and other animals*

The priorities for animal genetic resource collections include:

- The making of inventories of livestock and other domesticated animals in areas that have not been fully documented (e.g. Africa).
- The strengthening of protection of breeds in areas that have been surveyed but where greater protection is needed (notably the former Soviet Union and China).
- Taking account of the need to conserve local breeds in livestock development projects, especially in those countries with indigenous breeds.
- The establishing of genetic resource collections for the many sectors of animal agriculture that do not have them (see 8.8.2).

Conservation of rare breeds could be facilitated by requiring that all relevant stock improvement proposals supply a 'genetic impact statement' (Hall 1992). If the development is likely to damage the genetic integrity of local breeds, then conservation of the latter must be assured.

8.8.6.3 *Fungi and other microorganisms*

The future priorities for microbial genetic resource collections should be to:

- Capture a greater proportion of the microbial gene pool in world collections by long-term cryopreservation methods in order to safeguard their genetic potential. This work should begin with collection of material from disappearing habitats.
- Improve collaboration between and strengthen the present network of 482 collections within the World Federation for Culture Collections to maximize complementarity.
- Consider how to establish a framework similar to that co-ordinated by IPGRI for plant genetic resources.
- Develop methods for quality control of the collections.
- Develop new techniques to culture and preserve hitherto uncultured strains and strains from extreme conditions.

The World Federation for Culture Collections (WFCC) has prepared guidelines for the establishment and operation of microbial collections (Hawksworth 1990; Kirsop and Hawksworth 1994).

8.9 Sequence databanks

Molecular techniques and databases offer a means to survey and quantify biodiversity through the acquisition, storage and analysis of linear sequences of amino acids and nucleotides. As has been seen in earlier Sections of the GBA, molecular sequence studies of DNA, RNA and proteins are powerful tools, and in some cases the only ones available, for biosystematic analysis, biodiversity surveying, and quantification and conservation.

Molecular databases are held in the developed countries of the northern hemisphere, with access typically free via the Internet and through CD-ROM subscriptions (but see Section 9 for a discussion of the problems of accessing data on human, livestock and crop plant gene sequences). The principal molecular databases are listed in Box 8.9-1. There are two groups: nucleic acid sequence (DNA and/or RNA sequences) repositories and protein (amino acid) sequence repositories. World-wide there are three primary databases that collect and distribute nucleic acid sequences: GenBank, EMBL and the DNA Data Bank of Japan (DDBJ). These databases exchange and update data on a daily basis. The major protein databases are the PIR-International Protein Sequence Database and the SWISS-PROT protein sequence database. To make molecular databases useful for measures of biodiversity, resources must be allocated to ensure that electronic access is easy and affordable.

Databases often contain supporting documentation and software tools for the manipulation and analysis of molecular sequences. For example, the National Center for Biotechnology Information at the National Library of Medicine in the US supports Nentrez (via the Internet) and Entrez (on CD-ROMs). Both provide access to nucleic acid and protein databases and offer links to a literature citation database, MEDLINE. A variety of tools exists for retrieving sequences according to keywords, authors, and organism names amongst others. A recently announced feature of Nentrez and Entrez is the ability to use classification hierarchies to extract sequences. Ultimately the biosystematic mode will accommodate alternative phylogenetic perspectives in the search procedures. Although biosystematic information has always been available in molecular databases, such as EMBL and GenBank, the ability to search and sort sequences according to taxonomic rank represents a step forward in making molecular databases useful for studies of biodiversity.

Box 8.9-1: Molecular sequence database.*Primary nucleic acid databases*

GenBank	NIH, Bethesda, Maryland, USA	info@ncbi.nlm.nih.gov
EMBL European Molecular Biology	Hinxton Hall Hinxton Cambridge CB10 1RQ, UK	datalib@ebi.ac.uk
DNA Data Bank of Japan	Mishima, Japan	

Specialized Nucleic Acid Databases

Ribosomal Database Project (RDP)	University of Illinois, USA	rdp@phylo.life.uiuc.edu
--	--------------------------------	-------------------------

Primary Protein Databases

SWISS-PROT	Geneva, Switzerland	datalib@embl-heidelberg.de
PIR	Multinational	PIRMAIL@nbrf.georgetown.edu

Specialized Protein Databases

PROSITE (protein function and structure)	Geneva, Switzerland	datalib@embl-heidelberg.de
--	---------------------	----------------------------

Note: Access to and information about the RDP can be obtained by sending e-mail or making an 'anonymous ftp' connection to: info.mcs.anl.gov (140.221.10.1). Change directory to pub/RDP and get the 000README.ALL file. In addition to the data, RDP services are available by electronic mail. Further information is available by sending to rdp@mcs.anl.gov a single line e-mail message with the word: Help.

Additional information about molecular databases can be obtained from the database issue of the journal *Nucleic Acid Research* **21**: 2963–3156 (1993).

The lack of attention paid until recently to the role of taxonomic information in molecular databases is also reflected in other ways. One of the most problematic is that there is no obligation for scientists depositing sequence data in databanks to preserve voucher material simultaneously when the organisms are preservable. A consequence of this policy is that it is not always possible to re-check identifications when divergent sequence data are lodged for the same species. In the long-term interests of data quality, the practice of making it mandatory for depositors to deposit vouchers in service genetic resource collections should be encouraged wherever possible.

Most molecular data exist as individual sequence submissions to databases such as EMBL, GenBank or SWISS-PROT. For example more than 500 chloroplast ribulose-bisphosphate carboxylase gene coding region sequences have been deposited in GenBank. They have been used to measure the diversity of plant chloroplast genomes and to reconstruct the evolutionary history of plants (Chase *et al.* 1993). An even larger database used to infer phylogenetic relationships is the collection of more than 2000 small subunit ribosomal RNAs (ribonucleic acids), commonly referred to as 16S, 18S, 16S-like or SSU rRNA sequences. These sequences have gained widespread

acceptance among systematic biologists for inferring relationships at all levels of the taxonomic hierarchy, from above the kingdom to below the species, and are therefore an extremely powerful means of measuring and understanding organismal biodiversity (see Section 2.1). Though the number of major groups that have no representative members within the rRNA dataset continues to shrink, there remain major gaps in our knowledge, particularly of eukaryotic microorganisms.

The contribution of macromolecular (nucleic acid and protein) sequences in assessments of biodiversity, as well as any inferences of phylogenetic relationships, is contingent upon the ability to align homologous positions between macromolecules of varying length. Unlike archival databases, sequence alignments represent dynamic data structures that change significantly in response to the addition of new information. In general, databases such as EMBL and GenBank do not maintain alignment information for homologous sequences (sequence alignments can be submitted to or retrieved from these databases but only in a static, archival form). Ribosomal RNAs are a notable exception: complete ribosomal sequences can be retrieved in aligned format from the Ribosomal RNA DataBase Project (RDP), which updates its alignments at regular intervals (see note at end of Box 8.9-1). The RDP is a curated database that incorporates new information into a multiple sequence alignment for the 5S, 16S-like and 23S-like ribosomal RNAs. It is maintained at the University of Illinois with a grant from the National Science Foundation. Through e-mail and FTP servers, the RDP offers aligned and phylogenetically ordered rRNA sequences in a variety of user-selected formats, as well as various software programs for handling and analysis of data. In addition, services are provided such as automated sequence alignment, probe design checking, user-selected subsets of the sequence data with corresponding phylogenetic trees, and rRNA secondary structures. This database is of central importance to studies of molecular systematics, molecular structural analysis, and organism detection and identification.

8.10 Human resources

Crucial to the capacity of countries to undertake the monitoring and assessment of the magnitude of biodiversity is the availability of personnel, something governed by both training and funds for employment. The size and distribution of the existing human resource now deployed in systematics is a key constraint which will restrict the ability of countries to fulfil their obligations under the Convention on Biological Diversity, especially under Article 7. The need for urgent action to address this situation has been highlighted in, for example, *Systematics Agenda 2000* (1994).

8.10.1 The magnitude of the resource

8.10.1.1 Systematists

Minelli (1993) speculated that there were 20 000–30 000 systematists working world-wide, but these figures were not based on any data set (Minelli, pers. comm.). For North America, based on scaled-up returns of about 2500 questionnaires, an estimate of 8000–10 000 taxonomists was reached by Edwards *et al.* (1985). Another approach was taken by Stuessy (1993) who analysed society membership lists, staff lists for herbaria, and other sources, to derive an estimate of 1000–2000 'active working plant taxonomists in the world'.

None of the above estimates adopted an unambiguous definition of a systematist or taxonomist, including curators, technicians and identifiers, as well as those generating classifications. One objective measure of the workforce available to describe new species is the number of persons actually publishing them in a 12-month period. Analyses of the principal nomenclatural databases, commissioned for the GBA, revealed that during 1991–2, almost 7000 taxonomists described 20 723 species as new to science in a 12-month period (Table 8.10-1). This figure of 7000 is likely to be an underestimate of the total number of active biosystematists on Earth as: not all biosystematists describe species new to science every year; data for algae and bryophytes were not available; there will be some omissions from the indexing databases; and authors with the same surname and initials will have been counted as one person. However, the total does include those who work only on fossils, which account for one-third of the new names now being introduced in zoology. This fact alone gives a figure of 1735 systematists, and more than compensates for the above four points. In view of these considerations, the figure of 7000 is considered as a reasonable approximation of the human resource potentially available to describe new species found in inventory programmes.

Many factors affect the 'productivity' of particular scientists in terms of the number of new species they describe in a year, of which the proportion of their time that can be devoted to taxonomy is critical. As discussed below, Janzen (1993) observed 'that the bulk of good taxonomists today are spending only 0–20% of their time actually doing taxonomy', a figure from which few of the profession would dissent. Using the 20% figure on the 7000 estimate yields a mere 1400 full-time equivalents, which is clearly inadequate for the task at hand. However, it should also be borne in mind that there is pool of trained systematists who have never found employment in the field: while currently following other careers, they could be available to compete for new positions.

With respect to the workforce, retired professionals merit particular attention, as systematists tend to become more productive with age as their experience of both their chosen groups and the literature accrues. For example, the botanist T.G. Tutin described more species after he reached age 60 years than at any time since he was under 30 (J. Parnell, unpubl.).

Table 8.10-1: The numbers of new species of organisms described as new to science in 1992 compared with the number of authors involved and the numbers of known and estimated species.

Organisms ¹	Species ²	Authors	Species per author		
			1992	Known ³	Estimated ⁴
Viruses ⁵	100	75	3	53	5 333
Bacteria ⁶	120	336	0.4	12	1 190
Fungi ⁷	1 600	498	3.2	141	3 012
Plants ⁸	1 705	875	2	309	366
Animals ⁹	17 218	5 205	3.3	254	1 883
Totals	20 743	6 989	3	250 ¹⁰	1 949 ¹⁰

1. Treated in groups as indexed by the sources indicated; they include fossils in the case of fungi and animals but omit algae and bryophytes as they are not indexed annually.

2. Only newly described species are considered; supra- and infraspecific taxa, transfers between genera, and changes in rank are excluded.

3-4. Data from Table 3.1-2.

5. Data supplied by M.A. Mayo (International Committee on Taxonomy of Viruses).

6. From the International Journal of Systematic Bacteriology, extracted by G.S. Saddler.

7. *Index of Fungi* database, extracted by P.M. Kirk.

8. Index Kewensis database, extracted by R.A. Davies.

9. Zoological Record database, extracted by M.N. Dadd and covering the period July 1991 to June 1992.

10. These ratios are based on the total for all groups given in Table 3.1-2, i.e. including algae and bryophytes but excluding fossils.

8.10.1.2 'Amateurs'

The distinction between amateur and professional is perhaps less important in relation to the study of biodiversity than in most other fields of science (Bates 1951). Indeed a significant proportion of the species known on Earth have been described by amateurs working to high scientific standards. The critical study of natural history by amateurs was commonplace in Victorian times in the UK (Allen 1976), and the tradition has continued to this day. Flowering plants and birds are especially popular, and attract the largest followings, but the amateur workforce is also significant for butterflies and moths, beetles, larger and lichenized fungi, and bryophytes. As an example, The Royal Society for the Protection of Birds (the UK partner of BirdLife International) currently has 860 000 members, a figure which exceeds the memberships of the three major political parties in the UK.

Hard information is difficult to secure, and the proportion of amateurs included in the numbers of systematists in the analysis in Table 8.10-1 is unknown. The emergence of a skilled amateur workforce is related to the amount of leisure time in society, and it is unlikely to become a major factor in any but the most developed countries. Nevertheless, the amateur is an important part of the human resource able to undertake

systematic work in developed countries, not least because such persons are often able to devote a larger proportion of their time to their studies than many 'professionals' (see 8.10.2).

Many amateurs are excellent identifiers, but most are not taxonomists in that they do not provide descriptions of new species or prepare monographic accounts. Not being linked to institutions, amateurs are invariably widely distributed geographically in a country and their collective expertise and location enables them to make particularly significant contributions to distributional studies. In the British Isles, most of the major surveys developed since grid-mapping became established in the 1950s have been possible only by the mobilization of that resource. The *Atlas of the British Flora* published in 1962 had inputs from some 1500 primarily amateur participants (Allen 1986). Atlases of bird distributions, now available for at least 12 countries, also rely heavily on amateur inputs.

8.10.1.3 Parataxonomists

An innovative approach aimed at maximizing the skills of professional taxonomists has been developed at the Instituto Nacional de Biodiversidad (INBio) in Costa Rica since 1986, and has also been utilized by WWF in its

programmes in Madagascar. This involves the use of local rural adults as 'parataxonomists' – persons trained to collect, sort and prepare material for subsequent examination by taxonomists (Janzen 1991, 1992, 1993; Janzen *et al.* 1993). This scheme has been applied particularly to insects and appears to have worked well in Costa Rica. The model merits consideration for application in both other groups and other places.

8.10.1.4 Indigenous peoples

Indigenous peoples without formal scientific training are generally dependant on their biodiversity to varying degrees and need to be able to recognize and communicate about species of value for food, medicine, clothing, construction, weaving, dyeing and other uses, as well as about those that are poisonous or harmful to humans, their crops, or their buildings. An immense amount of precision, as measured against modern species concepts, is to be found in some indigenous peoples' naming systems (Mayr 1969; see Section 2.1.0.1). Where the selection of landraces of crops suited to local conditions has occurred, individual genetic variants with specific useful characteristics may be named and may be important for the breeding of improved cultivars. The fine level of distinction achievable is illustrated by traditional weavers of the Maoris of New Zealand, who recognize over 80 genetically and geographically distinct forms of New Zealand flax (*Phormium cookianum* and *P. tenax*; Given and Harris 1994). For further examples see Table 2.1-2; Berlin (1992) and Berlin *et al.* (1974).

The capture and utilization of this specialist ethnobiological knowledge, and its relation to the scientific database, is an important aspect of biodiversity exploration. This is especially so as some tribal groups and their cultures are themselves dying out, and further because much relevant information is held now only by their more aged members as products of the modern age supersede the traditional at the village level. While significant progress has been made in relation to medicinal plants and land races of crops, only a fraction of that which exists has so far been documented. This is time-consuming work which requires personnel familiar with local languages and dialects who will be trusted by the indigenous peoples being visited. Nevertheless, it is appropriate to accord the capture of such indigenous knowledge priority (Wightman *et al.* 1992, Smith *et al.* 1993). These issues are considered further in Section 13.1.4.2.

8.10.2 The deployment of the resource

8.10.2.1 Geographic deployment

Only about 6% of the world's scientists live in those countries that house 80% of the Earth's terrestrial biodiversity (*Systematics Agenda 2000* 1994). Although an

overall geographical analysis of the world's taxonomic workforce is not available, there is no reason to assume that this statistic does not apply to those able to contribute to the understanding of biodiversity at all levels. In the case of entomology, the pattern of loans from the Natural History Museum in London indicates that 80% of insect systematists in institutions able to receive such material are based in Europe and North America (Gaston and May 1992). This statistic is probably applicable to all groups of organisms.

However, the geographic deployment pattern is changing, albeit slowly. National and regional facilities staffed by local scientists now exist in many less developed countries, but these are rarely adequately resourced so that immediate service duties rather than taxonomic research are the norm. Especially encouraging are the numbers of scientists and journals concerned with systematics in the broadest sense now located in and produced by such countries. Conversely, the number of taxonomists in at least some former colonial powers is in decline (see Section 7.4.3.2).

8.10.2.2 Subject deployment

Gaston and May (1992) drew attention to the mismatch between the numbers of taxonomists working on particular groups, and the sizes of those groups, drawing particularly on data from Australia and North America. Table 8.10-1 presented here provides evidence that this mismatch occurs on a global scale.

Using the working figures adopted in Table 3.1-2, the ratio of the number of scientists describing new species to the number of known and described species is greatest in the flowering plants (1:309) and least in the bacteria (1:12). The higher ratio for plants than animals (1:254) will reflect the major imbalances within zoology between vertebrates and other groups documented in Gaston and May (1992); for example in Australia they reported that there were 17 tetrapods for each tetrapod taxonomist, but 840 insects and spiders for each entomologist. The mismatches are, however, most striking in relation to the numbers of estimated species where the lowest ratio by far is for plants (1:366) and the greatest figures are for fungi (1:3012) and viruses (1:5333); the situation for bacteria could, however, easily be the largest if some of the more recent estimates of 3 million or more bacteria on Earth are accepted.

The conclusion that fungi and other microbial groups, and also species-rich groups such as insects and nematodes, are grossly under-resourced in terms of the biosystematic workforce compared to other groups is inescapable. Such statistics merit careful consideration when considering the development of national action programmes for biodiversity assessments, and plans for completing the overall inventory as proposed in *Systematics Agenda 2000* (1994), as well as when conducting *All-Taxa Biodiversity Inventories* (Janzen and Hallwachs 1994).

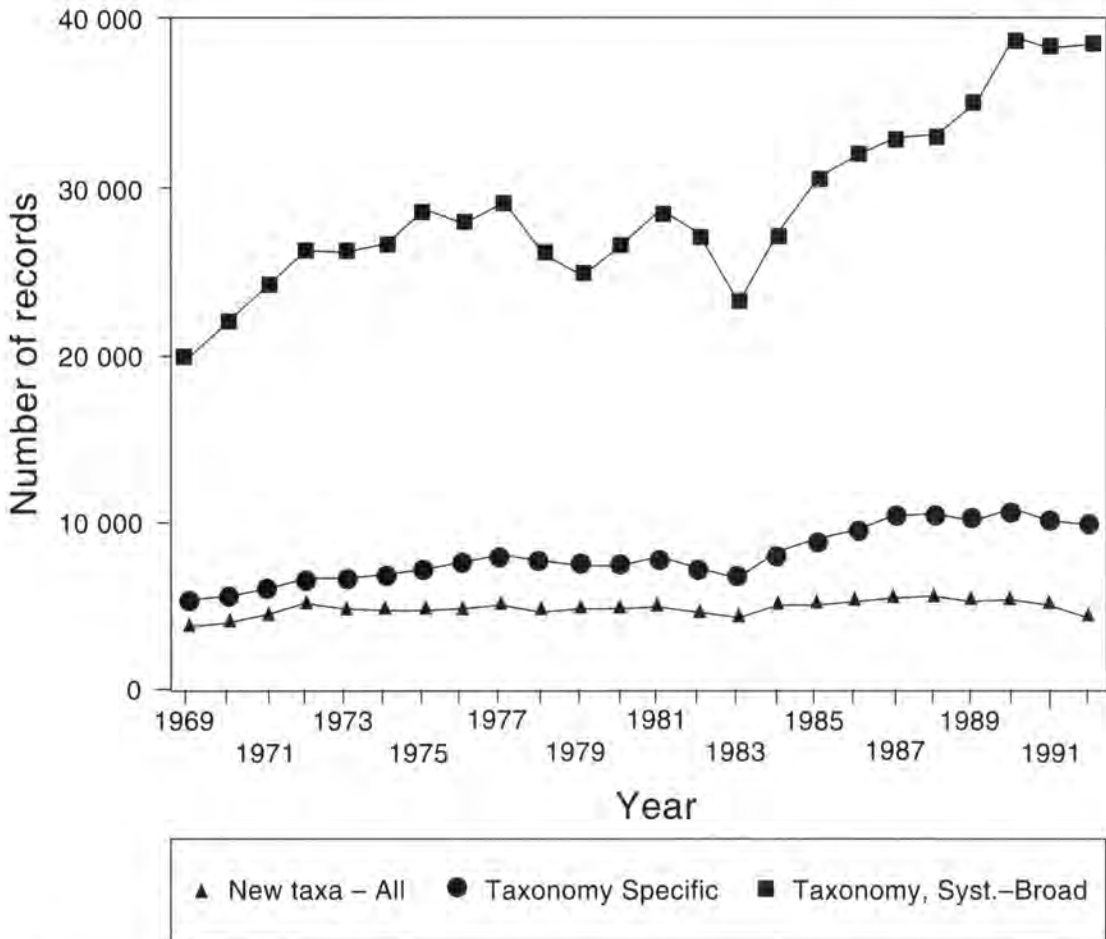

Figure 8.10-1: The coverage of taxonomy in the *Biological Abstracts* BIOSIS database 1969–92 (based on data extracted from the database by M.N. Dadd in March 1994).

8.10.3 Productivity and working practices

8.10.3.1 Productivity

Three measurable indicators of the productivity of the taxonomic workforce are the numbers of scientific papers published, the numbers of new species described, and the time taken to complete major works. A fourth indicator would be the number of species treated (i.e. described, reviewed, revised, illustrated), but a method of obtaining that information on a world-wide scale has not yet been developed.

An analysis of the papers abstracted in the *Biological Abstracts* database BIOSIS, from its inception in 1969 to 1992, shows almost a doubling in the number of systematic titles in the broadest sense. At the end of this period they stood at about 38 000 each year (Figure 8.10-1). The marked rise from 1985 may to a large extent be attributed to the rapid growth of biochemical and molecular systematics and phylogenetics (see Section 2.1). The number of core taxonomic papers, that is those including descriptions, revisions, monographs or new taxa, has also doubled over the same period, but at around 10 000 papers each year is only slightly more than a quarter of the overall systematics output. The existing workforce, especially as it

has been declining in numbers in developed countries (see Section 7.4.3.2), is to be commended on this achievement. However, with respect to the challenge of the time necessary to complete the description of life on Earth, it is of concern that, despite new technologies, the number of papers including new taxa has remained almost unchanged through the last 25 years (Figure 8.10-1).

If there are 11.9 million species still to be described on Earth, at the 1992 rate of description (Table 8.10-1) that task would take another 575 years, i.e. until the year 2570. However, that calculation assumes that the workforce could be directed to the most species-rich groups, and that palaeontologists could be turned into neontologists. Without major shifts in the spending of scientific research monies even such far off dates will not be realizable. In practice, increased prioritization will be necessary, especially for the most species-rich groups (Hawksworth and Ritchie 1993), as even if substantial funding were made available, a sufficient cadre of adequately skilled specialists could not be generated in under a decade.

The data presented in Table 8.10-1 also reveal considerable differences in overall productivity between biosystematists describing new species in different groups

of organisms. Assessed on the basis of the number of species described, mycologists and zoologists appear to be able to describe about 30% more species in a year than botanists. Bacteriologists would appear to have the lowest output, although this is an oversimplification as the mean number of authors of a new bacterial name introduced in 1992 was 5, with a maximum of 12. This is a direct reflection of the wide range of biochemical and molecular data now required formally to describe a new bacterium.

The time taken to complete major botanical works has been investigated by Polhill (1990), who compared the production rates of major regional floras. He found that the rate at which species descriptions were published ranged from 138 (*Flora Malesiana*) to 770 (*Flora Europaea*) each year. While the progress in such projects will to a large degree be directly related to the resources deployed and the editorial policy of the publication, he notes that completion dates are often still distant after many years of work; for example, the *Flora of Southern Africa* started in 1966 is projected to take to the year 2124 (19 500 species; 158 years), the *Flora of Tropical East Africa* started in 1949 and is projected to 2013 (10 500 species; 64 years), and *Flora Neotropica* started in 1968 is projected to 2397 (90 000 species; 429 years). There are parallel examples in other subject areas: the *Handbooks for the Identification of British Insects* series started publication in 1949 but to date has treated only 6000 of the 22 000 insects known in the UK.

Ng (1990) points out that in preparing their work, systematists carry an often unappreciated psychological load. Scientists in most disciplines are concerned over the approval or disapproval of their endeavours by their peers, but systematists are especially conscious of the long-term implications of their work. Acceptably published names, once introduced into the literature, cannot be revoked and will have to be handled in some manner by succeeding generations. No other scientific discipline burdens the literature of the future in such a manner.

Cullen (1984) estimated that 90% of the work published by systematists was for the consumption of other systematists. The need to identify their various target audiences and prepare and deliver works appropriate to those needs in a timely manner has been a concern of several distinguished botanists, including Corner (1946), Heywood (1983, 1988) and Walters (1988). It has been argued that systematists need to view themselves as a part of a retail process, delivering products to customers (Bisby 1984). This is something that will necessitate the adoption of different working practices.

8.10.3.2 Improving working practices

The available systematics workforce needs to increase its effectiveness if it is to meet the challenges of adequately assessing biodiversity. The situation can be improved, but

not alleviated, by taking full advantage of the latest technologies and a re-examination of current working practices is urgently needed. For example, Huhtinen (1994) has provided insights into how data capture may be maximized at the points of collection and examination in discomycete fungi, and the results disseminated more efficiently by modern technology.

The professional systematist of the 1990s spends only a small proportion of the available time on research. This figure has been estimated at 0–20% (8.10.1.1). Increased pressure on a diminishing workforce in developed countries has meant that those with systematic skills have become increasingly involved in data management, curation, preparation and dispatch of loans, identification, editing, refereeing, teaching and consultancies, or in administration or management. In order to improve productivity against such a background, attention must be given to ensuring that the time available for scientific work is used to maximum effect.

A comprehensive and readily accessible catalogue of accepted names (see 8.1.4.1) and their synonyms would be particularly time-saving. In many groups of organisms even finding out what species have been named is far from straightforward. In the case of botanical groups alone, the number of names at species rank, excluding fossils, has been estimated at 1 675 000 (Hawksworth and Greuter 1989). Taking the number of known species in these groups at 320 000 (Table 3.1-2), that suggests 5.2 names have been proposed for each species. An analysis of 15 fungal monographs gave a ratio between accepted names and those having to be evaluated of 1:6.5 (Hawksworth 1992).

The scientific names of organisms are controlled by a series of five internationally agreed Codes or Rules of Nomenclature, each relating to a different organism group (see Section 2.1). While a carefully controlled system is essential, the application of some of the current codes is far from straightforward. The emphasis on historical priority of names led Ride (1991) to argue that justice for living zoologists rather than dead ones should be the priority. A poll of active systematists in the UK in 1991 revealed that the proportion of time spent on investigating nomenclatural issues rather than the scientific study of material ranged from 1 to 75%, with a mean value of 19.5%, i.e. about one day per week for a full-time researcher (Hawksworth 1992). Attention is now being focused on how the effectiveness of the nomenclatural systems can be improved, motivated by the need to: (a) minimize the time systematists have to spend on historical and legalistic work; and (b) restrict name changes for non-scientific reasons (Hawksworth 1991b). Significant changes to this end were made in the latest edition of the International Botanical Code (Greuter *et al.* 1993), and the first steps towards a harmonized and unified system of nomenclature for all groups of organisms have been taken (Hawksworth *et al.* 1994; Hawksworth 1995b with the

support of IUMS IUBS. An International Commission on Bionomenclature to advance this initiative is being established.

While biosystematists need to reconsider their working practices so as to optimize their effectiveness, this cannot be expected to make a significant overall contribution to the problem of the 'taxonomic impediment' to biodiversity investigation (Solbrig 1991). It is an inescapable conclusion that the currently employed workforce is seriously inadequate for this task. The issue of how to increase the human resource is considered further in Sections 7.4.3 and 13.

Conclusions

A wide variety of resources is required for the objective assessment of the extent of biodiversity and the realization of its potential both to benefit humankind and to contribute to the well-being of the planet.

The number of protected areas is substantial, but fewer than 5% have been thoroughly inventoried for even one major group of the biota. In consequence, the contribution of such sites to our understanding of biodiversity and ecological processes at the community level is not being realized. Marine stations are widely distributed and linked by a number of active regional networks.

Biological reference collections are the material basis for biodiversity assessments; they include anchors for the application of scientific names, and an immense wealth of information pertinent to inventory production and distributional studies. There are some 2.5 billion specimens in such collections, but accessing this information remains a major problem. Most such collections are inadequately equipped to cope with the demands of the resurgence of interest in biodiversity, with serious consequences for curation standards.

Living collections are a key resource for *ex situ* conservation and are necessary for assessments of biodiversity within and between species. The approximately 1600 botanic gardens hold over 4.5 million accessions representing about 80 000 plant species, but this is only some 30% of those now known. The 2000 or more zoos, insectaries and aquaria world-wide collectively maintain at least 5900 species.

Genetic resource collections are a key resource for the assessment of the utility of particular organisms and for breeding, as well as for maintaining the genetic variability of species. Plant germplasm collections amount to some 4.32 million accessions, but while representing some 6000 species in total, about 3 million of those accessions relate to only about 100 species. For fungi and other microbes, such collections are the only practical source of some species; 482 collections of fungi and other microorganisms collectively hold 786 328 strains, representing almost all isolated bacteria, about 17% of the known fungi, and much smaller proportions of algae, protozoa and viruses.

The major documentation on Earth's biodiversity is inaccessible to those with the greatest need for it. Potential users need means to identify and locate what exists and what they need. Electronic systems for the capture and dissemination of the required information exist, but many vital data are not yet available in such formats. Molecular sequence data are consolidated by only seven centres, data from which are largely accessible through the Internet. The lasting value of these data would be enhanced if vouchers were preserved.

The human resource required for biodiversity assessments includes professional systematists, 'amateurs', parataxonomists and indigenous peoples. Estimates of the number of biosystematists vary, but only about 7000 are actively involved in species descriptions. There is currently a mismatch between the number of known and estimated species in different groups and that of the specialists working on them. Bacteria, fungi, nematodes, certain groups of insects, and viruses are particularly poorly served. The building up and focus of the human taxonomic workforce will be critical to the implementation of national biodiversity programmes.

Major and concerted international action is necessary to improve the organization, deployment and replenishment of the systematic resource on a scale hitherto not envisaged.

References

- Adams, R.P. and Adams, J.E. (eds) 1992. *Conservation of Plant Genes - DNA banking and in vitro biotechnology*. Academic Press, London.
- AICR 1991. Frozen mice embryos help in the fight against cancer. *Progress. The Newsletter of the Association for International Cancer Research* Winter 1991: 8.
- Akeroyd, J., McGough, N. and Wyse Jackson, P. (eds) 1994. *A CITES Manual for Botanic Gardens*. Botanic Gardens Conservation International, Richmond, UK.
- Akeroyd, J.R. and Wyse Jackson, P.S. (eds) 1995. *A Handbook for Botanic Gardens on the Reintroduction of Plants to the Wild*. Botanic Gardens Conservation International, Richmond.
- Alderson, L. (ed.) 1990. *Genetic Conservation of Domestic Livestock*. CAB International/Rare Breeds Survival Trust, Wallingford.
- Allen, D.E. 1976. *The Naturalist in Britain. A social history*. Allen Lane, Penguin Books, London.
- Allen, D.E. 1986. *The Botanists*. St Paul's Bibliographies, London.
- Allkin, B. and Winfield, P. 1993. Cataloguing biodiversity: new approaches to old problems. *Biologist* 40: 179-183.
- Andrzejewski, R. and Weigle, A. (eds) 1993. *Polskiestudium różnorodności biologicznej*. Narodowa Fundacja Ochr. Środ., Warszawa.
- Arber, A. 1953. *Herbals: Their origin and evolution*. Cambridge University Press, Cambridge.

- Arctander, P.** and Fjeldså, J. 1994. Avian tissue collections for DNA analysis. *Ibis* **136**: 359–360.
- Association of Systematics Collections.** 1993. ASC guidelines for institutional database policies. *ASC Newsletter* **21**(6): 65–71.
- Bachmann, B.J.** 1988. The *Escherichia coli* Genetic Stock Center. *U.S. Federation of Culture Collections Newsletter* **18**: 7.
- Basile, A.** 1992. The equine breeds of the Murge region of Italy. *Animal Genetic Resources Information* **9**: 95–99.
- Bates, M.** 1951. *The Nature of Natural History*. Chapman and Hall, London.
- Beattie, A.J.** 1994. Correspondance; Systematics and biodiversity. *TREE* **9**: 227.
- Beeching, J.R.,** Marmey, P., Gavalda, M.C., Moirou, M., Haysom, H.R., Hughes, M.A. and Charrier, A. 1993. The assessment of genetic diversity within a collection of cassava (*Manihot esculenta* Crantz) germplasm using molecular markers. *Annals of Botany* **72**: 515–520.
- Berlin, B.** 1992. *Ethnobiological Classification. Principles of categorization of plants and animals in traditional societies*. Princeton University Press, Princeton, NJ.
- Berlin, B.,** Breedlove, D.E. and Raven, P.H. 1974. *Principles of Tzeltal Plant Classification*. Academic Press, New York.
- BGCI** 1993. Developing the BGCI database on botanic gardens and their collections worldwide. *The Recorder. An occasional publication of Botanic Gardens Conservation International* **1**:12–14.
- Bisby, F.A.** 1984. Information services in taxonomy. In: Allkin, R. and Bisby F.A. (eds), *Databases in Systematics*. 17–33. Academic Press, London.
- Bisby, F.A.** 1993. Progress with inventories. *Nature* **363**: 11.
- Bisby, F.A.** 1994. Global master species databases and biodiversity. *Biology International* **29**: 33–40.
- Bisby, F.A.** and Hawksworth, D.L. 1991. What must be done to save systematics? In: Hawksworth, D.L. (ed.), *Improving the Stability of Names: Needs and options*. 323–336. [Regnum Vegetabile No. 123.] Koeltz Scientific Books, Königstein.
- Bonner, C.E.B.** 1962–. *Index Hepaticorum*. J. Cramer, Weinheim.
- Boyazoglu, J.** and Hetényi, L. 1994. *Game Farming in Europe. Proceedings of the Technical Consultation, Nitra, Slovakia, 14–17 September 1993. REUR Technical Series No. 31*. Food and Agriculture Organization of the United Nations, Rome, Italy.
- Bramwell, D.** and Heywood, V.H., *Ex situ Conservation Guidelines for Botanic Gardens* (in press).
- Bramwell, D.,** Hamann, O., Heywood, V. and Syngé, H. (eds) 1987. *Botanic Gardens and the World Conservation Strategy*. Academic Press, London.
- Brasier, C.M.** 1987. The dynamics of fungal speciation. In: Rayner, A.D.M., Brasier, C.M. and Moore, D. (eds), *Evolutionary Biology of the Fungi*. 231–260. Cambridge University Press, Cambridge.
- Bridson, D.** and Forman, L. (eds) 1992. *The Herbarium Handbook*, 2nd edn. Royal Botanic Gardens, Kew.
- Brisbin, I.L., Jr.** 1989. Feral animals and zoological parks: conservation concerns for a neglected component of the world's biodiversity. *American Association of Zoological Parks and Aquariums, Regional Proceedings, Southern Regional Conference, Atlanta, Ga, USA, 2–4 April 1989*: 523–530.
- Brown, A.H.D.** and Schoen, D.J. 1994. Optimal sampling strategies for core collections of plant genetic resources. In: Loeschcke, V., Tomiuk, J. and Jain, S.K. (eds), *Conservation Genetics*: 357–370. Birkhäuser-Verlag, Basel.
- Burdet, H.M.** 1985. *Ouvrages Botaniques Anciens*. Editions des Conservatoire et Jardin Botaniques de la Ville de Genève, Geneva.
- Burke, M.G.** 1988. Status, impact, and conservation implications of feral goats on Aldabra Atoll. *Biological Society of Washington Bulletin* **8**: 129–138.
- Burnett, J.H.** 1994. The International Organization for Plant Information (IOPI). *Biology International* **29**: 40–44.
- Butler, G.,** Meredith, L. and Richardson, M. 1992. *Conservation of Rare and Threatened plants in Australasia*. Australian National Parks and Wildlife Service, Canberra.
- Buttel, F.H.** 1992. The 'environmentalization' of plant genetic resources: possible benefits, possible risks. *Diversity* **8**: 36–39.
- Canhos, V.P.,** Lange, D., Kirsop, B.E., Nandi, S. and Ross, E. (eds) 1992. *Needs and Specifications for a Biodiversity Information Network*. UNEP, Nairobi.
- Canhos, V.P.,** Manfio, G.P. and Blaine, L.D. 1993. Software tools and databases for bacterial systematics and their dissemination via global networks. *Antonie van Leeuwenhoek* **64**: 205–229.
- Center for Plant Conservation** 1991. Appendix: Genetic sampling guidelines for conservation collections of endangered plants. In: Falk, D.A. and Holsinger, K.E. (eds), *Genetics and conservation of rare plants*. 225–238. Center for Plant Conservation and Oxford University Press, New York and Oxford.
- Chalmers, N.,** Hawksworth, D.L., Ingram, D.S., Long, G., Prance, G.T., Raven, P.H. and Skog, L.E. 1990. In defence of taxonomy. *Nature* **347**: 224.
- Chapuis, J.L.,** Boussès, P. and Barnaud, G. 1994. Alien mammals, impact and management in the French subantarctic islands. *Biological Conservation* **67**: 97–104.
- Chase, M.W.,** Soltis, D.E., Olmstead, R.G., Morgan, D., Les, D.H., Mishler, B.D., Duvall, M.R., Price, R.A., Hills, H.G., Qiu, Y.L., Kron, K.A., Rettig, J.H., Conti, E., Palmer, J.D., Manhart, J.R., Sytsma, K.J., Michaels, H.J., Kress, W.J., Karol, K.G., Clark, W.D., Hedren, M., Gaut, B.S., Jansen, R.K., Kim, K.J., Wimpee, C.F., Smith, J.F., Furnier, G.R., Strauss, S.H., Xiang, Q.Y., Plunkett, G.M., Soltis, P.S., Svensen, S.M., Williams, S.E., Gadek, P.A., Quinn, C.J., Eguiarte, L.E., Golenbeg, E., Learn, G.H., Graham, S.W., Barrett, S.C.H., Dayanandan, S. and Albert, V.A. 1993. Phylogenetics of seed plants: an analysis of nucleotide sequences from the plasmid gene *rbcL*. *Annals of the Missouri Botanical Garden* **80**: 528–580.
- Chauvet, M.** and Delmas, M. (eds) 1991. *Jardins Botaniques et Arboretums de Demain*. Bureau des Ressources Génétiques, Paris.
- Christensen, C.** 1906–65. *Index Filicicum*. 5 vols. Hagerup, Copenhagen.
- Clarke, C.M.H.** and Dzieciolowski, R.M. 1991. Feral pigs in the northern South Island, New Zealand; II. Breed composition of present population. *Journal of the Royal Society of New Zealand* **21**: 249–260.

- Clement, C.R.** (1991) Amazonian fruits: neglected, threatened and potentially rich resources require urgent attention. *Diversity* 7 (1.2): 56–59.
- Clifford, H.T., Rogers, R.W. and Dettmann, M.E.** 1990. Where now for taxonomy? *Nature* 346: 602.
- Coblentz, B.E.** 1990. Exotic organisms: a dilemma for conservation biology. *Conservation Biology* 4: 261–265.
- Cohen, J.L., Williams, J.T., Plucknett, D.L. and Shands, H.** 1991. Ex-situ conservation of plant genetic resources: global development and environmental concerns. *Science* 253: 866–872.
- Consultative Group on International Agricultural Research** 1992. *Partners in Conservation: Plant genetic resources and the CGIAR system*, 2nd edn. IBPGR, Rome.
- Corbet, G.B. and Harris, S.** (eds) 1991. *The Handbook of British Mammals*, 3rd edn. Mammal Society/Blackwell Scientific Publications, Oxford.
- Corner, E.J.H.** 1946. Suggestions for botanical progress. *New Phytologist* 45: 185–192.
- Cotterill, F.P.D.** 1995. Systematics, biological knowledge and environmental conservation. *Biodiversity and Conservation* 4: 183–205.
- Cotterill, F.P.D., Hustler, C.W., Sparrow, A.L. and Broadley, D.G.** 1993. Conservation of biodiversity in Africa: the role of the Natural History Museum of Zimbabwe. *The Zimbabwe Science News* 27: 32–34.
- Cotterill, F.P.D., Hustler, C.W., Sparrow, A.L. and Broadley, D.G.** 1994. Correspondance: Systematics and biodiversity. *TREE* 9: 228.
- Crawford, R.D.** 1990a. *Actual situation and problems in conservation policy and practice in North America*. Proc. 4th World Congress on Genetics applied to Livestock Production, Edinburgh 14: 455–458.
- Crawford, R.D.** 1990b. *Poultry conservation: the international situation*. Proc. American Minor Breeds Conservancy Annual Conference, 13–17 June 1990, Plimoth Plantation, Mass.
- Cullen, J.** 1984. Libraries and herbaria. In: Heywood, V.H. and Moore, D.M. (eds), *Current Concepts in Plant Taxonomy*. 25–38. Academic Press, London.
- Culotta, E.** 1992. Museums cut research in hard times. *Science* 256: 1268–1271.
- Dallmeier, F.** 1995. Biodiversity network: Report from SI/MAB's Director. *Biodiversity News* 1995(4): 3
- Dallmeier, F. and Comiskey, J.** 1995. The monitoring process: How the network works. *Biodiversity News* 1995 (4): 12–13
- Dawson, E.Y.** 1962. *New taxa of Benthic Green, Brown and Red Algae Published since De Toni*. Beaudette Foundation, Santa Yuez, USA.
- Deighton, F.C.** 1969. *A Supplement to Petrak's Lists 1920–1939. [Index of Fungi Supplement]*. CAB International, Wallingford.
- De Toni, J.B.** 1889–1924. *Sylloge Algarum*. 6 vols. Pavia.
- Downing, G.** 1988. A study of the use of biological sciences literature by staff at the British Museum (Natural History). *IATUL Quarterly* 2: 135–141.
- Drouet, F. and Daily, W.A.** 1956. Revision of the coccoid *Myxophyceae*. *Botanical Studies from Butler University* 12: 1–218.
- Duckworth, W.D., Genoways, H.H. and Rose, C.L.** 1993. *Preserving Natural Science Collections: Chronicle of our environmental heritage*. National Institute for the Conservation of Cultural Property, Washington, DC.
- Dyer, R.A. et al.** (eds) 1963–. *Flora of Southern Africa*. Government Printer, Pretoria.
- Eberhart, S.A., Ross, E.E. and Towill, L.E.** 1991. Strategies for long-term management of germplasm collections. In: Falk, D.A. and Holsinger, K.E. (eds), *Genetics and Conservation of Rare Plants*. 135–145. Center for Plant Conservation, Oxford University Press, New York.
- Edwards, S.R., Davis, G.M. and Nerling, L.I.** (eds) 1985. *The Systematics Community*. Museum of Natural History, Lawrence, Kansas.
- Environment Canada** 1991. *State of the Parks Report 1990 (Canada's Green Plan)*. 2 vols. Environment Canada Parks Service, Ottawa.
- Falk, D.A.** 1990. Integrated strategies for conserving plant genetic diversity. *Annals of the Missouri Botanical Garden* 77: 38–47.
- Falk, D.A. and Holsinger, K.E.** 1991. *Genetics and Conservation of Rare Plants*. Oxford University Press, New York.
- FAO** 1994. *STRIPE Study on Genetic Resources in the CGIAR, AGRITAC: IAR/94/2.1* The Secretariat, April 1994, Rome.
- Fisher, R.C., Peterson, J.C., Beecher, J.W., Johnson, J.S. and Boast, C.** 1990. *Agricultural Information Resources Centers. A world directory 1990*. IAALD and CTA, Illinois.
- Fitzgerald, S.M.D.** 1988. Botanical archives: notes for archive selection and classification. *Archives* 18: 145–152.
- Forey, P.L., Humphries, C.J. and Vane-Wright, R.I.** (eds) 1994. *Systematics and Conservation Evaluation*. Systematics Association Special Volume 50. Clarendon Press, Oxford.
- Fortuner, R.** (ed.) 1993. *Advances in Computer Methods for Systematic Biology: Artificial intelligence, databases, computer vision*. John Hopkins University Press.
- Fosberg, F.R. and Sachet, M.-H.** 1965. Manual for tropical herbaria. *Regnum Vegetabile* 39: 1–132.
- Frankel, O.H.** 1984. Genetic perspectives of germplasm conservation. In: Arber, W., Llimensee, K., Peacock, W.J. and Starlinger, P. (eds), *Genetic Manipulation: Impact of man on society*. Cambridge University Press, Cambridge.
- Froggatt, P. and Oates, M.** 1993. *People, Plants and Conservation: Botanic gardens into the 21st Century*. Royal New Zealand Institute of Horticulture, Wellington.
- Fungal Genetics Stock Center** 1988. *Catalog of Strains*, 2nd edn. University of Kansas Medical Center, Kansas City.
- Gadgil, M.** 1991. Conserving India's biodiversity: the societal context. *Evolutionary Trends in Plants* 5 (1): 1–6.
- Gaston, K.J. and May, R.M.** 1992. Taxonomy of taxonomists. *Nature* 356: 281–282.
- Gausen, D.** 1993. The Norwegian Gene Bank Programme for Atlantic salmon (*Salmo salar*). In: Cloud, J.G. and Thorgaard (eds), *Genetic Conservation of Salmonoid Fishes*. 181–187. Plenum Press, New York.
- Given, D.R.** 1994. *Principles and Practice of Plant Conservation*. Timber Press and Chapman and Hall, London.
- Given, D.R. and Harris, W.** 1994. *Techniques and Methods of Ethnobotany*. Commonwealth Secretariat, London.
- Global Zoo Directory** 1993. Swengel, F.B. (ed). IUCN/SSC,

- Captive Breeding Specialist Group, in collaboration with ISIS, Apple Valley, Minnesota.
- Grassle, J.F.** 1991. Deep-sea benthic biodiversity. *BioScience* **41** (7): 464–469.
- Grassle, J.F., Lasserre, P., McIntyre, A.D. and Ray, G.C.** 1991. Marine biodiversity and ecosystem function. *Biology International, Special Issue*, **23**.
- Greenoak, F.** 1994. Preserving our heritage. *The Garden* **119** (5): 212–215.
- Greuter, W., Barrie, F.R., Burdet, H.M., Chaloner, W.G., Demoulin, V., Hawksworth, D.L., Jørgensen, P.M., McNeill, J., Nicolson, D.H., Silva, P.C. and Trehane, R.P.** (eds) 1994. *International Code of Botanical Nomenclature (Tokyo Code) adopted by the Fifteenth International Botanical Congress, Yokohama, August–September 1993*. [Regnum Vegetabile No. 131.] Koeltz Scientific Books, Königstein.
- Greuter, W., Brummitt, R.K., Farr, E., Kilian, N., Kirk, P.M., and Silva, P.C.** (eds) 1993. *NCU-3. Names in Current Use For Extant Plant Genera*. [Regnum Vegetabile No. 129.] Koeltz Scientific Books, Königstein.
- Guarino, L., Rao, V.R. and Reid, R.** (eds) 1995. *Collecting plant genetic Diversity: Technical Guidelines*. CAB International, Wallingford.
- Haines, J.H. and Cooper, C.R., Jr.** 1993. DNA and mycological herbaria. In: Reynolds, D.R. and Taylor, J.W. (eds), *The Fungal Holomorph: Mitotic, meiotic, and pleomorphic speciation in fungal systematics*. 305–315. CAB International, Wallingford.
- Hall, A.V. and Rycroft, H.B.** 1979. South Africa: the conservation policy of the National Botanic Gardens and its regional Gardens. In: Syngé, H. and Townsend, H. (eds), *Survival or Extinction*. 125–134. Bentham-Moxon Trust, Kew.
- Hall, S.J.G.** 1992. Conservation of livestock breeds. In: Rege, J.E.O. and Lipner, M.E. (eds), *African Animal Genetic Resources: Their characterisation, conservation and utilisation*. 11–16. Proceedings of the Research Planning Workshop held at ILCA, 19–21 February 1992. Addis Ababa, Ethiopia. International Livestock Centre for Africa, Addis Ababa.
- Hall, S.J.G. and Ruane, J.** 1993. Livestock breeds and their conservation: a global overview. *Conservation Biology* **7**: 815–825.
- Halloy, S.** 1990. *Large scale collection of South American Germplasm for development and conservation in New Zealand*. MAF Technology Report, Invermay.
- Halloy, S.** 1994a. Long trends in the relative abundance of New Zealand agricultural plants. *Otago Conference Series* **2**: 125–141.
- Halloy, S.** 1994b. *Relevamiento rápido de recursos alternativos - Reserva de Vida Silvestre Ríos Blanco y Negro*. Fundación Amigos de la Naturaleza, Santa Cruz, Bolivia.
- Halloy, S.** 1995. Status of New Zealand biodiversity research and resources: how much do we know? *New Zealand Journal of the Royal Society* (in press).
- Hamann, O.** (ed.) 1992. *ex situ* conservation in botanical gardens. *Opera Botanica* **113**.
- Hawksworth, D.L.** 1972. *Lichens 1961–1969*. [Index of Fungi Supplement]. CAB International, Wallingford.
- Hawksworth, D.L.** (ed.) 1990. *Guidelines for the Establishment and Operation of Collections of Cultures of Microorganisms*. World Federation for Culture Collections, Campinas.
- Hawksworth, D.L.** (ed.) 1991a. *Improving the Stability of Names: Needs and options*. [Regnum Vegetabile No. 123.] Koeltz Scientific Books, Königstein.
- Hawksworth, D.L.** 1991b. The fungal dimension of biodiversity: magnitude, significance, and conservation. *Mycological Research* **95**: 641–655.
- Hawksworth, D.L.** 1992. The need for a more effective biological nomenclature for the 21st century. *Botanical Journal of the Linnean Society* **109**: 543–567.
- Hawksworth, D.L.** 1995a. Fungal genetic resource collections and biodiversity. In: Hennebert, G.L. (ed.), *Taxonomy and Tropical Mycology: Quo vadis?* Université Catholique de Louvain (in press).
- Hawksworth, D.L.** 1995b. Steps along the road to a harmonized bionomenclature. *Taxon* **44**: 447–456.
- Hawksworth, D.L. and Bisby, F.A.** 1988. Systematics: The keystone of biology. In: Hawksworth, D.L. (ed.) *Prospects in Systematics* 3–30. Oxford: Clarendon Press, Oxford.
- Hawksworth, D.L. and Greuter, W.** 1989. Report of the first meeting of a working group on Lists of Names in Current Use. *Taxon* **38**: 142–148.
- Hawksworth, D.L. and Kirk, P.M.** 1995. Name-bearing types and the Convention on Biological Diversity. *Nature* (in press).
- Hawksworth, D.L. and Kirsop, B.E.** (eds) 1988. *Living Resources for Biotechnology: Filamentous Fungi*. Cambridge University Press, Cambridge.
- Hawksworth, D.L., McNeill, J., Sneath, P.H.A., Trehane, R.P. and Tubbs, P.K.** 1994. Towards a harmonized bionomenclature for life on Earth. *Biology International, Special Issue* **30**: 1–44.
- Hawksworth, D.L. and Ritchie, J.M.** 1993. *Biodiversity and Biosystematic Priorities: Microorganisms and invertebrates*. CAB International, Wallingford.
- He, Shan-An, Heywood, V.H. and Ashton, P.S.** 1990. *Proceedings of the International Symposium on Botanical Gardens, 1988*. Jiangsu Science and Technology Publishing House, Nanjing.
- Henson, E.L.** 1992. *in situ* conservation of livestock and poultry. *FAO Animal Production and Health Paper* **99**. Food and Agriculture Organization of the United Nations, Rome.
- Hernández-Bermejo, J.E., Clemente, M. and Heywood, V.H.** (eds) 1990. *Conservation Techniques in Botanic Gardens*. Koeltz Scientific Books, Königstein.
- Heywood, V.H.** 1983. The mythology of taxonomy. *Transactions of the Botanical Society of Edinburgh* **44**: 79–94.
- Heywood, V.H.** 1987. The changing role of the botanic garden. In: Bramwell, D., Heywood, V.H. and Syngé, H. (eds), *Botanic Gardens and the World Conservation Strategy*. 13–18. Academic Press, London.
- Heywood, V.H.** 1988. Tropical taxonomy – who are the users? *Symbolae Botanicae Upsalienses* **28** (3): 21–28.
- Heywood, V.H.** 1990. Botanic gardens and the conservation of plant resources. *Impact of Science on Society* **158**: 121–132.
- Heywood, V.H.** 1991a. Botanic gardens and the conservation of medicinal plants. In: Aberle, O., Heywood, V. and Syngé, H. (eds), *Conservation of Medicinal Plants*. 213–228. Cambridge University Press, Cambridge.

- Heywood, V.H.** 1991b. Developing a strategy for germplasm conservation in botanic gardens. In: Heywood, V.H. and Wyse-Jackson, P. (eds), *Tropical Botanic Gardens: Their role in conservation and development*. 11–23. Academic Press, London.
- Heywood, V.H.** 1992. Conservation of germplasm of wild plant species. In: Sandland, O.T., Hindar, K. and Brown, A.H.D. (eds), *Conservation of Biodiversity for Sustainable Development*. 189–203. Scandinavian University Press, Oslo.
- Heywood, V.H.** 1993a. The role of botanic gardens and arboreta in the *ex-situ* conservation of wild plants. *Opera Botanica* **121**: 309–312.
- Heywood, V.H.** 1993b. Broadening the basis of plant resource conservation. In: Gustafson, J.P., Appels, R.P. and Raven, P. (eds), *Gene Conservation and Exploitation*. 20th Stadler Genetics Symposium. 1–13. Plenum Press, New York.
- Heywood, C.A., Heywood, V.H. and Wyse Jackson, P.S.** 1990. *International Directory of Botanical Gardens*, 5th edn. Koeltz Scientific Books on behalf of WWF, Botanic Gardens Conservation Secretariat and the International Association of Botanical Gardens.
- Heywood, V.H. and Wyse Jackson, P.S.** (eds) 1991. *Tropical Botanic Gardens: Their role in conservation and development*. Academic Press, London.
- Hintum, T.J.L. van** 1994. *Drowning in the Gene Pool: Managing genetic diversity in genebank collections*. Swedish University of Agricultural Sciences, Department of Plant Breeding Research, Svalöv.
- Hodges, J.** (ed.) 1992. The management of global animal genetic resources. Proceedings of an FAO Expert Consultation, Rome, Italy, April 1992. *FAO Animal Production and Health Paper* **104**. Food and Agriculture Organization of the United Nations, Rome.
- Hodgkin, T., Brown, A.H.D., van Hintum, Th.J.L. and Morales, E.A.V.** 1995. *Core Collections of Plant Genetic Resources*. John Wiley, Chichester, UK, with International Plant Genetic Resources Institute (IPGRI), Rome and Sayce Publishing, Bovey Tracey, Devon, UK.
- Holden, J., Peacock, J. and Williams, T.** 1993. *Genes, Crops and the Environment*. Cambridge University Press, Cambridge.
- Holloway, J.** 1983. The role of taxonomy, reference works and insect collections in tropical ecology. *Antenna* **7**: 50–53.
- Holmgren, P.K., Holmgren, N.H. and Barnett, L.C.** (eds) 1990. *Index Herbariorum, Part I. The herbaria of the world*. Regnum Vegetabile No. 120. New York Botanical Garden for IAPT, Bronx, New York.
- Hone, J.** 1990. How many feral pigs in Australia? *Australian Wildlife Research* **17**: 571–572.
- House of Lords Select Committee on Science and Technology** 1992. *Systematic Biology Research*. Her Majesty's Stationery Office, London.
- Howie, F.M.P.** 1986. Conserving Natural History Collections: some present problems and strategies for the future. In: Waddington, J. and Rudkin, D.M. (eds), *Care and Maintenance of Natural History Collections*. 1–6. Life Sciences Miscellaneous Publications, Royal Ontario Museum, Toronto.
- Huhtinen, S.** 1994. Traditional discomycete taxonomy: should we also shift to a second gear? In: Hawksworth, D.L. (ed.), *Ascomycete Systematics: Problems and prospects in the nineties*. 295–302. [NATO ASI Series, A, No. 269.] Plenum Press, New York.
- Hurka, H.** 1994. Conservation genetics and the role of botanical gardens. In: Loeschcke, V., Tomiuk, J. and Jain, S.K. (eds), *Conservation Genetics*, 371–380. Birkhäuser-Verlag, Basel.
- Huxley, P.A. and Westley, S.B.** 1989 (eds). *Multipurpose Trees: Selection and testing for agroforestry*. ICRAF, Nairobi.
- IBPGR** 1991. *Elsevier's Dictionary of Plant Genetic Resources*. Elsevier, Amsterdam.
- Index of Fungi** 1940– [Twice yearly]. CAB International, Wallingford.
- Index Kewensis** 1895–. 2 vols, 18 Supplements. Clarendon Press, Oxford.
- Intergovernmental Oceanographic Commission.** 1993. *Assessment and Monitoring of Large Marine Ecosystems*. OIC/INF-942, UNESCO.
- International Plant Genetic Resources Institute (IPGRI)** (various dates) *Directories of Germplasm Collections Series*. IPGRI, Rome.
- IPGRI** 1993. *Diversity for Development. The strategy of the International Plant Genetic Resources Institute*. International Plant Genetic Resources Institute, Rome.
- IUCN** 1992. *Protected Areas of the World: A review of national systems*. 4 vols. Prepared by the World Conservation Monitoring Centre. IUCN, Gland, Switzerland and Cambridge, UK.
- IUCN** 1994a. *1993 United Nations List of National Parks and Protected Areas*. Compiled by the World Monitoring Centre and the IUCN Commission on National Parks and Protected Areas. IUCN, Gland, Switzerland and Cambridge, UK.
- IUCN** 1994b. *Guidelines for Protected Area Management Categories*. CNPPA with the Assistance of WCMC. IUCN, Gland, Switzerland and Cambridge, UK.
- IUCN-The World Conservation Union**, 1988. *A Directory of Neotropical Wetlands*. IUCN, Cambridge.
- IUCN-The World Conservation Union**, 1989. *Directory of Asian Wetlands*. IUCN, Gland, Switzerland.
- IUCN-The World Conservation Union**, 1990. *IUCN Red List of Threatened Animals*. IUCN, Cambridge [additional red lists available].
- IUCN-The World Conservation Union**, 1991. *Directory of African Wetlands*. IUCN, Gland, Switzerland and WCMC, Cambridge.
- IUCN-The World Conservation Union**, 1992. *Protected Areas of the World: A Review of Actual Systems*, vols 1–4. IUCN, Gland.
- IUDZG/CBSG (IUCN/SSC)** 1993. *The World Zoo Conservation Strategy. The role of zoos and aquaria of the world in global conservation*. Chicago Zoological Society, Brookfield, Ill.
- Janzen, D.H.** 1991. How to save tropical biodiversity. *American Entomologist* **37**: 159–171.
- Janzen, D.H.** 1992. A south–north perspective on science in the management, use, and economic development of biodiversity. In: O.T. Sandlund, K. Hindar, and A.H.D. Brown, (eds), *Conservation of Biodiversity for Sustainable Development*, 27–52. Scandinavian University Press, Oslo.
- Janzen, D.H.** 1993. Taxonomy: universal and essential infrastructure for development and management of tropical wildland biodiversity. In: Sandland, O.T. and Schei, P.J. (eds),

- Proceedings of the Norway/UNEP Expert Conference on Biodiversity, Trondheim, Norway.* 100–113. NINA, Trondheim.
- Janzen, D.H.** and Hallwachs, W. 1994. All Taxa Biodiversity Inventory (ATBI) of Terrestrial Systems. A genetic protocol for preparing wildland biodiversity for non-damaging use. Report of a NSF Workshop, 16–18 April 1993, Philadelphia, Pa. 1–132.
- Janzen, D.H.,** Hallwachs, W., Jimenez, J. and Gamez, R. 1993. The role of the parataxonomists, inventory managers, and taxonomists in Costa Rica's national biodiversity inventory. In: Reid, W.V., Laird, S.A., Meyer, C.A., Gamez, R., Sittenfeld, A., Janzen, D.H., Gollin, M.A. and Juma, C. (eds), *Biodiversity Prospecting: Using genetic resources for sustainable development.* 223–254. World Resources Institute, Washington, DC.
- Jarrett, F.M.** (ed.) 1985. *Index Filicium Supplementum quintum pro annis 1961–75.* Clarendon Press, Oxford.
- Katyega, P.M.J.** 1987. Mpwapwa cattle of Tanzania. *Animal Genetic Resources Information* 6: 23–26.
- Kew Index** 1986– [annual], Clarendon Press, Oxford.
- Kirk, P.M.** 1985. *Saccardo's Omissions.* [Index of Fungi Supplement]. CAB International, Wallingford.
- Kirsop, B.** and Hawksworth, D.L. 1994. *The Biodiversity of Microorganisms and the Role of Microbial Resource Centres.* World Federation for Culture Collections, Braunschweig.
- Lamb, I.M.** 1963. *Index nominum lichenum inter annos 1932 et 1960 divulgatorum.* Ronald Press, New York.
- Lapage, S.P.,** Sneath, P.H.A., Lessel, E.F., Skerman, V.B.D., Seeliger, H.P.R. and Clark, W.A. (eds) 1992. *International Code of Nomenclature of Bacteria, 1990 Revision.* American Society for Microbiology, Washington, DC.
- Larsen, K.,** Morley, B. and Schoser, G. 1989. *Proceedings of the Tenth General Meeting and Conference, International Association of Botanic Gardens,* 2–7 August 1987. Pippert and Koch, Frankfurt.
- Lasserre, P.** 1992. The role of biodiversity in marine ecosystems. In: Solbrig, O.T., van Emden, H.M., van Oordt, P.G.W.J. (eds), *Biodiversity and Global Change.* 105–130. IUBS Press, Paris.
- Lasserre, P.,** McIntyre, A.D., Ogden, J.C., Ray, G.C. and Grassle, J.F. 1994. Marine laboratory networks for the study of the biodiversity, function and management of marine ecosystems. A contribution to 'Diversitas' Programme. *Biology International, Special Issue* 31: 1–33.
- Leadley, E.,** Wyse Jackson, D., and Wyse Jackson, P. 1993. Developing the BGCI database of botanic gardens and their collections worldwide. *Botanic Gardens Conservation News* 2 (2): 61–64.
- Linnean Society of London and the Systematics Association** 1950. *Lectures on the Development of Taxonomy.* Linnean Society of London, London.
- Loftus, R.** and Scherf, B. (eds) 1993. *World Watch List for Domestic Animal Diversity,* 1st edn. Food and Agriculture Organization of the United Nations, Rome.
- Lund, H.G.,** Rudis, V.A. and Stolte, K.W. (in press). Plots, pixels and partnerships – prospects for mapping, monitoring and modeling biodiversity. Abstracts and Proceedings of the International Symposium Smithsonian/Man and Biosphere Biodiversity Program: *Measuring and Monitoring Forest Biological Diversity: The International Network of Biodiversity Plots,* 23–25 May 1995, Washington, DC.
- Macfarlane, J.S.** 1993. *Livestock Research in Pakistan. A review of current research being undertaken in Pakistan on breeding indigenous cattle, sheep and goat breeds.* Unpublished report, Centre for Tropical Veterinary Medicine, University of Edinburgh.
- McGinley, R.J.** 1993. Where's the management in collections management? Planning for improved care, greater use, and growth of collections. *International Symposium and First World Congress on the Preservation and Conservation of Natural History Collections, Madrid, 10–15 May 1992.* 3: 309–338.
- McNeely, J.A.** (ed.) 1993. *Parks for Life: Report of the IVth World Congress on national parks and protected areas.* IUCN, Gland.
- McNeely, J.A.** 1994. Protected areas for the 21st century: working to provide benefits to society. *Biodiversity and Conservation* 3: 390–405.
- McNeely, J.A.,** Harrison, J. and Dingwall, P. (eds) 1994. *Protecting Nature: Regional reviews of protected areas.* IUCN, Gland.
- Mason, I.L.** 1984. *Evolution of Domestic Animals.* Longman, London.
- May, R.M.** 1988. How many species are there on Earth? *Science* 241: 1441–1449.
- Mayr, E.** 1969. The biological meaning of species. *Biological Journal of the Linnean Society* 1: 311–320.
- Melgar, R.A.,** Solano, R. and de Alba, J. 1985. The Barroso cattle of Guatemala. *Animal Genetic Resources Information* 4: 13–15.
- Miller, S.E.** 1993. Biological collections databases available on Internet. *Pacific Science Association Bulletin* 45: 14–15.
- Miller, S.E.** 1994. Development of world identification services: networking. In: Hawksworth, D.L. (ed.), *The Identification and Characterization of Pest Organisms.* 69–80. CAB International, Wallingford.
- Minelli, A.** 1993. *Biological Systematics. The state of the art.* Chapman and Hall, London.
- Minelli, A.** 1994. Correspondance: Systematics and biodiversity. *TREE* 9: 227.
- Ministère de l'Agriculture et de la Pêche** 1992. *Races domestiques en péril. Affaire de collectionneurs ou affaire collective?* Journée du 24 septembre 1992, Festival Animalier International de Rambouillet. MAF, Paris, France.
- Moulder, D.S.** and Momzikoff, N. 1991. *Directory of European Aquatic Sciences Libraries and Information Centres.* Institute Oceanographique, Paris.
- Mukai, F.,** Tsuji, S., Fukazawa, K., Ohtagaki, S. and Nambu, Y. 1989. History and population structure of a closed strain of Japanese Black cattle. *Journal of Animal Breeding and Genetics* 106: 254–264.
- Muñoz, C.E.** and Tejón, D.T. 1986. *Catálogo de razas autóctonas españolas. I.- Especies ovina y caprina,* 2nd edn. Ministerio de Agricultura, Pesca y Alimentación, Dirección General de la Producción Agraria, Madrid.
- National Research Council** 1993. *Managing Global Genetic Resources: Agricultural crop issues and policies.* Committee on Managing Global Genetic Resources: Agricultural Imperatives. National Academy Press, Washington, DC.

- NCCPG:** National Council for the Conservation of Plants and Gardens. 1994. *The National Plant Collections Directory 1994*. NCCPG, Wisley, UK.
- Neave, S.A.** (ed.) 1939–93. *Nomenclator Zoologicus*. 8 vols. Zoological Society of London, London.
- Nielsen, E.S.** and West, J.G. 1994. Biodiversity research and biological collections: transfer of information. In: Forey, P.L. et al. (eds), *Systematics and Conservation Evaluation*. 101–121. Clarendon Press, Oxford.
- Ng, F.S.P.** 1990. Regional floras: the target groups, usage and feedback. *Flora Malesiana Bulletin, Special Volume 1*: 9–10.
- NSB** 1989. *Loss of Biological Diversity: A global crisis requiring international solutions*. National Science Board, Washington, DC.
- Nucleic Acids Research** 1993. *Database Issue 21*: 2963–3156.
- O'Uigin, C.** and Cunningham, E.P. 1990. Conservation of the Kerry breed. *Farm and Food Research* January–March 1990: 25–27.
- Payne, W.W.** et al. 1979. *Systematic botany resources in America. Part II: The costs of services*. Cary Arboretum of the New York Botanical Garden, Millbrook, New York.
- Perring, F.H.** and Walters, S.M. (eds) 1962. *The Atlas of the British Flora*. Thomas Nelson and Sons Ltd., Edinburgh.
- Persing, D.H.**, Telford III, S.R., Rys, P.N., Dodge, D.E., White, T.J., Malawista, S.E. and Spielman, A. 1990. Detection of *Borrelia burgdorferi* DNA in museum specimens of *Ixodes dammini* ticks. *Science* **249**: 1420–1423.
- Petrak, F.** 1930–44. Verzeichnis der neuen Arten, Varietäten, Formen, Namen und wichtigsten Synonyme. *Just's botanischer Jahrbücher* **48** (3), **49** (2), **56** (2), **57** (2), **58** (1), **60** (1), **63** (2).
- Petrak, F.** 1950. In: *Index of Fungi*. 1–117, Commonwealth Mycological Institute, Kew.
- Petrov, E.M.** 1980. *Bashkirskaya hortevaya pchela* [The Bashkir tree-hole bee]. Bashkirskoe Knizhnoe Izdatel'stvo, Ufa, Russia.
- Pine, R.H.** 1994. Correspondance: Systematics and biodiversity. *TREE 9*: 229.
- Plucknett, D.L.**, Smith, N.J.H., Williams, J.T. and Anishetty, M.N. 1987. *Gene Banks and the World's Food*. Princeton University Press, Princeton, NJ.
- Poland, U.** (ed.) 1988. *World Directory of Biological and Medical Sciences Libraries*. KG Saur, München.
- Polhill, R.M.** 1990. Production rates of major regional floras. *Flora Malesiana Bulletin, Special Volume 1*: 11–20.
- Ray, G.C.** and Gregg, W.P., Jr. 1991. Establishing biosphere reserves for coastal barrier ecosystems. *BioScience* **41**: 301–309.
- Ray, G.C.** and McCormick-Ray, M.G. 1994. *Marine Protected Areas*. WCMC.MPA, unpublished report.
- Rege, J.E.O.** and Lipner, M.E. (eds) 1992. *African Animal Genetic Resources: Their characterisation, conservation and utilisation*. Proceedings of the Research Planning Workshop held at ILCA, Addis Ababa, Ethiopia, 19–21 February 1992. International Livestock Centre for Africa, Addis Ababa.
- Reid, W.V.** and Miller, K.R. 1989. *Keeping Our Options Alive: the scientific basis for conserving biodiversity*. World Resources Institute, Washington, DC.
- Rejmánek, M.**, Ward, P.S., Webster, G.L. and Randall, J.M. 1994. Correspondance: Systematics and biodiversity. *TREE 9*: 228–229.
- Renner, S.S.** and Ricklefs, R.E. 1994a. Systematics and biodiversity. *TREE 9*: 78.
- Renner, S.S.** and Ricklefs, R.E. 1994b. Correspondance: Systematics and biodiversity. A reply. *TREE 9*: 229–230.
- Richardson, M.**, Falk, D., Wyse Jackson, P., Butler, G. and Meredith, L. 1991. *Proposal for an 'Australian Network for Plant Conservation'*. Australian National Parks and Wildlife Service, Canberra.
- Ride, W.D.L.** 1991. Justice for the living: a review of bacteriological and zoological initiatives in nomenclature. In: Hawksworth, D.L. (ed.), *Improving the Stability of Names: Needs and options*. 105–122. [Regnum Vegetabile No. 123.] Koeltz Scientific Books, Königstein.
- Robertson-Vernhes, J.** 1993. Biosphere reserves: the theory and the practice. *Nature and Resources* **29**: 2.
- Rodriguez, A.** and Martinez, R. 1992. Bovino criollo argentino 'Patagónico'. *Animal Genetic Resources Information* **9**: 27–31.
- Ruttner, F.** 1976. Isolated populations of honeybees in Australia. *Journal of Apicultural Research* **15**: 97–104.
- Saccardo, P.A.** 1882–1931, 1972. *Sylloge fungorum*. 26 vols. Saccardo, Padua.
- Seville** Strategy for Biosphere Reserves 1995. *The Vision from Seville for the 21st Century*. UNESCO Man and Biosphere Programme, Paris (unpublished report).
- Shetler, S.G.** 1973. Demythologizing biological data banking. *Taxon* **23**: 71–100.
- Sherborn, C.D.** 1902–33. *Index Animalium*. 11 vols. British Museum (Natural History), London.
- Simon, D.L.** and Buchenauer, D. 1993. *Genetic diversity of European livestock breeds. Results of monitoring by the EAAP Working Group on Animal Genetic Resources*. European Association of Animal Production Animal Genetic Data Bank, Institute of Animal Breeding and Genetics, School of Veterinary Medicine, Hannover, Germany [EAAP Publication no. 66]. Wageningen Pers, Wageningen, Netherlands.
- Sims, R.W.**, Freeman, P., Hawksworth, D.L. (eds) 1988. *Key works to the Fauna and Flora of the British Isles and north-western Europe. Systematics Association Special Volume 33*. Clarendon Press, Oxford.
- Skerman, V.D.B.**, McGowan, V. and Sneath, P.H.A. 1989. *Approved Lists of Bacterial Names*, amended edition. American Society for Microbiology, Washington, DC.
- Smith, D.** and Hawksworth, D.L. (in press). Microbial Genetic Resources: Their Use and Organization. *Biology International*, Special Issue.
- Smith, N.**, Wididburu, B., Harrington, R.N. and Wightman, G. 1993. Aboriginal plant use from the Victoria river area of Northern Australia. *Northern Territory Botanical Bulletin* **16**: 1–64.
- Smith, N.J.**, Williams, J.T., Plucknett, D.L. and Talbot, J.P. 1992. *Tropical Forests and their Crops*. Cornell University Press, New York.
- Solbrig, O.T.** (ed.) 1991. *From Genes to Ecosystems: A research agenda for biodiversity*. Report of a IUBS-UNESCO Workshop, Harvard University, IUBS Monograph Series.
- Southward, A.J.** 1980. The Western English Channel – an inconsistent ecosystem. *Nature* **285**: 361–366.
- Stessey, T.F.** 1993. The role of creative monography in the biodiversity crisis. *Taxon* **42**: 313–321.

- Sugawara, H., Ma, J., Miyazaki, S., Shimura, J. and Takishima, Y.** (eds) 1993. *World Directory of Collections and Cultures of Microorganisms: Bacteria, fungi and yeasts*, 4th edn. WFCC World Data Centre on Microorganisms, Japan.
- Suhirman, Butler, G., Fuaddini, Pfeiffer, J., Richardson, M. and Suhendar** 1994. *Strategies for Flora Conservation in Asia*. Kebun Raya Bogor.
- Systematics Agenda 2000** 1994. *Systematics Agenda 2000: Charting the Biosphere. A global initiative to discover, describe, and classify the world's biodiversity*. SA200: A consortium of the American Society of Plant Taxonomists, the Society of Systematic Biologists, and the Willi Hennig Society, in cooperation with the Association of Systematics Collections.
- Thomas, R.H.** 1994a. Analysis of DNA from natural history museum collections. In: Schierwater, B., Streit, B., Wagner, G.P. and DeSalle, R. (eds), *Molecular Ecology and Evolution Approaches and Applications*. 311–321. Birkhäuser-Verlag, Basel.
- Thomas, R.H.** 1994b. Molecules, museums and vouchers. *TREE* 9: 413–414.
- Tilling, S.** 1984. Keys to biological identification: their role and construction. *Journal of Biological Education* 18: 293–304.
- Tilling, S.M.** 1987. Education and taxonomy: the role of the Field Studies Council and AIDGAP. *Biological Journal of the Linnean Society* 32: 87–96.
- Tourtellot, J.B.** (ed.) 1987. *Into the Unknown. The Story of Exploration*. National Geographic Society, Washington, DC.
- Turrill, W.B. et al.** (eds) 1952–. *Flora of Tropical East Africa*. Crown Agents for Overseas Governments and Administrations.
- Vanlangingham, S.L.** 1967. *Catalogue of the fossil and recent genera and species of diatoms and their synonyms*. J. Cramer, Lehre and Vaduz.
- Vietmeyer, N.D.** 1990. Forward: The new crops era. In: Janick, T. and Simon, J.E. (eds), *Advantages in New Crops*. xviii–xxii. Proceedings of the First National Symposium New Crops: Research, Development, Economics, Indianapolis, Indiana, 23–26 October 1988. Timber Press, Portland, Oregon.
- Virus Identification Data Exchange (VIDE)**. CAB International, Wallingford.
- Walters, M.** 1988. The purposes of systematic botany. *Symbolae botanicae upsalienses* 28: 13–20.
- Watson, G.W., Heywood, V.H. and Crowley, W.** 1993. North American Botanic Gardens. In: Janick, J. (ed), *Horticultural Reviews* 15: 1–52.
- WCMC** 1992. *Global Biodiversity: Status of the Earth's Living Resources*. World Conservation Monitoring Centre, Cambridge.
- WCMC** 1994. *1993 United Nations List of National Parks and Protected Areas*. IUCN, Gland.
- WCMC and IUCN** 1990. *1990 United Nations List of National Parks and Protected Areas*. IUCN, Gland.
- Weiner, G.** (ed.) 1990. *Animal Genetic Resources. A global programme for sustainable development*. Proceedings of an FAO Expert Consultation, Rome, Italy, September 1989. FAO Animal Production and Health Paper 80, Food and Agriculture Organization of the United Nations, Rome.
- Wightman, G., Roberts, J.G. and Williams, L.** 1992. Aboriginal plant use from the Eusey area, northern Australia. *Northern Territory Botanical Bulletin* 15: 1–59.
- van der Wijk, R., Margadant, W.D. and Florschütz, P.A.** 1959–69. *Index Muscorum*. Utrecht, Netherlands.
- Willison, J. and Greene, J.** (eds) 1994. *Botanic Gardens Environmental Education: Guidelines for the development of individual strategies*. Botanic Gardens Conservation International, Richmond.
- Willison, J. and Wyse Jackson, P.** (eds) 1992. *A Natural environment for Learning: Proceedings of the 1st Congress on Education in Botanic Gardens*. Botanic Gardens Conservation International, Richmond.
- World Conservation Monitoring Centre** 1990. *A Directory of Wetlands of International Importance*. IUCN, Cambridge.
- World Conservation Monitoring Centre** 1993. *Ecologically Important Areas of Africa*. World Bank, Washington, DC.
- World Conservation Monitoring Centre and Royal Botanic Gardens, Kew, UK** 1990. *World Plant Conservation Bibliography*. Royal Botanic Gardens, Kew and WCMC, Cambridge.
- World Resources Institute and International Institute for Environment and Development** 1993. *Directory of Country Environmental Studies*. WRI, Washington, DC.
- WWF and IUCN-BGCS** 1989. *The Botanic Gardens Conservation Strategy*. IUCN-BGCS, Richmond, UK and Gland, Switzerland.
- Wyse Jackson, P.S. and Akeroyd, J.R.** 1994. *Guidelines to be followed in the design of plant conservation or recovery plans*. Convention on the Conservation of European Wildlife and Natural Habitats, Nature and Environment, No. 68. Council of Europe Press, Strasbourg.
- Zahlbruckner, A.** 1921–40. *Catalogus lichenum universalis*. 10 vols. Borntraeger, Leipzig.
- Zoological Record** 1865–. [Issued in 20 Sections by Phylum or Class]. BIOSIS International, York.

Acknowledgements

The Lead Author and Contributors would like to thank the following for their critical comments on drafts of the manuscript, and for assistance in compiling the data and information contained in this Assessment:

Drs D.H. Janzen, University of Pennsylvania, PA; F.P.D. Cotterill, Natural History Museum of Zimbabwe; G.C. Ray, University of Virginia, VA;

The staff from CAB International's Scientific and Library Services, in particular Drs P.M. Kirk and G. Saddler; Mrs E. Wheeler, IMI, Egham, Surrey, Mr H. Fox and Mr K.J. Hudson, Ascot, Berkshire;

The Librarian from the Royal Society for the Protection of Birds, Sandy, Bedfordshire, Mr I. Dobson;

Scientists from the Royal Botanic Gardens, Kew, Surrey: Drs R. Brummitt and A. Cox.

9

Data and Information Management and Communication

S.T. OLIVIERI, J. HARRISON AND J.R. BUSBY

Lead Authors:

*J.R. Busby, D.L. Canhos, V. Canhos, R. Cavalcanti, A.D. Chapman, B. Dansby,
J. Harrison, M. Hernandez, M. Jensen, S.M. Lanou, W. Los, S. Olivieri, B. Stein,
L. Tangle, P. Uhlir*

Contributors:

*I. Crain, M. Cordiner, F. Dallmeier, A. Gómez-Pompa, E. Forno, C. Lankester,
G. Lloyd, J.C. Rakotoary, J. Reynolds, J. Rhind*

CONTENTS

Executive Summary	611	9.2.6.2 Potential areas for the development of guidelines	624
9.0 Introduction	613	9.3 Tools and technologies	624
9.1 Biodiversity information: its nature and its users	613	9.3.0 Introduction	624
9.1.0 Introduction	613	9.3.1 Data management tools	624
9.1.1 The nature of information	613	9.3.1.1 Database management	624
9.1.2 Biodiversity information use	614	9.3.1.2 Geographic information systems	626
9.1.2.1 Public policy motivations	614	9.3.1.3 Management and integration of text	626
9.1.2.2 Private sector motivations	614	9.3.1.4 Tools to computerize existing data	627
9.1.2.3 Public interest and cultural motivations	614	9.3.1.5 Harmonization tools	628
9.1.3 Information flow	615	9.3.1.6 Environmental thesauri	629
9.1.4 Criteria for success in information management	615	9.3.1.7 Other evolving tools	629
9.1.4.1 Internal criteria	615	9.3.2 Reporting, analysis and modelling tools	630
9.1.4.2 External criteria	616	9.3.2.1 Modelling physical and ecological processes	630
9.2 Data collection and management	617	9.3.2.2 Risk and hazards	630
9.2.0 Introduction	617	9.3.2.3 Modelling and policy-making	630
9.2.1 Types of data	617	9.3.3 Networks	631
9.2.1.1 Natural environment	617	9.3.3.1 Connecting to networks	631
9.2.1.2 Society	618	9.3.3.2 Internet	632
9.2.1.3 Relation between natural environment and society	618	9.3.4 Other information dissemination tools	632
9.2.1.4 Auxiliary information	619	9.3.4.1 Diskette and CD-ROM	632
9.2.2 Identifying data requirements	619	9.3.5 Selection of software and hardware tools	633
9.2.3 Data formats	620	9.3.5.1 Selection of computer software	634
9.2.3.1 Numeric data	620	9.3.5.2 Selection of computer hardware	635
9.2.3.2 Categorical data	620	9.3.5.3 The selection process	635
9.2.3.3 Text	620	9.3.5.4 Selection of database management systems	635
9.2.3.4 Spatial data	620	9.3.5.5 Selection of geographic information systems	636
9.2.3.5 Remote sensing data	620	9.3.5.6 Existing biodiversity application software	636
9.2.3.6 Images	621	9.4 Making information more widely available	639
9.2.3.7 Sounds	621	9.4.0 Introduction	639
9.2.4 Data collection and management strategies	621	9.4.1 Exchange standards	639
9.2.4.1 Data collection strategies	621	9.4.1.1 Directory exchange standards	639
9.2.4.2 Data management strategies	621	9.4.1.2 Data exchange standards	639
9.2.4.3 Documentation	622	9.4.1.3 User interface standards	639
9.2.4.4 Metadata	622	9.4.2 Presentation of information	639
9.2.5 Custodianship	622	9.4.2.1 Current issues in information presentation	640
9.2.5.1 Criteria for assigning custodianship	622	9.4.2.2 Future needs	641
9.2.5.2 Responsibilities of custodianship	623	9.4.3 Information dissemination	641
9.2.5.3 Custodianship in networks	623	9.4.3.1 Printed media	641
9.2.5.4 Difficult issues in custodianship	623	9.4.3.2 Electronic media	642
9.2.6 Standards and guidelines	623		
9.2.6.1 Potential areas for the development of standards	624		

9.4.3.3 Networks	642	9.5.6.3 Special interest networks	654
9.4.3.4 Microfilm and microfiche	642	9.5.7 CD-ROM and diskette	654
9.4.3.5 Distribution channels	643	9.5.8 Directories of data sources	659
9.4.4 Issues in electronic publishing	643	9.5.8.1 Species names/described species	661
9.5 Sources of biodiversity information	643	9.6 Legal aspects of information management	661
9.5.0 Introduction		9.6.0 Introduction	661
9.5.1 Libraries, bibliographies and bibliographic databases	644	9.6.1 Sources of international law	661
9.5.1.1 Libraries	644	9.6.1.1 Public law	661
9.5.1.2 Bibliography	645	9.6.1.2 Private law	663
9.5.1.3 Bibliographic databases	645	9.6.2 Major legal issues	663
9.5.1.4 Periodicals	646	9.6.2.1 Intellectual property rights	663
9.5.2 National Biodiversity Information Centres	646	9.6.2.2 Freedom of information and public databases	664
9.5.3 National biodiversity assessments	646	9.6.2.3 Privacy	664
9.5.3.1 Country environmental profiles	647	9.6.2.4 Liability	664
9.5.3.2 Biodiversity assessments	647	9.6.2.5 Authentication and admissibility of data	665
9.5.3.3 UNEP country studies programme	648		
9.5.4 Global and regional assessments	649	9.7 Institutional capacity development	665
9.5.4.1 Global environment reports	649	9.7.0 Introduction	665
9.5.4.2 Thematic reviews	649	9.7.1 Information needs and information resources available	665
9.5.4.3 Regional assessments	649	9.7.2 Institutional capacity	666
9.5.5 Global, regional and thematic information centres	650	9.7.3 Technology selection: a double-edged sword	666
9.5.6 On-line sources of information	652	9.7.4 Human resources and training	667
9.5.6.1 Metadatabases	653	9.7.5 Financing	667
9.5.6.2 Virtual libraries	654	References	667

EXECUTIVE SUMMARY

Section 9 provides decision-makers with guidelines for creating or enhancing the national capability to manage and disseminate biodiversity information. Increasingly, such national capacity is required for the best management of biodiversity, now recognized as a natural resource of potential economic value as well as one critical to maintaining the air, water, soil and other conditions essential to human life.

The first chapter (9.1) gives an overview of the nature of biodiversity information and the many ways in which such information is used. Beginning by drawing a distinction between information and data – information consists of data that have been organized, integrated and to some extent analysed – the chapter summarizes three categories of motivation for using biodiversity information. These categories are: public policy motivations (including compliance with laws, regulations or treaties), private sector motivations (including advancement of commercial interests such as biotechnology and natural resource development), and public interest and cultural motivations (including conservation and the advancement of basic science). To develop an effective biodiversity information management system, one must first understand the needs of all these potential users.

The authors emphasize that development of an information management system should not be contingent upon having any particular kind of technology. While high-tech, computer approaches have recently revolutionized this field, an effective system can be built using paper – including maps, card files, ledger books, field notes and bibliographies. The most critical step is to develop a good intellectual framework for the system, which can be modernized with high-tech approaches later if appropriate.

Moving on to specifics, the second chapter presents guidelines for deciding what kinds of information to collect. While the range of information types needed for biodiversity conservation is huge, limited resources mean that priorities must be set carefully from the start. To help decision-makers with that task, the chapter reviews all relevant data types and the many formats those data come in, then provides a list of criteria for identifying a user's own data requirements. Project managers should also find out what kinds of data have already been collected by others to avoid wasteful duplication.

Once it is known what kinds of data are needed, a system to manage them should be established before data collection begins. Chapter 9.2 provides guidelines for establishing such a system, focusing particularly on the documentation of procedures, resolving issues surrounding custodianship (who will be responsible for maintaining the data), and following (or setting) standards and guidelines so that the information will be useful to as wide an audience as possible.

Chapter 9.3 gives a comprehensive overview of the relevant tools and technologies in the field today. It includes a discussion of current trends in the availability of tools and the selection of appropriate tools, and reviews some of the tools developed in the field of biodiversity. The following categories are discussed in detail: data management tools, data analysis and modelling tools, and data dissemination tools.

Focusing specifically on dissemination, Chapter 4 emphasizes that, because every nation has its own unique biodiversity information needs, there can be no single recipe for success in data access and dissemination. Yet because of the vast (and growing) amount of information available – and the vast array of information types needed to solve any given biodiversity problem – a carefully thought out access and dissemination strategy is essential. To ensure successful transfer of information from one party to another, the use of data-exchange standards is important, and current standards for exchanging various data types are listed. Next, technologies that facilitate the presentation of biodiversity data are summarized. Finally, current methods of information dissemination are described – including paper, disks, CD-ROM and electronic media – comparing the uses, costs, advantages and disadvantages of these media.

Chapter 9.5 presents an overview of available information sources, describing different approaches to managing today's diversity of information, particularly special-interest computer networks and computer-based, or 'virtual', libraries. The chapter reviews the important efforts being made in the production of national, regional and global biodiversity assessments as well as the institutions that have focused on biodiversity information management. Finally, it reviews on-line sources of information on biodiversity as well as CD-ROM and diskette-based information products.

Stepping back from these details, Chapter 9.6 provides an overview of legal issues relating to biodiversity information management. Noting that international law has imposed obligations as well as restrictions on both public and private organizations regarding such information, this chapter begins by describing the various sources of current international law. These include international conventions that relate to biodiversity and international customary law.

The major legal issues that can arise in the field of information management include intellectual property rights, freedom of information, privacy, and liability. Chapter 9.6 examines the sources of law relating to each of these broad issues and gives examples of how they relate to biodiversity information.

Focusing on the development of institutional capacity, the final chapter (9.7) summarizes some of the most important issues to consider when establishing a national information management system. First, one should clearly identify the system's intended users and their specific needs. Another critical early step is to find out what kinds of information are actually available (or relatively easy to locate), identifying data-sharing options whenever possible.

An honest evaluation of current institutional capacity – including financial security, stability and ability to

collaborate with other institutions – is also important, as is an analysis of available human resources. The latter is often a problem in developing countries, which may lack trained professionals in the biological and information management fields, both of which are necessary for setting up a successful system. While often critical, training programmes must be carefully designed to develop the kinds of professionals that are most needed and to provide them with incentives to stay with the information management programme once they have been trained.

Finally, careful thought must be given to technology selection. As emphasized at the beginning of Section 9, sound information management principles are technology-independent. While computers have revolutionized the field in recent years, all the basic functions they perform can also be done manually. Before selecting a technology, decision-makers must consider the following: the problems they want the system to solve, the current and future costs of technology, ease of maintenance, flexibility, growth potential, and the human resources that will be required to run the system. If planners lock themselves into a particular technology before asking these questions, they are likely to end up with a system that matches neither their needs nor their capability to run it.

9.0 Introduction

Virtually every section of this Global Biodiversity Assessment makes a strong case for the collection of biological and other relevant information *before* decisions affecting biodiversity are made. Increasingly, the appropriate use of biodiversity information is also required by national and international law. The goal of Section 9 is to provide decision-makers with guidance for enhancing their nations' capacities to manage and disseminate biodiversity information. While enhanced greatly by the use of computers and other technologies, these activities can be carried out successfully with devices as simple as filing cabinets, card catalogues and paper maps.

Although information management and dissemination has long been viewed as an essential government activity, traditionally most effort has focused on social and economic issues. Natural resources routinely inventoried and monitored tend to be only those with direct economic significance, such as minerals, timber, land and soil, agricultural production and water resources. The development and use of other biodiversity information generally has not been a priority of governments and, with a few notable exceptions, most of the efforts in this area have been undertaken by the scientific research community or, to a lesser degree, by the non-governmental sector. Broadening the use of biodiversity information from these to other sectors of society is a principal challenge addressed in this Section.

Also encouraging an increase in the use of biodiversity information are the mandates of international agreements such as the Convention on Biological Diversity (CBD), the Convention on International Trade in Endangered Species (CITES), Chapter 15 of *Agenda 21*, the World Heritage Convention, and the Global Biodiversity Strategy, each of which calls for the effective organization, management and use of biodiversity information. The CBD in particular specifies a wide range of activities requiring the use of biodiversity and other scientific data. These activities include (but are not restricted to):

- biological survey and inventory
- monitoring and assessment
- education and training
- public awareness and participation
- restoration and rehabilitation
- ex situ conservation measures
- environmental impact assessment
- policy development
- assessment of economic benefits
- estimating conservation costs
- socioeconomic surveys and studies

The convention also anticipates extensive information collection and management through the so-called Country Study process. Already under way, or even completed in some countries, the studies' goal is to gather and analyse the biological, economic and social data needed to prepare the national strategies and plans the CBD requires. Beyond producing these products, the studies are intended to be the first step in an ongoing and evolving process. In essence, the convention and other recent international agreements are requiring the world's nations to develop environmental information infrastructures similar to those they have developed for military and economic planning.

Based on principles developed under the CBD, biological and genetic resources are also increasingly viewed as natural resources with potential economic value. In addition, such resources play a key role in providing so-called ecosystem services – maintaining the air, water, soil, climate and other environmental conditions essential to human survival (see Section 6). For all of these reasons, countries today have strong incentives to inventory and monitor the status of their biodiversity resources and to use this information for the intelligent conservation, management and use of those resources.

9.1 Biodiversity information: its nature and its users

9.1.0 Introduction

Previous sections of the GBA have described various tools available for collecting biodiversity and other environmental data. This section will take up where those left off – describing the tools that are available to *manage* data that have already been collected, *apply* these data, and *communicate* them to decision-makers and others who will use them to better conserve and manage biodiversity. The section also describes the types of *information sources* that will complement these activities, and identifies a range of examples.

Readers of this section will tend to be either those who generate information on biological diversity and/or have responsibility for managing it or those who are users of biodiversity information or could potentially benefit from the use of such information. Obviously, these two groups are not mutually exclusive, and there is considerable overlap between them. However, differentiating between information generators and users helps to frame much of the following overview, which briefly describes the nature of information (9.1.1), motivations for biodiversity information use and the diverse user constituencies (9.1.2), and criteria for success in biodiversity information management (9.1.3).

9.1.1 The nature of information

Clarifying the relationship between data and information – terms that are too often used interchangeably – is important

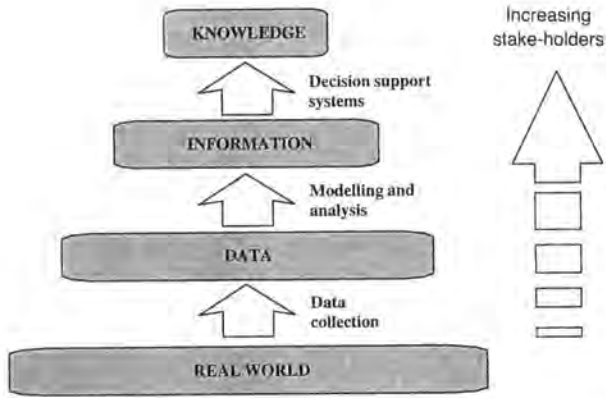

Figure 9.1-1: The nature of information.

for understanding the nature of information and its management, communication and use. A continuum describing this relationship links in a hierarchical fashion data, information and knowledge (Figure 9.1-1).

Data generally refers to the observations or measurements describing a particular entity or process. *Information*, however, usually refers to data that have been organized, integrated and to some extent analysed. *Knowledge* can be derived from information through further analysis, interpretation, and understanding. The ideal end product of this continuum is *wisdom* – in this case in biodiversity management – which is achieved through the intelligent use of knowledge. As one moves up the continuum from the real-world process of data collection toward wisdom, the primary stakeholders involved in each activity change – from those with a primarily local focus to decision-makers and others who are interested in the broad application of knowledge.

9.1.2 Biodiversity information use

In any effort to develop or improve biodiversity information management strategies, it is essential to consider who are the projected users of the information, what are their needs, and what is their level of technological sophistication. Only with a thorough understanding of these factors can system capacities and requirements be evaluated successfully.

Use of biodiversity information generally depends upon specific motivations. The different types of motivations therefore provide a perspective from which to view potential user audiences. Three principle categories of motivations – public policy motivations, private sector motivations, and public interest and cultural motivations – are described below.

9.1.2.1 Public policy motivations

These motivations for using biodiversity information primarily involve compliance with laws, rules, regulations or treaties. They derive from all levels of human activities,

from village-established rules, through state- or national-level laws and policies to international treaties.

As emphasized in the introduction to this Section, legal incentives are some of the most powerful drivers of biodiversity information management today. It is no coincidence that those countries that have strong environmental legislation – be they industrialized or developing countries – also have the most heavily used biodiversity information management efforts. The rigour with which these policies or regulations are enforced, however, has a large influence on the degree to which they provide motivation for biodiversity information use. Lax or non-existent enforcement leads to low compliance, and therefore little incentive to apply this information. The enforcement mechanism behind many public policies is economic in nature. At the level of individuals or companies, this generally translates into fines or delay costs, whereas for governments this may translate into trade barriers or reduction in foreign assistance financing.

9.1.2.2 Private sector motivations

These motivations relate to the need for biodiversity information to advance commercial interests. Companies involved in plant breeding, ecotourism, biotechnology or natural resource management may have a vested economic interest in receiving and applying such information. A corollary, however, is that biodiversity information developed by private interests may be treated in a more proprietary way than information developed for other reasons. The need for information to avoid costly penalties or regulatory delays spans both public policy and private sector motivations. In addition, the private sector is increasingly seeking biodiversity information to avoid potential environmental problems or to develop contingency plans.

9.1.2.3 Public interest and cultural motivations

Public interest motivations for the use of biodiversity information are growing rapidly. They include efforts by both government and non-governmental institutions, as well as individuals, to apply biodiversity information in ways that advance the conservation and sustainable development of natural resources. Much of the work in biodiversity information management to date has been undertaken with public interest incentives as a primary motivator. This often takes the form of encouraging proactive efforts for environmental protection, such as the establishment and management of protected areas. Access to environmental information has also proved to be a powerful force for empowering local people to take an interest in and feel responsible for their biodiversity resources.

Cultural motivations – including scholarly pursuits and the incentives traditional societies have to document knowledge

about local plant and animal species – are responsible for the vast amount of biodiversity information that has been acquired over the past few hundred years. Most of the widely known basic information about species and ecosystems has come from scientists and interested amateurs driven by intellectual curiosity. In addition to being the major source for exploration and information generation, these academic and scholarly endeavours also constitute a major incentive for the use of existing information. Indeed, the advancement of scientific inquiry builds upon a foundation of existing knowledge, providing the basis for the strongest historical use of biological diversity information.

9.1.3 Information flow

Often, those most in need of biodiversity information either fail to get the information at all, or find themselves overwhelmed with information that they cannot assimilate (WRI *et al.* 1992). This is a failure of the effective flow of information caused by one of the following factors:

- Poor access to existing information, including:
 - cost of access
 - unpublished material
 - restricted access (for whatever reasons – political or personal)
 - inadequate information on what is available
 - multiple sources
 - lack of integration
- Information does not meet user requirements, including:
 - wrong format
 - inadequate documentation
 - poor (or undocumented) quality
 - not scientifically credible

Figure 9.1-2 presents a representation of information flow taken from WRI *et al.* 1992.

This section therefore not only deals with the actions required to improve the management of biodiversity information, but also those actions required to improve the flow of that information.

9.1.4 Criteria for success in information management

9.1.4.1 Internal criteria

Internal criteria for success are primarily those factors related to the effective and efficient functioning of the institutions responsible for information management. Key to achieving this goal is: (1) having a clearly stated *mission* and *objectives* against which activities and progress can be measured; (2) having appropriately *qualified staff* able to

implement the objectives; and (3) having enough *stability* in governance and finance to allow proper long-term development.

For many information-orientated institutions, there is a dynamic tension between the need to produce short-term products and the desire to accumulate information over the long term. For financial reasons, and to provide needed services, many information management efforts follow a very project-driven pathway. This ‘consultant model’ often involves intense work and detailed information development about a specific topic over a short time span. Contrasting with this is the more strategic goal of long-term accumulation of information that will be capable of informing a broad range of users rather than just a project sponsor. This often involves long-term data development and analysis that identifies and addresses broad societal needs.

While following only the first model will tend to produce information that is quickly lost or forgotten, following only the second may lead to the perception of irrelevancy in the short term. Thus another internal criterion for success is the balance struck between these two approaches, which are not in fact mutually exclusive. Short-term project work can and should feed into a long-term strategy for accumulating knowledge, and long-term information collection and management efforts must provide short- and mid-term benefits in order to justify their existence.

One way to strike this critical balance is to develop a phased approach. Early phases can focus on meeting important short-term goals, while simultaneously keeping an eye on future goals. Such an approach also allows a new institution to start out using a lower level of information management technology – making use of the staff, budget and tools immediately available – switching to more advanced approaches when the organization is ready. Key to the success of this approach is designing projects so that changes in tools are possible, i.e. not becoming so wedded to one technology that changing to another is impossible in the future.

Although high-technology approaches to information management have revolutionized the field in recent years, an unwanted side effect may be that those who do not have these tools are discouraged from entering the field. Well-organized data on paper – in the form of maps, card files, ledger books, bibliographies and field notes – are an essential part of information management. Preparing the intellectual framework in which the original data will be collected and organized is far more important than employing the most modern tools. By concentrating initially on this phase, thereby minimizing the technological barrier, more institutions will be encouraged to develop biodiversity data management capabilities in the first place. Well-organized data can be easily transferred to electronic systems at a later date.

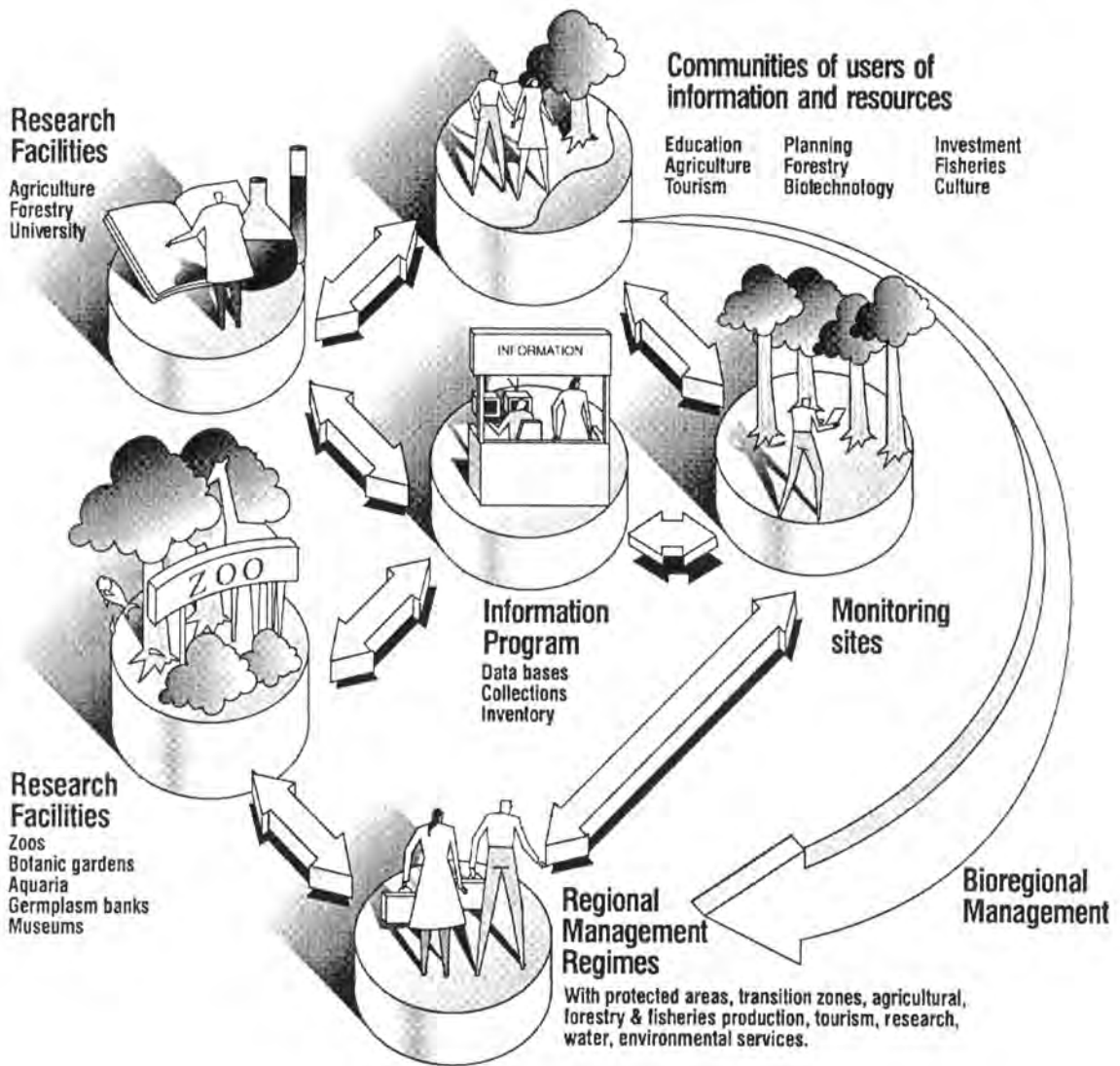

Figure 9.1-2: The information flow (from WRI/IUCN/UNEP 1992).

New institutions should also not be discouraged by gaps in the information available to them. If developing according to the phased approach described above, these institutions can use estimates to fill these gaps during their early stages of development in order to meet short-term goals. As they become available, actual data can replace estimates in later stages.

9.1.4.2 External criteria

Perhaps the most important criterion for evaluating the success of biodiversity information management activities is the degree to which the resulting information is useful to, and used by, their target audiences. Ideally, this usefulness should translate into influencing and improving key government as well as societal actions. Such actions range from preparing state-of-the-environment reports and improving the environmental sensitivity of development planning to enhancing the ability to restore damaged ecosystems and increasing the effectiveness of conservation action in general.

Measuring the impact of information on such actions, however, is subjective at best. More quantitative measures include the number of biodiversity information users, the sectoral breadth of users, and the number of requests for information. Regarding the latter, it is important to distinguish between requests that come from the biodiversity information management community itself and requests from users, particularly decision-makers, in other sectors.

Critical to meeting this criterion for success is ensuring that the availability of information is known to those who need it and that they find the information both relevant and readily accessible. The definition of ready accessibility will differ from country to country and among user groups, depending upon the level of technological sophistication. Optimal accessibility in one context may be responding to telephone, mail or personal inquiries, whereas in others nothing less than on-line computer access with full multi-media capabilities will be considered truly accessible. In either case, feedback

mechanisms are needed so that information managers can keep track of changes in user needs as well as the relevance of the information provided.

9.2 Data collection and management

9.2.0 Introduction

For reasons discussed earlier, it is necessary to draw together a wide range of information on which conservation priorities and actions can be based (9.2.1). Data gathering can be an endless process, however, unless clear boundaries are specified and linked to unambiguous objectives.

A common error in conservation planning is to allow researchers and data managers to set the parameters for data acquisition independent of the interests of information users. Thus an information management strategy should always be made a part of any conservation planning process (see 9.2.4). As part of this strategy, the information needs of users must be determined through a continuing dialogue that identifies and sets priorities for types of data required as well as the processing and models needed to make it useful (see 9.2.2). Information users should in fact participate in *all* phases of the development and maintenance of an information strategy.

With limited resources available, setting data collection priorities is critical. Priorities will vary according to specific needs and requirements, but decisions on the depth and breadth of data gathering, particularly if additional research is envisaged, must be subject to a thorough assessment of the costs and benefits involved. Particularly pertinent is the need to identify those data sets with multiple applications and those that are irreplaceable (perhaps because of environmental change).

It is also essential to consider what work has already been done. Many people have collected data for many purposes for many years. Before developing any new data collection and management operation, it is essential to review what information already exists, who is collecting it and how, and who is managing it and how. There is no sense in expending time and resources on repeating existing information collection and management operations.

In the past there has been a tendency to assume that it is best to collect and manage all information in one central location to ensure its adequate integration and application. However, this may not always be true and may in fact result in information not being used by those who need it most. What is important is not centralized information collection and management, but ensuring that the information is available, compatible and comparable. This is facilitated by the application of appropriate standards to the process (9.2.6); custodianship by the appropriately qualified centres of excellence (9.2.5); good

communication between information collectors, managers and users; and careful co-ordination of any information collection and management effort (9.7).

9.2.1 Types of data

Effective biodiversity management is ultimately concerned with influencing the interface between human and biological systems at local, national and international levels. International trade in natural resources is potentially as significant a factor in biodiversity conservation as are national forest policies or local community action. Similarly, the market value of a particular resource may be as important a factor in its conservation as the resources applied to its conservation.

Thus the range of data types needed for biodiversity conservation and management varies considerably (see Figure 9.2-1). The following paragraphs identify some of the most important information types necessary. Although brief, these paragraphs begin to demonstrate the extent of interrelationships among information types needed to study and manage biodiversity effectively. It is essential that such interrelationships are kept clearly in mind when planning both data collection and data management strategies.

Another important consideration is the dynamic nature of most biodiversity and economic data. The status and distribution of species and habitats are constantly changing, as are the costs of their conservation and the economic benefits of their use. When developing data collection and management systems, it is critical to design databases that allow for regular, systematic updating as well as gathering a diversity of new data.

It is also essential to be aware not only of the 'scientific' and 'economic' data of modern societies, but also of traditional knowledge. The recording of this knowledge may require particularly careful thought because of the nature of the information and the sensitivities involved in its collection.

9.2.1.1 Natural environment

Biological information and the many forms that information takes is a primary focus of the entire Global Biodiversity Assessment. Earlier sections discuss information requirements for species, ecosystem and genetic resources, covering issues ranging from status and distribution of resources to functional relationships (including ecosystem processes) and the development of tools to support the science.

Information on physical factors such as climate, topography, hydrology and substrate allows one to place biological data within a physical context and facilitates the development of predictive models (as the distribution of many species and vegetation types can be predicted by a combination of physical characteristics). Physical factors also have a significant impact on ecosystem processes (the

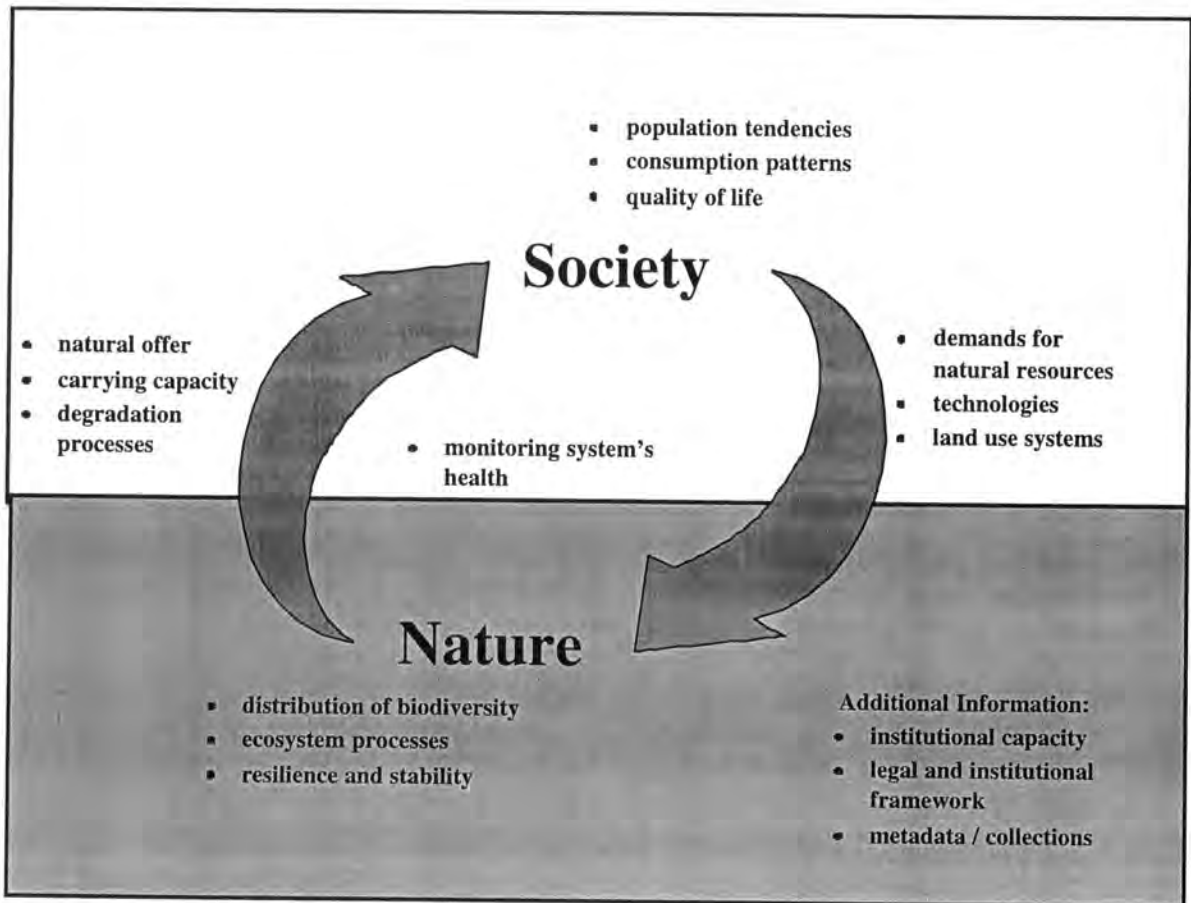

Figure 9.2-1: Different types of data related to biodiversity.

interaction between the biological and physical), potential use of biological resources, and management strategies for those resources. Such information is essential in order to assess and manage biodiversity effectively.

9.2.1.2 Society

Use and abuse of biological resources is essentially a function of social and economic factors. Important data within this category include human population structure and trends, the distribution of that population, and the ways in which distribution changes over time (both short term and long term). More difficult to measure but also relevant to resource use are factors such as quality of life (including literacy, relative income and life expectancy) and aesthetic values.

9.2.1.3 Relation between natural environment and society

The management of biodiversity is a function of this interaction, and it is vital to get an accurate picture of how human activities affect the natural environment. Most obviously this includes data on land use and pressure on natural resources, including forestry and fisheries practices, farming methods, location of transportation routes, and the use local people make of natural resources. Such information must include not only a review of the status and distribution of the various

types of activity, but also of the technologies involved. Do forestry practices, for example, involve cutting selected trees with saws or clear-felling large areas with heavy machinery?

Assessing the value of local economies is also essential. To ensure effective and efficient biodiversity management, one must know the true value of biodiversity as well as the costs and benefits of different management options – including the costs of managing protected area systems, the level of income derived from tourism associated with natural resources, and the value of indirect benefits such as watershed protection. Some of these values require assessment of biodiversity's true value, methodologies for which are only now being developed (see Section 12).

Identifying and monitoring pressures on environmental resources and threats to biodiversity is essential (see Section 7). To do this effectively, data collection programmes must go beyond the obvious, direct threats to biodiversity and also identify and record the underlying causes of those threats – such as overpopulation, poverty, and government policies, linking these data as necessary with other types of data.

Biodiversity conservation requires effective resource management. To assess the effectiveness of that

management, information is needed not only on the status and distribution of biodiversity, but also on current and past resource management activities. This would include information on protected area management, coastal zone management and species management strategies.

9.2.1.4 Auxiliary information

Good biodiversity management not only requires easy accessibility to sources of all kinds of information listed above but also appropriate contacts for procuring that information. This may include bibliographic information on who has published what and where, basic information on names and addresses of qualified experts, sources of information on reliable and appropriate models, metadatabases (see 9.4), information on projects that have been conducted, and so on.

9.2.2 Identifying data requirements

Data collection and management should be done in a systematic and planned manner, identifying *first* the problems that must be solved before deciding what data are needed to solve them. Although collecting and managing data are only part of any project life-cycle, they often, by accident or design, become the primary focus of the project. While understandable, given the ease with which data can be recorded and analysed by computers, this 'data first' approach can increase the risk of misusing resources, as well as developing research activities that do not address priorities.

The range of relevant information is so huge that project managers must distinguish from the start between information that is necessary, information that is desirable, and information that one can do without. These decisions depend on:

- a clear definition of the problems to be solved and the needs of those who will solve them;
- an assessment of data requirements (including type of information, level of detail and periodicity of update);
- an assessment of available resources (including financial and human resources and necessary equipment);
- the extent to which information is already available in a useful form; and
- ongoing information management activities that can be used or adapted.

If data collection and management are planned within the confines of a specific project, the activities involved will be bounded by the project's required outputs and products. For instance, a project aiming to evaluate the land cover characteristics of a region may employ the expensive

option of detailed sample surveys over the relatively cheaper, yet coarser, option of classifying satellite imagery. This would be an appropriate decision if the project required a product that was detailed and repeatable.

If, on the other hand, the objective is to develop a national biodiversity database, the task is somewhat more difficult, because resources will never satisfy the wide range of needs. With limited resources available, setting priorities for the types of data to collect is critical. These priorities will vary according to planning needs and requirements, and identification of who will use the information and how. Although decisions on the depth and breadth of the data gathering will be subject to an assessment of costs and benefits, general priorities for types of data to be collected include the following (adapted from UNEP 1993):

- data that can be used for more than one purpose;
- data that provide a baseline for monitoring conservation action;
- data that are important for decision-making;
- data on the social and economic values of biodiversity and protected areas;
- data supporting policy and conservation programmes;
- data on genetic resources, including medicinal plants and wild ancestors of domesticated species;
- data on species that could serve as indicators of ecosystem health;
- data on 'keystone' and 'flagship' species and habitats;
- data on alien or exotic species, potential threats to indigenous biodiversity;
- data on biodiversity known to be threatened;
- data on biodiversity protected within conservation areas;
- data on threats to biodiversity;
- data on potential rates of biodiversity loss;
- data on species and habitat distribution;
- data on biodiversity function and ecosystem services provided;
- data on landscape infrastructure and pattern;
- data on species and sites of special significance outside protected areas; and
- data on the status/distribution of protected areas and their biodiversity.

It should be noted that as well as being required in their own right, data may also have a value in supporting other data, or in acting as a surrogate for data that either cannot be collected, or would be too costly to collect.

9.2.3 Data formats

Not only must project planners decide what data should be collected, but they also must decide how those data should be managed. While much of this is discussed in Chapter 9.3, a critical early aspect of data management is the format of the data collected. The following paragraphs give an introduction to this topic, although they are neither all-inclusive nor mutually exclusive.

9.2.3.1 Numeric data

There are two main types of numeric data: primary data and derived data. Primary numeric data are obtained directly from many types of survey ranging from counts of species in particular locations to measurements of rainfall, tree growth or the length of a bird's primary feathers (which might be used in identification and taxonomic work). A count results in a whole number, while a measurement is made on a continuous scale. Primary numeric data can also be generated automatically from recording machines. Note that in all cases it is important to differentiate between zero and no value – zero may be the actual value.

Derived numeric data are obtained from the manipulation and analysis of other numeric data sets. The altitudinal range of a protected area, for example, can be derived from subtracting the lower altitude from the upper. Another form of derived numeric data is ranking. For example: Everyman's National Park in Batavia is the third largest in the country (based on a ranking of sites by size) and the second most important for conservation of endemic species (based on analysis of species records).

Numeric data are used extensively in modelling and in the derivation of categoric data (see below). For instance, information on temperature, rainfall and altitude at a particular site (all numeric data) can be used to predict which Holdridge 'life zone' (see Section 2.3.3.3) it lies within. And because numeric data are by definition structured, it is possible to structure their management quite carefully, including checking data entry to ensure that figures input are theoretically possible.

9.2.3.2 Categoric data

Categoric data are classified or coded non-numeric data, which could include records of variables such as soil type, land cover, forest type, species and protected area designation. These data are structured, usually through a thesaurus or data dictionary, and can be checked for allowed values. As mentioned above, categoric data can be derived from numeric data. For example, classification of

remotely sensed data often results from the derivation of categories from numeric data. Qualified with numeric data, categoric data are often used in association with maps.

For very sound reasons, primary data should take precedence over classified categoric data wherever practicable. This will ensure that if the categories become obsolete, or one wishes to use another classification system, new categories can be readily identified from the primary data. If the primary data are not available, then expensive data re-collection exercises will become necessary.

9.2.3.3 Text

Text consists principally of descriptions – including descriptions of protected areas, species and threats. By its nature, text is much less structured than other kinds of data and can become subjective unless careful controls are placed on its compilation through, for example, definition of paragraph headings, specification of paragraph contents, and vocabulary control. Text, when attached to a database or map, can provide valuable extra description. It can be used, for example, to check more thoroughly the identity of a species once a database has been used to identify it. With recent developments in text manipulation using computers, such as the use of 'hypertext' links (9.3.2.3), the value of text description has increased considerably.

9.2.3.4 Spatial data

Maps have always been a valuable tool for the storage and presentation of information, because they provide a ready identification of the nature of the landscape and the relationship between various features within it. Basically, any feature that can be 'geo-referenced' (its location identified with respect to other geographic features) can be placed on a map. Such features range from known locations of particular species to the extent of remaining threatened habitats, mean daily temperature at various meteorological stations, and the location of major population centres. Maps are a good tool with which to synthesize and present complex information in a format easily understood by a broad spectrum of people, and the development of computer tools for handling spatial data (9.3.2.2) has increased the potential for map generation, manipulation, and analysis.

9.2.3.5 Remote sensing data

There are several forms of remote sensing, based on the kind of sensor used (radar, visible and infrared, thermal) and on the kind of platforms from which the sensor operates (satellite, aircraft). Remotely sensed data generally require careful interpretation and validation, without which the data may be misunderstood or even misused. Their advantages include their potential to cover very large geographic areas, and their repeatability, providing an opportunity to monitor change. Their disadvantages include

the difficulty of interpreting these data, their cost, and the fact that they can result in very large amounts of information, meaning that storage and analysis can also be costly. It is therefore essential that the implications of using remotely sensed data are carefully assessed before launching such a project.

9.2.3.6 Images

A variety of useful data come in the form of images. Photographs and drawings of individual species and parts of their bodies, for example, are an essential aid to identification. Photographs of a particular landscape feature taken periodically over time are a valuable resource for assessing change. Combining images and sound, video adds a dynamic factor that allows, for example, the recording of movement patterns and animals in particular habitats. Video may be particularly pertinent to the recording of traditional knowledge.

9.2.3.7 Sounds

Sound may not be an obvious data type, but it has significant value in identifying certain species. In fact, experts can use sound to confirm the presence of some species, particularly birds, without actually seeing them, which can be particularly valuable in dense vegetation.

9.2.4 Data collection and management strategies

Having identified the information required, the next step is to review what data already exist and what data collection and management programmes are already under way. Without this review, time and resources may be wasted and other institutions or individuals antagonized. Methods should always be developed to make the most efficient use of existing data, whatever their quality. However, in order for data to be reliable, they must also be validated or accompanied by information that indicates the level of reliability.

Following this review, the actual data sets required can be defined. Data sets are groups of related data and attributes about those data and their collection. Such data sets are usually sectoral in nature and are linked to other data sets through common fields. For example, geographical location can be used to link data sets on protected areas with data sets on species distributions.

Because most project resources are finite, good science and good decision-making require the application of appropriate data collection and management strategies. Given the aesthetic appeal of GIS, image processing systems and other 'high-tech' approaches (9.3.2.2), project managers may be tempted to believe that low-quality data have been enriched simply through its presentation, advocating 'garbage in, gospel out'. There is also a tendency to go for high-tech solutions when low-tech solutions are perfectly adequate. Good strategic planning can avoid both problems.

9.2.4.1 Data collection strategies

Having identified the types of data required and the relevant data collection and management programmes already available, project managers must devise strategies for both compiling and transforming existing data and collecting new data. Such strategies will involve many organizations, and those developing them must recognize – in advance – all potential constraints, including the adequacy of existing data and availability of resources. In particular, the following issues need to be carefully considered:

- negotiations with holders of existing data and managers of existing programmes;
- availability and costs of appropriately skilled labour;
- capacity to provide supporting materials;
- time constraints;
- logistics of handling field results;
- adherence to collection standards;
- quality controls and validation methods;
- integration;
- level of detail required including needs for estimates or approximations;
- collection methods;
- need for systematic time series, change analysis, update; and
- appropriate incorporation of traditional knowledge.

It is also important at this stage to develop strategies for communicating to those collecting data why it is valuable for them to do so, and where necessary developing appropriate training programmes. Commitment to the process at all levels is essential to success.

9.2.4.2 Data management strategies

Project managers must also devise strategies for managing their data. Because data collectors must be aware of any specific requirements (relating, for instance, to data type, quality assurance, digital media formats, communications, and time scales), planning such strategies should take place before the data are collected. It is at this stage that very careful thought must be given to the appropriateness of technological solutions to data management tasks.

Issues that should be considered in developing the strategy include:

- negotiations over coordination and custodianship with managers of existing data management programmes (9.2.5)

- evaluation of appropriate tools (9.3 and 9.7.3)
- identification of investment required (9.7.5)
- identification and adoption of standards (9.2.6)
- personnel/institutional issues (9.2.5 and 9.7.4)
- location of data management programmes
- documentation and metadata (9.2.4.3 and 9.2.4.4)

9.2.4.3 Documentation

It is essential that data collection and management procedures are well documented to facilitate not only the application and dissemination of data, but also to ensure continuity of data collection procedures. Documentation should cover data collection and management procedures as well as issues of data quality. For example, each data set should have information on:

- source of data
- data lineage (actions performed on data since collection/derivation)
- accuracy and precision
- date and life expectancy of the data
- data field definitions
- collection methodology
- comprehensiveness
- consistency
- constraints on use

Data that are fit for one purpose may or may not be fit for another. Only with adequate documentation on data sets can this be assessed, and appropriate caveats added to applications of these data.

9.2.4.4 Metadata

With the rapid increase in information available and the need to use information, metadata – information about information – is becoming increasingly important. Documenting what data sets are found where, what they contain, and how they are put together forms the basis for the development of data directories (see below), either published or electronic. The development of both documentation and metadata should be considered an essential part of good information management practice.

Typically, a metadatabase might include two types of information:

1. About institutions that hold relevant information:
 - basic details (who, where, and function)

- available resources (human, technical, financial)
- key linkages (who currently works with who, and how)

2. About relevant data sets:

- description of data sets (what, purpose, format, and how managed)
- coverage (geographic, thematic, time scale, completeness, limitations and gaps)
- access (availability, cost, formats available, and documentation)

9.2.5 Custodianship

All data sets required in environmental information systems are complex, thus their establishment and maintenance requires the knowledge of specialists. This specialist knowledge is needed not only to acquire and maintain data, but also to document the data and advise clients on its fitness for various potential uses. Custodianship is the means by which responsibility for data sets (or defined parts of data sets) is assigned to and accepted by the most appropriate organizations. It provides a mechanism to ensure that each data set is established, maintained and made available by the organization best able to do so.

Custodianship includes responsibilities in data acquisition, management and documentation as well as rights to determine the conditions under which data are accessed and used. Custodianship may also include responsibility for modelling and analytical tools, including expert systems and decision support systems (Busby and Walton 1994). A custodian should consult with all categories of potential users of a data set to ensure that, as far as practicable, their requirements are taken into account. Where user requirements exceed those of the custodial agency for its own corporate objectives, additional resources may be required.

9.2.5.1 Criteria for assigning custodianship

The most appropriate custodian for a data set is likely to be the agency that meets one or more of the following criteria:

- has sole statutory responsibility for capture and maintenance of a data set;
- normally is the first to record changes to a data item;
- is the most competent to capture and/or maintain those data items;

- has the confidence of users that it will continue to meet its commitments to data collection and maintenance; and
- requires the highest integrity of a data item.

Certain data sets are of very high national priority, and it is particularly important to identify appropriate custodians for these. The data sets that are required to support national objectives or those of a number of agencies would be among the first to be considered. Every country, for instance, needs an accurate and stable data set representing its national boundary, which must be maintained at a resolution and accuracy required by key national agencies and their programmes. One agency, in this instance normally some central mapping agency, should be assigned as custodian for this data set. If a country cannot do this, consortia of countries could share custodianship of these data in a regional centre.

9.2.5.2 Responsibilities of custodianship

A custodian should provide the following services:

- organize the building of the data set
- update the data set
- ensure the continued integrity of the data, e.g. through making periodic copies of the data
- archive the data set, whether as hard copy or electronic copy
- ensure appropriate access to the data set
- maintain documentation of the data set
- advise on appropriate uses of the data set

9.2.5.3 Custodianship in networks

The principle of data custodianship in information networks is that all data available to the network is 'corporately owned', meaning that many network users have a stake in those data. Designated custodians, however, have responsibilities to collect and maintain the data and also rights to regulate their access and use. Conditions may be attached to data on a network: for example, data may be used for government decision-making, public information or research purposes, but not for any commercial purposes without a specific licence to do so.

Custodians are responsible for licensing arrangements, which often become complex. For example, some agencies in a network may own licences to use data that would be infringed if those data were passed through the network, but not if they were passed directly to certain other networked agencies. In other cases, certain agencies may be authorized to access data in raw form, while others may only be able to access more generalized versions.

9.2.5.4 Difficult issues in custodianship

Identified high priority data sets that underpin the corporate objectives of well-established agencies tend, on the whole, to be well maintained and documented. Difficulties can arise where an agency has built a data set of relatively low priority to that agency but of high priority to another, which itself is not in a position to be the custodian. An example might be a digital elevation model, which would be required by a number of resource management agencies, none of them with the expertise to construct and maintain such a product. In such cases, some higher-level framework agreement should be negotiated between the various stakeholders and any resource implications resolved.

Another problem can arise when a number of agencies – such as research groups – collect data on, for example, the distributions of animal or plant species. Each data set may be accumulated for different purposes, meaning that the various data fields, even when congruent, may be collected to different standards. It can be extremely difficult to integrate all these disparate data sets in order to build a nationally coherent data set. Even if such a data set is feasible, who is then the custodian of the data – the agency that integrated them or all the individual contributors? If the latter, how does one resolve the fact that each small research group may have no interest in long-term maintenance of the data? In fact the group may even disband after the project has been completed.

9.2.6 Standards and guidelines

One means of ensuring the wide applicability and relevance of information is the development and promotion of standard methods and classifications to facilitate information exchange. While it is difficult to find international consensus on many aspects of data collection and management it is still possible to develop basic principles that ensure the continuity of data and their analysis among researchers. Encouraging the application of such standards is very important, yet wide application comes not from adopting and promoting all that is new and sophisticated, but from fostering a strategic vision of future compatibility. It is far more important that some standards are used – and that they facilitate access to information – than it is for the newest standards to be adopted.

The issue of defining and adopting a set of standards is problematical because, ultimately, all standards are compromised by available resources. It is, for instance, expensive to guarantee well-documented and quality-controlled data. In situations where resources are scarce, it is unreasonable to expect methodologies and analyses that demand a high degree of investment and sophistication. It would, for example, be inappropriate to suggest that wildlife protection should adopt a standard requiring data-

intensive methods in a country that is not easily surveyed and has limited resources.

In developing and promoting standards, one must also be aware of the potential for over-standardization, which constrains new initiatives in the development of what is still a very new science. For instance, there are new possibilities for measuring plant and animal distributions using the Global Positioning System, which have changed current requirements for standardizing qualitative/quantitative procedures for citing field observations.

These issues should encourage institutions interested in developing standards to consider promoting 'guidelines' and methods of 'harmonizing' data (making different approaches comparable) in cases where universal standards are premature. The development of such standards and guidelines is the focus of work currently under way under the auspices of UNEP and a range of other organizations, which should facilitate the collection, management and application of data.

9.2.6.1 Potential areas for the development of standards

The following list provides an overview of areas where standards might be developed or adopted and more widely promoted. Such standards may be developed at the national or local level for specific projects, but the more widely standards are adopted, the more useful and comparable the data become.

- data collection methods and survey protocols
- documentation and quality assurance
- key products – particularly those that may be specifically defined by international agreements such as the Convention on Biological Diversity
- cartographic projection
- spatial data accuracy
- baseline classifications (such as species, protected areas)

9.2.6.2 Potential areas for the development of guidelines

The following list provides an overview of areas where guidelines might be developed or adopted and more widely promoted. As with standards, such guidelines may be developed at the national or local level, but the wider their applicability the better.

- information collection methods
- information management methods
- development of reporting and products
- data application (modelling)
- data validation

- user interface
- vegetation classification
- harmonization of data

9.3 Tools and technologies

9.3.0 Introduction

While it is possible to collect substantial amounts of data relatively easily, these data alone do not provide the understanding of biodiversity that is so critically needed today. For that understanding, it is necessary to have the tools to make the data useful to decision-makers and others. This chapter will review the most important tools and technologies now available to manage data and convert them into valuable information.

Different tools are needed by each of the many kinds of players in today's field of biodiversity management. These players include: the so called 'experts' working in a very specific field (for example, database experts, GIS experts, computer experts and biodiversity experts), planners who use input from experts to transform data into information and provide it to decision-makers, and decision-makers who take this information and use it to make policies and initiate projects.

The tools discussed in this chapter include those that are needed to manage, analyse, model and disseminate biodiversity data (see Figure 9.3-1). They are all computer tools, because the authors have assumed that there already exists wide familiarity with non-computer tools such as card indexes, filing cabinets, annotated maps and libraries. The issue of establishing libraries and similar information services is discussed by, for example, Webb (1988).

9.3.1 Data management tools

One challenge when selecting a data management tool is that of ensuring that data can be retrieved in whatever form users require. A wide variety of such tools are now available, ranging from written text on paper, filing systems and libraries to sophisticated computer databases, including geographic information systems. Assuming a general knowledge of non-computer tools, this section concentrates on computer tools for information storage and management.

9.3.1.1 Database management

Until the mid-1970s 'database management systems' (DBMS) for organizing data were commonly based either on a hierarchical structure or on a network structure. These approaches limited their application in the environmental field because they were unable to handle either the complexities usually encountered in environmental data or the complex relationships among these data.

In recent years, the development of 'relational database management systems' (RDBMS) has had a significant

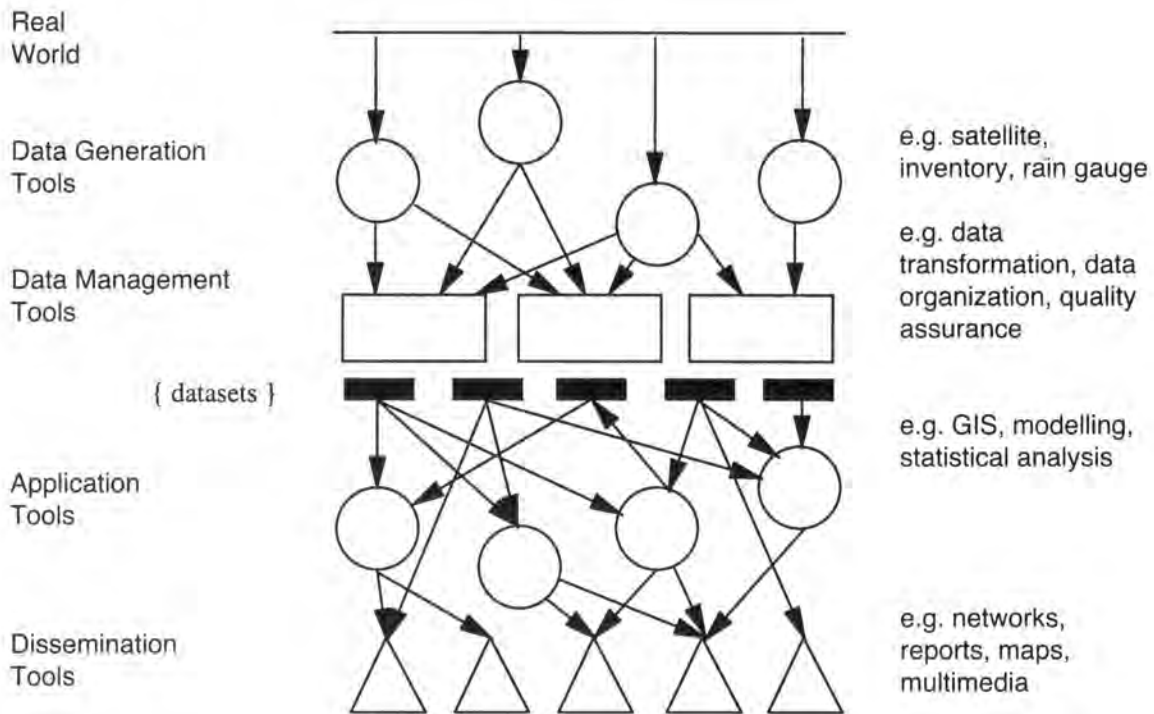

Figure 9.3-1: The information process.

impact on data management. RDBMS organize information as a set of tables or files, with relationships between files determined by common values in the 'related' tables. Thus the RDBMS model for organizing data offers a flexible database structure that is easy to define, expand and change. Accessing one type of data allows one to explore relationships with others that are needed for effective environmental information analysis.

Associated with RDBMS has been the creation of 'Structured Query Language' (SQL). This is an English-like retrieval language for querying relational databases. It borrows mathematical set theory concepts for expressing the query. More important, SQL is database-independent, allowing its use with many available RDBMS systems. The standardization introduced by SQL frees organizations from being committed to any particular brand of RDBMS and introduces even greater flexibility.

SQL also has benefitted from the development of client-server database architectures. Normally a PC database is a single program that handles both the data files and the user interface (forms, reports and so on), but these responsibilities are split in a client-server system resident in different computers connected through a network. One application – the client – looks after the user interface, while another – the server – manages the data files at a central location (usually the network file server), and can deal with many clients on a network simultaneously. This architecture is currently incorporated in most commercial RDBMS packages, and facilitates the development of data sets that can be accessed by a wider range of users in remote locations.

The 'Object-Oriented Database Management System' (OO-DBMS) is a relatively new approach that could further improve one's ability to manage groups of data items (objects) and make connections between objects. The OO-DBMS approach provides an intuitive and powerful way of creating and implementing data models of complex systems such as ecosystems. Because this technology is still immature it suffers from the poor performance and lack of standards that RDBMS suffered from a decade ago. In the future, however, this technology will allow information compatibility on a much broader scale than is possible today.

There have also been recent developments in distributed database systems (DDBMS) – single logical databases physically distributed on several computers that communicate through a network. These provide multiple access to databases as well as mechanisms to avoid conflict in update, retrieval and backup of data. DDBMS are particularly useful for very large databases where most users are concerned with only a small subset of the data. They also permit access to users with broader needs.

Currently, however, it is difficult to link existing databases in a DDBMS because of differing technology at each site. A possible solution to this problem now being developed is the 'Federated' database management system, which has the advantages of the DDBMS but also allows data communication among DBMSs of different data models, brand-names and access methods. (At the same time, each local DBMS remains autonomous.) The environmental policy decision support system of the future will no doubt

use this technology to link heterogeneous information collections in various countries and agencies. The technology is expected to mature in the next five to ten years.

As database management tools become more powerful and easier to use, many institutions responsible for biodiversity collections have developed specialized databases for the management of biodiversity collections or the analysis of regional or world data sets. Box 9.3-1 presents a selection of some of these tools.

9.3.1.2 Geographic information systems

Much biodiversity information is spatially orientated – it can be mapped. For many purposes, simple geographic information such as latitude/longitude, and links with geographic features such as countries or provinces, is quite adequate and can be used to produce simple map-based products. These need not necessarily be computer-based.

Computer map-based geographic information systems (GIS) have been used to manage environmental information and aid decision-makers since the inception of the Canadian Geographic Information System (CGIS, Canada Lands System Division, Environment Canada) in the mid-1960s. The basic advantage of a GIS is its ability to manage and perform complex processing on both spatial and statistical data and to permit the manipulation of geographic boundaries. This allows for the integration and summarization of environmental information using natural units – such as watersheds, natural forest areas and soil units – and to combine these effectively with human-made administrative data collection units. Thus a GIS can provide a link between the decision-maker's viewpoint and the natural boundaries of a problem (Fedra 1993) (see Box 9.3-2).

In spite of considerable interest and demand, current GIS technology is still limited in its applicability for environmental decision-making. First, spatial databases for any given region are frequently very large, requiring large system resources and highly trained personnel. Second, most early developments of GIS technology were orientated to produce high-quality cartographic products as a priority, giving less importance to modelling and data analysis issues important in the environmental field. For this reason also, systems tend to be designed with the GIS specialist in mind, and they tend to be complex. Users commonly note 'lack of user friendliness', 'slowness' and 'unreliability'.

Another drawback with current systems is that they cannot represent or process information of an uncertain or variable quality. A further restriction on usefulness is the lack of standardization of internal structures and access methods. No standard spatial access protocol like SQL is yet on the horizon, so it may be some time before the heterogeneously distributed GIS needed for decision-making becomes a reality.

This tendency has been changing lately with the development of simpler GIS systems with friendly interfaces, for the use of non-specialists interested in incorporating spatial analysis within their own work. This tendency is also improving in the integration of systems and their capacity for exchanging data.

There is considerable research into GIS and their applications, and a number of journals dedicated to the subject, such as *International Journal of Geographic Information Systems*, *Geojournal*, and *Cartographica*. A number of trade magazines provide useful information on GIS software and related hardware, and often feature consumer reports. Popular magazines include *GeoInfo Systems*, *GIS World* and *GIS Europe*. Basic text books on the subject are numerous and include Aronoff (1989), Burroughs (1989), Tomlin (1990), McGuire *et al.* (1988), and Antenucci *et al.* (1991) and Miller (1994), both of which provide a number of examples of applications relevant to biodiversity. A review of GIS and databases for vegetation change studies is given in Skole *et al.* (1993).

9.3.1.3 Management and integration of text

The recording of biological and environmental phenomena still relies heavily on a descriptive (narrative) approach that can only be captured in text form. For example, the best description of a protected area is likely to be a narrative describing its floristic and faunistic characteristics.

The basic tool for producing text is and will continue to be the word processor. In the past, however, scientists have been reluctant to rely too heavily on word-processed documents because they are not as easily queried or updated as database tables. Their main use has therefore been limited to reference material that is not likely to change (site descriptions, for example).

For several years software tools have been available to increase the utility of digital text through the application of text indexing that allows access to the text based on keywords, facilitating the location of relevant text. These tools are as flexible as the more popular database management systems, though the contextual form of free text can often be more informative. Such tools have been used very successfully in the past to retrieve data, metadata and reports. Nevertheless, their use is not widespread and remains limited.

With the advent of network communications, we are seeing a renaissance in the use of text as a form of information storage and retrieval. Network tools and services such as email, Gopher, WAIS (Wide Area Information Server) and WWW (World Wide Web) are ideally suited to the querying and retrieval of text. Tools such as WAIS are particularly powerful systems that allow Internet users to query a wide variety of information sources based on word searching.

Box 9.3-1: Selected biodiversity database projects.***FishBase***

Description: A global database on fishes developed by ICLARM and FAO with support from the European Commission. The database presents information on all aspects of ichthyology and of fishes as resources, notably on their nomenclature, distribution, ecology, reproduction, growth and mortality.

Where used: More than 63 researchers from 18 countries have contributed to the collection and validation of FishBase data holdings. Particularly active countries are Australia, Bangladesh, Ghana, Hawaii, Malawi, Malaysia, Mexico, Peru, the Philippines and Vietnam. *Availability:* The full FishBase software package (with pictures) currently requires about 100 Mb of hard disk space, and has only been provided to close collaborators (around 20 institutions). Most users will prefer to wait for the CD-ROM which was released in 1994, and will be updated regularly.

Contact: R. Froese/M.L.D Palomares/D. Pauly, International Center for Living Aquatic Resources Management.

Biodiversity Information Management System (BIMS) [formally MacKinnon-Ali Software System (MASS)]

Description: Relational database for monitoring the conservation status of species, wildlife habitat and protected areas.

Where used: Most Asian countries; used to determine conservation priorities at institutions in Bhutan, China, Indonesia, Thailand and Vietnam.

Availability: User manual is provided; continuous support is not. Various aspects of BIMS are still under development (e.g. data validation, user interface design, ease of use, packaging). To realize the full potential of BIMS, an intensive period of training is required.

References: MacKinnon (1992), MacKinnon (1994).

Contact: John MacKinnon, Asian Bureau for Conservation.

Botanical Research and Herbarium Management System (BRAHMS)

Description: An information system for storing and processing botanical data, primarily that derived from or relating to botanical collections. The system has been developed for use by professional botanists, for general herbarium management, and for those working in disciplines such as ecology, forestry and conservation science.

Where used: Various locations in Africa and Central and South America.

Availability: The system is supplied with full technical documentation and user manual. A module known as RDE is also provided for Rapid Data Entry. BRAHMS is only supplied via a formal collaborative arrangement, in which installation, training and support are provided.

References: Filer (1994).

Contact: Dennis Filer, Oxford Forestry Institute.

Environmental Information System (ENVIS)

Description: A suite of packages aiding retrieval of information on government and non-governmental environmental activities.

Where used: Indira Gandhi Conservation Monitoring Centre, New Delhi.

Availability: The system is currently not available outside of IGCMC. However, plans are being made to release data holdings over the Internet, and to provide run-time versions to other organizations.

References: WWF-India (1994).

Contact: S.K. Puri, Indira Gandhi Conservation Monitoring Centre.

The trend toward the use of WWW will make the integration of text and data more powerful as it encourages the use of text not just as a format to hold information and data, but also as a means of helping users find and use data. For example, users of a WWW page may selectively retrieve information based on related text describing sources and quality. These new tools, coupled with the very large user base provided by the Internet, have empowered organizations with large text-based archives to become active in the dissemination of information and data.

9.3.1.4 Tools to computerize existing data

When dealing with large amounts of data, information retrieval can become extremely difficult. Modern tools such as computers provide assistance in accessing data, but the problem of converting existing data into electronic form remains. Fortunately, there are several tools that facilitate the conversion of analog data (paper, graphics, images) into electronic form, thereby reducing the need to enter them manually using a computer keyboard.

Box 9.3-2: Added value of a national environmental information system.

Eighty major development projects in various sectors in Lesotho were reviewed by Tveitdal (undated). Every project needed geographic information as a basic input, and 50 of the projects produced geographic information useful for environmental assessment and resource management. In all 80 projects, a great deal of time and money were used in the collection and integration of incompatible data from various sources. Moreover, in most of the 50 projects that produced environmental or resource information, the information was simply discarded at the end of the project. In the best cases, it was filed in the form of reports. Upon completion of all 80 projects, the general availability of environmental information in Lesotho had not been improved at all.

If a national Environmental Information System (EIS) had been established at the outset, project-orientated information could have been accumulated in a systematic way and shared among projects, increasing the value of information many times over and reducing project costs. An EIS would have also increased the overall value of environmental information in Lesotho, resulting in better resource management and environmental protection in the future.

The conversion of text on paper into electronic form can be done, for example, using a 'scanner' that converts written lines into a graphical image. This image can be converted into text using optical character recognition (OCR), and, if the text is laid out on paper in a standard way, it can then be converted into a data file. However, not all text can be converted into a computer-readable format accurately, and handwritten text cannot be recognized by commercial software. Problems can also arise during the OCR process if printed text uses too many different fonts and sizes.

Scanning devices range from very simple desktop devices to extremely sophisticated professional scanners. The devices can also be used to convert printed images, graphics and maps into electronic form. The resulting electronic images – in particular, maps – may be extremely large files, and their manipulation requires specialized software packages. When scanning images and/or maps, consideration must be given to what kind of device will represent the resulting electronic image as this may dictate the resolution and thus the type of scanner required. If the scanned maps are to be used within a GIS, points on the map will need to be accurately geolocated, and one may also need a considerable amount of identification of features and the addition of attribute information. Maps can also be manually digitized, which involves the physical

tracing of lines on a map after the map has been set on a digitizing table.

When scanning or digitizing any data, it is critical to validate them (just as is done when data are keyed into a computer). To maintain data quality, nothing should be added to a database without being checked for reliability. In addition, while the conversion of data from remote-sensed imagery to maps can provide a substantial amount of valuable information, it can also introduce errors. It is therefore important to require some in-the-field qualification/quantification of remotely-sensed data – a process called ground truthing – before making any major decisions based on these data.

9.3.1.5 Harmonization tools

Combination of data from different sources, or from different environmental sectors, depends more on the data themselves and how they are collected and stored, than on hardware or software. Effective combination requires a knowledge of the measurement techniques, standards, classification systems, quality assurance methods and terminology used in obtaining and describing the information. This re-emphasizes the importance of adequate documentation of data sets (9.2.4.3), and the value of metadata (9.2.4.4) in locating those data that can be usefully combined. Most frequently, harmonization relies on the use of whatever computer tools are available by individuals familiar with the data concerned. Combination will depend on key fields present in both data sets, which may be geographic or taxonomic, and so on.

Simonett (1992) identified a range of issues that should be examined in merging remotely sensed data with data from other sources, including:

- the quality of the various data sets, and the effects of data quality on error propagation;
- establishment of physically-based or index relations between remotely sensed data and other data, to enable data substitution to be employed; and
- the degree to which missing data can be tolerated.

Image analysis systems (which provide tools for processing digital images deriving from remote sensing and photography) have been developed mainly as aids to the interpretation of remote-sensed imagery, but are now merging with GIS technology. Functions offered usually include geometric rectification and automated image classification. The basic differences between the very low cost systems and more expensive systems are the range of choice in automated classification, size of the image which can be handled, and the range of output choices.

In the field of biodiversity, many of the data have a subjective element and considerable uncertainty. Resulting from the intrinsic complexity and randomness of nature,

combined with finite budgets, this uncertainty cannot be entirely removed. Biodiversity conservation decisions must always be made in the presence of imperfect data. The technology of uncertainty management is therefore an essential harmonization tool. There have been recent advances in this area, employing what is called fuzzy set theory and fuzzy logic to manage retrieval in databases with subjective or 'verbal' attributes and the use of spatial uncertainty zones and error propagation techniques to present visualization of relative uncertainty to decision-makers in the form of an uncertainty map.

Modern metadatabases and other information servers are beginning to use hypertext linkages and multilingual thesauri to form flexible relationships between the information descriptors, which allows for effective intelligent guidance to the decision-maker on locating the appropriate information, its quality and accuracy, and its appropriateness to models. Although at present the information available over such networks is very variable, such information sources are key to an effective intelligent human interface to an environmental decision support system.

9.3.1.6 Environmental thesauri

Sources of information can be described and referenced through a catalogue or a metadatabase by assigning descriptor keywords to the sources. The use of a controlled vocabulary to describe data sets has the following advantages:

- it ensures a consistency of spelling around the world;
- it provides cross-linking and referencing through a hierarchy of categories and a network of related terms; and
- it provides standard lists in multiple languages (e.g. English, French and Spanish).

Good thesauri will not only deal with synonymy (such as wood and forest, or national park and *parc national*), but will also store a hierarchy of categories. For example, a geographic thesaurus would enable a search on the keyword 'Africa' to score a hit if it located an information source with the keyword 'Kenya'.

A conclusion of the International Society for Knowledge Organisation (ISKO) Conference of 1994 (Rybinski *et al.* 1994) was that the range of existing environmental thesaurus initiatives was not desirable because they lead to an uncoordinated and confusing plethora of choices for the thesaurus user. Collaboration between these initiatives was required so that at the minimum a common thesaurus structure could be agreed upon.

The major environmental thesauri are:

- CAB International Thesaurus for Agriculture and Environment
- The Consortium for International Earth Science Information Network on-line catalogue system
- EEA, Trilingual Thesaurus for the Environment
- INFOTERRA, Thesaurus of Environmental Terms
- Japan Information Centre for Science and Technology (JICST) Thesaurus
- Umweltbundesamt Environmental Thesaurus

9.3.1.7 Other evolving tools

Several other areas of information technology are evolving rapidly today, and some may prove very useful to environmental decision-making. Recent advances in telecommunications allow the transfer of very high volumes of digital data between different locations. In theory, it would allow the creation of a globally distributed database (although so far none has been created). In practice, at the very least, it has permitted the efficient movement of large volumes of information.

New knowledge-based or 'expert' systems are intended to give decision-makers the reasoning power of a large group of experts who have individually contributed their knowledge. These systems should help environmental decision-makers locate appropriate information (where the complexity of the data is too great for any one person to 'know') as well as provide expert reasoning in the decision-support models.

Global Positioning Systems (GPS) utilize a series of satellites to allow the determination of positions on the Earth's surface in terms of their latitude, longitude and altitude. The units that achieve this are referred to as GPS receivers and can be small enough to be hand-held or used in moving vehicles. These are obviously important aids in determining the location of sample sites or biological observations, which in the past was often accomplished by marking maps or air-photos – an error-prone process, especially in dense forest or featureless terrain. Absolute accuracy on the ground is normally limited to 100 metres, but relative accuracy using 'differential' methods from a nearby accurately surveyed point can easily be a few centimetres.

GPS receivers can be linked to digitizing software, allowing data capture in the field and this process is becoming more popular, particularly in areas where very few data already exist and accurate locations are required (to the nearest 100 metres). Improved accuracy normally means increased cost, with highly accurate units (which utilize several transmission frequencies and many 'channels', i.e. satellites) costing a few thousand US dollars. Less accurate units suitable for field work cost a

few hundred dollars. Analysis software is also needed, and in some cases incurs an extra charge.

New applications based on graphical user interfaces and standardized menu systems are becoming much easier to use than older systems, integrating many of the functions that previously required separate programs and new interfaces to learn. Many communication functions are being built into the operating systems on which computers run, further simplifying the installation and use of networked applications. These tendencies facilitate integration and effective use of a wide variety of tools in biodiversity assessment and management activities. Many of these applications do require more powerful hardware, but the increased cost of equipment should be considered in the light of cost savings from reduced training requirements and the more limited potential of less sophisticated solutions.

9.3.2 Reporting, analysis and modelling tools

The products of information management range from very simple indexes and indicators to complex environmental or spatial models. The applications and use of these products will also vary – from efforts to better understand the natural system to the evaluation of the impact on the system resulting from a specific action, prediction of the natural or human-influenced evolution of a natural system, or the development of flexible decision-support systems in environmental management.

All the data management tools described in the previous paragraphs have output capabilities that allow for the selection of material based on defined criteria. For example, RDBMS records can be selected to meet certain criteria and be sorted and presented in a variety of formats. In a GIS, a range of maps can be generated and overlaid to demonstrate certain landscape features and then be printed out as part of a report (possibly with annotations added from attribute files).

Environmental modelling has developed considerably since the early efforts of Volterra (1926) to model competition between populations. Not all areas of analysis related to biodiversity have the same level of development: some natural processes lend themselves to analysis with currently known technologies. In other cases we have not been able to develop a sufficient level of understanding of the system, and an analytical approach commensurate with the challenges placed by biodiversity management. Nevertheless, this field has benefited greatly from the easier access to and power of the present breed of computer equipment, allowing an easier and more cost-effective use of these analyses at several scales, from field level to national level.

As demand for analysis and modelling grows, so does the demand for more data, at different scales, with better precision and quality. Data availability and quality will in most cases determine the type of analysis that can be done.

In most cases, trying to implement too complex an analytical approach – with limited data or data of questionable quality – might prove to be a mistake. In these cases, a simpler approach based on the use of more basic database outputs, indices and the advice of experts may prove to be more useful and viable.

9.3.2.1 Modelling physical and ecological processes

Models of the physical environment represent the most advanced area in environmental modelling to date. Such models include analyses of hydrological systems, atmospheric systems, and land surface and subsurface processes. Present modelling efforts range from simpler non-spatial prediction models for water flow to complex dynamic models that explicitly include a spatial topology.

One important type of analysis is the extrapolation of spatial data, principally topography and climatic variables (see Box 9.3-3). The digital terrain model and climatic layers generated through this process can be used in a great number of analyses related to biodiversity – for example, for predicting the potential distribution of a species, or in estimating areas of high fragility based on erosion potential.

Biological and ecological models focus on obtaining a better understanding of the structure and dynamics of natural systems. These kinds of models have already been discussed elsewhere in this volume.

9.3.2.2 Risk and hazards

Concerned with the analysis of interactions between humans and the natural world, these are among the most frequently used environmental analyses. So far they have focused primarily on the area of impact assessment – estimating the impact of development projects on the environment and on biodiversity. These assessments take into consideration effects on land use and land-use change, socioeconomic processes, quality of life and so on, integrating a wide array of information under a common framework, usually provided by a GIS.

Risk and hazard analyses require an integrated information system that will include relevant information on the physical environment (topography, climate, soils, etc.), biotic environment (species distribution, distribution of ecosystems, habitats, etc.), socioeconomic issues (including population growth and demand), and the entire area of natural resource use and conservation.

9.3.2.3 Modelling and policy-making

The development of decision-support systems in the environmental field at the level of planning and policy has been advocated for some time. Nevertheless, there are a limited number of successful implementations. This is an area where more effort is needed in the development of novel approaches to better integrate large amounts of data

of different types in a framework that will facilitate the analysis of complex problems by different types of decision-makers, from citizens to government officials.

A key issue related to the Convention on Biological Diversity is that of defining priority areas for the conservation and management of diversity. One effective approach to regional priority-setting has been that of relying on experts on a particular region to identify top conservation priorities within the larger area. These experts make heavy use of a previously assembled GIS-based database on the region's physical and biotic environment, land use, population pressures, natural resource use, and other variables (Olivieri *et al.* 1995). The end result is a consensus among a broad array of experts on specific areas of high biological value, threats to their future, and opportunities for conservation within the region.

9.3.3 Networks

The use of stand-alone computers within an information management facility can be greatly enhanced through the development of Local Area Networks (LANs). This not only allows the sharing of resources such as printers and file storage facilities, but also provides the opportunity for exchange of documents, messages, images, sounds, spreadsheets and databases. LANs can also use telecommunications facilities to link to other networks and, with the growing awareness of the importance of information and communications, wide area connectivity has become a primary issue. In more and more cases it is now expected that computers *should* be networked in some way, able to communicate with any other computer similarly connected whether in the same office or on another continent.

However, networking depends on the efficacy of national telecommunications infrastructure. Despite rapid technological advances and decreasing costs, telecommunications facilities have not kept pace with developments in computing (Jensen 1995). Demand for facilities to exploit sophisticated applications remains largely unsatisfied for many users, even in developed countries. This is almost always because of the fragility of the 'last mile' from the public telecommunications operator to the user. This situation is particularly important in developing countries where this is the most important limiting factor for the interconnection of the existing computing capacity. Africa, for example, has an average phone density of one line per 250 people, which represents less than 1% of the density in the advanced industrialized nations. Some countries have less than one line per 1000 people. Furthermore, in most developing countries, communication costs are still very high, phone lines are unreliable for computer communication, and waiting time for new connections is over-long (5–10 years). This situation is not likely to change in the near future and changes will most likely not occur quickly. As a result, we

Box 9.3-3: Bioclimate prediction model.

Bioclimate Prediction System (BIOCLIM)

Description: Software that uses previously generated climate surfaces to generate climate estimates for sites where a species has been recorded; generates a climate profile for that species, and evaluates geographic areas in terms of their climatic similarity to the profile.

Where used: Mainly Australia, although suitable climate surface databases have also been developed for New Zealand, Papua New Guinea, Madagascar, Guyana, Africa and other areas.

Availability: A basic user manual is provided; continuous support is not. System was converted from a mainframe version to PC and does not meet commercial standards in terms of user interface design or ease of use. Good background on GIS is needed to realize the potential of BIOCLIM.

Contact: Henry Nix, Centre for Resource and Environmental Studies, Australian National University.

must be careful in assessing the value of networking in each country and look for those technical solutions that will allow us to circumvent these limitations.

9.3.3.1 Connecting to networks

Until relatively recently, most interaction between computers on different sites was *direct dial*, involving a direct modem/phone connection between individual machines. Terminal emulation programmes resident on both local and host machines allowed the computers to 'talk' to each other, and software resident on the remote host was then used to transfer messages and files, and to access other available services.

This system requires the user to be on line for long periods of time, so more recently *client/server systems* have been developed which use the capacity of local hardware as far as possible, to automate network functions, to integrate transparently with locally run applications, and to maximize efficient use of communications facilities.

It is often more cost-effective for a group of users to share the use of a local computer host (often called a *node* or *server*) which provides a 24-hour service to allow users to send and receive communications at their own convenience. The group of local users effectively splits the cost of maintaining the necessary linkages.

Services have now been installed by many public telecommunications operators which allow the use of local phone calls to connect computers to a *packet switched data network* (PSDN). Once connected to the local network, commands can be issued to link the user's computer to any other system connected to the worldwide network of PSDNs. These networks charge

mainly for the quantity of data that passes through the network.

An alternative to the demand-based temporary dial-up link over voice phone lines to a remote network is a *dedicated leased line* connection. A dedicated link has the added advantage of enabling members of other remote networks to access your system directly at their convenience, should this be desired. The maximum number of users able to share a line varies depending on the type of line available and the applications being used. While many users can make use of a slow link for electronic mail (which does not require interactive response from the user), sophisticated operations can become frustratingly slow unless faster (and higher costs) links are applied.

Connectivity in many developing countries is limited to email because of slow or unreliable connections. Although present technology allows connections at a speed of 28 Kb/sec over telephone lines, in practice the interference common on dial-up analogue lines can limit the potential speed substantially, especially during the rainy season when unmaintained cables can be subject to the effects of moisture.

9.3.3.2 Internet

The best-known computer network is the Internet, which is in fact a large collection of networks using a common communications protocol – Transmission Control Protocol/Internet Protocol (TCP/IP). Information can be communicated across these networks using a range of different tools (Table 9.3-1).

While in some parts of the world telematics activities are still virtually non-existent, users in many countries are taking advantage of the wide range of information available through computerized networks (see chapter 9.4). One hundred and fifty-nine countries now have some form of connection to the Internet (Figure 9.3-2); the number of users was estimated at over 30 million by mid-1994 and continues to grow at 12–15% per month. At this rate, it is expected to reach 200 million by the year 2000. Where the precise nature of planned national and regional information infrastructures has yet to be established, the exponential growth of the Internet indicates that it will be the model from which other networks will evolve.

The Internet is experiencing exponential growth in the number of networks, number of hosts and volume of traffic. The number of host computers has increased from 200 to 5 million in 12 years (between 1983 and 1995) (Cerf 1995). The Internet now encompasses an estimated 50 000 networks world-wide, about half of which are in the United States.

The Internet breeds the electronic equivalent of the thief who looks for open windows and doors, but security is only a real problem for dedicated lines (see 9.3.3.1). The most robust form of security is to install a 'firewall'. This

is a computer set up between your computer network and the Internet through which all traffic is diverted. However, the issue of security is too complex an issue to discuss in full here. Service providers should be able to advise on this.

The growth of the Internet and its distributed architecture has encouraged the integration of local dial-up networks. Most of these networks offer at least email access to Internet and in many cases other services such as FTP and Gopher as well. They also provide their own tools for news and information services, conferences, database access, fax and telex. Because they offer a local dial-up connection, in many cases this is the easiest and most cost-effective way to link to the Internet in developing countries.

ECONET, established by the Institute for Global Communications (IGC), is one such network which provided email access in developing countries in Africa and Latin America long before Internet was accessible. The Association for Progressive Communications (APC), a consortium of more than 50 international member networks (among them the IGC networks) reaches some 30 000 people in more than 130 countries on themes closely related to biodiversity.

With the global interconnection of networks, contact can be made with millions of others on the various university computer networks that form part of the Internet world-wide, the APC, BitNet and other networks, as well as the commercial users on other business-related networks such as Dialcom, GeoNet, CompuServe and MCI Mail.

9.3.4 Other information dissemination tools

Traditional data dissemination in the form of printed material remains the most common approach today. Printed materials range from published books to posters and maps and from customized reports to standard products. With the advent of DeskTop Publishing Systems – which allow text, graphics, images and numeric values to be reproduced and moved around easily – all of these printed materials have become easier to develop in recent years.

9.3.4.1 Diskette and CD-ROM

The exchange of information between computers by the exchange of diskettes, and the marketing of information on diskettes, has been widely used for many years. This means of data dissemination is easy and direct, and it does not require a major investment in equipment to produce or to read. It is also a solution that depends on the passing of a diskette by hand – rather than over networks, which may not work in some parts of the world because of poor telecommunications systems.

Applications range from the simple exchange of data files to marketing diskettes that not only include data, but also applications for helping the user access and apply the

Table 9.3-1: Network tools and applications.

Tools that use computer networks include:

- **Electronic Mail** (email). This tool enables users to send messages as electronic text to one or more users working on another computer. It can also be used to automatically request identified documents.
- **LISTSERV**. This is an extension of email, where users decide to be on a particular mailing list for regular receipt of information or to participate in a discussion forum.
- **USENET**. This application is similar to the previous one, the main difference being that subscribers have access to electronic bulletin boards, and they can read the messages from the board itself without having to receive any messages.

Some of the more popular Network Information Retrieval (NIR) tools include:

- **Telnet**. This tool enables users at one site to connect to and use a computer located at another, remote site. To use Telnet, one generally needs an account at the remote site, but there are exceptions where a 'common account' for external users is available.
 - **File Transfer Protocol (FTP)**. A powerful data-exchange tool, FTP enables users from the same site or from different sites to access computer files and browse through them or bring them into their own computer for analysis. There are several tools to help FTP users find the data they need. One, called ARCHIE, locates files at remote sites by filename search.
 - **Wide Area Information Server (WAIS)**. This is a utility tool from the network that enables users to retrieve information by searching indexes of databases.
 - **GOPHER**. Gopher locates and retrieves information resources from other computers on the network through the use of a graphic interface. Its use is quite straightforward, and information can be located independently of the site where it is housed.
 - **Veronica**, acronym for Very Easy Rodent-Oriented Network Index to Computer Archives is a software tool for searching the Gopher-space using keywords. A list of Gopher sites that house information related to the keyword can be retrieved by Veronica.
 - **World Wide Web (WWW)**. WWW retrieves resources via an 'intelligent text' (called hypertext), which enables the user to browse information presented by a WWW server, 'clicking' on key words to retrieve further information. WWW supports the display and transfer of images, text and sound. It is an excellent way for organizations to present information in a structured manner to a very large audience.
-

information. Beyond data and text, diskettes can also hold simple graphics, which can be incorporated into their applications.

This general strategy for data dissemination received a significant boost with the recent development of CD-ROMs. These provide definite advantages over traditional diskettes, including a very large storage capacity, long life, and a ruggedness meaning that they can be exposed to shocks and electromagnetic fields. CD-ROMs have one drawback, however: they require special equipment both to enter and to read their data. This disadvantage may be outweighed by the additional data-holding capacity, which includes the ability to include large map and photographic files as well as video. There has been a rapid increase in the availability of information on CD-ROM in recent years. In regions where access to networks is difficult or expensive, this technology can play an important role in the dissemination of biodiversity information.

A major innovation in information dissemination is the use of 'multimedia', in which a combination of computer tools is used to present text, pictures, videos and sounds in an integrated format. Multimedia techniques have an advantage in that the non-expert user can easily access and navigate the complete range of information. CD-ROMs are a perfect medium for distributing multimedia applications given their high data capacity.

9.3.5 Selection of software and hardware tools

The fast development of computer technologies – both hardware and software – has also facilitated the rapid development of computer tools. These tools are becoming more accessible, more powerful, and easier to use. They require less training and software has become extremely user friendly. Despite this progress, current commercially available software will not necessarily respond to the specific requirements of biodiversity information management.

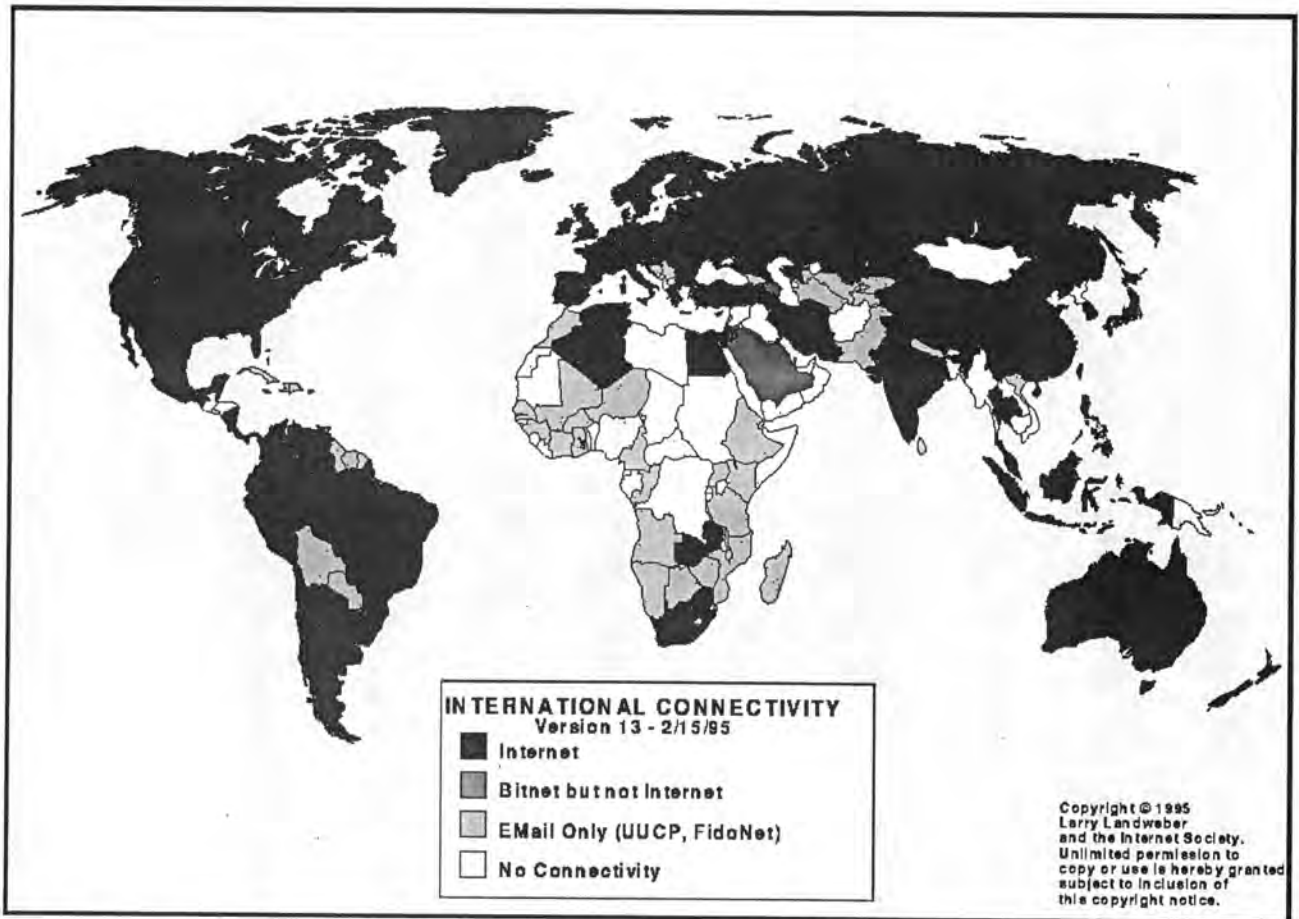

Figure 9.3-2: Network connectivity world map, February, 1995.

The development of tools is driven by demand – usually commercial demand – which means that the research and development effort is focusing on sectors with specific needs and constraints that do not necessarily reflect those found in the field of biodiversity information management. As a result, the range of tools on offer is limited, as is their ability to fulfil our specific requirements. In many cases we settle by adapting tools that were developed with a quite different set of objectives and constraints in mind. The demand-driven tendency means that most tools are developed in a few dominant languages, usually in English, limiting their full use in the developing world.

In some cases it may be necessary for users to consider the option of developing their own tools to complement the general ones that are widely available. Although superficially an attractive alternative, it is often a difficult one to pursue, and only in exceptional circumstances can a local institution do this in a cost-effective way. The rapid changes in technology and the need to keep the tools compatible with existing and emerging data formats and other tools, require a constant development and support effort to ensure the adequacy of the tools over time, a task that few institutions can justify with their own demand. One answer may reside in pooling demands for specific tools

at a national or regional level, ensuring a larger user base that can share development, support and training costs over time.

The first question when considering the development of a new tool is whether or not an appropriate one already exists. The computer network (see Chapter 9.4) can provide considerable assistance with this task. Considerable thought should be given to deciding whether an existing tool will require more work and expense (to change data formats, for example) than it ultimately will be worth. In addition, today's market is evolving so rapidly that tools may become obsolete after just a few years. One also should avoid creating dependencies on other parties (for training or maintenance, for example) that may become problems in the future.

9.3.5.1 Selection of computer software

There are many factors to be considered when buying software. In most applications it is more important than the hardware, although often the hardware already exists and the software must be adapted to it. Software may either be acquired as an off-the-shelf product (assuming the software can be run on the available hardware), or a new package can be developed specifically for the application in mind (or perhaps modified from an existing package to meet

specific requirements). The arguments for and against both these approaches are discussed in FAO (1986). Because many software packages are written for a specific type of hardware, knowing which computers will be used to run the application will eliminate some software packages from consideration.

9.3.5.2 Selection of computer hardware

If new hardware is required, then the best match between the system needs, the available resources, and the various hardware options needs to be determined. Establishing criteria for sizing applications is a complex process and is discussed at length in Bentley (1984). However, two preliminary, basic questions can be used to narrow down the hardware choices – the identification of the number of people who need *simultaneous* access to the data, and an assessment of how much data will need to be managed.

If single-user access is adequate, a microcomputer (PC) is probably the best choice, unless a very large amount of data needs to be handled (Fairhead (1992) provides an excellent, comprehensive guide to the technical options available for PCs and discusses their practical implications for the user). For simultaneous access by more than one person, a workstation is a better choice. If the plan is to store and manipulate a large volume of data, the options to consider include networks, minicomputers and possibly client-server architecture.

9.3.5.3 The selection process

The selection and purchase of both software and hardware follow a similar path, which can be broken down into the following eight stages. These stages are discussed in detail in Wright (1988).

- Decide what is required of the system.
- Carry out a feasibility study.
- Prepare an accurate specification of needs, which includes:
 - the system's objectives and functions
 - the work load to be executed (volumes of transactions to be input, processed, output, stored)
 - performance targets
 - special requirements in hardware, software and support services
 - operational requirements (availability targets, etc.)
- Invite tenders, based on the specification.
- Evaluate tenders, based on criteria that would include:
 - whether the solution proposed fully meets the specification

- price
- additional useful functionality proposed
- ease of use
- follow-on services (such as upgrades, maintenance, technical support)
- product reputation
- vendor reputation
- product durability (including likely lifetime and 'expandability')
- compatibility with other products
- comparative performance (see, for example, Fairhead 1992)
- Prepare a short-list based on the tender documents.
- Carry out acceptance tests to ensure that the system meets the specification.

9.3.5.4 Selection of database management systems

All databases, whether they are simple card index programs or full-blown professional development systems, store information rather like record cards in a filing cabinet. All database management systems allow the entry of new records, and changes to be made to existing ones, through screen forms (which can usually be customized). They also allow searches to be made for specific records, sorting of records into different orders, and the design of reports which print details of the records selected in the order desired by the user.

Most databases today are 'relational' in one form or another (9.3.1.1) and the majority follow a non-programmed approach by getting the user to complete on-screen forms or choose menu options. The more sophisticated databases are programmable, allowing the user to handle more advanced data structures and to tailor the resulting database to personal needs.

Some of the most important options to consider when deciding which DBMS to select are:

- whether a 'relational' capability is required (to combine data from two or more tables using key values)
- data validation capabilities
- file import/export formats supported
- form (screen display) designs, and the capacity to modify them
- indexing capability
- programmability

- adequacy of the report designer
- SQL and client-server architecture

9.3.5.5 Selection of geographic information systems

Several hundred commercial vendors can provide GIS software packages, and consequently a very wide choice of functionality is available. The two basic approaches are *raster*, in which the data are represented by a huge matrix of grid cells, and *vector*, in which the spatial data are kept as a series of connected line segments (arcs). Raster GIS are generally cheaper and simpler, and can provide good spatial modelling capacities and are thus often applied to regional planning and assessment. Vector-based GIS software is more complex and defines the data with much more detail and spatial accuracy. Application is widespread, particularly where there is a need for complex analysis and accurate delineation of boundaries, especially when high-quality cartographic production is involved. These systems also have higher requirements in hardware and trained personnel. Many systems now offer a mixed approach and are able to handle both kinds of data.

Geographic Information (GIS) packages offer a vast array of spatial analysis functionality, therefore the requirements should be defined very clearly prior to purchasing a GIS. For example, will the GIS be used for modelling or for simple two-dimensional map design? This type of consideration will greatly affect the choice of GIS – and its cost.

Many of the longer-established products have built up an international user base that collectively attends regular local, regional and international conferences. Several now have their own email list servers and news groups over the

Internet and CompuServe to exchange ideas and provide answers to problems. International or local support for the product may be provided by the manufacturer or distributor as part of the cost of purchase or as an additional maintenance contract.

For a complex software package, support, both as training and continued technical support, is an extremely important factor in the success of new installation. Different distributors are strong in different areas of the world, and consequently the support a user can expect varies with their locality. Local support and an established user base should be an important consideration when reviewing the possible options for the implementation of a GIS.

9.3.5.6 Existing biodiversity application software

Over the last decade, many institutions holding biodiversity information have applied information technology specifically to manage their data in efficient ways. The resulting tools, which can broadly be defined as biodiversity application software, fall into the following rough categories (see also Box 9.3-4):

- Species information systems. Sources of information on particular life forms or taxonomic groups. Some released as multimedia packages containing 'finished product' information sources (e.g. distribution maps, photographs, taxonomic nomenclature).
- Biodiversity assessment tools. Used to gauge the distribution and status of species, communities and habitats. By relating species occurrence to underlying habitat, some systems permit rapid biodiversity assessment using predictive techniques.

Box 9.3-4: Selected biodiversity application software.

ALICE Biodiversity Database System

Description: A family of programs for biologists designing and building their own checklist or biodiversity database. Intended primarily for data capture, ALICE also has species-orientated query facilities and pre-defined reports. Applications include writing checklists, building species inventories, and developing species identification systems.

Where used: The International Legume Database and Information Service (ILDIS), involving collaborating institutions in more than 20 countries; UK poisonous plants database; species inventories in several protected areas.

Availability: The Alice Software Partnership has a professional relationship with users. In exchange for a licence fee, programs are provided with documentation, user support and updates. On-site guidance for installation, use, and how to develop your own database, can be arranged.

References: ALICE (1990).

Contact: Robert Allkin, ALICE Software Partnership.

BG-BASE 4.0

Description: Database application designed for managing biological information in four categories: taxonomy, distribution, conservation and collections management (living and preserved). Suitable for a variety of institutions including botanic gardens, arboreta, zoos, university campuses, horticultural societies and private gardens.

Where used: BG-BASE has been installed at 53 locations in eight countries, including Arnold Arboretum, Harvard University, USA; Royal Botanic Gardens, Kew, UK, National Botanic Garden, Harare, Zimbabwe, and WCMC.

Availability: BG-BASE has been tuned to users' needs over a 10 year period. A comprehensive user manual is provided (currently under revision), and a regular newsletter is produced containing news from BG-BASE users, technical tips, and details of new locations using the system.

References: O'Neal (1989).

Contact: Kerry Walter/Michael O'Neal, BG-BASE Inc.

Biodiversity Data Bank 1.0 (BDB)

Description: Desk-top tool for storing, analysing and mapping biodiversity data.

Where used: National Biodiversity Data Bank, MUIENR, Uganda.

Availability: Full technical documentation is provided; however, no user manual has yet been written; continuous support is not available outside Uganda. BDB is written professionally in terms of user interface design, ease of use, and data validation, but would require *in situ* training until a user manual is produced.

References: Reynolds (1993).

Contact: Jake Reynolds/Derek Pomeroy/Herbert Tushabe, Makerere University Institute of Environment and Natural Resources.

Biological and Conservation Data (BCD) System

Description: Data management package that facilitates the collection, distribution and exchange of information pertinent to the preservation of biodiversity.

Where used: At Natural Heritage Programmes (NHPs) and Conservation Data Centres throughout the USA, plus Canada, Puerto Rico, and 13 Latin American countries.

Availability: Full training programme encouraged via collaborative agreement with TNC.

References: TNC (1992).

Contact: Richard Warner, The Nature Conservancy.

CISIG Geographic Information System

Description: A Geographic Information System designed to work at the field level: PC-based, multilingual (currently in English, Spanish, Portuguese), user friendly, analysis orientated (raster based), includes several modules tailored to needs of biodiversity analysis and management.

Where used: Installed in around 200 institutions, mainly in developing countries.

Availability: CISIG 3.0 available 9/95 for a price of US\$200 or through Conservation International's Grant Programme. The system is supplied with full manual in any of the three languages, technical support available from Conservation International and through the SIGNatura Network.

References: Conservation International (1994).

Contact: Silvio Olivieri, Conservation International.

Countryside Information System

Description: Stores, analyses and presents data for each 1 km square of Great Britain and Northern Ireland. Intended to help policy-makers and researchers obtain information about the British countryside in a standard and user friendly way.

Where used: UK Department of the Environment, ITE (Merlewood Research Station, Monks Wood).

Availability: The Countryside Information System is supplied as part of a commercial-quality package that includes technical documentation, user manual and support.

References: Barr (1993).

Contact: Robert Bunce, Institute of Terrestrial Ecology.

Expert Center for Taxonomic Identification

Description: A project to create a centralized resource of world-wide biodiversity information, via a network of contributing partners. The project encompasses software for entry of species information, species identification, and multimedia species presentation.

Where used: Queensland Museum, Australia; Smithsonian Institution; University of California; Institute of

Box 9.3-4 cont.

Taxonomic Zoology, Amsterdam; Shikoko University, Japan; many other institutions concerned with taxonomy in Europe and world-wide.

Availability: Partners for the ETI programme are actively encouraged. Each enters into an agreement with ETI to provide species data on a suitable media (including special purpose software such as *Linnaeus II* provided by ETI). In return ETI promises to distribute the results to partners regularly on CD-ROM.

References: Schalk (1992).

Contact: Peter Schalk, Expert Center for Taxonomic Identification.

Forest Reserves of Ghana: Geographic Information Exhibitor (FROGGIE)

Description: Interactive map-based database for assessment of forest biodiversity. Developed originally to manage the Ghana forest inventory, but now being extended into a generic forest assessment tool.

Where used: Planning Branch, Forestry Department, Kumasi, Ghana; Pasoh Forest Reserve, Malaysia.

Availability: FROGGIE is currently being developed into a sophisticated visualisation tool for a variety of forest inventory data. The new version (April 1995) written in Visual Basic (DOS) comes with full documentation. It is compatible with the BRAHMS collection management software and thus is able to share data files. The availability of support structures and documentation should be carefully examined.

References: Hawthorne (1992).

Contact: W.D. Hawthorne, Oxford Forestry Institute.

RECORDER 3.2

Description: Relational database for organizing site-related species records. Aims to answer two common queries: the species inventory for a particular location; and the circumstances of a record at a given location.

Where used: Biological recording centres, research organizations, conservation trusts, museums, local authorities, and individuals throughout the United Kingdom.

Availability: RECORDER is packaged with full documentation, training and user support (e.g. a bi-monthly newsletter). The current version is also bundled with Advanced Revelation 3.1 software so that users do not have to purchase this separately. The package is continually being improved according to user demands.

References: English Nature (1993).

Contact: Rosy Key, English Nature.

WORLDMAP 2.4

Description: Graphical tool for the interactive assessment of priority areas for conserving biodiversity. Can be used to find a sequence of priority areas accounting for the maximum biodiversity as measured by species richness, higher-taxon richness and various other phylogenetic dispersion measures.

Where used: The Natural History Museum, London; National Museums of Kenya, Nairobi; biodiversity research groups in Southern Africa.

Availability: WORLDMAP is supplied with basic documentation covering installation, use and potential error messages. A sample data set is provided with the system to guide and demonstrate its potential to new users. Ease of transfer of existing data and maps to WORLDMAP format, and long-term support issues should be examined carefully.

References: Humphries (1991), Williams 1995.

Contact: Paul Williams, The Natural History Museum (UK).

- Collection management systems. Facilitate the entry, storage, querying and reporting of information on biological specimens in museums, herbaria, universities and other collections.
- Biodiversity action records/tools. Supporting biodiversity conservation in novel or indirect ways. This would include a number of the models discussed earlier (9.3.2).

With most systems, a trade-off may be observed between the geographic scale of the information holding, and its subject area. For example, a localized system serving the needs of a single institution may bring together many areas of biodiversity information, whereas a global system may for practical reasons be restricted to a single subject area.

It is difficult to define 'typical' biodiversity application software due to the wide variety of tools currently in use, so it is necessary to review a variety of systems performing

different functions and illustrating different approaches. Only then can an assessment be made of the relevance of particular systems to an individual user's needs. A key aspect of this will be the degree to which the system is *transferable* to different situations, not rooted to one project or location.

9.4 Making information more widely available

9.4.0 Introduction

In addition to working within the framework of the Convention on Biodiversity, each of the world's nations will have its own unique information management needs and priorities. There is therefore no single recipe for information access and dissemination, and countries and other users of biodiversity information should adopt individual approaches based on local conditions.

The greatest challenge in information dissemination is encouraging agencies and individuals to share appropriate data with others who need it. This can happen in a variety of ways, including dissemination through networks, magnetic tapes, diskettes, reports and maps. One should not underestimate the value of simply copying and disseminating information to those who might use it.

It is essential to build an efficient information-dissemination infrastructure as part of the development of a national information management capability. This is vital in order to ensure that those most in need of information are able to access it in a format they can use. It is also critical that those who are part of the information process can see the value and impact of the information they have contributed.

9.4.1 Exchange standards

Communication between information providers and users depends on common vocabularies and languages, which are generally expressed as standards. Standards covering the way in which biodiversity data are collected and recorded are discussed above (9.2.6). The following paragraphs outline standardization in the exchange of data.

It is obvious that transfer of data between agencies and, in particular, integration of data sets from a number of agencies is made easier by at least elementary standardization. Similarly, data users are more comfortable with standardized interfaces and other methods of accessing data.

9.4.1.1 Directory exchange standards

These standards allow users to integrate descriptions of data sets from a variety of sources, usually data directories. Directories are maintained by a range of national and international agencies. There is no one body that can enforce compliance with any particular format, so agreed standards are necessary in order that users can navigate relatively easily between directories. The NASA Global Change Master Directory has been built on one such standard.

9.4.1.2 Data exchange standards

Data exchange standards often emerge out of informal arrangements between parties who want to move data back and forth. The simplest form currently in use is called ASCII text. As long as an institution's database software permits the import and export of data in ASCII text, data exchange is possible once the list of data elements to be exchanged and their characteristics have been determined.

Data exchange standards must take into account several variables: (1) the selection of attributes to represent biodiversity or other phenomena of interest; (2) the nature and meaning of values attached to those attributes, and (3) the way in which these attributes and their values are communicated. A 'community', for example, could be represented by: its species composition, the names (from a national checklist) and estimated abundances (from a specified classification system) of each species, and a data file transmitted from one agency to another in an ASCII character format with specified characters acting as field and record delimiters.

There are numerous spatial and other data transfer standards developed or being adopted around the world. This is a very dynamic area and much work remains to be done. Many standards are based on a standard language format, such as the International Standard Organization (ISO). Translations between these standards are being developed by various software development agencies. Some data transfer mechanisms are very straightforward and can be used by anyone. For example, as outlined above, merely using some designated special character to separate different attributes of a data record is a very simple, yet flexible and powerful, way of exchanging structured alphanumeric data. Table 9.4-1 presents a list of standards most relevant to the field of biodiversity.

9.4.1.3 User interface standards

All information users, whether expert or not, expect interfaces to be simple and intuitive. In addition to providing ready access to information, the interface should allow the user to combine information in various ways and to export data for other purposes. The information should be available in the most appropriate form – whether text, numeric, pictorial, video, sound or maps – and all information should be linked through a single interface to allow fast, interactive use.

9.4.2 Presentation of information

The technology to support the presentation of biodiversity and other environmental information is reasonably well developed and is still advancing rapidly today. It is currently possible to retrieve raw and processed data from virtually anywhere in the world, if not on-line then by various media through the post. It is also now possible to access modelling and analysis tools, even to run them on another agency's computer and to bring back the derived product(s).

Table 9.4-1: Data exchange standards of importance for biodiversity information.

- **Spatial data:** There are numerous standards being implemented or under development, e.g. US Geographic Data Committee – Spatial Data Transfer Standard.
- **Tabular data:** Structured Query Language (SQL) is a high-level, set-oriented, non-procedural database language for relational databases. SQL is an ISO/ANSI standard with the latest version commonly known as SQL92 (ISO 9075:1992/ANSI X3.135-1992). Most relational databases comply with this standard and many also include additional non-standard extensions to SQL92.
- **Taxonomic data:** Standards are enforced through formal publication within the procedures set by the International Codes of Zoological Nomenclature and Botanical Nomenclature.

The International Working Group on Taxonomic Data for the Plant Sciences (TDWG) is developing world-wide database information standards for plant taxonomy, while the International Organization for Plant Information (IOPI) is developing taxonomic checklists of the world's plants.

The International Committee on Taxonomy of Viruses (ICTV) is developing a standardized code for virus description, the foundation-stone for a world-wide universal virus database (ICTVdB) (Green and Croft 1994).

- **Descriptive data:** The DELTA (DEscriptive Language for Taxonomy) format was designed to satisfy the need for a generalized system capable of accommodating all the different kinds of descriptive data used by taxonomists, but in an easy-to-use format. The innovators of DELTA solved the problem of how to order and analyse data of different types. Official DELTA Internet archive sites have been set up at the CSIRO Division of Entomology, Canberra (spider.ento.csiro.au) and at the Muse biodiversity server at Cornell University, Ithaca, USA (muse.bio.cornell.edu/11/software/DELTA and muse.bio.cornell.edu).

Others have developed more restricted taxon-group-dependent expert systems. A number of these, however, use the DELTA format for exchange (see also Bisby 1993).

- **Genes and molecular biology:** Many molecular biology databases use the simple but effective criterion of publication in a refereed journal before records are accepted into a database (Green and Croft 1994).
- **Bibliographic:** The ISO 2709 is an international standard for bibliographic information interchange on magnetic tape. This Standard specifies the requirements for a generalized exchange format which will hold records describing all forms of material capable of bibliographic description, as well as related records such as authority records. Although this Standard is designed for magnetic tape, its structure may be used for other data carriers (ISO 1981).
- **Multimedia:** The Standard Generalized Marking Language (SGML) provides a powerful and flexible standard for formatting information for processing of all kinds. The SGML is emerging as a leading international standard for preparing both hypertext and multimedia material for publication. It can also be used for interchanging database records.
- **Software:** The ISO 9000 is a universal standard for development and maintenance of software. It includes a rigid set of conditions and a protocol to follow in software programming.

In general, then, it is not technology, but other factors – such as lack of agency co-ordination, poor data availability and quality, and lack of modelling or other analysis tools – that create obstacles to effective presentation of biodiversity information. To enhance presentation, those who disseminate information must consider carefully the format in which it will be presented. Different users of biodiversity information will find that information more or less accessible and valuable depending on its format. Selecting the most powerful format for your particular intended user is thus a critical first step.

9.4.2.1 Current issues in information presentation

One significant challenge is that of assessing the reliability

of a product that has been integrated from multiple data sources, such as a complex map overlay in a geographic information system. It is extremely difficult to assess, in a quantitative fashion, how errors in all the source data sets have been propagated in the final product. Most theoretical calculations show that error propagation is so severe that almost no confidence ought to be placed in the final product. This is obviously not particularly helpful in decision-making, and practical solutions need to be found. Part of the answer lies in attaching appropriate caveats to the derived product(s). Such caveats, however, are seldom welcomed by decision-makers, who prefer technical advice to be clear and unambiguous, even when lack of data and ecological understanding makes this difficult.

Recent developments in presentation tools such as three-dimensional image-processing technology and three-dimensional geographic information system modelling are at the forefront of research in meteorology, oceanography, hydrology, geology and ecology. These tools allow users to gain richer perspectives of data and their interrelationships by providing closer simulations of the 'real world'. Since environmental entities exist and interact in all dimensions, tools that assist the user visualize these will enhance understanding. For example, the ability to 'fly' down a valley and view vegetation patterns using video imagery can aid in the understanding of the influence of altitude on temperature and of slope and aspect on radiation and water distribution.

The increasing availability of digital elevation models has enabled ecologists to superimpose computer-classified land-cover types and actual and predicted distributions of individual species onto accurate representations of the land surface. It has then been relatively easy to quantify elevation ranges, aspects and areas occupied by various biological entities. Visualizing temporal changes in landscapes requires animating a time series of changes at each point. This is currently an active research area (Morain 1993).

9.4.2.2 Future needs

What is needed in the future is 'four-dimensional' modelling (including time) across landscapes and within vegetation canopies. However, neither the technology nor the necessary data are yet available. Unlike geological, atmospheric and oceanographic studies – where vertical profiles are standard attributes – ecological studies usually do not include vertical structure profiles (Morain 1993). Such modelling will help vegetation managers considerably in the future – whether conservationists or foresters.

Constraints to the implementation of existing technology include lack of basic computing infrastructure (such as stable electricity supplies, repair facilities and trained staff), inability to keep up with the pace of technological development, and the expense (both purchase and maintenance) of major software systems.

9.4.3 Information dissemination

The 'owner' of biodiversity information, along with any publisher, controls its dissemination, including timing, publication, distribution and proprietary rights. In addition, information owners have the ultimate ability to control its preservation and destruction. By and large, the issues arising from the rights and responsibilities of ownership are ethical, relating to appropriate conduct, rather than legal (Nash 1993) (see also 9.6).

Information owners, or custodians, often have legitimate concerns about how their information will be used. Will it be used for inappropriate analyses? Will any caveats on

data quality be responsibly considered? Will the proposed work pre-empt or duplicate the custodian's own efforts?

Despite these issues, the needs of biodiversity information users should be made a high priority. Consider, for example, the challenges facing a non-botanist in a developing country who wishes to identify an unknown plant of local economic potential. The country may not have a major herbarium, and there may be no plant taxonomists. All the significant collections may be in herbaria in North America or Europe. There may be no comprehensive plant checklists, let alone any plant collections. Even if such a checklist exists, it may be in an unfamiliar language, incomplete, with complex keys, highly technical descriptions, and inadequate illustrations. If, despite all odds, the user obtains a tentative identification, definitive confirmation against reference collections may be virtually impossible.

Yet the countries that have the greatest difficulties identifying their plants are often those with the highest species diversity and thus the greatest need. It is vitally important for these countries' future – and that of global biodiversity – that their biota be adequately identified, studied, protected and managed. Thus we must develop mechanisms that allow reasonable information control by custodians, yet at the same time promote maximum use of that information by those who need it most.

Conversely, those who are creating information systems must plan carefully for information dissemination as part of the process of implementing an information strategy. Whether provided through direct access, a third party, or distributed paper or electronic products, the information must be accessible, relevant to users, and understandable. Potential users must also know that the information is available.

Current methods of information dissemination take a wide variety of forms, which are summarized in Table 9.4-2. This variety is expected to increase in future.

9.4.3.1 Printed media

In the form of reports, tables, graphs, images and maps, printed materials will remain the major form of information communication for many years to come. Reproduction in large quantities through printing presses is relatively straightforward, though expensive (particularly for colour). Distribution procedures for books and journals are well developed. Cost can be an issue in many countries, particularly where currency exchange is difficult.

Printed material can be viewed almost anywhere without additional aids. Further analysis, through overlay of printed maps or extraction of numeric data from tables, is possible, though awkward and time consuming. Neither animation nor audio is, of course, possible. It is probably true to say that, despite the advent of computers and electronic networks, there is more paper circulating at present than at

Table 9.4-2: Characteristics of media for the distribution of data.

Medium	Application	Advantage	Disadvantage	Costs
Paper	Presentation of condensed data	No special tools needed	Restricted size of data set	Low for text, high for pictures
Disks	Presentation of condensed data	Easy to manipulate	Restricted size of data set, computer required	Low for disk, high for computer
CD-ROM	Customized access to large data sets	Interactive, easy to use	Computer required	Low for disk, high for computer
Electronic	On-line retrieval of frequently updated data	Huge volume, networkable	Searching can be complex; connection required	High for computer and network connection

any time in the past. Recent developments in other media are, however, making inroads on more traditional products as well as creating new market opportunities. One reason is that publication through print takes months or years, whereas electronic distribution can take place within hours.

9.4.3.2 Electronic media

Computer-based media are excellent for distributing large volumes of information in compact forms. These include storage media such as floppy disk, optical disk, CD-ROM and data cartridge. A major advantage is that very large volumes of data, in a wide variety of formats, can be stored on quite small objects. Laser videodisks, for example, can hold photographs of herbarium specimens, 35 mm slides of plants in their habitats, printed illustrations (including close-up illustrations of diagnostic features), distribution maps and other information. Storage capacities are so large that storage of many illustrations per species is feasible.

An advantage of CD-ROMs is that they are cheaper to produce than printed works, especially when many full-colour pictures are needed. Updates can also be readily produced and distributed. Easy distribution, with minimal mailing costs, ensures wide access. On the other hand, technologies such as computers and CD-ROM drives are required to access the information. Recent examples of 'publications' using these technologies include '*Beetle Larvae of the World*' by CSIRO in Australia. Another development in this area is the Expert Centre for Taxonomic Identification (ETI) in the Netherlands and their use of multimedia technology and innovative tools for identification and database storage in a custom-built program distributed on CD-ROM.

9.4.3.3 Networks

Information must be available not only to human eyes but also to computer-based tools used to analyse large complex data sets.

Systems such as Gopher and World Wide Web servers (see Table 9.3-1) accomplish two major objectives: first, they serve as ways of displaying significant documents, descriptions of current activities, organizational business, etc., and second, they serve as links to biodiversity and other information. Much of what is currently available on the network can basically be described as electronic copies of printed media. In some cases, such as the newly establishing 'electronic journals' (e.g. *Electronic Green Journal*), only the electronic form actually exists and a paper version is dispensed with completely. Among the many advantages of such publications is that, instead of needing to incorporate illustrations and other material from previous work, with all the administrative and technical overhead involved, links can be made directly, within the paper, to other 'published' sources. As navigation aids, these sources can provide a cohesive focal point for biodiversity information managers and analysts, helping to form a community that places people at the threshold of the information they need.

9.4.3.4 Microfilm and microfiche

In the past 25 years or so microform has been one of the main ways for libraries and organizations to store large quantities of documents. The main advantages of microform storage are:

- small space requirements;

- relatively cheap production and distribution of microform and microfiche, in particular; and
- recognized international standards which assure the quality and thus the longevity of the medium under the appropriate storage conditions.

The main disadvantage with the medium is user aversion. A microfiche reader is an essential tool to permit the information on the microform to be read as it cannot be read with the naked eye. Reader aversion to microforms is due to difficulties experienced in finding the correct pages as serial searching is required with microfilm or the seeming 'jumping around' in the case of microfiche. Thus, although not essential, a microform reader which can provide prints is highly desirable. Microforms are principally used for distribution of reports and learned journals.

9.4.3.5 Distribution channels

The distribution of the various kinds of information packages depends on the kind of information carrier. There are three main categories of distribution channels: printed material, computer media, and electronic network services.

The advantage of printed media, such as books, journals, reports and maps, is that they are portable and may be used anywhere at any time convenient to the user. This implies that there are mechanisms (advertising, product reviews, etc.) to inform the user of the availability of the information, how to order it and then to distribute it. This, traditionally the domain of professional publishers and retailers, has a long history of working reasonably well, but there is no guarantee that the potential market is fully supplied.

More recently, data and information have been distributed on electronic media such as diskettes, CD-ROMs, cartridge tapes and videodisk. Provided the technology to access these data is available – at a minimum a personal computer – this is also a reasonably flexible and comparatively low technology distribution channel.

Electronic network services promote the on-line accessibility of the very latest information. It is generally assumed that there is no widely available information that is more up-to-date. Access to this information, however, is conditional on establishing and maintaining some form of physical connection to a network node. In addition, developing and maintaining these network services requires technology and resources that are sometimes not available in developing countries.

9.4.4 Issues in electronic publishing

The advent of the World Wide Web makes network publishing a reality. The Web deals with 'hypermedia' (hypertext + multimedia). Documents are formatted, with embedded figures, as with traditional paper publications.

However, they have the added power of multimedia and of hypertext links to items anywhere in the world. This information can be text, images, animation, sound and data (Green and Croft 1994). For example, a reference in a document to the Convention on Biodiversity can be a direct link to the text of that document, located in a computer somewhere else on the network.

A major advantage of network publication is that material can be updated continuously and be instantly available to users in a transparent fashion. The current status can be assured through direct links or by 'mirroring', i.e. automatically downloading copies at frequent intervals (Green and Croft 1994).

The sheer variety of forms in which information can be transmitted around networks leads to challenges in quality control and appropriate attribution of credit for intellectual contributions. In the case of printed journals, well-established procedures of peer review are in place to try to maintain uniform high quality. If a contribution fails to meet appropriate standards, it is simply not published, at least until modified. Frustrated authors do have alternative avenues: non-refereed journals, private publishing and personal circulation, but these contributions are generally discounted by their peer community. Career advancement is often based on assessments of contributions to the peer-reviewed literature and citations of those contributions.

With the advent of World Wide Web and other network servers, anyone with a computer and a connection can make a contribution. Many of these contributions are proving invaluable in many fields, and a number of individuals are building well-deserved global reputations. There are so far, however, no mechanisms to authenticate or provide quality assessments of material thus made available. More formal recognition for contributions to network resources and infrastructure, particularly with respect to career advancement, is in very early stages of development.

9.5 Sources of biodiversity information

9.5.0 Introduction

In recent years there has been an explosion of effort by the world's communities, scientists, industries, governments and policy-makers to better understand, use and conserve biological diversity. However, much of the information on biodiversity remains in the domain of scientists. For example, much statistical data on species and habitats exists, yet it is largely scattered through research institutes, universities, zoos and botanical gardens, and not accessible in a form useful for policy-makers (see Section 8.4).

At the same time there have been significant shifts in environmental management policies, and parallel shifts in the requirement for environmental information. While much biodiversity information generated in the past was

descriptive, recent efforts in compiling biodiversity information also seek to address the conservation and sustainable use of biodiversity, integrating biological data with the ecological, social, economic and policy dimensions of biodiversity management.

For many countries, much of the existing information about plant and animal species is held in collections or databases located in other nations. If that information is already computerized, it is neither particularly difficult nor expensive to make copies available to the source country's research and management agencies – provided one can find it. A problem arises, however, when information is not available in electronic form and, particularly, when relevant plant and animal specimens are scattered throughout large collections around the world. Locating these specimens and computerizing the data that accompanies them is extremely time-consuming and expensive. In such situations, it is important to establish, as rapidly as possible, strategies and resources for obtaining the information needed.

As governments must now take action to ensure the conservation and sustainable use of biodiversity, policy-makers need significantly improved access to this information. At the same time, a broad range of other constituents need information about the distribution, health and policy relevance of the ecosystems in which they live, and of the elements that make up those systems. This chapter addresses some of the mechanisms by which this information can be located and retrieved (see also Section 8.4).

9.5.1 Libraries, bibliographies and bibliographic databases

Libraries are established with the express purpose of being information centres, and mechanisms and agreements are in place which facilitate the exchange of information on collections, and the searching for, and loan of, material. This is supported by the use of catalogues and indexes, and by bibliographies, bibliographic databases and abstracting services.

9.5.1.1 Libraries

When reviewing available sources of information, careful attention should be paid to *national collections* of both published and unpublished literature. National libraries are often the depository for copies of all works published in that country. In addition, some are charged with collecting all material published by a national whenever the work is published, and/or attempting to acquire all material published about the country.

Another key source will be the libraries of internationally operating organizations carrying out work relevant to biodiversity and its management. Many of these libraries are thematic, drawing material from sources right around the world; others are regional in their coverage. See 9.5.5 and Table 9.5-1.

Other types of organizations that may hold relevant collections of literature include:

Table 9.5-1: Selected libraries of international significance.

1. Asian Institute of Technology
2. BirdLife International
3. Consultative Group on International Agricultural Research
– Centre for International Forestry Research
– International Centre for Tropical Agriculture
– International Maize and Wheat Improvement Centre
– International Potato Centre
– International Plant Genetic Resources Institute
– International Laboratory for Research on Animal Diseases
– International Livestock Centre for Africa
4. Institute Français de Recherche Scientifique pour le Développement en Coopération
5. International Centre for Integrated Mountain Development
6. International Centre for Living Aquatic Resources Management
7. International Development Research Council
8. International Waterfowl and Wetlands Research Bureau
9. National Library of Agriculture (USA)
10. The Natural History Museum (UK)
11. Royal Botanic Gardens, Kew and Edinburgh (UK)
12. Smithsonian Institution (USA and Panama)
13. United Nations organizations
14. IUCN – The World Conservation Union

- government departments (such as forestry, agriculture, fisheries, environment, natural resources and tourism);
- universities and other seats of higher learning;
- research institutes, museums and botanic gardens;
- learned societies and professional associations; and
- non-government organizations.

Libraries the world over are experiencing financial constraints, and these pressures tend to focus activities such as collection building to meet the needs of the primary user

Box 9.5-1: On-line reference databases services.

There are a number of good on-line information sources available today. By far the largest commercial system available is DIALOG, which comprises more than 450 databases containing more than 330 million articles, abstracts and citations covering a variety of topics, with particular emphasis on news, business, science and technology. For example, DIALOG offers:

- the complete text of articles from more than 2500 journals, magazines and newsletters
- the complete text of more than 60 leading US and international newspapers, plus wire service stories from Knight-Ridder/Tribune Business News, PR Newswire, Business Wire, and Reuters;
- references to and abstracts of articles from more than 100 000 international publications on science and technology, social sciences and humanities;
- details on more than 15 million patents from 46 patent-issuing authorities worldwide, and
- data on more than 10 million chemical substances.

group, and foster networking and co-operation between libraries. In this context some libraries or parts of their collections are now referred to as 'information centres', 'resource centres' or 'documentation centres' where the emphasis is placed more on the information delivery than simply organizing and storing information.

9.5.1.2 Bibliography

Material relating to biodiversity can be found not only in the literature of the biological sciences and the related applied sciences (such as forestry, fisheries, agriculture, wildlife management and conservation biology), but also in literature related to economics, social sciences and even legislation. However, the terms 'biodiversity' and 'biological diversity' are relatively recent, and other concepts and key words also need to be used in searching for relevant literature.

Perhaps more than in most sciences, there is also a substantial body of knowledge and experience to be found in the 'grey' literature, for example, reports from consultancy groups, field workers, research workers and non-government organizations, and reports to government departments. Most of this knowledge is never formally published, and is often extremely difficult to trace, and thus obtain copies. Often the grey literature may be

Table 9.5-2: Selected on-line bibliographic services.

1. Abstracts on Tropical Agriculture (ORBIT)
2. Agricola (DIMDI, Data-Star/Dialog)
3. AGRIS International (Data-Star/Dialog, DIMDI, ESA-IRS)
4. Aquatic Sciences and Fisheries (Data-Star/Dialog, DIMDI)
5. Biological and Agricultural Index (BRS)
6. BIOSIS Previews (Data-Star/Dialog, DIMDI)
7. CAB Abstracts (Data-Star/Dialog, CAN/OLE, DIMDI)
8. GEOBASE (Data-Star/Dialog, ESA-IRS)
9. Life Sciences Collection (Data-Star/Dialog, STN International)
10. Microbial Information Network Europe (DIMDI, Deutsche Sammlung von Mikroorganismen und Zellkulturen GmbH)
11. Oceanic Abstracts (Data-Star/Dialog, STN, ESA-IRS)
12. Remote Sensing On-Line Retrieval Systems (ORBIT, ESA-IRS)
13. SciSearch (Data-Star/Dialog, DIMDI)
14. UBIB UNESCO Bibliography (ECHO)
15. Zoological Record On-Line (Data-Star/Dialog)

Note that a number of these are also available in published format.

prepared for a very limited audience and it may never be intended to be publically available. As a result, it can often be found only by talking to workers in the field, contacting relevant organizations, or in the reference lists of other publications.

9.5.1.3 Bibliographic databases

There are a number of specialist bibliographic databases on relevant subjects, some of which are available on-line (see Box 9.5-1). No single service covers all aspects of the subject and thus there is significant overlap between them. Emerging disciplines, such as economic valuation of biological resources, do not always sit comfortably in the

coverage of scientific databases, and are not adequately covered at present. See Table 9.5-2 for examples of available services.

9.5.1.4 Periodicals

The 32nd edition of *Ulrich's International Periodicals Directory 1993-94* (Bowker 1993) lists approximately 250 serial publications under the heading 'conservation' (although not all cover biodiversity conservation), and there are several other headings relevant to biodiversity. Further, this list selects only key learned journals. Many organizations produce newsletters with the aims of disseminating information to particular interest groups. For example, in the Asia region FAO produces *Tigerpaper* with information about conservation projects in the region. These can best be traced through references in the literature, knowledgeable individuals, or information centres familiar with the regions or topics concerned.

9.5.2 National biodiversity information centres

In a wide range of countries, the need to improve information management has already been appreciated, and databases and/or information centres have been established. Some of these centres are autonomous (such as the Conservation Data Centre of Bolivia), some are to be found within non government organizations (such as the Costa Rican Conservation Data Centre at the Fundación Neotropica), others are located within university departments (such as the database on species, habitats and protected areas at Mahidol University in Thailand), and others are managed under government auspices (such as the database on India's National Parks and Wildlife Sanctuaries managed by the Indian Institute of Public Administration). For another example see Box 9.5-2.

The aims and objectives of the centres range widely, with some centres concentrating on the distribution of species (such as the UK Biological Records Centre), while others concentrate on aspects of management and the impact of humans (such as the Indian database already mentioned). Working practices will also vary widely. Some, such as the Conservation Data Centres in Latin America have all the data collected on one site, while others, such as the Australian Environmental Resources Information Network are based on a distributed network approach (see Box 9.5-3). Yet whatever the objectives or approach, each of these information centres will have a significant body of information on the country in question, and access to an even greater body of information through its contacts both within the country and elsewhere.

In order to effectively implement the Convention on Biological Diversity, and in particular Article 6 which deals with the development of 'national strategies plans

Box 9.5-2: Indira Gandhi Conservation Monitoring Centre, India.

The Indira Gandhi Conservation Monitoring Centre (IGCMC) has been established by WWF India as a major national facility, with the full support of the Government of India, with a view to providing information support to government and non-government programmes for environmental conservation in the country. The objectives of IGCMC are to:

- maintain information on India's natural resources, especially its biological diversity (including indigenous plant and animal species, habitats of conservation importance, national parks and protected areas, and the trade in threatened species of wild flora and fauna);
- gather, store, retrieve and disseminate such information through a modern information management system;
- form collaborative links with other relevant natural resource organizations within India, including government research and survey institutions, universities and non-government organizations; and
- form collaborative links with other relevant organizations outside India.

and programmes for conservation and sustainable use of biological diversity', it is essential that there is a good information base from which to work. In order to assist in the implementation of this and other articles, UNEP is currently managing a project, supported by the Global Environment Facility, which will assist a number of countries in the development of their information management capability. Part of this project involves the preparation, by WCMC of a range of materials which will provide guidance and assistance to countries in the development of improved information management at the national level. In particular, the project is developing guidelines and standards for biodiversity data management, information on appropriate technologies, and know-how for the management and application of data and methods of accessing sources of biodiversity information and technology.

9.5.3 National biodiversity assessments

Heightened awareness of threats to biodiversity over recent decades has brought about increased efforts to take stock of what is at threat. Series of inventories of biodiversity and

Box 9.5-3: Environmental Resources Information Network, Australia.

ERIN was established in 1989 by the Australian Government and is part of the Federal Department of the Environment, Sport and Territories. ERIN is a national facility, with a goal to provide environmental information required for planning and decision-making. The information covers many aspects of the environment of the continent of Australia and adjacent maritime areas. It is drawn from many sources and includes maps, species distributions, documents and satellite imagery. Building such a broad information base has involved close and continuing co-operation and collaboration with research, government, industry and other sectors of the community.

The ERIN information bases were designed to answer questions crucial to the management and conservation of the Australian environment. These include:

- What is found in a particular region?
- Where is something (such as a type of management zone, an environmental resource or a rare species)?
- What kinds of environments exist and where are they found?
- How are these environments being managed?
- Is the environment changing and by how much?

and, the most difficult question of all:

- What will happen if ...?

The answers to these questions are urgently required by government, industry, researchers and community groups. Information is needed to contribute to the development of environmental policies and the assessment of development proposals. There is also a growing requirement to provide environmental information for education and regional land management purposes.

assessments of its status have been carried out in many countries and regions by international organizations, foreign assistance donors, international conservation groups, and local governments and NGOs (WRI/IUCN/UNEP 1992). These efforts to obtain an understanding of global and national biodiversity have grown to constitute a large yet generally uncoordinated source of biological information.

Nearly every country in the world has produced at least one national environment report (WRI/IIED/IUCN 1992), although the content of these reports varies widely from country to country. Some national reports touch on all aspects of a country's environment, providing only an overview of the environmental problems. Other more specialized environmental studies may cover particular sectors (such as forestry or biodiversity), looking in more depth into their status and the problems they face.

As the need for policy-relevant information has grown, these assessments have begun to take a broader approach which includes the integration of biological data with a wide range of other environmental information, coupled with policy analysis, the identification of policy options, and possibly a strategy or action plan with programme initiatives and implementation and monitoring procedures.

In recent years, several international programmes have provided consistent reporting on the state of countries' environments, with specific sector studies on forestry and biodiversity (see Table 9.5-3).

9.5.3.1 Country environmental profiles

These are broad introductions to the environmental issues within a country, offering basic references on the state of the environment, as well as indicating where urgent problems may lie and where future resources should be invested. They can help policy-makers identify opportunities for improving the environment and set priorities (Parker and Hope 1992).

Most of the programmes initiated to produce such profiles have been carried out by donor country governments to strengthen environmental considerations in their development assistance programmes (WRI/IIED/IUCN 1993). Some profiles are simply environmental synopses produced as desk studies which draw on published sources of information, others are considerably more consultative in their approach, involving extensive dialogue, research and review phases, and reaching consensus on an 'action agenda' to deal with the priority issues (WRI/IIED/IUCN 1993).

Generally, country profiles or national environmental reports include an analysis and description of the most important environmental issues, and an overview of the monitoring, research and administrative capacity of the countries to address environmental problems. However, as environmental profiles are usually broad environmental synopses, they are generally of limited use to decision-makers in terms of biodiversity. As the need for more information on biodiversity has grown, so too have programme efforts to provide such information.

9.5.3.2 Biodiversity assessments

Before policies, strategies and action plans could be developed to address biodiversity conservation, it became

obvious that a baseline understanding of the extent and magnitude of a country's biota was needed. Development assistance agencies and international organizations took the lead in initiating national reports on the state of biodiversity. Their aim was to feed the ever growing awareness of, and responsibility for addressing, the rapid depletion of the world's biological diversity.

National biodiversity assessments generally contain information on the laws and institutions affecting biological resources; the status and protection of endangered species; conservation efforts both within and outside protected areas; impacts of development projects; conservation facilities (such as seed banks, zoos, botanical gardens and sometimes micro-organism genetic resource collections); conservation of economically important species; major issues in biological diversity conservation; and recommendations and proposed activities (WRI/IIED/IUCN 1993).

Some biodiversity assessments have also been produced by agencies outside the country concerned, although usually for briefing purposes rather than as a definitive assessment. An example would be the profiles compiled by the World Conservation Monitoring Centre (WCMC), which can serve as easily accessible reference summaries (WRI/IIED/IUCN 1993).

9.5.3.3 UNEP country studies programme

The principal goal of this programme is to assist countries in assessing the status and value of their biological resources, and to show how countries can deploy this information as an input to the national biodiversity planning process required under the Convention on Biological Diversity. The revised guidelines (UNEP 1993) focus on the compilation of biological and economic data to reinforce the biodiversity planning process within countries, rather than on quantifying the unmet financial needs of nations to implement the articles of the Convention (which had been the primary orientation of the first tranche of studies).

Components of the revised Country Studies on biodiversity include (UNEP 1993):

- identification of components of biodiversity that are important for its conservation and sustainable use;
- collection and evaluation of data needed for the effective monitoring of the components of biodiversity;
- identification of processes and activities that threaten biodiversity;
- evaluation of the potential economic implications of the conservation and sustainable use of biological resources;

Table 9.5-3: Examples of organizations that have supported development of country environmental profiles and biodiversity assessments.

International organizations

1. IUCN – The World Conservation Union – Conservation of Forest Ecosystem Studies and national conservation strategies.
2. United Nations Conference on Environment and Development (UNCED) – encouraged the preparation of national reports (the development of many of the reports supported by UNEP).
3. United Nations Environment Programme (UNEP) – State of the Environments reports, and biodiversity country studies.
4. World Bank – Environmental issues papers (EIP) and national environmental action plans (NEAP).
5. World Conservation Monitoring Centre (WCMC) – national biodiversity profiles, and support to the UNEP biodiversity country studies programme.
6. Conservation International (CI) – promotion of Workshops for definition of Biodiversity Priority Areas at national and regional levels.

Bilateral aid agencies

7. Environmental Synopses supported by the United Kingdom (ODA), the European Commission and Australia (AIDAB).
8. Environmental Profiles supported by Denmark's Department of International Development Cooperation (DANIDA), the United States Agency for International Development (USAID), the Dutch Ministry of Foreign Affairs, and the Japanese Overseas Economic Cooperation Fund.
9. Environmental strategies supported by the Canadian International Development Agency (CIDA).
10. Tropical Forest and Biodiversity Assessments supported by USAID.

Compiled from WRI/IIED/IUCN (1992), and Olivieri (1995).

- determination of the economic values of biological and genetic resources, and
- assessment of priority actions for the conservation and sustainable use of biodiversity.

The Country Studies are a potentially useful step mechanism for integrating biological data with assessment of its value and the degree of threat to its integrity, linking this with the necessary policy-relevant information. The result will assist policy-makers in developing national strategies and action plans, and other programmes to better conserve their biodiversity. To date, 40 countries have either completed, are in the process of, or have expressed interest in producing a Country Study on Biodiversity.

9.5.4 Global and regional assessments

In addition to the various nationally focused efforts to report on biodiversity, there are numerous studies that present information on the status and trends of the global environment in general, and sectoral or thematic topics in particular. While these reports are not intended to be used for national environmental planning efforts, they often serve to inform policy-makers about the global trends and conditions that are relevant to the national situation. These reports have been instrumental in alerting the international community to global problems in the environment which ultimately necessitate concerted mitigation efforts at the national scale.

9.5.4.1 Global environment reports

Most of the globally focused reports contain relatively up-to-date analyses of environment and development issues. They also contain sets of indicators and data tables that can be used directly or help the user locate more information. Some, such as the World Resources Report and the World Development Report, provide statistical tables and time series on diskette (Table 9.5-4).

9.5.4.2 Thematic reviews

More frequent, and perhaps more useful than global reviews, are those that take particular themes (such as a particular habitat or species group) and review the status and distribution of that feature, and often the actions that need to be taken for its improved conservation or management. Because there are substantial numbers of such reviews, rather than try to list them in their entirety it seems sensible to provide some examples of several different types of review.

- The International Council for Bird Preservation (now BirdLife International) has reviewed the distributions of all bird species occupying an area of less than 50 000 km², identifying a series of 'endemic bird areas' where two or more restricted-range species are to be found (Bibby *et al.* 1992).
- Directories of wetlands have been compiled for various parts of the world by IWRB and IUCN working in close collaboration with a number of national and international organizations. Examples include Scott and Carbonell (1986), Scott (1988), Hughes and Hughes (1992) and Scott (1993).

- Different aspects of conservation legislation have been reviewed by a number of organizations and individuals. The results of much of this experience are summarized by de Klemm (1990) and de Klemm and Shine (1993).
- Tropical forest atlases have been produced for both the African and Southeast Asian regions, and will shortly be available for Latin America. These are compiled by WCMC and IUCN, again working in close collaboration with national and international agencies (Sayer *et al.* 1991, 1992).
- More in-depth studies of particular species groups, such as the study of forest bird communities in Hawaii (Scott *et al.* 1986), or on the ecology and conservation of grassland birds (Goriup 1988) have been published by various organizations.

9.5.4.3 Regional assessments

While national assessments and profiles can help to address priorities and needs *within* a country, regional assessments can help to place those priorities and needs in a wider context. For this reason a number of international and intergovernmental organizations have promoted the development of regional reviews or assessments covering, at one time or another, most regions of the world. There is a wide range of such reviews, so the following examples are necessarily only representative.

- Workshop 90, held in Manaus, Brazil, brought together a hundred scientists from 15 countries, all specialists on the biodiversity of the Amazon Basin. The workshop produced a map of priority areas representing the consensus of the scientific community, and had an important impact on the region. This approach of combining information compilation and synthesis with an expert workshop with broad participation, using a GIS as a tool for unifying and representing priorities, has been developed further since then and has been applied to other regions and countries including Papua New Guinea, the Atlantic Forest of Brazil and Madagascar.
- In the mid-1980s, UNEP commissioned IUCN to prepare protected area systems reviews covering both tropical Africa and Southeast Asia. The two reports (MacKinnon and MacKinnon 1987a, b), were based on detailed studies by consultants which involved regional meetings and travel to the countries covered, as well as using the database already compiled by IUCN/WCMC. Each study aimed to identify where the shortcomings in existing protected area systems were, and resulted in proposed action.
- In order to develop a sound basis for its policy on biodiversity conservation, USAID sponsored a

Table 9.5-4: Selected global environmental reports.

1. Boyle, T.J.B. and Boyle, C.E.B. (eds) 1994. *Biodiversity, Temperate Ecosystems and Global Change*. NATO ASI Series Advanced Science Institutes Series, SERS I, Vol. 20. Springer-Verlag, Berlin.
2. Brown, L.R. *et al.* 1994. *State of the World 1994*. W.W. Norton, New York.
3. Food and Agriculture Organization of the United Nations 1992. *State of Food and Agriculture*. FAO, Rome.
4. IUCN–The World Conservation Union, United Nations Environment Programme, World Wide Fund for Nature 1991. *Caring for the Earth: A strategy for sustainable living*. IUCN, Gland, Switzerland.
5. Norse, E.A. (ed.) 1993. *Global Marine Biological Diversity: A strategy for building conservation into decision making*. Island Press, Washington, DC.
6. Organization for Economic Co-operation and Development 1993. *State of the Environment*. OECD, Paris.
7. The World Bank 1994. *World Development Report 1994: Development and Environment*. Oxford University Press, Oxford.
8. United Nations Conference on Environment and Development 1992. *Nations of the Earth Report*, Vols. 1–3. UNCED, Geneva.
9. United Nations Environment Programme 1990. *State of the Marine Environment*. UNEP, Nairobi.
10. United Nations Environment Programme 1992. *State of the Environment: 1972–1992*. UNEP, Nairobi.
11. United Nations Environment Programme 1993. *Environmental Data Report 1993–1994*. Basil Blackwell, Oxford.
12. World Commission on Environment and Development 1987. *Our Common Future*. Oxford University Press, Oxford.
13. World Conservation Monitoring Centre 1992. *Global Biodiversity: Status of the Earth's living resources*. Chapman and Hall, London.
14. World Conservation Monitoring Centre 1994. *Biodiversity Data Sourcebook*. WCMC Biodiversity Series No. 1. WCMC, Cambridge.
15. World Resources Institute 1994. *The 1994 Information Please Environmental Almanac*. Houghton Mifflin, Boston.
16. World Resources Institute, IUCN–The World Conservation Union, and the United Nations Environment Programme 1992. *Global Biodiversity Strategy*. WRI, IUCN, UNEP, Washington, DC.
17. World Resources Institute, in collaboration with the United Nations Environment Programme and the United Nations Development Programme 1994. *World Resources 1994–1995*. Oxford University Press, Oxford.

process to define priority areas for biodiversity conservation within the Latin American and Caribbean Region. After compiling and analysing available information it culminated in a one-week workshop of regional experts during September 1994. The results included an assessment of the level of knowledge of biodiversity, and areas of high biological importance, and an analysis of the level of threat to biodiversity. The process was carried out by a consortium of institutions including Conservation International, The Nature Conservancy, World Resources Institute, World Wide Fund-US, and the Wildlife Conservation Society, co-ordinated by the Biodiversity Support Program.

- Information can also be compiled, and then used in conjunction with our understanding of the implications of different policy options, to assess the potential impact of those policies. See, for example, Bischoff and Jongman (1993) which looks at the potential impact of land-use choices in Europe.

9.5.5 Global, regional and thematic information centres

A major source of information can be those internationally operating organizations which, as part of their operations, either compile or improve access to information on a wide range of issues, and from a wide range of sources. These may be international organizations (such as the World Conservation Monitoring Centre), regional organizations (such as the European Environment Agency) or thematic in orientation (such as BirdLife International). Their primary orientation may be towards information (such as UNEP-INFOTERRA) or towards research (such as the CGIAR centres). Some selected centres are listed in Box 9.5-4.

Improvements in computer communications have allowed the rapid development of information services that can be accessed by substantially more people than ever before. Many of these international organizations listed in Box 9.5-4 have Internet facilities, but these do not yet provide access to most of the information they have available. Such capacities will develop over the years, in part driven by development of the 'Clearing

Box 9.5-4: Selected international information centres.

BirdLife International: BirdLife International is a federation of 360 member organizations in 100 countries. It is dedicated to saving the world's birds and their habitats. It conducts research into the status of and threats to birds throughout the world; works to protect endangered birds and promote public awareness of their ecological importance and lobbies policy-makers on issues relating to bird conservation. BirdLife International publishes various technical publications and monographs.

CAB International: CAB International is an intergovernmental organization which provides research information, and scientific and development services for agriculture, forestry and related disciplines throughout the world. It has the world's largest bibliographic database (CAB Abstracts) of relevant research and development publications. There are four constituent institutions: International Institute of Entomology; International Mycology Institute; International Institute of Biological Control; International Institute of Parasitology.

Consultative Group on International Agricultural Research: CGIAR consists of a consortium of donor countries, foundations and development banks, jointly sponsored by the World Bank, FAO and UNDP. Its establishment was motivated by international concern over the problems of genetic erosion in cultivated species and the loss of related wild species of flora. At present there are 13 International Agricultural Research Centres supported by the CGIAR. Most of these centres have specific responsibilities in crop varietal development and germplasm conservation. A few of these centres also serve as an international base for specific crops and actively collect on a world-wide basis. The collection efforts of the CGIAR network were initially focused on crop plants and were based on the economic importance of the crop, the quality of existing collections and the degree of threat to the crop.

European Environment Agency: EEA was conceived as a co-ordinating unit for a large decentralized network, providing the European Union and its member states with objective and reliable information and assessment on the state of the environment in Europe. In the first years of its operation, emphasis will be placed on providing information that can be used directly in environmental policy implementation. Such areas include: air quality and atmospheric emissions; water quality, pollutants and water resources; the state of soil, flora, fauna and biotopes; land use and natural resources; waste management; noise emissions; environmentally hazardous chemical substances; coastal protection. Various European organizations have already been appointed as 'topic centres' to coordinate information management in several of these sectors.

Food and Agriculture Organization of the United Nations: FAO carries a major programme for the agricultural community on behalf of governments and development agencies; collects, analyses and disseminates information; advises governments on policy planning; and provides opportunities for governments to meet and discuss food and agriculture problems. The major FAO units concerned with environmental and natural resource problems and issues are: the Interdepartmental Working Group on Environment and Sustainable Development; Forestry Department; Fisheries Department; Agriculture Department; and the regional commissions and technical committees.

International Council of Scientific Unions: CODATA is a scientific committee of ICSU, established to address data quality and utilization on an international level. CODATA was given several general objectives: to improve data quality and accessibility, as well as the collection, management and analysis methodology; to facilitate international co-operation among those collecting, managing and using data; and to promote an increased awareness in the scientific and technical community of the importance of these activities.

International Centre for Living Aquatic Resources Management: ICLARM conducts and fosters research and training in aquaculture, fisheries management and coastal area management. The Centre works to resolve critical technical and socio-ecological constraints to increased production, improved resource management, and equitable distribution of benefits. ICLARM publishes *Naga*, *The ICLARM Quarterly*; bibliographies; educational materials; technical reports; and conference proceedings.

International Institute for Applied Systems Analysis: IIASA's research efforts are primarily related to the development and use of scenarios and computer models. These activities include: environment; systems and decision sciences; technology, economy and society; and population. Data and information management are an integral part of model and scenario development, which are primarily in the areas of biosphere dynamics, trans-boundary air pollution, water resources, environmental monitoring and climate change.

Box 9.5-4 cont.

International Plant Genetic Resources Institute: IPGRI (formerly IBPGR) is an autonomous international scientific organization operating under the aegis of CGIAR. Its mandate is to advance the conservation and use of plant genetic resources for the benefit of present and future generations. IPGRI is expanding its information service to meet the needs of the plant genetic resources community. Existing services and databases held by other institutions already cater for many of these needs. Wherever appropriate, IPGRI refers users to such sources.

IUCN – The World Conservation Union: IUCN's mission is to provide knowledge and leadership for the sustainable use of natural resources. It provides leadership that can guide governments, aid agencies, non-governmental organizations and local communities investigating the causes of environmental change and degradation in different places, assessing the problems, and determining options for solutions. IUCN publishes authoritative reviews on conservation policy and on the status and urgent conservation needs of flora and fauna. It also publishes directories, handbooks, guides, reports and guideline documents on biodiversity conservation. IUCN's various expert groups include the Commission on National Parks and Protected Areas, the Environmental Law Centre and the Species Survival Commission.

UNEP Global Resource Information Database: GRID, part of the Global Environment Monitoring System (GEMS) network, aims to collect and disseminate the most advanced information available on the state of natural resources world-wide. In order to better collect, manage and disseminate data sets and other information, GRID has established a series of *nodes*. At the moment there are four nodes: Nairobi, Geneva, Bangkok and Arendal, Norway. The information GRID holds consists of processed geo-referenced data sets drawn from various sources, including the GEMS network.

UNEP International Environmental Information System: INFOTERRA was established by UNEP to identify and aid in the exchange of sources of environmental information and expertise. It was established as a decentralized world-wide network of information storage and dissemination facilities. These are primarily independent National Focal Centres (NFCs) whose activities are co-ordinated by the INFOTERRA Programme Activity Centre. Information is made readily available through a variety of means, including regular publications such as *International Directory of Sources* and the *World Directory of Environmental Expertise*.

United Nations Educational, Scientific and Cultural Organization: UNESCO was established 'for the purpose of advancing, through the educational, scientific and cultural relations of the peoples of the world, the objectives of international peace and the common welfare of mankind'. UNESCO has set up various forms of inter-governmental co-operation concerned with the environmental sciences and research on natural resources, with key programmes including the Man and the Biosphere Programme, the International Network of Biosphere Reserves and the World Heritage Convention.

United Nations Statistical Division: UNSTAT (formerly the United Nations Statistical Office) concentrates on developing economic methodologies. Two current projects involve the development of indicators for sustainable development and environmental accounting.

World Conservation Monitoring Centre (WCMC): WCMC provides information services to support the conservation and sustainable use of biological diversity, and also assists others in the development of their own information management systems. WCMC has particular experience in the management of information related to species, habitats, protected areas, and financial investment in biodiversity conservation.

House Mechanism' anticipated by the Convention on Biological Diversity (Box 9.5-5).

9.5.6 On-line sources of information

Organizations throughout the world are discovering the new opportunities provided by improved information technology and the development of communications networks. The use of discussion lists, on-line databases, virtual libraries and Special Interest Networks is

expanding rapidly. Examples of such developments in the field of biodiversity are the Australian Environmental Resources Information Network (see Box 9.5-3) (<http://kaos.erin.gov.au/erin.html>), the Biodiversity and Ecosystems Network (BENE) in the USA (<http://straylight.tamu.edu/bene/bene.html>), and the Base de Dados Tropical (BDT) in Brazil (<http://www.bdt.org.br>).

The growth of this medium is so rapid that it is difficult to keep abreast of developments, but there are

Box 9.5-5: Clearing house mechanism.

Article 18(3) of the Convention on Biological Diversity requires the establishment of a *clearing house mechanism to promote and facilitate technical and scientific co-operation*. The Interim Secretariat to the Convention has convened meetings to discuss the proposed mechanism, and to explore means by which the mechanism can provide access to information services, technical assistance and advice.

The principles for a successful co-operative clearing house are stated in the recommendations of the second session of the Open-ended Intergovernmental Meeting of Scientific Experts on Biological Diversity (UNEP/CBD/IC/2/11), which can be summarized as:

- an openly accessible electronic data network;
- a decentralized network of national and regional centres with central co-ordination;
- based as far as possible on existing institutions;
- based as far as possible on existing databases, information services, and networking services;
- driven by the needs of contracting parties; and
- small in the initial phase but with the capacity to be developed further.

At present a key thrust of discussion is towards mechanisms for facilitating information exchange, which must be based on a strategy which:

- reviews information needs for implementation of the Convention;
- identifies where those needs are already fulfilled, and where the gaps are;
- ensures effective dissemination of information from the existing information sources;
- ensures the co-ordinated use of existing information services; and
- develops a programme for meeting information needs not already satisfied by existing sources and services.

Information services that meet some of the needs of contracting parties either already exist, or could easily be developed from existing information sources. Initial implementation of the Clearing House Mechanism will need to recognize and use these facilities to improve the information available to contracting parties, both through computer networks and through more traditional means of information dissemination.

mechanisms for keeping up to date, ranging from mailing lists and newsgroups to metadatabases, virtual libraries and 'Special Interest Networks'. The Internet Services List by Scott Yanoff is a good overview list of Internet resources, and is regularly updated (<http://www.uwm.edu/Mirror/inet.services.html>). The InterNIC Directory and Database Services (<http://www.internic.net/ds/dspg01.html>) is also a good source for general Internet resources.

Without tools and methodologies for gathering, evaluating, managing and presenting the wealth of information through on-line means, most of this knowledge could be lost. New tools and different information networks and organizations are filling this niche, including Metadatabases (9.5.6.1), Virtual Libraries (9.5.6.2) and Special Interest Networks (9.5.6.3). However, these can be supplemented by a growing number of 'search engines' which locate information sources based on words provided by the searcher.

9.5.6.1 Metadatabases

Metadatabases, as defined earlier, provide information on what information is available where to a diverse set of users, using a structured description of the available data sets. Good examples of metadatabases are UNEP's GRID Database (<http://www.inpe.br/grid/home>), the Federal Geographic Data Committee (<http://fgdc.er.usgs.gov/>) and CIESIN (<http://www.ciesin.org/>).

The Global Resource Information Database (GRID) is a system of co-operating centres within the United Nations Environment Programme (UNEP) dedicated to making environmental information more readily accessible to environmental analysts as well as international and national decision-makers. Its mission is to provide timely and reliable geo-referenced environmental information. Besides acquiring and disseminating integrated, spatially-referenced environmental data, GRID provides decision-support services to environmental analysts and international and

national decision makers, and fosters the use of geographic information systems (GIS) and satellite image processing (IP) as tools for environmental analysis.

The US National Spatial Data Infrastructure (NSDI) encompasses policies, standards and procedures for organizations to co-operatively produce and share geospatial data. The US Federal Geographic Data Committee (FGDC) has assumed leadership in the evolution of the NSDI in co-operation with state and local governments, academia and the private sector. CIESIN, the Consortium for International Earth Science Information Network, specializes in the access and integration of physical, natural and socioeconomic information across scientific disciplines. Other major programmes with international data access roles include the US National Aeronautics and Space Administration (NASA) Global Change Master Directory and, in the UK, the Global Environmental Network for Information Exchange (GENIE). A number of major metadatabases are described in Table 9.5-5.

Many other agencies have set up co-ordinating centres providing links to more specialized information sources elsewhere. Examples on the World Wide Web include plant fossil records (<http://sunrae.uel.ac.uk/palaeo/pfr2/pfr.html>) and plant viruses (<http://life.anu.edu.au/.viruses/virus.html>). At the genetic level, Genbank – the database of all published nucleic acid sequences – is accessible through the Internet (fly.bio.indiana.edu/11/Genbank-Sequences), and entries can be found and retrieved by Accession Number, Description, Locus Name, Keywords, Source, Organism, Authors, and Title of the Journal Article.

9.5.6.2 Virtual libraries

A virtual library is an organized set of links to items (documents, software, images, databases) resident in different computers on the network. The purpose of a virtual library is to enable users to find information that exists elsewhere on the network from one central ('virtual') location. Virtual libraries (VL) are a natural growth of the ability of modern client-server protocols (especially HTTP and Gopher) to provide seamless links to information anywhere on the Internet.

The World Wide Web Consortium (<http://www.w3.org>) holds the WWW Virtual Library (<http://www.w3.org/hypertext/DataSources/bySubject/Overview.html>). This is a distributed subject catalogue and includes a list of virtual libraries in a number of fields including those of interest to biodiversity. Other examples are 'Biosciences' housed at Harvard University in the United States (<http://golgi.harvard.edu/biopages.html>), and 'Forestry' (<http://www.metla.fi/info/vlib/Forestry.html>), among many others.

9.5.6.3 Special interest networks

A Special Interest Network (SIN) is a group of people and/or institutions who collaborate to provide information about a particular subject. SINS consist of a series of participating 'nodes' that contribute to the network's functions (Green and Croft 1994). More specifically the nodes carry out one or more of the following tasks:

- accept and store relevant, contributed material;
- provide some form of public access for users;
- provide some unique information, or mirror other sites;
- provide organized links to other nodes; and
- co-ordinate their activity with other nodes.

For research activity, SINS are the modern equivalent of learned societies and perform such functions such as publication (journals, newsletters, data sets, software), library services (links to both on-site and off-site sources), communication (mailing lists, workshops and conferences), and other services (specialist advice, data analysis). A good example of a SIN is the European Molecular Biology Network (gopher.felix.embl-heidelberg.de). EMBNet is a special interest network that serves the European molecular biology and biotechnology research community. It consists of nodes operated by biologically orientated centres in different European countries. It features a number of services and activities, especially genomic databases.

Various projects are also putting into practice the SINS concept. FireNet (<http://online.anu.edu.au/Forestry/fire/firenet.html>), for example, is a SIN concerned with all aspects of landscape fires (Green *et al.* 1993) and the Biodiversity Information Network – BIN21 (<http://www.bdt.org.br/bin21/bin21.html>) was established to facilitate the access of all levels of information, from molecular to biosphere (Canhos *et al.* 1992). BIN21 is developing affiliations with and network links to organizations that are already carrying out related activities (Canhos *et al.* 1994).

9.5.7 CD-ROM and diskette

The distribution of information on CD-ROM has emerged as a major form of information exchange in recent years, a trend that is set to continue. This is mainly due to the enormous storage space offered by a single CD-ROM disk, which is quite adequate to store comprehensive collections of journal abstracts, whole learned scientific journals, books, encyclopaedias, and other information sources, which up until now have been distributed as on-line databases and printed text. See Table 9.5-6 for a list of selected CD-ROM products.

Table 9.5-5: Selected international metadatabases.

-
1. The *CIESIN Catalog Service* allows search and retrieval of metadata concerning the environment. Data available through the system will consist primarily of CIESIN holdings and the holdings of CIESIN's Information Co-operative partners and those that are referenced by the US NASA Global Change Master Directory.
 2. The *European Environment Agency* is the European Union body charged with harmonizing environmental data and distributing it to EU institutions, Member States and the public. Collecting and distributing knowledge about relevant sources of environmental data and information is to be done through a Catalogue of Datasources, based on collaboration mainly between the Agency, the National Focal Points of the Member States and a limited number of international organizations.
 3. The *IUCN Environmental Law Centre* monitors and maintains databases on legal trends and developments in the environmental field, including international agreements, binding instruments of international organizations, national legislation and legal literature.
 4. The *NASA Global Change Master Directory* includes information on a wide range of data sets relevant to the study of global change.
 5. The *Global Environmental Network Information Exchange (GENIE)* aims to allow those with knowledge of data holdings to make their knowledge available to other researchers. Although no single centre will hold all the information available in the system as a whole, GENIE will assist users to answer a variety of queries.
 6. The *Global Land Information System (GLIS)* is an interactive computer system developed by the US Geological Survey (USGS) for scientists seeking information and access to data pertaining to the Earth's land surface that can be used in continental and global scale Earth science and global change studies.
 7. The *International Referral System (IRS)*, later renamed The *Global Environmental Information Exchange Network or INFOTERRA*, was established in 1975 to 'facilitate the exchange of environmental information within and among nations'. It is under the auspices of UNEP.
 8. The *International Plant Genetic Resources Institute (IPGRI)* maintains a database on the known Directories of Germplasm Collections. These directories list the germplasm holdings of specific crops and food plants in institutes around the world. The information aids scientists in making contact with other workers involved in the same crop.
 9. *UNEP/GRID* was established in part to facilitate access to global and regional GIS data sets. GRID is developing a metadatabase of its data holdings.
 10. The *HEMDisk* produced by the UNEP Office of *Harmonization of Environmental Measurement (HEM)* is derived from three surveys to identify environmental monitoring agencies, particularly those with international scope, outlining their organizational objectives, the nature of the monitoring programmes, and providing a contact address.
 11. The *World Federation for Culture Collections (WFCC)* is a federation of the International Union of Microbiological Societies. One of its aims is to create a global network of information services charged with compiling and disseminating data on cultures. Another is to address practical questions such as the impact of postal regulations, quarantine rules, patent laws and public health concerns on culture distribution. Computerized Information Services operated by the Federation include the *Microbial Strain Data Network*, and publications include the *World Directory of Collections of Micro-organisms* and the *Living Resources for Biotechnology*.
 12. The *World Data Centres* were originally established to store information from ICSU's 1957 International Geophysical Year. Currently, 27 WDCs are active collecting, archiving and disseminating data which encompass most facets of the physical global environment.
-

As people's demand for information increases, CD-ROM has emerged as an excellent alternative to on-line access, video tapes and the printed word. Users can browse and search the database while familiarizing themselves with search techniques, without the pressure of mounting cost as occurs

with on-line access. Indeed, in some circumstances CD-ROM is now replacing on-line usage completely. However, while on-line databases normally have frequent updating schedules, updated CD-ROMs may not be released frequently or at all, causing them to become obsolete over time.

CD-ROMs are normally acquired for a one-time charge. This may give the user outright purchase or may be a type of lease agreement. As such they offer more budgetary control and no additional costs are incurred for frequent use. Thus if used frequently, the initial high cost can be recouped. In some cases, favourable charge rates may be offered to developing country customers.

Although many electronic information sources are now being shipped on CD-ROM, the large capacity of this medium is rarely used. In some cases, the information will fit onto a small number of diskettes which can be installed directly onto the hard disk of the user's computer. Provided the requisite hard disk space can be afforded, this solution has the advantage that access to the information is very

Table 9.5-6: Selected CD-ROM and diskette products with global or regional data sets related to biodiversity.

- **African Development Indicators** (Diskette). Published by World Bank. Statistical data for 242 indicators of development in 52 African countries. Indicators in two groups, economic and financial, social and environmental.
- **AgECONCD** (CD-ROM). Published by CAB International. Aspects of economics and policy related to agriculture, rural development, environment and forestry.
- **Agricola** (CD-ROM). Published by SilverPlatter. The National Agricultural Library database concentrates on agricultural subjects but includes related material such as ecology. The references are drawn from journals, books, theses, patents, audiovisual materials and technical reports. The CD corresponds to the printed product, *Bibliography of Agriculture*.
- **Agris** (CD-ROM). Supplied by SilverPlatter. FAO produces an on-line product by this name in addition to the CD-ROM and the printed product *Agrindex*. Centres in over 100 countries contribute. The coverage is primarily agricultural but relevant aspects include economics, development, forestry, aquatic sciences and fisheries and natural resources. The principal sources are books, journal articles and conference proceedings. Searchable in English, French, Spanish.
- **AGRISearch** (CD-ROM). Supplied by SilverPlatter. This product brings together five databases on research and development projects in agriculture food and nutrition:
 - CRIS produced by US Department of Agriculture describes projects within the Department and other agricultural, forestry and veterinary institutions.
 - ICAR produced by the Canadian Agricultural Research Council, a bilingual database of Canadian research projects.
 - AGREP produced by the European Commission, the Agricultural Research project database contains records of European research in agriculture, fisheries, food science and forestry.
 - ARRIP the Australian Rural Research in Progress database covers recent Australian research in agriculture, horticulture, forestry, fisheries, food technology and soil science.
 - SIS produced by the Special Program for African Agricultural Research, contains records for research in all areas of agriculture, with emphasis on the sustainable use and development of renewable natural resources.
- **AGROSTAT-PC** (Diskette). Supplied by FAO. Provides access to world-wide time series statistics on agricultural production and trade; land use and inputs; nutrition; forestry; and population. AGROSTAT-PC is designed to supplement FAO's print publications and to provide faster dissemination of data for longer time periods.
- **Antarctica - digital database** (CD-ROM). Available from British Antarctic Survey. The database is a seamless digital map of Antarctica with the most up-to-date and complete coastline of the continent from which maps can be generated and used as a topographic framework to provide a common base for spatial data. Requires PC ArcView, PC ARC/INFO, PC ArcCAD software.
- **Aquatic Sciences and Fisheries Abstracts (ASFA)** (CD-ROM). Published by SilverPlatter. A product of co-operation between UN agencies and national research centres which corresponds to three printed products – *Aquatic Sciences and Fisheries Abstracts*, *Biological Sciences and Living Resources* and *Ocean Technology Policy*, and *Non-Living Resources*. As the titles of the printed products imply the main subject areas covered are global developments in management of marine, freshwater and brackish water environments. The main sources are journal articles, books, conference proceedings and technical reports.

- **Biological and Agricultural Index** (CD-ROM). Published by H.W. Wilson. The CD-ROM corresponds to *Biological and Agricultural Index*, which comprehensively indexes over 200 key scientific journals. The main pertinent areas covered are: agriculture, biology, botany, ecology, entomology, fishery sciences, forestry, genetics and zoology.
- **Biological Abstracts/RRM on Compact Disc** (CD-ROM). Supplied by SilverPlatter. The corresponding printed product is the pre-eminent source of literature on biological subjects, *Biological Abstracts/RRM (Reports, Reviews, Meetings)*. As such its coverage includes agriculture, botany, ecology, environmental biology, forestry, genetics, systematic biology and zoology. The coverage is drawn from journals, books, papers from meetings and symposia, and reports. Reviews of books can be used to determine the relevance of sources for purchase.
- **CABCD (CAB Abstracts)** (CD-ROM). Supplied by SilverPlatter. In this form all the CAB Abstracts journals are included. The subject coverage is agriculture and forestry including economics. Separate CD services are produced on some topics e.g. *TREES-CD*, *PlantGene-CD* which cover much longer time periods.
- **Compact International Agricultural Research Library Basic Retrospective Set 1962-1986** (CD-ROM). Published by CGIAR. This bibliographic and reference database corresponds to the publications of International Agricultural Research Centres and includes full text, references, statistics and graphics. The main subject covered is forestry.
- **Directory of Country Environmental Studies** (Diskette). Available from World Resources Institute. The diskette corresponds to the printed document of the same name but includes material from both the 1993 and previous editions. The directory lists selected environmental and natural resource assessments, profiles and strategies for developing countries. These may relate to biodiversity, forestry and natural resources, land forms and use.
- **Earth Summit** (CD-ROM). Published by IDRC. All documentation relating to the United Nations Conference on Environment and Development is included. The documentation includes the texts of the conventions, Agenda 21, reports of NGOs, and documentation from the preparatory stages, such as the country reports.
- **Endangered and Threatened Species** (CD-ROM). Published by Quanta Press. This CD contains both text and images for all plants or animals listed in the US Endangered Species Act. The coverage also includes wildlife recovery programmes, status reports, scientific names and major programmes.
- **Families of Flowering Plants** (CD-ROM). Published by CSIRO, Australia. The CD is aimed at those attempting to identify and classify flowering plants. It uses an interactive program, INTKEY. For every level there are morphological descriptions. The CD includes comprehensive information on plant distribution.
- **Fish of the North-Eastern Atlantic and the Mediterranean** (CD-ROM). Published by UNESCO. For approximately 1500 species of fish, species name, habitat, distribution is given in full-text format with images where appropriate.
- **Fish and Fisheries Worldwide** (CD-ROM). Published by NISC. This product depends on information provided by the US Fish and Wildlife Service, JLB Smith Institute of Ichthyology and National Fisheries. The main aspects of interest are fish ecology, distribution and economic aspects.
- **FishBase** (CD-ROM). Published by ICLARM. This database includes information on all aspects of ichthyology and of fish as resources, e.g. nomenclature, distribution, ecology, reproduction, ecology, mortality.
- **GEOBASE** (CD-ROM). Published by Elsevier Science. This CDROM combines six printed sources on a family of disks. Three speciality subsets of the data are available on separate disks, two of which are relevant, i.e. Geography (human and physical geography including international development) and ECODISC, focusing on all ecological sciences. Material covered is drawn from journals, books and reports.
- **HEMDisk** (Diskette). Published by UNEP. The information on this diskette corresponds to three publications, i.e. *Directory of Organisations and Institutes Active in Environmental Monitoring*, *A Survey of Environmental Monitoring and Information Management Programmes of International Organizations* and *A Survey of Organizations and Laboratories Manufacturing Supplying or Using Reference Materials for Environmental Measurement*. The main access point in the printed publications is by institution name: in electronic format searching is greatly enhanced.

Table 9.5-6: Cont.

- **Index Kewensis** (CD-ROM). Published by Oxford University Press. The reference work is the most comprehensive registry of plant names, including family, genus and species. As the original publication and all 19 supplements are on one CD-ROM, searching is greatly enhanced.
- **Life Sciences Collection** (CD-ROM). Supplied by SilverPlatter. The CD product corresponds to 20 different abstracts journals whose coverage includes entomology, ecology and agriculture. The product is promoted to those looking for an interdisciplinary approach to the life sciences.
- **Multimedia Encyclopedia of Mammalian Biology** (CD-ROM). Published by McGraw-Hill. This corresponds to the 1990 edition of *Grzimeks Encyclopedia of Mammals*. In addition, it includes video and audio sequences which were mainly provided by the BBC Natural History Unit.
- **Natural Resources Metabase** (CD-ROM). Published by NISC. The database is compiled from more than 40 US and Canadian government databases. This compilation concentrates on the effects on natural resources (wetlands, Pacific islands, ecosystems, national parks, endangered species etc) of human actions and changes in natural phenomena primarily in the US, Canada and the Pacific.
- **Oceanographic and Marine Resources Vol. 2** (CD-ROM). Published by NISC. The bibliographic references cover selected material from 1807 to 1959 and are complete from 1960 to date. The relevant subject areas are marine resources, law and policy.
- **PlantGeneCD** (CD-ROM). Published by CAB International. This joint CAB International and International Board for Plant Genetic Resources product covers the literature of plant breeding and genetic resources. The main sources are journal articles, books, reports and conference proceedings.
- **PROSPECT (Programmed Retrieval of Species by the Property and End-use Classification of their Timbers)** (Diskette). Published by Oxford Forestry Institute. Primarily it is a database of wood properties which has been developed to support the requirements of those involved in forest management, timber conversion and utilization. Many of the data on over 1000 species are derived from the literature held in the Oxford Forestry Institute.
- **SESAME** (CD-ROM). Published by CIRAD. This bibliographic database covers French-language literature, although most entries have English titles added, on sub-tropical and tropical agriculture and rural development. Many of the approximately 150 000 references are unique to the source.
- **Smithsonian on Disc - Catalogue of the Smithsonian Institution Libraries on CD-ROM** (CD-ROM). Published by GK Hall. Some of the 16 libraries of the Smithsonian hold material very relevant to conservation of biological diversity. Although a US institution, its coverage extends far beyond national boundaries.
- **TREECD** (CD-ROM). Published by CAB International. This product, comprising one CD, corresponds to the abstracting service *Forestry Abstracts* since its inception in 1939 and includes all *Forest Products Abstracts* and *Agroforestry Abstracts*. In all over 300 000 abstracts are included.
- **TROPAG AND RURAL** (CD-ROM). Supplied by SilverPlatter. In printed form *Abstracts on Tropical Agriculture* and *Abstracts on Rural Development in the Tropics* cover the same ground. The subject area, as the name suggests, is literature about practical aspects of agriculture in tropical and subtropical regions and rural development including economic policy and planning, environment and natural resources. The product's strength is its coverage of these subjects in France and Francophone developing countries.
- **Wildlife Review and Fisheries Review** (CD-ROM). Published by NISC. As the name suggests, the printed products *Wildlife Review* and *Fisheries Review* form the basis for this CD-ROM, which covers international literature on mammals, birds, amphibia and reptiles, habitats, management techniques, natural history, hunting and propagation. Good taxonomic and geographic indexing helps searching. No Abstracts.

- **Wildlife Worldwide (National Information Services Corporation)** (CD-ROM). Published by NISC. The product corresponds to 'Wildlife Review', the indexing service produced by US Department of the Interior, National Biological Survey and on-line sources e.g. Waterfowl and Wetlands. The product covers the literature on mammals, birds, reptiles and amphibians. No abstracts of the literature are provided.
- **World Resources Data Base** (Diskette). Published by World Resources Institute. This source gives a substantially expanded version of the data in Part 4 of the printed volume of *World Resources*. One can browse or extract data with the aid of a number of mathematical or statistical functions from more than 500 variables (e.g. forests and rangeland, biodiversity, landcover, agriculture, number, species density, protected areas, trade, habitats) for almost 200 countries.
- **Zoological Record on Compact Disc** (CD-ROM). Supplier SilverPlatter, Microinfo. This product corresponds to the print one, *Zoological Record*, which concentrates on every major area of zoology with emphasis on animal biology. In addition to covering over 6000 international serials conference proceedings, books and reports are carefully screened for inclusion.

fast: CD-ROM drives are ideal for storing large amounts of data, but are currently slower than hard disks.

9.5.8 Directories of data sources

There is a range of directories, catalogues and indexes available to help in locating sources of information on species, habitats and genetic resources. For example, the directories of plant germplasm collections list the germplasm

holdings of specific crops and food plants in institutes around the world, including root and tuber crops, cereals, vegetables, industrial crops, tropical and subtropical fruits and tree nuts, temperate fruits and tree nuts and forages. The information in most of these directories serves to direct scientists and others requiring such information to more detailed sources of information, and assists them to make contact with other individuals working in the area of interest (see Table 9.5-7).

Table 9.5-7: Selected directories useful for biodiversity information.

1. Guarino, L., Rao, V.R. and Reid, R. (eds) 1995. *Collecting plant genetic diversity: Technical Guidelines*. CAB International, Wallingford, UK.
2. International Plant Genetic Resources Institute (IPGRI). *Directories of Germplasm Collections Series*. IPGRI, Rome.
3. Sugawara, H., Ma, J., Miyazaki, S., Shimura, J. and Takishima, Y. 1993. *World Directory of Collections of Cultures of Microorganisms*, 4th edn. WFCC World Data Center on Microorganisms, Saitama, Japan.
4. Directories of wetlands for various parts of the world prepared by IUCN and IWRB working with a range of other organizations.
5. Directories of protected areas for various parts of the world compiled by IUCN and WCMC, including the *UN List*, and *Protected Areas of the World: A review of national systems* (IUCN 1992).
6. *Coral Reefs of the World*, a three volume series prepared by IUCN and UNEP.
7. Tropical forest atlas series prepared by IUCN and WCMC, and published by MacMillan, London.
8. World Conservation Monitoring Centre 1993. *Ecologically Important Areas of Africa*. World Bank, Washington, DC.
9. World Conservation Monitoring Centre and Royal Botanic Gardens 1990. *World Plant Conservation Bibliography*. Royal Botanic Gardens, Kew and WCMC, Cambridge.
10. World Resources Institute, International Institute for Environment and Development, and IUCN 1992. *1993 Directory of Country Environmental Studies*. WRI, Washington, DC.

Table 9.5-8: Principal catalogues and indices of names of living species.**'Algae', including cyanobacteria**

- Dawson, E.Y. 1962. *New taxa of Benthic Green, Brown and Red Algae published since De Toni*. Beaudette Foundation, Santa Yuez, Calif.
- De Toni, J.B. 1889–1924. *Sylloge Algarum*. 6 vols. Pavia.
- Drouet, F. and Daily, W.A. 1956. *Revision of the coccoid Myxophyceae*. Botanical Studies from Butler University **12**: 1–218.
- Vanlangingham, S.L. 1967. *Catalogue of the Fossil and Recent Genera and Species of Diatoms and their Synonyms*. J. Cramer, Lehre and Vaduz.

Bacteria

- *International Journal of Systematic Bacteriology* 1980 on.
- Skerman, V.D.B., McGowan, V. and Sneath, P.H.A. 1989. *Approved Lists of Bacterial Names*. Amended edition. American Society for Microbiology, Washington, DC.

Bryophytes

- Bonner, C.E.B. 1962 on. *Index Hepaticarum*. J. Cramer, Weinheim.
- van der Wijk, R., Margadant, W.D. and Florschütz, P.A. 1959–69. *Index Muscorum*. Utrecht, Netherlands.

Flowering plants and ferns

- Christensen, C. 1906–65. *Index Filicum*. 5 vols. Hagerup, Copenhagen.
- Jarrett, F.M. (ed.) 1985. *Index Filicum Supplementum quintum pro annis 1961–75*. Clarendon Press, Oxford.
- *Index Kewensis* 1895 on. 2 vols., 18 supplements. Clarendon Press, Oxford.
- *Kew Index* 1986 on. [Annual.] Clarendon Press, Oxford.

Fungi

- Deighton, F.C. 1969. *A Supplement to Petrak's Lists 1920–1939*. [Index of Fungi Supplement.] CAB International, Wallingford.
- Hawksworth, D.L. 1972. *Lichens 1961–1969*. [Index of Fungi Supplement.] CAB International, Wallingford.
- *Index of Fungi* 1940 on. [Twice-yearly.] CAB International, Wallingford.
- Kirk, P.M. 1985. *Saccardo's Omissions*. [Index of Fungi Supplement.] CAB International, Wallingford.
- Lamb, I.M. 1963. *Index nominum lichenum inter annos 1932 et 1960 divulgatorum*. Ronald Press, New York.
- Petrak, F. 1930–44. *Verzeichnis der neuen Arten, Varietäten, Formen, Namen und wichtigsten Synonyme*. Just's botanischer Jahrbücher 48(3), 49(2), 56(2), 57(2), 58(1), 60(1), 63(2).
- Petrak, F. 1950. *Index of Fungi 1936–1939*. Commonwealth Mycological Institute, Kew.
- Saccardo, P.A. 1882–1931, 1972. *Sylloge fungorum*. 26 vols. Saccardo, Padua.
- Zahlbruckner, A. 1921–40. *Catalogus lichenum universalis*. 10 vols. Bornträger, Leipzig.

Viruses

- *Virus Identification Data Exchange (VIDE)*. CAB International, Wallingford.

Zoology

- Neave, S.A. (ed.) 1939–93. *Nomenclator Zoologicus*. 8 vols. Zoological Society of London, London.
- Sherborn, C.D. 1902–33. *Index Animalium*. 11 vols. British Museum (Natural History), London.
- *Zoological Record* 1864 on. [Issued in parts by group.] BIOSIS International, York.

9.5.8.1 *Species names/described species*

The main compilations of species names are given in Table 9.5-8. These comprise a mixture of catalogues (mostly from the last century) and on-going indices, although these do not exist for all groups of organisms. Detailed catalogues for particular groups are also published occasionally.

Those describing new species are under no obligation to register the names of those species with any authority (with the exception of bacteria). The International Registration Authorities for the 'cultivar' names of cultivated plants operate only as a voluntary system, and no authorities exist at all for many genera. However, registration has been approved in principle from the year 2000 onwards, as a requirement for all names in botanical groups, with details of mechanisms to be drawn up by the International Association for Plant Taxonomy. The concept is also under discussion for animal species (Hawksworth *et al.* 1994). Whether or not registration systems can be realized will depend upon appropriate international funding becoming available.

The current compilations of names, and also registers of names, are nomenclatural devices rather than a continuously updated list of scientifically accepted species with the "correct" name. It is such global master species databases that are the real need of those involved in the inventorying, description, communication and regulation of biodiversity and its uses. This type of information does exist for many groups, but is uncoordinated and scattered though a variety of databases based in different countries (Bisby 1993). With advances in computing and communications technology, it is now technically feasible to consider collating the many existing data sets, so as to provide access to accepted species databases covering all groups of organisms.

That such a major compilation could now be achievable is indicated by two recent events. First, the production of a list of 28 041 generic names for non-fossil botanical groups prepared with the help of over 200 plant taxonomists (Greuter *et al.* 1993), and second the establishment of a mechanism to produce a list of the accepted species of the world's vascular plants (Burnett 1994). In recognition of the international need for a global synthesis of the organisms now known, the 1994 IUBS General Assembly unanimously agreed to include the production of a global master species database in its scientific programme for 1994–97. Funding for this is now being sought.

9.6 Legal aspects of information management

9.6.0 Introduction

As the introduction to this Section describes, several international agreements impose obligations on governments and private organizations in the area of biodiversity information management and communication. In addition,

international law has limited what public and private organizations can do with such information. The goal of this chapter is to describe the major sources of international law as well as some of the principal legal issues associated with biodiversity information management.

The topic is simultaneously narrow and broad. It is narrow in the sense that legal aspects of biodiversity information management relate primarily to the evolving intellectual property regime for numerical data and published information, both in hard-copy and digital electronic formats. At the same time, biodiversity information is inextricably linked to many other kinds of activities and issues, including technology transfer, natural resource management and trade, remote sensing and telecommunications, and national security. Thus, while the following discussion focuses specifically on law pertaining to global biodiversity information, references are made to related, yet directly relevant, legal regimes and issues.

9.6.1 Sources of international law

International law has both public and private dimensions. The public domain (9.6.1.1) regulates the activities and relationships of nation states and intergovernmental organizations. Within the context of public law, private law (9.6.1.2) controls the activities and relationships of individuals, corporations and nongovernmental organizations.

9.6.1.1 Public law

The sources of public international law are, in descending order of priority: international conventions, international custom, general principles of law, and judicial decisions and teachings of the most highly qualified publicists (International Court of Justice Statute 1948). The two most important of these are described below.

International conventions. Like private contracts, treaties – or international conventions – are not sources of law, but sources of rights and obligations of the signatory parties (Fitzmaurice 1958). However, because they constitute the most binding form of legal instrument, they are looked to first in the resolution of disputes among nation states.

The treaties that are most directly relevant to biodiversity information management are the Convention on Biological Diversity, particularly Articles 15, 16, 19, 20 and 21 (UNEP 1992), and the existing system of international intellectual property law, which is composed of several treaties that provide nations with legal mechanisms for protecting, under their own laws, each others' copyrighted works and similar materials. The treaty that is most applicable to the legal protection and control of biodiversity information is the Berne Convention for the Protection of Literary and Artistic Works (Berne Convention 1886), which, as of mid-1994, had 105 members (IITF 1994). The intergovernmental

organization responsible for administering this convention and other agreements regarding intellectual property is the World Intellectual Property Organization (WIPO). While traditional copyright and patent laws do not apply to numerical databases of the kind discussed in this section, the subsidiary forms of legal protection for databases are discussed below.

There are several additional treaties relevant to biodiversity information management. These include the United Nations Charter (UN 1948), which provides the broad institutional and legal context within which the Convention on Biological Diversity is framed, and the Uruguay Round of the General Agreement on Trade and Tariffs (GATT 1993), the principal legal forum for resolving trade disputes, including those concerning biological resources. The Convention on International Trade in Endangered Species (CITES 1973), the major international agreement prohibiting trade in endangered species, is also relevant as it requires national governments to collect, manage and communicate biodiversity information in a certain prescribed way.

In addition to treaties, executive agreements – also referred to as Memoranda of Understanding (MOUs) – between the government agencies of two or more nations, are an important source of specific rights and obligations. Although these agreements do not have the legal binding force of treaties (not a universally held view), they do reflect high-level policy decisions of their participants' executive branches. In the area of biodiversity information management, MOUs will primarily define the scope and content of specific bilateral relationships. The aggregation of these agreements will ultimately be the most important source of what is known as international custom.

International custom. International custom derives from the general practices of nation states accepted as law (International Court of Justice Statute 1948). Evidence of the general practice of states may be found in MOUs, the consistent and repetitive behaviour of states, and the official acts of states, including the promulgation of national laws. Most nations, for example, have environmental and natural resource laws and regulations that seek to balance competing interests such as environmental protection, economic exploitation, public health and safety, and national security. Together, these national laws contribute to the evolution of international custom.

As formal intergovernmental organizations have proliferated in the latter half of this century, there has been a tendency to accord similar legal status to the behaviour and official acts of these organizations – a significant factor with respect to biodiversity information. For example, there have been a number of relevant UN General Assembly Resolutions since the early 1970s (see, *inter alia*, the Stockholm Declaration, 1972; the World Charter for Nature, 1982; the Rio Declaration, 1992; Agenda 21, 1992;

and the UNEP Forest Principles, 1992). Although these resolutions are not legally binding, they reflect an emerging global environmental ethic and incipient international environmental law that, over time, will likely achieve the status of customary international law (see Tinker 1990).

A large body of customary law has developed around the subject of intellectual property (although, as noted above, copyright and patent provisions generally apply to information but not numerical data). While the foundation international agreement on intellectual property – the 1886 Berne Convention – has existed for more than 100 years, nations have interpreted it quite differently, and individual approaches continue to evolve rapidly today (see Stewart 1989). A notable example of such differences is the fact that information produced by the United States Government is not subject to copyright, whereas copyright provisions usually apply to the information published by most other governments. Moreover, the rapid rise in the use of national and international electronic networks has raised new issues regarding the legal protection of digital data and information (IITF 1994), which are likely to require changes to the Berne Convention and other intellectual property agreements under the WIPO umbrella.

Numerical databases present a special challenge. The huge increase in the amount of observational environmental data – brought about by highly sophisticated sensing instruments and facilitated by continuous advances in computer and communication technologies – has created pressure to develop and harmonize new legal constructs for their effective management. As in the case of environmental law, a number of competing interests have made this difficult. On the one hand, the public interest in encouraging the broadest possible access to information on biodiversity and other environmental problems has led to the treatment of numerical databases as public goods, unencumbered by legal restrictions on their dissemination and use. Within the scientific research community, it has been customary to openly share many types of geophysical data, although this tradition has not been as strong in ecological research. In addition, many environmental treaties have provisions for the open exchange of scientific data, including environmental satellite data (see Uhler 1986).

On the other hand, businesses and certain government agencies have contrary interests – driven by commercial opportunities or national security – regarding the sharing of numerical databases. Commercial data have generally been protected through private, contractual licensing and 'trade secrecy' provisions while governments have applied national security laws with severe penalties to restrict dissemination of certain types of data, sometimes for spurious reasons. An important development in the economic protection of data is the European Union's proposed Directive on Legal Protection of Databases (EC 1992) – discussed

further below – which would provide a legal framework for the economic exploitation of numerical databases within Europe.

Customary law that has arisen in the area of international trade will also be an important source of law regarding business aspects of biodiversity data and information. Although the General Agreement on Tariffs and Trade (GATT) provides the principal dispute-resolution mechanism for the nations that are party to it, most of them have separate bilateral or regional trade agreements regulating specific commercial transactions, including those involving biodiversity resources and related data and information.

9.6.1.2 Private law

Much of the research that will generate biodiversity information in the future will be conducted by private-sector parties, including researchers employed by private universities, corporations, and not-for-profit, non-governmental organizations. These parties will also in many cases become the custodians or owners of that information and will control its access and distribution.

How private parties manage biodiversity information will be determined in part by the public laws outlined above as well as by private contracts. Disputes among these parties are generally settled in formal legal proceedings. These proceedings will eventually result in a body of legal precedents spanning multiple jurisdictions.

Although each private contract regarding biodiversity information will apply only to its signatory parties, some particularly innovative contracts are likely to serve as models. One such agreement, between Merck & Company, Inc. and Costa Rica's Instituto Nacional de Biodiversidad (INBio) (Merck 1991), is already considered a potential model for how the biotechnology industry and nations with diverse biological resources might co-operate under the framework of the Convention on Biological Diversity (see Joyce 1991). Signed in 1991, the agreement requires Merck to provide US\$1 million to INBio and meet other specific conditions in exchange for exclusive rights to screen for potential pharmaceuticals certain, specific taxonomic groups of plants, insects, and other organisms collected by INBio researchers. Over time, such contracts as well as adjudicated disputes should generate a worldwide body of evidence of customary practices in the private sector.

9.6.2 Major legal issues

To summarize all the major legal issues surrounding biodiversity information management in all the world's jurisdictions would be futile. Instead, this section will discuss relevant legal principles in as general terms as possible. Frequent reference is made to United States laws, while pointing out distinctions with major international trends.

9.6.2.1 Intellectual property rights

The law of intellectual property is designed to protect the legitimate rights of those who produce original works, thereby providing incentives for that work. Copyright, patent and trademark are the primary formal mechanisms within this body of law.

Copyright requires very little in terms of formal legal requirements. However, a recent US Supreme Court case shows that, in the United States, the requirements that copyrighted work be original and involve the creative process are strictly construed (*Feist Publications v. Rural Telephone*). The case is particularly pertinent to computer databases, where the elements of originality and creativity tend to be minimal. In addition, the so-called 'Idea Expression' merger doctrine of US copyright law – which holds that if the expression is the same as the physical fact, then no original expression is made and the work cannot be copyrighted (*Mason v. Montgomery Data*) – will play an important role in assessing the eligibility for copyright protection of biodiversity databases, at least in the United States.

In the European Union, a 'right to prevent unfair extraction' has been advocated in a directive on the legal protection of databases. The directive defines this unfair extraction right as the 'right of the maker of the database to prevent acts of extraction and reutilization of material from the database for commercial purposes'. The US Register of Copyrights has indicated that a similar right of extraction might be considered in that country.

Patents traditionally have been used to protect property rights related to devices or machines. Today, however, computer software has blurred the distinction between machines and information, and patents as well as copyright are now used to protect certain aspects of computer software. Information and software are often difficult to separate, either because data are formatted such that practical access depends on the use of particular software or because they are included with the software. This means that those seeking access to – or seeking protection of their rights to – biodiversity information may have to deal with both patent and copyright law today.

Where patent and copyright protection is either not available or impractical, contracts may be used to secure property rights to data. Contracts relating to computer software or data, usually referred to as licences, establish such terms as cost and restrictions on redistribution. The important distinction between a licence and copyright is that the latter arises automatically and applies to any party, while the former must be created by contract and applies only to the parties to that contract.

The emergence of wide-area computer networks has introduced many still-unanswered legal questions with respect to information access. Computer networks – in particular, global computer networks – have increased the

fluidity and accessibility of data by orders of magnitude. This has made protecting legitimate property rights far more difficult from a technical point of view. In addition, the choice of intellectual property law among the world's hundreds of jurisdictions portend as a legal morass. While the basic legal principles underlying licences, copyright and patents are likely to remain unchanged, applying and enforcing these principles will have to meet new challenges.

9.6.2.2 Freedom of information and public databases

The rules that govern access to public information are often different from those governing private information. As noted above, government information is generally viewed as belonging to all citizens as a public good. In many countries, open records or freedom of information laws permit public access to government information for a nominal cost. Such laws are based on the premise that access to information is necessary for citizens to make governments accountable for their actions. Thus any barriers to information access, including the charging of fees, are viewed with the suspicion that they are being used by government to operate 'behind closed doors'.

While access to information is generally important to biodiversity conservation and management, there may be some exceptions. If the precise location of an endangered species is available to the general public, for example, that species could be placed at risk, and some restrictions on open access may be required.

In countries such as the United States, Canada, Australia and New Zealand, access to governmental information is governed by statute. One example is the US Freedom of Information Act (FOIA), which provides that the final opinions, policy, and any records reasonably described shall be disclosable to the public, subject to such exemptions as matters of national defence, commercial trade secrets, and personnel and medical information.

Although many national governments feel free to charge fees for public access to government information, FOIA allows agencies to charge only for the cost of search and review. However, because information is increasingly being regarded as a commodity with value, some experts argue that even public information should be paid for according to its value and that such payments can be made without compromising the principle of keeping government accountable. They say that it is the prohibition of information access, and not the charging of reasonable fees for that information, that poses a danger to democracy.

9.6.2.3 Privacy

The pervasiveness of computerized information has generated considerable concern for privacy. Although biodiversity information would seem to pose less of a

threat than that directly related to people, the breadth of information needed for biodiversity conservation and management means that privacy conflicts are bound to arise. Many corporations and individuals, for example, may resist the collection of information by outsiders on private land, yet collecting such information may be essential to the effective management of biodiversity found there and therefore be required by law.

In the United States, privacy statutes have emphasized access to government information by the individual in order to ensure that inaccurate, and therefore potentially damaging, information can be corrected. Statutes have also limited the mixing and matching of information among agencies to protect against unanticipated use of personal information by the government. When a conflict between FOIA and privacy occurs, the law has consistently favoured disclosure over nondisclosure.

US privacy laws applicable to the private sector primarily concern the practices of financial credit reporting companies, so that even the relatively limited protection with regard to public data are not present in the private sector. In contrast, the European Union does not differentiate between the private and public sectors, but provides universal standards to control the dissemination and matching of information (Anderson 1992).

9.6.2.4 Liability

In any enterprise – including information management – legal liability can be a concern to participants. Liability arising from contracts or the licensing of information is relatively obvious as exposure is limited to the parties and terms of the contract. The law of negligence or intentional wrongdoing, referred to as tort law, includes liability for negligent or intentional misrepresentation. Defamation or libel can also result from the tortious use of 'information'. Private disseminators are generally subject to these rules of law.

With regard to public information, state courts in the United States in general have been reluctant to impose liability on government agencies when erroneous information has damaged a citizen, although courts in some states have nevertheless done so. At the US federal level, the Federal Tort Claims Act specifically exempts federal agencies from liability for misinformation.

In the United States and other common law jurisdictions, tort law is based mainly on common sense and logic. If the circumstances under which a government agency or private party provides information to a person creates a reasonable expectation of reliability – and that person relies on the information and is harmed – it is likely that a legal remedy for the injury can be found. Whether or not liability can be avoided, those who disseminate information should always be sure to notify potential users of its limitations.

9.6.2.5 Authentication and admissibility of data

Although law is often thought of as lagging behind technological developments, a number of courts in the United States have recognized the admissibility of electronic documents in official legal proceedings. Because the requirements for admissibility are the same as those for hard-copy materials, it has generally not been necessary to pass new legislation to accommodate electronic materials (Weiss 1994).

Documents – both hard-copy and electronic – are generally admissible if they can be shown to be reliable and what the litigant purports them to be. To be sure, this requirement creates some difficulties given the comparatively ephemeral character of electronic information. In US law, a common requirement for the admissibility of electronic documents is that of demonstrating that the documents are used in the regular course of business and are therefore reliable. Meeting this and other criteria for admissibility underscores the importance of sound information management.

9.7 Institutional capacity development

9.7.0 Introduction

While there is no question that nations must develop the capacity to manage and communicate biodiversity information, there is no universal model that demonstrates how to do this. Every country faces a unique situation, and national planners must devise their own individual strategies based on these conditions. Starting from this premise, this chapter will discuss some of the issues decision-makers should consider when developing an information management strategy, no matter what model they have adopted.

The obvious first step is to look at what in-country institutions already do in this area. Institutions that manage biodiversity or other relevant data are likely to be one of two types: data centres whose activities are determined by the demands of specific users (a census bureau would be one example) or more-thematic, data-generating institutions committed to long-term goals (such as national meteorological or regional development agencies) whose data would be valuable to a wide range of users. Planners of information management systems must be aware of all these institutions – found throughout government, nongovernment and private sectors – and devise a strategy that co-ordinates their unique contributions. To facilitate co-ordination and the exchange of information, a central co-ordinating body should be identified. This body will have access to, and knowledge about, information held throughout the national network, but will generally leave control of information to the individual custodian institutions.

The following describes some issues that experience has shown should be considered when developing a national information management strategy. Those issues are: information needs and information resources available (9.7.1), institutional capacity (9.7.2), technology selection (9.7.3), human resources and training (9.7.4), and financing (9.7.5).

9.7.1 Information needs and information resources available

The most critical step in designing an information management strategy is to define clearly who the intended users are and what their specific information needs will be. Too often this step is overlooked or not well defined. The result can be that inappropriate information is collected while other, more relevant information is not collected, or that information is collected at scales either too detailed or too general for use by the intended audience. This does not imply that the collection of basic information without immediate uses is always inappropriate. Indeed, many major advances in knowledge come about in this way. However, given limited resources, priorities in information collection and management must be set at the outset.

Another major consideration is defining what information resources are actually available or easy to develop. In many parts of the world, very little detailed information actually exists about biological resources. Even the most basic information about which species are present and how they are distributed is often lacking or very patchy. Information about the genetic or ecosystem levels of biodiversity is even less well developed. Thus, along with defining the information that users may desire, there is the need to define what information is already available or open to collection in a cost-effective manner.

A significant challenge in defining information needs is that many prospective users are unaware of the range of possibilities and therefore have trouble articulating their needs. Conversely, they may be unaware of the technical limitations or costs – both direct and indirect – of developing certain types of information. To define accurately what types of information users desire or need, and what types of information are available or can be developed, an interactive, consultative process is necessary. Such a process serves to educate users about the different possibilities available, while simultaneously seeking to identify which of them are of greatest interest, applicability and ‘do-ability’.

Along with defining information needs and availability, it is also important to identify data-sharing possibilities. To the extent possible, information management strategies should seek to adopt standards that will facilitate information sharing (9.2.4), although the degree to which information actually will be shared depends upon many factors of a technical, institutional and policy nature.

Making use of standards that hold this option open, however, is highly desirable, particularly in light of recent advances in electronic communications and global collaboration.

9.7.2 Institutional capacity

While the network model of a national information management strategy relies on a diversity of specialized institutions, the effectiveness of the network as a whole depends on the quality of its components. Careful and honest consideration of institutional capacity is therefore a key to any successful national information management effort.

Long-term institutional support for information management efforts normally occurs only if the institution has a vested interest in the effort. Does the institution have a clear mission, and is this mission appropriate for or dependent upon the data management effort (i.e. is it either a producer or user of biodiversity information)? How will such an effort fit into both the strategic objectives of the institution and its operational plans? While information management can produce short-term results, ideally it should be carried out in a long-term context; this raises the question, is the institution stable or is it subject to abrupt changes or elimination altogether? Adequate financing is another, obvious ingredient in creating a strong and sustained information management system (9.7.5); does the institution have the authority to secure the resources necessary to develop and maintain its information management system?

Because most biodiversity information efforts will require extensive collaboration among individual researchers and institutions, the ability to co-operate with like institutions (both at home and abroad), and with institutions in other sectors, is critical. Related to this, it is important to avoid or minimize duplication of effort with other institutions, seeking instead to establish unique and complementary roles.

9.7.3 Technology selection: a double-edged sword

Sound information management principles are technology-independent. Over the past few decades, the increasing availability and power of electronic data processing has made the popular image of information management virtually synonymous with use of computers. Computers can, of course, greatly increase the speed and efficiency of information management tasks. However, virtually all the basic functions that a computer performs, can also be done manually, albeit more laboriously. The basic principles that govern biodiversity information management can be, and often are, successfully employed with non-electronic technologies. Indeed, such non-electronic devices as filing cabinets, libraries, card catalogues and paper maps still form the basis for much if not most information management throughout the world.

Computers and the applications they support – especially database management tools and geographic information systems – will continue to play an increasingly important role in the management, retrieval, analysis and dissemination of biodiversity information. However, it is imperative that the technology selected for any particular information management effort be appropriate to the needs of that effort and be sustainable given the institutional, human and financial resources available. The questions posed and information needs identified should define the technology selected, rather than vice versa. Sadly, far too many information management efforts start the other way – with technology in search of a question to answer, the proverbial tail wagging the dog.

Key issues to consider in the selection of appropriate technologies are initial and recurrent costs, operation and maintenance viability, flexibility and growth potential, and potential for technological dependency. Actual costs of operating sophisticated database and GIS systems are often grossly underestimated in programme planning. Typically, project planners focus on the initial hardware and software acquisition cost and do not adequately plan for the costs associated with training, operation, maintenance and, especially, data development.

Beyond cost, the viability of operating and maintaining a given technology in the place where it will be used is also critical. For example, are the necessary electrical and telephone systems (needed for access to most national and international computer networks) available and reliable? Will the components of a system operate as expected in the new working environment? (Cost and frequency of repair information, for example, is generally valid only in specific places.) If any components of the system do need repair, can those repairs be made in-country, or must the machinery be sent abroad (resulting in considerable expense and inconvenience)? To avoid the latter problem, information managers should, whenever possible, choose less specialized equipment that can perform the necessary functions and also be repaired easily in-country.

In many industrialized nations, the high cost of human labour provides strong incentives for the adoption of automated technologies that require only a few, highly qualified workers. Each country faces a unique situation in this area, however. When developing any national information management strategy, it is important to consider the cost of training and retaining workers – beyond the expense of equipment itself – when considering the adoption of an advanced technology.

To facilitate wise decisions in this area, countries are encouraged to share experiences with other nations with similar human-resource structures. Not only can countries share such experiences, but they can also share software, which saves resources and personnel time by either

enhancing existing software or conforming to software that has already been tested and used.

9.7.4 Human resources and training

Those planning and implementing biodiversity information strategies often fail to recognize the importance of hiring or training experts in the field of information management. Instead, they usually rely on re-training existing personnel who lack the essential skills or long-term dedication to the field. Ultimately, such compromises will limit the effectiveness of the overall programme, providing a strong incentive to find – or train – the proper people at the outset.

Staff expertise is essential in implementing and using information management programmes. For example, competent staff are required to operate whatever technologies are used, whether that includes computer databases, geographic information systems, or satellite-image processing. Expertise in some of these technologies is often in short supply in developing countries, and training personnel must be a part of the information management strategy. But these technical skills are scarce and valuable in many parts of the world and every effort needs to be made to spread these skills among more people and retain skilled people in the organization.

Unfortunately, staff turnover can become a serious problem in information management, especially in the public sector. Many staff who receive specialized computer training as part of such activities become competitive for, and take, positions with better-paying private companies. To solve this problem, staff members who receive training could be offered alternative incentives to stay in their current positions – stability or future career options, for example – if higher salaries are not an option. Other solutions could be to train more people than are actually needed, to require a minimum length of stay through a contract, or to adopt a different technology, less dependent on highly trained professionals who are in demand in other sectors.

Local availability of trained personnel might also be a criterion used when deciding on technology options: depending on the information problem to be solved, the most efficient alternative is to adopt systems for which trained staff are already easily available.

Individuals with training in the biological and ecological sciences are also in extremely short supply, especially in developing countries where career pathways in these fields have not previously existed. In the absence of these career opportunities, there is little incentive for bright university students to study biology or ecology rather than go into more traditional and lucrative fields such as medicine, law, economics or business. Staff with appropriate expertise are, however, essential to ensure that the biodiversity information is appropriately collected, interpreted and managed, and also of high quality. Development of local capacities in these fields is another critical, if long-term, need.

9.7.5 Financing

Developing an effective national information management strategy is likely to be expensive. A serious challenge to procuring the necessary funding is the difficulty of finding funds for infrastructure development as opposed to higher priority but shorter-term projects. This problem underscores the need, mentioned previously, to demonstrate a data-gathering institution's relevance to solving environmental problems. One way to do this is to develop, early in the course of institutional development, products that show the organization's long-term, practical relevance.

Another solution in certain cases is to require the user of biodiversity data to pay for the costs. This approach has the advantage that 'the market' determines what data are collected and gives appropriate 'price signals' to potential users of that information. An assumption here is that a mature, informed market exists in this sector, which is not necessarily so. In addition, there is usually a time lag between identifying a need for information and the collection of that information, meaning that user needs would seldom be met. It is unlikely that agencies would be motivated to collect information for which there may or may not be future demand, particularly if not in their own countries.

A further difficulty is that, if information is judged by potential users to be too expensive, then it will not be acquired and thus not be used in reaching decisions, which will be poorer as a result. Since the consequences of making bad decisions seldom, if ever, flow back to the decision-maker, the 'discipline' ordinarily exerted by the market is not effective, thus distorting the pricing mechanism.

An alternative strategy is to support organizations that make data collected primarily for their own corporate requirements available to others. This can be done either by directly supporting the costs of making data freely available or, alternatively, by allowing a data set custodian to recover the marginal cost of doing so. A disadvantage of the latter alternative is that the marginal cost may be roughly comparable with the overheads involved in its administration.

While financial strength is certainly important to the success of any information management effort, some financing strategies may work against an institution's long-term survival. For example, large influxes of funding can often exceed an institution's absorptive capacity, undermining rather than increasing its stability. Achieving financial stability often depends upon having a balanced mix of funding sources to buffer against drastic changes in any one source. In addition, it is highly desirable to have some stable core-programme funding to provide continuity during the inevitable cycles characteristic of more volatile project-level funding.

References

- ALICE 1990. *ALICE: A Bio-Diversity Database System*. ALICE Software Partnership.

- Anderson, R.I.** 1992. *Access and Privacy of Distributed Land Related Information*. M.Sc.E. thesis. Department of Surveying Engineering Technical Report No. 161, University of New Brunswick.
- Antenucci, J.C., Brown, K., Crosswell, P.L., and Kevany, M.** 1991. *Geographic Information Systems: A guide to the technology*. Van Nostrand Reinhold, New York.
- Aronoff, S.** 1989. *Geographic Information Systems – A management perspective*, WDL Publications, Ottawa, Canada.
- Barr, C.J., Bunce, R.G.H., Clarke, R.T., Fuller, R.M., Furse, M.T., Gillespie, M.K., Groom, G.B., Hallam, C.J., Hornung, M., Howard, D.C. and Ness, M.J.** 1993. *Countryside Survey 1990: Main Report*. UK Department of the Environment.
- Berne Convention for the Protection of Literary and Artistic Works**, 9 September, 1886; completed at Paris on May 4, 1896; revised at Berlin on November 13, 1908; completed at Berne on March 20, 1914; revised at Rome on June 2, 1928, at Brussels on June 26, 1948, at Stockholm on July 14, 1967, and at Paris on July 24, 1971; amended at Paris on July 24, 1979.
- Bibby, C.J., Collar, N.J., Crosby, M.J., Heath, M.F., Imboden, Ch., Johnson, T.H., Long, A.J., Stattersfield, A.J., Thirgood, S.J.** 1992. *Putting Biodiversity on the Map: priority areas for global conservation*. International Council for Bird Preservation (ICBP), Cambridge, United Kingdom.
- Bisby, F.A.** 1993. Progress with inventories. *Nature* **363**: 11.
- Bischoff, N.T. and Jongman, R.H.G.** 1993. *Development of Rural Areas in Europe: The claim for nature*. Preliminary and background series. National Scientific Council for Government Policy, The Hague.
- Bowker, R.R.** 1993. *Ulrich's International Periodicals Directory, 1993-94*, 5 vols, 32nd edn. New Providence, NJ, USA.
- Burnett, J.** 1994. IOPI and the Global Plant Checklist Project. *Biology International* **29**: 40-44.
- Burrough, P.A.** 1989. *Principles of Geographic Information Systems for Land Resources Assessment*. Monographs on Soils and Resources Survey No. 12. Clarendon Press, Oxford.
- Busby, J.R. and Walton, D.W.** 1994. A National Biological Survey for the United States? Comparable Australian activities at the national level. In: Longmore, R. (ed.) *Biodiversity – Broadening the Debate* **3**: 4-11. Australian Nature Conservation Agency, Canberra.
- Canhos, D.A.L., Canhos, V.P. and Kirsop, B.E.** (eds) 1994. *Linking Mechanisms for Biodiversity Information*. Tropical Foundation, Campinas, Brazil.
- Canhos, V., Lange, D., Kirsop, B.E., Nandi, S. and Ross, E.** (eds) 1992. *Needs and Specifications for a Biodiversity Information Network*. United Nations Environment Programme, Nairobi.
- Cerf, V.G.** 1995. *Computer Networking: Global infrastructure for the 21st century*. (Internet: <http://www.cs.washington.edu/homes/lazowska/cra/networks.html>)
- CITES**, 1973. *Convention on International Trade in Endangered Species*. UNEP, Washington, DC.
- Computer Security Act of 1987**. US Code. Vol. 40, sec. 759.
- Conservation International** 1994. *CISIG User's Manual*. Version 2.4g, Conservation International, Washington, DC.
- de Klemm, C.** 1990. *Wild Plant Conservation and the Law*. IUCN Environment Policy and Law Paper No. 24. IUCN, Gland, Switzerland.
- de Klemm, C. and Shine, C.** 1993. *Biological Diversity Conservation and the Law: Legal mechanisms for conserving species and ecosystems*. IUCN Environment Policy and Law Paper No. 29. IUCN, Gland.
- English Nature** 1993. *RECORDER Specification*. English Nature, Peterborough, UK.
- EC** 1992. *Proposal on the Legal Protection of Databases*. EC Directive issued January 1992. Council of the European Communities.
- EC** 1992. *Draft Directive on the Legal Protection of Databases*. European Community COM (92) 24 Fol Syn 393.
- Fairhead, H.** 1992. *The 386/486 PC: A Power User's Guide*, I/O Press.
- FAO**, 1986. *Animal Genetic Resources Data Banks: Computer Systems Study for Regional Data Banks*. Food and Agriculture Organization and United Nations Environment Programme.
- Federal Tort Claims Act. U.S. Code**. Vol 28, sec. 2680.
- Fedra, K.** 1994. *State-of-the-Art Environmental Reporting Part IV: A Demonstration Prototype*, Project Progress Report, IIASA.
- Fedra, K.** 1993. GIS and environmental modelling. In: Goodchild, M.F., Parks, B.O. and Steyaert, L.T. (eds), *Environmental Modelling with GIS*. Oxford University Press, Oxford.
- Feist Publications** 1991. *Inc. v. Rural Telephone Service Co.*, 111 S.Ct. 1282.
- Filer, D.** 1994. *BRAHMS: A Pocket Introduction and Demonstration Guide*.
- Fitzmaurice, G.** 1958. Some Problems Regarding the Formal Sources of International Law. In: *Symbolae Verzijl*. Martinus Nijhoff, The Hague.
- Freedom of Information Act (FOIA). U.S. Code**. Vol. 5, sec. 552.
- GATT**, 1993. *Uruguay Round of the General Agreement on Trade and Tariffs*.
- Goriup, P.D.** (ed.) 1988. *The Ecology and Conservation of Grassland Birds*. Technical Publication No. 7. ICBP, Cambridge.
- Green, D.G. and Croft, J.R.** 1994. Proposal for implementing a biodiversity information network. In: *Linking Mechanisms for Biodiversity Information*. Proceedings of a Workshop for the Biodiversity Information Network, Base de Dados Tropical, Campinas, São Paulo, Brazil.
- Green, D.G., Gill, A.M. and Trevitt, A.C.F.** 1993. FIRENET – and international network for landscape fire information. *Quarterly Journal of the International Association for Wildland Fire* **2**: 22-30.
- Greuter, W., Brummitt, R.K., Farr, E., Kilian, N., Kirk, P.M., and Silva, P.C.** (eds) 1993. NCU-3. Names in current use for extant plant genera. *Regnum Vegetabile* 129. Koeltz Scientific Books, Germany.
- Hawksworth, D.L., McNeill, J., Sneath, P.H.A., Trehane, R.P. and Tubbs, P.K.** (eds) 1994. Towards a harmonized bionomenclature for life on earth. *Biology International*, Special Issue **30**: 1-44.
- Hawthorne, W.D.** 1992. *FROGGIE: User Manual* (Part 1).
- Heit, M. and Shortreid, A.** (eds) 1991. *GIS Applications in Natural Resources*. GIS World, Fort Collins, Colorado.
- Hughes, R.H. and Hughes, J.S.** 1992. *A Directory of African*

- Wetlands*. IUCN, Gland Switzerland and Cambridge, UK/UNEP, Nairobi, Kenya/WCMC, Cambridge United Kingdom.
- Humphries, C.J., Vane-Wright, R.I., Williams, P.H.** 1991. Biodiversity reserves: setting new priorities for the conservation of wildlife. *Parks* 2: 34–38.
- IITF** 1994. *Intellectual Property and the National Information Infrastructure, Report of the Working Group on Intellectual Property Rights*. Information Infrastructure Task Force, US Department of Commerce, Washington, DC.
- ISO** 1981. *Documentation – Format for bibliographic information interchange on magnetic tape*, 2nd edn. International Organization for Standardization, 1981: 10-01.
- Jensen, M.** 1995. *Discussion Paper*. African Regional Symposium on Telematics for Development, UNESCO/ITU/UNECA.
- Joyce** 1991. Prospectors for Tropical Medicines, *New Scientist*, October 19.
- MacKinnon, J.** 1992. *The Logic of Mass*, Asian Bureau for Conservation.
- MacKinnon, J.** 1994. *A Method for Evaluating and Classifying Habitat Importance for Biodiversity Conservation*. WCMC/WCI Meeting on Identification of Habitat Criteria, 11–12 October 1994. Cambridge, UK.
- MacKinnon, J. and MacKinnon, K.** 1987a. *Review of the Protected Area System in the Afrotropical Realm*. IUCN, Gland, Switzerland and Cambridge, UK.
- MacKinnon, J. and MacKinnon, K.** 1987b. *Review of the Protected Area System in the Indomalayan Realm*. IUCN, Gland, Switzerland and Cambridge, UK.
- Maguire, D.J., Goodchild, M.F. and Rhind, D.W.** (eds) 1988. *Geographical Information Systems: Principles and applications*, Vols. 1 and 2. John Wiley, New York.
- Mason v. Montgomery Data*, 967 F.2d 135 (5th Cir. 1992).
- Merck and Company, Inc.** 1991. *News Release*, September 19.
- Miller, R.I.** 1994. *Mapping the Diversity of Nature*. Chapman and Hall, London.
- Morain, S.E.** 1993. Emerging technology for biological data collection and analysis. *Annals of the Missouri Botanical Garden* 80: 309–316.
- Nash, J.E.** 1993. Ownership and outreach: a model for administration of shared data. *Annals of the Missouri Botanical Garden* 80: 304–308.
- Olivieri, S., Mittermeier, R.A., Bowles, I.A., Cavalcanti, R.B., da Fonseca, G.A.B. and Rodstrom, C.** 1995 *A Participatory Approach to Biodiversity Conservation: The regional priority setting workshop*. Conservation International, Washington, DC.
- O'Neal, M. and Walter, K.S.** 1989. The BG-BASE Users's Manual: designing a computer-software application to meet the plant-record needs of the Arnold Arboretum. *Arnoldia* 49 (1): 42–53.
- Parker, J. and Hope C.** 1992. The State of the Environment: a survey of reports around the world. *Environment* 34 (1): 1920, 3944.
- Reynolds, J.** 1993. *National Biodiversity Data Bank: Software guide and user manual*. Makerere University Institute of Environment and Natural Resources, Uganda.
- Rybinski, H., Muraszewicz, M., Budin, G. and Galinski, C.** 1994. *The Environment Macrothesaurus System – MTM 4.0*. Proceedings of the First European ISKO Conference, Indeks-Verlag, Bratislava.
- Sayer, J.A. and Whitmore, T.C.** (eds) 1991. *The Conservation Atlas of Tropical Forests. Asia and the Pacific*. Macmillan Press Ltd, London.
- Sayer, J.A., Harcourt, C.S. and Collins, N.M.** (eds) 1992. *The conservation atlas of tropical forests. Africa*. Macmillan, London.
- Schalk, P.H.** 1992. Computer-aided taxonomy. *Binary* 4: 124–126.
- Scott, D.A.** (ed.) 1988. *A Directory of Asian Wetlands*. IUCN, Gland, Switzerland and Cambridge, UK.
- Scott, D.A.** 1993. *A Directory of Wetlands in Oceania*. IWRB, Slimbridge, UK and AWB, Kuala Lumpur, Malaysia.
- Scott, D.A. and Carbonell, M.** 1986. *A Directory of Neotropical Wetlands*. IUCN, Cambridge and IWRB, Slimbridge.
- Scott, J.M., Mountainspring, S., Ramsey, F.L. and Kepler, C.B.** 1986. *Forest Bird Communities of the Hawaiian Islands: Their dynamics, ecology and conservation*. Studies in Avian Biology No. 9. Cooper Ornithological Society, New Mexico State University.
- Simonett, O.G.** 1992. *Geographic Information Systems for Environment and Development*. GRID Information Series No. 19. UNEP, Nairobi.
- Skole, D.L., Moore, B. III and Chomentowski, 1993.** Global geographic information systems. In: Solomon, A.M. and Shugart, H.H. (eds), *Vegetation Dynamics and Global Change*. 168–189. Chapman and Hall, New York.
- Stewart, S.M.** 1989. *International Copyright and Neighboring Rights*, 2nd edn .
- Tinker, C.** 1990. Environmental Planet Management by the United Nations: an idea whose time has not yet come? *N.Y.U. Journal of International Law and Politics* 22: 793.
- The Nature Conservancy** 1992. *An Overview of the Biological and Conservation Data (BCD) System*. TNC, USA.
- Tomlin, C. D.** 1990. *Geographic Information Systems and Cartographic Modelling*. Prentice Hall, New York.
- Tveitdal, S.** (undated). *Economics of EIS/GIS: Focus on Environmental Information Systems in Sub-Saharan Africa*. Technical Paper. Environmentally Sustainable Development Division, World Bank, Washington, DC.
- Uhlir, P.F.** 1986. The public international law of civilian remote sensing: an overview. In: Mink, P.D. (ed.), *American Enterprise, The Law, and the Commercial Use of Space*, Vol. II, 27: 78 National Legal Center for the Public Interest, Washington, DC.
- United Nations**, 1945. *Charter of the United Nations*.
- United Nations**, 1948. *Statute of the International Court of Justice*. Article 38 (1).
- United Nations**, 1972. *Report of the United Nations Conference on the Human Environment: The Stockholm Declaration*. UN Doc. A/Conf.48/14 and Corr. 1.
- United Nations**, 1992. *Agenda 21*. UN Doc. A/Conf.151.
- United Nations**, 1992. *The Rio Declaration*. UN Doc. A/Conf.151/5/Rev.1.
- United Nations**. *The World Charter for Nature*.
- United Nations Environment Programme** 1992a. *Convention on*

- Biological Diversity*. UNEP, Nairobi.
- UNEP** 1992b. *Non-Legally Binding Authoritative Statement of Principles for a Global Consensus on the Management, Conservation and Sustainable Development of All Types of Forests ('Forest Principles')*. UN Doc. A/Conf.151/6/Rev.1. UNEP, Nairobi.
- UNEP** 1993. *Guidelines for Country Studies on Biological Diversity*. UNEP, Nairobi.
- UNEP** 1985. *Register of International Treaties and Other Agreements in the Field of the Environment*. UNEP, Nairobi.
- Volterra**, V. 1926. Variazione e fluttuazioni del numero d'individui in specie animali conviventi. *Atti. Accad. Naz. Lincei Memorie (ser. 6)* 2: 31–113.
- WCMC** (World Conservation Monitoring Centre) 1994. *Availability of Biodiversity Information for East Africa*. UNO/RAF/006 GEF Field Document 3. Food and Agriculture Organization of the United Nations, Dar es Salaam, Tanzania.
- Webb**, S.P. 1988. *Creating an Information Service*, 2nd edn. ASLIB, London.
- Weiss**, P.N. 1994. *Security Requirements and Evidentiary Issues in the Interchange of Electronic Documents: Steps toward developing a security policy*. *GIS Law* 2: 2.
- Williams**, P.H., Humphries, C.J. and Vane-Wright, R.I. 1995. Measuring biodiversity: taxonomic relatedness for conservation priorities, *Australian Systematic Biology* (in press).
- WRI**, IIED and IUCN 1992. *1993 Directory of Country Environmental Studies: An annotated bibliography of environmental and natural resource profiles and assessments*. World Resources Institute, Washington, DC.
- Wright**, G. 1988. *Mastering Computers*. Macmillan, New York.
- WWF-India**. 1994. *Indira Gandhi Conservation Monitoring Centre: A profile*. World Wide Fund for Nature-India.

10

Biotechnology

B.A. BARLOW AND G.T. TZOTZOS

Lead Authors:

B.A. Barlow (Chapter 10.0); R. Appels, A.G. Young, G.T. Tzotzos, B.A. Barlow, C. Simoens (Chapter 10.1); M. van Montagu, J.M. Tiedje, D. Powell, C. Simoens, G.T. Tzotzos, B.A. Barlow (Chapter 10.2); G.T. Tzotzos, W.H. Lesser, D. Powell, P.J. Dale (Chapter 10.3); B.A. Barlow, G.T. Tzotzos (Chapter 10.4)

Contributors:

A. van Gysel, M. Jaziri

CONTENTS

Executive Summary	675	10.2.3 Using biodiversity for environmental remediation	694
10.0 Introduction	677	10.2.3.1 Factors that limit bioremediation	694
10.0.1 Definition	677	10.2.3.2 How can microbial diversity be discovered?	695
10.0.2 Putting biotechnology in context	677	10.2.3.3 The classes of environmental contaminants	695
10.0.3 Multiple roles of biotechnology	678	10.2.3.4 Recent discoveries of diversity important for remediation	695
10.0.4 Positive and negative impacts of using biotechnology	678	10.2.3.4.1 Anaerobic metabolism of BTEX	695
10.1 Accessing and using molecular DNA data on biodiversity	678	10.2.3.4.2 Enhanced PCB degradation	696
10.1.1 Key technologies	679	10.2.3.4.3 Niche adjustment to accommodate CCl ₄	696
10.1.1.1 Chemical screening	679	10.2.3.4.4 Chlororespiration	697
10.1.1.2 DNA technologies: genome mapping	679	10.2.3.4.5 Co-metabolism of TCE	697
10.1.2 Biotechnology applications in biodiversity assessment and management	680	10.2.3.4.6 Construction of a TNT degrader	697
10.1.3 Increasing option values: providing the knowledge base for biodiversity culture and preservation	681	10.2.3.5 Traits sought in bioremediation	697
10.1.3.1 <i>Ex situ</i> conservation	681	10.2.3.6 Tracking microbial strains added to the environment	697
10.1.3.2 Biotechnology-enhanced option values	681	10.2.3.7 Bioremediation technologies	698
10.1.3.3 DNA libraries and sequence data	683	10.2.4 Roles of biotechnology in utilization of biodiversity: conclusions	698
10.1.3.3.1 Role of DNA libraries and sequence data in biodiversity conservation	683	References	698
10.1.3.3.2 Role of DNA libraries and sequence data in biodiversity assessment and utilization	684	10.3 Impacts of biotechnology on biodiversity	700
10.1.4 Biotechnology as a tool for utilizing biodiversity for human benefit	684	10.3.1 Definitions of impacts	700
References	684	10.3.2 Direct impacts	700
10.2 Applications of biotechnology for the utilization of biodiversity	685	10.3.2.1 Lessons from past introductions	700
10.2.1 The scope of biotechnology applications	686	10.3.2.2 GMOs: Invasiveness in natural habitats	701
10.2.2 Improving production and sustainability	686	10.3.2.3 GMOs: Gene transfer to non-target populations	703
10.2.2.1 Biotechnology-assisted breeding in crop plants	687	10.3.3 Risk assessment	704
10.2.2.1.1 Molecular markers for rapid selection	688	10.3.4 Measures for minimizing direct impacts	705
10.2.2.1.2 Techniques for wide crosses	689	10.3.4.1 Measures for transgenic crops	705
10.2.2.1.3 Disease screening	690	10.3.4.2 Measures for genetically modified microorganisms	705
10.2.2.2 Genetic engineering	690	10.3.5 Indirect impacts	705
10.2.2.2.1 Applications of genetic engineering	690	10.3.5.1 Increases in value of genetic resources generated by biotechnology applications	706
		10.3.5.1.1 Implications of value increases	706
		10.3.5.1.2 Remoteness of incentives	

	for conservation	707	10.4.1 Biotechnology provides important tools for biodiversity assessment and monitoring	709
	10.3.5.1.3 Moral/ethical debates	707	10.4.2 Biotechnology provides important tools for biodiversity conservation	709
	10.3.5.2 Biotechnology-generated increase in agricultural productivity	707	10.4.3 Biotechnology provides important tools for biodiversity utilization for human benefit	709
	10.3.5.2.1 Replacement of traditional landraces	707	10.4.4 Biotechnology can impact on biodiversity in various ways	709
	10.3.5.2.2 Disadvantaged groups	707		
References		708		
10.4 Conclusions		709	Acknowledgements	710

EXECUTIVE SUMMARY

Biotechnology provides important tools for biodiversity assessment and monitoring:

- Key molecular technologies for biodiversity assessment and monitoring include screening methods for various classes of compounds, and DNA fingerprinting.
- Applications of biotechnology can increase our understanding of biodiversity at several levels, ranging from the effects of habitat modification or population fragmentation on partitioning of genetic diversity, through definition of taxonomic boundaries, to understanding evolutionary relationships on a broad scale. It contributes to our understanding of processes that underlie patterns of biodiversity. In effect, biotechnology brings new levels of quality and refinement to inventorying and monitoring of the living world.

Biotechnology provides important tools for biodiversity conservation:

- *In situ*. Applications of biotechnology provide data critical for the best management solutions for species. They allow assessment of optimal or minimal population sizes for maintaining diversity, and best practices for augmenting wild populations through transfers from other wild populations or from captive breeding programmes.
- *Ex situ*. Biotechnology contributes to the quality and efficiency of *ex situ* conservation of biodiversity.
- Biotechnology increases the quality of *ex situ* germplasm collections. Samples characterized on the basis of DNA sequence rather than on phenotype can provide better coverage of existing diversity, and can provide a means of avoiding redundancy.
- Biotechnology is the entire basis for a class of non-living conserved collections, namely DNA libraries and sequence databases. It allows compact storage of large amounts of genetic information which are recoverable for conservation or utilization objectives.

Biotechnology provides important tools for biodiversity utilization for human benefit:

- Living organisms can be used as factories for specific products, targeted to a variety of production end uses, harnessed for environmental remediation, or used in industrial processes. Biotechnology applications can serve rural, manufacturing and extractive activities.
- *Biotechnology-assisted breeding*. Especially through use of genetic markers, biotechnology can both enhance and accelerate the breeding process.
- *Genetic engineering*. Although not a universal solution, genetic engineering is the most elegant way of improving domesticated breeds. Protocols for gene transfer are now becoming routine. Genetic engineering can be used, among other objectives, to increase productivity, control disease, eradicate pests and improve product quality or novelty.
- *Novel genes and gene products*. Biotechnology-based screening (bioprospecting) can increase our capacity to locate and benefit from useful genes and compounds in the biodiversity around us.
- *Environmental remediation*. Biodiversity is the key resource for rehabilitating degraded ecosystems. Biotechnology greatly enhances both the specificity and efficiency of remedial actions.

Biotechnology can impact on biodiversity in various ways:

- These impacts can be direct or indirect. Both for human benefit and for environmental conservation, the outcomes can be positive or negative. Importantly, there are realistic ways of assessing potential impacts, and therefore of gaining maximum benefits from biotechnology applications. The benefits can be realized for both industrialized and non-industrialized peoples and places.
- Direct impacts of biotechnology are ecological or evolutionary, and can be assessed by scientific methodology and tested experimentally. They could include introgression, weediness, pathogenicity, altered nutrient cycling and a range of responses in other species populations.

- Procedures exist in many countries for assessing the possible impact of release of genetically manipulated organisms. In general, these adopt a case-by-case approach, although generic *a priori* risk appraisal is becoming acceptable in some situations. Step-by-step approaches to risk assessment may be of little predictive value for assessing the risk of commercial releases. Careful definition of data required during experimentation and post-release monitoring is necessary.
- Risk reduction is achieved mainly by confinement. Measures for minimizing direct impacts on native ecosystems aim to impose specified limits on gene transfer, on exposure to toxic products and on direct invasion. Good containment possibilities exist, even for microorganisms. Past experience with release of conventionally bred varieties is often a good guide for best practice.
- Indirect impacts of biotechnology are predominantly socio-economic. They can be of major importance because of the way social systems drive our use of biotechnology and biodiversity. Risk assessment for indirect impacts should therefore be independent of that for direct impacts.
- Biotechnology can increase the value of genetic resources. In absolute terms these values may be limited, but value changes may lead to indirect effects.

These may include conflicts over ownership, including intellectual property; altered rates of utilization and therefore of resource conservation and environmental protection; and ethical debates on the acceptable scope of the biotechnology applications themselves.

- When biotechnology results in increased agricultural productivity, both positive and negative impacts can be predicted. These include changed pressures for cultivating new land, replacement of traditional landraces, and marginalization of fringe production areas through price changes.

Biotechnology has great potential to generate benefits, both environmental and socio-economic. It can enhance our understanding of biodiversity and our capacity to conserve, manage and utilize it. It can improve our production systems and the diversity of the amenities we desire. In general, however, its impacts on biodiversity may not be different in nature, but only in degree, from those of our traditional or conventional practices. These impacts may be direct ecological and evolutionary outcomes of biotechnology applications, or indirect, resulting from altered socioeconomic circumstances. The Convention on Biological Diversity calls for appropriate safeguards to ensure safe applications of biotechnology. We have a growing capacity to assess likely impacts, and to make informed decisions both for conservation of biodiversity and for equitable sharing of the benefits of biotechnology.

10.0 Introduction

For policy-makers with responsibility for the good management of their national or regional biological resources, **biotechnology** is of special importance as it can greatly influence the economic basis for many management decisions relating to these resources. Thus, for many managers the issue of the conservation of biodiversity is, in a practical sense, the issue of how biotechnology can best be applied to obtaining national or regional benefits from genetic resource conservation and utilization.

10.0.1 Definition

In the Convention on Biological Diversity, **biotechnology** is defined as 'any technological application that uses biological systems, living organisms, or derivatives thereof, to make or modify products or processes for specific use'. Many countries have adopted the same or similar definitions. When interpreted broadly, biotechnology can therefore include traditional methods, for example in improving domesticated plants and animals by breeding; utilizing microorganisms for food and beverage processing, and disease control through inoculation; and biological control of pests.

Biotechnology can be defined more narrowly, however, to encompass new technologies that have a strong molecular basis. These include recombinant DNA technologies, rapid screening techniques for natural products, and sophisticated culture processes. In the context of applying biotechnology to biodiversity, now and in the future, to capture significant new benefits for humankind, these new technologies are of great importance, and are the major focus of this Section. Whilst the traditional methods are important, their significance is largely self-evident and it is not necessary to deal with them comprehensively here. The traditional methods nevertheless give us a strong background of experience against which to assess the merits and risks of biotechnology applications.

Throughout this Section, the term biotechnology generally refers to these new molecular technologies, even though they comprise only a subset of the more broadly defined biotechnology of the Convention on Biological Diversity. Because of its importance to policy-makers, this subset is the one that requires particular attention in the context of the Global Biodiversity Assessment.

Many people apply the term 'biotechnology' even more narrowly, strictly in the sense of using gene manipulation, especially genetic engineering, for human benefit and commercial gain. This is the facet of biotechnology that is perceived, perhaps wrongly, to have the greatest economic implications, and is the one that has the highest public profile. It is the facet of biotechnology most strongly linked with ethical issues and concerns about biosafety and most emphasis in Section 10 is given to this aspect. However,

this interpretation of biotechnology overlooks the important contributions it can make to our understanding, management and conservation of biodiversity, which are also outlined below. The somewhat broader definition adopted here is therefore much more relevant to all of the aspects of biodiversity covered by the Convention.

There is a broad range of terminology in biotechnology, including **genetic engineering, gene engineering, recombinant technologies, recombinant DNA technologies, molecular techniques/technologies, gene manipulation/transfer** and **transgenesis**, all of which have the same or similar meanings. A comparable range of terminology applies to the products of biotechnology, including **genetically engineered/modified organisms, transgenic organisms** and **transgenes**. For the purposes of the discussion that follows, these terms are more or less interchangeable.

10.0.2 Putting biotechnology in context

As part of the Global Biodiversity Assessment, the primary focus of this Section is on biodiversity, and the Section is structured accordingly. Specific details of biotechnologies can be found in texts or in recent reviews, and to provide here a structured account of all biotechnologies would obscure the main issues relating to biodiversity. For each particular biodiversity issue, only those new biotechnologies most relevant are introduced, and biotechnologies are dealt with generically where appropriate. This enables us to best understand how biotechnology provides ways to increase our knowledge base on biodiversity, to manage it, to utilize it, and to address the implications of its use.

This Section, in common to some extent with Section 7, differs from most other Sections of the Global Biodiversity Assessment in that its subject is certain *tools* that are increasingly being used to achieve various biodiversity objectives. The other Sections focus primarily on *issues* relating to biodiversity. Wherever the objectives of applying these tools are discussed below, there is a consequent overlap with the subject matter of the other Sections. In order to present a picture of the importance and implications of biotechnology for biodiversity issues, a selection of examples and case studies is presented below. This selection is limited both by space and by the overlap with other Sections. Where further detail and examples are discussed in other Sections, appropriate cross-references are provided. In particular, the applications of biotechnology have relevance for the issues discussed in Sections 2, 3, 11, 12 and 13.

Chapter 16 of UNCED *Agenda 21* (see Section 1) is devoted to biotechnology. It too makes a distinction between 'modern' biotechnology (DNA manipulation) and 'traditional' biotechnology. It sets out a suite of recommended programmes for:

- Increasing the availability of food, feed and renewable raw materials.
- Improving human health.
- Enhancing protection of the environment.
- Enhancing biosafety and developing international mechanisms for co-operation.
- Establishing enabling mechanisms for the development and environmentally sound application of biotechnology.

This Section of GBA is in harmony with the broad thrust of *Agenda 21* Chapter 16.

10.0.3 Multiple roles of biotechnology

The relationship between biotechnology and biodiversity is multidirectional. First, biotechnology provides powerful new tools for assessment of biodiversity. It is therefore playing an increasing role in identifying the biological resources themselves. Secondly, it gives us new methods and guidelines for conservation of biodiversity. Thirdly, it provides a greatly enhanced capacity for wise and efficient utilization of biodiversity, both as a genetic resource for production and in the remediation of degraded ecosystems. The chapters in this Section are structured to address these multiple roles.

10.0.4 Positive and negative impacts of using biotechnology

It is important to understand that by focusing on organisms resulting from applications of biotechnology, this Section does not imply that such organisms are necessarily dangerous. Neither does it imply that organisms resulting from traditional technologies, such as conventional breeding, are necessarily safe. As discussed below, many reviews have concluded that the assessment of risks of modified organisms should be based on the characteristics of the organism rather than on the means by which it was produced.

When applied prudently, biotechnology offers potential benefits to both developed and developing countries. However, there may be direct or indirect impacts that are negative, either for biodiversity itself or for the interdependent human communities. With adequate background knowledge, undesirable outcomes can be predicted, and with careful planning and good management they should be avoided or minimized. This topic is addressed in Section 10.3.

Biotechnology has great potential for improving our understanding and management of our biodiversity, for broad environmental and economic benefit. We can reasonably hold high expectations about embracing it, as long as we are able to identify the social and environmental risks and employ appropriate safeguards.

10.1 Accessing and using molecular DNA data on biodiversity

At its most fundamental level, biotechnology allows us to investigate critically the diversity of organic molecules, and the diversity of the primary structure of DNA, the genetic material itself. Our ability to isolate, clone and characterize specific DNA sequences from the vast array that exists in nature provides us with enormous opportunities. We can assay sections of genomes for genetic mapping purposes, and apply the knowledge to biodiversity assessment. The use of biotechnology to characterize living (and to some extent non-living) biological material can improve the quality of species inventories by, for example, refining the delineation of species and accurately estimating the scope of diversity within and between species (see Section 2.1).

Our knowledge and understanding of biodiversity is principally derived from biological collections, both living and non-living. Biological collections can be either *in situ* (conserving species by conserving habitat) or *ex situ* (conserving species by storage outside the natural habitat). The expansion of the knowledge base through applications of biotechnology to biological collections can not only enhance our understanding of the biodiversity of a region or country, but also foster practical approaches to its conservation. This chapter deals with technologies that can contribute to biodiversity assessment and conservation, and presents examples of how they may be applied. The substantive treatment of these topics is presented in Sections 2 and 13 respectively.

In order to maintain genetic diversity, *in situ* collections should have adequately large areas devoted to them, but in practice smaller carefully managed areas are usually set aside, and the role of biotechnology in this situation is of increasing importance. *Ex situ* conservation is achieved in many different ways, discussed in detail in Sections 8 and 13. A summary of the role of biotechnology in *ex situ* conservation is presented below. A recent development in data collection from *ex situ* collections is the storage of isolated DNA from endangered species, and its extraction from non-living samples is also discussed below.

Biological collections can also serve as sources of genetic material, either as genes encoding desirable characteristics (from living collections) or as storable DNA (from either living or non-living collections). They therefore provide the raw material for the genetic improvement of crop plants and animal breeding stock, and for other industrial applications. Utilization of biodiversity for these objectives is the major focus of this Section.

Although only 103 plant species provide 93% of the per capita food supply (Prescott-Allen and Prescott-Allen 1990), thousands more are grown for culinary and medicinal uses, as sources of fuel and fibre, as ornamentals and for many other purposes (see Sections 2.2.2 and 3.1.4).

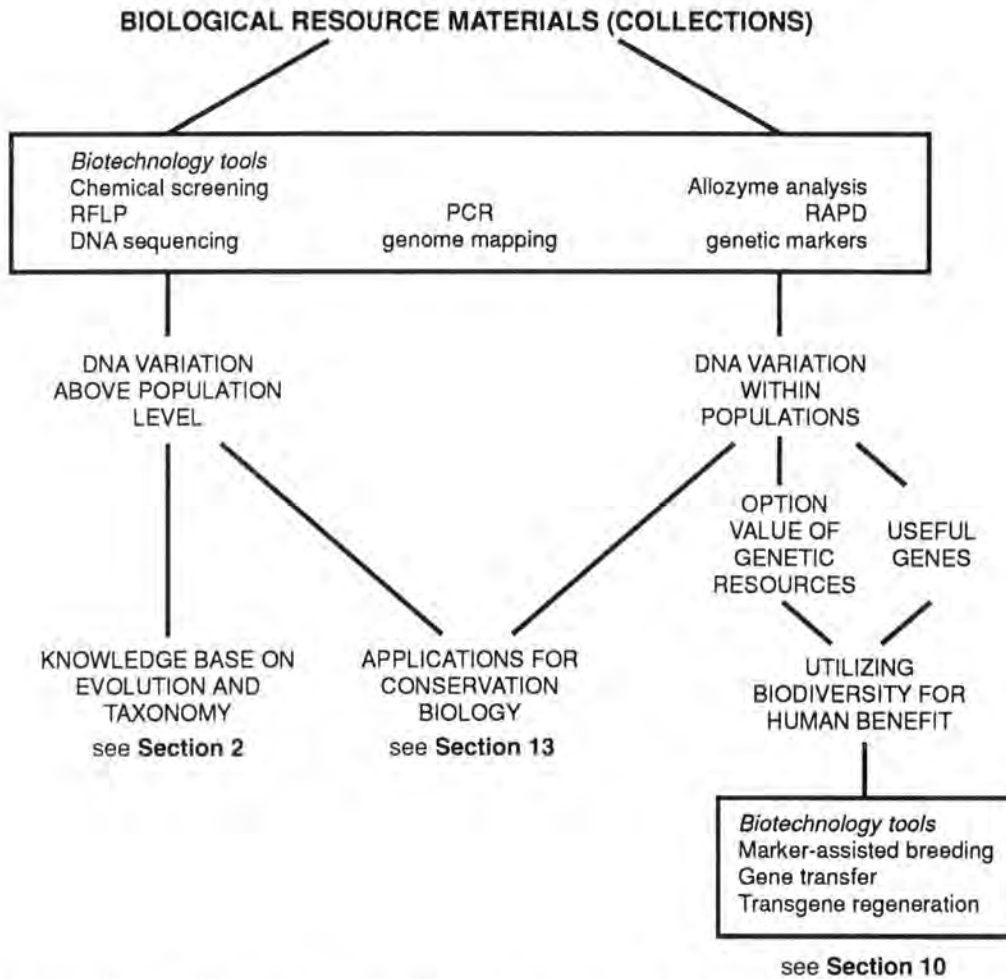

Figure 10.1-1: Biotechnology applications in biodiversity assessment and management.

Many of the species providing the food supply are not understood at a detailed evolutionary or cytogenetic level, and wild relatives of these crops with potential utility are in danger of being lost owing to inadequate conservation (see Section 3.1.4). Extensive sampling of global biodiversity is therefore very important not only for characterizing the biodiversity itself but also for broadening the resource base for improving our production systems.

The roles of biotechnology applications in biodiversity assessment and management are summarized in Figure 10.1-1.

10.1.1 Key technologies

The key technologies that contribute significantly to the objectives described above are presented below as a general overview, comprising both chemical and molecular biological tools. The most important DNA methodologies for each objective are summarized in Figure 10.1-1. Several of these methodologies are described elsewhere in the GBA.

10.1.1.1 Chemical screening

Chemical screening for biological variation among organisms is an established technology, based on

classifying organisms by virtue of their chemical phenotypes (chemotaxonomy). Chemical screening has resulted in extensive chemotaxonomic databanks based on, for example, analysis of the protein, carbohydrate and lipid components of crops and foods. Recent developments in instrumentation have established high performance liquid chromatography (HPLC) as a particularly versatile and adaptable technology for separating molecules on the basis of their physicochemical properties. In addition, immunochemical and nucleic acid methodologies for detection of compounds have been adapted to produce easy-to-use kits (Skerritt and Appels 1995).

The combination of screening technologies with genetic engineering provides extremely powerful tools for the exploitation of genetic resources for human benefit (see 10.1.4 and 10.2).

10.1.1.2 DNA technologies: genome mapping

Whereas chemical screening provides characterization at the level of the phenotype, molecular biological techniques achieve characterization at the level of the genotype. Techniques such as DNA fingerprinting are becoming major tools for analysing populations and for taxonomic-

decision-making. The PCR technology, described in Section 2.2, combined with electrophoretic analysis of DNA products, underlies current DNA fingerprinting techniques. Useful characteristics from new sources, recognized through screening, DNA fingerprinting or ethnobiology, can be bred into cultivated varieties. Unique combinations of characteristics can be incorporated into single individuals, the process being facilitated by the identification of molecular markers linked to the desired traits.

Different kinds of genetic material occurring in living organisms can be used for DNA sequence studies. Genetic material is found, for example, in the cytoplasm of prokaryotic organisms, and in the nucleus and organelles (e.g. mitochondria and chloroplasts) of eukaryotic organisms. The different potentials for analysis of these kinds of DNA are summarized in Section 2.2, Box 2.2-4, and examples involving data from nuclear, mitochondrial or chloroplast DNA are briefly presented below as case studies.

The variation in the DNA sequences of the alternative forms that occur among different individuals in a population (polymorphism) provides useful markers that can be exploited to map the relative location of chromosomal segments. These markers can be found in the coding and non-coding regions of chromosomal DNA (exons and introns respectively).

The distance between two markers on the same chromosome can be measured in terms of base pairs (physical mapping) or in terms of their frequency of recombination (genetic linkage mapping). The process of sperm and egg cell production (meiotic recombination) may result in the separation of two markers originally found on the same chromosome. Generally, the closer to each other these markers are, the smaller is the chance of their being separated in the process of recombination.

A feature of the use of DNA markers in genetic analyses is that several ways are now available for measuring the differences in DNA sequence between individuals (see Section 2.2). If these differences are found to represent alternatives at a single position in the genome, they are considered to define alleles in the same way that alternative products from wild type and mutant genes define alleles of that gene. Allelic differences between individuals can therefore be identified within a specified DNA segment at positions that do not necessarily code for a gene product. In principle, this means that variation among individuals can be detected without *a priori* knowledge of chemical or morphological phenotype, thus allowing much more precise characterization of phylogenetic relationships.

Biodiversity can make a contribution to agricultural practice only when that diversity can be catalogued in a meaningful way. Depending on their respective resolutions, genome mapping techniques have significant potential in biodiversity conservation, assessment and utilization. Until

recently, mapping mammalian genomes has been an extremely difficult and slow process. New techniques, many derived from the Human Genome Project (Szybalski 1993), have been developed specifically to accelerate the process of mapping chromosomes. In many species there are specific patterns of repetitive DNA sequences that can be used to provide markers for segregating chromosomes (in the same way that, in 1865, Mendel used the colour of peas as markers for segregation). These numerous arrays of sequences provide more 'characteristics' than are available by examining the phenotype alone. In addition PCR, in its various guises, generates new analytical probes rapidly, using small amounts of material. Fluorescent *in situ* hybridization can be used to confirm chromosome assignments (Lichter *et al.* 1990).

Together, this suite of powerful techniques can enormously reduce the time taken to map genes and chromosomes, and can be used to help isolate individual genes. Researchers in major international projects are currently attempting to map the genomes of pig, sheep and cow (Gellin & Chevalet 1994; Broad & Hill 1994; Fries *et al.* 1993; Beattie 1994), and of *Arabidopsis* (Bevan 1994). Underlying these approaches is the reasonable assumption that related, perhaps feral, animals and plants will display conservatism of genetic information in two ways – related sequence information (homology) and related gene order (synteny). This type of information in such species may then be more readily derived and used.

10.1.2 Biotechnology applications in biodiversity assessment and management

The use of biotechnology to characterize biological material, including herbarium and fossil samples, generates information that can be utilized in developing databases for systematic studies, and thus contributes to the inventory and management of national floras and faunas. Applying biotechnology to clarifying taxonomic and evolutionary relationships among groups of organisms allows:

- effective definition of taxa as management units;
- the evolutionary uniqueness of lineages to be used as a measure of their relative conservation value;
- relationships between cultivated plants and animals and their wild relatives to be used to identify possible sources of genetic material for domestic plant and animal improvement.

Taxic diversity is an important consideration in biodiversity assessments, and is dealt with in the GBA principally in Section 2. A simple example of the application of biotechnology to enhancing the knowledge base on evolution and systematics is presented in Box 10.1-1.

Box 10.1-1: Biotechnology applications enhance the knowledge base on evolution and systematics.

Example: Chase *et al.* (1993) examined variation in the chloroplast gene *rbcL* (ribulose-1,5-bisphosphate carboxylase large subunit) of 499 taxa encompassing all of the major flowering plant lineages. The results generally agreed with comparable morphological studies, and supported several major hypotheses such as the sister group status of flowering plants and Gnetales, and the isolated position of *Ceratophyllum* as a sister to all other flowering plants. The important new insight from this study was the identification of a major division within the flowering plants, not based on the monocotyledon versus dicotyledon disjunction, but correlated with pollen type (exclusive of *Ceratophyllum*). The major role of broad analyses like this is probably in hypothesis generation rather than testing.

Biotechnology provides a variety of applications for increasing our current understanding of the dynamics of biodiversity. Information on processes such as mating, derived from the use of genetic markers, is important for an understanding of how biodiversity is generated, structured and lost, the topic of Section 4.

Biotechnology can also be used to assess rapidly the effects of ecosystem disturbances on components of biodiversity and on biological processes. It thus generates information critical to the management of biodiversity, sustained utilization of resources and long-term ecosystem conservation (see Section 13). Simple examples of applications of biotechnology to management solutions in biodiversity conservation are presented in Box 10.1-2.

10.1.3 Increasing option values: providing the knowledge base for biodiversity culture and preservation

In addition to enhancing the resolution when measuring and monitoring biodiversity, biotechnology can play important roles in culturing and conserving biodiversity. The possibilities for biotechnology to find solutions for *in situ* restoration of balance in natural ecosystems are illustrated by the examples above and in 10.2.2.2.1 and 10.2.3. In *ex situ* situations, it also provides new opportunities. For living resource collections it has potential for more efficient culture of the samples themselves, and for refining the quality of a collection as a whole. Biotechnology is also the entire basis for a class of non-living collections, namely DNA libraries and sequence databases. Biotechnology therefore profoundly increases the *option values* of genetic resource collections.

10.1.3.1 Ex situ conservation

Genetic resources are the basis of agricultural development because they can provide an enormous pool of genetic adaptability which acts as a buffer against environmental change. Valuable genes are dispersed through local cultivars and wild relatives. Destruction of natural ecosystems and replacement of local varieties by imported ones have led to the loss of wild relatives and of land races.

As discussed in Section 3.1.4.2, the growing world population is today largely dependent on only a restricted number of improved, high-yielding varieties. Although increases in food production have been achieved, they have been at a very high cost since many heterogeneous local varieties have been lost forever. The value of primitive landraces rests in their ability to withstand conditions that would seriously damage many modern cultivars, and also to provide resources for attributes such as nutritional quality and resistance to disease, as well as those characteristics which, unrecognized at present, may some day be considered invaluable.

Largely because of degradation or loss of habitat, therefore, off-site (*ex situ*) conservation measures for species and the genetic resources they encompass is a critical component of biodiversity conservation strategies. Options and management systems to meet this need, through botanic gardens, zoos and germplasm banks for example, are described in Sections 8 and 10.4. They use a variety of techniques, including intensive husbandry, cold storage and tissue culture, to maintain the quality and diversity of their accessions. None of these techniques would fall within the narrower definition of biotechnology that has been adopted here.

One role for biotechnology in *ex situ* conservation derives from its potential for refining the quality of *ex situ* collections (Gustafson *et al.* 1993). Taxonomic classification of germplasm collections based on morphological or chemical phenotypes can be tentative and/or redundant, and there is often no direct relationship between phylogeny and phenotype. On the other hand, samples characterized on the basis of known DNA sequence rather than on phenotype may provide a more comprehensive coverage of existing diversity, and may also provide the means of avoiding duplication (redundancy) of germplasm collections.

10.1.3.2 Biotechnology-enhanced option values

Molecular markers provide a powerful approach for investigating the genetic basis of variation between different varieties and for manipulating complex genomes. For the estimation of genetic diversity of germplasms the profiles obtained by DNA fingerprinting are sufficiently powerful to characterize and distinguish between the genetic bases of cultivars and their wild relatives. Based on DNA fingerprints, selection can be made for the

Box 10.1-2: Applications of biotechnology may be critical to good management solutions for long-term community and population conservation.

Example 1: An important question in the active management of natural populations is whether interpopulation transfer of individuals is an appropriate way to augment populations with low diversity or few individuals. This question is especially relevant given the rate at which habitat fragmentation and destruction is reducing the number and size of populations of many species. The answer is largely dependent on the amount of genetic differentiation among source and target populations. The introduction of individuals with maladaptive genes may, for example, result in outbreeding depression (see Section 4.2).

Gibbs *et al.* (1994) addressed this management question for the black rat snake in southwestern Ontario, Canada, where it is currently known from only four geographically disjunct populations, one large and three small. RAPD markers (see Section 2.2) were used to assess genetic divergence between the large population and one of the smaller populations. High genetic similarities between populations were observed, indicating that the populations do not represent different genetic stocks, and that translocation of snakes from the large population to the smaller one may be a suitable management option.

In contrast, examination of interpopulation genetic structure of the uncommon and vulnerable ghost bat (*Macroderma gigas*) in northern Australia, based on mitochondrial DNA RFLP markers and sequencing (Section 2.2), indicates highly developed geographic genetic structure, with the presence of several fixed allelic differences among populations (Worthington Wilmer *et al.* 1994). This suggests that current populations have been effectively isolated for long periods, a conclusion supported by observations of strong site fidelity among females. In this case populations should be managed as independent genetic units.

Example 2: Different technologies have different resolving powers with respect to biodiversity assessment. A good example is provided by the analyses of genetic structure of green turtles (*Chelonia mydas*) from the Indian and western Pacific Oceans (Norman *et al.* 1994). In this case, intensive RFLP analysis of mitochondrial DNA (see Section 2.2, Box 2.2-4) revealed four genetic groups of turtles which could be viewed as units for management purposes. However sequence analysis of a 385 bp segment of the control region showed an eight-fold higher divergence, and the existence of ten distinct genetic groups.

incorporation of material in germplasm collections or for the elimination of repetitive profiles. For example, Beeching *et al.* (1993) reported the use of RFLP markers to assess the genetic diversity within a collection of cassava germplasm. Significant levels of polymorphism were revealed, and made it possible to construct dendrograms indicating the genetic diversity within the collection. RFLP and RAPD (see Section 2.2) markers were used to study the genetic variation within and between trembling aspen and bigtooth aspen (*Populus* spp.) (Liu and Furnier 1993). Compared with allozymes (see Section 2.2), molecular markers clearly generate more polymorphic and species-specific loci in aspen, and RAPDs provide a very powerful tool for fingerprinting aspen individuals.

Chloroplast DNA variation (see Section 2.2, Box 2.2-4) can readily be assayed using RFLPs. For example, among 33 taxa of the cabbage family Brassicaceae, two separate evolutionary lineages each of which contained taxa cultivated as crops were identified by Warwick and Black (1991). They also observed a high level of congruence between currently recognized crossing groups and clusters defined by phenetic analysis of the cpDNA data. Such correlations suggest that cpDNA data can be used in a predictive fashion to identify potential crossing groups among undomesticated taxa which would

facilitate the introduction of new genetic material into breeding programmes.

Within a species, chloroplast RFLPs have also been used to ascertain the domestication history of species already in cultivation, allowing rationalization of current breeding programmes and relocation of superior provenances. For example, the application of chloroplast DNA markers to the analysis of the domestication of *Acacia mangium* has helped to define the populations to be used in breeding programmes. The species occurs naturally in eastern Indonesia, Papua New Guinea and northeastern Australia, and is used for the pulp and paper industry. Although *A. mangium* was introduced into plantations less than 25 years ago, more than 200 000 hectares are already planted in Indonesia alone. More than 90% of the plantations are derived from a seed orchard in Sumatra, and records suggest that this stand was sourced primarily from a narrow southern part of the species area. Isozyme studies failed to reveal sufficient genetic variation for use in biodiversity assessments (Moran *et al.* 1989). In contrast, a survey of chloroplast RFLP variation in ten populations throughout the range of *A. mangium* indicated that eight types could be identified. One chloroplast DNA polymorphism was unique to the southern part of the natural range of the species, and is presently being used to determine the

Table 10.1-1: Genome size and sequence knowledge of some selected model organisms.

Organism	Genome size (Mb)	Percentage of genome sequenced ¹	5-year research goals 1993–98 ²
<i>Escherichia coli</i>	4.8	76.0	100% 1998
<i>Saccharomyces cerevisiae</i>	14.4	27.0	100% 1998
<i>Caenorhabditis elegans</i>	100.0	1.1	Near complete 1998
<i>Drosophila melanogaster</i>	165.0	1.8	50% 1998
<i>Mus musculus</i>	3000.0	0.3	Selected segments 1998
<i>Arabidopsis thaliana</i>	100.0	0.6	40 Mb 1999 ³
<i>Homo sapiens</i>	3000.0	0.6	80 Mb 1998

1. Hodgson 1992.

2. Source: Human Genome Management Information System (HGMIS). HGMIS is jointly sponsored by the NIH and DOE Human Genome Programmes.

3. Bevan 1994.

proportion of the Indonesian populations that originated from this region. Since field trials indicate that *A. mangium* from Papua New Guinea and Cape York is superior in volume growth to the accessions from southern populations, the DNA marker will provide a critical indicator for accessions to be included in a breeding programme (G.F. Moran, pers. comm.).

Approaches based on DNA and RNA sequences may be especially valuable in microbial collections (see 10.1.3.3.2).

10.1.3.3 DNA libraries and sequence data

The ability to decipher the biological information stored in DNA and correlate it with phenotypic traits is to a large extent synonymous with modern biotechnology. Given that an ultimate goal of biological research is to relate DNA to protein structure and function, and eventually to physiology, genome analysis projects aim at building databases containing information on nucleotide sequences of genes, genetic markers, and the function and chromosomal location of identified genes. The emerging biological paradigm is that of ‘all “genes” being known (in the sense of being resident in databases available electronically) and that the starting point of biological investigation will be theoretical... the reagents that the scientist uses will include a knowledge of the primary sequence of the organism, together with a list of all previous deductions from that sequence’ (Gilbert 1991).

Prerequisites for this paradigm are the availability of appropriate genetic maps and clones and of rapid sequencing technologies. The latter are essential given the size of genomes of most organisms (Table 10.1-1). Genetic maps allow the assignment of genes to specific chromosomal loci, the study of the interaction of genes located in different positions and the effects of this interaction on phenotypic characters. Physical maps

represent the position of DNA segments relative to a chromosomal landmark (low resolution mapping) or relative to the exact order of all contiguous segments in the chromosome (high resolution).

Complete genome analysis involves the construction of high-resolution physical maps and is well under way in some model organisms (Table 10.1-1). The construction of physical genome maps involves:

- purification of chromosomal DNA;
- cutting the DNA into fragments at specific sites;
- cloning the DNA fragments into vectors;
- establishing libraries of the clones;
- ordering the clones in their exact chromosomal sequence; and
- sequencing the nucleotides of all clones or of trait-related clones.

10.1.3.3.1 Role of DNA libraries and sequence data in biodiversity conservation. Storage in the form of sequence data, naked DNA, genomic and cDNA libraries and isolated chromosomes has distinct economic advantages as a complementary approach to conventional methods such as cryogenic storage of whole organisms, embryos, oocytes, semen, stem cells and stem lines. Although not a substitute for live collections, the rate of species extinction and the lack of resources to maintain the latter dictate alternative strategies permitting the conservation of genes for future utilization of potentially useful traits. The value of this approach is amply illustrated by the study of ancient DNA samples, preserved in fossil tissues of extinct organisms. The amplification of minuscule amounts of DNA degraded to fragments as small as 100–200

nucleotide base pairs long is achievable by PCR technology. Comparison of the DNA sequence of these fragments with present or past relatives of the extinct organism reveals evolutionary changes within the gene pool as a function of time. In other words, it provides a time clock for rates of speciation and/or extinction. Framing strategies aimed at limiting the erosion of biological diversity depends on this kind of knowledge, and gene banks are an essential element in the implementation of such strategies.

Another potential role of genomic banks is alleged to be the reconstruction of an extinct organism from DNA sequence data. Whilst this may be far-fetched on the basis of the complexity of interactions that influence gene expression, cell differentiation and development, it is perfectly feasible to 'reanimate' extinct traits by introducing them into new species (Pääbo 1993). It may, however, prove easier to reconstitute a virus if its complete nucleotide sequence is known. Smallpox virus is a case in point. This virus has been eliminated except for stocks in two highly contained facilities (Atlanta, USA and Moscow, Russian Federation). There is considerable controversy about the eradication of these remaining stocks. This would constitute the first deliberate elimination of a biological entity from the planet and would have a number of ethical ramifications. In addition, there are safety concerns about the possibility of synthesizing smallpox virus DNA (186 102 base pairs) from the published sequence data (Mahy *et al.* 1993).

10.1.3.3.2 Role of DNA libraries and sequence data in biodiversity assessment and utilization. Genetic variation is not always related to variation of morphological and chemical phenotype. Often the latter is controlled by the environment and is the quantitative expression of more than one gene. One of the significant findings of sequencing whole genomes is the discovery of genes that code for undetectable phenotypes and as such cannot be mapped by classical methods. Construction of physical maps of polymorphic regions and sequencing of parts only of the genome are advantageous in the study of genetic variation within populations and therefore particularly pertinent to assessing biodiversity (see Section 2.1).

On the other hand, physical mapping of multigenically controlled (quantitative) traits (e.g. drought tolerance, insect resistance, yield), or of several unrelated ones, is a much more effective way of selecting traits than relying on phenotypic characteristics, and therefore provides a powerful tool in the exploitation of germplasm. As mentioned earlier (10.1.3.1), taxonomic classification based on DNA and RNA sequence data provides new possibilities for establishing phylogenetic relationships. This is of particular value in the study of populations of microorganisms where phenetics are of little use in species characterization. Nucleic acid sequencing, mainly of 5S,

16S and 23S rRNA, has been used successfully in prokaryote taxonomy, enabling species and even strain characterization (see, for example, Stackebrandt *et al.* 1991; Roller *et al.* 1992). Given the value of microorganisms in ecological processes and as sources of high added value compounds, the accurate taxonomic classification of these life forms is very important.

The potential of rRNAs for delineating phylogenetic relationships and taxon identification has developed strongly over the last decade. The number of partial and full rRNA sequences available from the Ribosomal Database Project (RDP) is in the hundreds (see Section 8.9). The RDP supplies its users with rRNA data and software packages for various applications (Olsen *et al.* 1991).

10.1.4 Biotechnology as a tool for utilizing biodiversity for human benefit

The combination of chemical and DNA screening technologies with genetic engineering provides an extremely powerful tool for the exploitation of genetic resources. For example, medium chain fatty acids such as laurate accumulate in the seeds of tropical trees and are harvested for dietary and industrial purposes at the rate of at least a million tonnes annually. Knowledge that production of medium chain fatty acids is due to a specific protein (acyl carrier protein-BTE) has led to the cloning of the DNA of the gene coding for this protein from the Californian bay (*Umbellularia californica*). This gene can be introduced into an oilseed species and can increase the levels of laurate (Voelker *et al.* 1992).

Many people interpret 'biotechnology' in this very narrow sense of using genetic engineering for human benefit. It is the facet of biotechnology that is perceived to have the greatest economic implications, and the one that has the highest public profile. It is also the facet of biotechnology most strongly linked with ethical issues and concerns about biosafety, and is discussed in detail in the following chapter.

References

- Beattie**, C.W. 1994. Livestock genome maps. *Trends in Genetics* **10**: 334–338.
- Beeching**, J.R., Marmey, P., Gavalda, M.C., Moirou, M., Haysom, H.R., Hughes, M.A. and Charrier, A. 1993. The assessment of genetic diversity within a collection of cassava (*Manihot esculenta* Crantz) germplasm using molecular markers. *Annals Botany* **72**: 515–520.
- Bevan**, M. 1994. The European Arabidopsis Genome Sequencing Project. *The International Electronic Arabidopsis Newsletter* **1**: 10.
- Broad**, T.E. and Hill, D.F. 1994. Mapping the sheep genome - practice, progress and promise. *British Veterinary Journal* **150**: 237–252.
- Chase**, M.W., Soltis, D.E., Olmstead, R.G., Morgan, D., Les,

- D.H., Mishler, B.D., Duvall, M.R., Qui, Y., Kron, K.A., Rettig, J.H., Conti, E., Palmer, J.H., Manhart, J.R., Sytsma, K.J., Michaels, H.J., Kress, W.J., Karol, K.G., Clark, W.D., Hedren, M., Gaut, B.S., Jansen, R.K., Kim, K., Wimpee, C.F., Smith, J.F., Furnier, G., Strauss, S.H., Xiang, Q., Plunkett, G.M., Soltis, P.S., Swensen, S.M., Williams, S.E., Gadek, P.A., Quinn, C.J., Eguiarte, L.E., Golenberg, E., Learn, G.H., Graham, S.W., Barrett, S.C., Dayanandan, S. and Albert, V. 1993. Phylogenetics of seed plants: an analysis of nucleotide sequences from the plastid gene *rbcL*. *Annals of the Missouri Botanical Garden* **80**: 528–580.
- Fries, R., Eggen, A. and Womack, J.E. 1993. The bovine genome map. *Mammalian Genome* **4**: 405–428.
- Gellin, J. and Chevalet, C. 1994. Gene-mapping strategy – the pig as an example. *Genetics, Selection and Evolution* **26**: s35–s51.
- Gibbs, H.L., Prior, K.A. and Weatherhead, P.J. 1994. Genetic analysis of populations of threatened snake species using RAPD markers. *Molecular Ecology* **3**: 329–337.
- Gilbert, W. 1991. Towards a paradigm shift in biology. *Nature* **349**: 99.
- Gustafson, J.P., Appels, R. and Raven, P. (eds) 1993. *Gene Conservation and Exploitation*. Plenum Press, New York.
- Hodgson, J. 1992. Sequencing and mapping efforts in 'model organisms'. *Bio/Technology* **10** (7): 760.
- Lichter, P., Tang, C.J.C., Call, K., Hermanson, G., Evans G.A., Houseman, D. and Ward, D.C. 1990. High-resolution mapping of human chromosome 11 by *in situ* hybridization with cosmid clones. *Science* **247**: 64–69.
- Liu, Z. and Furnier, G.R. 1993. Comparison of allozyme, RFLP and RAPD markers for revealing genetic variation within and between trembling aspen and bigtooth aspen. *Theoretical and Applied Genetics* **87**: 97–105.
- Mahy, B.W.J., Almond, J.W., Berns, K.I., Chanock, R.M., Lvov, D.K., Pettersson, R.F., Schatzmayr, H.G. and Fenner, F. 1993. The remaining stocks of smallpox virus should be destroyed. *Science* **262**: 1223–1224.
- Moran, G.F., Muona, O. and Bell, J.C. 1989. *Acacia mangium*: a tropical forest tree of the coastal lowlands with low genetic diversity. *Evolution* **43**: 231–235.
- Norman, J., Moritz, C. and Limpus, C.J. 1994. Mitochondrial DNA control region polymorphisms: genetic markers for ecological studies of marine turtles. *Molecular Ecology* (in press).
- Olsen, G.J., Larsen, N. and Woese, C.R. 1991. The ribosomal RNA database project. *Nucleic Acids Research* **19**: 2017–2021.
- Pääbo, S. 1993. Ancient DNA. *Scientific American* **269** (5): 60–66.
- Prescott-Allen, R. and Prescott-Allen, C. 1990. How many plants feed the world. *Conservation Biology* **4**: 365–374.
- Roller, C., Ludwig, W. and Schleifer, K.H. 1992. Gram-positive bacteria with a high DNA G + C content are characterized by a common insertion within their 23S RNA genes. *Journal of General Microbiology* **138**: 1167–1175.
- Skerritt, J.H. and Appels, R. 1995. *Diagnostics in Agriculture*. CAB International, Wallingford.
- Stackebrandt, E., Witt, D., Kemmerling, C., Kroppenstedt, R. and Liesack, E. 1991. Designation of streptomycete 16S and 23S rRNA-based target regions for oligonucleotide probes. *Applied and Environmental Microbiology* **57**: 1468–1477.
- Szybalski, W. 1993. From the double helix to novel approaches to the sequencing of large genomes. *Gene* **135**: 279–290. [See also related articles in the same volume.]
- Voelker, T.A., Worrell, A.C., Anderson, L., Bleibaum, J., Fan, C., Hawkins, D.J., Radke, S.E. and Davies, H.M. 1992. Fatty acid biosynthesis redirected to medium chains in transgenic oilseed plants. *Science* **257**: 72–74.
- Warwick, S.I. and Black, L.D. 1991. Molecular systematics of BRASSICA and allied genera (Subtribe Brassicinae, Brassicaceae) – chloroplast genome and cytodeme congruence. *Theoretical and Applied Genetics* **82**: 81–92.
- Worthington Wilmer, J., Moritz, C., Hall, L. and Toop, J. 1994. Extreme population structuring in the threatened ghost bat, *Macroderma gigas*: evidence from mitochondrial DNA. *Proceedings of the Royal Society of London, B* **257**: 193–198.

10.2 Applications of biotechnology for the utilization of biodiversity

As described in chapter 10.1, biotechnology can be utilized for the assessment and evaluation of the enormous diversity of plant, animal and microorganism species still inhabiting our planet. Studies on the role of biodiversity in maintaining ecological equilibria have shown that the simple fact of existence of many species inevitably gives them a value. For some, of course, this is the highest value that can be given at present.

As human population pressure continues to increase, we are experiencing a rapid acceleration in the rate of degradation of biodiversity. Increasing efforts for food and fibre production will impact on marginal lands and wilderness areas, increasing the level of ecological disturbance. For socioeconomic reasons, which among other things involve the globalization of economies and intensification of production systems, this impact will be greatest where population growth is greatest, in developing countries and largely in the tropics. Accordingly, it is logical that there be strong demands for scientific advances that will increase the incentive and capacity of countries to conserve their existing biological diversity, such as, for example:

- assessment of the resource values of tropical forests;
- utilization, in breeding, of the wild relatives of domesticated plants and animals;
- search for undocumented species and investigation of their economic potentials; and
- soil rehabilitation.

This is not an easy task. For most known species, we do not have the necessary knowledge base to formulate sound development programmes. Even if there were substantial

increases in research budgets and numbers of trained biologists, the use of classical techniques alone could not possibly provide the short-term solution to the problem.

Fortunately biotechnology is providing new tools to help us in this endeavour, and for developing countries in particular it will be important to pursue the development and implementation of these new molecular techniques. However, it will be important that biotechnologists work together with ecologists to assemble rapidly the basic knowledge needed for evaluation of the genetic resource potential of biodiversity. Having the capacity to manage their genetic resources will enable countries to produce novel products derived from their own biodiversity, generating new income sources needed for development as well as the conservation of the natural resources.

Apart from its contribution to understanding the intrinsic ecological value of biodiversity, biotechnology can therefore also add to its economic value. The ability to assess biodiversity in whole or in part at the molecular level, through techniques such as DNA sequence analysis and markers, expands the reservoir of genetic resources that can be tapped by biotechnology. The combination of biotechnology and the conventional technologies of breeding and screening, as shown in the range of examples presented below, can speed up processes and often achieve targets that would have been unattainable with the use of conventional methods alone.

10.2.1 The scope of biotechnology applications

Biotechnology can be utilized in a wide range of applications, as outlined in Box 10.2-1. Living organisms can be used as factories delivering a variety of products, or targeted to a variety of end uses. They can be harnessed for environmental remediation, and also for various industrial processes. Biotechnology can improve the product yield and/or the efficiency of such activities.

Although biotechnology is commonly identified with genetic engineering, it supports a more diverse array of applications. In some cases, for example, conventional breeding is still more convenient for domestic plant and animal improvement, but nevertheless the use of molecular techniques can dramatically accelerate the breeding process (marker assisted breeding, see 10.2.2.1).

Other approaches which can overcome interspecific barriers, mostly in plants, are *in vitro* culture techniques, including *in vitro* fertilization or pollination, embryo rescue, cell fusion and somatic hybridization (10.2.2.1). Micropropagation is often an efficient means of plant multiplication, avoiding long generation times. Furthermore *in vitro* culture can increase diversity by somaclonal variation or mutagenesis. Fermentation methodologies can be improved by adapting the media and selecting for better performing cells. Another application of

biotechnology is the development of disease diagnostic kits, based on enzymes, antibodies or DNA probes (10.2.2.1). Sophisticated separation instrumentation (such as HPLC and counter-current chromatography) for natural product utilization is routinely used in biotechnology.

Nevertheless, genetic engineering opens a new spectrum of possibilities, because it breaks barriers between species, genera, families and even kingdoms, making available the entire gene pool for crop or livestock improvement (10.2.2.2). Production of subunit or even synthetic vaccines (10.2.2.2) is now possible, offering tremendous improvements in efficacy and purity. Because of this broad spectrum of application for human benefit, there are many biodiversity-based rural and manufacturing industries for which biotechnology is key to improving production efficiency, product diversification and sustainability of output. Some examples are listed in Box 10.2-2.

When the values of biodiversity are considered, attention is often focused on higher plants and animals. Viruses, microorganisms (bacteria, fungi, miomaleae) and other more complex microscopic species are often overlooked. The biochemical versatility and diversity of bacteria and fungi in particular represents an enormous variety of genes that are still unknown. More and more useful gene functions are being discovered, particularly for environmental remediation and industrial processes (Box 10.2-1). The heat stable Taq polymerase, which has revolutionized biotechnology, also has a bacterial origin (*Thermus aquaticus*). The early successes in plant genetic engineering often involved bacterial genes: these have included an endotoxin gene from *Bacillus thuringiensis* for insect resistance, a herbicide (basta) resistance gene from *Streptomyces hygrosopicus*, and a ribonuclease gene from *Bacillus amyloliquefaciens* for male sterility. Microorganisms also provide numerous antimicrobial compounds. Clearly microbial diversity should be considered in conservation and assessment programmes.

10.2.2 Improving production and sustainability

A major aim of biotechnology is to improve production, quantitatively as well as qualitatively (e.g. increased nutritional value). Disease resistance and stress tolerance dramatically improve yields. Improvements depend on the introduction of new genes or the modification of endogenous genes. Chimaeric genes with enhanced or reduced expression can be constructed and tuned to specific cell types or developmental stages. Alternatively, by spontaneous or induced mutagenesis, desired new characteristics can be screened or selected. However, most improvement strategies at present utilize genes already existing in the available biodiversity gene pool, from closely related lines or wild relatives to distantly related

Box 10.2-1: Areas of application of biotechnology in biodiversity utilization.**Using transgenic animals, plants and micro-organisms as sources of**

- *proteins and peptides*: structural and storage proteins; peptide hormones (insulin, growth hormones) and antibodies; all kinds of enzymes;
- *lipids and fatty acids*: animal and vegetable oils; essential oils;
- *carbohydrates*: cellulose, agar, pectin, chitin;
- *secondary metabolites*: diverse organic substances utilizable for example as pharmaceuticals, food additives and biopesticides.

Targeting plants/animals/micro-organisms to specific end uses. Genetic engineering, breeding and in vitro culture systems can be used to:

- *enhance agronomic performance*: yield, disease resistance, stress tolerance and more.

Improving environmental maintenance/rehabilitation, through:

- *identification of soil micro-organisms by fingerprinting*: determining the best combinations for soil rehabilitation (nitrogen-fixing bacteria, mycorrhizae, bacteria capable of degrading pollutants, etc.);
- *use of plants naturally capable of accumulating high doses of heavy metal ions*: e.g. cadmium, zinc;
- *engineering the key bacterial genes involved in pollutant degradation*: improved clean-up efficiency;
- *improving plant microbe symbiotic systems*: for waste water treatment (controlling water hyacinth, reeds, duckweed);
- *production of biosurfactants, bioplastics and other biodegradable products from micro-organisms*: improving production by modifying biosynthetic pathways.

Enhancing the efficiency of microorganisms in industrial processes, such as:

- *microbially-enhanced secondary recovery of oil from reservoirs*;
- *bioleaching*: microbiological extraction of metals from often low grade ores;
- *production of industrial enzymes*: for the food industry; and for a variety of other production processes;
- *production of endogenous products*: enhancement of microbial fermentation for production of, for example, antibiotics, alcohol and organic acids.

organisms. These features can be introduced mainly via breeding and genetic engineering.

10.2.2.1 Biotechnology-assisted breeding in crop plants

Biotechnology provides important new tools with which to enhance the breeding process. Because of the high variability of the DNA sequences that comprise the genome, specific fragments can be found that are linked to

a trait that is known only by its phenotype. Such **DNA markers** can be identified in the seedling stage, and are independent of tissue or environmental conditions. A procedure to quickly link a DNA marker to a phenotypic character is **bulk segregant analysis** (Michelmore *et al.* 1991). Two bulked DNA samples are generated by pooling individuals that are identical for a particular trait or genomic region but arbitrary at all unlinked regions. The

Box 10.2-2: Biotechnology in the service of industries.

Rural industries. These may use biotechnology in many ways, including identification, by fingerprinting, of varieties and wild relatives; creation of new varieties or races using modified endogenous genes or genes from wild relatives or from other organisms through marker-assisted breeding, genetic engineering or *in vitro* techniques; gene manipulation for increased yields, improved nutritional value, disease resistance or stress tolerance; disease diagnosis by use of DNA markers, antibodies or enzyme assays; subunit vaccines; etc. in:

- *Agriculture*: especially for crop varieties and domestic animal breeds;
- *Forestry*: especially marker-assisted breeding for reduced generation time;
- *Aquaculture/mariculture*;
- *Horticulture, including production of ornamentals*: especially genetic engineering for qualities such as enhanced flavour and shelf life.

Manufacturing and processing industries. These industries generally make use of chemical compounds produced by plants, animals or micro-organisms (see Box 10.2-1: plants/animals as sources). Biotechnology can assist in: screening and extracting compounds of interest, as well as in enhancing the production of desired components via cultivation; *in vitro* cultures (cell-, root-, callus-, etc.); selection or screening of highly productive varieties (at cellular or whole organism level); mutagenesis; identification of important biosynthetic genes, cloning and production of derivatives from bacteria, yeast or plants, for:

- *Pharmaceuticals*: e.g. anti-cancer derivatives such as vinblastine and vincristine (from *Catharanthus roseus*) and taxol (from *Taxus brevifolia*); anti-malaria derivatives such as artemisinin (from *Artemisia annua*); subunit vaccines; antibiotics;
- *Cosmetics*: e.g. copaiva balsams and fragrances;
- *Food additives*: flavours, natural dyes, antioxidants; vitamins;
- *Energy*: e.g. carbohydrate fermentation for alcohol production; alternative biofuels such as *Jatropha* oil (*Jatropha curcas*);
- *Chemicals*, including: natural alternatives for biopesticides (e.g. pyrethrins from *Tanacetum cinerariifolium*; azadirachtin, a potent insecticide from neem); natural dyes (e.g. indigo, saffron, safflower); bioplastics, such as polyhydroxyalkanoic acids; biosurfactants, including oil derivatives such as soaps and detergents, surface coatings for paints, varnishes and printing inks, lubricants and hydraulic oils; linoleum;
- *Other manufacturing products*, including construction materials (e.g. timber, bamboo, rattan, teak, mahogany); textiles, ropes, paper (e.g. hemp, cotton, flax, jute); leather tanning.

Extractive industries. These utilize microbiological extraction of materials of low concentrations (Box 10.2-1), for example bioleaching, or materials recalcitrant to physical or chemical extraction (e.g. enhanced secondary recovery of oil). Biotechnology also has a potential role in the recycling of industrial residues (from pulping and paper manufacture, timber milling, fish processing, etc).

two bulks are therefore genetically similar in the selected region but seemingly heterozygous at all other regions. The pools are then screened for differences at the DNA level. DNA markers that are polymorphic between the pools will be genetically linked to the loci determining the trait used to construct the pools. Once a linked DNA marker has been identified it is a straightforward procedure to follow the selected trait through the successive generations and thus to develop the high-quality strain with the desired

combinations of traits ('marker assisted breeding'). When combined with methods of enhancing flowering and thus seed setting, the effort and time required to obtain commercially available breeds is dramatically reduced.

10.2.2.1.1 Molecular markers for rapid selection. To produce new varieties, desirable genes have to be incorporated and/or undesirable genes eliminated or replaced. If a domesticated race is being crossed with a wild relative this almost always results in the incorporation

of large numbers of undesirable genes along with the few desired ones. Several further rounds of crossing and selection are then necessary to eliminate these undesirable genes. Selection is often the rate-limiting step in improvement, mainly because the breeders depend on observing the final products of gene action and sometimes individuals have to be grown to maturity to select genes influencing the final product, such as yield. Genetic maps based on molecular markers present the breeder with a new set of tools to attack these traditional breeding problems. The maps consist of molecular markers that are distributed at fairly regular intervals over each of the chromosomes. Each gene will then of necessity be linked to one or more markers. By analysing segregation patterns of both the gene and the markers in the crosses, co-segregation can be used to determine which markers are linked to the gene. This indirect selection of the lines that contain new traits can be done on a large number of young individuals, reducing losses in time and expense compared to a traditional breeding programme where selections can only occur on the final product of the gene action. Marker-assisted selection is especially interesting for short-term breeding programmes, designed to develop new varieties quickly or to incorporate a new trait into an existing and otherwise desirable genotype. Detailed linkage maps saturated with RFLP markers are now available for several crops including tomato, maize, oilseed rape and sugarbeet (Bosemark 1993).

Marker-assisted breeding in forest trees presents a unique and interesting challenge, because inbreeding is generally not possible, multi-generation pedigrees are rare, generation times are long and resources are limited. The high heterogeneity that exists in most forest trees can be used to great advantage in mapping since it is a rich source of genetic diversity. Molecular marker maps based on RAPDs are available for various forest trees including *Populus*, *Eucalyptus*, white spruce and loblolly pine, and are currently being used as tools to identify and dissect Quantitative Trait Loci, in which the molecular basis is complex (Neale 1993; Kinlaw and Harry 1994). The advantages of the haploid genetics offered by conifer megagametophytes are also exploited for mapping work.

Crops can be protected against parasites and pests by cultural practices, application of biological control agents or pesticides, and the introduction of genetic resistance into the crop. However, breeding for genetic resistance has many advantages: the use of resistant cultivars reduces the pollution caused by pesticides, and even if the resistance does not protect the crop completely, partial resistance can lead to a marked reduction in the dose of pesticide required to provide satisfactory control. Moreover, a partially resistant crop will exert no (or only limited) selective pressure on the parasite. The sacrifice of a few plants can prevent the emergence of a new resistant parasite. Working

with a sufficiently heterogeneous population is necessary, since an inbred line can be completely destroyed when confronted with an adapted resistant parasite.

There are only a few drawbacks to resistance breeding. One important problem is that it takes a long time to introduce resistance into a crop. However, if genetic maps are available and markers co-segregating with the trait have been identified, screening for resistance can be done quickly at an early stage. Several programmes to identify co-segregating markers are in place, and different molecular markers linked to the Lr9 leaf rust resistance gene of wheat, the crown rust resistance gene Pc68 in oats and the rhm resistance gene to southern corn leaf blight in maize have been identified and localized (Schachermayr *et al.* 1994; Penner *et al.* 1993; Zaitlin *et al.* 1993). Resistance is often effective against only one parasite, and therefore the effort to introduce and maintain genes for resistance needs to be repeated for each cultivar and for each target parasite species. Additionally, the cultivar should not only be resistant but also produce a high-yielding good quality crop.

10.2.2.1.2 Techniques for wide crosses. Interspecific and intergeneric crosses have long been attempted by breeders in order to combine characteristics of different species. Unfortunately, interspecific pollination, *in vitro* or *in vivo*, frequently fails because the pollen tubes are incompatible with the pistil and stop growing before they reach the ovules. Thus the number of fertilized ovules obtained is very low, and when hybrid embryos do develop the failure of normal endosperm formation often leads to their degeneration. Embryos of such unsuccessful crosses can develop into normal hybrid plants on an artificial medium *in vitro* (endosperm replacement). The embryos can be rescued from the ovule several days after pollination, then followed by *in vitro* culture, or can be cultured *in vitro in ovulo* for a certain period after which the embryo is isolated.

These techniques have been practised for many wide crosses within both dicotyledons and monocotyledons (Foroughi-Wehr and Wenzel 1993). For example, red clover ($2n = 14$), an important forage legume, is normally of limited utility because of lack of persistence. Interspecific hybridization between red clover and *Trifolium alpestre* ($2n = 16$) using *in vitro* embryo rescue, results in a hybrid that resembles *T. alpestre* more strongly than the paternal parent, red clover. The hybrid exhibits the expected somatic chromosome number (15) and is functionally sterile in both male and female floral parts. This new hybrid combination may be useful for the future improvement of red clover if the infertility barrier can be overcome (Phillips *et al.* 1992).

As early as 1909, protoplast fusion was proposed as another possible way to produce new hybrid forms while eliminating all sexual barriers. No barriers exist to the fusion of cells of different species and families, but often

incompatibility reactions occur at various levels after the fusion, and the hybrids cannot regenerate or else give rise to highly abnormal and sterile organisms. These cell fusion products could not be introduced into breeding schemes, and led to the search for methods for transferring only part of a plant genome to allow the synthesis of partial but fertile hybrid plants. One of the solutions for chromosome elimination is the use of irradiated donor protoplasts, where the chromosomes are broken and the chromosomal fragments are transferred to the recipient genome after fusion. By this method Dudits *et al.* (1980) restored chlorophyll synthesis in a carrot albino mutant by fusion with irradiated parsley protoplasts. The production of these asymmetric nuclear hybrids between distant species allows sexually limited exchanges to be overcome, and offers many possibilities if polyploidy or the absence of fertile sexual organs, often the case in vegetatively propagated plants, is a restriction to gene exchange.

10.2.2.1.3 Disease screening. There is a significant deficit between realized and potential crop yields, and the losses due to parasites (pathogens and pests) are considerable. To prevent major losses it is important to detect and identify pests at an early stage. The development of molecular markers has introduced a new generation of diagnostic kits which can detect the invading parasite on the basis of its genetic material. This is in contrast to the immunoassay kits that detect the protein antigens that the invading organism produces. Molecular marker diagnostic kits, particularly for medical applications, are of much higher levels of sensitivity. Additionally, the creation of DNA primers that detect specific pathogens is both far more rapid and far more economical than immunological approaches.

Roosien *et al.* (1993) demonstrated that RAPD markers provide a basis for the development of a diagnostic assay to differentiate the potato cyst nematode species *Globodera rostochiensis* and *G. pallida*. Another highly sensitive PCR-based assay is used for the detection of plant viruses such as the potato virus Y and the fungus that causes blackleg disease on canola (Hataya *et al.* 1994; Landry *et al.* 1994). The claimed sensitivity of the test for blackleg disease is so high that as few as four spores of the fungus can be detected. It also differentiates between the aggressive and non-aggressive isolates, even in a mixture of DNAs. These levels of specificity and sensitivity allow the test to be performed on crude samples from seed, plants and stubble. For example, seed is simply boiled in a microwave oven and the DNA is extracted, incorporated in the assay and the result is available on the following day.

10.2.2.2 Genetic engineering

The most sophisticated way of improving domesticated species is through genetic engineering. This involves a DNA sequence of diverse origin (plant, animal or micro-

organism) being introduced into another genome, irrespective of how distantly the two are related. Notwithstanding its elegance, in the near future genetic engineering will not be able to provide universal solutions for the improvement of domesticated breeds and cultivars. The molecular basis of many agronomically and industrially important traits is often complex, owing to the number of gene loci involved (Quantitative Trait Loci). In such cases molecular-assisted breeding might be a more fruitful approach. However, there is still a considerable number of traits controlled by one or a few genes, and genetic engineering can be utilized, both for industrial and agronomic applications. For the key techniques see Box 10.2-3.

10.2.2.2.1 Applications of genetic engineering. The range of applications of genetic engineering is continuously extending. Very exciting new fields, for example, are industrial crop improvement and the development of a new class of vaccines. Now opportunities are arising, for example, in forest tree breeding, where long generation times mean that conventional breeding programmes are very slow.

The molecular basis of many agronomically and industrially important traits is often complex, depending on biochemical pathways with many steps, each regulated by one or more enzymes. As our knowledge of the genes that produce these enzymes increases, it is becoming possible to use genetic engineering to modify biosynthetic pathways. Genetic engineering is therefore no longer confined to the manipulation of single-gene traits such as disease or toxin resistance, but now also provides opportunities to change the nature and quality of many organic products. Some examples are presented below.

Because of the very high profile of genetic engineering in biotechnology, and its great potential for improvement of human well-being, the topic is further developed below under different headings. These relate to the variety of different outcomes that can be sought using genetic engineering; they may involve different techniques, and they commonly involve different biological processes and different target organisms. Examples involving both plants and animals are given.

Increasing productivity. Husbandry of domestic animals is a conservative practice, mostly using familiar animals in new combinations to generate new or modified phenotypes. This conservatism is a direct consequence of the large investment of money and effort required to generate new breeding lines. In the United Kingdom, for example, the principal bovine artificial insemination scheme uses semen from only a few hundred animals of superior pedigree. In aquaculture there is a greater willingness to embrace new organisms, perhaps related to the economic advantages of shorter reproductive cycles, but this is restricted in part by public acceptance. In all these systems, however, the desire for a consistent 'product' requires that the smallest number of parents is used to produce suitable breeding lines.

Box 10.2-3: Genetic engineering.

Key technologies. The main problems genetic engineering still has to cope with are the development of procedures to obtain fully transformed individuals, and the identification and characterization of genes of interest. Nevertheless, our capacity to genetically engineer living species is growing exponentially, and the research effort itself continues to grow. It is likely that gene transfer will become routine, and that for any newly discovered species or strains it will be possible to develop specific gene transfer protocols. This box briefly summarizes the technical basis of genetic engineering, using plants as the example.

Identification of the foreign DNA. In order to capitalize on our ability to transform plants, it is obviously necessary to identify and isolate the genes controlling the traits that are of interest to breeders. Some genes were originally isolated without their function being known, this being revealed only when the gene had been altered. In microorganisms genes can be isolated easily by complementation of specific mutants. Often genes are isolated by using a homologue from another organism. A very interesting method of finding the gene that corresponds to a certain phenotypic trait is 'chromosome walking', which makes use of DNA marker based genomic maps.

Gene manipulation (e.g. regulation of gene expression). Many genes are not expressed continuously in the plant, but are turned on and off by other genes (promoters). There have been many advances in knowledge of the regulation of gene expression, and of the promoter sequences involved. By linking a novel gene to an appropriate promoter it is possible to specifically target the expression of the gene to a certain tissue (e.g. anther, root, xylem or seed) or even developmental stage (e.g. seedling). It is also possible to modify expression levels: by using or modifying specific promoters, the level of gene expression can be dramatically increased or decreased. It is also possible to knock out a certain gene, for instance by introducing an antisense orientated gene. The corresponding transcript is complementary to the normal one, and by hybridization translation is inhibited.

Transformation. The foreign DNA must be incorporated into the genome of the plant being engineered. Originally the crown gall microbe, *Agrobacterium*, was exploited for this purpose. This organism transfers some of its DNA to its host's nuclei, thus performing a natural genetic engineering process. Subsequently various transfer procedures for naked DNA have been developed. These include polyethylene glycol treatment, electroporation and micro-injection as ways of bringing the foreign DNA to the target nuclei. Recently the most spectacular progress has been made through the development of microprojectile bombardment (DNA gun). Microscopic metal particles coated with the foreign DNA are ejected at high velocity to deliver the DNA into the plant cells.

Regeneration. The new or modified DNA (gene construct) is usually delivered to the nuclei of individual cells of the plant being engineered. It is therefore necessary to be able to regenerate fertile adult plants from these cells, using culture techniques. However, many important crops, such as legumes, cereals and commercial tree species are still very recalcitrant to regeneration. Some alternative procedures have been developed.

Regeneration alternatives. As well as exploring different means of DNA delivery, different tissues and cells have been used to avoid problems with regeneration. Although plant cells are generally considered to be totipotent and thus apparently easy to regenerate, this is often not the case. Tissues such as premature embryos, mature and germinating pollen, and apical, flower and anther meristem, which avoid *de novo* organogenesis, are more successful targets.

How might biodiversity and biotechnology interact to increase productivity of our farm animals? It seems likely that use of biodiversity as a resource for beneficial characteristics will be a slow process. This is largely because our understanding of physiological processes is in many cases inadequate: we often do not know which gene or protein is responsible for conferring the characteristic that we wish to modify or use in farm animals (see above). Our current understanding of reproduction, development, growth and feed conversion, the objective of much biotechnology, is founded on reductionist science. This approach, although essential for most research, does not lend itself well to alteration of organismal physiology or use of the full spectrum of biodiversity. Many of the approaches used to date focus

on clear targets, such as growth hormone (Pursel *et al.* 1989), for which defined effects have been obtained from protein studies. There are, nevertheless, some trends that indicate that our appreciation of physiological processes and our ability to map and to manipulate genomes will improve in concert.

Transgenic biology is founded on the identification, isolation and modification of genes (Box 10.2-3). Transgenesis currently uses only few genes at a time. However, different research groups have recently developed techniques for transferring large numbers of genes, using 'cosmids' (vectors that can carry 40 000 base-pairs of DNA) or yeast artificial chromosomes ('YACs', which can carry millions of base-pairs of DNA). Many research groups are actually trying to develop mammalian

artificial chromosomes (MACs) which could be used for direct transfer of large regions of DNA. Despite these opportunities it seems likely that, in the industrialized world, the farming community will continue to rely on the tried, the (partly) understood, and the familiar. Most approaches to alteration of productivity (growth rate, carcass composition, reproduction) will use genetically engineered constructs of single genes (perhaps modified *in vitro* to enhance the efficiency of their gene product). The expression of these genes may be enhanced (to increase or modify protein production) or targeted to an alternative site (Box 10.2-3).

Areas where the use of biodiversity appears to have a more immediate role are in stress tolerance and reproduction. The physiology of both these processes is poorly understood. However, the diversity of tolerance to environmental stress is a natural consequence of evolution, one that is often bred out of domesticated species in developed countries. Transfer of the appropriate gene(s) would lead to increased productivity, especially for animals on poor feed, but also for many farm animals in developed countries. The mapping procedures outlined above will be an essential part of this strategy.

Reproductive capacity, the ability to produce offspring that reach maturity, depends on a suite of factors from fertility to the quality of mothering. A small number of traits, such as the Booroola gene in sheep which predisposes towards twin births, have been identified, but the emphasis is on our current stock of domesticated species.

Over the next 10 to 20 years, the interaction of biodiversity and biotechnology is therefore likely to be neutral in its effects on animal productivity. The contribution that biodiversity in general can make is largely unknown because of insufficient information or because the information is not organized into an accessible form. Projects to formalize this information would be an important prerequisite for its use.

Direct productivity improvement in plants through genetic engineering is still a difficult task. However, some successes have been achieved indirectly. Hybrid vigour (heterosis), the remarkably higher vigour of hybrid varieties compared with both parent lines, is reflected in higher yield, increased resistance to disease, and enhanced performances in different environments (see Section 2.2). The production of hybrid seeds depends on the avoidance of self-pollination, which is often difficult to achieve. Through genetic engineering, a ribonuclease gene from *Bacillus amyloliquefaciens* was specifically expressed in the tapetum, disrupting this nutritive tissue essential for pollen development, and in this way male sterile plants were obtained which can only cross-pollinate.

Increasing environmental stress tolerance is another indirect way to increase productivity. Notwithstanding it being a complicated phenomenon, impressive progress has

been made and the first strategies for improving stress tolerance by genetic engineering have emerged. An example is oxidative stress. Reactive oxygen species play an important role in the damaging effects of many stress conditions. Over-expressing genes involved in reactive oxygen metabolism have already resulted in higher tolerance to cold, heat and ozone.

Controlling disease. Animals seek to minimize the effects of pathogens through many levels of defence mechanisms, from mechanical to molecular. In principle, modulation at any of these levels might result in improved disease resistance. Veterinary medicine in the West has always followed the approach of human therapy, laying emphasis on treatment rather than avoidance or prevention of diseases. Biotechnology, perhaps together with biodiversity, offers new opportunities to alter this balance. Natural and feral populations of relatives of our farmed animals often display different sensitivity to disease, and are a valuable resource of potentially important traits. Our increasing understanding of the roles of receptors for pathogens, of the immune system, and of cytokines is beginning to illuminate new possibilities for molecular intervention.

There are two main routes to disease resistance: to stimulate the host defence, for example by a vaccine, and to modify the host so that it is no longer susceptible, or at least less susceptible, to the pathogen. Either route could potentially make great use of biotechnology and biodiversity. Vaccines are being revolutionized by biotechnology, with methods being brought to bear on prevention of infectious diseases (Rabinovich *et al.* 1994). However, the majority of the searches for improved vaccines (more effective, more specific, safer) are being developed using components (genes or proteins) from known pathogens. The vectors for vaccine delivery will most likely be those that have been tested and found to be safe. Vaccination has also been proposed as a route for pest eradication, especially in Australia. Here the approach is to use immunocontraception, rendering the animals immune to gamete-associated antigens such as zona pellucida proteins or sperm proteins (Bradley 1994; Boyle 1994). Target species include the mouse, rabbit and fox. Clearly a requirement for such an immunocontraceptive vaccine is that they are entirely species-specific. There is considerable optimism that this is so, for the process of fertilization is itself a very species-specific event. In addition, some virus vectors are species-specific. However it will be necessary to confirm no reaction of, for example, a fox vaccine against domestic or feral dogs. Equally important, the release of a vaccine must be controlled to prevent spread of the vaccine to areas where the species is *not* a pest species (Tyndale-Biscoe 1994).

As mentioned above, disease resistance can be enhanced by intervention at any one of several stages of the

infectious cycle of the pathogen. Because each pathogen has a unique cycle, and because each response by the host is unique, it is normally not possible to generate general protocols for enhancing resistance. It truly is a case-by-case approach. However, there are many instances of quantitative differences in heritable disease resistance or tolerance (Freeman and Lindberg 1993; Klein 1993).

As described above, mapping and isolation of the genes encoding such traits should become a more rapid process using new technologies. In a similar vein, a useful catalogue of resistance to common diseases amongst domesticated and feral breeds would be an enormous, albeit an extremely useful, task. However, where the basis for resistance can be identified at the molecular level then there is the opportunity to use molecular methods as an initial screen of large numbers of breeds.

Crop protection is also a major objective in plant breeding, and most of the attention in genetic engineering has been directed to this area. Developing pathogen-resistant varieties is the ideal sustainable alternative for crop protection through toxic pesticides. Classical breeding for pathogen resistance may be very cumbersome as often the genes for resistance are not present in sexually compatible varieties. In the cases where only one or a few genes are mostly sufficient to obtain resistance, genetic engineering may be a preferable approach for conferring resistance to pathogens.

Different strategies have been developed for different pathogens. In many cases microbial genes have been used, but genes from wild relatives or distantly related plant (and animal) species are also good sources. Against insects the endotoxin gene from *Bacillus thuringiensis* has been engineered. For viral resistance, sequences of the virus itself have been introduced into the plant in order to interfere in the viral life cycle. Antimicrobial compounds from grasses, fungi (*Trichoderma*, *Aspergillus*), bacteria and animals (insects, rat, cow) are being used to obtain resistance against fungi and bacteria. Finally, finer tuning of endogenous, general resistance mechanisms in the crop of interest is another promising strategy for pest and disease resistance.

Improving product quality or novelty. As with changes in productivity, changes in quality or novelty are likely to come from classical breeding allied to the use of genetically modified genes. In the medium term, these genes will most often be selected from known sequences. The vast potential resource of biodiversity will remain largely untapped for some time. And, as with productivity, this lack of use largely reflects a lack of useful information.

Human blood and human tissues have been the raw materials for the preparation of many therapeutic compounds. With the development of transgenic biology, the spare synthetic capacity of the blood system or the mammary gland of farm animals is a viable alternative

means of producing these compounds (Carver *et al.* 1993; Swanson *et al.* 1992; Ebert *et al.* 1991). This novel means of producing biopharmaceuticals, sometimes called 'pharming', is likely to be a significant area of development and exploitation. It is also likely to involve the use of established breeds of animals using well-understood gene products. However, one important role of biodiversity, especially of plants, is as a well-spring of entirely novel therapeutics. Farm animals, used as bioreactors, can produce large quantities of 'foreign' protein. To use biotechnology in this way to synthesize such novel therapeutics will maximize the use of biodiversity while minimizing the use of the species of origin and consequently the possibility of driving them to extinction. As the efficiency of animals as bioreactors improves, and much improvement has already been seen, so their use becomes more scientifically, industrially and economically sound. It is likely that many medium-term changes in the quality of products derived from farm animals will follow the same pattern. Injection of growth hormone protein induces an increased ratio of lean:fat tissue in the carcasses of pigs (Machlin 1972). Transgenic animals containing a growth hormone gene show similar changes (Vize *et al.* 1988; Pursel *et al.* 1990; Wieghart *et al.* 1990). But these examples also demonstrate the inadequacy of our physiological subtlety: pigs subjected to either method of raising levels of growth hormone displayed health and welfare problems. It is likely that such problems will be overcome as our understanding of the natural processes increases and as the sophistication of gene constructs improves.

Most of the domestic species in industrialized countries have been carefully selected over centuries to maximize their productivity in domesticated circumstances. However, recently consumer-led demand for higher quality, more 'natural' products has led to an erosion of common farm practices and an increase in more 'natural' farming methods. In concert with this, some suppliers have emphasized the use of less domesticated or less popular breeds. It is not possible to predict the extent to which this trend will continue, but the available domestic breeds and indeed their less domesticated counterparts will be an important resource for future diversity through conventional breeding programmes and possibly through gene transfer.

Although the initial efforts in genetic engineering were directed mainly towards the improvement of agronomic crop performance, various industries have discovered the potential of this field for industrial crops. As described above (Box 10.2-1), plants can be utilized as chemical factories synthesizing a wide variety of useful compounds.

Although underlying biochemical pathways are often very complex, by changing the expression level of a single

gene or a few genes, the whole pathway can be reorientated. Starch, for instance, is increasingly the focus of material applications such as the production of biodegradable polymers. By modifying the activity of some key enzymes, starch types with different chemical composition are produced by the plant. Another example involves cellulose, the basis for paper production, which is associated with lignin in the walls of the xylem cells in wood. Research aims to engineer trees with partially reduced lignin content to reduce the difficulty and energy needs of the pulping process.

Plant oils, with their very wide range of applications (Box 10.2-2), are becoming an exciting domain for genetic engineering. In oilseeds, for example, it is possible to alter the proportions of unsaturated fatty acids, so that desirable fatty acids or oils will accumulate as the end product. Polyhydroxyalkanoic acids, which can be used as bioplastics, can be synthesized in oilseed rape by cloning into the latter the biosynthetic genes of these acids from the bacterium *Alcaligenes eutrophus*. New plants are being discovered or rediscovered, such as the African *Jatropha* which produces a good diesel substitute. Similar approaches can be followed to augment the synthesis of secondary metabolites.

10.2.3 Using biodiversity for environmental remediation

Biodiversity is the key resource for the rehabilitation and remediation of degraded and contaminated ecosystems. Biotechnology applications are of increasing importance to these efforts, enhancing both the specificity and the efficiency of remedial actions.

As is clearly evident world-wide, environments and ecosystems can be degraded through excessive modification, such as land clearing, and unsustainable exploitation for production. They can also be degraded in the sense that one type of land use may make them unsuitable for conversion to another type of use. Rehabilitation objectives may therefore involve the restoration and/or conservation of 'natural' ecosystems, or the maintenance of the original or altered production systems (see Section 13).

Some examples of biotechnology-driven management solutions for conservation objectives are presented in 10.1.2.2. Other examples, relating to production systems, include:

- genetic characterization of strains of ectomycorrhizal fungi which may be important as inoculants for reforestation of lands with a long history of intensive cropping;
- genetic characterization of rhizobia in situations where recovery plans for perennial native legumes are being developed; and

- use of DNA probes to screen soils for general changes in biotic composition resulting from land-use practices.

As is also clearly evident, environments and ecosystems can be degraded by excessive release of chemicals into them. A more specific and very significant aspect of environmental rehabilitation is the repair of such contaminated ecosystems. Further discussion below is confined to the utilization of microbial diversity for remediation of contaminated ecosystems.

Chemical contamination of our environment has been a highly visible and undesirable outcome of industrialization. Environmental clean-up is now a global issue, and has become a matter of global interest and action. Biological technologies for remediation, especially microbial ones, are often sought because they are usually less expensive than mechanical ones. This is because:

- bioremediation can often be carried out *in situ*, eliminating or greatly reducing costs for soil excavation and movement;
- the biological catalyst multiplies at the expense of the pollutant, thus naturally enhancing the remediation rate; and
- low cost resources are usually needed to implement the technology.

Bioremediation is therefore likely to become a preferred technology for clean-up of earlier wastes as well as to cleanse current waste streams. It utilizes the great diversity of organisms in nature and their catalytic enzymes, because it is this variation that results in the often novel biotransformation capacities. Considerable variation has evolved during nearly 4 billion years of microbial life on Earth, and it is this variation that provides the wide variety of transforming enzymes, tolerance to environmental stress conditions, and variety of respiratory processes that are key features for bioremediation.

10.2.3.1 Factors that limit bioremediation

Biodiversity promises solutions to a number of the factors that are limiting to bioremediation. These limitations are usually due to:

- the lack of any known organism with the capacity to transform a pollutant;
- environmental features that are limiting; or
- the absence of the appropriate organism at the particular pollutant site.

The lack of evidence of a biotransformation may simply mean that scientists have not looked extensively enough for the desired phenotype. It is likely that only a few per cent

of the microorganisms that exist in nature have been discovered, but if nature has not produced a gene for the desired transformation it is now feasible to consider constructing the desired protein by genetic engineering (Janssen and Schanstra 1994).

Environmental limitations to bioremediation include the following:

- The environment may be toxic owing to the presence, for example, of other contaminants, acidity, alkalinity or salts. However, microorganisms that can withstand these stresses are known, and some of the genes that confer tolerance to such stresses are also now known.
- Many of the soil and sediment environments containing pollutants are anaerobic. However, recent discoveries of new anaerobic biodegrading organisms suggest that some remediation may be achieved under anaerobic conditions.
- Some pollutants are tightly sorbed to soil, thus reducing their availability to organisms. Some microorganisms, however, produce surfactants that may be useful in enhancing the bioavailability of the pollutant to the degrading organism.

All of these improvements in bioremediation therefore rely on nature harbouring a great diversity of genes and organisms, and on the discovery of these organisms so that they can be utilized to overcome the potential limitations.

If effective biodegrading organisms exist, but are not present at the remediation site, then inoculation (bioaugmentation) with the desired organism can be attempted. Bioaugmentation can also be attempted with genetically engineered organisms. However, it is not easy to disperse inoculated organisms throughout a site because they are filtered out by soil and sediment particles (Harvey 1993). Some work has been done on selecting organisms modified in their adhesive properties to aid dispersal in aquifers.

The most easily managed bioremediation is when the pollutant serves as a growth substrate for the microbe, because selection will then naturally enhance both the degradation rate and dispersal. However, some of the newer, promising remediation technologies are based on co-metabolism of the pollutant, and not on growth. In this case the co-substrate must be supplied to stimulate the process. Genetic engineering offers the potential to recruit biochemical pathways from other organisms to convert some of these processes into energy-yielding pathways for growth. An alternative approach to improving co-metabolism processes is to engineer into the organism the capacity to grow on an environmentally friendly, cheap substrate that is rarely metabolized by the indigenous organisms (LaJoie *et al.* 1994). The co-metabolizing organism then can be more specifically stimulated to grow.

10.2.3.2 How can microbial diversity be discovered?

Discovering where new microbial diversity resides, and developing strategies to identify that diversity are equally important challenges, both for finding organisms and genes important to pollutant degradation and for the discovery of new pharmaceutical or industrial enzymes. It is known that most microbial species are very widely distributed on Earth, but that does not mean that particular phenotypic traits are equally universally distributed. One fundamental need is to understand better the geographic patterns of microbial diversity and how particular environmental conditions determine the indigenous microbial community. If many organisms important to bioremediation were rather uniformly distributed, then it could be assumed that microbes for bioremediation should already be present everywhere – including pollutant sites. Similarly, there would be less concern about ownership of such organisms by companies or countries since the same organism is likely to exist everywhere. A second major challenge in utilizing the large untapped reservoir of microbial diversity is the lack of appropriate strategies to detect and recover organisms with the desired features. Classical enrichment techniques have led to the isolation of many of the unique organisms that we now know, but this basic approach is 100 years old and does not lend itself to the recovery of all of the organisms of interest. New strategies such as using multidimensional gradients, the organism's positioning mechanisms, nucleic acid based tracking techniques, and new strategies of physical separation are being explored. Furthermore, methodology now exists to recover not the organism but its genes directly from community DNA extracted from nature, thus avoiding the need to cultivate fastidious organisms.

10.2.3.3 The classes of environmental contaminants

Tens of thousands of chemicals have been discarded into the environment by industrial society. Some present more serious problems than others because of their persistence, potential toxicity, and extent of environmental contamination. The most serious contaminants are described in Box 10.2-4.

10.2.3.4 Recent discoveries of diversity important for remediation

10.2.3.4.1 Anaerobic metabolism of BTEX.

Microbes that can grow anaerobically on toluene, ethylbenzene and xylene using nitrate, ferric iron, and/or sulphate have been isolated, characterized and their physiological features determined. These are all members of newly discovered genera, illustrating the reservoir of diversity that has been found. Recently a microbial enrichment has been reported that can also grow anaerobically on benzene using ferric iron as the electron acceptor (Lovley *et al.* 1994). Together these findings show that the entire BTEX class of pollutants can be destroyed under anaerobic conditions.

Box 10.2-4: Serious environmental contaminants.

Chlorinated solvents. These include chemicals such as tetrachloroethene (PCE), trichloroethene (TCE), trichloroethane (TCA), and carbon tetrachloride (CCl₄) (McCarty 1993). These chemicals are water-soluble, and most do not serve as growth substrates. This class probably presents the most extensive and serious groundwater contamination problem.

Chlorinated aromatics. This group includes the polychlorinated biphenyls (PCBs), chlorinated dioxins, tetrachlorophenol (PCP), and chlorinated benzenes. The members of this group with higher molecular weights are strongly sorbed to soil and thus do not usually leach to groundwater, but they are also not easily biodegraded. Those with lower molecular weights are more leachable and somewhat more biodegradable.

Explosives and other nitroaromatics. This group includes TNT, RDX, and some industrially used chemicals such as nitrophenol. The reduction of the nitro- group occurs readily under anaerobic conditions. Complete degradation of the explosive members is not readily achieved under natural environmental conditions.

Polynuclear aromatic hydrocarbons (PAHs). This class includes chemicals with multiple aromatic rings, such as phenanthrene, pyrene and benzo[a]pyrene (Cerniglia 1993). These chemicals are strongly sorbed to soil, some are carcinogenic, and those with higher molecular weights are very difficult to biodegrade. Co-metabolism is the only known way to degrade those with higher molecular weights. These chemicals present some of the most widespread and serious pollution problems because of the extensive use of petroleum compounds and, historically, the casual means by which they have been disposed of.

Components of gasoline such as benzene, toluene, ethylbenzene and the xylenes (BTEX compounds). These chemicals are easily degraded by aerobic micro-organisms and, except for benzene, by some anaerobes. The chemicals are common groundwater pollutants because they are water-soluble and because of the widespread occurrence of spills and leaks. This is perhaps the easiest class of environmental contaminants to bioremediate. Bioventing and air sparging technologies are currently used clean-up technologies for vadose and saturated zones respectively (National Research Council 1993).

Metals. Heavy metals are perhaps the most difficult class of pollutant chemicals for which bioremediation may be useful. Some metals can be removed from waste streams by sorption of the metal onto the microbial biomass, and some metals can be oxidized or reduced by microbes which may alter their solubility. If so, solubilization and precipitation can be used for their removal. In both cases, however, the metal remains and must be appropriately managed for the long term, which is not the case for the organic pollutants that are mineralized.

Other chemicals. There is a variety of other pollutants, including pesticides, dyes, alcohols, ethers, ketones, creosote, glycols, nitrogen heterocyclics and organo-sulphur compounds, for which bioremediation is also a feasible technology.

This is a very important discovery because the greatest limitation to BTEX clean-up in nature is in the absence of sufficient oxygen at the site. Further understanding of these organisms, including their biochemistry, genetics and ecology, will be important for their effective use for one of the most extensive groundwater pollution problems.

10.2.3.4.2 Enhanced PCB degradation. New organisms with different PCB congener degrading capacities have been discovered, some in new taxonomic families not previously known to degrade these chemicals. Information from the molecular level is now revealing which genes confer specificity for the particular PCB congeners and in some cases it is known which amino acids alter the substrate range (Furukawa *et al.* 1993; Erickson and Mondello 1993). This information is critical to expanding the range of PCB congeners that can be degraded. Other work has led to the discovery of new chlorobenzoate degraders and to the isolation of their

genes, which if combined with the chlorobiphenyl degrading genes may lead to organisms that can actually grow on PCBs. To date no organism from nature has been found that grows well on the major congeners in the commercially used PCB mixtures. This is a case where genetic engineering for bioremediation may provide an important phenotype that so far has not been found in nature.

10.2.3.4.3 Niche adjustment to accommodate CCl₄. A new strain of *Pseudomonas* has been discovered with the novel property of hydrolysing CCl₄ without producing chloroform (Tatara *et al.* 1993). This process is known only for this particular organism, and when in a slightly alkaline environment (pH 8.2). This organism is now being tested in a biofence, which is a zone constructed perpendicular to the carbon tetrachloride plume and amended with the organism and the pH adjusted to 8.2. This provides a selective environment for the organism, and thus should stimulate the bioremediation process.

10.2.3.4.4 Chlororespiration. Several organisms have now been discovered that live by a completely different respiration process, using the dechlorination of a chlorinated substrate as the electron acceptor for energy generation and growth. This has been demonstrated for organisms grown on PCE, chlorinated benzoate and chlorinated phenol (Holliger and Schumacher 1995; Cole *et al.* 1994). Reductive dechlorination reactions have been found with PCBs and chlorobenzenes, but no organisms capable of respiratory growth on PCBs have yet been isolated, nor is it clear that the organisms that carry out the PCB dechlorination readily grow at the expense of this process. Nonetheless, reductive dechlorination, whether it be coupled to growth or not, is one of the most useful biodiversity discoveries for bioremediation in the last decade (Mohn and Tiedje 1992).

10.2.3.4.5 Co-metabolism of TCE. The great diversity of mono-oxygenases in microorganisms has resulted in some that have the capacity also to co-oxidize TCE. Organisms that grow on CH_4 , NH_3 , phenol and toluene are major examples (McCarty 1993). All these phenotypes have members that degrade TCE. However, not all organisms that grow on these substrates are equally active in TCE degradation, and some are completely inactive. Thus the biochemical diversity of these organisms is essential to this co-oxidation technology. The difficulty in implementing this technology arises from the uncertainty about whether active or inactive TCE degraders would be selected when the co-substrate is added. Gene probes are now being evaluated to determine whether they can be used to predict if an active TCE-degrading community is likely to be selected.

10.2.3.4.6 Construction of a TNT degrader. An organism that grows on TNT was recently constructed by taking from soil near an explosives factory an isolate that had the capacity to remove the nitro groups from TNT, and adding to that organism a plasmid that carries the ability to grow on toluene (Duque *et al.* 1993). The resulting organism could then grow on TNT. This illustrates what can be achieved by combining genotype features of two organisms that had existed under different selective conditions.

10.2.3.5 Traits sought in bioremediation

The more challenging bioremediation goals are not being met simply by inoculating a single organism that can complete the degradation. They may require either a consortium of organisms or the construction, by genetic engineering, of organisms with a combination of desirable traits. Consortia may be necessary to carry out different steps in the pathway of biodegradation, or they may be important because of the different phenotypic features maintained in the mixture, such as a range of kinetic

properties effective at different substrate concentrations, or tolerances to different conditions. Such mixtures are likely to yield more robust processes because of the diversity that exists in such communities. There is likely to be more interest in the future in not considering single organisms for bioremediation, but consortia.

Genetic engineering is an alternative approach which combines some of these different features into a single organism. The types of traits sought by genetic engineering are recruitment of pathways so that the pollutant becomes the growth substrate or so that the same organism can degrade more than one pollutant. This has been demonstrated for several chloroaromatic compounds (Rojo *et al.* 1987; Wackett *et al.* 1994). Alteration of the regulatory genes so that the pollutant induces the desired enzymatic activity or so that the pollutant-degrading activity is constitutive rather than inducible may be necessary. Genetic engineering also important to alter the active site to accommodate a broader substrate range or to enhance the rate of metabolism. It may also be used to effect microbial attachment or mobility, depending on whether the goal is to improve the performance of a fixed film reactor or to disperse the organism in an aquifer. Genetic engineering can also be used to enhance the surfactant-producing property of organisms and thereby potentially overcome bioavailability limitations (Finnerty 1994). Finally, genetic engineering can be used to make the organism more tolerant to co-contaminants, for example by introducing genes conferring resistance to heavy metals, tolerance to solvents or to pH extremes.

10.2.3.6 Tracking microbial strains added to the environment

Tracking the fate of a microbial strain added to the environment is essential in order to assess the organism's survival, growth and dispersal, and thus its effectiveness as a product, as well as to evaluate any unintended effects. Interest in the environmental impact of genetically engineered microorganisms has stimulated new tracking techniques. These include engineering the organisms with markers for easy detection such as the lac ZY gene for β -galactosidase activity; the lux and lac genes for light emission; selective markers for growth such as antibiotic resistance; detection of unique DNA segments by PCR; use of fluorescently labelled oligonucleotide probes to microscopically detect phylotypes by hybridization to ribosomes; and specific antibody-based methods such as ELISA. Each method has different advantages in specificity, sensitivity, cost and speed of applicability to particular organisms and environments. These methods have not yet been widely applied in bioremediation studies, probably because most studies have used indigenous organisms. The most sensitive, specific method for detecting added organisms without relying on their

cultivation has been the PCR-based method targeted at randomly cloned unique segments of the organisms' chromosome (e.g. Thiem *et al.* 1994). Methods based on probes or primers targeted at the variable region of 16S rRNA genes are also being used, but they are not uniquely specific for a single strain. Nonetheless, they are more convenient for studies on the population dynamics of the added organism and its competitors in the remediation habitat.

10.2.3.7 Bioremediation technologies

There are two basic classes of bioremediation technologies: intrinsic (non-engineered intervention to speed the process) and engineered (in which the process is enhanced by reducing the rate limiting parameter). To practise intrinsic remediation, considerable knowledge of the process and conditions controlling the process at the site must be known to ensure that the process continues at the expected rate. In engineered remediation, addition of oxygen, nutrients, surfactants, organisms and co-substrates are examples that are either in practice or have been tested in the field.

The bioremediation technologies in accepted commercial practice today are land farming, in which pollutant degradation is stimulated by the addition of nutrients and perhaps by oxygen from cultivation, and bioventing, in which air is drawn through the vadose zone of soil to stimulate the aerobic activities of the community. These are comparatively simple technologies which rely on the native populations of the soil community.

Several extremely promising emerging technologies are based on the discoveries mentioned above, although these technologies require more sophisticated knowledge and management. They include sequential anaerobic-aerobic treatment for remediation of PCBs; enhanced anaerobic reductive dechlorination of PCE and TCE; co-metabolic treatment of TCE, especially using phenol or toluene; and anaerobic biodegradation of BTEX. All of these technologies have now been demonstrated at least at the pilot scale in the field and would be expected to be more widely attempted in the near future. Another emerging technology is phytoremediation, in which plants are used as bioaccumulators of heavy metals to extract those metals from contaminated soils (Raskin *et al.* 1994). There have also been some studies in which the rhizosphere environment is thought to stimulate the biodegradation of organic pollutants in soil. In these strategies the plant's root system is used as a less expensive means of permeating the polluted site.

10.2.4 Roles of biotechnology in utilization of biodiversity: conclusions

Biotechnology provides important tools for biodiversity utilization for human benefit. Living organisms can be used as factories for specific products, targeted at a variety of

production end uses, harnessed for environmental remediation, or used in industrial processes. Biotechnology applications can serve rural, manufacturing and extractive activities.

Although not a universal solution, genetic engineering is the most elegant way of improving domesticated breeds or strains. Protocols for gene transfer are now becoming routine. Genetic engineering can be used, among other objectives, to increase productivity, control disease, eradicate pests, improve product quality or novelty, and rehabilitate a broad array of degraded or polluted ecosystems.

References

- Bosemark, N.O.** 1993. The need for a comprehensive plant breeding strategy. In Hayward, M.D. and Romagosa (eds), *Plant Breeding: Principles and prospects*, 526–533. Chapman and Hall, London.
- Boyle, D.B.** 1994. Disease and fertility control in wildlife and feral animal populations: options for vaccine delivery using vectors. *Reproduction, Fertility and Development* **6**: 1393–1400.
- Bradley, M.P.** 1994. Experimental strategies for the development of an immun contraceptive vaccine for the European red fox, *Vulpes vulpes*. *Reproduction, Fertility and Development* **6**: 307–317.
- Carver, A.S., Dalrymple, M.A., Wright, G., Cottom, D.S., Reeves, D.B., Gibson, Y.H., Keenan, J.L., Barrass, J.D., Scott, A.R., Colman, A. and Garner, I.** 1993. Transgenic livestock as bioreactors: stable expression of human alpha-1-antitrypsin by a flock of sheep. *Bio/Technology* **11**: 1263–1270.
- Cerniglia, C.E.** 1993. Biodegradation of polycyclic aromatic hydrocarbons. *Current Opinion in Biotechnology* **4**: 331–338.
- Cole, J.R., Cascarelli, A.L., Mohn, W.W. and Tiedje, J.M.** 1994. Isolation and characterization of a novel bacterium growing via reductive dehalogenation of 2-chlorophenol. *Applied and Environmental Microbiology* **60**: 3536–3542.
- Dudits, D., Fejer, G., Hadlaczy, G., Lazar, G.B. and Horvath, G.** 1980. Intergeneric gene transfer mediated by plant protoplast fusion. *Molecular and General Genetics* **179**: 283–288.
- Duque, E., Haidour, A., Godoy, F. and Ramos, J.L.** 1993. Construction of a *Pseudomonas* hybrid strain that mineralizes 2,4,6-trinitrotoluene. *Journal of Bacteriology* **175**: 2278–2283.
- Ebert, K.M., Selgrath, J.P., DiTullo, P., Denman, I., Smith, T.A., Memon, M.A., Schindler, J.E., Monasterski, G.M., Vitale, J.A. and Gordon, K.** 1991. Transgenic production of a variant of human tissue-type plasminogen activator in goat milk. *Bio/Technology* **9**: 835–838.
- Erickson, B.D. and Mondello, F.J.** 1993. Enhanced biodegradation of polychlorinated biphenyls after site-directed mutagenesis of a biphenyl dioxygenase gene. *Applied Environmental Microbiology* **59**: 3858–3962.
- Foroughi-Wehr, B. and Wenzel, G.** 1993. Andro- and parthenogenesis. In: Hayward, M.D., Bosemark, N.O. and Romagosa (eds), *Plant Breeding: Principles and prospects*, 261–277. Chapman and Hall, London.
- Finnerty, W.R.** 1994. Biosurfactants in environmental

- biotechnology. *Current Opinion in Biotechnology* **5**: 291–295.
- Freeman, A.B.** and Lindberg, G.L. 1993. Challenges to dairy cattle management: genetic considerations. *Journal of Dairy Science* **76**: 3143–3159.
- Furukawa, K., Hirose, J., Suyama, A., Zaiki, T. and Hayashida, S.** 1993. Gene components responsible for discrete substrate specificity in the metabolism of biphenyl (bph operon) and toluene (tod operon). *Journal of Bacteriology* **175**: 5224–5232.
- Harvey, R.W.** 1993. Fate and transport of bacteria injected into aquifers. *Current Opinion in Biotechnology* **4**: 312–317.
- Hataya, T., Inoue, A.K. and Shikata, E.** 1994. A PCR-microplate hybridization method for plant virus detection. *Journal of Virological Methods* **46**: 223–236.
- Holliger, C. and Schumacher, W.** 1995. Reductive dehalogenation as a respiratory process. *Antonie van Leeuwenhoek Journal of Microbiology* (in press).
- Janssen, D.B. and Schanstra, J.P.** 1994. Engineering proteins for environmental applications. *Current Opinion in Biotechnology* **5**: 253–259.
- Kinlaw, C. and Harry, D.** 1994. Distinctive biology of forest trees highlighted at Sixth International Meeting. *Probe* **4**: 37–39.
- Klein, P.A.** 1993. Immunology and biotechnology for the study and control of infectious diseases in wildlife populations. *Journal of Zoo and Wildlife Medicine* **24**: 346–351.
- LaJoié, C.A., Layton, A.C. and Saylor, G.S.** 1994. Cometabolic oxidation of polychlorinated biphenyls in soil with a surfactant-based field application vector. *Applied Environmental Microbiology* **60**: 2826–2833.
- Landry, B., Penner, G., Rossnagel, B., Scoles, G., Taylor, J., Warwick, S. and Webster, F.** 1994. Molecular markers – save time, save money, but what are they? *PBI Bulletin*, November, p. 7.
- Lovley, D.R., Woodward, J.C. and Chapelle, F.H.** 1994. Stimulated anoxic biodegradation of aromatic hydrocarbons using Fe(III) ligands. *Nature* **370**: 128–131.
- McCarty, P.L.** 1993. *In situ* bioremediation of chlorinated solvents. *Current Opinion in Biotechnology* **4**: 323–330.
- Machlin, L.J.** 1972. Effect of porcine growth hormone on growth and carcass composition of the pig. *Journal of Animal Science* **35**: 794–800.
- Michelmore, R.W., Paran, I. and Kesseli, R.V.** 1991. Identification of markers linked to disease-resistance genes by bulk segregant analysis: a rapid method to detect markers in specific genome regions by using segregation populations. *Proceedings of the National Academy of Sciences USA* **88**: 9828–9832.
- Mohn, W.W. and Tiedje, J.M.** 1992. Microbial reductive dehalogenation. *Microbiology Reviews* **56**: 482–507.
- National Research Council** 1993. *In situ bioremediation – when does it work?* National Academy Press, Washington, DC.
- Neale, D.B.** 1993. Progress reported at Forest Tree Genome Mapping Workshop. *Probe* **3**: 4–5.
- Penner, G.A., Chong, J., Wight, C.P., Molnar, S.J. and Fedak, G.** 1993. Identification of an RAPD marker for the crown rust resistance gene Pc68 in oats. *Genome* **36**: 818–820.
- Phillips, G.C., Grosser, J.W., Berger, S., Taylor, N.L. and Collins, G.B.** 1992. Interspecific hybridization between red clover and *Trifolium alpestre* using *in vitro* embryo rescue. *Crop Science* **32**: 1113–1115.
- Pursel, V.G., Hammer, R.E., Bolt, D.J., Palmiter, R.L. and Brinster, R.D.** 1990. Integration, expression and germ-line transmission of growth-related genes in pigs. *Journal of Reproduction and Fertility* (suppl.) **41**: 77–87.
- Pursel, V.G., Pinkert, C.A., Miller, K.F., Bolt, D.J., Campbell, R.G., Brinster, R.D., Palmiter, R.L. and Hammer, R.E.** 1989. Genetic engineering of livestock. *Science* **244**: 1282–1288.
- Rabinovich, N.R., McInnes, P., Klein, D.L. and Hall, B.F.** 1994. Vaccine technologies: view to the future. *Science* **265**: 1401–1404. [See also other articles on vaccines in the same issue.]
- Raskin, I., Kumar, P.N., Dushenkov, S. and Salt, D.E.** 1994. Bioconcentration of heavy metals by plants. *Current Opinion in Biotechnology* **5**: 285–290.
- Rojo, F., Pieper, D., Engesser, K.H., Knackmuss, H.J. and Timmis, K.N.** 1987. Assemblage of ortho-cleavage routes for degradation of chloro- and methylaromatics. *Science* **238**: 1395–1398.
- Roosien, J., Van Zandvoort, P.M., Folkertsma, R., Rouppe Van Der Voort, J.N.A.M., Govers, A., Gommers, F.J. and Bakker, J.** 1993. Single juveniles of the potato cyst nematodes *Globodera rostochiensis* and *G. pallida* differentiated by randomly amplified polymorphic DNA. *Parasitology* **107**: 567–572.
- Schachermayr, G., Siedler, H., Gale, M.D., Winzeler, H. and Keller, B.** 1994. Identification and localization of molecular markers linked to the Lr9 leaf rust resistance gene of wheat. *Theoretical and Applied Genetics* **88**: 110–115.
- Swanson, M.L., Martin, M.J., O'Connell, J.K., Hoover, K., Lago, W., Huntress, V., Parsons, C.T., Pinckert, C.J., Pidler, S. and Logan, J.D.** 1992. Production of functional human haemoglobin in transgenic swine. *Bio/Technology* **10**: 557–559.
- Tatara, G.M., Dybas, M.J. and Criddle, C.S.** 1993. Effects of medium and trace metals on kinetics of carbon tetrachloride transformation by *Pseudomonas* sp. strain KC. *Applied and Environmental Microbiology* **59**: 2126–2131.
- Thiem, S.M., Krumme, M.L., Smith, R.L. and Tiedje, J.M.** 1994. Use of molecular techniques to evaluate the survival of a microorganism injected into an aquifer. *Applied and Environmental Microbiology* **60**: 1059–1067.
- Tyndale-Biscoe, C.H.** 1994. Virus-vectored immunocoontraception of feral animals. *Reproduction, Fertility and Development* **6**: 281–287.
- Vize, P.D., Michalska, A.E., Ashman, R., Llody, B., Stone, B.A., Quinn, P., Wells, J.R.F. & Seamark, R.F.** 1988. Introduction of a porcine growth hormone fusion gene into transgenic pig promotes growth. *Journal of Cell Science* **90**: 285–300.
- Wackett, L.P., Sadowsky, M.J., Newman, L.M., Hur, H.-G. and Li, S.** 1994. Metabolism of polyhalogenated compounds by a genetically engineered bacterium. *Nature* **368**: 627–629.
- Wiegart, M., Hoover, J.L., McGrane, M.M., Hanson, R.W., Rottman, F.M., Holtzman, S.H., Wagner, T.H. and Pinchert, C.A.** 1990. Production of transgenic pigs harbouring a rat phosphoenolpyruvate carboxykinase – bovine growth hormone fusion gene. *Journal of Reproduction and Fertility* (suppl.) **40**: 89–96.
- Zaitlin, D., Demars, S. and Ma, Y.** 1993. Linkage of rhm, a recessive gene for resistance to southern corn leaf blight, to RFLP marker loci in maize (*Zea mays*) seedlings. *Genome* **36**: 555–564.

10.3 Impacts of biotechnology on biodiversity

The Convention on Biological Diversity, while recognizing the role of biotechnology in the attainment of its objectives [Article 8(g)], calls for measures to 'regulate, manage or control the risks associated with the use and release of living modified organisms resulting from biotechnology which are likely to have adverse environmental impacts that could affect the conservation and sustainable use of biological diversity, taking also into account the risks to human health'. It also calls on the signatory countries 'to consider the need for and modalities of a protocol setting out appropriate procedures, including, in particular, advance informed agreement, in the field of the safe transfer, handling and use of any living modified organism resulting from biotechnology that may have an adverse effect on the conservation and sustainable use of biological diversity' [Article 19.3].

This chapter sets out to identify some of the potential adverse impacts on biodiversity arising from the use of recombinant technologies, and to present current approaches to environmental impact assessment and management. As pointed out above, however, it is important to note that such discussions do not imply that genetically engineered organisms are necessarily dangerous, or that non-engineered organisms are necessarily safe. The explosive generation of information in life sciences, and our increasing familiarization with the handling of transgenic organisms, changes continuously our perception of risk, and the adaptation of risk assessment and management procedures to the current levels of knowledge becomes quite a challenge.

10.3.1 Definitions of impacts

Loss of species and habitat diversity as a result of environmental introductions of genetically modified organisms (GMOs) is theoretically possible. Adverse biological effects on non-target populations and ecological and evolutionary disruption may be either the *direct* result of the introduced transgene(s) or alternatively the *indirect* result of changing socioeconomic conditions related to the application of recombinant technologies. At the same time, there are perceivable beneficial impacts on biodiversity. For example, the introduction of genetically modified microorganisms (GMMs) for bioremediation purposes, as described in 10.2.3, results in the addition of new genetic diversity for habitat restoration. Likewise, changing the reproductive behaviour of crop plants from sexual to asexual (apomixis) through genetic engineering may lead to significant economic advantages. Although the splicing of genes into organisms from unrelated species is thought to result in increasing genetic diversity, technology detractors would rather see this as increasing genetic 'pollution'.

Whereas, in principle, direct impacts can be assessed by

scientific methodology and be tested experimentally, indirect impacts are by and large conjectural, being influenced by a multitude of intractable factors of an institutional, social and economic nature. The chapter addresses both as they form the basis of risk management considerations.

10.3.2 Direct impacts

Harm to biological diversity arising from the release of GMOs may result from the properties of transgenes themselves, or alternatively, from the transfer and expression of the transgene in non-target organisms. Disturbance of the dynamic population equilibria of ecosystems through GMO introductions may also result in adverse impacts on biodiversity. Enhanced ability of GMOs to invade natural habitats may lead to reduction of population diversity within species or – less likely – the displacement of an entire species, in cases where the latter is endangered or represented by only a few local populations (Edge 1994). However, it has to be stressed that the likelihood of this type of impact is highly speculative, and such concerns derive from earlier experience with introductions of 'exotic' natural organisms (10.3.2.1) which can not be considered directly analogous to introductions of GMOs.

In summary, the addition of a new genotype or species to a community can have various undesirable effects:

- displacement or destruction of indigenous species;
- exposure of species to new pathogenic or toxic agents;
- pollution of the gene pool;
- loss of species diversity;
- disruption of energy and nutrient cycling.

10.3.2.1 Lessons from past introductions

From the dawn of humankind the history of human travel is full of examples of the introduction of 'exotic' natural organisms into new locations. During the last 500 years colonists from Europe have brought with them many thousands of organisms as they visited and settled in 'new' lands. After colonization the importation of exotic species often continued for agricultural, recreational or pest control purposes (Drake and Mooney 1989). The last hundred years have witnessed many attempts (some successful, some not) to control pests by natural predators (see, for example, DeBach and Rosen 1991). How much can be learnt from these releases?

The considered view is that, using current methods for modelling ecosystems, we cannot reliably predict the outcome of the release of an exotic organism. Effects on population dynamics are extremely sensitive to environmental influences, and their manifestation is often slow to be recognized. The success of the rabbit

(*Oryctolagus cuniculus*) in colonizing Australia is often cited as an example of an introduction that had drastic and unforeseen consequences. The irony is that the rabbit, introduced into Australia 150 years ago, was not widespread in the United Kingdom until about 500 years ago. Introduced from its true natural home in Spain, several hundred years elapsed before its population increased dramatically during the fifteenth century (Thompson 1993). In a careful analysis of colonizations of Australia, New Zealand and the UK, Adam *et al.* (1993) pointed out that few of the outcomes could have been predicted: even subtle differences in behaviour, predation, reproduction, disease resistance and foraging between the exotic animal and the nearest natural counterpart can have far-reaching consequences. However, can we nevertheless make some predictions about the outcome of the release of transgenic organisms? Adam *et al.* (1993) argued that this will often be a more tractable problem.

The fundamental similarity of many transgenic animals to their parents is evoked in support of this argument. The modification is usually well characterized, and although pleiotropic effects in other genes must be considered, many of the effects of a specific modification can be assessed quite accurately. This argument might not hold for all modifications or for all species: both these variables are likely to become broader in coming years. For example, cold-tolerant and faster-growing transgenic fish have been produced. Would a cold-tolerant species displace a wider range of competitors? Would a faster growing or larger fish destroy more habitat or displace non-transgenic natives? One of the features of the assessment of a controlled release of transgenic carp in Alabama, USA, was the likely effects on 'native' carp (USDA 1990). The carp is an exotic species introduced to the USA from Asia in the late nineteenth century, and quite possibly displaced the natural fauna. Nevertheless the concerns are real, and in releases of this type it is critical that such concerns are addressed (Tiedje *et al.* 1989; Kapuscinski and Hallerman 1990). Ideally some biological containment (impaired reproduction, reduced stress tolerance) could be built into fish in aquaculture to limit their chance of propagating in the wild. It is also possible to conceive of, but difficult to engineer, systems of suicide genes, repressed in the true-breeding line, but which would be effective when heterozygotes are produced through mating with feral populations. If the transgenic organisms are designed to breed *inter se* and not with feral animals, then such systems should be a priority in development.

Our domesticated or cultured animals are often deemed to be less fit than their feral counterparts, and thus less likely to survive or spread widely. Whilst this is often true, it cannot be assumed *a priori*. It may be that a more rapidly growing goat may forage more widely and displace non-transgenic feral animals as well as destroy the habitat of other species.

Table 10.3-1: Some indicative attributes of importance for a successful invasion process (modified from Tomiuk and Loeschcke 1993).

Vertebrates	Plants
Large econiche	Germination in a wide range of conditions
Large founder population	Many seeds, easy dispersal
Short generation time	Rapid growth
High genetic variability	Plastic perennials
Gregarious	Early flowering
Female able to colonize alone	Vegetative propagation
Larger than most relatives	Good competitors
Associated with humans	Associated with humans

Although some assessment of such behaviour could be made, a rigorous and complete examination is not possible. How rigorously should such an assessment be made? Should we treat transgenic animals more rigorously than we treat 'exotic' animals? In most cases, common sense and biological arguments would say no. Perhaps, then, the argument becomes one that we should apply the same rigour to all releases, but that the rigour can be tempered by familiarity and understanding of the genotype and phenotype of the non-natural species as well as of the receiving environment.

Table 10.3-1 lists some of the phenotypic attributes that are thought to enhance invasiveness. It needs to be stressed, however, that it is not necessary that all of these attributes occur simultaneously for a successful invasion. Consideration of the same attributes is instructive in the case of released GMOs as well.

10.3.2.2 GMOs: invasiveness in natural habitats

By analogy to the above, ecological disruption may occur from the addition of engineered phenotypic traits that are either toxic or pathogenic to non-target populations or increase the fitness of the GMO, thus rendering it competitively superior to the existing natural biota. Population size and the evolutionary properties of the introduced GMO are important parameters in the consideration of the effects that may result from such introductions as they may significantly influence the ecological dynamics.

For example, the high multiplication and mutation rates of engineered microorganisms may lead to the selection, accumulation and permanent or transient establishment of advantageous mutants in short time spans. More importantly, even competitively inferior mutants may eventually be established in areas where it is difficult to dislodge them (competition in structured habitats; Kim *et al.* 1991). A case in point is provided by GMMs used in

bioremediation and the utilization of toxins as growth substrates. The population of transgenic microorganisms may increase rapidly after their introduction (Lenski 1991). This effect, however, is likely to be mitigated by selection against the intended function of the transgene (e.g. depletion of the toxic substrate). A number of other mitigating factors are also known to operate (Table 10.3-2).

The rapid increase in numbers, and the establishment, of introduced GMMs may give rise to potential risks involving effects on biotic communities and known or predicted involvement in biogeochemical processes such as mineral cycling and nitrogen fixation.

Assessment of the potential risks is confounded by additional uncertainties arising from the speculative nature of the routes of transmission of the GMM (e.g. water, wind, air, biological vectors, mechanical means), its multiplication and survival potential, and the availability of appropriate niches for establishment. In view of the intractability of these factors and the dearth of validated experimental models for quantifying most of the above-mentioned variables, work with transgenic microorganisms requires rigorous control measures (10.3.4.2).

The establishment of GMMs in the environment is intimately related to mode, scale and frequency of application. The potential ecological risks arising from the use of GMMs have been extensively reviewed in the literature (Stewart-Tull and Sussman 1992; Campbell 1991). However, it is argued (Lenski 1991) that engineering transgenes into microorganisms that have evolved to function optimally in a given niche has the effect of 'excess baggage' on the GMM, which thus becomes less fit than its unmodified counterpart and, therefore, outcompeted in the presence of the latter. This argument may well hold true for higher organisms as well.

For plants, some applications of plant biotechnology have also generated concern as being potentially harmful to the environment. Invasiveness of transgenic plants is considered to be a perceivable risk, and an often quoted example is that of salt-tolerant rice escaping confinement and invading estuaries. Concern has also been expressed in

the case of engineered crops turning into weeds in agricultural and non-agricultural settings. Weediness is considered here in a broad context to include both persistence of plants in agricultural habitats and invasiveness in natural habitats. Even though the causes of weediness have been debated for many years, there is still no consensus on what characters contribute to making a successful weed. Because the performance of a plant species depends on interacting features of its environment and on competing plant species, it is not easy to make predictions on the likely weediness characteristics of particular transgenic plants (Tomiuk and Loeschke 1993).

The widespread use of transgenic plants in agriculture could enhance weediness in one of two ways. The transgenic crop plant may become more difficult to control in subsequent cropping (i.e. produce more persistent 'volunteer' plants), or the transgene may transfer to sexually compatible wild species and produce more persistent weed populations (10.3.2.3). The impact of both of these events will be determined by the nature of the transgene inserted and the receiving environment.

Herbicide resistance is often cited as a trait likely to produce more persistent weeds in agricultural habitats. This is likely to be the case only if there is no suitable alternative method of chemical or mechanical weed control. If several transgenes conferring resistance to different herbicides are introduced into a crop species, this could potentially contribute to the creation of a weed problem.

The effect of introducing other kinds of transgenes, such as disease resistance, pest resistance and environmental stress tolerance, would have to be considered as part of a risk assessment before field trials and commercialization of transgenic crop plants. However, plants in agricultural habitats are usually closely managed, and unless the transgene substantially increases persistence in agricultural habitats, transgenic plants are unlikely to have a significant impact on those agricultural habitats.

The impact of transgenes on the invasiveness of plants in natural habitats will again depend on the nature of the transgene and the receiving environment. Herbicide resistance is not likely to have any substantial effects on natural habitats because herbicides are not normally applied in those habitats, and therefore herbicide-resistant plants would not gain a selective advantage. Similarly, the effect of disease resistance, pest resistance and environmental stress tolerance will depend on the characteristics of the environment and on whether the transgene-carrying plants would be at a selective advantage. Transgenes conferring tolerance to stressful environments, such as saline soils, soils containing heavy metals or drought, could provide a significant selective advantage and this aspect would need to be considered in detail during the risk assessment exercise.

Generalized predictions of the likely impact of transgenic plants on persistence and invasiveness are not

Table 10.3-2: Summary of factors affecting hazard potential of GMMs (adapted from Strauss 1991).

Factors mitigating hazard potential	Factors enhancing hazard potential
Starvation	Increased fitness
Competition	Adaptation
Predation	Instability of transgene
Parasitism	Resistance/avoidance to predation
Unfavourable niche	Favourable niche

possible, and models based on the introduction of exotic species are not particularly helpful in this exercise (10.3.2.1). However, because of the long history of conventional plant breeding, it is important to draw on that experience in assessing the likely impact of transgenes on weediness. Where particular transgenes are considered likely to affect weediness, competition experiments may be helpful in assessing their likely impact. In the final analysis it may be necessary to monitor the impact of particular transgenic varieties during the early stages of their commercial use.

10.3.2.3 GMOs: gene transfer to non-target populations

Horizontal gene transfer of unmodified genes has been demonstrated in laboratory studies, and has been observed to occur in nature in the case of microorganisms (Médigue *et al.* 1991), albeit at variable frequency. By analogy, it would not be unreasonable to predict dissemination and establishment of a released transgene, under certain circumstances. With the exception of T-DNA transfer from *Agrobacterium tumefaciens* to plants, and of *E. coli* plasmids to yeast, however, fixation of prokaryotic genes in natural population of eukaryotes remains speculative (López-Pila and Scheler 1993). Knowledge of the method of transgenesis (if, for example, it is vector-mediated) and of the stability of the transgene in its host organism, is considered important in ascertaining its potential for being transferred into non-target organisms.

In the case of plants, the opportunity for genetic recombination between natural and engineered species, followed by successive breeding between the hybrid progeny and the natural species (introgression of transgenes), depends on the physical distance between the transgenic crop and the recipient species; whether flowering is synchronous; whether there is a means of transporting pollen from one plant to another (insect, wind, etc.), and whether the donor and recipient are sexually compatible. Once a hybrid forms, its fate will depend on whether the plant is able to develop vegetatively, and on its degree of fertility following self-pollination or outcrossing. The means of vegetative survival and propagation will also determine its success as a hybrid plant.

Sexual compatibility between crop plants and other plant species is the principal feature determining introgression. There are measures that can be used to prevent or reduce the amount of cross-pollination, such as isolation by distance, removal of flowers and use of male sterile transgenic plants (10.3.4.1), but once transgenic plants are in commercial production, reproductive isolation using these means is largely impractical.

Plant breeders have attempted wide hybridization for many decades as a means of introducing genes of agricultural importance into our crop plants. Because of this experience, there is a great deal of information on the

degree of sexual compatibility between our crop plants and their related species. Hybridization may occur easily, or may be extremely difficult and require ovary and embryo culture to rescue the hybrid embryo. Once a hybrid plant is formed its success then depends on its ability to survive and propagate in its current environment.

For an analysis of the likelihood of transgenes introgressing into natural plant populations, it is important to examine the evidence for introgression of genes from conventionally bred plant varieties into wild plant populations. Many of the characters currently manipulated by modern genetic modification methods fall into classes of characters that have been manipulated by conventional plant breeding for many decades. Most of the documented evidence to date, of introgression between crops and wild species, is between crop plants and related weed species. There is negligible information describing the extent and consequences of gene flow from crops to plants in natural populations. This may be because studies on natural populations are particularly difficult to carry out. However, if introgression into natural plant populations had made a significant impact on wild populations, it is reasonable to assume that an effect would have been observed. One of the main reasons why introgression between crops and plants in natural populations appears limited is that plants developed for agriculture do not often survive well in nature (reduced seed dormancy, reduced fruit shattering, poor competitive ability), so hybrids between crop plants and wild plants in natural populations are generally at a selective disadvantage.

As stated above, most of the documentation on gene flow is on introgression between conventionally bred crops and related weed species. Because the weed has to compete with the crop in an agricultural environment, introgression tends to lead to weed species that are genetically and phenotypically more like the crop. Gene flow has been observed between rice (*Oryza sativa*) and perennial rice (*O. perennis*), maize (*Zea mays*) and teosinte (various *Zea* species), sugarbeet (*Beta vulgaris*) and wild beet (*B. vulgaris* subsp. unknown) (Dale 1994). However, it is important to emphasize that even without introgression there is often a remarkable genetic capacity within many weed populations to adapt to agricultural conditions, and to become more successful weeds without genetic introgression. There are several well-documented cases in which weed species have mimicked the phenotype of crop plants without any evidence of genetic introgression (Dale 1994).

The consequence of genetic introgression between transgenic crop plants and related species depends on the nature of the transgene. A risk assessment needs to take into account the nature of the transgene, along with relevant features of the environment, before arriving at an estimate of the likely consequences of gene introgression. The environmental consequences of the transfer from

transgenic crops of transgenes conferring resistance to certain herbicides, resistance to stressful environments, or resistance to pests and pathogens, is being actively debated internationally. The consequence of the transfer of pest and disease resistance depends on the way in which sexually compatible wild relatives are influenced by those pests and pathogens. The introgression of genes conferring resistance to environmental stress will again depend on the characteristics of the particular environment to which the hybrid plant may be exposed.

A consideration of all these factors is a necessary feature of the risk assessment that must be carried out before experimental releases of transgenic plants, and before transgenic plant varieties are approved for commercial release. However, further studies on the extent of gene introgression between our crops and wild species would be helpful, as would monitoring of gene flow following the commercial release of transgenic plant varieties.

The issues discussed above are those that have received greatest attention in risk assessments to date and that are amenable to practical risk assessment. Other potential risks have been referred to in the literature as, for example, the impact of transgenic plants on soil microorganisms (Angle 1994; Morra 1994) and the potential of virus-resistant plants to broaden the host range of some viruses ('transcapsidation'; Rissler and Mellon 1993). However, our present level of understanding is inadequate to assess and evaluate these risks.

10.3.3 Risk assessment

The commercial development and environmental application of GMOs involves several stages of experimentation ranging from complete laboratory containment, through small-scale field trials, to large-scale production release. The purpose of experimentation is to test the alleged properties of the GMO under field conditions and its interaction with the environment of the release. Each stage involves extensive data collection on a number of phenotypic and ecological variables and their subsequent evaluation and statistical analysis. This gradual progression of experimentation and data collection is intended to build in adequate safety assurance regarding the potential impacts of the release on human health and the environment. It should be noted, however, that this step-by-step procedure is not always mandatory and depends on whether regulatory authorities deem necessary the collection of additional data for a more thorough assessment of potential ecological risk.

Assessing the risk associated with a particular process or event involving a GMO depends upon the *a priori* identification of the potential hazards, the estimation of their relative importance and the computation of the probability of adverse impacts. Points to consider in risk assessment include:

- Characterization of the host organism.
- Method of transgenesis.
- Characterization of the GMO.
- Intended use/effect of the GMO.
- Ecological relevance of the intended effect of the release.
- Monitoring, containment and control of the released GMO.

Although the ultimate objective of risk assessment is the quantification of the impact probability, in the case of biodiversity this is hardly feasible. Modelling approaches to help predict, for example, invasiveness of GMOs, range of pollen transfer, and the fate and effects of GMMs, are only approximations to real situations and need to be validated (Fiksel 1991). This is because the identification of potential hazards is confounded by the complexity of interactions of the introduced gene and the environment into which it has been released. Recognizing this difficulty, most regulatory review systems approach risk assessment on a case-by-case basis. Accordingly, individual applications for trialling or release of GMOs are assessed against criteria relevant to the particular situation of the release. Hazard identification and evaluation of the magnitude of the risk damage is based on the degree of knowledge (familiarity) of the GMO at hand and the environment into which it is to be released. Risk assessment also takes into account whether the application of management techniques (confinement and control of the GMO) could reduce the level of risk (UK Department of Environment 1993).

There is increasing confidence that, at least for some types of genetic modification and certain organisms, characterization of the phenotypic properties of the GMO and familiarity with the ecosystems of release allow reasonably accurate classification of risk levels (low, intermediate or high). Thus a generic *a priori* appraisal of risk is permissible. This departure from the case-by-case approach is becoming an evident trend in a number of regulatory systems (UK Department of Environment 1994; USDA 1993). It should be stressed, however, that risk evaluation is ecosystem-specific and therefore not necessarily valid in ecological settings where the GMO under consideration is likely to be confronted by different environmental variables.

There is also some concern that the step-by-step approach to risk assessment, involving the gradual reduction of GMO containment and increased geographical range of the release, contains some inherent methodological flaws. Small-scale field research of GMOs under the Good Development Principles (GDP;

OECD 1992) is designed to ensure minimization of potentially adverse effects on the site of the trial itself. GDP involves measures aimed at controlling and containing the GMO of interest (see below). This design feature raises questions about the predictive value of the data generated during the trial for environmental impact assessment arising from the large-scale release of the GMO. Reproductive isolation of transgenic crop varieties necessary in small-scale trials, for example, 'places a distinct limit on what can be learnt from release in terms of the effect on the environment beyond the vicinity of the test location' (OECD 1993).

In addition, small-scale field trials are designed to test the phenotypic expression of a gene of interest under variable environmental conditions and very seldom to derive data that are relevant to ascertaining the safety of a large-scale release (e.g. gene flow and dose exposure of other organisms to the GMO; Lesser and Maloney 1993). Indeed there is no statutory requirement for this type of data in most regulations pertaining to small-scale release of GMOs. There is, therefore, considerable need for more definition of the type and amount of experimental data to be collected during experimentation and post-release monitoring, as well as the time scale in which potential impacts are to be evaluated.

10.3.4 Measures for minimizing direct impacts

In field trials, the aim of these measures is to limit the possibility of gene transfer, exposure of non-target populations to toxic components expressed by the transgenic organism, and invasion of the latter into native ecosystems. Risk reduction is achieved mainly by confinement and control of the organism at hand, and is therefore attainable in small-scale field trials only.

10.3.4.1 Measures for transgenic crops

In the case of transgenic crop plants that have been transformed by means of biological vectors, it is possible to eliminate or disarm the vector and therefore the potential for vector-mediated gene transfer. It is also possible to delete the pathogenic sequences contained in some transformation vectors (e.g. *Agrobacterium tumefaciens* Ti plasmid) and to eliminate the possibility of their survival and transmission.

Dispersal of the transgenic plant beyond the test site can be controlled through reproductive isolation. This can be achieved by:

- Spatial separation of the transgenic plant from sexually compatible plant populations. The distance of separation may range from tens of metres to several kilometres depending on the reproductive characteristics of the crop species.
- Physical prevention of pollen movement (e.g. flower bagging prior to anthesis).

- Mechanical debilitation of reproductive potential. That is, removal of the male or female reproductive structures (e.g. detasselling), eliminating the chance of cross-pollination.
- Genetic debilitation of reproductive potential by the incorporation of male cytoplasmic sterility traits; by the incorporation of non-flowering traits (applicable where the plants are propagated vegetatively).
- Early or late induction of anthesis to limit cross-pollination with sexually compatible species.

For plants that have been transformed to contain a toxin, additional measures (isolation, caging) may be necessary to eliminate the possibility of non-target organisms (e.g. herbivorous insects) being exposed to the toxin.

10.3.4.2 Measures for genetically modified microorganisms

Unlike plants, genetic isolation of GMMs is not meaningful as the possibility of horizontal gene transfer cannot always be excluded (Vidarar and Stotzky 1992). Determination of the characteristics of the GMM and of the test site and surrounding environment are essential features of the experimental design. In view of the large number of parameters determining the multiplication, dispersal and establishment of viable organisms beyond the site of the experiment, as well as the complexity of interactions with other organisms and ecosystem processes, measures are aimed mainly at minimizing the dispersal of the transgene, or alternatively at preventing or mitigating its establishment beyond the test site.

In addition, it is possible to 'engineer' properties that minimize the probability of horizontal gene transfer and reduce the ability of the GMM to compete with native organisms. By definition, deliberate release of bacteria in the environment means the establishment of an adequate population to perform an intended function (degradation of xenobiotics, plant protection, vaccination, etc.). A useful strategy for containing bacterial establishment for the duration and the location of the intended use only is the integration into the genome of the microorganism of an environment-inducible gene that has the potential of killing its host if induced in an environment other than its intended use. This strategy is equivalent to the geographical confinement of the GMM. Several suicide systems have been identified in *E. coli* plasmids. The significant containment potential of this strategy is hampered by the fact that the total elimination of the GMM population is highly unlikely, either because of the possibility of mutations or through inadequate expression of the suicide gene (Molin 1993).

10.3.5 Indirect impacts

The direct effects of biotechnology on biodiversity operate through biological processes. The indirect effects are

predominantly socioeconomic ones, working through human economic and social systems. Yet because people live first within social systems, any indirect effects can be of major importance, especially for developing countries where many people rely directly on biodiversity for sustenance. Numerous examples are now emerging of potential beneficial socioeconomic outcomes. How these benefits may be identified and fostered is an essential component of the assessment of the use of any biotechnology application. On the other hand, negative implications exist as well, and should be considered in any assessment. As mentioned above, however, risk assessment relating to direct effects of biotechnology applications is distinct from that relating to indirect effects, and as a general matter should be undertaken independently.

Indirect effects can be defined as those operating through another mechanism. The potential number and type of indirect effects of biotechnology could be immense, and attempting to identify them all would be a speculative exercise of little practical value. The relevant mechanism of indirect effects to focus on is change in relative costs and prices. The effects themselves are the results of human responses to those changes.

As an example, biotechnology could lead to the identification of a plant material for an important pharmaceutical use. This use would raise the value of that material, which would increase collection pressures, possibly leading in poorly controlled areas to over-exploitation and species loss. Alternatively, biotechnology could simplify preservation technologies, increasing the chance that the species would be preserved *in situ*.

Indirect effects can be divided into *secondary* effects, those caused by the initial adjustments, and *tertiary* effects, encompassing subsequent adjustments. As a hypothetical example, biotechnology that replaced a broad-spectrum synthetic pesticide with a more specific and less costly biopesticide would be expected to foster greater biodiversity of animal life in the area. This would be the secondary effect. However, as a consequence of lower costs, farmers might increase the area farmed, potentially degrading regional biodiversity, or alternatively they might reduce the land area farmed, with beneficial effects on biodiversity. These would be tertiary effects. Another example of a tertiary effect of biotechnology involves the production of pharmaceuticals. Better medicines have led to population increase which is linked with environmental degradation and biodiversity loss. However, because of their speculative nature, or because specific connections are unclear, tertiary effects receive limited attention.

There is at present very limited field experience with the products of biotechnology. In terms of the definition used in this Section, very few species altered by biotechnology

are currently in commercial use. Consequently most indirect impacts of biotechnology applications cannot be analysed directly but rather must be assessed from related past experiences. Of these, the Green Revolution is perhaps the most relevant. Owing to the nature of the data, what can be projected most clearly of change is its direction, less clearly its magnitude.

The economic values of biodiversity, and the social and environmental impacts of changes in these values, are the major focus of Section 12. Because biotechnology is, in essence, a set of tools used to achieve the same broad objectives in biodiversity utilization as conventional methods, all of the general considerations presented in Section 12 apply to biotechnology, and they are not discussed in detail here. The discussion below focuses only on specific attributes of biotechnology that may have indirect socioeconomic effects and impacts on biodiversity.

Furthermore, in the brief discussion that follows, attention is placed primarily on the components of biodiversity regarded as genetic resources. Indirect impacts of biotechnology applications will arise mainly through changes to these components. However, it is implicit that preserving this part of biodiversity will contribute to the conservation of the whole.

10.3.5.1 Increases in value of genetic resources generated by biotechnology applications

Several attributes of biotechnology are likely to raise the value of genetic resources as inputs. For example:

- Biotechnology makes gene transfer possible both within species and between unrelated species, increasing the utilization potential of genetic resources and hence their value.
- Biotechnology, in the form of bioassays, has reduced the time and cost of screening for pharmaceutical and other uses and increased the value of the underlying genetic resources.

For discussion of how such values may be estimated, see Section 12.

10.3.5.1.1 Implications of value increases. Value increases through applications of biotechnology can have several implications. Most of these are of a general nature, and are discussed in Sections 11 and 12. They include interest and conflict over ownership of genetic resources, the rates at which these resources should be utilized, intellectual property rights, and formulation of laws relating to access to the resources. There are, however, some aspects of value increases that apply to biotechnology applications in particular, and are briefly outlined below.

10.3.5.1.2 *Remoteness of incentives for conservation.*

The placement of a value on sustainable as opposed to destructive uses of genetic resources for biotechnology applications would be expected to increase conservation. The Merck/INBio arrangement (Reid *et al.* 1993) is a well-known example of such an agreement, but the consequences for conservation are not easily recognizable in the well-protected national reserves that are the sources of the resource materials (see Sections 12 and 13).

The benefits of such direct uses of genetic resources flow immediately to the protectors. Whether these concepts will apply to less tangible and more distant benefits of biotechnology applications is not evident at this stage. For many genetic resources the immediate benefit from collection fees is small, and any real return must await a protracted period of product development.

10.3.5.1.3 *Moralethical debates.* The rise in value of genetic resources associated with biotechnology has been cast into a moral and ethical framework. The debate is sufficiently broad that it is not possible at present to determine the overall implications. Even so, there is a distinct possibility that the debate and the responses to it will lead to delays and restrictions on the use of genetic resources which are the raw materials for biotechnology applications.

Because the inputs often are genetic resources, and the means of incorporation is biotechnology, there have been many calls for sharing the value of the final products. This is reflected in the 'fair and equitable sharing' clause in the Convention on Biological Diversity [Article 15.7], as well as in calls for new forms of intellectual property rights for genetic resources and in specific proposals like 'Farmers' Rights'. Not everyone would regard these predominantly monetary issues as ethical matters, but they are so for many people for whom economic equality is often considered a matter of equity. For further discussion, see Section 12.

Objections to particular uses of biotechnology are more clearly ethical in the conventional sense. The use of human genetic materials in other life forms provides one particular focus, and raises cultural as well as individual objections. More general is the concept of 'species integrity', the notion that species have an inherent right to exist as created. The concept lacks substantial scientific support (see Macer 1990). It is an emotional rather than a scientific issue, and surveys indicate only a slight plurality of support for bioengineering of animals (Macer 1990, Fig. 4-1; 1992, Tables 4-2, 5-3).

Overall, the majority of people world-wide seem to accept a pragmatic approach to biotechnology termed 'Interest Sensitive Speciesism'. While that position is likely to determine policy in the long term, minority views, many in opposition, can inhibit utilization of biotechnology applications in the interim.

10.3.5.2 *Biotechnology-generated increase in agricultural productivity*

Agriculture, including aquaculture and silviculture, is the major land use in the world, and the principal source of human environmental impact. Hence anything that biotechnology contributes to agricultural activities will have environmental impacts, including impacts on biodiversity. Productivity increases attributed to the Green Revolution have resulted in the same amount of food, feed and fibre being produced in the 1990s on about 40% less land than would have been required using 1960s technology. It is possible that biotechnology will have similar effects, although the reality will not be known for many years. Improvements in the feed conversion of animals (including fish) will reduce the amount of land required to support the production of meat, milk and eggs.

General outcomes, consistent with all types of productivity increase, include using less but better quality land, and reduced pressure for cultivating new land.

The driving forces are primarily economic. Higher-quality land has lower production costs. Reduced pressure for the clearing of new land for agriculture can have powerful conservation effects, but local economic factors will ultimately determine whether this happens (see Section 13).

10.3.5.2.1 *Replacement of traditional landraces.* Traditional crop varieties are the result of millenia of selection by farmers, and are a major source of genetic diversity in agriculture and of genetic resources for plant breeding (10.1.2.1). Much use of such landraces ended with the Green Revolution, when so-called improved varieties replaced the local varieties. For example, whereas Philippine farmers at one time used hundreds or even thousands of rice varieties, two varieties accounted for 90% of the area planted in one recent year (National Research Council 1993, Ch. 1; Friis-Hansen 1994). Further improvements in varieties as a result of biotechnology are feared to displace yet more traditional varieties, exacerbating the loss of biodiversity and increasing the vulnerability of genetically uniform crops. The extent of this potential problem and appropriate management solutions are not yet clear (see Sections 12 and 13).

10.3.5.2.2 *Disadvantaged groups.* In the context of the possible benefits of biotechnology, those who will be relative losers are seldom discussed. The legacy of the Green Revolution and other major changes in technology indicate that biotechnology will disadvantage some groups, particularly in marginal production areas. Declines in crop prices, owing to reduced production costs, will further marginalize fringe areas. If they have no alternative non-farming land-use opportunities, the poor tend to degrade their environment further. Thus, without specific remedial action, further selective degradation and consequent loss of

biodiversity can be anticipated. The extent cannot be predicted at this time, but must be considered in the context of the overall effects of biotechnology.

References

- Adam, K.D., King, C.M. and Köhler, W.H.** 1993. Potential ecological effects of escaped transgenic animals: reasons from past biological invasions. In: Wöhrmann, K. and Tomiuk, J. (eds), *Transgenic Organisms: Risk assessment of deliberate release*. 153–173. Birkhäuser-Verlag, Basel.
- Angle, J.S.** 1994. Release of transgenic plants: biodiversity and population-level considerations. *Molecular Ecology* **3**: 45–50.
- Campbell, A.** 1991. Microbes: The laboratory and the field. In: Davies, B.D. (ed.), *The Genetic Revolution*. 28–44. John Hopkins University Press, Baltimore, Md.
- Dale, P.J.** 1994. The impact of hybrids between genetically modified crop plants and their related species: general considerations. *Molecular Ecology* **3**: 31–36.
- DeBach, P. and Rosen, D.** 1991. *Biological Control by Natural Enemies*, 2nd edn. Cambridge University Press, Cambridge.
- Drake, J.A. and Mooney, H.A.** (eds) 1989. *Biological Invasions: A global perspective*. John Wiley, New York.
- Edge, T.** 1994. Genetically Modified Organisms. In: *Biodiversity in Canada: A science assessment*. 156. Environment Canada, Canadian Wildlife Service, Ottawa.
- Fiksel, J.** 1991. Applications of knowledge systems for biotechnology risk assessment and management. In: Levin, M. and Strauss H. (eds), *Risk Assessment in Genetic Engineering: Environmental release of organisms*. 354–367. McGraw-Hill, New York.
- Friis-Hansen, E.** 1994. Conceptualizing *in situ* conservation of landraces. In: Krattiger, A.P., McNeely, J., Lesser, W., Miller, K., St Hill, Y. and Senanayake, R. (eds), *Widening Perspectives in Biodiversity*, Chapter 5-3. IUCN/IAE, Gland and Geneva.
- Kapuscinski, A.R. and Hallerman, E.M.** 1990. Transgenic fish and public policy: anticipating environmental impacts of transgenic fish. *Fisheries* **15** (1): 2–11.
- Kim, J., Ginzburg, L.R., Dykhuizen, D.E.** 1991. Quantifying the risks of invasion by genetically engineered organisms. In: Ginzburg, L.R. (ed.), *Microorganisms in Assessing Ecological Risks of Biotechnology*. 193–214. Butterworth-Heinemann, Stoneham, Mass.
- Lenski, R.E.** 1991. Quantifying fitness and gene stability. In: Ginzburg, L.R. (ed.), *Microorganisms in Assessing Ecological Risks of Biotechnology*. 173–192. Butterworth-Heinemann, Stoneham, Mass.
- Lesser, W.H. and Maloney, A.P.** 1993. *Biosafety: a report on regulatory approaches for the deliberate release of genetically-engineered organisms – issues and options for developing countries*. Cornell International Institute of Food, Agricultural Development: CHFAD.
- López-Pila, M. G. and Scheler, C.** 1993. Gene transfer from bacteria and heterologous viruses into cells of higher organisms. In: Wöhrmann, K. and Tomiuk, J. (eds), *Transgenic organisms: risk assessment of deliberate release*. 65–82. Birkhäuser-Verlag, Basel.
- Macer, D.R.J.** 1990. *Shaping Genes: Ethics, law and science of using new genetic technology in medicine and agriculture*. Eubios Ethics Institute, Christchurch, New Zealand.
- Macer, D.R.J.** 1992. *Attitudes to Genetic Engineering; Japanese and international comparisons*. Eubios Ethics Institute, Christchurch, New Zealand.
- Médique, C., Rouxel, T., Vigier, P., Hénaut, A. and Danchin, A.** 1991. Evidence for horizontal gene transfer in *Escherichia coli* speciation. *Journal of Molecular Biology* **222**: 851–856.
- Molin, S.** 1993. Environmental potential of suicide genes. *Current Opinion in Biotechnology* **4**: 299–305.
- Morra, M.J.** 1994. Assessing the impact of transgenic plant products on soil organisms. *Molecular Ecology* **3**: 53–55.
- National Research Council, Board on Agriculture** 1993. *Managing Global Genetic Resources*. National Academy Press, Washington, DC.
- OECD** 1992. *Good Developmental Principles (GDP): Guidance for the design of small-scale field research with genetically modified plants and microorganisms*. Part Two of Safety Considerations for Biotechnology, 1992. OECD, Paris.
- OECD** 1993. *Safety Considerations for Biotechnology: Scale-up of crop plants*. OECD, Paris.
- Reid, J.W., Laird, S.A., Meyer, C.A., Gamea, R., Sattenteh, A., Janzen, D.H., Gollin, M.A. and Juma, C.** 1993. *Biodiversity Prospecting: Using genetic resources for sustainable development*. World Resources Institute, Washington, DC.
- Rissler, J. and Mellon, M.** 1993. *Perils Amidst the Promise: Ecological risks of transgenic crops in a global market*. Union of Concerned Scientists, Cambridge, Mass.
- Stewart-Tull, D.E.S. and Sussman, M.** (eds) 1992. *The Release of Genetically Modified Microorganisms – REGEM 2 (Second International Conference)*. Plenum Press, New York.
- Strauss, H. S.** 1991. Lessons from chemical risk assessment. In: Levin, M. and Strauss, H. (eds), *Risk Assessment in Genetic Engineering: Environmental Release of organisms*. 297–318. McGraw-Hill, New York.
- Tomiuk, J. and Loeschke, V.** 1993. Conditions for the establishment and persistence of populations of transgenic organisms. In: Wöhrmann, K. and Tomiuk, J. (eds), *Transgenic Organisms: Risk assessment of deliberate release*. 117–134. Birkhäuser-Verlag, Basel.
- Tiedje, J.M., Colwell, R.K., Grossman, Y.L., Hodson, R.E., Lenski, R.E., Mack, R.N. and Regal, P.J.** 1989. The planned introduction of genetically engineered organisms: ecological considerations and recommendations. *Ecology* **70**: 298–315.
- Thompson, H.V.** 1993. The rabbit in Britain. In: Thompson, H.V. & King, C.M. (eds), *The European Rabbit: The history and biology of a successful coloniser*. 101–121. Oxford University Press, Oxford.
- UK Department of Environment** 1993. *The regulation and control of the deliberate release of genetically modified organisms (GMOs)*. DOE/ACRE Guidance Note 1.
- UK Department of Environment** 1994. *Fast track procedures for certain GMO releases*. DOE/ACRE Guidance Note 2.
- USDA** 1990. Availability of an environmental assessment and finding of no significant impact relative to USDA funding of research on transgenic carp. *Federal Register* **55**: 48661–48662.
- USDA** 1993. *Genetically engineered organisms and products: notification procedures for the introduction of certain*

regulated articles; and petition for nonregulated status. Animal and Plant Health Inspectorate Service 7CFR Part 340.

Vidaler, A.K. and Stotzky, G. 1992. Overview: confinement, decontamination and mitigation. In: Levin, M. A., Seidler, R. J. and Rogul, M. (eds), *Microbial Ecology: Principles, methods and applications*. 781–797. McGraw-Hill, New York.

10.4 Conclusions

10.4.1 Biotechnology provides important tools for biodiversity assessment and monitoring

10.4.1.1 Key molecular technologies for biodiversity assessment and monitoring include screening methods for various classes of compounds, and DNA fingerprinting.

10.4.1.2 Applications of biotechnology can increase our understanding of biodiversity at several levels, ranging from the effects of habitat modification or population fragmentation on partitioning of genetic diversity, through definition of taxonomic boundaries, to understanding evolutionary relationships on a broad scale. It contributes to our understanding of processes that underlie patterns of biodiversity. In effect, biotechnology brings new levels of quality and refinement to inventorying and monitoring of the living world.

10.4.2 Biotechnology provides important tools for biodiversity conservation

10.4.2.1 *In situ*. Applications of biotechnology provide data critical for the best management solutions for species. They allow assessment of optimal or minimal population sizes for maintaining diversity, and best practices for augmenting wild populations through transfers from other wild populations or from captive breeding programmes.

10.4.2.2 *Ex situ*. Biotechnology contributes greatly to the quality and efficiency of *ex situ* conservation of biodiversity.

10.4.2.2.1 Biotechnology increases the quality of *ex situ* germplasm collections. Samples characterized on the basis of DNA sequence rather than on phenotype can provide better coverage of existing diversity, and can provide a means of avoiding redundancy.

10.4.2.2.2 Biotechnology is the entire basis for a class of non-living conserved collections, namely DNA libraries and sequence databases. It allows compact storage of large amounts of genetic information which are recoverable for conservation or utilization objectives.

10.4.3 Biotechnology provides important tools for biodiversity utilization for human benefit

Living organisms can be used as factories for specific products, targeted to a variety of production end uses, harnessed for environmental remediation, or used in industrial processes. Biotechnology applications can serve rural, manufacturing and extractive activities.

10.4.3.1 *Biotechnology-assisted breeding*. Especially

through use of genetic markers, biotechnology can both enhance and accelerate the breeding process.

10.4.3.2 *Genetic engineering*. Although not a universal solution, genetic engineering is the most elegant way of improving domesticated breeds. Protocols for gene transfer are now becoming routine. Genetic engineering can be used, among other objectives, to increase productivity, control disease, eradicate pests and improve product quality or novelty.

10.4.3.3 *Novel genes and gene products*. Biotechnology-based screening (bioprospecting) can increase our capacity to locate and benefit from useful genes and compounds in the biodiversity around us.

10.4.3.4 *Environmental remediation*. Biodiversity is the key resource for rehabilitating degraded ecosystems. Biotechnology greatly enhances both the specificity and efficiency of remedial actions.

10.4.4 Biotechnology can impact on biodiversity in various ways

These impacts can be direct or indirect. Both for human benefit and for environmental conservation, the outcomes can be positive or negative. Importantly, there are realistic ways of assessing potential impacts, and therefore of gaining maximum benefits from biotechnology applications. The benefits can be realized for both industrialized and non-industrialized peoples and places.

10.4.4.1 *Direct impacts of biotechnology are ecological or evolutionary, and can be assessed by scientific methodology and tested experimentally*. They could include introgression, weediness, pathogenicity, altered nutrient cycling and a range of responses in other species populations.

10.4.4.1.1 *Procedures exist in many countries for assessing the possible impact of release of genetically manipulated organisms*. In general, these adopt a case-by-case approach, although generic *a priori* risk appraisal is becoming acceptable in some situations. Step-by-step approaches to risk assessment may be of little predictive value for assessing the risk of commercial releases. Careful definition of data required during experimentation and post-release monitoring is necessary.

10.4.4.1.2 *Risk reduction is achieved mainly by confinement*. Measures for minimizing direct impacts on native ecosystems aim to impose specified limits on gene transfer, on exposure to toxic products and on direct invasion. Good containment possibilities exist, even for microorganisms. Past experience with release of conventionally bred varieties is often a good guide for best practice.

10.4.4.2 *Indirect impacts of biotechnology are predominantly socioeconomic*. They can be of major importance because of the way social systems drive our use of biotechnology and biodiversity. Risk assessment for indirect impacts should therefore be independent of that for direct impacts.

10.4.4.2.1 Biotechnology can increase the value of genetic resources. In absolute terms these values may be limited, but value changes may lead to indirect effects. These may include conflicts over ownership, including intellectual property; altered rates of utilization and therefore of resource conservation and environmental protection; and ethical debates on the acceptable scope of the biotechnology applications themselves.

10.4.4.2.2 When biotechnology results in increased agricultural productivity, both positive and negative impacts can be predicted. These include changed pressures for cultivating new land, replacement of traditional landraces, and marginalization of fringe production areas through price changes.

Biotechnology has great potential to generate benefits, both environmental and socioeconomic. It can enhance our understanding of biodiversity and our capacity to conserve, manage and utilize it. It can improve our production systems and the diversity of the amenities we desire. In general, however, its impacts on biodiversity may not be different in nature, but only in degree, from those of our traditional or conventional practices. These impacts may be direct ecological and evolutionary outcomes of biotechnology applications, or indirect, resulting from

altered socioeconomic circumstances. The Convention on Biological Diversity calls for appropriate safeguards to ensure safe applications of biotechnology. We have a growing capacity to assess likely impacts, and to make informed decisions both for conservation of biodiversity and for equitable sharing of the benefits of biotechnology.

Acknowledgements

Helpful advice on the structure, development and/or authorship of the Section 10 text was kindly provided by Dr J.T. Baker, ACT Commissioner for the Environment, Canberra, Australia; Dr Evans Lagudah, Department of Agriculture, University of Western Australia; Dr K.M. Old, Assistant Chief, CSIRO Division of Forestry, Canberra, Australia; Professor Dulce de Oliveira, Instituto de Biologica, Centro de Ciencias de Saude, Rio de Janeiro, Brazil; Dr C. Pankhurst, CSIRO Division of Soils, Adelaide, South Australia; Dr Cyrie Sendashonga, UNEP, Nairobi, Kenya; Dr A.H.D. Brown, Dr D. Llewellyn and Dr Judy G. West, CSIRO Division of Plant Industry, Canberra, Australia. The final version of the text also incorporates suggestions of many peer reviewers.

Human Influences on Biodiversity

J.A. McNEELY, M. GADGIL, C. LEVEQUE, C. PADOCH, K. REDFORD

Lead authors:

M. Gadgil (Chapter 11.1); J.A. McNeely (Chapter 11.2); C. Levèque (Chapter 11.3); K. Redford (Chapter 11.4)

Contributors:

C. Arden-Clarke, M. Bellon, F. Berkes, R. Beverton, P. Bloch, J. Bonner, M. Bouamrane, T. Burton, M. Cameron, M. Cesario, M. Chauvet, J. Clay, G. Coggins, P. Condon, M. Corbett, P. Craig, M.C. Cruz, J. Diamond, D. Ehrenfeld, I.A. Fleming, L. Fortmann, M. Freudenberger, G. Frisvold, A. Ghosh, D. Ghosh, H. Gjosaeter, H. Glasser, M.G. Gogte, N. Goodwin, A. Hails, J. Hamre, R. Healy, S. Hecht, B. Hitchcock, J. Hodges, K. Hindar, B. Jonsson, A. Kothari, L. Laikre, R. Leemans, L. Malaret, K.C. Malhotra, C. Martinet, J. Matowanyiko, J. Mehta, J.L. Munro, G. Ness, R. Norgaard, G. Olssen, E. Ostrom, N. Peluso, F. Popper, D. Popper, H. Raffles, P.S. Ramakrishnan, N.H. Ravindranath, R. Raza, M. Ritchie, D. Rocheleau, B.O. Rosseland, N. Ryman, C. Safina, O.T. Sandlund, P. Waggoner

CONTENTS

Executive Summary	715		
11.0 Introduction: conceptual framework	717		
11.1 The history of human impact on biodiversity	718		
11.1.1 Introduction	718		
11.1.2 The hunter-gatherer phase	718		
11.1.3 The farming phase	721		
11.1.4 The urban phase	726		
11.1.5 The modern high-energy phase	728		
11.1.6 History of conservation traditions	730		
11.1.7 Historical trends in property rights	732		
11.2 The impact of human activity on biodiversity	733		
11.2.1 Introduction	733		
11.2.2 The mechanisms of human impacts on biodiversity	736		
11.2.2.1 Exploitation of wild living resources	736		
11.2.2.2 Expansion of agriculture, forestry and aquaculture	740		
11.2.2.2.1 Introduction	740		
11.2.2.2.2 Traditional cultivation	742		
11.2.2.2.3 Modern cultivation	744		
11.2.2.2.4 Fisheries	746		
11.2.2.2.5 Forestry	749		
11.2.2.3 Habitat loss and fragmentation	751		
11.2.2.4 Indirect negative effects of species introduced by humans	757		
11.2.2.4.1 Introduction	757		
11.2.2.4.2 Introduced species and their distribution	758		
11.2.2.4.3 Effects of invasive species and ecosystem susceptibility	758		
11.2.2.4.4 Recovery of invaded ecosystems	760		
11.2.2.5 Pollution of soil, water, and atmosphere	761		
11.2.2.6 Global climate change	763		
11.2.3 Forces driving human impact on biodiversity	763		
11.2.3.1 The rules governing the use of biological resources	763		
11.2.3.1.1 Introduction	763		
11.2.3.1.2 The impact of cultural values on biodiversity	764		
11.2.3.1.3 Property rights and the use of biological resources	767		
11.2.3.1.4 Impact of access to information intellectual resource rights	769		
11.2.3.2 Growth in human population and natural resource consumption	771		
11.2.3.3 Urbanisation and biodiversity	774		
11.2.3.3.1 Effects of urbanization on biodiversity	774		
11.2.3.4 Consequences of increasing demand for resources	776		
11.2.3.5 Economic systems and policies that fail to value the environment and its resources	779		
11.2.3.6 Inequity in the ownership, management and flow of benefits from the use and conservation of biological resources	782		
11.2.4 Conclusions	783		
11.3 Information requirements for the sustainable use of biodiversity	783		
11.3.1 Introduction	783		
11.3.2 Monitoring biodiversity, its use, and changes in natural and managed ecosystems	784		
11.3.2.1 Long-term monitoring	784		
11.3.2.2 Monitoring the rehabilitation of degraded ecosystems	785		
11.3.2.3 Species introductions	785		
11.3.2.4 Inventory and data bases	785		
11.3.3 Strengthening social science research and the connections between biological and social processes	786		
11.3.3.1 Knowledge, innovations, and practices of indigenous and local communities	786		
11.3.3.2 Legal aspects	786		
11.3.3.3 Economics and biodiversity	787		
11.3.3.3.1 Contribution of wild species to local economies and to international trade	787		
11.3.3.3.2 How to value what we have?	788		
11.3.3.3.3 Managing trade and having biodiversity too	789		
11.3.4 Toward sustainable use of resources and ecosystems: the need for new management options	789		
11.3.4.1 Ecosystems management	789		

11.3.4.2	Living resources management	789	11.4.2.2	Changes in terrestrial and aquatic ecosystems	794
11.3.4.3	The question of common property of natural resources	791	11.4.2.3	Climate change	795
11.3.4.4	Predicting the consequences of social and economic changes on biological diversity	791	11.4.2.4	Implications of global change	798
11.3.4.5	Knowledge-based systems	791	11.4.3	Human adaptations	799
11.3.4.6	Development and transfer of technologies relevant to the sustainable use of biological diversity	791	11.4.3.1	The benefits of technology	799
11.4	Future prospects	792	11.4.4	Constraints on human adaptations	800
11.4.1	Introduction	792	11.4.4.1	Problems of uneven development	800
11.4.2	Trends	792	11.4.4.2	Prices, politics and alternative models of development	801
11.4.2.1	Population and resources	792	11.4.4.3	Building the capacity to adapt to change	801
			11.4.4.4	Uncertainty	802
			References		802

EXECUTIVE SUMMARY

Humans depend on biological resources for food, energy, construction, medicine, inspiration, and much else besides. Indeed, biodiversity and humans have had a close and mutually supportive relationship for tens of thousands of years. The biological resources upon which people depend have the critical character of being renewable, at least when they are managed well; but biological resources that are abused can also become extinct. The way societies have managed their resources determines how much diversity survives and the way that societies manage biological diversity determines the productivity of important resources and ecological services.

Human activities have helped to create substantial genetic and species diversity, and have increased the diversity of biological communities in particular regions through resource management practices and through the domestication of plants and animals.

A number of traditional resource management practices have supported the maintenance of species and genetic diversity. Systems of shifting cultivation in Southeast Asia, for example, often left some portions of the land permanently out of the rotation as sacred groves. And within the cultivation rotation itself, high levels of species diversity have been maintained, because the fallow fields offer productive feeding grounds for many species of wildlife. Shifting cultivation systems that once covered much of the land surface of the Earth (except Australia) have had a profound influence on biodiversity, often leading to increases in those species that were of greatest interest to people.

Low-input agricultural systems have long been important sources and custodians of biodiversity. Farmers frequently grow mixtures of different crops adapted to different localities in order to reduce the risk of loss to pests or extreme weather. Farmers have also traditionally engaged in active breeding of local cultivars and livestock, building most of the genetic base of our modern intensive agricultural systems. These traditional biological technologies have now been supplemented by modern breeding techniques and the new 'biotechnologies' including tissue culture and genetic engineering. These techniques rearrange genetic diversity and create new plant and animal varieties.

Within any given region, the introduction of alien species may increase the species diversity in that region. However, species introductions can be a major cause of extinction of native species and the global effect of increased rates of species introduction is overwhelmingly a net loss of global species diversity. Species are introduced for many reasons, most of which relate to the human interest in providing species that are especially helpful to people, such as agricultural species; but humans also accidentally introduce species, such as rats on oceanic islands and zebra mussels in the North American Great Lakes. Nevertheless, within a given region, species introductions can increase diversity. For example, the diversity of domesticated species in temperate cities may exceed the natural species diversity in the region, and many islands, such as those of New Zealand, now contain more alien plant species than native species. Similarly, the mammalian fauna of Britain has been increased through the introduction of new mammal species, even as it was earlier reduced by human-induced extinctions.

Biotic impoverishment – the loss of the characteristic diversity of species, genes and biological communities in a region – is an almost inevitable consequence of the ways in which the human species has used and misused the environment in the course of its rise to dominance; the factors that have led to the expanding ecological niche of humans are indirect causes of the loss of biodiversity. One study suggests that humans today annually mobilize approximately 40% of the total primary production on land, a massive and pervasive co-option of resources that inevitably leads to significant impoverishment of the biota.

The underlying causes of loss of biodiversity stem from changes in attitudes toward nature; growth in human population and natural resource consumption; the impact of global trade; economic systems that fail to value the environment and its resources; and inequity in the ownership, management, and flow of benefits from both the use and conservation of biological resources.

Human impacts on all levels of biodiversity are closely interrelated. An introduction of a new gene into a population, for example, could change the competitive dominance of that species, causing the extinction of a competitor and changing the composition and processes in the biological community. Recognizing that these impacts

cannot be fully separated, it is still useful to assess the impacts humans are having or could have on each general level of biodiversity.

Humans have been a cause of species extinction for thousands of years, especially when they migrated into new habitats. Hunting of large mammals in the Americas and Australia is thought to have contributed to substantial extinctions of large mammals between 50 000 and 15 000 years ago, as humans first moved into these continents. During the past 400 years, some 486 animal and 654 plant species are recorded as having gone extinct.

Despite the long history of human impact, human activities are placing significantly more species at risk of extinction today than at any time in the past as a result of environmental changes affecting current population sizes, environmental carrying capacity, population density, the mean and variance in population growth rates, the genetic structure of populations and the size, number and distances of suitable habitat patches and local populations.

The current dominance of intensive agricultural production in much of the world, which relies on lower levels of varietal diversity, has led to a significant reduction in the genetic diversity of crops and livestock under active management. For example, some 27% of the over 1400 recorded breeds of animals are threatened with extinction.

Declines in indigenous breeds and varieties and their replacement by a few varieties has been less extensive in developing countries but is now accelerating. In India, for example, an estimated 50 000 local varieties of rice existed until recently. Today, a small number of varieties is grown on over 70% of the rice land and on 90% of land allocated to wheat. In one district, an estimated 95% of traditional rice varieties have been lost.

The introduction of any new crop, crop variety or micro-organism can have significant impacts on the genetic make-up of other species in the region, and potentially on the composition of surrounding biological communities. The nature of these potential impacts is independent of the technology used to produce the variety: gene flow from a traditionally bred crop variety could represent as great a threat as gene flow from a genetically engineered variety.

Human impacts on biological communities take two main forms: conversion from one type of community to

another; and modification of the conditions within a biological community. Worldwide, forest and woodland communities have decreased by about 15% in area since pre-agricultural times. Temperate forests are currently relatively stable in area, while tropical forests are rapidly decreasing in area; but even in the temperate forests, the increasing area of plantations means that much biodiversity is being lost even if the forest area remains relatively constant.

Since 1700, cropland has increased five-fold and since 1800, irrigated cropland has increased 24-fold. The area in grassland has remained roughly constant over the past 300 years, with loss through conversion to cropland being balanced by gain through deforestation. The area of grassland has decreased significantly in Europe, North America and Southeast Asia, but this has been compensated by increases in Latin America and tropical Africa.

Commercial agriculture has led to considerable marginalization of the landscape. Surface irrigation schemes, for example, transform the complex mosaic of micro-habitats into a uniform agricultural mosaic, favouring a few crop species and varieties while displacing numerous micro-habitats such as hedgerows, fallow fields, tree groves, riparian vegetation, and so forth.

The introduction of alien species is often responsible for the modification of conditions within a biological community. Introductions influence the genetic diversity of native species and may alter species composition by causing the extinction of other species, influencing the interactions between other species, and altering ecological processes such as water chemistry, nutrient cycling and soil structure.

The perception that biodiversity management is primarily an issue of isolating biodiversity from humanity is a very recent phenomenon and is scientifically unfounded. Traditionally, biodiversity has been conserved and utilized as an integral part of resource management. While active protection of biodiversity by governments has played and should continue to play an important role in biodiversity management, even more important will be steps to reintroduce or restore local and regional management practices that successfully integrate sound management of biological resources.

11.0 Introduction: conceptual framework

Humans depend on biological resources for food, energy, construction materials, medicine, inspiration, and much else besides. Further, biological resources have the critical character of being renewable, so with proper management they can be used sustainably. However, when the levels of human use of biological resources exceed their capacity for renewal, the diversity and productivity of the system in which they occur may be reduced. Ultimately, the way that societies manage their resources determines how much diversity survives. Societies vary in the extent to which they use external inputs in resource management, with some societies living at a very basic stage and others almost totally dependent on external inputs (especially of energy). This section reviews the history of human impacts on biodiversity, assesses the factors that govern the way human societies influence biodiversity, identifies gaps in knowledge, and speculates about future human impacts.

The history of human civilization is intricately associated with the evolution of artefacts – objects constructed by people from natural resources. Centuries of effort have resulted in an endless procession of technological innovations which transformed many terrestrial and aquatic ecosystems, leading in turn to profound – but usually unquantified – impacts on biological diversity.

As indicated by historical evidence, traditional activities related to agriculture, fishing and livestock husbandry sometimes had the quality of sustainability, but many traditional systems also carried with them the seeds of their own destruction. Over time, selection may have led to sustainable systems that were in the self-interest of the people involved, at least at their current level of population and technology. However, with recent technological advances, changing demographic profiles and the quest for a 'better' quality of life, biological resources became easy targets for over-exploitation, and at an unprecedented rate.

Modern tools and technologies, with their roots in the Industrial Revolution and their flowering after 1945, changed the relationship between people and resources in at least two fundamental ways: scale and intensity. In terms of impacts on ecosystems, a large number of technologies aimed at short-term gains have also had long-term effects which may not have been foreseen. While many of these technologies are more efficient than the earlier practices (in the sense of being able to support more people), their pattern, scale and intensity of use have led to profound and unpredicted consequences for biodiversity. For example, mechanized fishing trawlers, with satellite back-up and on-board processing units, have led to depletion of many fish stocks. Intensive agriculture with multiple cropping by artificial manipulation of the soil system and high input of chemicals has resulted in increased wastelands and waterlogged areas in many parts of the world. New technologies intensify open-cast mining resulting in large-

scale loss of cropland and subsoil water. Taken together, the full range of heavy industries, chemicals, fertilizers and power plants has had significant impacts on surface water, groundwater quality and biological resources. However, the last few decades have also been marked by the development of technological innovations that appear to be 'biodiversity friendly', ranging from bio-composters and wetland options for waste-water treatment to national systems of protected areas.

Many of the issues involving human impacts on biodiversity can be illuminated by considering energy flows – especially in the form of carbon – between systems and regions. Once humans began to use sources of energy from outside their own bodies, their relationship with biodiversity underwent a fundamental transformation. The use of fire gave people the potential to change environments in fundamental ways, including converting forests to grasslands. The much later use of fossil fuels – formed from once-living organisms – has led to further changes, including international trade which has the effect of enabling local resources to be harvested to feed a global market that has little information on the impact of its harvest.

While the benefits to humanity of the use of fossil fuels such as oil and gas have been enormous, their use has also entailed costs to biodiversity. Fossil fuels have enabled the world to become a global marketplace, so that local feedback is no longer a mediating force in over-exploitation of local ecosystems. Fossil fuels have also played a dominant role in the Industrial Revolution, which has led to greatly increased levels of consumption and an additional range of costs and benefits for biodiversity. And fossil fuels have led to various forms of pollution, again with a range of impacts on biodiversity. Since fossil fuels are non-renewable, at least at time-spans of interest to humans, they will not form a permanent part of human cultures. It is therefore important that their impacts on biological resources be minimized so that the renewable resources remain available to support human welfare.

Among the most significant human impacts on biodiversity has been the domestication of plants and animals, which began thousands of years ago. The controlled breeding of plants and animals procured a more reliable and expandable resource base than subsistence hunting and gathering, allowing humans to reduce substantially the space required for sustaining each individual. This, in turn, provided a secure basis for cultural advancement, from the establishment of the first major settlements to entire civilizations. In terms of biodiversity, the selective breeding of species, whether conscious or unconscious, also expanded the range of human impact from habitats and species to genes. The 40 or so species of animals that have been domesticated have often greatly increased their genetic diversity, range and populations due

to human management, as have the 100 or so main domesticated plant species and thousands of other plants selected for use as food, spice, medicine, decoration and construction. But the gains for these species, which have had their fates linked with human desires, typically have been at the expense of other species which people found less easy to mould to their vision of the desirable.

The historical landmarks of tool use, technology development, energy capture and domestication form the building blocks with which humans have had and continue to have impacts on biodiversity.

11.1 The history of human impact on biodiversity

11.1.1 Introduction

Our species is remarkable for the wide range of plant, animal and mineral resources we put to use. Humans feed on mushrooms and grass seeds, green leaves and fleshy fruit, ants and crabs, fish and frogs, snakes and monkeys, dolphins and elephants. We also use bacteria to ferment milk and fungi to produce antibiotics; crocodiles and snow leopards to furnish hides, and eucalyptus trees to furnish the pulp out of which are fashioned clothes and shoes; trees to provide wood and whales to provide tallow for lighting; snails and ostriches to provide shells and plumes for fashion, and herbs to produce drugs. So people have become increasingly interested in harvesting more kinds of microbes, plants and animals for some human use or other.

The human species is also remarkable for its complex nervous system, with enormous numbers of nerve and sensory cells making highly specific interconnections and permitting exceedingly flexible patterns of behaviour. Beginning around 2 million years ago, our ancestors took advantage of this flexibility to master the use of tools and other technology, such as fire. This mastery over technology has permitted species of our genus *Homo*, first *H. erectus* followed by *H. sapiens*, to spread all over the Earth, colonizing not only all of the land surface, but more recently penetrating the ocean depths and outer space. The expansion of human use of the planet's environmental regimes has been accompanied by an explosion of objects fabricated by humans. The accumulation and expansion of knowledge and experience has given rise to a spectacular series of new technological devices, ranging from ploughs and pulleys to clocks, guns, steam engines, internal combustion engines, radios, television sets, computers, nuclear weapons and communications satellites. In fact it is possible to see interesting parallels in the history of evolution of life, and of objects fabricated by humans (Gadgil 1993). Like living organisms, fabricated objects have over time become more and more complex and occupied a greater and greater range of environmental regimes. Their use has permitted humans to modify the biosphere profoundly – mobilizing an estimated 40% of its

terrestrial biological production to their own ends (Vitousek *et al.* 1986). In the process, humans have significantly affected the magnitude and distribution of biological diversity on the surface of the Earth. The purpose of this chapter is to point to the major historical processes involved, although there is little detailed understanding of how these processes have affected levels of biodiversity.

An excellent framework for tracing this history is furnished by di Castri's (1989) interpretation of historical driving forces, following the work of Fernand Braudel (1979a, b, c). Braudel's school of history links and relates the patterns of daily life with long term historical trends, thus embracing different scales of space and time. Table 11.1-1 is a summary of the historical forces driving human impact on biodiversity, indicating when these forces began: most have continued to the present.

Boyden (1992) proposes four ecological phases of human existence in which societies are classified according to how humans relate to the biosphere and to other humans: the hunter-gatherer phase, the farming phase, the urban phase and the modern high-energy phase. The distinctions between the phases are not always sharp, some societies may not fit easily into one of these categories, and they are not evolutionarily linear as some of these phases may coexist in some societies. A simplistic manner of framing cultural diversity and its complex and divergent evolution does not exist, but these phases provide a useful framework within which to assess the history of human impact on biodiversity.

11.1.2 The hunter-gatherer phase

The hunter-gatherer phase represents the only known lifestyle and economy known for many thousands of human generations. Some groups, although diminishing, still belong to this phase. Hunter-gatherers are usually nomadic and fit ecologically into their habitat in much the same way as other omnivorous species. An important discovery which interrupted this presumed harmony and may have had major ecological impact on the local environment was the deliberate use of fire for driving game and clearing forest. This activity produced major modifications in vegetation patterns and fauna distribution in some regions. The invention and use of spears, bows and arrows, harpoons and nets also must have affected the interrelationships between human beings and populations of other animal species as, indeed, must have the development of language and its use for communicating observations about the environment. The effects of culture on humans themselves in the hunter-gatherer phase included impacts on techniques of food-gathering, and especially of hunting. Nevertheless, with the exception of the use of fire in some situations, it is difficult to determine accurately the impacts on biodiversity of these changes.

Table 11.1-1: Human forces driving changes in biological diversity (modified after di Castri 1989).**Before 1500**

1. Fire.
2. Hunting and gathering.
3. Domestication of plants and animals.
4. Intensification of agriculture.
5. Trade.
6. Intensification of agriculture by ploughing.
7. Offshore traffic and trade.
8. Building up of large empires (e.g. Persian, Roman, Mongol), with considerable expansion of communication and transportation systems.
9. Long-ranging wars and military expansion.
10. Large-scale invasions of people, long-distance shipping trade.
11. Establishment of 'market economies' (e.g. Venice).

1500 to 1800

12. Exploration, discovery and colonization by Europeans of other territories and continents (e.g. the 'Colombian exchange').
13. Establishment of new market economies and crossroad places (e.g. Amsterdam, London) favouring the globalization of trade exchange.
14. 'Revolution' in food customs (e.g. increased use of tea, coffee, chocolate, rice, sugar, potatoes, maize, beef and lamb).
15. Increased demand for products such as cotton, tobacco, wool, etc.
16. International introductions of exotic species through activities of acclimatization societies, botanical gardens and zoos, and for agricultural, forestry, fishery or ornamental purposes.
17. Large-scale emigrations.

Since 1800

18. Rapid improvement of transportation systems (roads, railways, navigation canals).
19. Large-scale industrial production and emergence of multinational companies.
20. Large engineering works for irrigation and hydropower.
21. High input, chemicalized agriculture.
22. Mechanized fisheries and forestry.
23. World wars and displacement of human populations.
24. Tropical deforestation and resettlement schemes.
25. Afforestation of arid lands with exotic species.
26. Increased urbanization and creation of habitats characterized by cosmopolitan species.
27. International interdependence of markets.
28. Release of genetically engineered organisms.

Mastery over tools and fire permitted hominids greatly to expand the range of plants and animals they could harvest and eat or put to a variety of other uses. It also facilitated their dispersal out of the original homeland of savannahs of East and South Africa. By one million years ago, *Homo erectus* populations had migrated out of Africa and reached the very different habitats of Europe, Java and China, undoubtedly learning to harvest a whole new range of biological resources. Fewer than 2000 individuals are

known of fossils that can be applied to the human family. With such a relatively spotty fossil record, considerable controversy surrounds their taxonomy – estimates of the number of species involved range from five up to 20 or so. At any rate, it is generally agreed among anthropologists that the first fully modern humans appeared about 90 000–100 000 years ago. They seem to have expanded rapidly over the Earth. By 50 000 years ago they had reached Australia, and undoubtedly covered most of

Eurasia as well (Cavalli-Sforza *et al.* 1993). They probably moved onto the North American continent across the Bering Straits at least 12 000 years before present (BP) and over the next several thousand years covered both North and South America. Last to be colonized by humans were the oceanic islands, Madagascar, Polynesia and New Zealand (Diamond 1991). The first humans to arrive on any land mass usually lived by hunting animals and gathering plants, though the first colonizers of New Zealand were gardeners, and of Antarctica members of industrial societies. The impacts of these first colonizers on the biodiversity of their new-found homes appear to have been quite negative, culminating in the extinction of a number of larger bird and mammalian species (Martin and Klein 1984).

On first colonizing a new locality, early humans were unlikely to have been in a position to estimate sustainable levels of harvests of any of the plants or animals that they used. Nor were humans likely to have been concerned initially with sustaining harvests since they were most likely part of a movement of people who were seeing the option of moving on to yet another area if the resource base became depleted (Gadgil 1987). Consider, for instance, the first colonizers of the Americas entering Alaska across the frozen Bering Straits. They would have run into a land without any human competitors, full of large mammals unaccustomed to being hunted by clever and well-organized bipeds with bows, arrows, spears and other hunting technology. Such prey populations are likely to have been hunted without any special restraint, leading to decline, and perhaps extinction in some cases (Ehrlich and Ehrlich 1981; Martin and Klein 1984). Subsequent colonizations by people with more advanced technology were also accompanied by further waves of over-exploitation. Thus European colonization of the Americas led to waves of overhunting or overfishing proceeding from east to west, on a continent that had already been subject to a wave of significant extinctions from the first invaders (Koppes 1988).

The impact on biodiversity of colonization by hunter-gatherers was especially negative on islands, specifically due to hunting of endemic species and, occasionally, by the introduction of alien species. In Madagascar, for instance, early colonization apparently led to the extinction of larger species of lemurs and of elephant birds, and in New Zealand to the extermination of flightless birds such as moas, a large duck, a giant coot and an enormous goose (Martin and Klein 1984; Diamond 1994).

It is widely accepted that early hunter-gatherers usually concentrated on species that yielded the most returns per unit of time or physical effort put in, or that involved minimal risk; modern hunter-gatherers do the same (e.g. Lee and Devore 1968; Coon 1971). Only when they could not fulfil their nutritional or other resource needs with the

most desirable of such species would they be expected to turn to others less desirable. Indeed, optimal foraging theory, the branch of ecological theory that addresses how animals garner resources, suggests that early hunter-gatherers would have arranged potential resource species in a sequence, implicitly grading them on the basis of returns per unit effort (or time, or risk), utilizing only as many at the top of the sequence as necessary to fulfil their total requirements (Smith 1983; Redford and Robinson 1987). Large flightless birds such as moas in New Zealand and large, easily-hunted mammals in continental areas are apt to have headed such a list, perhaps along with large fleshy fruits such as durian or jackfruit, while rats or grass seeds might lie lower down. In this way the hunter-gatherers would first harvest the most desirable items, shifting to less desirable ones only on exhaustion of the more desirable options.

Earlier sections have shown that populations of living organisms are renewable resources which can be harvested, within limits, without depleting them. It is then possible to use any plant or animal species sustainably without driving it to extinction. However, in Section 4 it was shown that populations of living organisms are components of complex biological communities, so that their population levels may change greatly not only in response to the harvesting of a particular species, but also in response to the dynamics of other prey, predator or parasitic species, their geographical distribution and abundance, as well as fluctuations in abiotic parameters of the environment, such as cyclones, long dry spells of weather or onset or withdrawal of ice ages. It is then impossible even for scientists to determine precise prescriptions of the levels of harvest of any biological population that would be fully sustainable (Ludwig *et al.* 1993). The early hunter-gatherers probably eventually arrived at workable solutions of how to sustain harvests only on the basis of long experience at exerting different levels of hunting and gathering effort and monitoring the resultant changes in the species population under harvest (Joshi and Gadgil 1991); they doubtless made many mistakes in the process.

While domestication of plants and animals has considerably reduced the significance of hunting-gathering for most modern societies (see below), forestry and fisheries are two sectors in which harvests of natural populations continue to play a major role in global trade. During the early centuries of global trade these resources were considered limitless. As suggested by optimal foraging theory, these were then exploited with harvesting effort concentrating on resources yielding the highest level of profit. As any such element neared exhaustion, exploitation concentrated on the next most profitable element. This process of sequential exploitation is evident in the search for wood for railway sleepers in ever more remote tracts of peninsular India, of mahoganies in West

Africa, or economic extinction of successive species of whales. As it became evident that these resources were not really limitless, a body of theory was developed on how to harvest them sustainably. Sustainable yield has, however, remained a myth given the very limited understanding of functioning of natural ecosystems and the lack of reliable data on the dynamics of natural populations (Ludwig *et al.* 1993). Thus even today there are two widely varying estimates of the number of minke whales: those who favour whaling estimate the target population at 80 000, while those who are opposed to it estimate it at 4000. Given these kinds of uncertainties it is evidently difficult to arrive at workable prescriptions for sustainable harvests. As commercial pressures are continually pushing for ever higher harvests it is no wonder that there are indeed continued trends of sequential exhaustion of forests and fisheries all over the Earth – whether it be Siberia and the Baltic Sea, or Brazil and the Pacific Ocean.

11.1.3 The farming phase

By about 15 000 to 10 000 years before present, *Homo sapiens* had colonized all the continents, other than Antarctica, and many islands as well. The last ice age had just withdrawn, bringing climate changes that induced shifts in vegetation zones, drastically changing levels of plant and animal populations on which humans depended. Thus, the withdrawal of glaciers resulted in a warmer, moister climate, leading to a switch from grasslands to forests and from dry to wet forests. This may have reduced the availability of large mammalian prey for humans, a species that is generally agreed to have originated on and was best adapted to the grasslands and savannahs, and may then have rendered the habitat less suitable for human occupation, resulting in a change in resource availability in many parts of the world, especially in the tropics and subtropics (Flannery 1973; Rindos 1984). It has been speculated that these changes may have prompted some people in southwestern Asia, southeastern Asia and middle America to bring plants and animals under domestication, where they were selectively bred to bring advantages to people. The domesticated forms were, in turn, fed by people and protected from other predators.

Another possible explanation is that farming began in a haphazard way at a time when the climate was especially favourable for hunting and gathering (Boyden 1992). An abundance of food may have permitted a more sedentary lifestyle and, under these circumstances, some may have experimented with propagating plants and improving the farming of animals. Initially, these domesticated sources of food would have formed only a small part of the diet.

The earliest evidence of agriculture based on the cultivation of seeds, notably wheat and barley, and the domestication of goats, sheep and cattle, is found in a broad

area known today as the Fertile Crescent, extending from Greece to a region about 2400 kilometres to the east and to the south of the Caspian Sea, as well as in the uplands flanking the valleys of the Tigris and Euphrates rivers (Baker 1970; Heiser 1973; Reed 1977). In southern Egypt people were collecting and grinding grain from barley nearly 18 000 years ago. Their tools included grinding stones, some mortars and pestles, and blades of sickles, presumably used for reaping barley and perhaps other grasses (Ucko *et al.* 1969; Boyden 1992). The first signs of seed agriculture with millet and pig-raising in northern China date from 7000–8000 BP. In the Americas, it seems likely that maize had been domesticated by 7000–8000 BP in the region of southern Mexico, Guatemala and Honduras. Squash, beans, avocados, gourds, pumpkins and chillies were also cultivated by 5000 BP. However, until about 5000 BP hunting and gathering remained the main source of food. In the coastal areas of Peru, squash, beans, chillies, peppers and cotton were grown by 7000 BP although fish was also an important source of nutrition in these parts. In the lowlands to the east of the Andes, manioc, sweet potato and arrowroot were farmed, and on the Andean plateaux the potato became established as the main crop around 3000 BP (Salaman 1949).

The development of domestication marked the beginning of an entirely new era in the interplay between human society and biological systems. As a consequence, human populations no longer fitted into their ecosystems in much the same way as other large omnivorous species. This transition to domestication has allowed humans deliberately and systematically to manipulate biological systems, landscapes and waterscapes for their own perceived advantage using a small sample of the world's biodiversity.

The domesticated species consist of a tiny subset of all known living organisms. A few thousand of the 250 000 described species of flowering plants are today under cultivation, while a few tens of the 4000 species of mammals, 9672 species of birds, 24 000 species of fish and 40 000 species of crustaceans, and about 20 out of 70 000 species of molluscs, five out of millions of species of insects and a few out of thousands of species of bacteria, are domesticated by humans (see Box 11.1-1). That is equivalent to about 1 in 10 000 living species. Moreover, this is a very biased sample, with most domesticated species coming from tropical and subtropical biomes, especially from the more disturbed, successional habitats. In addition, traditional and indigenous communities have domesticated many species that are not counted here (Frankel and Soulé 1981; Turner *et al.* 1990).

The change in subsistence behaviour also resulted in higher food yields from a given area of land than had been the case in hunter-gatherer systems. Thus, farming systems

Box 11.1-1: Domestication and the history of microbial diversity.

Humans have also unwittingly moulded the diversity of microbes which live as commensals or parasites of humans and their domesticated plants and livestock. In the Old World, when towns were first established 6000 years ago, these unprecedented concentrations of human hosts permitted the evolution of new strains of epidemic diseases such as smallpox and plague. Similarly corn, domesticated in Central America, first became the basis of intensive farming in the Illinois and Ohio river valleys around 1000 BP. Until then the human skeletons recovered by archaeological excavations showed few signs of disease. With the arrival of corn, the skeletons suddenly began to show many pathologies. The number of cavities in an average adult's mouth jumped from less than one to nearly seven; tuberculosis became established as an epidemic disease; half the population suffered from yaws or syphilis and two-thirds suffered from degenerative diseases of bones (Cohen and Armelagos 1984; Eaton *et al.* 1988). Conditions for the survival and evolution of such microbes have continually improved with increasing human densities and movements, but in recent times have deteriorated with advances in hygiene, immunization techniques and antibiotics. Part of microbial diversity has thereby been reduced (as with the elimination of smallpox) but the elimination of all of its laboratory cultures remains controversial. In general, the diversity of human pathogenic microbes appears unaffected by medical advances, with new organisms such as hypervariable strains of viruses like HIV continuing to appear on the scene.

could support much higher population densities of humans. Population densities of hunter-gatherer communities are estimated to have ranged from around 0.02 to 0.2 persons per square kilometre; in early farming societies they ranged from 25 to 1000 persons per km². It is even believed that a peasant farming system in southern China supported 7500 persons per km². It is worth noting, however, that generally the amount of food produced per hour of human effort in early farming societies was comparable to that of hunter-gatherers.

Farming techniques, such as hoeing, irrigation, and eventually ploughing and manuring, and the kinds of animals or plants that were used, varied around the world. All early farming activities consisted of redistributing plant and animal species in a given area by deliberately increasing the local concentrations of species of food value to humans and decreasing concentrations of species with

little or no food value. Furthermore, it is likely that shifting or slash-and-burn agriculture was initially used both for vegiculture and for seed culture. Shifting was unnecessary in the cultivation of wet rice and some other grain crops because a fresh supply of plant nutrients was provided each season through irrigation. Between 5000 and 4000 BP, the plough came into use in northern Europe and by the time of the Roman Empire, some regions practised alternating fields between spring- or winter-grown grain and fallow (the two-field system). After this time and until well into the nineteenth century, the fundamental characteristics of the farming of cereal crops remained basically unchanged. With regard to other kinds of crops, the most important developments in European farming before the nineteenth century were the introduction of maize (or 'corn') around 500 BP and of the potato about 420 BP.

Domestication also implies the 'creation' of new varieties and races. But as people began domesticating plants, more animals were also brought under domestication. Only a handful of species has dominated farming, especially in Western societies: three medium-sized herbivores (sheep, goat and pig), four larger herbivores (cattle, buffalo, horse and camel), two carnivores (cat and dog) and only two bird species (chicken and duck) (Clutton-Brock 1981). These animals are maintained under two rather distinct systems: larger numbers associated with nomadic herding, or, in modern times, ranching; and smaller numbers associated with settled villages and cultivation (Grigg 1974).

A very different form of farming is *pastoralism* where nomadic people move with their flocks or herds of domestic ruminants over great distances. This is especially characteristic of arid and semi-arid areas. Nomadic herders, primarily dependent on cattle, horses, sheep and camels have ranged for millennia over large parts of Eurasia and Africa, moulding its biodiversity (the Native Americans of the Great Plains had a comparable relationship with a large wild herbivore, the bison, and migrated with the herds). From 8000 BP until five to six centuries ago, these formed largely autonomous warlike societies that kept agriculture out of the drier tracts of Eurasia. Consequently, the whole tract very likely remained under relatively light levels of grazing, with particular clans guarding their own pastures. They undoubtedly hunted extensively, but most probably had little adverse impact on the region's biodiversity. Rather, their major role, played so famously by Genghis Khan's golden hordes, was to promote systems of rapid transport over huge distances and create great trade routes such as the silk route between China and Arabia, thereby incidentally encouraging biological invasions.

In many parts of the world, commercial livestock production has taken the form of ranching, a system of agricultural production that originated in the second half of the nineteenth century. Beginning in the 1830s, ranching for sheep and cattle was established in Australia, on lands

until then used lightly by Australian aborigines for hunting and gathering. Since then, half the country has come to be grazed by domestic livestock (Holmes 1976). This expansion has caused ringbarking of trees and elimination of tree cover in New South Wales, Victoria and South Australia. In the drier tracts it has led to conversion of salt bush to grassland. In the process, a small proportion (less than 0.2%) of the plant species seem to have gone extinct (Wilson 1990). However, the process has caused an overall reduction in plant and bird diversity and lowering of population sizes of medium-sized marsupials (Friedel *et al.* 1990). Similar impacts have been felt in North America beginning around 1850 and in South America beginning around the turn of the century.

Humans have endeavoured, rather successfully, to acquire their growing biomass needs from intensifying the productivity of a small number of domesticated species. Populations of the favoured species have then reached high densities in limited areas manipulated as farmlands, pastures, fish ponds or plantations. Substantial quantities of biomass are exported from these limited areas, involving removal of large quantities of minerals from soil or waters. To sustain productivity, these minerals must be replenished, through a long fallow period when only a small proportion of land and waters are under intensive use, or through addition of manure or fertilizers. Fallowing was the technique originally followed in most places, and it remains a component of the shifting cultivation systems in many parts of Asia, Africa and Latin America today (Grigg 1974). Such a system of cultivating a plot of land for a few years and leaving it under fallow for a much longer period creates a mosaic of vegetation under different successional stages. Furthermore, part of the land was often left out of cultivation. Thus in northeast Indian states such as Manipur, as much as 10 to 30% of the land was permanently maintained under natural climax vegetation in the form of sacred groves (Hemam pers. comm.). Historically, this would have ensured the persistence of almost all the natural elements of biodiversity, coupled with stimulation of overall productivity by favouring faster growing early successional species in the patchwork of successional stages covering 70% to 90% of the land. Selection for adaptation to highly heterogeneous local environments accompanied by genetic drift would also have promoted considerable genetic variation in the cultivated species (Frankel and Soulé 1981).

It is now recognized that shifting cultivation systems also actively encouraged diversity in other ways. Recent work in the Amazon Basin has concentrated on longer-term changes in the forest structure, and has discovered practices that result in the creation, for example, of forest islands, or *apete*, by the Kayapo Indians of Brazil who live at the southern limit of the rain forest (Posey 1985). *Apete* begin as small mounds of vegetation about 2 m in diameter

(*apete-nu*). As planted crop and tree seedlings grow and the planted area expands, the taller vegetation in the centre of the mound is cut to allow in light. A full-grown *apete* has an architecture that creates zones that vary in shade and moisture. The species mix includes medicinal species, palms, and vines that produce drinking water. Of a total of 120 species found in ten *apete*, Posey (1985) estimated that 75% may have been planted.

New *apete* fields peak in crop production in 2–3 years, but some species continue to be productive for a longer period: sweet potatoes for 4–5 years, yams and taro for 5–6 years, papaya and banana for 5 years or more. Contrary to common belief, old fields (*ape-ti*) are not abandoned when the primary crop species disappear; they keep producing a range of useful products. They become forest patches in the savannah-like open *cerrado*, managed for fruit and nut trees, and 'game farms' which attract wildlife. This behaviour promotes patchiness and heterogeneity in the landscape through a number of devices. Posey first became aware that these isolated forest patches were human-made in the seventh year of his field research (Taylor 1988), but the local people were of course well aware of the dynamics involved.

Working in the Ecuadorian portion of the Amazon forest, Irvine (1989) has reported that Runa Indian swiddens resemble agroforestry systems rather than the slash-and-burn that merely results in temporary clearings in the forest canopy. Compared with unmanaged fallows, he found that management actually increased species diversity in 5-year-old fallows. Between 14 and 35% of this enhanced species diversity was attributed to direct planting and production of secondary species. Irvine (1989) characterized Runa agroforestry as a low-intensity succession management system which alters forest composition and structure in the long term.

Among the most diverse of agricultural systems known are the 'home' gardens in the humid tropics, the result of long historical development of technology designed to meet the needs of local agricultural communities. In West Java, the typical home garden appears as a crowded assemblage of trees, shrubs, climbers, herbs and creeping plants that are used for fruit, vegetables, starchy food crops, spices, ornamentals, medicines, fodder, fuel and building material, and involve over a hundred species. Even in the more arid regions, such as the Gondar area of northwestern Ethiopia, farmers plant together six or more crops, including maize, faba bean, sweet sorghum, cabbage, tomato, potato, pumpkin and bottle gourd. In northern Ethiopia, especially in the drought-prone areas, wheat and barley are grown in specific mixtures. In favourable years both wheat and barley give good yields, but in poor years barley still gives some returns.

In Vietnam, multiple varieties of early-maturing rice, *Oryza sativa* var. *indica*, are cultivated with multiple varieties of other *indica* and *japonica* rice with up to 20

cultivars harvested from one field. In Sierra Leone, in 1983 as many as 59 distinct rice varieties were planted by 98 households of one community, each farm averaging 4–8 varieties. The Kantu of Kalimantan, Indonesia, planted at least 44 varieties in one area with an average of 17 per household. A gene pool of potatoes of some 3000 varieties representing eight species are traditionally under cultivation in the Andes. In Papua New Guinea, as many as 5000 varieties of sweet potato are under cultivation, with as many as 20 varieties being planted in a single garden (Wood and Linne 1993).

This maintenance of considerable diversity of landraces in traditional farming is based on a great deal of deliberate effort since old varieties are continually lost due to outcrossing with other varieties or wild or weedy relatives of cultivated plants, and by a variety of chance events. So farmers historically have tended continually to acquire new varieties by exchange, through new encounters while travelling, through natural hybridization and from the markets. In Sierra Leone, new rice varieties are mostly borrowed from friends, while in Indonesia they are acquired as gifts as a new household emerges from an old one. In the Andes, some towns have a special reputation for the production of new varieties of potatoes from seed derived from outcrossing between cultivated species. The Aguaruna Jívaro from the Amazon Basin of Peru obtain new varieties of cassava through nurturing of volunteer cassava seedlings derived from accidental seeding. They also regularly exchange cassava varieties within the community as well as over long distances. Such patterns appear to be as old as agriculture and help explain the great biological diversity of traditional agricultural systems.

It is then entirely plausible that biological diversity was higher in earlier times, when large numbers of farmers of many different cultures had long-term stakes in the land they farmed and had control over their own technology. These historical systems of land management were highly variable, following a range of different rules to take into account specific attributes of the physical systems within which they were found, cultural views of the world, and the economic and political relationships that existed in the setting. Despite their great diversity, such systems often had characteristics such as clearly defined boundaries, specific rules on the harvesting of different products, involvement of the affected people in these collective choices, a system of monitoring the use of resources, cultural sanctions for those who violated the operational rules, inexpensive local mechanisms for resolving conflict, and ways of organizing these activities so that different types of decisions were taken at different levels. For example, Teran and Rasmussen (1995) found that pre-Colombian Maya agriculture was characterized by a high diversity of genetic resources and a similarly high diversity of agricultural and non-agricultural activities. In pre-

Colombian times all land was dedicated to mixed farming: land was communal, settlement was disbursed, and the system was supported by the ruling class. These factors resulted in higher productivity than is found today, where these conditions are absent. In addition, large tracts of the tremendously species-rich Amazonian forests that were viewed as virgin ecosystems until recently are now known to have been shaped by shifting cultivation systems of relatively dense populations of Amerindians. In fact, Denevan (1992) estimates that lowland South America supported over 8.6 million people prior to the European conquest – populations of both shifting cultivators and more permanent farmers that were greatly reduced by epidemic diseases brought in from Europe.

However, the highly diverse early farming systems generated very little surplus of production above and beyond the needs of the cultivators themselves; therefore they could only sustain autonomous, small-scale societies. The more complex agrarian and industrial societies that followed were based on large-scale resource exports from the countryside to the cities. Since shifting cultivation cannot provide such exports, more advanced agrarian, pastoral or industrial societies tended to generate them by conversion of the forest vegetation while restricting shifting cultivation to more and more circumscribed areas, usually in the uplands. Intervention of technologically simple societies by more advanced societies has also promoted growth in numbers of shifting cultivators. All of this has intensified shifting cultivation, shortened the fallow period, and often destroyed the sacred groves. Under these pressures tracts under shifting cultivation are today becoming progressively impoverished of biodiversity all over the world (Ramakrishnan 1992).

Erosion and chemicalization have been other causes of degradation in food-producing ecosystems. Although erosion is a natural phenomenon, overgrazing, unwise farming practices and the excessive use of wood have sometimes greatly increased the rate of erosion, especially in more ecologically vulnerable areas. As a result, fertile soil that has accumulated over thousands of years has been lost within a few years. Chemicalization occurs when there is an accumulation of unnatural concentrations of certain chemical compounds, which then interferes with plant growth. Boyden (1992) cites a historical example in which it is believed that excessive sodium chloride left in the soil following water evaporation was one of the main factors that caused the failure of the Mesopotamian agricultural system in the Euphrates and Tigris valleys, upon which the early Sumerian and Akkadian cities depended.

Apart from affecting the size of human populations and the lifestyles of individuals, one of the most obvious impacts of farming on biodiversity has been its influence on the redistribution of different kinds of plants, microbes and animals. For example, in Europe, the trees of the great

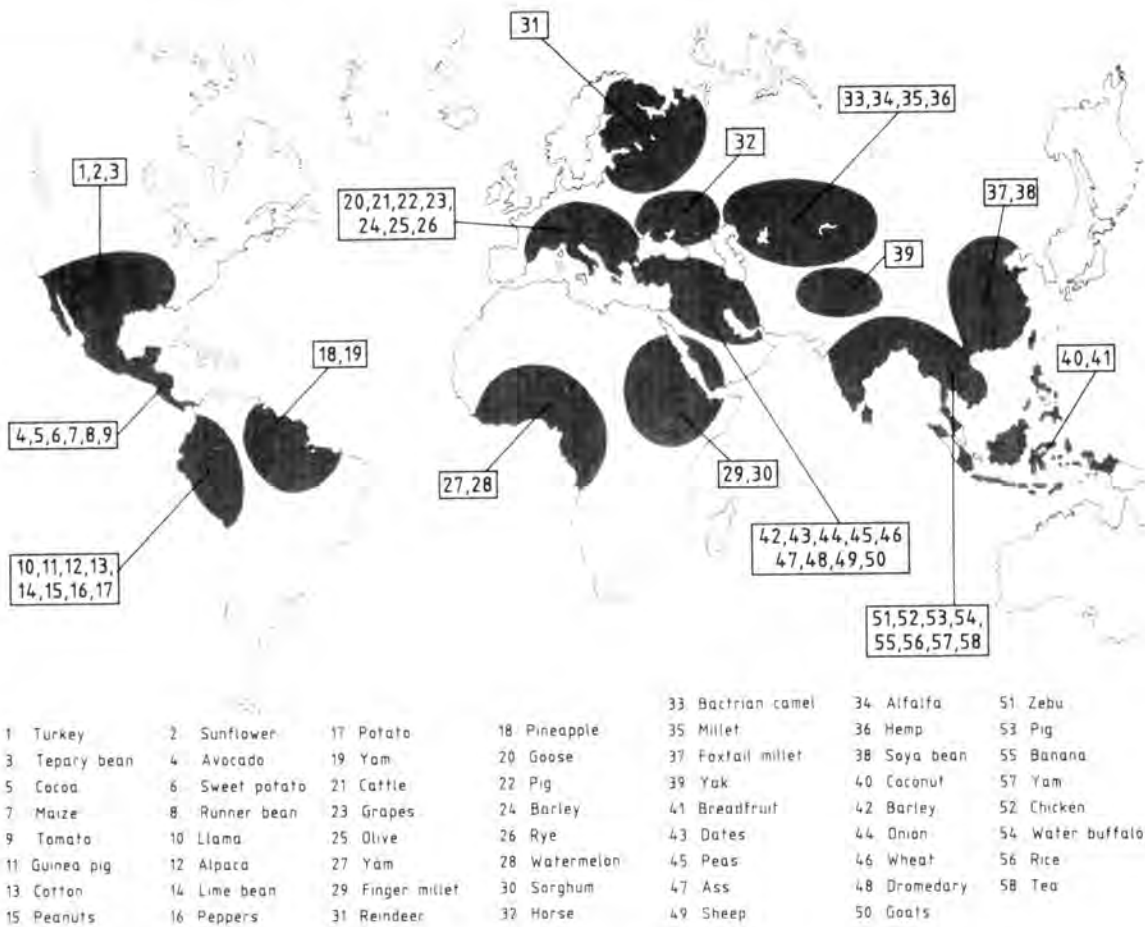

Figure 11.1-1: Regions of origin of domesticated plants and animals (from Boyden 1992).

forests that had covered much of the continent were displaced by Danubian farmers around 7000 BP. Until relatively recently many plant species used in farming systems, which had been domesticated at least 4000 years ago, were confined to their sources of origin (see Figure 11.1-1). In this context, the colonization of America by Europeans was especially important since not only were maize, potato, squash, gourds, pumpkins, peppers, chillies and the turkey introduced into Europe, but European cereal and vegetable crops, cattle, sheep and pigs were also introduced into the American continent. Eventually all the main European food sources were introduced to New Zealand and Australia. Just as new plants and animals were introduced into farming ecosystems, so were local native ones displaced.

The requirement of land for food production was not the only cause of deforestation. Eventually, the demands for timber for use as fuel and for various other purposes became increasingly important motives for felling trees. For example, although dense forest covered most of central and western Europe during Roman times, a significant increase in human population in the region is speculated to have caused 'the great age of land clearance' in the early

part of the second millennium. Paradoxically, it has been suggested that deforestation was also an important contributing factor in the decline of the Roman and Greek civilizations (Boyden 1992).

In another region, the Indian epic Mahabharata, probably based on events that took place at the junction of the Indus and Gangetic plains 3000 years ago, narrates the story of the destruction of the great Khandava forest on the banks of the river Yamuna near Delhi. Krishna and Arjuna, the two great warrior heroes of the pastorals, supposedly burned the entire forest driving back into the fire any creature attempting to flee the conflagration. Historical evidence suggests that the destruction of the Gangetic plains forest continued over the next five centuries and was nearly completed by the time of Buddha, 2500 years ago (Gadgil and Guha 1992).

Pastoralism has also led to significant changes in vegetation. The most significant of the domesticated animals (sheep, cattle, buffalo, horse and camel) feed primarily on grass and their maintenance has catalysed the conversion of much natural vegetation into grasslands all over the world (Stewart 1956). Fire has enhanced this conversion, and has promoted the spread of a small number

of grasses and other herbaceous species that thrive under fire. For example, the original vegetation of the Scottish Highlands was a forest cover of oak, pine, hazel, birch, alder and willows. This began to be destroyed during the Viking raids a thousand years ago, but was further reduced by exploitation for timber and smelting in the eighteenth and nineteenth centuries, and was nearly entirely eliminated to create pasturage for sheep. Initially this sheep-raising was immensely profitable, but over the past several decades it has been maintained only through government subsidies (Darling 1956). Similarly, most of the grasslands of India, dominated by a small number of grass species such as *Heteropogon contortus* and a few exotic weeds like *Parthenium*, have been created from much more species-rich tropical deciduous forests (Gadgil and Meher-Homji 1985). Large tracts of Central and South America have been converted to grass to graze beef cattle (Caufield 1984), and native American prairies have been largely eliminated by invading European species, even as the great herds of American buffalo have given way to European cattle (Crosby 1986).

The early farming phase covers the first known agricultural and horticultural systems to the high-energy phase of human societies where more recent developments have led to significant ecological changes in farming practices. From the first establishment of cities, the early farming phase has coexisted alongside the early urban phase.

11.1.4 The urban phase

The early urban phase includes all human populations living in cities from about two hundred generations ago, when some humans first began to live in cities, through to six or seven generations ago when the Industrial Revolution was under way in western Europe. These populations depended almost entirely on early farming communities for sustenance. Associated with this phase were important societal developments, including expanding growth in trade of manufactured goods and raw materials, increasing human migration and population, greater specialization and hierarchical stratification within societies, and the institutionalization of warfare.

Boulding (1973) has suggested that the two most significant phenomena of human history have been the tendency of our species to expand into an existing niche and our tendency to expand the niche itself once an old niche has become tight. Cowgill (1975), on the other hand, argues that population growth is not an inherent tendency of humans, but rather a possibility that is encouraged in some situations and discouraged in others. In his view, development followed perception and creation of new opportunities and new possibilities, probably more often by specific social segments or categories than by societies as a whole.

Over millennia people have continually broadened the

variety and quantity of plants, animals and minerals being treated as resources for human use. The distribution of these resources tends to be patchy, and people soon learned that trade could help them improve their way of life. These exchanges are ancient: archaeological evidence points to movements over long distances of stone tools fabricated in sites with especially suitable stone outcrops. New Guinea tribals too have for centuries exchanged shells from the sea coast for birds-of-paradise feathers from the interior (Rappaport 1984). Trade became especially important in agrarian societies with elites demanding goods, some of them valued simply because they came from a long distance away. Their possession was therefore a matter of prestige. Thus Indian ivory and peacock feathers were in great demand by the Roman nobility and rhinoceros horns were prized in the Chinese court, while Arabian horses were sought by Indian princes. Trade then became a very significant activity in the early urban societies, an activity that has had a growing impact on the Earth's biodiversity since it enabled even the most isolated groups to earn more benefits from biodiversity.

During the initial period of global trade there was little concern with conservation of biological resources, or of their diversity. Consequently, the newly-developed understanding of biological diversity was used for short-term economic utilization. A major component in this agenda was the screening of this diversity for its economic utility and the transfer of economically useful elements to other suitable regions on the earth. The botanic gardens, founded from the sixteenth century onwards in Europe, and more important the tropical botanic gardens established in the eighteenth and nineteenth centuries, played a key role in this process. Thus the botanic garden at Bogor, Indonesia, founded in 1819, was responsible for the introduction of the oil palm (*Elaeis guineensis*) in 1848; and those of Calcutta, India founded in 1787, and Peradeniya founded in 1821 and Gampaha 1876, both in Sri Lanka, played a significant role in the development of rubber plantations of Southeast Asia (indeed the latter garden was created especially to receive and grow rubber plant seedlings) (Heywood 1987). In such a fashion cocoa was transferred from South America to West Africa, potatoes from the Andes to Europe, nutmeg from the Moluccas to Grenada and coffee from Africa to Brazil and Colombia. The emphasis was on the creation of monocultures for intensive production of a small number of commercially valuable biological products. The inevitable result was large-scale local erosion of biological diversity (Grigg 1974).

The movement of people, often over very long distances, has also been significant in human and ecological history. Some of these migrations have been voluntary and peaceful; others have been violent and forced by dominant human groupings. The movements of Asians into the

Americas, Madagascar and the Pacific were discussed above. A more recent great and demographically significant movement consisted of the spread and expansion of Europeans to all corners of the globe. This began with the exploits of the navigational adventurers from Portugal, Spain, Britain, France and Holland in the late fifteenth and early sixteenth centuries and, in particular, with the European discovery of the American continent and, two centuries later, of Australia and New Zealand. Europeans began to settle in North America in the sixteenth century and in South America early in the seventeenth century. In Australia and New Zealand European settlement began in 1788 and 1790 respectively. In southern Africa the Dutch started to settle in 1632, and the English in 1788 (Crosby 1986).

In North America and Australia, Europeans largely displaced the local native populations. Their biological advantage was partly due to their technology and weaponry, but it was also the consequence of the fact that they introduced into the local populations a series of devastating infectious diseases – diseases to which they themselves were, for historical reasons, relatively resistant. In Mexico, for instance, smallpox wiped out at least half the local population in the first few years after initial European contact.

Associated with the voluntary migration of Europeans to the Americas was the involuntary migration of Africans to the same region as slaves. It has been estimated that between 1451 and 1870 about 11 million slaves were taken from Africa, of which 9.6 million were still alive when they reached the American coast. In 1850 about 11% of the population of the USA was of African origin.

Between 1850 and 1960 – the great period of voluntary European migration – 60 million people left the continent to settle in faraway lands. This figure represents about a fifth of the population of Europe at the beginning of this period.

Largely as a consequence of these developments, the Caucasian population of the world increased 5.4 times between the years 1750 and 1930, while in the same period the Asian population increased 2.3 times and the African population less than twice. By 1930 the proportion of Caucasians who did not live in Europe was one-third; and in 1970 it was more than half. At present more than one-fifth of Africans live outside Africa.

Migrations have always resulted in a redistribution and mixing of both genetic and cultural traits, including an exchange of technologies for resource use, and these have had a variety of different impacts on biodiversity.

Migration and trade calls for means of transport. Historically, transport was by ships on sea and trains of camels, horses, bullocks and humans on land. Transport over water is the least expensive, and ships have been the dominant means of transport for millennia. By 6000 BP it

was important in the Mediterranean and it has been speculated that the early city-builders of Mesopotamia, the Sumerians, had migrated to the region by sea between 5500 and 5000 BP.

For most of human history, boats and ships have been constructed of wood, and wood for shipbuilding was a major demand on forest resources, especially in medieval Europe (Thirgood 1981). Oak was the favoured raw material, and this demand caused extensive denudation of the oak forests of Europe. Extensive deforestation began around 1100 and continued until the fourteenth century, when it declined after the spread of the bubonic plague. Deforestation began again around 1500 and almost all the oak forest of Britain had disappeared by the sixteenth century. British interest in India's teak forests, to secure an alternative supply of timber for their merchant ships and navy, was a major motivation behind imperial ambitions. The teak plantations raised after the conquest of India were a significant cause of erosion of biodiversity over large forested tracts of peninsular India. So too was the demand for railway sleepers for the extensive network of railway lines built to facilitate transport of raw materials such as tea, jute, indigo and cotton out of India in exchange for manufactured goods from Britain, which were desired by Indian consumers (Rawat 1991).

Large-scale movements of material and people have also led to deliberate as well as accidental movements of living organisms. Such movements, for instance, led to the spread of tropical rat species as human commensals with the crusaders going back to Europe, and later to the outbreak of plague (Zinsser 1934). During their colonization of the world Europeans carried with them not only wheat, cattle and goats, but also many other European species which eliminated native biota over continental areas, such as American prairies, and on islands such as New Zealand (Crosby 1986). More recent times have witnessed the invasion of American weedy plants such as *Parthenium* and *Eupatorium*, all over the tropical world, leading to erosion of diversity of the native biota (di Castri *et al.* 1989; see 11.2.2.4 for a further discussion of the impact of introduced species).

Although the earliest settled communities most probably defended themselves against other human groups, the establishment of settled societies undoubtedly increased the reasons and potential for warfare by instituting clear ownership of resources and defined territories. The continually growing human demands for a variety of natural resources inevitably led to conflicts over access, and being a highly social species, humans have sometimes turned such conflicts into warfare. Other conflicts have arisen from attempts to keep aliens out of circumscribed group territory. Areas close to the boundaries of two contiguous group territories can be especially dangerous; these have often served as refugia for natural diversity in

tribal societies (Hickerson 1965). For example, *Arthashastra*, the Indian manual of statecraft composed some 2000 years ago, prescribed strict protection to wild elephant populations in forests at the boundaries of kingdoms (Kangle 1969).

Such conflicts can have a variety of effects on biodiversity. When a New Guinea highland tribe defeats another in a war, it does not immediately take over the territory of the vanquished. Instead, the winners cut down the fruit trees raised by them, perhaps to reduce the chances of the defeated people attempting to reclaim their territory (Rappaport 1984). As conflicts have intensified with the march of civilization, they have called for large investments in both defence and offence, putting greater demands on the natural world. Apart from these indirect demands, conflicts have directly inflicted much damage, for instance in the pursuit of the scorched-earth policy by warring armies. Defoliation in Vietnam, damage to marine life in the Kuwait war, and destruction of agricultural land in the Horn of Africa are recent examples of the impact of international conflicts on nature. Internal insurgencies also affect biodiversity, in part positively by reducing the pressures of commercial exploitation, in part negatively by allowing unregulated hunting.

This phase of human existence provides the first examples of intensive human alteration of and major destructive impact on the environment. It also provides the first examples of how environmental degradation became a main contributing factor to the collapse of vast societies.

11.1.5 The modern high-energy phase

The steadily expanding global trade in biological resources under increasingly centralized control of nation states and business corporations has been accompanied by an industrial revolution brought about by a series of technological advances. These advances have deployed large amounts of energy towards production, processing, transport and distribution of increasing quantities of goods. Until a few centuries ago, humans for the most part depended on their own muscle power, and that of their domesticated livestock, for production. Thus horses and oxen ploughed the land and pulled the carts, and artisans depended on their own muscle power to weave the cloth, forge swords and ploughshares and build houses and bridges. Wood fuel fired kitchen hearths and metal foundries, and wind power moved ships over oceans, but these energy sources could only be used at very moderate levels of efficiency.

Enormous supplemental sources of energy came about with the development of the steam engine, the internal combustion engine, electricity turbine, nuclear fission and solar cells. An associated development is the ability to synthesize a variety of chemical molecules serving a wide range of functions (i.e. building materials, fertilizers,

pesticides, synthetic drugs and plastics). All of this is contributing to even more profound changes in global biodiversity.

This modern high-energy phase is the dominant ecological and economical phase in the modern world today. It is characterized by very high and increasing rates of use of material resources and of energy (mainly in the form of fossil fuels) which is used for driving various kinds of machines. The basic ecological characteristics of farming remained unchanged until the nineteenth and twentieth centuries, but the industrial transition unleashed a new era in farming, with fundamental changes in agricultural practice. First, the use of machines powered by fossil fuels began to perform work previously done by humans or draft animals (e.g. ploughing, sowing and harvesting). Second, application of artificial fertilizers (mainly nitrogenous, phosphate and potash fertilizers) has progressively increased. And third, the genetic variability of cultivated plants has gradually declined.

Historically, as agriculture intensifies there is a tendency to emphasize a smaller number of crops (Boserup 1965). Thus in Asia the less intensive systems of cultivation involve several species and landraces of millets, amaranths and beans along with hill rice. With the introduction of wet paddies this gives way to stands of a few high-yielding varieties of rice and blackgram (*Phaseolus mungo*). This is because the technologies of more intensive crop production based on creation of relatively homogeneous environments tend to diffuse over wide areas.

Modern systems of agricultural production create extensive stands of single crops of low genetic diversity in the fields, while maintaining large amounts of genetic diversity so essential for continued success of plant breeding in *ex situ* storage. The modern farm production systems focusing on maximizing profits do so by wiping out environmental heterogeneity and by bringing in irrigation water and more recently chemical fertilizers, herbicides and pesticides. In these highly modified environments production tends to concentrate on genetically homogeneous stocks of a small number of species that may be grown most profitably in any given locality. These processes have led to a gradual loss of variety and genetic heterogeneity of cultivated plants being grown in any given locality, a process that is continually gathering pace.

The widespread use of synthetic pesticides to control parasites and diseases, and the cultivation of new high-yielding varieties of certain crops, are other changes that have resulted in considerable increases in yield per unit area, at the cost of losses in biodiversity.

The great increase in yield per hour of human labour is perhaps a more striking change. In the hunter-gatherer and farming phases, typically enough food was harvested to support each family. In the high-energy phase the situation

is very different. For example, in the 1970s, one farm worker would produce sufficient food for 50 people, and currently in Australia, one farmer produces enough for 85 people (two-thirds of whom live outside Australia).

Intensification of agriculture and livestock production has permitted the gradual differentiation of human populations into those directly dependent on biological resources produced with their own labour, and those dependent on the surplus production of the countryside. In the modern high-energy phase of society, the great majority of human beings do not participate in direct subsistence activity and so are far removed from the realities and consequences of food acquisition and production.

Dasmann (1988) distinguishes these two categories of people as 'ecosystem people' and 'biosphere people'. Ecosystem people are the farmers, herders, fishers and hunters who depend largely on natural resources gathered or produced from their own immediate surroundings: they experience at first hand the consequences of their patterns of resource use. Biosphere people are dependent on much larger systems, and typically are well insulated from the environmental consequences of their use of resources. If their consumption leads to over-exploitation, they can easily move on to other systems through the market-place. Early 'biosphere people' included the warriors, priests, bureaucrats, merchants, and artisans of the agrarian societies, while later biosphere people include those engaged in organized services and industries in modern societies who have access to the resources of the entire biosphere through global markets.

As agriculture and livestock production have become a part of modern industrial enterprise, farmers too are moving into the category of biosphere people. But over much of the historical period farmers have been ecosystem people, and to a large extent they remain so in parts of the developing world. The division into ecosystem and biosphere people is a great simplification, and different groups can be located at different places along a continuum of dependence on locally available resources. However, Dasmann's classification is a useful conceptual tool for understanding different relationships between people and biodiversity.

Subsistence farmers largely producing for domestic consumption or local level exchange – behaving as ecosystem people – have been motivated to cultivate a variety of plant species to fulfil their own manifold demands for food, fibre, fuel and medicine. They have also attempted to minimize the risks of large losses of plant production due to unfavourable weather events or outbreaks of pests. They would therefore tend to nurture a diversity of species, as well as a variety of landraces of many of these species. As farmers became linked to outside markets, they no longer had to produce locally a whole range of food, fibre and medicinal plants; indeed markets

could bring to them a much greater diversity of plant products from many different regions than could be produced locally. But farmers also required cash to buy these products from the markets, and hence their interest gradually shifted to managing on-farm production to maximize its market value, rather than generating a variety of products for local consumption, or to ensure buffering against risks.

The new methods are extraordinarily dependent on continual external inputs – especially energy-costly artificial fertilizers and pesticides, and considerable input of energy.

The development of the steam engine ushered in a new kind of technology of overwhelming ecological significance, powered by the combustion of fossil fuels. Another set of scientific advances relating to the use of energy that has had an enormous influence on human affairs involved the discovery of electricity and electromagnetic phenomena.

Fossil fuel driven generators are the largest source of electricity, with a usual energy efficiency of about 30%. Hydroelectric plants contribute to around 6% of the world's overall electricity budget. Over 350 000 PJ of extrasomatic energy per year is currently being used by humankind, which is a 10 000-fold increase in the past 400 generations. For example, the average North American uses 100 times more extrasomatic energy than the average hunter-gatherer.

Ecologically important distinctions exist between the direct or indirect forms of non-fossil fuel derived energy (solar power, hydroelectric power and wind power) and fossil fuels and nuclear power. No incidental chemical by-products are released into the environment in the case of the former. Fossil fuels result in the liberation of carbon dioxide, carbon monoxide, hydrocarbons, and sulphur and nitrogen oxides; and nuclear power produces highly radioactive substances. Furthermore, the use of solar power does not release additional heat to the environment beyond that which would in any case be given off as a consequence of the solar radiation of the Earth.

Recent decades have also seen the growth of the production of synthetic materials used for a wide range of purposes, including the manufacture of clothing, utensils and countless other commodities. This industry dates back to the middle of the last century, when a hard flexible transparent substance known as celluloid was made by mixing nitrocellulose and camphor. The environmental impacts of plastics are under considerable criticism. On the one hand, it is argued that they are 'biosphere friendly', because it takes less energy to produce a plastic product than a comparable one made from glass or aluminium. On the negative side, the lack of degradability of plastics represents hazards for sea birds, marine mammals and other creatures. In some cases the processing and manufacture of plastics also results in the release of toxic chemicals.

For humankind the possibility of resource scarcity is far less dangerous than that of 'choking in its own wastes', or severely damaging the productive processes of the biosphere. Broadly speaking, two kinds of waste are produced by high-energy societies. First are what can be called the biometabolism products of society which are the organic waste products (i.e. sewage, unused food and organic fibre). Usually little of this type of waste is returned to the soil so natural nutrient cycles are disrupted. The second type of waste consists of those waste products resulting from the technometabolic aspects of society, including industrial activities, such as plastic production, the use of machines, and the by-products of extrasomatic energy use. As discussed previously in this volume, human activities are also resulting in the discharge into the atmosphere of gases that contribute to global warming. The chlorofluorocarbons (CFCs), the synthetic products of our industrial society which are responsible for the thinning of the ozone layer are, volume for volume, many thousands of times more potent as greenhouse gases than carbon dioxide.

Needless to say, the control and use of material resources, and the material benefits derived from them, are far from evenly distributed within the populations of most high-energy societies. The disparities that exist in the intensities of resource use between populations in the developed and developing regions of the world are even more striking. The industrially developed world, which contains about one-fifth of the total human population, uses 90% of the non-renewable resources produced, meaning that on a per capita basis the populations in these countries are using about twenty times more non-renewable resources than populations in the developing countries. For example, the United States, which has 5% of the world's population, uses 27% of the materials extracted. Per capita, this is 36 times more than in the developing world. It is not easy to provide an accurate picture of the changing rates of use of different mineral resources either by humankind as a whole or by separate societies. However, it stands to reason that increasing industrial productivity involves increasing use of resources. The impact of this on biodiversity is unclear, but it seems inevitable that expanding human consumption of resources that means fewer resources will be available for other species.

In addition, in this phase, urbanization processes have increased, with a higher degree of artificialization. Simple shelters that once involved wooden poles and hides, or just shallow caves, have developed into enormous human-made caves of brick and mortar, concrete and steel. Simple beaten footpaths have been converted into kilometre after kilometre of paved and tarred roads. Such habitats especially favour a few commensals of humans; rock doves and swifts fond of rocky crags are at home in a forest of human-made crags as are black rats and house mice in human-made burrows. Cities have their own biodiversity-

rich areas in gardens and parks where high levels of diversity may be created by artificially collecting species from around the Earth, often in environments specially created to suit them (Section 13.3.8.1).

Apart from directly moulding large areas, urban concentrations, highways and railroads affect natural diversity through making ever-growing demands on resources of far-flung areas. Pink granite is mined in south India, destroying extensive dry deciduous forests on its hill tracts, to make tiles for the bathrooms of the urban middle class and facings for buildings in western Europe. The fuelwood demand for baking bricks to support the unceasing expansion of Calcutta is leading to the slow demise of the world's largest mangrove forest in Sundarbans.

Urban metropolises may appear to be burgeoning, crowded, overstressed habitats with little room for nature. But hidden within the concrete maze, a surprising amount of wildlife still survives (Section 13.3.8.1) A small lake in the centre of Hanoi in Vietnam harbours the only surviving population of the giant freshwater turtle (*Pelochelys bibronii*) (Quy 1995). Another outstanding example of such survival is the Delhi Ridge Forest which runs through the capital city, and is covered by dense dry deciduous forest and thorn scrub. This 7770 hectare sliver of vegetation harbours a large amount of biodiversity, including nearly 200 species of birds.

11.1.6 History of conservation traditions

The consequences of advances in human technology through the ages, for the life experience of humans and for the relationships between human society and the biosphere, have been multiple and wide-ranging.

The preceding discussion supports the conclusion that the Earth has witnessed an ever-accelerating erosion of biological diversity over the past 10 000 years as numbers of people and their abilities to affect the natural world have grown steadily. But people can and do modify their behaviour on the basis of their perceptions of the long-range consequences of their actions. At many different times and in many different cultures, people have apparently been motivated to conserve, even enhance, biological diversity and have evolved a variety of cultural practices that seem to contribute to this end. But establishing a connection between specific practices and conservation or enhancement of biological diversity is by no means a simple matter; for the overtly declared purpose of a practice which seems to help conserve biological diversity may in fact be quite different. Thus, in South Asia many sacred ponds have helped conserve the indigenous fish fauna. But people leave these ponds alone out of respect for some deities, not with an expressly declared purpose of conserving fish diversity. It is then quite possible that many practices that seem to promote conservation may have originated from different

motivations, while others declared as promoting conservation may in reality achieve something very different. Accepting that this may be so, it is still of considerable interest to review the variety of cultural practices that (a) apparently serve to conserve or enhance biological diversity – whether or not that is their declared purpose, and (b) expressly purport to conserve or enhance biological diversity – whether or not that is the actual result or the genuine underlying motivation.

Historically, people colonizing new environments or undergoing rapid economic development have not been concerned, at least in the initial phases, with conservation of biodiversity. But once an area is settled or developed, humans begin to accumulate experience of the impact of their resource management practices. They are able to see the resource depletions that follow non-sustainable harvesting pressures, and the recoveries that sometimes follow when, for some reason, harvesting pressures are reduced. Furthermore, when living in a given locality generation after generation, they might perceive self-interest in moderating harvesting efforts so that harvests are improved in the long term. This would be particularly so if they depend largely on harvests from a circumscribed area, and are using technologies that are not continually leading to higher and higher levels of harvesting efficiencies. Many small-scale, autonomous hunter-gatherer or agrarian societies have settled in regions where they control well-defined territories from which most resources garnered were likely to fulfil these conditions. Such people may then have had the knowledge base, the motivation, and the capability of moderating resource harvests so as to serve long-term, group interests in sustainable use and conservation of natural diversity (Gadgil and Berkes 1991).

A variety of such practices of moderating harvesting efforts are known historically from various parts of the world. Refugia immune from harvests may take the form of sacred groves, or ponds, or pools along river courses, or lagoons of coral islands where entire living communities are protected from human interference. Sacred groves may conserve species that have disappeared elsewhere; for example, the Botanical Survey of India discovered a new species of leguminous climber, *Kunstleria keralensis*, in a sacred grove on the densely populated coast of the state of Kerala. In Pakistan representatives of original tree species still persist in old Moslem graveyards, because of a taboo against cutting these trees. Khan (1994) used these tree stands to reconstruct the past distribution of the thorn forest in Punjab. In China, royal gardens, royal cemeteries, ancestor temples and Buddhist temples have long maintained examples of natural vegetation in excellent condition, although many of these are now disturbed. And the only surviving population of a freshwater turtle, *Trionyx nigricans*, survives in a sacred pond dedicated to a Moslem saint in Bangladesh (Gadgil *et al.* 1993).

The restraints on harvesting may involve giving protection to keystone species that may support the persistence of a range of other species. Thus, fig trees belonging to the genus *Ficus* are recognized as important sources of fleshy fruits available in seasons when no other tropical forest species are producing fleshy fruits. *Ficus* trees thereby promote persistence of a number of insect, bird, bat, squirrel and primate species for which they serve as a critical resource in a period of fruit shortage. All species of *Ficus* are even today to an extent protected as sacred trees through much of tropical Asia and Africa, where the local communities are aware of this ecological role.

Harvesting restraints also include the protection of critical stages in the life histories of species that are especially vulnerable to overharvesting. Thus a nomadic hunting tribe of Western India has the tradition of releasing any pregnant does or fawns of antelope or deer caught in their snares; and egrets, storks, herons, pelicans, ibises and cormorants at their colonial nesting colonies are given immunity from hunting over most of India, although these birds are hunted in the non-breeding season. Finally, in many Asian villages fruit bats are not hunted at their daytime roosts, but may be killed at a distance from the roost during the night (Gadgil *et al.* 1993).

A rich literature of such traditional conservation practices indicates that they have been a common feature of many cultures over many years (see, for example, Suzuki and Knudtson 1992; Maybury-Lewis 1992; Western and Wright 1994). This literature indicates that such practices serve the group interests of communities and that they remain viable only so long as (a) local communities continue substantial levels of dependence on resources garnered from their immediate vicinity, (b) they have full control over the local resource base, and (c) they retain a sufficiently high level of internal cohesion. These conditions are no longer fulfilled when outside state or corporate bodies establish control over natural resources, when access to markets begins to bring in resources from outside and local resources become a source of cash income, and when local communities lose their traditional social organization (Ostrom 1990). In many parts of the world, therefore, hunter-gatherer-shifting cultivator communities are today involved in excessive harvests and depletion of natural biodiversity (Redford 1990, 1992).

Historically, the more advanced agrarian societies seem to abandon most of the conservation practices of technologically less advanced communities. Such societies do, however, provide an example of a new type of conservation practice. With domestication of livestock, meat became available in abundance without having to resort to hunting. However, hunting remained a pleasurable pastime, and provided training for warfare. So the elite established hunting preserves in which resource harvests were severely restricted; and hunting the larger birds and

mammals, pheasants and deer, wild pigs and bear was the exclusive privilege of nobles. In mediaeval India, Hindu kings and Moghul nobles maintained extensive hunting preserves that have since become the nuclei of many of the nature reserves of modern India (Gadgil and Guha 1992). Europe, too, had a system of hunting preserves, for example, the Sherwood forest in Britain and Coto de Doñana in Spain. The elite also maintained menageries with falcons and cheetahs used in the hunt, and a whole range of other animals kept as a curiosity. The best known instance of conservation by these aristocratic zoos is the survival of the Chinese Père David's deer in the Duke of Bedford's zoo in Britain (Grzimek 1990). Successful breeding programmes in zoos have also made possible the reintroduction into the wild of two mammals: Przewalski's horse in Mongolia and the Arabian oryx in Oman.

Following European expansion beginning in 1500s the whole world became interconnected by networks of trade, stimulating interest in the biodiversity of the Earth. This interest was novel in creating people who were curious about a very large biota from diverse ecosystems, in contrast to the traditional in-depth knowledge of a much more limited biota of a circumscribed area in which the ecosystem people operated. There had of course been other attempts at such systematization of knowledge in agrarian societies, notably in developing the pharmacopoeias for the Chinese and Indian systems of herbal medicines. But they had dealt with a more limited range of diversity. Coping with the global range of diversity called for a systematization of knowledge of biodiversity on an unprecedented scale, demands that stimulated such innovations as the Linnaean system of classification of living organisms, von Humboldt's classification of world vegetation, and Wallace's delineation of biogeographic provinces. These achievements were accompanied by van Leeuwenhoek's discovery of the microbial world (Grove 1992).

As the world trading system emerged, many earlier conservation practices were initially completely rejected. But then newer ones emerged, including practices such as the setting up of National Parks or laws to protect endangered species. These attempts have taken on conservation as a responsibility of the state apparatus, often to be practised in isolation from the economic forces in the wider society and through exclusion of extractive human uses (Koppes 1988). These attempts are moderately successful in the industrial countries, but state-directed conservation is more difficult in the developing countries where natural resources must simultaneously provide raw material for the larger economy within the countries and abroad, and meet the subsistence demands of a growing rural population (McNeely *et al.* 1994).

11.1.7 Historical trends in property rights

Over historical periods, flows of biological and other resources from one region to another have progressively

assumed a more and more global character. Managing these flows has involved increasing levels of tighter, centralized control by nation states and their bureaucracies, and by business corporations. Control over environmental resources at the hunter-gatherer as well as shifting cultivator stage is basically in the hands of small kin groups, several of which make up some specific tribal group inhabiting and controlling a larger contiguous tract. As cultivation intensifies, village communities tend collectively to control resources in a similar fashion, though land under cultivation may now assume the character of private property. However, the non-cultivated lands, pastures and woodlots tend to be managed and controlled as community property. Herders, including nomadic herders, may also control pastures as properties of clans.

As populations have grown and societies have become more urbanized, however, such community-managed lands and waters have tended to change hands. An early well-known example of these was the enclosure of commons by English manorial lords in the mediaeval period. The theory was then developed that private or corporate ownership of property was appropriate because the state could expropriate surpluses by taxing such property, and redistribute benefits to the populace (and especially to support the cities). The residual property was to be claimed by the state itself. This scheme left no room for control over common property resources by communities, which were themselves beginning to disintegrate in response to the emerging market economy. This approach was extended to the colonies of European nations, since in these colonies large tracts of forest and pasture lands were under control of local communities for extensive rather than intensive use; such areas were often perceived by Europeans as 'wilderness' or 'wastelands' (Boyden 1992). Most of these lands were taken over as state property without any compensation being made to local communities. This in effect converted huge areas into open access property, since the state was in no position to exclude totally the use of some resources by local communities (Hardin 1968). In such tracts, local communities retained some privileges of use, but no rights for controlling overuse by any members of their own communities, or by outsiders. Huge tracts of earlier community-controlled, biodiversity-rich lands were thus converted to no-man's-lands subject to universal abuse and erosion of biodiversity (Gadgil and Guha 1992).

While this was the general pattern, community management and protection of biodiversity did persist in isolated pockets in several parts of the world. Thus residents of Kallabbe in Western Ghats of Karnataka managed to retain control over their village forest after its take-over by the state between the 1860s and the 1920s. In the 1920s a system of village-controlled forests was revived in this district in response to the forest destruction that followed the dismantling of community control. So

village community-based forest management was officially reinstated in a small number of villages, including Kallabbe. A survey in the 1980s revealed that the Kallabbe village forest was among the most biodiversity-rich tracts in the district (Chandran and Gadgil 1993).

However, not all colonies were the same. A few recognized the negative impacts of settlement and sought to correct them. On Mauritius, the French colonial government passed an ordinance in 1769 which stipulated that 25% of all land-holdings were to be kept as forest, particularly on steep mountain slopes, to prevent soil erosion; all denuded areas were to be reforested; and all forests within 200 metres of water were to be protected. In 1803, clearing of forest was forbidden higher than one-third of the way up a mountain side (Grove 1992).

In some parts of Europe, the community control of common property remained strong through the period of rampant deforestation of Europe. By the mid-nineteenth century Switzerland retained only about 4% of its land under forest cover, leading to serious problems of landslides and siltation. The communities then rolled back the tide of forest loss, and successfully built back the forest cover to the present 25% (WRI 1994). As of today these secondary forests remain under the control of powerful local community-based governments. But such examples of effective community control, whether of ecosystem people as in Kallabbe or of biosphere people as in Switzerland, are exceptions. Over much of the world, biodiversity-rich common lands and waters are largely under control of the state, and have often been permitted to lose much of their biodiversity.

11.2 The impact of human activity on biodiversity

11.2.1 Introduction

The current impacts of humans on biodiversity are both direct and indirect. The direct mechanisms include habitat loss and fragmentation, invasion by introduced species, the over-exploitation of living resources, pollution, domestication and selection, global climate change, local and industrial agriculture and forestry. But these are not the root of the problem. Biotic impoverishment is an almost inevitable consequence of the ways in which the human species has used and misused the environment in the course of its rise to dominance: the factors that have led to the expanding ecological niche of humans are indirect causes of the loss of biodiversity. Sections 3 and 8 have assessed the current status of biodiversity and showed that humans have been a major force in determining this status. Section 6 has assessed human impacts on ecosystem functioning in various biomes. Chapter 11.1 has assessed knowledge about the history of human impact on biodiversity. This chapter will assess the mechanisms of human impacts – both positive and negative, direct and indirect – on biodiversity.

The 'Global Biodiversity Strategy' (WRI, IUCN, UNEP 1992) identified both direct and indirect mechanisms that affect current levels of biodiversity, nearly all of which have significant human components. The direct mechanisms, following Soulé and Wilcox (1980), Diamond (1985) and Pimm and Gilpin (1989), include:

- exploitation of wild living resources;
- expansion of agriculture, forestry and aquaculture;

Key messages

- Humans have endeavoured, rather successfully, to acquire their growing biomass needs from intensifying the productivity of a small number of domesticated species. Populations of the favoured species have then reached high densities in limited areas manipulated as farmlands, pastures, fish ponds or plantations.
- Humans have been engaged over historical times in steadily improving technology and expanding the range of biological resources useful to people. This has inevitably been accompanied by a retreat of the natural world; and an erosion of biodiversity.
- As natural forests and fish stocks have declined, the historical trend is to devote greater effort to plantations and aquaculture. These replace large tracts of natural diverse ecosystems with species-poor systems supported by high levels of technological inputs; they also promote extensive use of pesticides and other poisonous substances resulting in more widespread negative impacts on biodiversity.
- As human technological capacities have increased, so have inequities within and between societies. The powerful social segments within nations have access to natural resources from wide catchments, suffering few of the negative consequences of environmental degradation and erosion of biodiversity. Rather, they have a strong vested interest in continued growth of the artificial at the cost of the natural, often in another country. This disrupted link between maintenance of biodiversity and the quality of life of those who ultimately decide the course of economic activity is at the base of the growing pace of erosion of global biodiversity (Shiva *et al.* 1991).

- habitat loss and fragmentation;
- indirect negative effects of species introduced by humans;
- indirect positive effects of species introduced by humans;
- pollution of soil, water and atmosphere; and
- global climate change.

The indirect mechanisms identified in the 'Global Biodiversity Strategy' and elsewhere are arguably more significant and indicate the foundations of the human impact on biodiversity. They include:

- human social organization;
- the growth of the human population;
- natural resource consumption patterns;
- global trade;
- economic systems and policies that fail to value the environment and its resources;
- inequity in the ownership, management and flow of benefits from both the use and conservation of biological resources.

However, the picture is seldom simple, and in many cases the human impacts on ecosystems can have positive, negative or neutral effects on various elements of biodiversity. Happold (1995), for example, showed that

different groups of mammals had different general responses to human interference (drawing on information from Africa) (Table 11.2-1).

The following paragraphs attempt to assess the current evidence on the impacts of human activities on biodiversity, using the categories listed above while recognizing that these impacts invariably involve a complex interplay of biological, social, historical, economic and political factors. The complexity of human impacts on biodiversity is indicated by Grainger (1992), who presented an example from deforestation (Box 11.2-1), Lamprey (1975), who showed the linkages among the various factors affecting desertification in northern Kenya (Figure 11.2-1), and Tucker and Heath (1994), who attempted to unravel the many threats to the 54% of European birds which are experiencing substantial population declines (Figure 11.2-2).

In any case, it is clear from several studies (e.g. Moyle and Leidy 1992; Frissell 1993; Angermeier 1995) that many extirpations of species are not explainable from knowledge of ecological attributes or particular anthropogenic impacts but are probably due to the cumulative effects of multiple impacts. Clearly, additional research is required to improve our understanding of such multiple and possibly synergistic or non-linear influences. Further study is required on the relationships between the biota and other ecological components, including sub-surface and surface water, riparian zones, watersheds, landscapes, and human influences on all of these (Karr 1991; Angermeier and Williams 1994; Angermeier and Karr 1994).

Table 11.2-1: Responses of mammals to human interference (modified after Happold 1995).

Group (examples)	Responses	Species characteristics	Reasons for response
A. Populations decrease (elephants, rhinos, large/medium artiodactyls and carnivores, most primates)	Negative	Large size Low reproductive rate Compete directly with humans/stock for resources	High value to humans High trophy value Cause damage High monetary value Competition for land Hosts for diseases
B. Populations remain static (many medium-sized mammals, many orders)	Neutral	Variable size Moderate reproductive rate Limited competition with humans/stock for resources	Less value to humans Limited value for trophies Low monetary value Limited competition for land Not known as hosts for diseases
C. Populations increase (certain small rodents, shrews, bats, other small species)	Positive	Usually small size Usually higher productive rate Limited competition with humans for resources, or good at exploiting human resources	No value or limited value to humans Difficult to hunt

Box 11.2-1: The causes of deforestation (Grainger 1992).

A. Immediate causes – land use

1. Shifting agriculture
 - (a) Traditional long-rotation shifting cultivation
 - (b) Short-rotation shifting cultivation
 - (c) Encroaching cultivation
 - (d) Pastoralism
2. Permanent agriculture
 - (a) Permanent staple crop cultivation
 - (b) Fish farming
 - (c) Government sponsored resettlement schemes
 - (d) Cattle ranching
 - (e) Tree crop and other cash crop plantations
3. Mining
4. Hydro-electric schemes
5. Cultivation of illegal narcotics

B. Underlying causes

1. Socio-economic mechanisms
 - (a) Population growth
 - (b) Economic development
2. Physical factors
 - (a) Distribution of forests
 - (b) Proximity of rivers
 - (c) Proximity of roads
 - (d) Distance from urban centres
 - (e) Topography
 - (f) Soil fertility
3. Government policies
 - (a) Agriculture policies
 - (b) Forestry policies
 - (c) Other policies

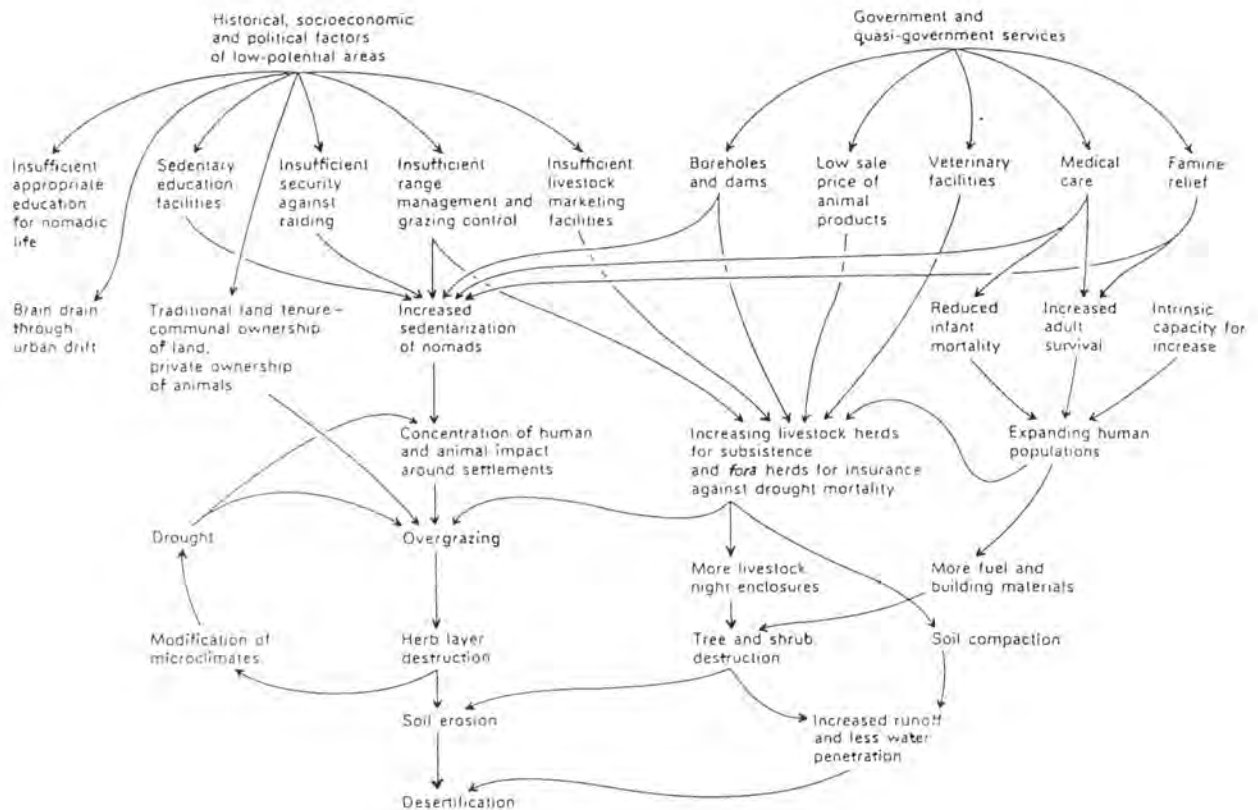
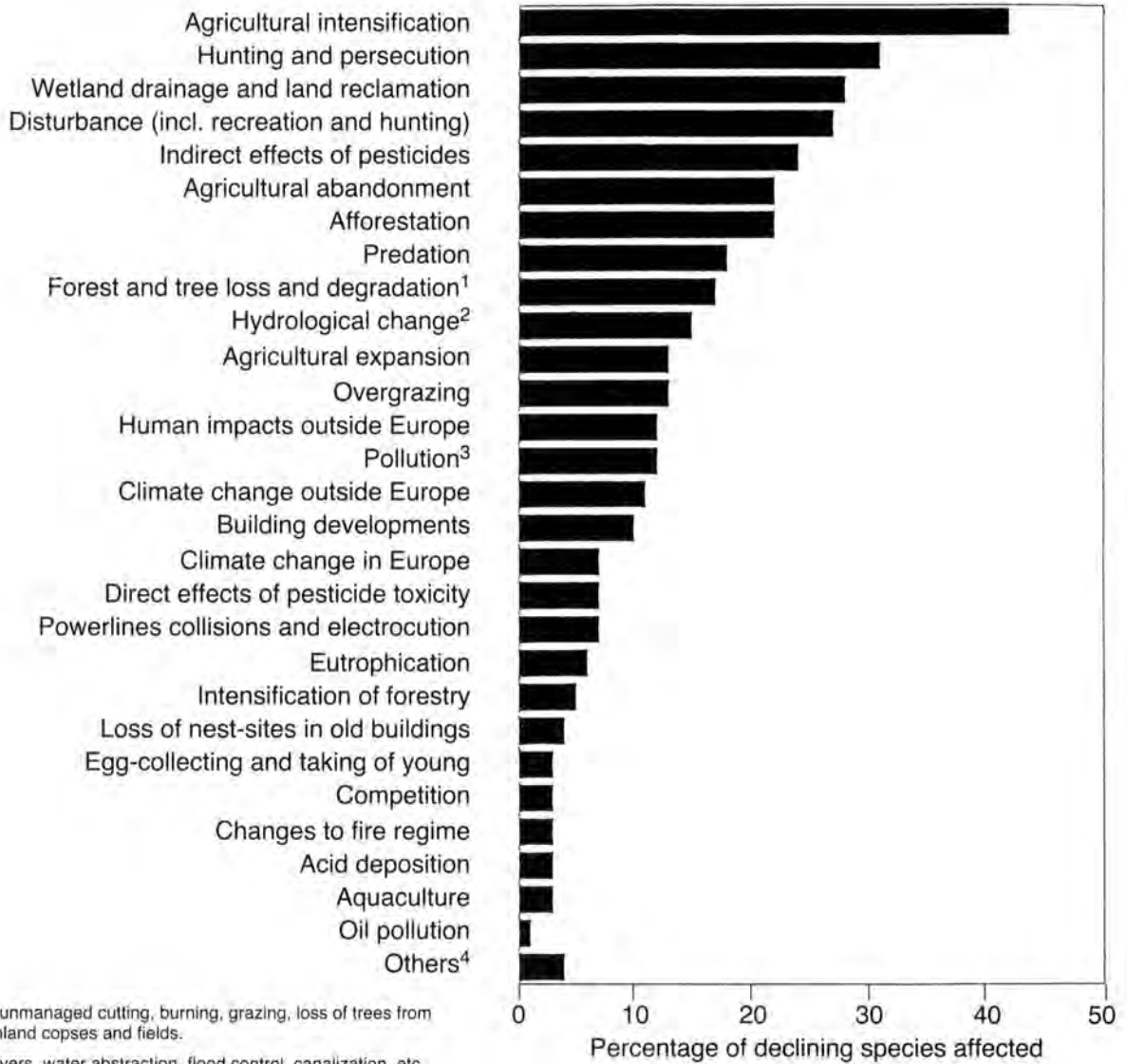

Figure 11.2-1: Some causal factors in desert encroachment in northern Kenya (after Lamprey 1975).



1. Clear-cutting, unmanaged cutting, burning, grazing, loss of trees from orchards, farmland copses and fields.

2. Damming of rivers, water abstraction, flood control, canalization, etc.

3. Other than acid deposition, oil spills, pesticides and eutrophication.

4. Includes destruction of haystacks, hybridization, plant disease, drowning in fishing nets and overfishing (each affected only one species).

Figure 11.2-2: Threats which have contributed to the decline of the 278 bird species, which have substantially declining European populations (total bird species regularly occurring in Europe = 514). (Modified from Tucker and Heath 1994.)

11.2.2 The mechanisms of human impacts on biodiversity

Human impacts on biodiversity become global in two main ways. First, by affecting a globally dynamic system, such as the atmosphere, world climate or sea level; and second, by occurring in a localized or patchwork fashion in enough places to lead to a globally significant impact (Turner et al. 1990) (Box 11.2-2). The following paragraphs discuss the mechanisms of human impacts.

11.2.2.1 Exploitation of wild living resources

Wild resources are harvested by rural people throughout the world for food, shelter, traditional medicines, dyes, oils, intoxicants, fuel, beverages, fibres, tools, religious purposes and cash income. Such harvests are motivated by cultural traditions, survival needs and, to a greater extent today, for

cash income to supplement earnings from other sources. For example, in Niger, 99% of the domestic energy (and 80% of primary energy) requirements are met from wild-harvested wood. Tiega (1993) and Anstey (1991) estimated that 75% of the meat production in Liberia was derived from wild harvests; and Murdock (1958) determined that 83% of 714 ethnic groups in Africa and Madagascar were dependent on wild resources, and 50% relied on fishing, hunting and gathering of wild plant products.

Historically, the environment was carefully manipulated to maintain optimum levels of species for human consumption. To achieve the desired effect, active management was needed. Native Americans in the Pacific Northwest of the United States, for example, conducted burns in the forests near their encampments so as to

Box 11.2-2: Types of global environmental change affecting biodiversity (modified after Turner *et al.* 1990).

Type	Characteristic	Examples
Systemic	Direct impact on globally functioning system	(a) Industrial and land-use emissions of 'greenhouse' gases (b) Industrial and consumer emissions of ozone-depleting gases (c) Land cover changes in albedo
Cumulative	Impact through world-wide distribution of change	(a) Groundwater pollution and depletion (b) Species depletion/genetic alteration
	Impact through magnitude of change (share of global resource)	(a) Deforestation (b) Desertification (c) Industrial pollutants (d) Reduction of population of certain species

facilitate hunting and ensure a plentiful supply of deer (Fisher 1992). Posey (1982) has argued that certain game species would not occur in forest unmodified by humans, and important game species of mammals such as deer, tapir, and collared peccary reach much higher densities in modified areas. Not all traditional hunting-gathering was within the capacity of species/ecosystems, and with increasing demands in recent times, such activities have become threats to many species. In India, some orchids used for medicinal purposes, for example *Paphiopedilum druryi*, *Dendrobium pauciflorum*, *D. nobile* and *Diplomeris hirsuta*, are threatened (Ayensu 1983). Several species of hornbills are also threatened in northeast India due to hunting, traditionally carried out for the supposed medicinal value of their casques, flesh, fat and bones.

The extraction of elements such as fuelwood by rural communities, perhaps once within the carrying capacity of surrounding forests, has now crossed this limit in many areas. Lean *et al.* (1990) identify the fuelwood shortage as 'the poor man's energy crisis' which is affecting 2 billion people world-wide. They calculate that currently 100 million people in developing countries cannot get sufficient fuel to meet energy needs and almost 1.3 billion are consuming fuelwood faster than it is being replenished. A direct result of this shortage is that people are forced to use animal dung as an alternative source. For example, ESCAP (1990) reports that 70% of the cooking needs in some parts of rural India are met by use of animal dung, representing a serious loss of nutrients which would normally be used to replenish the soil. In addition, in India, total fuelwood demand is 235 million m³, but only 40 million m³ can be harvested sustainably from its forests (FSI 1987); a

substantial part of this demand is from urban sources. Leach (1987) argues that rural fuel demand is not a major cause of deforestation; but Davidson (1992) and Ranganathan *et al.* (1993) point out that urban and industrial demand for fuelwood and charcoal may be major factors in forest degradation and deforestation.

Numerous forest, fisheries and wildlife resources have been over-exploited, sometimes to the point of extinction (IUCN 1994). Many historical extinctions have resulted from the human harvest of food, but the search for precious commodities – notably ivory and rhinoceros horn – and for pets, curiosities, and collectors' items has also impinged on some populations and obliterated others (Myers 1979; Ehrlich and Ehrlich 1981; Nitecki 1984; Wilson and Peter 1988).

Any use of biological resources results, to some degree, in alteration of ecosystems, and often in their simplification, an effect which may result in ecosystem instability. The harvest of biomass from ecosystems constitutes a mortality factor for the species harvested, which may add to natural mortality, or be compensatory, i.e. replacing parts of natural mortality. Most human harvest, however, imposes selection that differs from the natural one, affecting the gender, age or size groups present.

The impact of harvesting of material components of biodiversity varies with the type of harvesting and the harvest rate, with a gradient from low impacts on populations and ecosystems (e.g. sport fishing) to high-level harvest of manipulated and homogenized systems (e.g. farming). For instance, up to a certain degree, collection of dead wood for firewood or the picking of berries may be of little consequence for biodiversity. At

high harvest rates, however, removal of dead wood implies a reduction of food and substratum for large groups of species (e.g. Siitonen 1994). Moreover, picking of berries at extreme harvest rates may imply a change in selection pressure or reduction of recruitment rates for the species in question, as well as removing energy which would otherwise either be available to native fruit-eating birds, mammals and insects or form part of the nutrient cycle in the forest.

Hunting has exterminated many endemic species, particularly on islands (Olson 1989; Diamond 1989). However, hunting may also lead to the demise of species in less confined habitats (Caughley 1994), and circumstantial evidence indicates that prehistoric humans were instrumental in the disappearance of many large mammals in the Americas, the Mediterranean, Madagascar and Australia (Janzen and Martin 1982; Martin and Klein 1984; Owen-Smith 1987; Burney 1993). Although modern hunting based on scientifically developed management plans may actually increase population numbers, it is usually selective, implying increased mortality within sex or age groups, altered population structures, life histories and genetic structures and often the removal of some of the most fit males (Skogland 1990).

Harvesting of timber from a natural forest has profound effects on the biodiversity of the forest ecosystem (e.g. in tropical forests: Sayer and Whitmore 1991; Whitmore and Sayer 1992). Harvesting of timber reduces diversity in terms of tree species and structural variation (Järvinen *et al.* 1977; Kouki 1994), although young, early successional stands which develop soon after harvesting may have high biodiversity (Kimmins 1992). Forest trees compete with other plants, provide food for various animals, and dominate the physical structure and microclimatic conditions of the ecosystem, creating habitat and substratum for other species. In unharvested forests, old, dead and decaying trees are food and substratum to many late succession organisms (Whitmore 1984; Maser, 1988; Väisänen *et al.* 1993). Harvesting for timber and fuelwood removes these old and dead trees, and may lead to the disappearance of a number of the specialist species (Raphael and White 1984; Angelstam and Mikusinski 1994; Siitonen 1994).

In addition to these effects, removal of biomass may also influence the nutrient cycling in ecosystems. Clear-cutting removes biomass from the ecosystem and changes its physical structure to an extent that alters microclimate, nutrient cycles and nutrient availability (Bormann *et al.*, 1977; Saulei 1984; Malingreau and Tucker 1988), influencing regeneration processes and thereby species diversity in all subsequent successional stages. This aspect may be more pronounced in moist tropical forests than in temperate forests (Maser 1988), as tropical forests have a larger proportion of their biomass stored in the living vegetation (Whitmore 1984).

Harvest of biomass from natural ecosystems may also be indirect, through the grazing of domestic animals. It is well known that heavy grazing may seriously alter ecosystems in subarctic, temperate and tropical regions (e.g. Bond 1993). The effects of grazing depend on the species of grazing animals, for example domestic goats may destroy the plant roots, promoting soil erosion, whereas cattle only eat the above-ground parts of the plants (although, being heavy animals, they can cause soil erosion indirectly through soil compaction resulting in higher runoff).

While grazing may directly alter plant species composition and productivity, it may also indirectly affect invertebrate species which often play an important role in the maintenance of stability in ecosystems. Mott and Tothill (1994), reviewing the losses in diversity in Australian savannahs, document the large changes in abundance and diversity in ants, soil detritivores and termites as a result of grazing practices. Even at low stocking rates substantial changes in the fauna have been recorded: free-ranging, low-density livestock have been associated with a 60% reduction in small rodents and marsupials in the Central Australian region since pre-European times (Morton and Baynes 1985). A study in China showed that changes in plant communities through grazing by domestic animals directly affected the species composition of grasshoppers, with moderate grazing preserving more diverse grasshopper populations with a lower proportion of pest species (Le 1994). On the other hand, Dodd (1994) discusses the need for caution in explaining the vegetational changes in Africa's arid lands in terms of overgrazing of domestic livestock. While the high densities of animals near high-volume watering points and villages and on rangelands closely linked to crop agriculture in Africa can permanently and severely alter vegetation, he found no scientific evidence that either nomadic or commercial use of livestock has caused irreversible changes in range vegetation away from these areas.

Among wild ungulates, harvesting can affect population growth by influencing reproductive traits such as age at maturity, twinning rate, and proportion of reproducing females (Jonsson *et al.* 1993). These reproductive traits vary with body size and age of the animal, and show geographical variation reflecting differences in environmental conditions and adaptations. There is a negative correlation between age at sexual maturity among moose and life-time reproductive success; cows that mature earlier begin to produce twins sooner than cows that mature later and as a result have higher reproductive output.

Over-exploitation can severely disrupt ecological communities. While it is generally agreed that whaling represents one of the most dramatic alterations of mammalian species diversity by humans, the quantitative effect of whaling on deep-sea biodiversity is difficult to

evaluate because of the lack of information on historical distribution of most whale populations (Evans 1987; Butman *et al.* 1995). But of the large whales, two are endangered and five others are threatened (IUCN 1993), all due to hunting by humans. Populations of all the other large whales have been significantly reduced by human hunting.

Recent evidence (Smith *et al.* 1989; Bennett *et al.* 1994; Butman *et al.* 1995) indicates that these vast reductions in whale populations may have altered the biodiversity of the deep oceans by greatly diminishing an important source of organic matter for the chemosynthetic-based communities associated with hydrothermal vents: decaying whale skeletons apparently serve as stepping-stones that support a chemosynthetic-based deep-sea community of novel organisms. Butman *et al.* (1995) conclude that changes in the distribution and the severe reduction in the supply of whale carcasses may have directly affected deep-sea community composition in the world's oceans. The unique skeletons-associated community was discovered only in 1987 (Smith *et al.* 1989), but the community is apparently being threatened by the reduction in whale skeleton supply which means the spatial interruption or even obliteration of the stepping-stone between hydrothermal vent fields and other microbial-reducing communities. This problem requires more study, especially in view of the great interest that biotechnology has in the unique organisms of the deep sea.

Overharvesting of fish can also have profound systemic effects. For example, over-exploitation of the Atlanto-Scandinavian herring and capelin led to the collapse of many large fish, sea bird and sea mammal populations. Moreover, heavy exploitation of selected species in a multispecies ecosystem will influence the balance among competitors and their predators, prey and parasites, changing the dynamics of the system (Beverton 1990; Ajiad *et al.* 1992). Whether marine multispecies systems disrupted by heavy exploitation will return to their original or some alternative dynamic equilibrium after the harvesting is stopped is not known (Steele and Henderson 1984).

All the recorded extinctions of fish species and subspecies in the present century are from freshwater habitats. Fishing was involved in only a few, and only as a minor factor. The main causes were loss or degradation of habitat, interruption of migration routes and the introduction of exotics (Beverton 1993). This does not mean, however, that human harvesting is unimportant for the persistence and well-being of the exploited populations. On the contrary, fisheries frequently have depleted fish populations and thereby heavily influenced the diversity and dynamics of aquatic ecosystems (e.g. Pitcher and Hart 1982).

The ecosystem of the Barents Sea changed drastically due to the depletion of the herring stock from the mid-1950s to 1970 and the depletion of capelin in the mid-

1980s (Hamre 1994; Gjosæter *in press*). The Arctic cod population decreased due to lack of food (capelin and herring), with cannibalism and low individual growth rates as the result. The coastal cod fisheries were hit by the worst crisis on record. Furthermore, because of lack of capelin and young herring, seabirds, particularly the highly specialized fish-feeding guillemot, died by the thousands (Vader *et al.* 1990). Moreover, large numbers of starved harp seals invaded the Norwegian coast and many died as they were caught incidentally by the Norwegian coastal fisheries (Haug *et al.* 1991). The collapse of stocks and fisheries in the 1980s seems largely to be a result of the herring fishery in the 1960s but the crises in the whole ecosystem were not triggered until the climate changed in the early 1980s and the recruitment conditions of herring and cod were improved. The large capelin fisheries probably added to the shortage of prey in the mid-1980s. Since the late 1980s recruitment conditions for cod and herring have improved and these two stocks are now increasing due to favourable environmental conditions. This example illustrates that the depletion of prey populations has significant effects on the predators; but it also shows that at least some depleted fisheries often can rebound relatively quickly once harvesting pressure is reduced.

Apart from a shift of fishing effort towards the smaller end of the size spectrum of the fish community, clear-cut evidence of the effects of fishing on the substantive structure and function of marine ecosystems is scarce. The most extreme of the above collapses certainly caused detectable changes, for example the decline of seabirds following the collapse of Peruvian anchoveta, their main food (Pauly *et al.* 1989); but in most cases the basic ecosystem had already been profoundly disturbed by natural factors. The collapse of North Sea herring and mackerel was, however, due mainly to fishing which removed some 2 million tons or about one-sixth of the biomass in the area. There was probably a resulting upsurge in small competing species (sandeels, Norway pout and sprat) which may in turn have led to the increase in large predatory gadoids (Cushing 1980), but the evidence is incomplete and circumstantial.

The ultimate genetic threat posed by harvesting and other resource use is the extinction of a species, which results in the complete and (with present technology) irreversible loss of genes or gene combinations, although with the exception of island species, extinction through over-exploitation is rarely recorded (see also 11.2.2.1). Short of extinction, over-exploitation may result in reduction of population size on a local or global scale to a level where inbreeding and loss of genetic diversity become serious problems.

Concern has been expressed in recent years that prolonged fishing, because of its size-selective action, may

alter the genetic structure of the stocks (Policansky 1993; see also Section 13.3.1.1). In large-scale fisheries, where large populations have been depleted from billions to millions, the population may lose a significant proportion of its alleles, which may change the genetic constitution of a population dramatically (Ryman *et al.* 1994). The immediate biological implications of dramatic losses of alleles are unclear, but an organism's potential to survive and adapt to future environments is dependent on allelic diversity.

The ecological effect of changed genetics may influence life-history patterns, including age and size at maturity and reproductive investment of species (Ricker 1981; Law and Grey 1989; Ryman 1991; Hindar *et al.* 1991; Rijnsdorp 1991; Jorgensen 1992; Stokes *et al.* 1993). For example, selective harvesting of different species of Pacific salmon (*Oncorhynchus* spp.) on the west coast of North America has resulted in decreased growth rate and age at maturity over the past 60 years (Ricker 1981). However, in any particular situation it is difficult to foresee the nature and magnitude of the genetic changes caused by differential use (Hindar *et al.* 1991), and the ecological effects of this (Nelson and Soulé 1987). The biology of extinctions is discussed in greater detail in Section 4.4.

11.2.2.2 Expansion of agriculture, forestry and aquaculture

11.2.2.2.1 Introduction. Until this century, farmers and pastoralists bred and maintained a tremendous diversity of crop and livestock varieties around the world. But on-farm diversity is shrinking fast due to modern plant-breeding programmes and the resulting productivity gains achieved by planting comparatively fewer varieties of crops that respond better to water, fertilizers and pesticides. Swift and Anderson (1993) have classified agricultural systems on the basis of their biological diversity and complexity (Figure 11.2-3). The current dominance of intensive cereal production has led to a significant reduction in the number of species and of production systems.

Biswas (1994) has reviewed the impact of modern agriculture on the environment, concluding that the resources necessary for food production have deteriorated since 1962. Modern intensive agriculture has had an adverse impact on the physical environment through the degradation of land, the depletion of water resources and the loss of genetic diversity. Between 1952 and 1989, the area of cereals harvested increased from 616 844 000 ha to 704 732 000 ha, an increase of 14%. However, the yield increased from 1233 kg/ha to 2646 kg/ha, an increase of 114% (FAO 1990a), mostly due to increased use of fertilizers and pesticides. The modern systems have developed in close collaboration with the use of pesticides in a bewildering variety (Mannion 1991) (Box 11.2-3), the impacts of which are discussed in 11.2.2.5.

As a result of changing conditions in agricultural fields, many species of wild birds which had adapted to previous environmental conditions are undergoing significant population declines. Fuller *et al.* (1991) have demonstrated that many of the British farmland birds have undergone startling declines since 1970 as agricultural patterns have changed to remove hedgerows and farm larger contiguous areas (Table 11.2-2), and in conjunction with the loss of roadside verges, pits and ponds, this loss of habitat has contributed substantially to the decrease in biodiversity in Europe over the last century (Agger and Brandt 1988). In addition, there is evidence that, in general, species diversity and abundance are lower on farms using chemicals as fertilizers and pesticides than on farms using organic farming techniques.

Agricultural activities have three kinds of impact on biodiversity: (1) on the natural ecosystems (and their constituent species) within or in place of habitats or areas where they are conducted; (2) on the genetic variability of the cultivated or husbanded species themselves; and (3) through chemical pollution (covered in 11.2.2.5). The degree of impact can range from extinction to increase in population. Over-exploitation may result in reduction of population size to a level where inbreeding and loss of genetic diversity become serious problems. And some

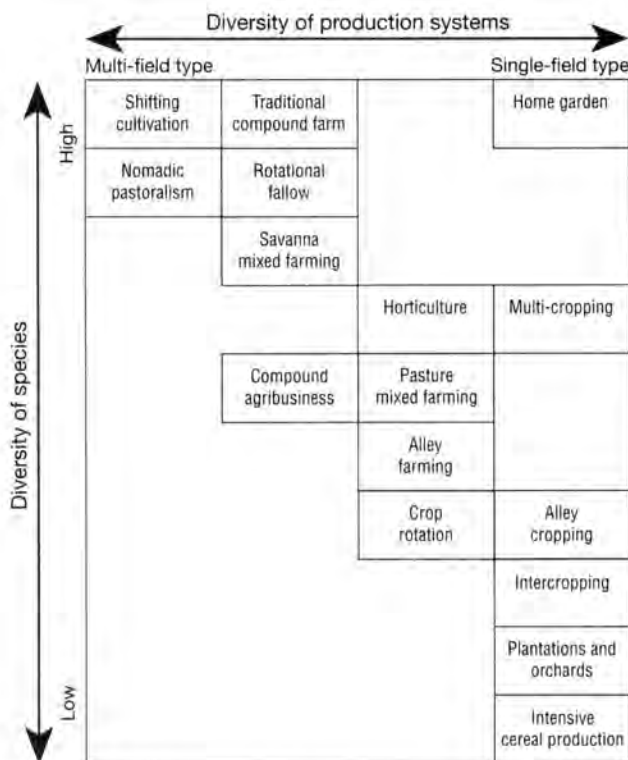

Figure 11.2-3: A classification of agricultural systems on the basis of their biological diversity and complexity. The vertical axis grades systems in relation to species richness of the productive biota, while the horizontal axis represents the complexity of the farming system structure in terms of the diversity of the different types of production system (Swift and Anderson 1993).

Box 11.2-3: Direct human impacts on 'pest' species: categories of pesticides (Mannion 1991).

	Herbicides	Fungicides	Insecticides	Acaricides	Nematicides	Molluscicides	Rodenticides	Plant growth regulators
Target organisms	Weeds	Fungi	Insects	Mites	Nematode worms	Snails, slugs	Rodents	Crops
Examples of types of pesticides and typical products	Phenoxy-acids 2,4 - D MCPA	Pyrimidines Ethirimol Fenarimol	Organo-chlorines DDT Dieldrin	Organo-chlorines Dicofol	Fumigants Methylbromide Dibromochloropropane	Aldehydes Metaldehyde	Coumarins Warfarin Coumateteryl Brodifacoum	Hormones Gibberellic acid Ethylene
	Bipyridiums Paraquat Diquat	Alanines Furalaxyl Ofurace	Organo-phosphates Terbuphos Dimethoate	Organotins Cyhexatin	Carbamates Aldicarb Oxamyl	Carbamates Methiocarb Thiocarboxime	Inorganic Zinc phosphide	Triazoles Paclobutrazol
	Phosphonates Glyphosate	Triazoles Triadimefon Flutriafol	Carbamates Aldicarb Carbofuran	Tetrazines Clofentezine	Organophosphates Fenamiphos			
	Pyrazoliums Difenzoquat	Pyrethroids Permethrin Cypermethrin Fenvalerate Tefluthrin Cyhalothrin						
	Aryloxy- Phenoxy-acetic acids Diclofopmethyl Fluazifopbutyl Nitrodiphenylethers Fomesafen Acetanilides Alachlor							

species, notably those that benefit from the agricultural plants, may increase to the level at which they become pests. Some domesticated plants and animals may have greatly increased genetic diversity (at least historically). We assess below the relative impacts of traditional and modern/commercial agriculture on other habitats and on genetic variability.

11.2.2.2.2 Traditional cultivation. At the level of intra-species genetic variation, traditional agriculture has been tremendously successful in enhancing biodiversity. Within

Table 11.2-2: Decline in population of farmland birds in Britain between 1970 and 1988 as shown by the Common Birds Census (from data in Fuller et al. 1991).

Species	Percentage decline
Corn bunting	69
Grey partridge	67
Tree sparrow	67
Lapwing	59
Bullfinch	58
Song thrush	54
Turtle dove	48
Linnet	36
Skylark	33
Spotted flycatcher	31
Blackbird	28

200 regularly cultivated plant species (WCMC 1992), very large genetic diversification has occurred in farming communities over the centuries. No aggregate figures appear to be available, but some indication can be had from the individual crop and country examples given below.

For farmers practising low-input agriculture, the maintenance of species and genetic diversity in fields is an effective strategy to create a stable system of conservation. Cultivated crops often intercross with their wild or weedy relatives growing in the field or in nearby fields, resulting in new characteristics. This has been observed for ensete (*Ensete ventricosum*) in central and southern Ethiopia. Farmers have exploited this system of interbreeding to adapt plants to changing agro-ecological realities. Strategies of intercropping and cropping with varietal mixtures may result in accidental crosses between the varieties, thereby promoting introgression and new genetic combinations. Bayush (1991) reports that farming communities in southern Ethiopia actively manage germplasm through artificial selection. It is believed that the different characteristics of plants within the brassicas, such as *Brassica carinata* (Ethiopian mustard) and

Brassica nigra (black mustard), arose on farms in which mixtures of these two species were planted. Also, coffee growers often preserve a diversity of local varieties in small areas alongside the more uniform coffee blight disease-resistant line which is distributed by the coffee improvement projects in Ethiopia (Worede and Mekbib 1993; Boef et al. 1993).

Traditional agriculture has been characterized not only by high intra-species diversity, but also by the use of a wide variety of crop species within the same system. In India, one species of mango, *Mangifera indica*, has been diversified into over 1000 varieties; and one species of rice, *Oryza sativa*, has over 50 000 varieties (IIPA 1995). In Java, small farmers cultivate 607 crop species in their gardens, with an overall species diversity comparable to deciduous tropical forest (Dover and Talbot 1987). This immense diversification within and between crop species was not accidental, but often carefully developed by farming communities.

The perception that agriculture has negative impacts on natural biodiversity is widespread, but not necessarily true where people have carefully adapted their farming and harvesting techniques to their environment. In the plains of Uttara Kannada (southern India), dominated by erstwhile shifting cultivators, under traditional management about 6% of the land was maintained under sacred groves. The mosaic of shifting cultivation sites, pastures, sacred groves and secondary forests in different stages of vegetational succession enhanced landscape heterogeneity and had been responsible for the abundant wildlife, including game animals and birds, which the local communities hunted for subsistence in the pre- and early colonial period (Chandran and Gadgil 1993). In the Amazon, there is often little distinction between cultivated and wild species, nor can a clear boundary be drawn between fields and fallow or between fallow and forest. Yet effects of indigenous cultivation are far-reaching and have substantial impacts on levels of biodiversity. Posey (1982) found that while routinely scavenging through the forest, the Kayapo Indians of Brazilian Amazonia gathered dozens of plants, carried them back to the forest campsites or trails, and replanted them in natural forest clearings. Such plants included several types of tubers, beans and other food plants. Such 'forest fields' are always located near streams, but even in the savannah, where patches of forest are scattered, areas where collected plants have been replanted form useful food depots for the Kayapo. This age-old pattern has had profound effects on the distribution of plants in the forest and has been an essential contributor to the current high levels of biodiversity in Amazonia.

Other studies have shown that moderate levels of human use tend to increase local biodiversity, by opening up new niches, providing new food or shelter sites, and diversifying the micro-habitats. Janzen (1987) reports that a

tropical forest that has had some crop production has a larger number of insect species than a primary forest. A study of two oases in the Sonoran Desert on either side of the Mexico–United States border found that the customary land-use practices of Papago farmers on the Mexican side of the border contributed to the biodiversity of the oases, while the protection from human use of an oasis 54 km to the northwest, within the Organpipe Cactus National Monument, resulted in a decline in the species diversity over a 25-year period (Nabhan *et al.* 1982). Saldarriaga *et al.* (1988) found that old secondary forest has greater species diversity than mature primary forest, with each 0.03 ha plot in 14-year-old secondary forest having 56 species, while plots of the same size in 30-year-old secondary forest had 77 species, 80-year-old secondary forest had 79 species, and mature primary forest had just 66 species.

Kappelle *et al.* (1995) studied changes in terrestrial vascular plant diversity along a successional gradient in a Costa Rican upper montane *Quercus* forest, finding that early secondary forest had 145 species of plants, late secondary forest had 130 species, and primary forest had just 96 species. They conclude that montane secondary forests can play a major role in the conservation of tropical montane vegetation, since they harbour a wealth of plant species which are becoming threatened in their original habitats up-slope. This is especially true for tropical alpine (*páramo*) and sub-alpine herb species that flourish in the early stages of montane secondary forest that recover from clearing and subsequent grazing. Moreover, their presence enhances the establishment of later successional species which are responsible for the success of the forest recovery process. In fact, secondary forests in upper montane Costa Rica can be as diverse as neotropical lowlands.

Such findings have also been observed in the case of traditional shifting cultivation in Asia (Ramakrishnan 1992; Wharton 1968). Forest clearings established by shifting cultivation in Southeast Asia provide the major habitat for

most of the region's large herbivores, especially wild cattle (Wharton 1968). In the Western Ghats district of Uttara Kannada, the nomadic shifting cultivators seldom came back to recultivate the fallow, which resulted in an enormous growth of secondary forests, a mixture of climax evergreens and deciduous timber trees such as teak (*Tectona grandis*) and rosewood (*Dalbergia latifolia*) (Chandran 1992). The prohibition of shifting cultivation in Uttara Kannada by the close of the nineteenth century and the simultaneous extraction of deciduous hardwoods resulted in quick elimination of species such as teak, prompting the Indian Forest Department to clear-fell natural forests and raise teak monocultures, with disastrous impacts on biodiversity.

Traditional agriculture has also played an important role in conserving genetic diversity by ensuring the perpetuity of certain species. A well-known example is that of the recently discovered perennial corn, *Zea diploperennis*, a secondary species that grows in abandoned cornfields. To protect the species, the local slash-and-burn techniques of traditional agriculture may be the most efficient way to provide the habitat that it requires. Without all the human cultural practices that go with the habitat, the species could be lost (Gómez-Pompa and Kaus 1992).

Traditional pastoralists have often tended to foster biodiversity, in both plants and animals. Many pastoral societies have developed elaborate protection systems for the preservation of the vegetational resources of their grazing areas (Shoup 1990), though their impact on wild mammals remains controversial (Table 11.2-3). Pastoralists have deliberately bred livestock to meet different needs and conditions. For example, at least a dozen breeds of camel are known in the Sudan alone (Köhler-Rollefson 1993). However, the wealthier sectors of society in Sudan are now accumulating large livestock holdings through purchase of animals from different tribal groups, with the resulting cross-breeding making camels into one generic type. It is

Table 11.2-3: Alternative viewpoints on the influence of pastoralism on wild mammals (after Happold 1995).

Viewpoint 1 (Brown 1971; Poins 1992)	Viewpoint 2 (Homewood and Rodgers 1987)
Cattle compete with mammals for forage.	Cattle and mammals can coexist because of niche separation.
Cattle cannot coexist with wild mammals.	Cattle can coexist with wild mammals.
Too many cattle cause ecological degradation.	Cattle do not cause long-term degradation, even though pastures may look overgrazed at the end of the dry season.
The number of pastoralists must be limited to conserve the pastoral way of life.	The number of pastoralists can increase (within limits) without adverse effects.

clear that breeds of domestic animals are not simply biological taxa, but rather represent the outcome of social processes; they are therefore unlikely to survive outside the social contexts and production systems that formed them.

Ironically, the gradual disappearance of indigenous breeds that are able to exploit the vegetational resources of extreme environments, such as deserts and other uncultivable lands, seriously affects the capacity of human society to inhabit large areas of the globe. The loss of these hardy animal breeds therefore means a reduction in the area of human habitat (Köhler-Rollefson 1993). Pastoral societies therefore contribute significantly to the maintenance of biodiversity in domesticated animals and help keep otherwise barren tracts of land habitable for humans.

Although many examples of traditional management are positive, many cases of mismanagement can be found as well. Linares (1976) describes archaeological sites at Cerro Brujo which represent a 20–30 year occupation about a millennium ago, indicating that the residents significantly over-exploited their habitat and then moved on to a new area. Perhaps at that time, this system was sustainable in that over-used habitats were able to restore themselves and migration was possible.

Many agricultural areas can be considered 'semi-natural communities', defined as plant and animal communities composed of species that are indigenous and/or wild in the region, but where the development and maintenance of the communities requires direct or indirect human impact. This human impact can be through a variety of practices linked to agriculture, such as forest clearing, burning, grazing by domestic animals, and/or mowing. The long-term persistence of these activities is essential to maintaining the biodiversity of these systems. European examples of semi-natural vegetation include most lowland heathlands and grasslands, and many woodlands and shrublands that have been affected by burning and grazing. On the other hand, natural grasslands and heathlands in Europe are shaped mainly by climatic and edaphic factors and include alpine grasslands and heathlands above the treeline and communities affected by periodic flooding along freshwater and marine shores. Many European grasslands have their origins in early prehistoric times, some 6000 years ago (Berglund *et al.* 1991) or even earlier (Bush and Flenley 1987). The biologically important Atlantic heathlands along the Atlantic coasts in Western Europe (Gimingham and de Smidt 1983) were developed during the Early Iron Age, c. 2000 years ago (Berglund 1969; Odgaard 1994). Recent investigations indicate that some moorlands of Western Europe, the blanket bogs, might have been initiated as early as the Mesolithic, around 7700 BP, by human activity of burning and grazing (Caseldine and Hatton 1993). These heathlands and grasslands are today threatened ecosystems that harbour a number of endangered plant and animal species and act as refuges of

biodiversity (Oostermeijer *et al.* 1994). The threats are mainly changes in land management, including cessation of grazing or mowing (Stevenson and Thompson 1993).

For semi-natural grasslands on limestone bedrock and calcareous soils, plant biodiversity reaches very high levels. Among the highest species richness ever recorded of field layer species (expressed as number of vascular plant species per unit area) is one reported from semi-natural meadows on limestone bedrock in South Estonia, with 63 species per square metre (Kull and Zobel 1991). Semi-natural grasslands are definitely European hotspots of biodiversity; in the absence of active management these semi-natural grasslands and heathlands revert by natural succession to woodlands and forests, and the species richness of vascular plants declines (Londo 1990).

Furthermore, indications are that the long-term existence of semi-natural communities has allowed the development of subspecies (and maybe even new species) with adaptations to the specific ecological conditions prevailing in a grazed or mowed grass-sward (Reinhammar 1995; Olsson *et al.* 1995).

11.2.2.2.3 Modern cultivation. Overwhelming evidence leads to the conclusion that modern commercial agriculture has had a direct negative impact on biodiversity at all levels: ecosystem, species and genetic; and on both natural and domesticated diversity. Agriculture may be one of the most important causes of pollution, by the production of sediments, by the generation of chemical wastes, or by the use of pesticides (Goudie 1993), and the runoff of organic wastes and inorganic fertilizers inflicts significant damage on aquatic ecosystems.

On the other hand, modern intensive agriculture has enabled substantial human populations to be fed, without resorting to extensive forms of agriculture which might cause even worse losses of biodiversity. Current information does not allow any general conclusion on this point, but further examination of the issues involved may lead to improved understanding.

At the level of ecosystems, commercial agriculture has led to considerable homogenization of the landscape. Surface irrigation schemes, for instance, transform a complex mosaic of micro-habitats into a uniform agricultural landscape, favouring relatively few crop species and varieties. In the process, micro-habitats such as hedgerows, fallow, bushy growth, tree groves and others, which harbour considerable biodiversity, are lost. Irrigation has been used by agriculturalists for thousands of years, dating back to the first major civilizations of Mesopotamia, and it is believed that irrigation on a large scale allowed the development of urban cultures by increasing the carrying capacity of the land, with a number of profound social consequences (Wittfogel 1957). However, the gradual salinization of the land which resulted, along with other unsustainable land practices, eventually lead to the

downfall of the Mesopotamian civilization of Sumer (Barnaby 1988).

Irrigation has continued to play a role in agricultural activities world-wide and WRI (1994) estimates that it is the largest consumer of fresh water on a global scale, consuming 2.5 times more than industry and accounting for 63% of water withdrawal globally (WRI 1990). Over the last few decades it has played a vital role in the dramatic increase in food production. White (1994), for example, estimated that 55% of the world's rice areas rely on irrigation. The total area of irrigated cropland in the late 1980s was 230 million ha representing 15% of the cropland world-wide and 31% of cropland in Asia (WRI 1990).

Although figures are conflicting, an authoritative estimate suggests that 2 million hectares per year are lost through salinization (FAO estimate quoted by Döös 1994), the same problem that afflicted early Mesopotamian efforts at large-scale irrigation. It seems likely that increasing dependence on irrigation in food production could exacerbate this problem. In its extreme form it results in the death of vegetation through toxicity and poor soil structure, creating bare ground which then becomes eroded by wind and water. For example, one of the most threatened ecosystems of the Indian subcontinent is the tropical thorn forest. The inception of canal irrigation in the last century and further new settlement and development of underground water resources and increasing trends toward waterlogging, salinity and desertification have now pushed natural tropical thorn forest communities to the verge of extinction (Khan 1994) (Box 11.2-4).

The evolution of crops over the past 10 000 years has been affected by both natural and artificial selection, the latter involving isolation of stocks followed by migration and seed exchanges; the resultant hybridization and recombination of genes has undoubtedly added to the genetic diversity of crop species. However, modern cultivation techniques are signalling the end of this period of diversification. The major threat to traditional varieties in the developing world is the process of agricultural modernization. In 20 years, a few modern high-yield varieties (HYVs) have replaced ancient crop varieties or 'landraces' as part of international and national efforts to develop agriculture. Preliminary assessments of genetic erosion in Mexico and Peru indicate several trends that may be generalized to most crops in the region (Brush 1991; Brush *et al.* 1992; Bellon 1991; Bellon and Brush 1994):

- Genetic erosion is occurring because farmers are changing their farming systems, pushed by social, economic and technical forces.
- The pattern and rate of adoption of HYVs is very uneven across geographic regions.

Box 11.2-4: Agricultural intensification and biodiversity in the Aral Sea.

A tragic example of how agricultural intensification can go wrong is observed in the Aral Sea, the largest body of water between the Caspian and the Pacific. Vast new irrigation systems, including the 1100 km Karakum Canal through southern Turkmenistan, led to the draining of the Amu Darya and Syr Darya rivers, causing the Aral Sea to shrink by over half and lose more than two-thirds of its volume since 1960. Its largest city is now 100 km from the shore. The loss of biodiversity has been profound; its waters formerly supported 24 species of fish, but now support none, and its 60 000 fishermen are unemployed. The former seabed is now a salt desert swept by the prevailing north wind, which dumps between 40 and 150 million tons of sand and salt on the precious fertile land of the Amu Darya delta each year. The problems are made worse by the use of pesticides and chemical fertilizers which are considered necessary to maintain yields of cotton, but which accumulated in the sediments of the Aral Sea, and are now turned into dust and carried to the surrounding lands (Ellis 1990; Kotlyakov 1991; Precoda 1991).

- As adoption of HYVs occurs, farmers tend to subdivide their farming systems into commercial sectors mostly devoted to HYVs and subsistence sectors where they still grow native varieties.
- Greatest losses of traditional varieties have occurred in lowland valleys close to urban centres and markets.
- The least genetic erosion occurs in higher zones (especially mountain areas) distant from urban centres and markets.

In general, diversity of crop genetic resources is affected by the following factors which both promote and constrain genetic change:

- Changes in numbers of and distribution of human populations.
- National and international crop improvement and extension programmes.
- Changes in consumption patterns in urban and rural populations.
- Increases in demand from urban markets.
- Improvements in transportation and communication systems.

- General factors in the agricultural economy such as human capital, labour, credit, tenure, and the availability of fertilizers, pesticides and irrigation.
- Development aid programmes.

Three decades of the Green Revolution in India have led to an enormous loss of biodiversity, though the exact dimensions are still not assessed. Some idea of the loss can be gauged by the fact that a handful of HYVs are now grown on over 70% of the rice land and 90% of the wheat land; in the Godavari district of Andhra Pradesh, an estimated 95% of rice varieties have been lost. Possibly thousands of varieties of rice, cotton, minor millet, pulses, and other crops are no longer in use in farmers' fields (Shiva 1991; Kothari 1994a). This loss of crop diversity extends globally to most crop species, including wheat and maize which, along with rice, supply half the world's caloric intake (Huxley 1984).

The loss of genetic diversity also occurs with animal domestication where a few highly productive breeds are transported world-wide, displacing and eventually resulting in the extinction of local breeds. The simplification of agricultural systems has severely affected the genetic diversity of domestic species of animals, with some 27% of the 1400 recorded breeds with population data threatened with extinction (Loftus and Scherf 1993) (Table 11.2-4). Genetic improvement has been used with particular intensity in the developed regions of Europe and North America during the second half of the twentieth century, where it has caused a marked decline in the numbers of traditional breeds and a preference for a few highly productive breeds serving the modern markets for milk and meat products. This decline in indigenous breeds and their replacement by a few highly favoured breeds has not yet taken place so thoroughly in the developing regions, owing to the greater need for adaptive traits in the tropics. However, genetic diversity in domestic livestock species can be expected to decline in the tropics as modern management techniques are introduced which modify the animals' environment and permit the use of less adapted breeds. India, for example, has a history of three decades of modern livestock breeding; an estimated 50% of indigenous goat breeds, 20% of indigenous cattle breeds, and 30% of the indigenous sheep breeds are today threatened (Balain 1992). The decline of local livestock diversity has perhaps been greatest in poultry; an estimated 80% of the total population in use is now of exotic breeds.

These various races/breeds along with their wild counterparts form the genetic base which plant and animal breeders use in developing their high-yielding varieties; their loss thus threatens the very building blocks of our modern agricultural system.

On the other hand, the expansion of agriculture seems inevitable. As Thomas Jefferson (quoted by McMillen

1981) said over 200 years ago, 'Whenever there are in any country uncultivated lands and unemployed poor, it is clear that the laws of property have been so far extended as to violate natural right. The earth is given as a common stock for man to labour and live on.' Two centuries later, naturalists might give wilderness itself more standing than Jefferson did. Nevertheless, even today parents of hungry children will not long hesitate to cross a boundary drawn around uncultivated land by absentee law-givers. What might be called Jefferson's Law of Property states that cropland will expand to match the product of population times diet divided by yield – regardless of legalities. Abundant harvest from cultivated land is the essential element for preserving the biodiversity on other, uncultivated land.

From AD 1700 until the middle of this century, agriculture grew more extensive, expanding global cropland per capita to about 0.5 ha. During recent decades, however, cropland per capita has fallen to 0.3 ha. Given the simultaneous improvement in diet and Jefferson's Law, higher yields – not rising population – caused the declining cropland per capita with the opportunity to preserve natural biodiversity on other, uncultivated land (Waggoner 1994).

11.2.2.2.4 Fisheries. Aquatic ecosystems, covering two-thirds of our planet's surface, have always been an important source of human food. All aquatic populations show biomass fluctuations: biomass increases with recruitment and individual growth, and decreases with mortality. The loss in biomass can be divided into natural mortality (predation, starvation, disease, etc.) and fishing mortality (human harvest).

WRI (1994) concluded that stock depletion in marine fisheries does not necessarily lead to endangered/extinct species, although it has other undesirable effects (social and economic). No case of overfishing leading to the extinction of a species has ever been documented. More insidious effects, which are difficult to quantify, include the effects

Table 11.2-4: Domestic breeds at risk (Loftus and Scherf 1993).

Species	On file	With population date	At risk ¹
Ass	78	17	11
Buffalo	62	28	1
Cattle	783	446	112
Goat	313	133	32
Horse	357	175	81
Pig	263	141	53
Sheep	863	493	101
Total	2719	1433	390

1. Estimated from breeds with available population data.

of over-exploitation of one species on other species or on whole ecosystems and the genetic effects of overfishing on exploited populations.

Marine and freshwater fisheries do not differ fundamentally; but the freshwater habitats are generally more circumscribed and less hostile as a working environment than the oceans, and are therefore more easily exploited by unsophisticated fishing gears and vessels. Multiple uses of open access freshwaters for fisheries, irrigation, domestic supply, sewage disposal, recreation and navigation leads to relatively frequent conflicts between users. Conversely, many freshwater bodies are privately owned, leaving scope for quite comprehensive management of the resources.

Fisheries can be broadly classified into five categories which form a continuum. Where markets have emerged or been developed, a transition towards more sophisticated, capital intensive systems has often been observed.

- Traditional or subsistence fisheries are those carried out primarily for fulfilling immediate food requirements and the catch is seldom bartered or sold. Examples of sustainable, community-based fishery management include indigenous use of marine mammals in Greenland and North America (Ward 1993), many Pacific Island reef and lagoon fisheries which are governed by elaborate codes of customary laws (Johannes 1981; Ruddle *et al.* 1992), and some invertebrate fisheries in the Caribbean (Smith and Berkes 1991).
- Recreational fisheries, often conducted with rod and line or with spear-guns, are the modern equivalent of traditional fisheries. In Europe and North America, recreational fisheries are of considerable economic importance and, in fresh waters, are usually readily and stringently controlled by licensing.
- Small-scale or artisanal fisheries are conducted on a commercial basis, usually from small vessels (or none at all), operating from beaches or moorings in which the basic operating unit is usually a kin group which markets its own catch. Artisanal fisheries currently provide approximately 25% of the global fish catch and c. 40% of the fish used for human consumption and employ the vast majority of the world's fishers, especially in developing countries. In Africa, the artisanal catch in 1989 accounted for more than 60% of the total domestic catch (Tvedten and Hersoug 1992). Usually a wide array of fishing gear is operated, which will vary according to weather or season, and the catch is composed of a multiplicity of species of fishes and invertebrates. Little is discarded as unsaleable in most developing countries. Although co-management systems have in some cases evolved from community-based management systems and are likely to be a

significant tool in the future, the majority of the world's small-scale fisheries are neither managed nor regulated with any significant effect. In the most overpopulated regions, many of the fishers are landless peasants who have entered the fishery as the resource-of-last-resort. As recent entrants, they are not bound by tradition nor do they have significant experience of the aquatic environment; they are motivated by their immediate need to fish to survive. Many cannot afford to eat the fish that they catch and all must be sold in order to purchase staples such as rice. Under such circumstances the pressure on the resources is very great and fishers are led to use destructive fishing methods such as explosives or poisons which destroy the resource base upon which the fishers depend. This has been termed 'Malthusian over-fishing' (Pauly *et al.* 1989). Moreover, the tendency to copy large-scale western industrial fisheries has yielded a number of failures (Tvedten and Hersoug 1992), and overfishing has become a major problem in small-scale fisheries.

In addition, the artisanal multispecies fisheries, such as operate in most tropical developing countries, can continue to operate after the most desirable species have been drastically reduced in abundance or extinguished locally (Munro and Smith 1984). For example, various species of groupers and snappers have become virtually extinct in Jamaican waters over the past few decades (Munro 1983; Koslow *et al.* 1988) yet the artisanal fishery continues, sustained by price rises for the available species.

- Large-scale or industrial fisheries operate sophisticated fishing vessels which supply centralized marketing systems located in fishing ports. The fishers are seldom involved in the marketing of catches and the crew are usually hired labour. The industrial fisheries of the world have steadily increased their role in world fish production and have, with few exceptions, come to over-exploit the resources upon which they have been based. This has led to economic dislocations, conflicts with artisanal fishers over access to a diminishing resource and drastic changes in the composition of the exploited fish community. The causes of the problems lie primarily in the open access to the resource and the reluctance of authorities to abrogate this 'right'. Additionally, the frequent provision of subsidies to support ailing fisheries, rises in the relative price of fish in response to scarcity, and technological improvements have meant that the best-equipped vessels can still make large short-term profits from a depleted resource. These factors have combined to ensure that most important fish stocks have been fished far beyond sustainable levels in the past decade.

At present, many of the world's largest and oldest fisheries are overfished in the sense that their productivity has been reduced below their potential maximum, sometimes very considerably, by unnecessarily heavy fishing (FAO 1990b). One example is fishing for finfish in the Southern Ocean which began in 1969–70 and for krill in 1972–3. After 15 years of exploitation, most fish stocks around South Georgia and Iles Kerguelen were heavily depleted. Impacts of krill and finfishing on the ecosystem of the Southern Ocean range from endangering recruitment due to the by-catch of juvenile fish in the krill fishery to incidental mortality of birds during longline operations and the entanglement of seals in fragments of discarded or lost fishing gear (Kock 1994). In the North Atlantic, cod populations in West Greenland (Dickson and Brander 1993) and in Labrador and Newfoundland (de Young and Rose 1993) have collapsed, i.e. fallen in abundance by 20 fold or more over a few years, although this has probably been the result of a combination of overfishing and natural causes.

The period from 1950 to 1970 saw the collapse of many of the world's largest fisheries for small pelagic species (Beverton 1990). All but one (Icelandic spring-spawning herring) have recovered, though to varying degrees and at various speeds. Some, like the Icelandic summer-spawning herring (Jakobsson 1992), the Georges Bank herring and the Japanese sardine, are now more abundant than in their former peak. All were heavily fished, especially in the waning years before fishing was stopped. These were species low in the food chain and hence directly dependent on primary productivity (Mann and Lazier 1991). Some are in unstable upwelling areas, e.g. the Peruvian anchoveta (El Niño effect; Pauly et al. 1989), and the Californian sardine, where scale deposits show their abundance has altered dramatically over the last 2000 years (Baumgartner et al., 1992). Others are on the meandering edge of a major boundary current, such as the Japanese sardine on the Kuroshio current and Georges Bank herring on the Gulf Stream.

Indiscriminate methods of resource use (e.g. drift-net fisheries) leading to high by-catch mortality can endanger species other than those targeted (Northridge 1991; Mangel 1993). Monofilament drift nets 60 km long and 60 m in depth are used in the South Pacific and the North Pacific, representing a fishing effort in the open ocean that was not previously thought possible. These massive drift nets not only take a huge harvest of target species but also catch non-target species indiscriminately. Elder and Pernetta (1991) report that one fishing trip by 32 Japanese ships using drift nets resulted in the deaths of 50 000 sharks, over

1000 small cetaceans, 52 fur seals and 22 turtles in the process of taking 3 million squid.

'Ghost fishing' refers to discarded or lost fishing nets and traps which continue to catch marine animals (Norse 1993). GESAMP (1990) reported that lost fishing gear was already estimated at 150 000 items world-wide 20 years ago. A 1.6 km long gill net in the North Pacific was found to have 350 seabirds entangled in it. Seals are particularly vulnerable to entanglement: at least 15 of the world's 32 pinniped species have been seen entangled and as many as 10 000 harbour seals (*Phocaena phocaena*) are thought to be lost annually in this way in the Danish North Sea (Vinther 1994). Entanglement kills thousands of northern fur seals in Alaska's Pribilof Islands and it poses an increasingly severe threat to the critically endangered Hawaiian monk seal, even though attempts are made to remove debris from its habitat.

- Aquaculture, whether marine or in fresh waters, is an old tradition, but has been greatly expanded over the past 20–30 years with sophisticated hatchery technologies for mass-rearing of larvae of many species. Technical advances in cultivation systems have enabled operations to be moved progressively into deeper and less protected ocean waters. During 1989–91, average annual aquaculture production of fish and shellfish was c. 12 million tons, and the production is increasing. The largest producers are found in Asia (China, India, Indonesia, Japan, Republic of Korea, Philippines, Thailand), Europe (France, Italy, Norway, Spain) and North America (USA) (WRI 1994). The increase in aquaculture production is rapid and very promising, but industrial fish farming is not without problems and conflicts. For instance, a large number of artificially reared fish escape each year from fish farms into the wild. This can result in the spread of contagious diseases (e.g. furunculosis, bacterial kidney disease), ecological interference with wild populations, and disruption of the genetic structure of wild populations through introgression, genetic drift and unintentional changes in selection regimes (e.g. Egidius *et al.* 1991; Hindar *et al.* 1991; Heggberget *et al.* 1993; Jonsson and Fleming 1993).

The artificial enhancement of natural fish stocks by the release of hatchery-reared fingerlings, also called sea ranching, results in genetic effects on conspecifics which are unpredictable and vary from no detectable effect to complete introgression (Hindar *et al.* 1991). When genetic effects on performance traits have been detected, they appear always to be negative in comparison with unaffected populations. Even when animals from local populations are used as brood stock

in the artificial propagation, the changed selection regime during rearing may change the genetic structure of the recipient population (Ryman and Ståhl 1980; Waples 1991), though the implications of this for biodiversity remain unclear.

11.2.2.2.5 Forestry. Global closed forest is estimated to have covered three million hectares in the early 1980s, roughly evenly split between temperate and tropical areas. In the most authoritative statement on forest status globally, FAO (1993) reports that between 1980 and 1990, an annual average of 15.4 million ha of tropical forests were cleared, amounting to an annual loss of about 0.8% and a total loss over the decade of tropical forests of almost three times the size of France. Alarming as these figures are, it is difficult to determine whether 1970–80 rates of loss were significantly different from the 1970s because FAO used different methodologies in its later assessments. FAO also reports that the area of tropical forest plantations increased from 18 million ha in 1980 to more than 40 million ha in 1990, with about three-quarters found in Asia.

Temperate closed forests are thought to be in a relatively stable state at present, or even showing a slight increase (WRI 1994), although Dudley (1992) warns that this general trend obscures some important regional variations and significant losses in old-growth forests.

Since tropical forests are thought to contain at least 50% of the species of the globe, it is hardly surprising that much attention has been focused on tropical deforestation rates and species extinction.

The documented evidence of species extinction through tropical forest loss is, however, limited and although much controversy surrounds the likely level of extinctions (see Section 4.3 and various papers in Whitmore and Sayer 1992) it is generally agreed that disturbance of forests will

alter the relative frequency of animal and plant species and, where severe, disturbance will cause a 'commitment to extinction' although the time to reach the new equilibrium state is unknown (Heywood and Stuart 1992; Reid 1992).

Deforestation has three major effects: habitat loss; habitat fragmentation; and edge effects at the boundary zone between forested and deforested areas (Skole and Tucker 1993). The data presented by these authors on deforestation in the Brazilian Amazon emphasizes the relative importance of the edge effect which may extend 1 km into adjacent forest resulting in a net loss of 'interior' plant and animal species in the edge area which may be occupied by a different suite of species (Turner *et al.* 1991). Skole and Tucker's figures indicate that simply looking at deforested areas alone masks the broader effects: deforestation affected a total of 230 324 km² in their study areas, creating 16 228 km² of isolated forest and an edge effect covering 341 052 km², resulting in a total area affected by deforestation activities of 587 604 km².

Deforestation is a dramatic alteration of habitat but many other levels of degradation, not considered as deforestation, can lead to long-term and perhaps permanent changes in species composition. Logging for international and domestic consumption, although only one of the causes of forest destruction, has proved to be of great importance because it opens up the forest to further encroachment by agricultural settlers, in itself believed to be the single greatest cause of forest destruction (Poore and Sayer 1991; Callister 1992).

Logging activities have both direct and indirect effects on biodiversity. Loggers are usually selective in their choice of species and, although extinction of exploited timber species has not been documented, Oldfield (1988) gives examples of several island endemic species that are on the brink of extinction and lists 41 other timber species

Table 11.2-5: Causes of tree mortality during logging (from Johns 1992).

	Percentage Loss of trees (>30 cm girth)				
	Ponta da Castanha, Brazil	Nigeria	S. Tekam, Malaysia	S. Pagai, Malaysia	G. Tebu, Malaysia
Killed					
Timber trees	0.6	1	3	8	10
Destroyed during construction of access roads and landing sites, etc.	60.4	25	8	46	55
Destroyed during felling and dragging			39		
Remaining	39	74	49	46	35

which are considered endangered as a result of their exploitation. Kemp (1992) stresses the importance of losses in genetic diversity in target species as a result of selective logging. The removal of timber trees is only a relatively minor consequence of logging and Johns (1992) documents the much higher losses of non-target trees as a result of access roads, landing sites and inadvertent destruction during felling and dragging (Table 11.2-5).

It is difficult to generalize on the effects of logging since so much depends on the intensity of logging and on the response of different animal and plant species to disturbance. Certain groups are highly sensitive to disturbance (e.g. amphibians, Johns 1985; termites, Collins 1980) and tend to disappear or show a reduction in species diversity after logging. Diversity also declines in forest avifauna that are specialized feeders (Johns 1985) and for many mammals there is a marked decline in abundance (Collins *et al.* 1991). However, some species withstand the effects of logging well (e.g. some primates) and of course plant diversity may increase soon after logging activities as a result of growth of pioneer species which germinate quickly to fill the gaps created by logging, thus altering the

species composition of the area (Johns 1985). Johns (1992) documents the successful recolonization of logged areas, although this may take many years and depends on there being a source of colonists in nearby unlogged forest (thus highlighting the importance of unlogged 'refuges' in managed tropical forests).

Totally protected areas cover only about 5% of the tropical forest biome and are therefore not sufficient to ensure the conservation of biological diversity (Sayer and Wegge 1992) but there is a broad consensus that it is technically possible to manage tropical forests for timber and other forest products and maintain considerable biological biodiversity if there is a political will to do so.

Temperate forests account for around 50% of global forest cover but, because of their lower diversity when compared with tropical forests, are generally not the focus of so much attention. Although their current status is considered stable this masks significant losses, particularly in Asia, and also the continuing loss of old growth temperate forest globally (Dudley 1992). Old growth forests, although not as diverse as their tropical counterparts, are frequently the richest habitats in the regions in which they occur and their rate of loss in some areas is faster than the loss of tropical forest in most countries (Dudley 1992). In addition, some temperate forests represent areas of biological diversity of global significance with high levels of endemism (for example in the old growth forests of New Zealand and Chile).

In western Europe, old growth forest represents less than 1% of total forest area, large-scale deforestation having taken place in historical times, and probably only Canada and New Zealand among the temperate countries retain more than 20% of total forest area as old growth forest (Table 11.2-6).

Trends similar to those discussed for agriculture are transforming diverse forest ecosystems into high-yielding monocultural tree plantations – some of which now resemble a field of maize as much as a natural forest – and even fewer tree genes than crop genes have been preserved off-site as an insurance policy against disease and pests (Chaney and Basbous 1978; MacKenzie 1986; Vitousek *et al.* 1987; Janzen 1988; Reid and Miller 1989; Schneider 1989; Thorsell 1990).

Although available figures show considerable variation, Sawyer (1993) estimates that there are currently 100 – 135 million ha of plantations world-wide roughly divided 25–75% tropical – temperate. As more plantations are developed to help alleviate the fuelwood crisis in certain countries, relatively more plantations will be developed in tropical areas. Plantations are highly variable: they may be monoculture or mixed; composed of indigenous or exotic species; large-scale or small-scale; structurally complex or simple. These parameters have important effects on their levels of biodiversity.

Table 11.2-6: Proportion of old growth forest remaining in selected temperate forest countries (from Dudley 1992).

Country/Region	% of old growth forest
USA	15
Washington and Oregon	13
Canada	52
British Columbia	40
Europe	
Western Europe	1
Scotland	1
Sweden	1
Finland	2
Norway	3
Oceania	
New Zealand	25
Australia ¹	5
Australia	21
Asia	
China	1

1. Australian figures vary widely. The Resource Assessment Commission, in their massive 1991 study, concluded that around half of the original forest resource had been felled and that 42% of forest was unlogged, so a figure of 21% has been suggested according to their calculations. However, WRI calculated just 5%, using figures from Wells *et al.* (1984).

Table 11.2-7: Habitat and human disturbance by continent (after Hannah et al. 1994).

Continent	Total Area(km ²)	Undisturbed %	Partially Disturbed %	Human Dominated %
Europe	5 759 321	15.6	19.6	64.9
Asia	53 311 557	42.2	29.1	28.7
Africa	33 985 316	48.9	35.8	15.4
North America	26 179 907	56.3	18.8	24.9
South America	20 120 346	62.5	22.5	15.1
Australasia	9 487 262	62.3	25.8	12.0
Antarctica	13 208 983	100.0	0.0	0.0
World total	162 052 691	51.9	24.2	23.9
World total reduced by area of rock, ice and barren land	134 904 471	27.0	36.7	36.3

Plantation forestry often creates artificially homogenous forests with one or a few tree species with individuals of the same size and age, like the cultivated monocultures of agriculture. Some forest plantations may use indigenous tree species, which will retain some of the natural biodiversity of the area through predators, parasites and symbionts of the tree species. But compared to a diverse community of trees, the plantation monoculture will simplify the other components of the ecosystem, not least the structure, fauna and flora of the soil. When industrial tree plantations are based on exogenous species, much of the native biodiversity is inevitably lost, especially through the active suppression of competing species, parasites, etc., through spraying with biocides or other actions (Maser 1988). Although plantations can be managed to maximize species diversity they are unlikely to attain the biodiversity levels of natural forest and should not be regarded as an alternative to natural forests but rather as complementary to them.

11.2.2.3 Habitat loss and fragmentation

Habitat destruction is widely considered the most pervasive anthropogenic cause of the loss of biodiversity (Brown 1985; Wilson 1985; Myers 1988). McCloskey and Spalding (1989) produced a quantitative analysis of the global distribution of 'undisturbed ecosystems'. However, they defined 'undisturbed' simply in terms of roadless areas in chunks of greater than 400 000 ha. Hannah *et al.* (1994) carried this effort further and reduced its mapping units to 100 000 ha (Table 11.2-7). They concluded that 73% of the world's land surface other than rock, ice, and barren land is either human-dominated (36.3%) or partially disturbed (36.7%), while 27% is 'undisturbed'. However, it is clear that no part of the world can be considered truly 'undisturbed'. The world's habitats have been so

significantly modified by human action that such terms as 'native ecosystem', 'undisturbed', or 'virgin forest' are of little practical utility (Thomas 1956; Balée 1985; Roosevelt 1989; Turner *et al.* 1990; Gómez-Pompa and Kaus, 1992; Meyer and Turner 1992; Fairhead and Leach 1993; McNeely 1994). MacKinnon and MacKinnon (1986a, b) estimate that 65% of the original ecosystems south of the Sahara have been subject to major ecological disturbance, and 68% of the natural habitat has been lost in the Indo-Malayan nations (Table 11.2-8). In freshwater ecosystems, dams have destroyed large sections of river and stream habitat. In marine ecosystems, coastal development has wiped out reef and nearshore communities.

Human impacts on habitats take two main forms: conversion from one habitat type to another; and modification of conditions within a habitat type (Meyer and Turner 1992). No general assessment of human impacts on habitats is available at any detailed scale, but as a broad-scale surrogate, land cover is frequently used by various global assessments (e.g. WRI 1994). Conversion of one category of land cover to another is better documented and more readily monitored than modification within a category, but most global classifications are so broad that they mask a number of important forms of land-cover modification, such as forest thinning, replacement of old forest with tree plantations, intensification of cultivation, and severe overgrazing of rangelands. This problem is especially apparent in the UN Food and Agriculture Organization's *Production Yearbooks*, which use four broad classes: forest/woodland; permanent pasture; cultivation; and 'other lands'. Further, the statistics contained are simply those reported by FAO member states, so quality is widely variable and sometimes politically motivated. An alternative approach is based on climate modelling and carbon storage (Matthews 1983;

Richards 1990). Such approaches deal with ecosystem modification as well as conversion, but the categories used are still extremely broad. While issues of data quality and comparability make global-scale assessments of land-use change difficult, Meyer and Turner (1992) have presented a useful summary of available information (Table 11.2-9).

Forests are the most species-rich terrestrial habitats (Maser 1988; Whitmore and Sayer 1992), but assessing human impacts on global forest cover is made more difficult by multiple definitions of 'forest'. Meyer and Turner (1992) summarize available information by estimating that about 29 million km², or 21% of the world's land area, is covered in closed forest, while 'open woodland', an ill-defined category that overlaps significantly with other standard cover types, adds about 18 million km² to the total. The estimated original 62 million km² of forest and woodland in pre-agricultural times has been reduced by 9 million km², of which 7 million represents loss of closed forest, a net global decrease of about 15%. While estimates of contemporary forest change vary considerably and are hampered by problems of data, definition, and method (Myers 1989; WRI 1994), the broad pattern is one of stability or even net gain in temperate

Table 11.2-8: Human impact on habitats: conversion.

	Original wildlife habitat (km²)	Amount remaining (km²)	Habitat loss (%)
(A) In Indo-Malayan nations (Mackinnon and Mackinnon 1986a)			
Bangladesh	1 142 777	68 567	94
Bhutan	34 500	22 770	34
Brunei	5 764	4 381	24
Burma	774 817	225 981	71
China	423 066	164 996	61
Hong Kong	1 066	32	97
India	3 017 009	615 095	80
Indonesia	1 446 433	746 861	49
Japan	320	138	57
Kampuchea	180 879	43 411	76
Laos	236 746	68 656	71
Malaysia	356 254	210 190	41
Nepal	117 075	53 855	54
Pakistan	165 900	39 816	76
Philippines	308 211	64 724	79
Sri Lanka	64 700	10 999	83
Taiwan	36 961	10 719	71
Thailand	507 267	130 039	74
Vietnam	332 116	66 423	80
Total	8 169 860	2 487 683	68
(B) In Afrotropical nations (Mackinnon and Mackinnon 1986b)			
Angola	1 246 700	760 847	39
Benin	15 800	46 320	60
Botswana	585 400	257 576	56
Burkina Faso	273 800	54 760	80
Burundi	25 700	3 598	86
Cameroon	469 400	192 454	59
Central African Rep.	623 000	274 120	56
Chad	720 800	172 992	76
Congo	342 000	172 420	49
Côte d'Ivoire	318 000	66 780	79
Djibouti	21 800	11 118	49
Equatorial Guinea	26 000	12 740	51
Ethiopia	1 101 003	30 300	70
Gabon	267 000	173 550	35
Gambia	11 300	1 243	89
Ghana	230 000	46 000	80
Guinea	245 900	73 770	70
Guinea Bissau	36 100	7 942	78
Kenya	569 500	296 140	48
Lesotho	30 400	9 728	68
Liberia	111 400	14 482	87
Madagascar	595 211	148 803	75
Malawi	94 100	40 463	57
Mali	754 100	158 361	79
Mauritania	388 600	73 834	81
Mozambique	783 203	36 776	57
Namibia	823 200	444 528	46
Niger	566 000	127 880	77
Nigeria	919 800	229 950	75
Rwanda	25 100	3 263	87
Senegal	196 200	35 316	82
Sierra Leone	71 700	10 755	85
Somalia	637 700	376 243	41
South Africa	1 236 500	531 695	57
Sudan	1 703 000	510 900	70
Swaziland	17 400	7 656	56
Tanzania	886 200	505 134	43
Togo	56 000	19 040	66
Uganda	193 700	42 614	78
Zaire	2 335 900	1 051 155	55
Zambia	752,600	534 346	29
Zimbabwe	390 200	171 688	56
Total	20 797 441	8 340 920	65

Table 11.2-9: Global human-induced conversions in selected land covers (Meyer and Turner 1992; WRI 1994).

Cover	Date	Area (10 ⁶ km ²)	Date	Area (10 ⁶ km ²)	Percentage change
Cropland	1700	2.65	1990	14.41	+543.0
Irrigated cropland	1800	0.08	1989	2.00	+2400.0
Closed forest	pre-agricultural	46.28	1983	39.27	-15.1
Forest and woodland	pre-agricultural	61.51	1983	52.37	-14.9
Grassland/pasture	1700	68.60	1980	67.88	-1.0
Lands drained			1985	1.606	
Urban settlement			1985	2.47	
Rural settlement			1990	2.09	

countries and rapid loss in the developing tropics, adding up to an annual net global loss of 100 000–200 000 km² in recent years. Deforestation affects biodiversity through destruction of habitat, isolation of fragments of formerly contiguous habitat, edge effects within a boundary zone between forest and deforested areas (Skole and Tucker 1993), and a variety of other mechanisms (Grainger 1992) (Box 11.2-5). In the boundary zone, edge effects lead to a net loss of plant and animal species through greater exposure to winds, increased micro-meteorological differences over short distances, and easier access for livestock, other non-forest animals, and hunters.

Brazil has the largest remaining area of tropical forest, but it too is under human pressure. Skole and Tucker (1993) used Landsat satellite imagery covering the entire forested portion of the Brazilian Amazon Basin to measure habitat loss and fragmentation in 1978 and 1988. They found that deforestation increased from 78 000 km² in 1978 to 230 000 km² in 1988, while habitats severely affected with respect to biodiversity increased from 200 000 to 588 000 km². Although this rate of deforestation is lower than other estimates, the effect on biological diversity is greater than just the loss of forest. Skole and Tucker found that the geometry of deforestation is critical to the estimation of forest fragmentation and the edge effect. If 100 km² of tropical deforestation occurs as a 10 km × 10 km² block and it is assumed that the edge effect is 1 km, the total area affected is about 143 km². But if the 100 km² of deforestation is distributed as 10 strips, each 10 km × 1 km, the affected area is about 350 km². They found that the largest contributor to negative effects on biological diversity was the 1 km edge effect from adjacent areas of deforestation, while isolation of forest patches was not a large contributor. While the rate of deforestation averaged about 15 000 km² per year in the Brazilian Amazon from 1978 to 1988, the rate of habitat fragmentation and degradation was about 38 000 km² per year.

The distribution and extent of grassland is controlled by

climate, soil and fire, the last of which represents a significant long-standing human impact (Hough 1926; Thomas 1956). The world area of grassland and pasture in 1700 is estimated at 68.6 million km², a figure that is nearly identical with that of today (Richards 1990). Factors affecting the global area of grassland have thus maintained a rough balance over the past 300 years, with loss through

Box 11.2-5: The consequences of tropical deforestation for biodiversity (modified after Grainger 1992).

1. Reduced diversity of species and genes
 - (a) Species extinctions
 - (b) Reduced capacity to breed improved crop varieties
 - (c) Inability to make some plants economic crops
 - (d) Threat to production of minor forest products
2. Changes affecting local and regional ecosystems
 - (a) Soil degradation
 - (b) Changes in water flows from catchments
 - (c) Changes in buffering of water flows by wetland forests
 - (d) Increased sedimentation of rivers, reservoirs, etc.
 - (e) Possible changes in rainfall characteristics
3. Changes affecting the global ecosystem
 - (a) Reduction in carbon stored in the terrestrial biota
 - (b) Increase in carbon dioxide content of the atmosphere
 - (c) Changes in global temperature and rainfall patterns by greenhouse effects
 - (d) Other changes in global climate due to changes in land surface processes

Table 11.2-10: Extent of desertification in rangelands within the drylands of the world (thousand ha) (from UNEP 1991).

Continent	Slight to none	Moderate	Severe	Very severe	Total moderate, severe and very severe	Percentage desertified
Africa	347 265	273 615	716 210	5 255	995 080	74
Asia	383 630	485 221	691 602	10 787	1,187 610	75
Australia	295 873	277 040	55 310	29 000	361 350	55
Europe	31 053	27 372	51 937	1 208	80 517	72
North America	71 987	116 102	284 858	10 194	411 154	75
South America	93 147	88 007	184 431	15 316	297 754	76

conversion to cropland being balanced by gain through deforestation. The global pattern has been significant grassland decrease in Europe, North America, and Southeast Asia, matched by increases in Latin America and tropical Africa (Meyer and Turner 1992).

It is difficult to generalize on the effect of these changes on grassland biodiversity since it is such a varied habitat with important distinctions between wet and dry grasslands, acid, base and neutral grasslands, etc. However, at least within Europe, a broad generalization is that the wildlife value of grasslands is likely to diminish as the intensity of production increases. Thus drainage, use of fertilizers and pesticides, greater densities of livestock and conversion from hay-making to silage are all likely to reduce biodiversity. In Europe the general consensus is that unimproved, extensively managed grasslands have declined sharply in recent decades as a result of more intensive management, conversion to arable land and a range of other uses (Balduck 1990). While difficult to generalize on the overall losses in biodiversity, the 164 species of dry grassland plant species threatened with extinction in Germany (Wolking and Plank 1981) and the fact that grassland specialists make up 40% of the bird species listed as vulnerable in Europe (Devillers 1988) attest to the probable effects.

Grasslands are subject to alteration to desert-like conditions under excessive human pressure. The 1977 UN Conference on Desertification identified 6% of the world's area as 'man-made deserts', with a quarter of the world's surface threatened by desertification. The annual degradation of land to 'desert-like conditions' was estimated by UNEP as 60 000 km² and the area annually reduced to zero or negative net economic productivity amounted to 200 000 km² (Rapp 1977; Mabbutt 1985) (Table 11.2-10).

It is currently believed that many tropical and subtropical grasslands are maintained by fire. A significant component in this dynamic is human-induced fires that increase fire frequency. Because of the long history of fire use, human

impact has probably contributed to the present ecosystem structure and function. Recent views on the prairies in North America interpret them in part as semi-natural ecosystems maintained by grazing of wild animals and by fires set by the native Americans (Delcourt *et al.* 1993). The absence of human-induced fires and of big grazers leads to significant shifts in the structure and functions of those ecosystems, as has been demonstrated in the prairie ecosystems of United States (Pyne 1982). Another example is the present savannah ecosystem of Cuba, which has been shown to be a product of long-term human impact by combined cutting, burning and grazing (Borhidi 1988).

Even some desert ecosystems have been shaped by human-induced fires. Burrows and Christensen (1994) have concluded that the relatively high plant diversity in the Australian desert is due largely to the activities of aborigines who used fire extensively for many purposes (including increase of food resources) over vast tracts of the Australian desert for thousands of years. With the departure of aborigines to settlements in the 1960s and the resultant decrease in the frequency of fires, plant diversity (and probably mammal diversity also) has been substantially reduced (Figure 11.2-4).

Biswas (1994) has compiled information on land degradation in drylands of the world, concluding that some 30% of irrigated lands, 47% of rainfed croplands, 73% of rangelands and 69% of agriculturally-used drylands have been degraded (Table 11.2-11). However, little information is available on the relationship between degradation of drylands, habitat loss and loss of biodiversity.

Some of the most diverse, dynamic and complex wetland ecosystems are comprised of natural rivers and their riparian zones. Given the dependence of most forms of life on water, river systems and their riparian zones are especially important in the regulation and maintenance of biodiversity, playing a fundamental role in the movement of organisms and other nutrients. These habitats have significant ecological interactions with the sea, the atmosphere, and the terrestrial surroundings of the river

Table 11.2-11: Global status of land degradation in drylands of the world (Biswas 1994).

Continent	Irrigated lands		Rainfed croplands			Rangelands		Total agriculturally used drylands				
	Total 10 ⁶ ha	Degraded		Total 10 ⁶ ha	Degraded		Total 10 ⁶ ha	Degraded		Total 10 ⁶ ha	Degraded	
		10 ⁶	%		10 ⁶	%		10 ⁶	%		10 ⁶	%
Africa	10.42	1.90	18	79.82	48.86	61	1342.35	995.08	74	1432.59	1045.84	73.0
Asia	92.02	31.81	35	218.17	122.28	56	1571.24	1187.61	76	1881.43	1341.70	69.7
Australia	1.87	0.25	13	42.12	14.32	34	657.22	361.35	55	701.21	375.21	53.6
Europe	11.90	1.91	16	22.11	11.85	54	111.57	80.52	72	145.58	94.28	64.8
N. America	20.87	5.86	28	74.17	11.61	16	483.14	411.15	85	578.18	428.62	74.1
S. America	8.42	1.42	17	21.35	6.64	31	390.90	297.75	76	420.67	305.81	72.7
Total	145.50	43.15	30	457.74	215.56	47	4556.42	3333.46	73	5159.66	3592.17	69.0

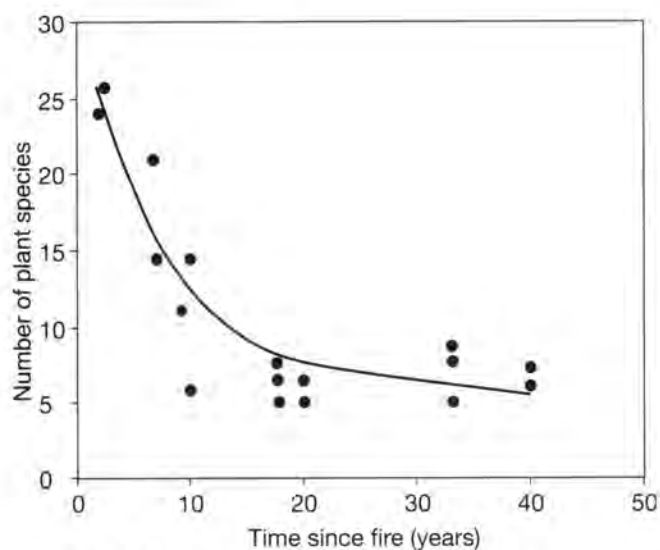
**Figure 11.2-4:** Numbers of plant species within a 100-metre radius plot with time since last fire in desert vegetation near Lake Mackay, Western Australia (from Burrows and Christensen 1990).

(Naiman 1992). Riverine systems have been profoundly influenced by damming, channelization, and other engineering works that reduce their diversity and dynamism. As of 1988, some 39 000 large dams had been constructed, creating reservoirs larger in total than the area of California or France (International Commission on Large Dams 1988); more than 100 dams with heights greater than 150 metres have been constructed, creating reservoirs that cover 600 000 km² (an area greater than the North Sea) and have a capacity of 6000 km³ equivalent to 15% of the annual runoff of the world's rivers (Pierce 1992). The reservoirs created by dams therefore represent substantial new aquatic habitats, though these tend to be occupied by common and widespread species. The new

reservoirs also tend to replace much more diverse habitats, including waterfalls, rapids and floodplain wetlands, leading to the loss of the numerous species of plants and animals specific to running waters (Dynesius and Nilsson 1994). As a result of habitat destruction and obstruction to the dispersal of fish and other organisms, many riverine species may have been extirpated over large areas and others have become fragmented and therefore more prone to future extinction.

While dam construction is the most obvious human intervention leading to the loss of wetland habitats, other engineering works also cause problems. For example, straightening rivers decreases the retention of matter and energy, and naturally functioning floodplains provide wildlife habitat and help reduce or buffer non-point-source pollution (Petts 1984).

Wetlands – including estuaries, mangroves, open coasts, floodplains, freshwaters (streams and rivers), lakes, peatlands, and swamps – have been lost due to a wide range of factors (Table 11.2-12).

The industrialized countries have had an especially profound impact on rivers. Dynesius and Nilsson (1994) found that 77% of the total water discharge of the 139 largest river systems in North America north of Mexico, Europe and the Republics of the former Soviet Union is strongly or moderately affected by fragmentation of the river channels by dams and by water regulation resulting from reservoir operation, inter-basin diversion and irrigation. Rivers are also being influenced through human activities in their catchments, which are being influenced by embankments, draining, deforestation, urbanization and industry (Turner *et al.* 1990). The remaining free-flowing large river systems are relatively small and nearly all situated in the far north, as are the 59 medium-sized river systems of Scandinavia. Modifications to riverine systems

Table 11.2-12: Human actions leading to wetland loss (modified after Dugan 1990).

	Estuaries	Mangroves	Open coasts	Floodplains	Freshwater	Lakes	Peatlands	Swamp
Drainage for agriculture, forestry, and mosquito control	●	+	●	●	●	+	●	●
Dredging and stream channelization for navigation and flood protection	●	●	○	□	+	○	○	○
Filling for solid waste disposal, roads, and commercial, residential and industrial development	●	●	+	+	+	+	□	□
Conversion for aquaculture/mariculture	●	●	●	●	●	+	○	○
Construction of dykes, dams, levees, and seawalls for flood control, water supply, irrigation and storm protection	●	●	●	●	●	●	○	○
Discharges of pesticides, herbicides, nutrients from domestic sewage and industrial waste waters, agricultural runoff and sediment	●	●	●	●	●	●	○	○
Mining of wetland would for peat, coal, gravel, phosphate and other materials	+	○	+	+	○	●	●	●
Logging and shifting cultivation	+	●	○	●	+	○	●	●
Groundwater abstraction	○	○	○	+	●	○	○	○
Fires	+	+	○	●	+	○	●	●
Sediment diversion by dams, deep channels and other structures	●	●	●	●	●	+	○	○
Hydrological alterations by canals, roads and other structures	●	●	●	●	●	●	+	+
Subsidence due to extraction of groundwater, oil gas and other minerals	●	○	+	●	●	○	○	○

Key: ○ = Absent or exceptional; + = Present, but not a major cause of loss;
● = Common and important cause of wetland degradation and loss.

include three major effects on biodiversity: the habitats for organisms adapted to natural discharge and seasonal water-level regimes are impoverished; the role of each river as a corridor is reduced; and the riparian zone is no longer able to serve effectively as a filter between upland and aquatic systems (Dynesius and Nilsson 1994). The available data indicate that many types of riverine ecosystem have been lost and that the populations of many riverine species have become highly fragmented, possibly with profound implications on biodiversity.

While it is well known that riverine faunas have been reduced due to the factors outlined above, it is too early to tell whether the faunas have reached a new equilibrium or whether additional losses are to be expected. The time needed for re-equilibration of ecosystems is undoubtedly longer than the relatively few decades over which rivers have been significantly regulated by dams and diversions (Dynesius and Nilsson 1994).

Many other wetland habitats have also been lost, judging from the available data. The USA has lost at least 54% of

its original wetlands, while losses in European countries range from 60% to 90% (Dugan 1990). In developing countries, especially in Asia, ricefields have replaced many of the natural wetlands – the loss may amount to as much as 1.3 million km² (Tolba *et al.* 1992). While coastal wetlands have not been lost at such a high rate, many mangroves have been replaced by shrimp ponds; while global figures are not available, the Philippines have lost over two-thirds of their mangroves and Thailand has lost 40% (Tolba *et al.* 1992).

Coral reefs are another highly diverse wetland ecosystem type that has been profoundly influenced by human activity. While reliable global data are scarce due to lack of field research, Wilkinson (1993) has reviewed data from many parts of the world to conclude that coral reefs of the world are declining so rapidly that localized extinctions are probable. The major threats to reefs come from anthropogenic pollution, sedimentation and over-exploitation, all of which are increasing with increasing human economic activity. While coral reefs are highly

resilient and are unlikely to be adversely affected by climate change (Wilkinson and Buddemeier 1994), they are vulnerable to chronic stress from sources such as pollution. While data are sparse, Wilkinson (1993) concludes that 10% of the coral reefs of the world have already been degraded beyond recognition; 30% are in a critical state such that they will be lost or severely damaged within the next 10 to 20 years; another 30% will be grossly damaged in 20 to 40 years; and about 30% appear likely to remain healthy into the far distant future. The status of coral reefs is clearly responsive to human management action (Phongsuwan and Chansang 1993; Lidell and Ohlhorst 1993).

More generally, a decline in biodiversity has been associated with specific land-use changes associated with economic development, such as power line construction (Nickerson *et al.* 1989), urbanization (Leidy and Fiedler 1985), colonization adjacent to protected areas (Neumann and Machlis 1989), and forest fragmentation (Harris 1984; Hanson *et al.* 1990). However, economic development in urban and peri-urban habitats does not invariably mean loss of all of the original biodiversity and, in addition, new habitats such as urban parks, urban forests, urban wetlands, domestic gardens, roadside plantings, etc. may result in increases in both population densities (in certain species) and local biodiversity (Tables 11.2-13 and 11.2-14). Urban

Table 11.2-13: Impact of urbanization on biodiversity: dependence of bird biomass and diversity on urbanization in Finland (Nvorteva 1971; Goudie 1993).

	City (Helsinki)	Near rural houses	Uninhabited forest
Biomass (kg/km ²)	213	30	22
No. of birds (km ²)	1089	371	297
Number of species	21	80	54

Table 11.2-14: Population estimates of birds in different habitats (from McClure 1969).

Place	Habitat	Birds per 40 ha
Kuala Lumpur	Urban and gardens	1100
Subang	Secondary forest	450
Rantau Panjang	Cococut plantation and mangrove	800
Ulu Gombak Forest Reserve	Extraction track in logged forest	400
Ulu Gombak	Virgin jungle reserve	400

biodiversity is discussed in greater detail in 11.2.3.3 and Section 13.3.8.1.

In conclusion, habitat loss clearly has been a major proximate cause of the loss of biodiversity, though surprisingly little accurate information on habitat loss is available globally. Changes in the distribution and quality of most habitat types are difficult to determine, even with the availability of satellite imagery. The problem is especially difficult in developing countries due to problems such as inadequate ground-truthing, less comprehensive satellite coverage, and the difficulties in identifying and classifying regional habitat types (Sisk *et al.* 1994).

11.2.2.4 Indirect negative effects of species introduced by humans

11.2.2.4.1 Introduction. As early as 1958 Elton recognized the effect of invasive species as 'one of the great historical convulsions in the world's fauna and flora'. The history of invasions is of course older than the history of humankind, some mixing of species certainly occurring without human intervention, but this section is concerned only with human-induced invasions of species. Historical aspects of invasions were dealt with in Chapter 11.1.

Species are introduced into alien habitats by people for a number of reasons. Levin (1989) identified three major categories: (1) accidental introductions; (2) species imported for a limited purpose which then escape, and (3) deliberate introductions. Many of the introductions relate to the human interest in providing species that are especially helpful to people. This is particularly true of agricultural species; indeed, in most parts of the world, the great bulk of human dietary needs are met by species that have been introduced from elsewhere (Hoyt 1992). Species introductions in this sense, therefore, are an essential part of human welfare in virtually all parts of the world. Further, maintaining the health of these introduced species of undoubted benefit to humans may require the introduction of additional species for use in biological control programmes which import natural enemies of, for example, agricultural pests (Waage 1991).

As a biodiversity issue it is not always possible to identify invasions as inherently 'bad'; di Castri (1989) asserts that overall, the central European flora has undergone an enrichment of diversity over historical time as a result of human-induced plant invasions. Britain's mammalian fauna totalling about 49 species includes some 21 introduced species, including eight large mammals (wild goat *Capra hircus*, fallow deer *Dama dama*, Sika deer *Cervus nippon*, Indian muntjak *Muntiacus muntjak*, Chinese muntjak *Muntiacus reevesi*, Chinese water deer *Hydropetes inermis*, Bennett's wallaby *Macropus rufogriseus bennetti*, reindeer *Rangifer tarandus*). It is thus highly likely that, due to human influence, the mammalian fauna of Britain is more species-rich now than at any time

Table 11.2-15: Known numbers of invasive and native species in various countries/areas.

Country/area	Number of native species	Number of invasive species	Source
Australia (plants)	15 000–20 000	1500–2000	Groves 1986
New Zealand (plants)	1790	1570	Heywood 1989
Hawaii (plants)	956	861	Wagner <i>et al.</i> 1990
Tristan de Cunha (plants)	70	97	Moore 1983
Campbell Island (plants)	128	81	Moore 1983
South Georgia (plants)	26	54	Moore 1983
Southern Africa (freshwater fish)	176	52	De Moor and Bruton 1988; Bruton & Van As 1986
California (freshwater fish)	83	50	Moyle 1976

since the Neolithic. The genetic diversity of this fauna is very high, including species originating from Asia, North America, Europe and Australia (Jarvis 1979). Jacobs (1975 in Goudie 1993) provides the example of the transformation of the saline Lake Nakuru from an ecosystem of very low diversity (a large population of flamingoes, two species of algae and a few invertebrate species) to one of much higher diversity (including 30 species of fish-eating birds) after the introduction in 1961 of a fish, *Tilapia grahami*, to control mosquitoes.

Despite some positive effects on biodiversity at the local level, however, overwhelming evidence indicates negative effects on species and genetic diversity at both the local and global level. Such introductions can lead to severe disruption of ecological communities (Smith 1972; Zaret and Paine 1973; Mooney and Drake 1986; Drake 1989; Carlton and Geller 1993), and heavily influence the genetic diversity of indigenous organisms. Some protected areas established to conserve native species have been profoundly affected by introduced species (Bratton 1982) and on some islands introduced species closely match or even outnumber native ones (Table 11.2-15). Globally almost 20% of the vertebrates thought to be in danger of extinction are threatened in some way by invasive species (Table 11.2-16). The single biggest tragedy is the probable loss of at least 200 of the 300 endemic cichlid species in Lake Victoria as a result of the introduction of the Nile perch, *Lates niloticus* (Lowe-McConnell 1993). This was exacerbated by eutrophication of the lake and the introduction of new fishing gear. The global effects of certain invasive species such as the European pig, *Sus scrofa* (Oliver 1994), rats, *Rattus* spp. (Atkinson 1985; Stuart and Collar 1988; Brockie *et al.* 1989) and two aquatic plants, *Salvinia molesta* and *Eichhornia crassipes* (Ashton and Mitchell 1989) also attest to their widespread effects.

11.2.2.4.2 Introduced species and their distribution. Although the absolute number of invasive species is an unknown (Heywood 1989; Carlton 1989) an order of

magnitude estimate is possible. From the range of data on invasive species in Table 11.2-16 it is clear that many thousands of species are involved (and from a much wider range of organisms than is shown here). However, they still constitute a relatively small proportion of total species diversity (Macdonald 1992).

Invasives have been found in almost every part of the world (with the possible exception of Antarctica (Macdonald *et al.* 1989 quoting Usher pers. comm.). At least some invasive species have been found in a wide range of nature reserves surveyed by Macdonald *et al.* (1989), covering eight of the 14 terrestrial biomes identified by Udvardy (1975). Lake and river systems have also been seriously affected (Zaret and Paine 1973; Barel *et al.* 1985; Miller *et al.* 1989; Roberts 1990; Holcik 1991; Allan and Flecker 1993; Lowe-McConnell 1993) and, although less well documented, it is clear that invasives seriously affect nearshore marine environments particularly through accidental introductions in ships' ballast (Carlton 1989; Chew 1990; Carlton and Geller 1993).

It would seem that not all ecosystems are equally affected. Mixed island systems have higher absolute and proportional numbers of invasives than any of the continental biomes; within continental biomes xeric environments (including warm deserts and semi-deserts, tropical dry forests and woodlands) tend to have fewer invasive species; among temperate regions, reserves in the Southern Hemisphere have often experienced severe invasions while those in the Northern Hemisphere seem relatively free of invasions (Loope *et al.* 1988; Usher *et al.* 1988; Macdonald *et al.* 1989).

11.2.2.4.3 Effects of invasive species and ecosystem susceptibility. Much time and effort has been expended in investigating susceptibility of ecosystems to invasions and various factors have been implicated. A key factor in the literature is human-induced disturbance of ecosystems (Elton 1958; Arthington and Mitchell 1986; Brooke *et al.* 1986; Myers 1986; Ashton and Miller 1989; Carlton 1989;

Table 11.2-16: The percentage of threatened terrestrial vertebrate species affected by introductions in the continental landmasses of the different biogeographic realms and on the world's islands. The total number of threatened species in the realm is given in brackets.

	Percentage of threatened species affected by introductions																	
	Eurasia		North America		Africa		Indo-Malaya		Oceania		Australia		South America		All mainland areas		All mainland areas	
	%	(n)	%	(n)	%	(n)	%	(n)	%	(n)	%	(n)	%	(n)	%	(n)	%	(n)
Mammals	16.7	(42)	3.4	(29)	8.0	(100)	12.7	(55)	0.0	(8)	64.4	(45)	10.0	(60)	19.4	(283)	11.5	(61)
Birds	4.2	(24)	13.3	(15)	2.5	(118)	0.0	(30)	0.0	(1)	27.3	(11)	4.2	(71)	5.2	(250)	38.2	(144)
Reptiles	5.9	(17)	16.7	(24)	25.0	(16)	4.3	(23)	14.3	(7)	22.2	(9)	14.3	(28)	15.5	(84)	32.9	(76)
Amphibians	0.0	(8)	6.3	(16)	0.0	(3)	0.0	(0)	0.0	(0)	0.0	(2)	0.0	(1)	3.3	(30)	30.8	(13)
Total for all groups considered	9.9	(91)	9.5	(84)	6.3	(237)	7.4	(108)	6.3	(16)	50.7	(67)	8.1	(160)	12.7	(647)	31.0	(294)

Source: Macdonald *et al.* 1989.

Ramakrishnan and Vitousek 1989; Neiring 1990); but successful invasions of undisturbed ecosystems are also common (Macdonald and Richardson 1986; Ashton and Mitchell 1989; Kruger *et al.* 1989). Ecosystems of low diversity may also be susceptible (Brockie *et al.* 1989; Rejmanek 1989) as well as those without predators, herbivores or competitors (Atkinson 1985; Macdonald and Frame 1988; Loope and Mueller-Dombois 1989; Mack 1989; Macdonald *et al.* 1989). Climatic and edaphic similarity between the invader's new and home environment may also be important (Holdgate 1986; Myers 1986; Diamond and Veitch 1989).

Invasive species are known to have wide-ranging effects on ecosystems, affecting both ecosystem structure and function. They may eliminate native species directly through animal predation or the browsing effects of herbivores as has happened, for example, in fish (Balin *et al.* 1985), molluscs (Wells 1995), and many bird species (Atkinson 1985; Brockie *et al.* 1988).

It is important to note that the many references to global extinctions due to invasives refer to islands or aquatic ecosystems and Macdonald *et al.* (1989) state that there has been no known global extinction of a terrestrial, continental species as a result of an invasive species. However, many examples of local eliminations or species brought to the brink of extinction by invasives can be quoted, including:

- the massive changes in species composition of temperate grasslands in Australia, South America and western North America as a result of the introduction of ungulates which have destroyed native plant communities (Mack 1989);

- the devastating effect of introduced trees and shrubs on the *fynbos* and *karoo* plant formations of South Africa which threaten over 50% of the 1808 plant species known to be under threat and which have caused substantial reduction in the local diversity of native fauna (Breytenbach 1986; Macdonald *et al.* 1989);
- the elimination of the American chestnut *Castanea dentata* as a dominant tree over much of the eastern USA as result of the introduction of the plant fungal pathogen *Cryphonectria* (= *Endothia*) *parasitica* (Elton 1958; von Broembsen 1989), and
- the elimination of the Atlantic salmon *Salmo salar* in more than 30 rivers in Norway as a result of the introduction of the conspecific Baltic salmon for aquaculture purposes. The latter carried the monoengean fluke *Gyrodactylus salaris* which proved to be deadly to the Atlantic salmon (Johnsen and Jensen 1986; Heggberget *et al.* 1993).

Invasive species may also act in concert to threaten native species in a variety of direct and indirect ways. In Australia early European settlement caused severe fragmentation of habitat through the widespread clearance of vegetation (e.g. in the development of Western Australia's wheat-belt) and this alone was responsible for a significant loss in native fauna. However, European settlement also brought with it the rabbit (*Oryctolagus cuniculatus*) and the fox (*Vulpes vulpes*). Rabbits soon reached plague numbers and led to further habitat destruction and failure of regeneration in remnant vegetation. Foxes were also able to reach high numbers

preying on the rabbit population and as a result had a considerable impact on other prey items – native mammals, reptiles, frogs, scorpions and large insect species. Once rabbits reached plague proportions, programmes to poison, fumigate and destroy burrows were introduced, killing rabbits but also inadvertently killing the native bilbies (*Macrotis lagotis*) and bush-tailed possums (*Trichosurus vulpecula*). The introduction of myxomatosis in the 1950s successfully reduced rabbit numbers but forced foxes to turn more to the remaining native species for food. Thus the introduction of these two species and later attempts to control them had a variety of effects on native species (Hobbs and Saunders 1994).

Certain species have been shown to have a range of indirect effects which can have an impact on several species and sometimes whole ecosystems. Invading aquatic macrophytes such as *Salvinia molesta* and *Eichhornia crassipes* (arguably the world's worst aquatic weeds) can spread prolifically by virtue of their rapid growth and relatively high biomass. While they may displace native plant species, they may also impede water flow, inhibit the penetration of light, increase evapotranspiration and alter water chemistry to such an extent that the water body no longer supports a functioning aquatic community (Humphries *et al.* 1994).

Other examples of indirect effects include the probable extinction of the snail *Bulimulus darwini* on the Galapagos Islands as a result of the destruction of its habitat through the effects of introduced goats (Coppo 1995); the reduction in the bird community around Lake Atitlan as a result of the introduction of the predatory fish species *Cichla ocellaris* which dramatically altered the trophic structure of the lake (Zaret and Paine 1973); and the prevention of recruitment of holly and oak trees in Ireland through the shading and impenetrable litter layer produced by the introduced *Rhododendron ponticum* (Usher *et al.* 1986).

Another serious effect at the ecosystem structure level is the genetic effect on species through hybridization or serious losses in genetic diversity. Invasive hybridization with local species has been recorded in ducks, wild cats, donkeys, fish, birds and grasses (Moyle 1976; Brooke *et al.* 1986; Macdonald *et al.* 1989; Holcik 1991; Ryman 1991; Hammer *et al.* 1993).

The consequences of invasions on ecosystem function are generally less well studied than those on ecosystem structure (Ramakrishnan and Vitousek 1989). This is an equally vital area since such changes can alter the conditions of life for all of the organisms in an ecosystem, often to the detriment of many native species. Effects of invasive species on ecosystems can alter soil erosion rates and other geomorphological processes (affecting such ecosystems as sand dunes, rivers, estuaries etc.), biogeochemical cycles, hydrological cycles, nutrient cycles

and fire regimes (Macdonald and Jarmen 1984; Macdonald *et al.* 1989). In summary, virtually all of the myriad ecosystem functions have been affected by introduced species (Macdonald *et al.* 1989).

11.2.2.4 Recovery of invaded ecosystems. Clearly, where endemic species have been exterminated, as has happened on islands and in aquatic systems, the effect of invasions is irreversible. However, in most cases invasives reduce local diversity or abundance of a given population, or alter community structure, and removal of these invasives is often accompanied by recovery of the biota (Veitch 1985; Brockie *et al.* 1989; Loope *et al.* 1989). However, this can be a very slow process. For example, rabbits and hares were introduced to the atoll of Laysan in the Hawaii group in 1903 as a source of meat for a cannery and within 20 years the number of plant species had fallen from 25 to four. After the extermination of the rabbits and hares, recovery proved to be much slower than destruction: seven years after the extermination of rabbits and hares there were nine plant species and after 38 years the number had risen to 16 (Goudie 1993). North *et al.* (1994) have shown rapid recovery of some native plant and animal species after elimination of non-native goats and rabbits but conclude that since many of the components of the original vegetation have been lost and other non-native species added, the developing ecosystem will inevitably differ from the original. Many invasive species have proved impossible to eradicate (Barel *et al.* 1985; Ashton and Mitchell 1989) or at least extremely difficult and costly to eradicate once well established (Macdonald and Frame, 1988; Macdonald *et al.* 1989). Thus stringent measures to avoid unwanted species in introductions would appear to be justified on both ecological and economic grounds.

An interesting management dilemma arises when existing species respond to the introduced species in certain ways. For example, native giant kangaroo rats (*Dipodomys ingens*) in California continually modify their burrow precincts by digging tunnels, clipping plants and other activities, with this chronic disturbance to soil and vegetation promoting the establishment of introduced early successional plant species such as *Erodium cicutarium*, *Bromus madritensis* and other Mediterranean annuals. Schiffman (1994) found that species richness, cover and frequency of the introduced plants were significantly greater on kangaroo rat precincts; the introduced species had significantly larger seeds than the native species, apparently making them more attractive to the kangaroo rats. This mutualistic relationship, whereby both kangaroo rats and introduced species benefit, presents an intractable management dilemma, possibly making it impossible to restore valley grasslands where endangered giant kangaroo rats occur to conditions where native species dominate.

The general global picture is, then, one of tremendous mixing of species with unpredictable long-term results.

While many introduced species have special cultivation requirements which restrict their spread, many other species are finding appropriate conditions in their new homes while many more may invade their new homes and constantly extend their distribution, thereby representing a potential threat to local species. The future is certain to bring considerable additional ecological shuffling which will have both winners and losers, although the overall effect will probably be a global loss of biodiversity at species and genetic levels.

11.2.2.5 Pollution of soil, water and atmosphere

Pollutants stress ecosystems and may reduce or eliminate populations of sensitive species (Carson 1962). Contamination may reverberate along the food chain: barn owl populations in the United Kingdom have fallen by 10% since new rodenticides were introduced, and illegal pesticides used to control crayfish along the boundaries of Spain's Coto Doñana National Park in 1985 killed 30 000 birds (MacKenzie 1986). Soil microbes have also suffered from pollution as industry sheds heavy metals and irrigated agriculture brings on salinization. Acid rain has made thousands of Scandinavian and North American lakes and pools virtually lifeless, and, in combination with other kinds of air pollution, has damaged forests throughout Europe (Blank 1985; Schindler 1988; Bucher and Bucher-Wallin 1989). Marine pollution, particularly from non-point sources, has defiled the Mediterranean and many estuaries and coastal seas throughout the world, leading to impacts on the reproduction of some marine species (DeLong *et al.* 1973).

The air is polluted mainly from the combustion of fossil fuels in power plants, industry, cars, houses, ships, etc. The main pollutants are carbon dioxide (CO₂), sulphur dioxide (SO₂), nitrogen oxides (NO_x), ammonia (NH₃), ozone (O₃), heavy metals and organic micropollutants. The concentration of CO₂ in the atmosphere is increasing annually by about 2.9 × 10⁹ tonnes (Mooney *et al.* 1987), and may cause a warming of the Earth through the so-called 'greenhouse effect'. The impact of increased CO₂ in the atmosphere is not always negative, as some plants may gain considerable benefits from such increases; but it is apparent that increases in carbon dioxide have systemic effects on plant-insect herbivore interactions (Fajer *et al.* 1989; Freedman 1989). The SO₂, NO_x and O₃ released into the atmosphere may directly affect crops and vegetation including forests (Hutchinson and Meema 1987; Bucher and Bucher-Wallin 1989). SO₂ and NO_x oxidized and converted to strong acids are precipitated and affect terrestrial and aquatic ecosystems negatively, directly by decreasing pH and indirectly by mobilizing toxic metals, especially aluminium (Chia *et al.* 1984; Hildrew *et al.* 1984; Rosseland *et al.* 1990). Heavy metals and organic micropollutants are also toxic by-products decreasing air

quality. In heavily affected areas pollution is a threat to the health of animals, humans included, by the accumulation of toxics through the food chain (Peakall 1975; Porter *et al.* 1984; Reutergårdh 1988; Beryland 1991).

The deposition of airborne pollutants on grasslands can have significant deleterious effects. In southwest Poland, one of the most highly polluted regions in Europe, Breymeyer (1990) showed that the species composition of an area of grassland significantly affected by pollution was highly impoverished, with only three species of grasses making up 75–97% of the plant biomass. Above-ground growth of plants was severely stunted and the soil fauna was decreased in biomass and proportion of large fauna. Particularly noteworthy was the reduction in Oligochaeta which are important for decomposition. Above-ground insects were small and assimilated food less efficiently, consequently needing to consume more plant matter and providing less prey for birds and other predators.

Acid rain has numerous system effects (Eney and Petzold 1987). On poor, acidified soils in the Netherlands, Graveland *et al.* (1994) found that many passerine birds produced eggs with thin and porous shells, leading to high incidence of clutch desertion and empty nests. Eggshell defects were found to be caused by calcium deficiency which in turn is caused by acid deposition. Acidification has also been implicated in greatly increased mortality of moose (*Alces alces*) in Sweden by leading to trace element imbalance, specifically deficiencies in essential trace elements such as copper and chromium (Frank *et al.* 1994).

The employment of chemical fertilizer on a large scale is around 150 years old (Goudie 1993) but the escalation in its use for food production has been most dramatic in the second half of this century, with a rise in world fertilizer use from 14 million to 143 million tonnes between 1950 and 1989. North America and Europe are still the dominant users but the gap is closing as tropical countries, particularly in Asia, develop agricultural practices requiring heavy use of fertilizers (Lean *et al.* 1990). Fertilizers have played a vital role, for example, in India's Green Revolution (Kothari 1994a).

That fertilizers have played an essential part in producing the world's harvests is undisputed: Lean *et al.* (1990) estimate that if the use of fertilizers ceased, the world's agricultural harvests would be cut almost in half. However, the negative side of the equation is that the nitrates from fertilizers seep into groundwater aquifers (a 1984 survey in the USA showed that 8000 out of a sample of 124 000 wells had nitrate levels above that considered safe for human health; Lean *et al.* 1990) and they are seriously implicated in the eutrophication of lakes, rivers and coastal ecosystems, often causing drastic changes in the fauna and flora.

Long-range transported air pollutants are precipitated as dry deposits or as acid rain and snow with negative effects

on soil (chemistry and microflora), crops and forests (e.g. Hutchinson and Meema 1987; MacKenzie and El-Ashry 1989; Likens 1989). Pollutants from the mining industry, organic and inorganic wastes from private and industrial sources, and agricultural activities are deposited, and the negative effects on the biota can be considerable. Construction and use of roads spread dust, road material and heavy metals from gasoline combustion to nearby areas (Watkins 1991).

Organochlorine pesticides (DDT, aldrin, Dieldrin, lindane) were introduced globally in agriculture in the 1950s, at a time when polychlorinated biphenyls (PCBs) were being used increasingly in a wide range of industrial processes. The principal mode of transport may be the atmosphere (Richards *et al.* 1987; GESAMP 1990; Loganathan and Kannan 1994). Organochlorine pesticides are soluble in fatty tissues and are biologically persistent; thus they can accumulate in high concentrations and, as a result of the process of biomagnification, the top predators in an ecosystem tend to contain the highest concentrations. The toxic effects on these species can lead to genetic mutations, breeding problems, infant mortality, impaired immunological functions and even death (Carson 1962; Henny *et al.* 1980; Mason 1989, Loganathan and Kannan 1994; Swart *et al.* 1994). Pollution can have significant impacts on particular species. For example, European mink in northern Spain have over twice the level of PCBs that produce reproductive failure in American mink in captivity (López-Martín, *et al.* 1994); and high organo-chlorine residues are associated with premature births in California sealions (Delong *et al.* 1973), other reproductive problems in several species of seal (Helle *et al.* 1976; Reijnders 1986) and, most recently, with impaired immunological functions in harbour seals, *Phoca vitulina* (Swart *et al.* 1994). In India, high pesticide residues have been found in several threatened species, though it cannot be stated conclusively that this is the main cause of threat. A long-term study in the Bharatpur National Park in west India showed high levels of pesticide residues in the Sarus crane. Other preliminary studies point to the role of pesticides in the high mortality rates found among raptors such as the peregrine falcon and the osprey (Rahmani 1989; Osman 1991).

For these reasons such pesticides have been banned in industrialized countries. However, they have found an increasing and lucrative market in the developing world. For example, Mowbray (1986) documents the sale in the South Pacific of 589 pesticide compounds that are banned or restricted in their countries of origin or are regarded by WHO as highly hazardous.

Acid sulphur and nitrogen products precipitated from the air affect water quality and thereby aquatic vegetation and animals (Hynes 1960; Henriksen *et al.* 1992; Rosseland and Staurnes 1994). Heavy metals from anthropogenic sources such as industry waste-waters, land deposits and

mining activity are affecting the water quality and the biota. The acidified precipitation can also mobilize trace metals and enhance their bioavailability (Vesely, 1994). Eutrophication of aquatic systems due to runoff of fertilizers from agriculture, increased nitrogen runoff from acid precipitation, or of nutrients and organic matter from sewage may lead to blooms of toxic algae, oxygen deficits or even the production of the highly toxic hydrogen

Box 11.2-6: Human impact on lake habitats: characteristics of lakes experiencing 'cultural eutrophication' (Mannion 1992; Goudie 1993).

Biological factors

- (a) **Primary productivity:** usually much higher than in unpolluted water and is manifest as extensive algal blooms.
- (b) **Diversity of primary producers:** initially green algae increase, but blue-green algae rapidly become dominant and produce toxins. Similarly, macrophytes (e.g. reed maces) respond well initially but due to increased turbidity and anoxia (see below) they decline in diversity as eutrophication proceeds.
- (c) **Higher trophic level productivity:** overall decrease in response to factors given in this box.
- (d) **Higher trophic level diversity:** decreases due to factors given in this box. The species of macro- and micro-invertebrates that tolerate more extreme conditions increase in numbers. Fish are also adversely affected and populations are dominated by surface dwelling coarse fish such as pike and perch.

Chemical factors

- (a) **Oxygen content of bottom waters:** usually low due to algal blooms restricting oxygen exchange between the water and the atmosphere. Oxygen-deficient conditions (anoxia) develop, especially at night when algae are not photosynthesizing. Thus seasonal and diurnal patterns of oxygen availability change. The decay of algal blooms also produces anoxia.
- (b) **Salt content of water:** this can be very high and provides a further restriction on floral and faunal diversity.

sulphide in lake and marine sediments (Mannion 1992; Goudie 1993) (Box 11.2-6). Aquatic life is also threatened by organic, chlororganic and other micropollutants from polluted rain, pesticides from agriculture, drainage from dumps and fillings, industry outlets, airport drainage, etc. Marine environments are polluted by organic waste and chemicals (e.g. antibiotics) from fish farms and inorganic (e.g. from antifouling paint) and organic waste products from ships, runoff and land-based discharges and airborne pollution from distant sources (e.g. Atlas and Giam 1981; Anon. 1989; Muir *et al.* 1992), etc. Table 11.2-17 summarizes the relative contribution of all potential pollutants from human activities which enter the sea as estimated by GESAMP (1990).

Chemicals added to ecosystems by human action can have profound ecosystemic effects. Peterson *et al.* (1985), for example, report that a river in northern Canada was transformed from a heterotrophic condition to an autotrophic condition through the addition of phosphorus from air pollution. Higher nutrient input from agricultural runoff (and also from human wastes) increases the primary production of coastal waters (80–90% of nutrient input is taken up by primary production in estuarine and nearshore waters; GESAMP 1990) and has, for example, increased primary productivity in the Baltic Sea by 30% (Hammer *et al.* 1993). However, this has not been followed by an increase in decomposition and the net result has been the production of anoxic conditions in deeper waters, either impoverishing or completely eliminating benthic communities. These conditions have also substantially reduced the spawning area for cod – which require, for successful spawning, a minimum salinity only found in the deeper waters of the Baltic. But there have also been other repercussions of high nutrient runoff: the higher turbidity resulting from runoff has caused a reduction in the *Fucus* community in deeper waters and an increase in filamentous algae which have taken over their role. The balance of species within the Baltic community has changed, with fishes such as bream and roach increasing at the expense of

whitefish, pike and perch (Hammer *et al.* 1993). The effects have therefore been far-ranging, affecting both biodiversity and the integrity of the ecosystem.

11.2.2.6 Global climate change

In coming decades, a massive ‘side-effect’ of air pollution – global warming – could play havoc with the world’s living organisms (Peters and Lovejoy 1992). Human-caused increases in ‘greenhouse gases’ in the atmosphere are likely to commit the planet to a global temperature rise of 1–3°C during the next century, with an associated rise in sea level of 1–2 metres. Each 1°C rise in temperature will displace the limits of tolerance of land species some 125 km towards the poles, or 150 m vertically on mountains. Satellite altimeters are becoming sufficiently sophisticated to measure changes in sea level, indicating rates of sea level rise of 3.9 ± 0.8 mm per year, substantially more than had earlier been estimated (Nerem 1995). Many species will not be able to redistribute themselves fast enough to keep up with the projected changes, and considerable alterations in ecosystem structure and function are likely. In the United States rising seas in the next century may cover the entire habitat of at least 80 species already at risk of extinction. Many of the world’s islands would be completely submerged by the more extreme projections of sea level rise – wiping out their fauna and flora, not to mention human habitations. And protected areas themselves will be placed under stress as environmental conditions deteriorate within them and suitable habitats for their species cannot be found in the disturbed land surrounding them. As the effects of climate change will be felt most profoundly in the future, this topic is covered more fully in Chapter 11.4.

11.2.3 Forces driving human impact on biodiversity

The root causes of the loss of biodiversity are not in the forest or on the savannah, but are embedded in the way societies use resources. They lie in human social organization, burgeoning human numbers, the way in which the human species has progressively broadened its ecological niche and appropriated ever more of the Earth’s biological productivity, the excessive and unsustainable consumption of natural resources, a continuing reduction in the number of traded products from agriculture and fisheries, economic systems that fail to set a proper value on the environment, inappropriate social structures, and weaknesses in legal and institutional systems (WRI, IUCN and UNEP 1992). These are discussed in more detail below.

11.2.3.1 The rules governing the use of biological resources

11.2.3.1.1 Introduction. The way human beings view, use and maintain elements of biodiversity is greatly dependent

Table 11.2-17: Relative contribution of all potential pollutants from human activities which enter the sea (GESAMP 1990).

Source	Contribution %
Offshore production	1
Maritime transportation	12
Dumping	10
Runoff and land-based discharges	44
Atmosphere	33

on the way human society is organized. The changes in social organization among humans as new technologies were developed also provided new and powerful means by which people influenced biodiversity, in both positive and negative ways. This sub-chapter discusses a range of the key issues involved, considering the impacts of various attitudes towards nature, and the impacts of various kinds of human interrelations, including economic, cultural, political and intellectual factors.

11.2.3.1.2 The impact of cultural values on biodiversity.

The diversity of human societies is reflected in the diversity of perceptions people have of their environment. Any classification of such cultural values will necessarily mask some of this diversity. However, some contrasting attitudes and examples to illustrate these attitudes are given in Box 11.2-7.

These attitudes overlap, and are not exhaustive. Nor do the set of attitudes on the left, or those on the right, necessarily go together in any one society; for instance, the modern animal rights movement may consider all creatures as equal, and yet think of nature as wild and humans as civilized (Marquardt 1993). Moreover, these attitudes are ideal types, and will not necessarily be found in their pure forms in any society. Rather, societies both over time and over space can be placed on a continuum between these opposites, as human attitudes change due to internal social dynamics and external influences. However, it is clear that such attitudes greatly influence how humans use natural resources, and therefore the impacts they have on biodiversity. Individual actions are often (though not always) based on what a person thinks of as 'right' and 'wrong', 'good' and 'bad', terms which are defined by the dominant ethical paradigm of the society the individual is living in.

For most of human existence, societies arguably have been characterized more by the set of attitudes on the left, and even now many tribal societies live by an ethical paradigm in which nature is valued both in its own right

Box 11.2-8: Wilderness is a state of mind.

One of the most powerful images of modern urban industrial societies is of 'wild' or 'virgin' nature. Anthropologists and others have shown that this is very different from the way indigenous communities have looked at nature (Gómez-Pompa and Kaus 1992). In Colombia, the forests of the northwest Amazon basin harbour a diverse array of plants and animals. This region is often considered part of the world's greatest remaining tropical wilderness. But for the Tukano people who live there, it is not a wilderness, it is home, and they perceive their 'wilderness' environment to be anthropogenic, transformed and structured in the past by the symbolic meaning their ancestors gave to resources and the knowledge they obtained about the plants and animals that enabled people to survive. Their forest is a system of resources in which the energy produced is directly proportional to the amount of energy it receives. They know that they cannot harvest more than the forest can produce, and they apply sophisticated knowledge of individual species and their uses. Their myths tell of animal species that were punished by the spirits for indulging in gluttony, boastfulness, improvidence and aggressiveness. These myths serve as object lessons to human society, in which animals are metaphors for survival. By analysing animal behaviour, the Tukano find an order in the physical world within which human activities can be adjusted (Reichel-Dolmatoff 1976).

and for its role in spiritually and materially nurturing humans (recent compilations on this point include India International Centre Quarterly 1992; Suzuki and Knudtson 1992; Hamilton 1993; Kemf 1993; Carmichael *et al.* 1994) (Box 11.2-8).

Box 11.2-7: Contrasting attitudes about nature.

Humans as one strand in nature's web	vs	Humans set separate from nature
All living creatures considered equal	vs	Humans superior to all creation
Culture/nature as a continuum (no such thing as wilderness)	vs	Culture/civilization human, and nature considered wild
Natural way is right, and human activities should be moulded along nature's rhythms	vs	Human technology is superior, needs to mould nature to suit human needs
Nature has an integral set of different values (cultural, spiritual, material)	vs	Nature is predominantly a material (economic) resource

Traditional societies have often 'set aside' parts of the natural landscape they live in, or left untouched some of its elements. Most such societies, for instance, have considered certain sites as sacred (Chaitanya 1992; Gadgil and Chandran 1992; Carmichael *et al.* 1994), where most or all human activities are prohibited. Most societies have also considered certain species as sacred, with elaborate myths and folk tales about how humans originated from such species, or how these species are incarnations of, or in some way associated with, gods and deities, or how they have magical powers. These could be wild species which are undisturbed (and therefore have survived in even the most densely populated and radically altered human landscapes, such as rhesus and bonnet macaques in Indian cities), or domesticated plants and animals whose utilitarian value is intertwined with spiritual values (such as the cow in Hinduism). Such belief systems can have the effect (although perhaps unintentional) of regulating resource use.

Some traditional communities have formed resource regulation systems. For example, many traditional communities – whether 'indigenous' or 'tribal' like the Tara'n Dayaks of West Kalimantan (Padoch 1993) or non-tribal, such as the ribereños of Amazonian Peru (Pinedo-Vásquez *et al.* 1990; Pinedo-Vásquez and Padoch 1993) – establish community reserves and formulate rules about how the species therein can be exploited, with the express intention of preserving these resources for the existing community and for future generations. Therefore, in some cases reserves may be protected by religious sanctions and in others by a more overtly 'social' contract, and enforced by strong economic and social sanctions. Combinations of approaches are also found.

Indeed, utilization, respect, enjoyment and other values have usually been integrated into an inseparable whole in

traditional societies. In one village of the Mebengokre, an Amerindian group in Brazilian Amazonia, Posey (1990) found over 60 species of birds, turtles, lizards, snakes, amphibians' and mammals being raised. Nurturing the 'pets' provides a valuable education by teaching children the behaviour patterns and feeding habitats of different animal species, and serves to reinforce cultural and social links between the people and their environment. Most were eventually eaten.

Notions of sustainability of use are inherent in the value systems of many traditional societies, usually manifested in some notion of inter-generational equity. The Iroquois tribe would plan for the seventh generation when making their decisions – the life-span, incidentally, of the dominant tree in their region (Suzuki and Knudtson 1992). The Koyukon Indians believe that future events will depend on the way people behave today and that the world can be nurtured by prudent use or harmed by unrestrained abuse. But equally important, the natural world will respond to gestures of respect given by those who recognize its sensitivity and awareness, and humble themselves to its power (Nelson 1989) (Box 11.2-9).

While it is indisputable that many indigenous populations appear to be well adapted to their environments, and even enhance biodiversity, most cultures maintain beliefs or practices that unnecessarily imperil their well-being (Edgerton 1992). Some of these customs and beliefs are indeed unacceptable in modern civilization, such as slavery (Mitchell 1984), infanticide (Neel 1970; Hausfarter and Hardy 1984), human sacrifice (Harner 1977; Davies 1981; Stein 1988), homicide (Chagnon 1988), feuding (Hallpike 1977; Chagnon 1988; Ferguson 1989), suicide (Rubenstein 1987), forced migration (Anthony 1990), and environmental pollution (Rambo 1985; Chagnon 1988). Edgerton (1992) argues that some beliefs concerning witchcraft (Lindenbaum 1972), the need for revenge (Keiser 1986; Chagnon 1988), and certain traditional practices involving nutrition (Cassidy 1980), health care, and the treatment of children (Miller 1981; Scheper-Hughes 1987; Goodman and Armelagos 1988) have been harmful as well. In short, while some traditional societies have had a relatively harmonious relationship with nature (Marshall 1959; Herskovits 1972; Bennett 1976; Ellen 1982), life in such societies has not been free from human discontent and suffering (Campbell 1975; Dirks 1980), and some have been unable to cope with the demands of their environments (Turnbull 1972; McGovern *et al.* 1988; Yoffee and Cowgill 1988; Tainter 1988). A generalization that can be drawn from this is that people are not always wise, and the societies and cultures they create are not ideal adaptive mechanisms, perfectly designed to provide for human needs (Turke 1990). A more balanced view is that traditional beliefs and practices may serve as important adaptive mechanisms, but they may also be inefficient, harmful and even deadly.

Box 11.2-9: Respect for nature in Alaska.

Many indigenous people exhibit behaviour that underlines their respect for the prey that supports their way of life. The Koyukon Indians of Alaska, for example, have an elaborate code of respectful behaviour that governs their relationship toward animal species. Red squirrel meat should not be cooked on a stick; women must never mention the brown bear's name, beaver bones should be returned to the water; hunters must avoid bragging about prowess. These and numerous other very specific rules govern their way of life. The Koyukon limit their own harvests, guided by a thorough knowledge of population levels and ecological relationships, and restrained by their traditional code of ethics (Nelson 1989).

Clearly, some societies adapt to changing conditions better than others (Davis 1977; Laughlin and Brady 1978; FÜRER-HAIMENDORF 1982; EDER 1987). Kuran (1988) has criticized the several theories seeking to account for such variability, which generally ascribe lack of adaptation to personal conservatism or collective conservatism – both forms of attachment to past choices. The key factor in successful adaptation appears to be the presence of feedback mechanisms which allow consequences of decisions to influence the next set of decisions, which enable societies to adapt to changing conditions.

When local people are part of a local ecosystem, their behaviour directly affects their own survival. But cultural mechanisms that have been developed as adaptations to the environment over tens or hundreds of generations are quickly cast aside when trade or new technology frees people from traditional ecological constraints, changing them from what Dasmann (1975) calls 'ecosystem people' who are adapted to their local ecosystem, into 'biosphere people' who can draw from the resources of the entire world.

While changes in traditional attitudes towards nature can be a result of internal dynamics (e.g. population increase), it is perhaps more often a result of outside influences: interaction with a modern culture, intrusion of the market, and so on. Redford (1990) has argued that in South America, at least, traditional resource use patterns may be sustainable only under conditions of low population density, abundant land, simple technology and limited involvement with a market economy, so that when confronted with market pressures, higher population densities, new technologies, and increased opportunities, few indigenous peoples can maintain the integrity of their traditional methods. This argument also applies to traditional fisheries management systems in the insular Pacific (Johannes 1978). In tropical Asia, on the other hand, some traditional systems have supported high populations and intensive agriculture for centuries. However, at least some such groups have fought hard to maintain their identity, and are seeking expanded international support for their efforts.

One of the lessons from recent work in ethnobiology and traditional ecological knowledge is that some indigenous views of conservation may differ from conventional biological views but nevertheless are legitimate in their own right (Berkes 1987; Alcorn 1993; Gadgil *et al.* 1993). One of the main differences between these two sets of views is that traditional concepts of conservation tend to be user-orientated; there have been no documented cases of a 'traditional preservation ethic'. Yet many indigenous groups have practices that help maintain ecological processes and the species that mediate these processes (Alcorn 1989). Thus, the area of common interest between Western conservation scientists and indigenous wise-use

conservationists is biological sustainability. A major paradigm change among some Western conservationists is that some kinds of human use are accepted as part of conservation planning, as done in the updated World Conservation Strategy (IUCN/UNEP/WWF 1991). According to this view, biodiversity cannot be conserved in the longrun without the support of indigenous and other rural peoples, and without attention to their views and needs (e.g. Gadgil *et al.* 1993). As Alcorn (1993) puts it, indigenous peoples' goals match the broader goals espoused by many conservationists who recognize that most of the world's biodiversity is found in landscapes already occupied by people.

The influence of modern attitudes towards nature is now global. Stressing the place of humans outside nature, and the need for and possibility of technology mastering nature, these attitudes tend to treat all biodiversity elements as material resources created for human use. Therefore, nothing is 'wrong' in the extinguishing of other life-forms if the pursuit of material well-being (called 'progress') is served by it. Also lost in much of modern thinking are notions of inter-generational equity, as the discount rates used by economists render long-term considerations non-viable (Daly and Cobb 1989). Such modern materialist views have directly or indirectly led to considerable over-exploitation of nature, and consequently to the loss of biodiversity (WRI, IUCN and UNEP 1992). However, it can be argued that the modern scientific world view is also essential in using resources sustainably, since this provides a better capacity to understand natural processes and products, and to use them rationally. Rolston (1993) believes that spirituality and science need not be at odds. The biological sciences describe what is the case in nature and enable us better to appreciate and conserve it. Ecologists, for example, often solve problems with numerous variables and make predictions based on those solutions (The Crucible Group 1994). Perhaps science does this better than folklore, mythology and religious beliefs. Science observes ecological reality in the world, and does not choose or assign this reality (though of course scientific tradition affects the way scientists perceive reality; Sprugal 1991). People may choose to conserve natural things because they are useful, but also because they marvel at the intricacy, diversity, complexity, beauty, order, natural history and creativity present in nature. Ethics is informed by the facts about nature, and these facts influence value judgements.

In a way, the human world-view of nature is coming full circle in parts of the modern conservation movement. Respect for nature, inter-generational equity, and other such values which characterized many traditional societies are again gaining ground, not just in the deep ecology (Wilson 1984) and animal rights groups (Regan 1983; Singer 1991), but also in more mainstream efforts such as

the UN General Assembly's *World Charter for Nature* (1982), the WWF's Network in Conservation and Religion, the IUCN's Working Group on Ethics, Culture, and Conservation, the World Commission on Environment and Development's *Our Common Future* (WCED 1987), the document *Caring for the Earth: A Strategy for Sustainable Living* (IUCN, WWF, UNEP 1991), the *Earth Charter* adapted by the UN Conference on Environment and Development (1992), and the Australian CSIRO Conference on *Nature Conservation: The Role of Networks* (in press). This is further explored in Section 13.

There is in all this an increasing realization that cultural and biological diversity are intimately and inextricably linked. Attitudes toward nature and toward fellow human beings are part of a society's culture, and the enormous diversity of cultures around the world has arisen in response to diverse biological, historical and physical environments, and has in turn influenced the management of these environments. As cultural homogenization sweeps across the world in the wake of modernization and westernization, the vast range of human knowledge, skills, beliefs and responses to biodiversity is also washed away, leading to great impoverishment in the fund of human intellectual resources. Loss of cultural diversity leads to loss of biological diversity by diminishing the variety of approaches to human, plant and animal coexistence that have been successful in the past, and by reducing the possibility of imaginative new approaches being developed in the future (Burger 1990; Mayberry-Lewis 1992; Suzuki and Knudson 1992).

11.2.3.1.3 Property rights and the use of biological resources. Human societies display an enormous range not only of moral and other attitudes, but also of organizational forms, interpersonal and inter-community relations, and political and economic systems. Each of these systems tends to have a somewhat different impact on the way humans relate to and use resources, and therefore on biodiversity. While no comprehensive comparative work on such impacts is available, the following provides examples indicative of the complexity of the situation.

The object of the property relationship is often a biological resource: land, trees, wildlife, crops and so on. The property relationship may then be based around obtaining, guaranteeing, or controlling access to the resource, essentially securing the rights to deriving value from it by either use or exchange. Property rights are not absolute and unchanging, but rather a complex, dynamic and shifting relationship between two or more parties, over space and time. Numerous property regimes have been distinguished, including open (unregulated) access, communal (regulated) property, private property (including corporate property), and state property (Berkes and Farvar 1989). How each of these relates to the conservation and use of biodiversity and the impacts of changing from one to another regime, appears to be highly variable (Berkes 1989).

In considering the property regimes that affect access to resources in most parts of the world, the complications are many. For instance, more than one set of laws or legal systems may be in operation at any one time and place, affecting the same common property resource. The dynamics of land use and transformation at a particular site are significantly influenced by competition between different sources of legitimate authority, such as 'customary' or 'traditional' law and 'formal' legal systems (Moore 1986; Fortman 1990; Peluso 1992). Further complicating the matter, conflicting perceptions and negotiations over the meaning of land and other natural resources may affect the form of property relations (Dove 1986; Posey 1989). In addition, scholars have pointed to the importance of an individual's social position, derived in part from participation in various types of social networks, as central to an appreciation of the ways in which property relationships are formed and operate in any particular place (Berry 1989, 1991).

Painter (1988), for example, found that the crucial issue underlying the loss of biodiversity in Latin America was the gross inequity in access to resources. In eastern Bolivia, smallholders are locked in an intense struggle for development resources (such as access to markets, agricultural credit, transport facilities and similar services) with large-scale commercial agriculture enterprises, lumber companies and other interests. This competition appears as an inter-ethnic conflict between people who are native to the area and migrants from Bolivia's highland and Andean valley regions.

Following up on this point, Lele (1991) has made a convincing argument that differential access to resources and the resulting affluence for some, in the form of over-consumption, may be linked much more directly to environmental degradation than is poverty *per se*, in either the North or the South. It is much easier for an economically powerful country to gain access to the resources of less powerful countries by creating an economically powerful market demand. This can then encourage the countries who are hoping to tap into this market to harvest their resources at unsustainable rates, while the richer country can protect its resources for a later day. Although it does not necessarily make environmental sense to do so, many tropical countries have taken an economically defensible position of harvesting their forest as quickly as possible, thereby cashing in on the stumpage value of the standing timber and investing the capital in opportunities that earn a higher rate of return, at least in the short term. This tendency explains the boom-and-bust logging cycles that have characterized many small tropical countries. Timber concession policies are partly to blame, because they fail to combine forest tenure with capture of stumpage value, thus preventing either the government or concessionaires from detecting and responding to rising

stumpage values by improving logging practices and reducing negative impacts on biodiversity (Vincent 1992).

Given this complexity, it is difficult to reach a general conclusion that any one of the forms of property regimes is necessarily, and in all circumstances, more conducive to conservation than another. The famous narrative of the 'tragedy of the commons', which, following Hardin (1968), presumed that conservation goals are best accomplished through either private or coercive state ownership, and that common property regimes led to over-exploitation, has been very widely criticised as emphasizing competition rather than cooperation and assuming the supremacy of individualism over communal interests (Ciriacy-Wantrup and Bishop 1975; Cox 1985; Berkes and Farvar 1992). Ample evidence has now been accumulated to show that common-property regimes do not inevitably lead to tragedy (Dasgupta 1983; McCay and Acheson 1987; Ostrom 1990), underlining the great difference between open access systems and regulated common property regimes. Renewed interest in the subject has stimulated a flurry of intensive studies of the performance of diverse common property institutions (Berkes 1989; Feeny *et al.* 1990; 1993; Ostrom 1990; Bromley 1992; Schlager and Ostrom 1992). Berkes and Farvar (1989) conclude that traditional systems have been the means by which societies have managed their natural resources over millennia on a sustainable basis. It is only as a result of these systems that any resources remain today.

A series of examples will illustrate the complexity of the property-biodiversity relationship. In Niger, resource use was controlled by time-tested rural systems such as carefully negotiated allotment of agricultural lands, wood-cutting rights within the territorial boundaries of sedentary communities, and the controlled use of water points and seasonal grazing lands by pastoral groups (Otto and Elbow 1993). These traditional systems regulated intra- and inter-group use of resources, which were allocated sequentially between various user groups. Many, perhaps most, hunter-gatherer, shifting cultivation, and traditional agricultural societies have had a combination of family proprietary rights over small intensively managed (usually cultivated) plots and clan/village/tribal group rights over larger foraging/hunting/fishing areas (McNeely and Pitt 1985; Ruddle and Johannes 1985). Biologically rich areas of the Sahel are often managed by rural populations through common property tenure arrangements which determine rights of access and responsibilities of the community (Lawry 1991). For example, sacred forests are managed by highly respected animist religious leaders who enforce rules governing access to remnants of primary growth forests (Freudenberger 1993a). Other ecologically diverse resources are considered private property of the resource users themselves. Dense concentrations of gum arabic trees (*Acacia senegal*) in the Ferlo of northern

Senegal are considered by rural communities to be the property of individual gum collectors, who protect 'their' trees (Freudenberger 1993b). In cases where no rules (imposed either through cultural traditional or legal institutions) effectively govern the use of open-access resources, ecological degradation can be severe (Hardin 1968).

Controlled comparisons between private and common property regimes are rare. One simple study in Zimbabwe showed that while as many as 99 species of trees existed on village communal lands, adjoining private farms had only 40 (McGregor, pers. comm. 1992). Other evidence suggests that private ownership can frequently lead to simplification of grown vegetation into a few commercially favoured crops, and that making the land a commodity itself creates conditions for its transfer to less conservation-orientated owners (Hecht 1988). Absentee private landowners are notoriously unsuccessful in conserving biodiversity (McGovern *et al.* 1988).

Place and Hazell (1993) did not find that fully transferable property rights (frequently lauded as the essential characteristic of private property) were a significant factor in affecting the kinds of investment that farmers made in improving their land, their use of input factors, their access to credit, or the productivity of their land. Farmers holding secure but communal rights were just as apt as those who could sell their land without prior approval to make long-term investments in the quality of land and to achieve equivalent yields. However, without secure tenure, rural communities can *only* afford to consider their own short-term interests. Without the security of realizing sustainable revenues, or returns from their investments, they are compelled to exploit resources for maximum immediate gain, regardless of future consequences for themselves, the resource base, or biodiversity. In Tanzania, past government interference with customary land-use rights has made rural people reluctant to make long-term investments in tree planting (IDA 1992), because they have no incentive to invest time, energy and capital if there is no assurance of reaping the benefits.

Ownership of land and/or resources by the State has been one method of securing property rights and regulating resource use. Various countries have tried to do so by nationalizing different resources, especially forests, land, water and minerals. However, many of these nationalization efforts ignore or overlook the reactions of the local peoples to such actions. In many parts of the world, the national plans or resource management strategies are imposed over pre-existing structures, thereby greatly weakening traditional systems of resource management that have functioned for hundreds of years and have deep historical, cultural and social roots. Changes in these systems result in loss of social control

mechanisms, and consequently lead to profound changes in resource use – usually in the direction of over-exploitation (Blaikie 1985; Berkes 1989; Vincent 1992; Dove 1993).

Similarly, government ownership has a chequered record in conserving natural resources. In many instances government ownership of forests has led to a concession economy, in which badly designed concession regimes have led to massive deforestation. In some tropical countries, forests and coastal areas are in effect 'open access common pool resources', open to use by anyone (Orstrom 1990). This status usually occurs despite property rights claims by governments or individuals. Such claims are often simply unenforceable in remote areas or where significant political pressure allows squatters to use vacant land. Under such conditions and with high use pressure, such open access (rather than communal property) may indeed lead to what Hardin (1968) termed 'the tragedy of the commons' in which all users rush to claim their share, despite long-term damage to the resource. In most cases, such local property rights disputes occur around resources with tangible economic value, such as timber, fish, or land that could be cleared for agriculture. Other biological resources, however, are often damaged or destroyed as a side-effect of the exercise of these rights.

A change in agricultural and land management technologies is often accompanied by a change in property regimes as well as by changes in biodiversity. The spread of irrigation is often also accompanied by a change from common property to individually owned plots and a reduction of access and decision-making by poor farmers, nomads, and women over land (Witfogel 1957). In the arid regions of western India, the Indira Gandhi canal has disrupted nomadic routes, allowing outside settlers to take over, and causing loss of native biodiversity as pastures and scrublands are turned into irrigated agricultural fields (Mukhopadhyay and D'Souza 1994).

The intrusion of the market is also very frequently the cause of a change in resource control and conservation regimes. Instead of using resources for subsistence, the people may elect to feed market demands and receive the benefits in financial returns rather than sustenance (Ekins 1993). In the northeast Indian states of Nagaland and Arunachal, tribals own the vast majority of forests in a variety of communal or private property systems. Once well protected by these systems, the forests are now being sold at alarming rates to outside timber and plywood markets, a process aided by lack of alternative income-generating livelihoods (required to obtain goods from the market), changes in local leadership, and alienation of the new generation from their lands (Kothari 1994b).

Attempts by the state to assume responsibility for species-rich areas for conservation purposes have often resulted in conflicting situations which, ironically, threaten biodiversity. Some of the most ecologically diverse areas,

such as the inland estuaries of the Senegal River, have been turned into state reserves managed by forestry and wildlife departments. Rural populations have been systematically excluded from use of these resources, and hence often harbour bitter feelings towards the reserves, a situation that frequently leads to poaching and other forms of abuse (Burnett and Stilwell 1990; Brandon and Wells 1992; Bergeret 1993). Several National Parks and sanctuaries in India, home to tribal and non-tribal peasant populations whose only stable resources are the forests, are now witnessing deliberate habitat destruction, or incitement to destruction by wood-poachers, by local communities who have been denied these resources (Basappanavar 1993; Kothari 1994a).

At the same time, the 9800 protected areas that have been established by all governments today cover over 925 million hectares, and provide one of society's strongest defences against over-exploitation of particularly important sites (McNeely *et al.* 1994). Many of these protected areas provide significant benefits to local people and earn broad popular support (Barzetti 1993; McNeely 1993). On balance it appears that government intervention in favour of conservation is well justified by the power of modern civilization to over-exploit: protected areas are thus a legitimate expression of national sovereignty and usually make a significant contribution to national welfare. When local communities are forced to pay the costs of providing such national benefits, governments are seeking ways of providing appropriate compensation for the opportunity costs involved (McNeely 1988). (See Section 13 for a further discussion.)

11.2.3.1.4 Impact of access to information intellectual resource rights. Among the newest forms of private property are regimes that relate to intellectual resources. The rapid development of intellectual property regimes (IPRs) (patents and plant breeder rights being the ones most directly relevant to biodiversity) in the past few decades has raised serious concern regarding the impact of this new form of property on the conservation and sustainable use of biological resources.

The rapidly advancing field of intellectual property rights has profound implications for the relationship between people and biodiversity. IPRs represent a privatization of ideas and innovations, mirroring the transition from common/public to private/corporate ownership and access which is seen in the case of physical/natural property. IPRs originated with industrial inventions but recent decades have seen their increasing extension to the living world, culminating in patent applications even for human genetic material.

As in the case of physical and biological property, access to information provides people and societies with a powerful means of influencing natural resource use and management. Indeed, in the modern world, information is

power. It would appear that recent advances in information technology and telecommunications (television, satellite dishes, computer networks and the 'information superhighway') are breaking the boundaries within which information is held. O'Neal (1993) goes so far as to assert that an explosion of knowledge has reached the masses, breaking 'the monopoly of the world's literate classes'. However, information remains an instrument of power, as can be seen in the continuing attempt to monopolize it in the form of intellectual property rights.

Access to information has both positive and negative implications for biodiversity. On one hand, information provides technology which can enhance public health standards, improve the quality of life, and otherwise assist in solving difficult problems. The more pertinent information that becomes available, the more able people are to make decisions based on the best available knowledge, with a reasonable idea of the consequences. However, in most countries, information about major development projects, political and policy decisions, and other activities which have a direct bearing on people's lives and on biodiversity, are not easily accessible to the general public. Development in such an atmosphere of secrecy is likely to be less successful in reaching those whom it targets, and in achieving an optimum use of the intellectual resources a society possesses. In India, destructive development projects have been stopped on the basis of information leaked to the public. Conversely, they have been forced ahead where such information has remained in closed files or been inadequately distributed.

Information also comes with the biases of dominant groups in society: it is orientated towards the literate against the non-literate, and towards a few widespread languages against the more localized languages. Even conservation literature, for instance, suffers from these biases: most information on biodiversity-related debates is in English. These biases mean that a considerable number of people are not being informed, and that the debate itself is losing out on essential and diverse inputs.

On the other hand, access to information does not come with control of it. Many countries are unable to protect themselves from the onslaught of information, nor are they really able to regulate how they are perceived by others. The mass media, particularly those of the industrialized world, predominantly portray high-consumption lifestyles, with little focus on sustainable use of resources (Opole 1993). Since such portrayals now reach most of the world's population, the media may be a major force in enticing people and countries to strive for consumption patterns far beyond their economic and natural resource means. Mass media are also inherently homogenizing, since they cannot possibly be flexible enough to cater to the enormous diversity of local cultural and biological systems. This influence itself may have a negative effect on biodiversity,

for example, in driving demand for a few new high-status foods in place of a diversity of traditional menu items (e.g. rice and wheat taking over coarse cereals and millets).

There is also, paradoxically, an information overload, at least among those who have access to the dominant channels of communication, including governments. The change in information availability on ecology and resource management in recent decades has had a considerable impact on decision-makers. Carew-Reid (1993), in summarizing the environmental strategies that countries have embarked on in the past two decades, documents a bewildering array of initiatives, not necessarily exclusive, prepared at national levels with the help of many different international organizations, resulting in a smorgasbord of strategies – for example NCSs (national conservation strategies), TFAPs (tropical forest action plans), NEAPs (national environment action plans), NEMPs (national environment management plans), Green Plans, and Biodiversity Action Plans. Printed literature too is expanding at a bewildering rate: there are now several dozen professional, and thousands of amateur, journals/newsletters on matters relating to biodiversity.

The special role of women in biodiversity-related issues is now widely recognized. Dankelman (1993) summarizes the role of women as managers of the environment, beginning with their role in traditional hunter-gatherer societies: credited with collecting four times as much food as men, they have developed a thorough knowledge of plant and animal life and ecological processes. In settled agricultural systems women have often played an especially important role in domesticating animals, inventing selective breeding, domesticating most of the currently important crop plants, inventing tools, and establishing the use of ash as a fertilizer, mulching, terracing, fallowing and crop rotation.

Van den Oever (1993) identifies women as the primary educators of the young, though of course father-son education has also been extremely important in most cultures. Children (particularly girls) have traditionally helped their mothers with the daily chores associated with subsistence farming, fuelwood gathering and freshwater collection. Traditional knowledge is passed on to them orally from their mothers. While the importance of the education of women to at least primary or early secondary level is seen as an important component in reducing fertility rates and controlling population growth, Opole (1993) suggests that the development of education has also contributed to the loss of indigenous knowledge through the separation of young girls from their mothers as they go to school. The media, too, have played their part in making women (and children) a special target group for consumer goods advertising (Dankelman 1993).

If the foregoing discussion about property relations and biodiversity is an indication, it would appear that the

possibility of conservation-orientated use of resources would be greater with decentralized political structures, everything else being equal. However, little literature is available to support this hypothesis. Nor is it possible to prove unequivocally, at the current state of knowledge, that democracies are better at conserving biodiversity than dictatorships: experience from Africa, for instance, suggests that either may be possible. However, given that democracies are more amenable to other aspects of social relations which may facilitate conservation (e.g. access to information, secure land tenure and resource rights, participation in decision-making, flexibility in dealing with diverse situations, etc.), such a relationship may be posited. Reed (1992) shows how the mismanagement of natural resources in Côte d'Ivoire, leading to severe deforestation, is a result of attempts by the ruling elite to maintain political power, and how this was made possible by a one-party system which repressed any challenge to official policies.

11.2.3.2 *Growth in human population and natural resource consumption*

The Earth's human population is increasing. Some 5.6 billion people currently occupy our planet and that number is projected to double within the next 60 years (UN 1992). More people means a greater need for agricultural and industrial produce, settlements, transportation, and infrastructure. More and more natural areas will be modified, though to what extent will depend partly on the number of people they support (Boserup 1965). This growth will have serious impacts on the levels of biodiversity that can be maintained.

In most countries with high fertility rates, about half the population is under the age of 16. The resulting demographic momentum – that is, high birth rates in coming years due to the large number of people who will be reaching their reproductive years – means that global population will continue to grow for at least the next half century and probably longer, barring catastrophe. Another billion people are likely to be added to the world population for each of the next three decades (UN 1992). The rates and magnitude of this growth and the eventual size at which the global population stabilizes – critical considerations for biodiversity – depend on social and economic measures, especially on the rate of economic development in the developing countries.

The problems associated with population growth and distribution and loss of biodiversity are reaching critical proportions in many parts of the world. In all but one of the seven mega-diversity countries which together contain over 54% of the world's flora and fauna – Brazil, Colombia, Mexico, Zaire, Madagascar, Indonesia and Australia – population growth exceeded the world's average for the period 1950–90. In these countries, population growth is expected to continue, and if present trends persist, population increases are likely to lead to higher

deforestation, degradation of land and loss of biodiversity. But the picture is seldom simple: Brazil, for example, has been experiencing an absolute decline in rural population since 1975 as rural people have moved to the cities. Declines in rural population can mean increased biodiversity in at least some cases where demand for biological resources also declines.

The impacts of population increase are felt in both terrestrial and aquatic habitats. Lundin and Linden (1993) estimate that already 66% of the Earth's population lives within 60 km of coasts and that population growth here is faster due to migration from inland areas. This has resulted in densities of 1000–2000 people per km² in the coastal zone of Asia, Central America and the Caribbean. Coastal migration affects developed and undeveloped countries alike: in recent decades migration to coastal areas of the Pacific Coast and the Gulf of Mexico has increased such that 50% of the US population now lives within 70 km of the sea (WRI 1994).

The average number of working-age people entering the labour force is about 35 million annually in developing countries, exacerbating the already serious problems of underemployment and unemployment. In the next 10 years, developing countries must generate 30 million new jobs each year just to absorb into the workforce the children already born. This means that the natural resource base of these countries will be increasingly under pressure if countries are unable to provide employment in industry and agriculture. For example, in India, almost 10 million entrants a year are projected in the coming decade. Since 73% of the Indian population is currently in rural areas, it is possible that agricultural lands and forests will need to absorb about 7 million new workers each year, placing additional pressures on already degraded resources (Bose 1991).

Population growth affects biodiversity: directly, through increased resource consumption; and indirectly, through fuelling the processes of poverty and migration, and causing a breakdown in social institutions determining the management of natural resources. However, the ways in which population pressure affects natural resources and habitats vary, and therefore it is necessary to understand the causes of such pressure before designing interventions for its control. One of the major causes is the effect of natural population growth on the regeneration rates of resources. Another cause is unsustainable resource consumption patterns, including excessive commercial use of resources, urbanization, and human uses of valuable or critical species. A third cause is increasing migration of poor people into ecologically fragile areas. Resource degradation can also occur when the population exceeds the social capacity of institutions to cope with environmental changes.

Human population density is clearly linked with wildlife habitat loss. The 20% of countries which have lost most

habitat in Africa and Asia (an average of 85% of habitat loss) had average population densities of 1888 persons per km². In the 20% which lost least habitat (an average of only 41%) population density averaged only 294 people per km². According to UNEP and Sadik (1992), 79–80% of deforestation results from population growth (though it is unclear whether the effects of changes in consumption patterns, discussed below, are included in this estimate).

As numbers have increased and new technologies have developed, humanity has appropriated an ever-increasing share of the Earth's resources. People consume, divert or destroy an estimated 40% of the terrestrial productivity of photosynthetic plants, algae and bacteria (Vitousek *et al.* 1986), the fundamental source of the energy available for virtually all living systems. This trend appears to be unsustainable. The world's biotic systems simply cannot accommodate an ever-growing claim on primary productivity to meet further growth in human population and consumption. The inherent limits of the natural resource base will impose a corresponding limit on the number of people who rely on it. Of course, an ecosystem's (or, for that matter, a planet's) 'ecological carrying capacity' can be increased by technology (as the history of agriculture demonstrates), but ultimate constraints on consumption are nevertheless real.

Ehrlich and Ehrlich (1990) give global population growth the primary importance in most environmental change because of the resources required to sustain the demands of over 5 billion people. They contend that population growth has exceeded the capacity of the biosphere to sustain it, under current levels of management. Simon and Kahn (1984) take an opposing position which holds that population increases stimulate technological and social advances that improve the conditions of life, so that greater numbers can transform the environment for the better (at least for humans).

Another view is that profit-seeking and capital accumulation require that natural resources be exploited at

an unsustainable level, wherein socioeconomic differentiation creates a situation in which the 'haves' place heavy demands on the world's resources, driving environmental change, while the subsistence needs of the 'have-nots' put marginal environments under increasing stress (Blaikie 1985; Redclift 1987; Sweezy and Magdoff 1989).

Allen and Barnes (1985) and Rudel (1989) provide statistical evidence to support the idea that population growth drives or strongly contributes to forest clearance, at least in the tropics, while Anderson (1990) emphasizes such factors as uneven land distribution and a complex array of policies, institutions and economic forces that promote and reward forest clearing (Hecht and Cockburn 1989). Bilsborrow and Okoth-Ogendo (1992) conclude that population growth is an important factor in the destruction of tropical forests, but one that is significantly modified by the natural and institutional context within which the damage occurs.

Meyer and Turner (1992) suggest that population is an important global variable in that total world population is directly related to total biological demand for resources, but its connections to land-cover change become weaker at increasingly smaller spatial scales because of the importance of other variables that affect demand or spatially deflect its impacts. These other variables must be incorporated to improve our understanding of the human causes of the observed changes in land cover.

Consumption is an especially important variable, as more consumption inevitably means increased impact on resources (Boyden and Dovers 1992). The past few decades have seen the emergence of a powerful new drive in human society: consumerism (Durning 1992). Throughout history, some people in society have had the power and privilege to amass material wealth, and to consume considerably more than the average, but until recently they constituted a small minority (mostly rulers, upper status/class people, and the

Table 11.2-18: Some indicators of growth in global consumption of resources from 1950 to 1991 (Brown *et al.* 1992).

World indicator	1950	1991	Change (%)
Grain production (10 ⁶ tonnes)	631	1696	270
Soybean production (10 ⁶ tonnes)	18	106	590
Meat production (10 ⁶ tonnes)	46	173	380
Fish catch (10 ⁶ tonnes)	22	97	440
Irrigated area (10 ⁶ ha)	94	235	250
Fertilizer use (10 ⁶ tonnes)	14	136	970
Oil production (10 ⁶ barrels/day)	10.4	59	570
Natural gas production (10 ¹² cu. ft.)	6.7	77	1150
Automobile production (10 ⁶)	8	35	440

like). In contrast, in the industrial world today, and among the large middle classes of the developing world, consumerism is all-pervasive: indeed it defines what constitutes 'the good life' (Durning 1992). An indication of the magnitude of the growth in consumption can be gained by several indicators in the growth of global consumption of resources since 1950 (Brown *et al.* 1992) (Table 11.2-18). Particularly remarkable is the order of magnitude increases in fertilizer use and natural gas production.

Whittaker and Likens (1975) have estimated that an 'agricultural world' in which most human beings are peasants, should be able to support 5 to 7 billion people, probably more if the large agricultural population were supported by an industry-promoting agricultural activity. In contrast, a reasonable estimate for an industrialized world society at the present North American material standard of living would be one billion. At the more frugal European standard of living, 2–3 billion would be possible. These figures represent not just the contrasting material demands of developed and developing societies but also their contrasting dietary habits. Huxley (1984) considers that dietary habits lie at the root of many of our troubles and calculates that the average Westerner consumes 65 kg of grain per year while the meat consumed accounts for over 900 kg of grain per year. The average Chinese consumes 160 kg of grain and under 20 kg of meat per year. In short, the range of food required to feed 200 million in the West would feed 1500 million Chinese. However, the current change in the economic status of China and Southeast Asian countries will result in a shift towards Western levels of consumption with drastic implications for world food reserves and future demand, and resulting impacts on biodiversity.

Most Asian and African nations have predominantly rural populations (70.1% and 67.3%, respectively). In contrast, in developed countries and in Latin America about 75% of the population is urban. Over the past 40 years, there has been an unprecedented growth in the world's urban population and by the year 2000 it is estimated that nearly half of the world's population will be urban (WRI, 1994). Urbanization affects biodiversity in four main ways:

- Geographical expansion of settlements and infrastructure displaces the existing vegetation and diversity through land conversion.
- Urban activities indirectly have a significant impact on hydrological and atmospheric systems at both local and global levels.
- Urban dwellers plant many species of plants around homes, along avenues and in parks. These are largely ornamental and often introduced species which displace the native vegetation, while adding to overall diversity.

- Urban demands for biomass require fuelwood, industrial wood, sawnwood and other products such as fruits and flowers from surrounding areas. Around cities, plantations of genetically similar trees are displacing the local vegetation to meet the urban demands for biomass.

Urbanization and its effects on biodiversity are discussed in more detail below (11.2.3.3) and in Section 13.3.8.1.

Another way in which population change affects biodiversity is through population movements. Environmental degradation is both a cause and a consequence of frontierward migration. It is a *cause* when decreasing ecological capacity forces people to move elsewhere, often entailing clearing forests for settlements and agriculture. It becomes a *consequence* when increasing populations exert pressure on resources for livelihood; short decision-making time horizons prevent many poor farmers from investing in soil or forest conservation techniques, especially when payoffs are not immediate (Shaw 1989).

Resource extraction activities have motivated movement into frontier sites (Cruz *et al.* 1992), including those initiated or supported by governments and aid agencies. More than half the developing countries in the tropics with annual deforestation rates of over 90 000 ha have populations in excess of 55 million and average annual population growth rates of 2–5% since the mid-1970s. Close to 30 million people reside in forests and protected areas in India and Indonesia. In the Rondonia area in Brazil, the population of small-scale cultivators has increased by over 15% per year since 1975, a rate that is many times higher than Brazil's annual population growth rate. Similar mass movements into tropical forests and protected areas have occurred (WRI, UNEP and UNDP 1990).

While the magnitude of population pressures on the environment can be measured, and in some cases predicted, another dimension of population pressure which is relevant in the management of natural resources is the social and cultural characteristics of the population. These characteristics determine the capacity of groups in dealing with changes in resources and access rules.

Because of accessibility to markets and increased immigration, which are often linked to population pressures, very few frontier sites have culturally homogenous populations and even areas, and can show striking differences among groups in their population growth rates, migration patterns, and their land-use and resource consumption patterns. Three aspects of the composition of populations have especially important impacts on the management of biological resources: recognition of ethnicity; gender-specialized roles in conservation; and differences in socioeconomic status. In any particular habitat or ecosystem, the ways in which

resources are used and managed will differ among ethnic groups, between men and women, and between different socioeconomic groups. It is important to distinguish interventions in terms of which population sub-groups are most vulnerable to changes in resources (e.g. indigenous peoples, women, the poor).

11.2.3.3 Urbanization and biodiversity

The urban environment is a mosaic of human-made, natural and semi-natural habitats with climatic and hydrological conditions that distinguish it from adjacent rural areas (Berry 1990; McPherson 1994). While only 18% of cities are open space (Nicholson-Lord 1987), as much as 40–70% may be green and photosynthesizing (Nicholson-Lord 1987; Ignatieva 1994; Loucks 1994).

Around 45% of the world's population is urbanized but this is unevenly split between the developed countries (over 70%) and the developing countries (just under 40%) (Berry 1990; WRI 1994). However, the gap is closing and the urban growth rate in the latter is currently four times faster than in the developed countries and their urbanized area is predicted to double over the period 1980–2000 (UNEP 1992). Some general trends in city growth include:

- an increase in cities of over 1 million inhabitants (increasing from 190 in 1975 to over 400 by the year 2000; Berry, 1990);
- 'counterurbanization' in the developed countries with substantial numbers of people leaving core city areas for the less built-up suburbs (OECD 1985; Nicholson-Lord 1987; Berry 1990; Skibniewska 1994) leading to more disturbance of green-belt areas and more dispersed populations;
- higher numbers and growth rates of cities in coastal areas where 60% of the world's population currently lives (Walker 1990; Lundin and Linden 1993).

11.2.3.3.1 Effects of urbanisation on biodiversity. These can be considered from two perspectives: the direct effects urbanization has on biodiversity (the loss of habitat; the fragmentation of habitat; the creation of new human-made habitats such as cemeteries, derelict lands, rubbish tips, etc.); and the indirect effects it has through its impact on hydrological systems and the atmosphere. Another indirect effect which is considered elsewhere and will not be discussed further here is the effect on the rural environment of the urban demands for resources.

Indirect effects: Urbanization covers the urban landscape with impervious surfaces (one US study of an average, urban area estimated this at 12–37% of total urban area: Loucks 1994) and these have a dramatic effect on runoff, an effect which is exacerbated by extensive sewers and drain systems (Binford and Buchenau 1993; Goudie

1993). A comparison of contaminant profiles of urban runoff and raw domestic sewage indicates that urban runoff contributes more suspended solids, pesticides, chlorides and heavy metals while the sewage is the main source of nitrogen and phosphorus (Goudie 1993). The less soil available, the more concentrated are these chemicals when they arrive in the rivers.

Most African and Asian urban centres have no sewerage systems at all (UNEP 1992) and in developing countries human sewage is the most important pollutant of freshwater and coastal zones (Markham 1994). Sewage, both treated and untreated, contains high nitrate and phosphate loads and, together with the nutrients and contaminants from urban runoff, produces an assault on the aquatic environment that has resulted, at best, in eutrophication, and at worst, in its almost total destruction and associated loss of biodiversity.

Highly polluted systems are characterized by the loss of fish life and small, specialized benthic life (composed of chironomid larvae and tubificid worms) as was recorded for the River Thames in the 1950s (GESAMP 1990; Allan and Flecker 1993) and other rivers (Whiteley 1994). Eutrophication of rivers, nearshore marine ecosystems and semi-enclosed seas (such as the Baltic, Black Sea and Mediterranean which are naturally oligotrophic), although producing less profound effects on species diversity, alters species composition and destroys the integrity of the ecosystem (Caddy 1993; Hammer *et al.* 1993).

Urban centres have substantial daily freshwater needs. Abstraction can have serious effects on species diversity and composition, both within the river, where lower water levels affect the fauna and riparian vegetation (Binford and Buchenau 1993) and in the nearshore waters where rivers meet the sea. Reduced water flows have caused increased salinity in San Francisco Bay, the Caspian Sea, the Black Sea and the Mediterranean with effects including a reduction in fish populations and changes in the composition of fish communities (GESAMP 1990; Caddy 1993; Goudie 1993).

A common phenomenon near and within urban areas as a means of flood control, channelization drastically alters the physical characteristics of a stream, increasing water velocity and reducing habitat diversity and riparian vegetation (and thus nutrient input to the stream). As a result some species are eliminated and species composition is altered (Allan and Flecker 1993; Binford and Buchenau 1993; Goudie 1993).

City-produced contaminants (such as CO₂, SO₂, nitrous oxides, ozone, etc.) have effects within the city, close to the city and globally (Berry 1990; Hawksworth 1990; Westman 1990). Lichens have proved to be excellent monitors of sulphur dioxide pollution which has caused the absence of any species in the central areas of some major cities and their severe reduction in cover and diversity

(over 80% reduction in the worst cases) in polluted urban areas with potential knock-on effects on a range of vertebrates and invertebrates associated with them (Hawksworth 1990; Goudie 1993; Loucks 1994). Loucks (1994) suggests that such pollution effects, although not well documented, occur in other groups such as plants, birds and other biota. Urban air pollution also affects adjacent habitats: Westman (1990) records changes in the structure of the Californian coastal sage scrub ecosystem with replacement of native shrubs by exotic annual plants as a result of urban pollution, and Goudie (1993) reports on smog damage to Ponderosa pines 129 km away from the pollution source – Los Angeles. Finally, at the global level urban air pollution is implicated in the greenhouse effect, global warming and sea-level change, with all their associated effects on biodiversity (Berry 1990).

Direct effects: Obviously urbanization contributes to one of the key factors in loss of biodiversity – the loss of habitat – and since urban centres tend to be near rivers and coastal areas, wetlands and coastal ecosystems have been most affected (Walker 1990; Schmid 1994). For example, human settlement is seriously implicated in the current threats to important Asian wetlands (Scott and Poole 1989), in the loss of natural flood plains in North America and Europe (Allan and Flecker 1993), and the loss of much of California's coastal sage scrub habitat (Westman 1990). However in terms of the extent of habitat lost the effects are not yet very serious. For example, the United Kingdom is highly urbanized and densely populated yet the built-up area of 1.3 Mha (Wynne *et al.* 1995) constitutes only 5.3% of total land area although it should be noted that urban development requires vast amounts of materials – rock, sand, gravel – which destroys natural habitat and alters the landscape (Douglas 1990). The densely-populated city-state of Singapore (45 869 people per km²), for example, still has considerable vegetation (see Box 11.2-10).

Perhaps a more serious effect of urbanization is that of habitat fragmentation and its effect on ecosystem structure and function. This has been the subject of much debate for over two decades (for a review of this issue, see Saunders *et al.* 1991). The process of fragmentation, as well as reducing the size of the habitat, causes changes in microclimate which affects the biota as do the size, shape and location of fragments in the landscape (Saunders *et al.* 1991). In addition, the biota themselves respond differently to fragmentation depending upon their size, life-history strategy and their role in important ecological interactions (predator–prey, pollinator–plant, etc.) (Cody 1986; Soulé and Simberloff 1986; Wilcove *et al.* 1986; Renman and Mortberg 1994). A useful general conclusion is that the smaller the remnant, the greater the chances of extinctions and disruptions of ecological processes altering species composition; and the greater the 'edge' effect which may alter species composition and may enhance invasion of alien species (Saunders *et al.* 1981; Wilcove *et al.* 1986). While the effects of fragmentation on natural and semi-natural urban areas is poorly documented, the above effects have been recorded in several cases (e.g. Renman and Mortberg 1994; Turner *et al.* 1994).

The search for solutions to the problem of habitat fragmentation has led to a whole new science of greenways or corridors – belts of land that link fragmented habitats (e.g. several papers in Smith and Helmund 1993; Hudson 1991). Although the benefits of such links in maintaining species diversity have been shown, negative effects are also possible, leaving the issue inconclusive at our present level of knowledge. (e.g. Simberloff and Cox 1987; Saunders *et al.* 1991; Noss, 1993).

Noss (1993) considers that roads are the single most destructive element in the habitat fragmentation process and that roads are also destructive in their own right, resulting in serious losses of wildlife through road deaths,

Box 11.2-10: Major vegetation types in Singapore.

Category	Type	Total area (ha)	Number of plant species	Number of species per ha
Primary	Rainforest	100	1200	200–300
Spontaneous secondary	Tall secondary forest	1600	400	80–110
Spontaneous secondary	Low secondary forest and scrub	4000	150	20–70
Spontaneous secondary	Herbaceous vegetation	6000	300	20–80
Primary and secondary	Mangrove forest	250	25	2–15
Managed secondary	Parks, gardens, etc.	2000	1000+	5–50

Source: Corlett (1992).

Box 11.2-11: Way (1977) records the following from an examination of roadside verges in Britain:

- (1) 870 species of mostly native plants (from a total of 2000 species), including 35 of the country's threatened species.
- (2) Breeding habitat for:
 - 20 of the country's 50 species of mammals
 - all 6 species of the country's reptiles
 - 40 of the country's 200 species of bird
 - 25 of the country's 60 butterfly species
 - 8 of the country's 17 bumblebee species
 - 5 of the country's 6 species of amphibian.

and aiding the transfer of non-native species and range extensions of native species (Noss 1991, 1993; Goudie 1993). However, the very specialized habitat of roadside vegetation reveals some surprising contributions to the conservation of native species (Box 11.2-11).

Some human-made habitats have lower biodiversity than their natural counterparts, (for example, the landscaped park versus forest (Corlett 1992; Hails 1992) although higher densities of certain species may be recorded (Goudie 1993; Gliwitz *et al.* 1994; Luniak 1994). But the urban environment includes a great diversity of habitats – refuse tips, sewage farms, waste ground, derelict ground, disused railway yards and railway rights-of-way, buildings (both inside and outside), pavements, parks, etc. – and the literature documents their value for wildlife (e.g. Wee and Corlett 1986; Goudie 1993; Ahern and Boughton 1994; Shepherd 1994; Trojan 1994; Whiteley 1994). In some cases these habitats play a significant role in the conservation of 'rare' species. For example:

- the rare limestone specialist plant which thrives well on the brick rubble of demolition sites and on limestone railway ballast in Britain (Shepherd 1994);
- the number of nationally scarce beetle species in Britain which were found among the 60 beetle species thriving on the shop floor of a factory six years after its closure (Whiteley 1994);
- the rare US prairie species found alongside railroads and highways where they are protected from agricultural activities which have destroyed much of the original prairie habitat (Ahern and Boughton 1994).

The modern planning ethic, beginning perhaps in the 1970s with the recognition of urban ecology as a separate discipline, is placing more emphasis on the maintenance of

biodiversity in the urban environment (Nicholson-Lord 1987; various papers in Platt *et al.* 1994 and Smith and Hellmund 1993). Thus urban areas should be seen as management challenges for those concerned with biodiversity, not simply as sterile biological wastelands of interest only to humans (see discussion in Section 13.3.8.1).

11.2.3.4 Consequences of increasing demand for resources

As technological advances in transportation and communication have made the world smaller, trade between all parts of the globe has increased in magnitude and frequency. Now a major force in the relations between and within nations as witnessed in the recent negotiations over the General Agreement on Trade and Tariffs (GATT), trade has profound impacts on biodiversity. While the impact on biodiversity of various kinds of trade (including a comparative assessment of barter and monetized trade), and the effect of trade liberalization, has not yet been evaluated systematically, some indicative trends can be discerned.

The global market tends to separate resource management from the consumers, so feedback systems which work at simpler levels of technology, and which require corrective action from people, are no longer operative. In fact, one major difference between local people and the global market system – between ecosystem people and biosphere people – is the differential opportunity for escape. That is, the market can easily move from one place to another for its resources, but the local people are stuck in situ (Dasmann 1988). The rules of democracy, with voters making decisions about the fundamental choices of society, apply within national boundaries; but in the global market, companies can often elude decisions they do not like and look across national boundaries to find lower wages or labour standards, more permissive environmental laws, or laxer financial regulations (Daly 1992; Dionne 1993). This can apply at the governmental as well as corporate level (Box 11.2-12).

An obvious conflict also exists between an international policy of free trade and a national policy of internalization of external environmental costs. A country that internalizes environmental costs into its prices will be at a disadvantage in free trade against countries that continue to externalize these costs (Daly 1992). A weakening of domestic environmental norms could result.

Another aspect of trade which becomes a factor in biodiversity loss is 'tariff escalation', the practice of levying progressively higher tariffs on more processed goods. This discourages commodity producers from adding value to their exports by processing them. Tropical products in particular are targets for tariff escalation practised by developed countries. Even after the Uruguay Round it is still applied to tropical timber, coffee, cocoa and various tropical fruits. In West African and Asian

Box 11.2-12: Trade in toxic waste.

The cross-border trade in toxic waste began as a general practice in the late 1970s and continued to grow throughout the 1980s and into the 1990s. Although just a handful of industrialized countries produce 95% of the world's hazardous waste, the international trade of that waste has been encouraged by global economic relationships. Extensive and increasingly inexpensive transport and communication networks, put in place for trade in commodities, has facilitated the trade in toxic wastes. This movement has been driven by cost factors spurred by environmental concerns in waste-producing countries. For example, while the disposal cost per tonne of hazardous waste in the USA in the 1980s was upwards of US\$250, in Africa waste was being dumped for as little as US\$2.50 per tonne.

By the late 1980s, 30–45 million tonnes of toxic waste made its way across borders every year. Over half of this trade appeared to be with non-OECD countries, with some 20% going to Third World countries.

The resulting damage to biodiversity and the environment more generally from the import and recycling of hazardous waste harms the economies of these developing countries. In many cases the waste contamination effects begin to show themselves over the long term in the diminished health of people, lower agricultural productivity of land, contamination of the food chain and of ground water, and harm to wildlife and biodiversity.

In brief, global trade links have enabled waste to be moved cheaply, and poverty and international debt patterns have encouraged its movement to less industrialized countries in need of foreign exchange. This process can only compromise economic development prospects in the future and thus fuel a vicious cycle of poverty and environmental damage. In several cases, waste traders have bypassed international regulations by relabelling hazardous wastes as commodities to be recycled.

In early 1994, the 'Third World-NGO Alliance' was successful in raising the issue of a ban on the Movement of Hazardous Waste and its Disposal. However if this ban is successful and stops the dumping and recycling of hazardous waste in poor countries, it may lead to an increase in transfers of dirty technology and the movement of entire dirty industries to non-OECD countries (Clapp 1994).

countries, at least, this necessitates the use of a larger amount of land for plantations than would be needed if exporting processed crops could earn them as much foreign exchange as they get exporting the raw materials.

Subsidies for the production of commodities or processed goods can encourage over-exploitation of natural resources and degradation/pollution of the environment. Examples include agricultural and energy subsidies in the industrial countries, especially in eastern Europe and North America. Conversely, when developing countries are forced to relinquish agricultural import controls, dumping of subsidized food increases, with attendant economic, social and environmental impacts. Small-scale farmers are forced to intensify production on fragile lands, and/or are displaced from their land when they are undercut in domestic markets by cheap, subsidized imports (Box 11.2-13).

In the case of other economic sectors (industry, fisheries, mining), the example of India is instructive. Since 1990, the country has begun 'opening up' its economy to free trade, and is consciously moving towards an 'export-driven economy'. Analysis of the economic activity consequent on this transformation suggests that severe social and ecological disruption is resulting (PIRG 1993, 1994). The exploitation of marine products, for instance, has increased; 56 fishing and fish processing projects, and 19 aquaculture projects, all of which are 100% export-orientated, were cleared in the period 1992–3 at a time when the fish catch was stagnant due to previous overfishing. Discontent among India's several million small-scale fisherfolk is running extremely high due to the large-trawler-orientated fisheries policies of the government (Kothari 1994b, 1995). Apart from its impact on local fisherfolk and coastal ecosystems in general, specific concern has also been expressed about the implications of trawler operations on endangered marine species of fauna. For instance, at least one and possibly four jetties are being constructed or planned close to Bhitarkanika Sanctuary, in the eastern Indian state of Orissa, to service deep-sea trawlers. Bhitarkanika harbours the world's largest nesting colony of the Olive Ridley turtle, a severely endangered marine reptile. Several other protected areas in India are threatened with denotification by state governments eager to open them up for commercial exploitation (Kothari 1995).

Another facet of trade which threatens biodiversity is the often highly lucrative trade in wild species. Although such trade has led to significant declines of populations and endangerment of some species in the past (e.g. the long history of trade in crocodile skins; Thorbjarnarson 1992), today it is characterized by its elevation to global status for a much larger number of species which are sought after by more affluent populations. The range of species involved and the size of the trade are quite staggering. It is estimated that annually this involves (WWF 1994):

Box 11.2-13: Trade, maize and biodiversity in Mexico.

While it is admittedly difficult to generalize about the effect of trade agreements on biodiversity worldwide, the probable effects of the North American Free Trade Agreement (NAFTA) on the great diversity of maize in Mexico may be an indicator. Mexico is within the primary region of maize diversity: the crop occupies around 35% of the arable land, with 72% of all farms producing it (Salcedo, *et al.* 1993). Most maize producers are small peasant farmers (Montañez and Warman 1985; CEPAL 1982). Though the last 40 years have seen dramatic changes in Mexican agriculture, with the adoption of modern cultivation methods and laboratory-generated seeds, farmers continue to plant landraces (Hibon *et al.* 1992). Government support has been essential for the maintenance of many small farmers producing maize. However, the Mexican government is now changing the economic and institutional environment of peasant agriculture, including modifications to the Agrarian Law, eliminating price supports and subsidies to inputs and marketing infrastructure, and opening the borders to foreign imports of crops such as maize, particularly under NAFTA (Hewitt de Alcantara 1991; Salcedo *et al.* 1993; Solleiro *et al.* 1993). Many farmers, particularly small peasant producers, might not be able to compete in this changing environment (Levy and Wijnbergen 1991; Salcedo *et al.* 1993), especially because the price of American maize is substantially lower than Mexican maize (at least partly due to hidden subsidies to the US maize growers). As a result they may stop planting maize altogether, at least in many agro-ecological niches currently used for the crop. This may translate into a significant loss of the maize diversity that has contributed to maize production in this country and world-wide (Mangelsdorf 1974; Goodman and Brown 1988). Other impacts on biodiversity could occur if large-scale, chemical-intensive monocultures replace the small-scale farms, and if the displaced farmers turn to alternative forms of livelihood that are environmentally harmful.

- 26 000 live primates
- 2 million live orchid and cactus plants
- 1 million live birds
- 45 000 wild cats
- 10 million reptile skins
- 9 million reptiles

However, the trade presents a dilemma. Trade places a market value on wild species, encouraging sustainable exploitation rates and indeed the trade in most wild species is sustainable and a valuable source of income for local people. Yet the very global status of today's trade coupled with the rising affluence of potential buyers has brought certain naturally rare or already endangered species to the brink of extinction through over-exploitation. Such is the value of trade in wildlife that controls on trade at both national and international levels (the latter through the Convention in International Trade in Endangered Species of Wild Flora and Fauna (CITES)), as they have become tighter and more effective, have encouraged the development of a highly sophisticated illegal network with low investment costs and potentially huge profits. For example, the uncovering of an illegal crocodile-skin trading operation by CITES revealed that the skins, obtained in South America and shipped to Europe and Asia, produced profits of more than US\$60 million, and a macaw (which can only be traded illegally) can be bought in a South American market for US\$100 and sold for US\$5000–6000 in European and North American markets (Le Duc, 1990).

Appendix I of CITES (which prohibits all trade in a species) lists over 600 threatened species of animals and plants that are, or might be, affected by trade (Burgess 1994). The scale of the trade and its very nature in some instances where the 'rareness' of a species adds dramatically to its value, constitutes a growing threat to an increasing number of species. Jenkins and Oldfield (1992) attest to the appeal to collectors of the rare and the unusual in the plant world and cite the examples of the Mexican cactus, the south Indian lady's slipper orchid and the giant pitcher plant as species that have been driven near to extinction by collectors. This kind of valuation of wildlife clearly puts some of those vulnerable species (those that are rare or of limited distribution) in high demand.

The illegal trade in rhino horn (used for medicinal and ornamental purposes) has been almost entirely responsible for the drastic decline of black rhinoceros over most of its range in Africa during the last 15 years (Cumming *et al.* 1990), and the exploitation of tiger parts for the Asian medicinal market is currently the biggest threat to the survival of the tiger already under severe pressure from habitat loss (Jackson and Kempf 1994). Mills and Servheen (1991) describe the trade in bears and bear parts (particularly gall bladder) in Asia where the rising affluence of some Asian countries is increasing the demand to the extent that trade in four species of Asian bear is a threat equal to or greater than habitat destruction and human encroachment. In South Korea these authors record that bear gall bladders are priced, gram per gram, at up to 18 times the price of gold. Similarly, when one considers that the sale of one tiger skeleton can yield profits worth more than ten times a year's salary in some countries

(Table 11.2-19), a continuing illegal trade, even when populations are critically low, seems almost inevitable.

11.2.3.5 Economic systems and policies that fail to value the environment and its resources

Many conversions of natural systems (such as forests or wetlands to farmlands and rangelands) are economically and biologically inefficient. They happen partly because of the urgent need for agricultural land, regardless of how sustainable cultivation is, and partly because natural habitats are commonly undervalued economically (Hufschmidt *et al.* 1983; Orians *et al.* 1990; Swanson and Barbier 1992; Pearce and Moran 1994).

Further, with the levels of uncertainty and the inability of scientists to predict future events, can anyone be sure that all the benefits and costs have been accurately accounted for? How much of a risk can society take in depleting the genetic resources that exist today, based upon current levels of knowledge? Even for countries that might appear to be able to afford further reduction of natural capital stocks, the risks from so doing are still high because of: (a) imperfect understanding of the life-support functions of natural environments (de Groot 1992); (b) the fact that losses are often irreversible; and (c) lack of substitutes for those functions, even if their loss is reversible in theory. Some economists therefore posit a rationale in terms of uncertainty and irreversibility for conserving the existing stock, at least until society has a clear understanding of what the optimal stock is and how it might be identified (Pearce *et al.* 1990).

Biological resources are mis-valued for several reasons. First, many biological resources are consumed directly and never enter markets. Among forest products, sawn timber, pulpwood, rattan and gums are likely to be marketed while much of the food, fuelwood, and medicinal plants harvested by local people will be consumed directly by them or their families (Collier 1990). Accordingly, the economic values of unsustainable logging and other

potentially exhaustive uses are overestimated while sustainable uses (and aesthetic and spiritual benefits) are underestimated, creating incentives to impoverish biodiversity (Desaigues and Point 1993).

Second, biodiversity's benefits are in large part 'public goods' that no single owner can claim (Ciriacy-Wantrup and Bishop 1975; Berck 1979; Stevenson 1991). Wetland protection, for example, benefits the public tangibly and quantifiably, but the benefits are so diffuse that market incentives for wetland conservation seldom develop. This undervaluation then justifies government policies (such as tax incentives) that further encourage wetland conversion to uses with greater 'market value'.

Third, property rights are more likely to be granted to those who clear and settle forests and other lands covered with natural vegetation than to forest dwellers living by the sustainable harvest of natural products (Dasgupta, 1983; Repetto, 1988; Price, 1989). Formal property rights are also often easier to obtain by people living in cities and working in the formal sector of the economy – which itself favours the extraction and marketing of products such as timber over the sustainable harvest of products with limited market value. Any uncertainty over property rights weakens incentives for stewardship and encourages over-exploitation. Few farmers will plant woodlots that they might not own five years later. People who do not benefit from a tourist industry, but need food, are more likely to kill than to protect wild animals. People who have no stake in a resource are the least likely to care for it and the most likely to alter it if doing so establishes ownership (Stevenson, 1991).

Biologically diverse natural systems are major economic assets (Pearce and Moran 1994). But because such systems are commonly undervalued, biodiversity conservation is seen as a cost rather than an investment, a burden rather than an opportunity.

Business accounting is relatively routine. By comparing the balance sheet of a company from one year to another an

Table 11.2-19: Prices paid for tiger bone to poachers and middlemen in range states.

Country	US\$/kg	US\$ per skeleton	Per capita (average) GNP
Cambodia	100	1700	200
China	31–126	527–2142	435
India	15–200	255–3400	310
Lao PDR	12–76	204–1292	230
Nepal	100–130	1700–2210	180
Russia	20–300	340–5100	2100
Vietnam	100–375	1700–6375	220

Source: Mills and Jackson 1994.

owner can see whether a company is growing or shrinking, and how fast. Environmental accounting (sometimes called 'green accounting') seeks to provide similar measuring tools for the environment (Daly and Cobb 1989; Pearce *et al.* 1989; Howarth 1990; Costanza 1991; Craig and Glasser 1993). However, environmental accounting is vastly more complex than accounting in the business world. Not only is there no accepted methodology to perform environmental accounting, but consensus, at least over the near-term, is unlikely.

Business accounting deals with goods and services that can usefully be inter-compared in terms of their monetary value. It also generally operates over relatively short time-spans. Environmental accounts are far more complex. They must include the value of a landscape, of a species of bird or fish, and of an undammed river. They must not only reflect the direct cultural, spiritual, economic and social values of these entities to humans, but also the more intangible values of these entities as members of tightly coupled ecosystems. Environmental accounts must address change at many scales: local, regional and global. They must provide information about both the near-term and the distant future. Environmental accounting for sustainability must be able to incorporate and illuminate our ideas about what kind of a world we want to leave to the future (Norgaard 1992).

All accounting systems incorporate social values and perceptions about how the world is organized and how it will unfold. The way an accounting system is constructed – what it includes, what it excludes – affects both the kinds of questions it can answer and the kinds of questions it cannot answer. In environmental accounting, basic conceptual issues are a more fundamental matter. Different people are likely to value a river valley in very different ways: as a place to hike, swim, or watch a rare bird; as a dam site; as a resort site; as a place to raise and harvest a cash crop of timber; as the home and source of physical and spiritual sustenance for indigenous people; or as a speculative investment. An additional complication is that each individual may recognize a variety of senses of value.

The further to the future one seeks to plan, the more uncertain and unforeseen effects matter. For example, if a resource is unknown, or if it is known but considered to have no value, then it will not be represented in an accounting system. The idea is best understood from an historical example. In 1850, in the early stages of the Industrial Revolution, coal was the dominant energy mineral. An energy accounting system of 1850 would ignore oil, except possibly for a minor entry for whale oil used for lamps. There would be no mention of uranium, which in 1850 before the discovery of radioactivity and fission, had no conceivable utility. The 1850 accounting system would reflect knowledge and technology of the time. It would view coal as a source of heat energy, but

would miss its potential as a fuel for electricity generation. The valuation of known coal deposits would entirely miss the collapse in the value of coal following the discovery of massive oilfields later in the century.

No discussion of economics and biodiversity can be meaningful without some idea of what we think should be sustained and for how long. Sustainability is necessarily a normative notion that demands some relatively objective measures to indicate whether conditions are improving or deteriorating. Environmental accounting can rarely give precise answers, but it can be an enormous help in framing issues and in sharpening ideas. Daly (1990) provides a useful starting point, pointing out the two obvious principles of sustainably using renewable resources. First, that harvest rates should be equal or be lower than regeneration rates (sustainable yield). Second, that waste emission rates should be equal to or lower than the natural assimilative capacities of the ecosystems into which they are emitted. Regenerative and assimilative capacities must be treated as natural capital, and failure to maintain these capacities must be treated as capital consumption, and therefore not sustainable.

The two 'common sense' principles for the establishment of sustainable policies differ from traditional approaches to economic accounting in several ways. They are based on biological, geological and physical knowledge. They are directly coupled to observable systems with specific indicators of achievement. They are explicitly dynamic, and take account of rates: e.g. harvest rates, regeneration rates, waste emission rates, and the natural assimilative capacities of ecosystems. Daly's notions are consistent with the idea that natural capital can be consumed and transformed into other forms. For example, it may be more 'sustainable' to use a depletable resource rather than harvesting some resource indefinitely. Fossil oil, for example, might provide a springboard to sustainable photovoltaic electrical systems, thereby avoiding the damming of wild rivers.

Human inventions can change the character of resources, but they can never fully substitute for them. Daly (1990) clarified why natural capital and human-made capital are complementary, and why both are needed. Extra sawmills cannot substitute for diminishing forests; more refineries cannot substitute for depleted oilwells; larger nets cannot substitute for declining fish populations. On the contrary, the productivity of sawmills, refineries, and fishing nets (human-made capital) will decline with the decline in forests, oil deposits, and fish. Natural capital as a provider of raw material and energy complements human-made capital, just as natural capital as absorber of waste products is complimentary to the human-made capital which generate those wastes.

The fact that environmental accounting incorporates perspectives on how the future will unfold is a major

strength as well as a problem. Accounting systems can help us expand the scope of our thinking. They can help us better understand points of view that differ from our own, thereby improving our ability to address previously unforeseen, but not unforeseeable, consequences of our actions. Accordingly, environmental accounting systems should also be able to capture the views of both technological optimists and technological pessimists; of those with little interest in 'natural' systems as well as those who believe that 'development' and 'quality of life' involve far more than an ever-increasing GNP.

Environmental accounting systems should attempt to represent the full set of goods and services provided by the global ecosystem. They should incorporate a multiplicity of notions of sustainability. They should incorporate distributional and intergenerational equity considerations, recognizing the concerns of those hurt by change (e.g. those displaced by new dams, by conversion of rain forests to cropland, or by sea level rise due to global warming) as well as those who are advantaged.

These general ideas allow one to understand why existing systems of national accounts (e.g. GNP and GDP measures) exhibit so many difficulties when they are applied to environmental planning. Three particular difficulties of conventional accounting deserve examination (Anderson 1991): (1) failure adequately to separate 'goods' from 'bads'; (2) uncertainty; and (3) over-reliance on single attribute (monetary) measures of value.

GNP measures do not distinguish between Goods and Bads. Medical care resulting from air pollution adds to GNP. So do the costs of restoration following storms or earthquakes, the costs of pollution control equipment, and investments made to preserve species. One can imagine a society with an ever-increasing standard of living as measured by dollar income, and yet an ever diminishing quality of life (Cobb 1989).

Information: national accounting systems. At present, national accounts rely on the notion that all important values can be compared and aggregated by expressing them in monetary terms. The key assumption is that monetary measures can capture all relevant senses of value. A controversial question for environmental accounting is whether to adopt this perspective.

Experience thus far suggests that ecological systems are far too complex to be usefully described by any single measure (Ludwig *et al.* 1993). Efforts to do so obscure how much is known. They fog issues and muddle real differences of perspective. Environmental accounting systems should illuminate diverse goals. They should be able to reflect the views of those who believe that technical ingenuity and 'progress' will provide future generations with undreamed – of opportunities and few adverse side-effects. And those who believe our generation is depleting the world of irreplaceable resources and impoverishing our

descendants and the rest of the world should also be able to employ economic concepts to illuminate their views.

To summarize, present accounting systems:

- include embedded assumptions about what is important now, what will be important in the future, and the nature of change;
- tend to emphasize quantities that enter into commerce;
- emphasize flow variables over stocks;
- often do a poor job of representing uncertainty;
- have difficulty dealing with 'side effects' or 'externalities' especially those which are uncertain in character and delayed in time;
- are not well suited to coping with limits, dynamic effects, irreversibilities (like loss of species), or characteristics that cannot be represented in monetary units.

What appears good to one person or group may appear bad to another. Further, values can and do change with knowledge and experience, and from one generation to another. Accounting systems must be responsive to this diversity. While no satisfactory system of environmental accounts is as yet in sight, it is possible to suggest some directions:

- Many kinds of measurement units should be included. Biological, geological, physical and equity indicators should figure prominently.
- indicators should be but one of many measures and they should not be determinative, as with benefit-cost analysis.
- A large range of spatial and temporal scales should be accommodated along with different levels of aggregation.
- Uncertainty should be explicitly addressed.
- There should be capability to represent many perspectives, including minority views.
- Environmental accounting systems should be linked to specific conceptual models. Data cannot be comprehended except in the context of logical structures. An example is the connection between anthropogenic carbon emission and climate. Without a conceptual framework (in this case climate models) data in this area would be incomprehensible.
- Optimization model approaches have serious limitations.
- Environmental accounting systems should be dynamic, flexible and adaptive. They should be structured so that their internal organization can be updated as new indicators and information become available.

Key Messages

- Virtually every decision people make can have an influence on biodiversity, either positive or negative. Losses in biodiversity can affect the sustainability of society. Continued policy failures can lead to domestic turmoil.
- Loss of biodiversity at the hands of people will continue and even accelerate, because the amount of space on our planet and the natural resource base are fixed, but both consumption and human population are expanding, leading inevitably to increasing pressure on limited resources. Therefore, these resources need to be managed more effectively, and the policies adopted need to be supportive of the Convention on Biological Diversity.
- Although it is by no means clear whether poverty, with its pressures to survive, or affluence, with its pressures to consume, ultimately leads to greater loss of biodiversity, it is obvious that the rural poor cannot conserve their biological resources if this is in conflict with their immediate survival needs.
- Human activity is not necessarily incompatible with the maintenance of biodiversity, and many human actions tend to foster greater biodiversity (especially components which people consider desirable). However, some important components of biodiversity are most likely to prosper in areas that are remote from human influence; where extreme environmental conditions prevail; or are associated with conditions provided by humans (for example, within protected areas, agricultural lands, and other systems that are managed by people).
- Tropical islands can provide a preview of the environmental situation that is likely to become more prevalent on the world's continents in the future. These islands typically have high population densities, exhibit highly fragmented landscapes, and have already experienced significant extinction events. On the other hand, their landscapes are now enriched by the addition of imported plants and animals that form new combinations of communities and ecosystems (which sometimes replace native species and communities which may have been unique in the world).
- Economics provides a useful perspective for understanding human relationships with biodiversity. Property rights is a crucial element in understanding why biodiversity is lost. Goods can be bought and sold only when property rights to them are well defined, where the seller truly owns the goods, and has the right to transfer these goods to others. Biodiversity, on the other hand, is a public good that is provided to everyone, rather like law and order and defense. Market economies, if left to themselves, typically under-provide public goods. Thus property rights work well for bread as a private good, but much less well for a public good such as genetic variation in wheat types. The full social benefits of tigers, rhinos, portfolios of germplasm, marine resources of a global commons, and so forth, are public goods beyond appropriation by markets, even when market value is fully enhanced by all the devices of the law. Therefore, new policies are required which help enable public goods to be managed for the benefit of society.

Efforts to develop alternative environmental accounting systems are at an early stage, but the process of refining existing accounts and proposing alternative accounts is helping to sharpen discourse and illuminate critical assumptions and issues.

11.2.3.6 Inequity in the ownership, management and flow of benefits from both the use and conservation of biological resources

In most countries, ownership and control of land and biotic resources, and all the benefits they confer, are distributed in ways that work against biodiversity conservation and sustainable living. The rapid depletion of species and the destruction of habitats are the norm in many countries where a minority of the population owns or controls most of the land. Profits from logging or fishing flow to the few,

while the local communities dependent on the continued production of the resources pay the price (see also 11.2.3.1.3).

A second problem arises from the concentration of resource control and responsibility for environmental policy decisions primarily in the hands of urban men. In many societies women manage the environment and possess far greater knowledge of biodiversity's value to farming and health.

A third issue is the way international trade, debt and technology transfer policies and practices foster inequities that resemble – and often reinforce – those found within nations. By 1988, developing countries were transferring \$32.5 billion net to industrialized countries, excluding other implicit resource transfers not involving direct financial flows (United Nations 1989). (At the beginning of

the decade, \$42.6 billion had been flowing to developing countries.) Between 1986 and 1993 developing countries paid \$1253 billion to serve a growing foreign debt that reached around \$1550 billion in 1994 (IMF, 1994). If the developing countries continue to be shut out of markets, deprived of access to technology, and burdened with debt, they will have neither the means nor the incentive to conserve their resources for the future.

11.2.4 Conclusions

The major cause of biodiversity loss in recent historical times is human action, primarily land use that alters and degrades habitat to serve human needs (Pimm and Gilpin 1989; Freedman 1989). Yet the ability to forecast the impact of specific actions on biodiversity is not yet well developed, and practical techniques for conducting such analyses are at only a very preliminary stage (OTA 1987; Soulé and Kohm 1989). Machlis and Forester (1992) have pointed out that while a large number of conceptual and predictive models of the interactions between humans and nature exist, explicit models of biodiversity loss are sparse and incomplete. While many of the generic models treat 'environmental change' or 'ecosystem alteration' as the dependent variable, it is not at all clear that biodiversity loss can simply be substituted for these more general factors. Biodiversity loss is a special case of environmental change, and the socioeconomic factors that influence it may not have generic impacts. For example, biodiversity loss measured as a reduction in species richness may be so dependent upon the original number of species at a specific locale that certain generic models will fail to explain, much less predict, even the most dramatic levels of biodiversity loss. The importance of habitat in the preservation of biodiversity may suggest that spatial relationships at the local scale will play a more significant role in biodiversity models than, say, models of climate change.

However, it seems apparent that the issue of scale is crucial, as biodiversity loss is embedded in a complex human/environment system that operates at several hierarchical levels; socioeconomic factors important at one scale may be less important at another, and at each different scale, new variables and relationships may emerge as critical driving forces.

The driving forces of human-induced change will vary with the type of change involved, and forces that drive some changes may lessen others (Meyer and Turner 1992). For example, rising agricultural prices may provide an incentive for clearing forests, while also providing an incentive to adopt soil conservation measures. Second, the same kind of land-cover change can have different sources in different areas, with deforestation in some areas primarily for timber extraction, in others for shifting cultivation, and in others for establishment of plantations.

In the dynamics of underlying causes, no agreement yet exists on the level at which adequate explanation is achieved. For example, some may consider that deforestation by agricultural expansion is driven by population growth, while others would contend that agricultural expansion helps to cause population growth; others will suggest that population growth needs to be explained in terms of the socio-political and economic conditions that promote it. Ehrlich and Ehrlich (1990) have attempted to provide a single comprehensive approach to the question of driving forces, using the equation $I = PAT$ where I represents environmental impact, as the product of P (population), A (affluence) and T (technology). Thus, human impact is a product of the number of people, the level at which they consume, and the character of material and energy flows in production and consumption. Meyer and Turner (1992) have pointed out that this formula suffers from the handicap of a mismatch between its categories of driving forces and the categories customarily used in the social sciences. Neither 'affluence' nor 'technology' is associated with a substantial body of social science theory.

Today's pressures on the natural world mean that the genetic diversity of many species is being reduced because the total sizes of populations are decreasing and they are often being split into small, widely separated, subgroups which cannot interbreed. Others might argue that this is one of the processes of speciation, with humans serving as a new isolating mechanism.

11.3 Information requirements for the sustainable use of biodiversity

11.3.1 Introduction

Effective action must be based on accurate information, and the more widely shared the information, the more likely it is that individuals and institutions will agree on the definition of problems and solutions. However, the current state of knowledge is still largely inadequate to evaluate precisely what are the impacts of human activities in different ecosystems, and to understand what are the relationships between economic activities, development and conservation of biodiversity. Gaps in knowledge may have at least three origins.

First, the lack of information resulting from an insufficient research effort, especially for the inventory of species and ecosystems (see 11.3.2.4), for understanding how components of ecosystems fit together and interact with one another, for information on traditional use and knowledge of biodiversity, and for changes in ecosystem use. A significant increase in funding and man-power could fill most of these gaps. However, while some scientists argue that until we understand the natural environment, it will be difficult to understand how human societies interact

with these systems, it is not realistic to wait for many years for conservation action. What to do in a situation of uncertainty?

The second major source of gaps derives from the complexity of the natural environment and the complexity of the interactions between human societies, their activities and the natural world. Natural and social sciences evolved independently, but better interaction between them is needed to understand the nature and strength of their relationships. The long-term preservation of biodiversity depends on management strategies and modes of development, but it is very difficult to forecast changes in human behaviour. This uncertainty makes it difficult to predict changes in the environment and the expected consequences for biodiversity, and it reinforces the need to monitor biodiversity carefully in order to respond with corrective action.

The third set of gaps involves access to information and how to use what we already know. How can technological solutions be applied on a large scale? While useful concepts such as 'sustainable development' and 'integrated management' are available, we need guidelines for action, supported by reliable observations and experiences. The effective implementation of biodiversity action plans relies on improved methodologies and tools.

In general, research must be expanded and strengthened to improve our understanding of biodiversity and its potential role in building sustainable human societies. We need to understand a great deal more about how, why and where human activities affect biodiversity, in order to provide accurate information to politicians and decision-makers. Research must serve to inform, supplement and improve conservation efforts, but it should not be a substitute for immediate action. However, even with a complete inventory of the status of global biodiversity, and a perfect understanding of the relationship between human activity and biodiversity, we will still face the problem of how to control destructive human behaviour.

11.3.2 Monitoring biodiversity, its use, and changes in natural and managed ecosystems

Different parts of the world are being subjected to varying degrees of transformation. Some areas have been altered by humans over long periods, while in other regions human influence has been moderate. The response to disturbance varies greatly from one ecosystem to another, so we need to monitor and document changes in biodiversity resulting from climatic changes or human activities in a variety of natural and managed ecosystems, and in different climatic zones (Solbrig 1991). To detect, measure and assess changes in the status of biological diversity, appropriate monitoring methods should employ specific indicators of biodiversity attributes, as well as indicators of

socioeconomic changes. One of the greatest difficulties is to distinguish the effects of natural fluctuations and changes from the effects of human-made disturbances. Another question still partly unanswered is what exactly should be monitored. Distribution and abundance of selected species? Changes in ecosystem structure, species composition, functions and processes? Distribution and area of different land-use classes, habitats, biotopes, ecosystems?

11.3.2.1 Long-term monitoring

Most of the questions asked of scientists by managers concern our ability to detect changes in the physical, chemical or biological state of the environment, and to distinguish cause from effect. We need data sets from good, regional, long-term monitoring to provide decision-makers with convincing data on environmental changes due to adverse impact (see Section 5). The selection of sites for long-term monitoring depends on the questions to be investigated, but in selecting sites, a good knowledge of their management history is most relevant to an understanding of the processes of change. However, long-term data collection programmes face problems of the continuity of the variables measured, continuity of funding, and comparability of data as analytical methods change.

Monitoring programmes are also faced with major difficulties in the interpretation of data. For example, species extinctions and ecosystem changes do not always result from a single disturbance but rather from the cumulative effects of many different disturbances, and it is not always easy to determine the relative importance of the different factors. Moreover, some environmental factors change gradually over time, while others create short-lived but major disturbances (such as acute pollution, volcanic eruption, or occasional extremes in climate) that could be very important determinants of long-term changes. If they are not recorded, the subsequent data sets will probably be difficult to understand. Moreover, ecological processes operate at a broader range of temporal and spatial scales than is typically addressed in ecological studies, and long-term research reveals processes and events that have often been invisible in the short term. Such is the case for slow changes occurring over years or decades, which are hidden in the so-called 'invisible present' (Magnuson 1990), i.e. we frequently observe the response of an ecological system to a cause that occurred before monitoring began, and in most impact studies we are seeing the transition of the system rather than the new state it is likely to reach.

A major issue in monitoring programmes, as well as in designing restoration programmes, is to identify a baseline reference situation with which to compare the collected data. Any impact study should refer to a standard 'natural' or 'non-perturbed' ecosystem. However, the 'natural community' has in fact already been disturbed virtually

everywhere and trying to ascertain its original characteristics is a risky task. What is a 'healthy' system which should serve as reference (Loehle 1991), and how to evaluate its 'integrity', are key questions for ecologists and managers (Woodley *et al.* 1993). The relevant normative goal of human–environmental relationships is to maintain the integrity of combined natural/cultural ecosystems. Natural and social scientists should collaborate in the design and execution of long-term pilot studies of ecosystem integrity in catchment areas that include human settlements, and not only relatively simple 'natural' ecosystems which have usually only recently excluded human occupation.

11.3.2.2 *Monitoring the rehabilitation of degraded ecosystems*

As populations increase, the proportion of modified land is likely to rise, and in areas of severe land shortage, the management of such lands will become a matter of significant concern. However, lands degraded by over-exploitation have received little attention compared with natural systems, and there is now a growing need to improve the scientific understanding on which the effective management of degraded ecosystems can be based.

Rehabilitation describes a management strategy designed to arrest the degradation of landscapes. It includes restoration, which aims to reinstate entire communities of organisms closely similar to those occurring in idealized natural systems. Research needs can focus on describing alternative methods for rehabilitation, including re-seeding of native species, plantations of exotics, etc. More information is required about the genetic structure, biology and ecological requirements of many plants or animals, and their potential for rehabilitating degraded sites. Research is needed on what species attributes would ensure successful invasion of degraded systems, and what is the most cost-effective way of screening the native or exotic flora and fauna to locate candidate species for (re)introduction (Soulé and Khom 1989). We also need to study and compare the rate of ecosystem recovery when submitted to natural and anthropogenic disturbance regimes, and to identify the impacts of different prior land uses on restoration potential, identifying the principal factors that affect restoration in different systems (USNRC 1992).

11.3.2.3 *Species introductions*

The devastating effects of introduced rats, pigs, cats or rabbits to oceanic islands are widely documented, but in most cases we know little about the impact of introductions on native communities and ecosystems when they do not result in ecological catastrophes. The list of plant and animal introductions is enormous and the future promises a continuing spread of exotic species. However, while the introduction of species has been encouraged all around the

world for centuries, both by managers and by scientists, many ecologists today are increasingly worried about their impacts.

Are introductions really a game of chance? Probably not, but we do not know the rules of the game. Many ecologists, more or less intuitively, claim that the introduction of exotics is risky, and Chapters 11.1 and 11.2 have mentioned cases that may be considered ecological disasters. Conversely, there are also examples of assumed success, and managers are very cautiously optimistic of using new species to improve agriculture or fisheries production, especially using biotechnology to produce genetically modified organisms.

However, one of the major problems with species introductions is their irreversibility, at least at human time-scales. Once introduced and established, it is almost impossible, given current technology, to eradicate an exotic species from a large ecosystem. Therefore, there is great need for a careful assessment of past experiences to provide general, scientifically based guidelines and policies about species introductions, taking into account both the potential ecological values and the economic values of these introductions. It is also essential to evaluate the potential long-term detrimental effects of introduced exotic species, under controlled conditions, and before their release.

Introducing genetically modified organisms presents unique risks because laboratory results alone provide a poor guide to their behaviour, ecological impacts and potential socioeconomic effects. Accordingly, strict Codes of Conduct related to the release of such organisms are urgently needed in all countries and at the international level (WRI *et al.* 1992).

11.3.2.4 *Inventory and data bases*

To assess long-term changes in biodiversity, a basic prerequisite is a good knowledge of species and their distributions in space – the task of biogeography. However, the inventory and descriptive phase of biodiversity is far from complete, and present-day estimates of the number of species on Earth is a matter of debate, because our knowledge of the species and their distribution is inadequate. The world database is still of variable quality, and there is a shortage of data for many taxonomic groups. There is an urgent need to accelerate collection along with description of organisms, particularly those that are ecologically important and threatened by human activities. A global network of systematists should be established to accelerate the inventory of global biodiversity through improved systematic practices (Solbrig 1991; Bisby 1994).

An effort should also be made to develop new and innovative ways of exchanging biological information, such as the use of computerized relational biological databases, so that it is possible to establish in-country user-friendly biodiversity databases for use in decision-making and for

analysis of trends. This is already under way by groups such as the World Conservation Monitoring Centre, and many of these efforts are discussed in Bisby *et al.* (1993).

11.3.3 *Strengthening social science research and the connections between biological and social processes*

The fundamental causes of the observed attrition of natural biological systems are rooted in the contemporary human condition, involving interactions between social and ecological processes. Therefore, the conservation of biodiversity must focus largely on economics, sociology and political science. Soulé (1991) recognized seven key factors to which our present knowledge does not allow definite answers:

- Population growth: what is the relationship between population growth and impact on biodiversity?
- Poverty: what is the impact of poverty on biodiversity? Conversely, what is the impact of wealth on biodiversity?
- Misperception of time scale: what is the impact on biodiversity of the short-term mentality of many governments and businessmen?
- Anthropocentrism: if a new ethic and a revolutionary change in human consciousness are necessary to support conservation purposes, why is there a general lack of support for non-utilitarian causes, and why are current cultural values usually human-centred?
- Cultural transitions: which socio-cultural situations foster loss of biodiversity and which foster conservation?
- Economics: what kinds of economic instruments foster the loss of biodiversity and which foster conservation?
- Policy implementation: what is the impact of social and political instability on biodiversity?

Another causal factor, not mentioned by Soulé, is the lack of responsiveness of decision-makers at the national and international levels to local indicators of environmental degradation, including indigenous knowledge and observation of user groups.

11.3.3.1 *Knowledge, innovations and practices of indigenous and local communities*

Faiths, cultures and traditions give people their basic orientations toward the natural world and guide their actions. Nature has been considered (and is still considered) by many people as an obstacle to human purposes as well as the direct or indirect source of all the material necessities and comforts of human life. For instance, aquatic ecosystems are considered both as a reservoir of biological

resources (fish, shrimps) to be preserved, and as a reservoir of diseases (malaria, schistosomiasis, etc.) to be eradicated. This dilemma may explain why human attitudes to nature differ from culture to culture, and have changed over time. Their importance is often overlooked in conservation programmes, while people's commitment to conserving and sustainably using biodiversity springs from the human 'sense of place'. There is a need to understand better how ethical norms and religions condition human behaviour toward biodiversity.

During the last two decades, the link between biodiversity conservation and sustainable socio-economic development has been recognized. It appears that the interests of some human groups have been strongly linked to the prudent use of their resource base, and that they have evolved appropriate conservation practices based on some simple and approximate rules that have tended to ensure the long-term sustainability of the resource base. These rules may have been developed by a process of trial and error, with acceptance of practices that appeared to keep the resource base secure coupled with rejection of those practices that appeared to destroy the resource base.

There is a need to recognize the value of traditional knowledge, and subsequently to develop a mechanism for the appropriate protection of, and compensation for, such knowledge (UNEP 1994). This can be achieved through (1) a better knowledge of biological resources being exploited, as well as the full range of uses and values of these resources, and (2) compilation of available information with the support of a group of specialists. We must also identify and develop means to maintain traditional knowledge and to strengthen and develop indigenous and local community strategies for conservation and sustainable use of biodiversity, fully respecting their intellectual and cultural integrity and their own vision of development. This research should build a greater understanding of the relationship between biodiversity and local systems of knowledge and resource use, and should translate this understanding into useful policy (USNRC 1992).

11.3.3.2 *Legal aspects*

The position of biological diversity in national legal systems is one of the important judicial problems of today (de Klemm and Shine 1993). Plants and animals are objects whose degree of protection depends on the value they represent for human beings. Although well intentioned, this specifically anthropocentric view leads directly to the subordination of biological diversity, and to its sacrifice in spite of modern understanding of the advantages of conservation.

One major concern is the implementation of legal instruments developed nationally or internationally. Most treaties and conventions are not obligatory for the

countries, and their application is usually delayed. Attention must be given to structural problems that contribute to biodiversity loss, such as unequal trade relations that might conflict with the conservation of biodiversity, or the impact of debt on the exploitation of biodiversity (IUCN 1994).

To strengthen the position of biological diversity in our societies we should provide the guidelines of legal procedures and ethical considerations. We should accept biodiversity as a legal subject, and supply it with adequate rights. This could clarify the principle that biodiversity is not available for uncontrolled human use. However, this non-availability should not turn into an unrealistic conservation. Contrary to current custom, it would therefore become necessary to justify any interference with biodiversity, and to provide proof that human interests justify the damage caused to biodiversity.

To realize the objectives of the Biodiversity Convention, biodiversity concerns must be integrated into mainstream public policy and law governing the natural resource-based production sectors, such as forestry, fisheries and agriculture. Many existing legal frameworks, issues, obstacles, strategies and prospects are associated with this integration (Glowka *et al.* 1994). The precautionary principle is increasingly seen to be of great importance to the conservation of biological diversity. In international environmental soft law, it has emerged as a recognition of the uncertainty involved in impact assessments and management, and in the determination of the future consequences of present decisions. However, its translation into binding rules of law is particularly difficult, and a number of legal problems will have to be resolved (de Klemm and Shine 1993). Its implementation in fisheries management has been suggested and FAO is currently developing Guidelines for Responsible Fishing (García 1994).

A whole new area in the legal world is the question of intellectual property rights. While the convention affirms the right of states to require payment for the commercial use of genetic resources obtained from their territory, the formalization of such rights, equitable as it may seem, gives rise to considerable practical difficulties. How will it be possible to determine the true country of origin when the resource has a distribution range overlapping many countries? What sort of recourse will a country of origin have if the genetic material has been smuggled out of the country? (de Klemm and Shine 1993). Disputes are therefore bound to occur and difficult problems of proof may arise.

11.3.3.3 Economics and biodiversity

Natural resources are crucial to human welfare so there are strong interactions between ecological systems, economies and social systems (Arom *et al.* 1993). Biologists have in

general displayed concern for the health and persistence of ecosystems as a foundation for human well-being, but usually oversimplify the economic side of the relationship. Conversely, many economists ignore natural systems and resources while many of the critical questions at the ecology–society interface involve economics (Ehrlich 1989).

Despite past neglect of environmental problems and externalization of environmental costs, a few economists since the 1970s have taken a broader interest in environmental issues. Growing environmental problems have not abandoned the idea that maximizing human welfare is an inherent goal of economics, but the goal has been deprived of its exclusivity. This change was due largely to scientists who argued that there were limits to human population and development (Goodland *et al.* 1991). Fortunately, the pessimistic scenarios foreseen for instance by the 'Club of Rome' and others (Goldsmith *et al.* 1972), have not occurred, but the decisive question raised by debates about the 'limits to growth' is still unanswered: How large can the human population become and how long can it be sustained with the available resources? To achieve global sustainability, economists must extend their theoretical horizons and consider the environment in production costs (Hohl and Tisdell 1993).

A major challenge is to evaluate the biological consequences of economic activities and to develop appropriate economic models for the sustainable use of natural resources.

11.3.3.3.1 Contribution of wild species to local economies and to international trade. A central question in the effort to conserve biodiversity is how local people affect the biological diversity of the ecosystems they inhabit (USNRC 1992). In other words, how do local people use biological resources? Why? And what is the overall contribution of wild species to local economy? What are the incentives of local people to use ecological resources sustainably and how can these incentives be transferred from the ecosystem to the biosphere? The screening of plants and animals for features of potential use to mankind should also be accelerated, in order to identify organisms of potential benefit in agriculture and in the provision of environmental services. Particularly important in this regard are traditional drugs which can be used to treat diseases in communities that lack access to modern medicine because of its expense (USNRC 1992). However, results of this screening should benefit local people directly where traditional knowledge leads to the identification of a resource with broader value, and it should be protected through local control from non-sustainable exploitation.

International trade in wild species deals with living specimens (ornamental plants, ornamental fish, snakes, parrots, etc.) as well as dead specimens for collections (shells, insects, etc.). It also includes the trade in ivory,

rhino horns, skins, furs, bones, etc. Recent estimates put the annual turnover in the wildlife trade at US\$5 billion (Le Duc, 1990) (as mentioned in 11.2.3.4). In recent years serious efforts to control this trade have been made through the Convention in International Trade in Endangered Species of Wild Fauna and Flora (CITES), which came into force in 1975. However, as controls have become tighter and more effective, they have encouraged the development of sophisticated illegal networks.

While we have a substantial amount of data for some charismatic species, they are far from complete, and for many other species we have little information about the number of species and the individuals collected by such trade. We know that a significant trade exists, but the usual lack of customs expertise for the identification of imported specimens makes regulation difficult. Also, for most species, we do not know the consequences and long-term effects of massive harvesting on either the genetic diversity or the abundance of heavily exploited wild populations. Indeed, we do not know how to predict with accuracy the level of exploitation possible for many species before serious genetic erosion or species endangerment occurs.

Nevertheless, there is evidence that over-harvesting is the principal threat to certain species (the illegal trade in rhino horn has been almost entirely responsible for the drastic decline of the black rhinoceros in Africa during recent decades according to Cumming *et al.* 1990), and a significant contributory threat to many others, especially rare species and those of limited distribution. The rareness of a species adds dramatically to its value in this trade, and several species have been driven close to extinction by collectors (Jenkins and Oldfield 1992). Appendix I of CITES lists over 600 threatened species of animals and plants that are, or might be, affected by trade (Burgess 1994).

11.3.3.3.2 How to value what we have? Natural ecosystems have been considered as unproductive areas whose benefits could be realized only by conversion to some other use. Decisions on land and water uses, for example, have a great impact on biodiversity but political considerations are often paramount in these decisions when the value of biodiversity is introduced as a major component in the evaluation of alternative land/water uses. Many systems have been greatly altered because their value to society was not adequately demonstrated, and because evaluations favoured short-term benefits.

Valuation is therefore a fundamental step in informing planners and resource managers about the economic importance of biodiversity in national development objectives, and in demonstrating the importance of different areas for the biological resources they contain (Ehrenfeld 1988). Current methods of evaluation used in decision-making, such as cost-benefit analysis,

inadequately reflect the true environmental and socioeconomic values of natural resources and ecosystems. The economic values of natural biological resources are poorly understood and a variety of methods have been devised for assigning values (de Groot 1992; Desaiques and Point 1993; Pearce and Moran 1994). Some methods have been developed to enumerate values of individual species, but not entire ecosystems. Moreover, the methodologies for economic valuation of environmental functions are not universally agreed. Economists have developed various techniques to capture direct use values, indirect use values and option values, but techniques for reflecting the non-use values involving bequest, cultural and heritage attributes are in early stages of development. Empirical problems include the difficulty of estimating the costs of environmental trends (such as the accumulation of greenhouse gases) in the presence of great uncertainty over their predicted impact (see Section 12 for a detailed review).

Another need is to determine how to protect an area and its species and how much it will cost. For example, conserving biodiversity in its present condition would require more funds than are assumed to be available in the near future. The need to provide economic incentives for the conservation of biodiversity is generally recognized – at the international or national level (by transfer of resources), or locally by ensuring that local communities benefit from the biological diversity of their regions (McNeely 1988). To achieve this goal, it would be useful to document and publicize cases in which incentive systems have successfully conserved biodiversity; determine how to adjust incentive systems to achieve a more efficient and sustainable allocation of resources; determine how incentives can be used in biodiversity restoration efforts in degraded systems; identify institutional constraints on the implementation of incentive systems at the local and national level, and develop strategies for the elimination or mitigation of these constraints (USNRC 1992). If we assume that environmental awareness evolved gradually in different countries, then studying the way these changes occurred, and working out how they could be enhanced in developing countries, is probably the type of research that is at the right level of resolution (global conservation) and could have far-reaching ramifications.

A major problem is therefore to find approaches, agreeable to economists and non-economists alike, on valuation methodologies that capture across cultures the consumptive and non-consumptive values of biological diversity. Research in environmental economics needs to be strengthened. Uncertainty over the local, national and international economic value of biological resources and biodiversity invites policy-makers to discount both and to avoid conservation investments when other budget priorities offer more readily quantifiable benefits. If the costs of resource degradation and the benefits of saving and

using biodiversity were better understood, better conservation incentives for resource users could be designed (WRI, IUCN and UNEP 1992). Moreover, while the valuation of the economic contribution of regulatory environmental functions, particularly in developing countries, is still in its infancy, findings to date indicate that the indirect benefits of these functions are of a magnitude that may rival even the direct benefits of sustainable use of natural systems (Aylward and Barbier 1992; de Groot 1992).

11.3.3.3 Managing trade and having biodiversity too. Never before has human society engaged in trading such a diversity of commodities, on such a geographical scale and volume, as currently occur. Further, as a result of liberalization measures contained in the recently concluded GATT negotiations, trade is likely to expand. The overall impact on biological resources from increased production, consumption, exchange and transportation of goods and services is difficult to foresee.

A major question is how much increase in consumption and production we can allow without compromising the sustainability of the biosphere. What is the optimum core of biological wealth necessary to maintain the present state of global production without impairing future options? For these questions, there is presently no definite answer.

Another major concern is that of how the global community can direct international trade to deliver economic progress without impairing economic sustainability (Goodland *et al.* 1991). Trade is market-driven, and markets function best when the regulator's 'command and control' measures are supportive of the development of free trade rules, practices and related infrastructures. However, trade in itself is environment-blind. The invisible hand of the market does not have any adequate self-corrective mechanism to consider biological losses and reduction of biological diversity. This would imply that some degree of 'command and control' will be necessary. Ecologically fragile wetlands can be transformed into shrimp farms in the short run, but without enlightened management, care and regulatory supervision, these areas may be destroyed. Individual nation states have considerable experience in using regulatory and market-based instruments to promote environmental objectives. However, there is no prior experience of fusing global trade and environmental goals.

11.3.4 Toward sustainable use of resources and ecosystems: the need for new management options

Modern societies seem unable to halt, much less reverse, the ongoing depletion of resources and degradation of the environment. Resource management has not always been designed for the sustainable use of resources, but for their efficient utilization as if they were boundless. Ecosystem management according to ecological principles alone, is

not sufficient. Increasing pressure to use natural resources for a variety of purposes, combined with the increasing democratization of resource allocation decisions, has made social values an important component in the management process. There is an urgent need to improve the link between ecological science and public perception and values. We must develop a new resource and ecosystem management science that is better adapted to serve the needs of ecological sustainability. Sustainability concepts are increasingly important to policy-makers around the world, but it is not easy to devise better development models because poverty is a major cause of habitat and biodiversity loss in developing countries. Actions to alleviate the loss of biodiversity must address the socioeconomic causes of poverty (Schweitzer 1992).

11.3.4.1 Ecosystems management

It is likely that one of the major environmental concerns in the 2000s will be the preservation of biodiversity in the context of sustainable development, and that is closely related to future options for the management of lands and waters.

A major factor of success in designing sustainable exploitation systems is the cooperative capacity of the local community, and its ability to design and implement management plans. Research is needed to help communities obtain the greatest benefit from any land or water over which they have legal rights, and to identify ways to integrate the knowledge, innovations and practices of indigenous and local communities into modern management practices. How do different land management systems, such as individual property and common property, affect the use and protection of natural resources? What combinations of extensive and intensive land and water use achieve satisfactory sustainable returns to people while conserving biological diversity? For instance, at the level of the forest people, more research is needed to determine how they and their traditional land-use practices are affected by different forms of rain forest management, e.g. alternative logging practices, introduction of plantations, conversion of cleared areas to intensive agroforestry. This also emphasizes the need to assess local perceptions of proposed modes of development (Schreckenbergh and Hadley 1991). There is a major gap in our knowledge of the effectiveness of alternative use/management strategies for biodiversity conservation.

11.3.4.2 Living resources management

The well-being of human populations depends on the availability of a variety of renewable resources which may be utilized either sustainably, at rates that permit harvests at a given level over a long time, or exhaustively, at rates which in the long run lead to a decline in the total stocks. Recognition that our natural resources are not currently

managed on a sustainable basis may lead to the conclusion that further loss of biological diversity will reduce our future options for sustainable biological resource management (Cairns and Lackey 1992).

Resource management options have ecological, socioeconomic and political constraints (Clark 1989). Conflicts, or at least competition, between protection of biodiversity and production of resources are likely to occur; and what might be in the interest of society is not always in the best interest of individuals. There is a conspicuous paucity of examples showing how both traditional and modern societies perceive, value and conserve biological diversity while successfully using natural resources in a sustainable manner (exceptions include a number of cases documented in Johannes 1978; McCay and Acheson 1987; Berkes 1989; Bromley 1992). Achieving a balance between resource use and conservation, accepted as mutual goals in technological societies, has largely failed. Ethnobiological research is needed to design more effective and locally acceptable conservation and management plans (Soulé and Khom 1989). In fact, rural populations have had the capacity throughout their history to manage their resources for a sustainable yield while the ability of primitive humans to exterminate a vast array of prey species is also well documented. It is only in recent times (beginning in the colonial period but greatly accelerated after 1950) that traditional systems for managing resources have been replaced by government agencies and have proved to be less efficient, or at least not as successful as they should be.

This situation can be illustrated by fisheries management in inland waters. After the Second World War, the European ideas of rational fisheries management were assumed to be the only universal solution for sustainable use of fish stocks. Most policies for the sustainable management of fish stocks derive from the concepts of equilibrium population dynamics and stock assessment, and aim to achieve a level of fishing effort at which the stock or population is conserved at its level of maximum sustainable yield. Although the principle of Maximum Sustained Yield has been challenged, it is still accepted as one of the main bases for management. Despite the apparent capacity to determine the levels of harvest needed to conserve fish stocks, there has been an almost universal failure to do so. This failure may lie in part in the shortcomings of scientific advice, but for the major part lies in the difficulties of applying coherent management strategies for political and sociological reasons (Welcomme 1992). Efforts at central fisheries management during the last few decades have not been especially cost-effective, and serious consideration therefore needs to be given to reinstating community-based, traditional-type management structures.

For tropical forests, agroforestry is a collective name for land-use systems and technologies in which woody

perennials (trees, shrubs, palms, bamboos, etc.) are combined on the same management unit with herbaceous crops and/or animals, in some form of spatial arrangement or temporal sequence (Schreckenberg and Hadley 1991). Agroforestry is not a new technology and it has often been used traditionally in different ways in many parts of the world, but farmers have abandoned such forest use because of inappropriate land or forest tenure systems. Combined with modern agricultural and forestry techniques, traditional agroforestry is often stated as one of the most successful approaches to producing tropical hardwood in a sustainable way, but it cannot be an answer to the demand in the developed world. At present, additional research is needed to allow a progressive change in land use from traditional shifting cultivation or extractive forestry to more intensive agroforestry (Schreckenberg and Hadley 1991). Several initiatives are also under way to develop systems for sustainable forest management in all types of forest in the world, and to agree on a system of labelling sustainably produced timber.

To achieve the sustainable use of environmental systems, there is an increasing need for new resource management systems. Should they be based on the resource management techniques of the industrialized countries, or should they be developed by rehabilitating and adapting 'indigenous' resource management systems and upgrading traditional local-level institutions? Is there any way to integrate the scientific and traditional systems? These are the central questions that must be answered in order to propose development models that take care of the environment and serve the needs of the people who use its biological resources. The only answer to this type of problem is to test different systems and discover what works. This is a new challenge because, until recently, scientists and policy-makers knew little about traditional management systems and accorded them little credibility.

We therefore need to conserve the diversity of traditional resource management practices and systems if we want to construct a new resource management science better adapted to the real world. The rejection of the monolithic scientific vision of resource management does not mean the overall rejection of science. The task is to develop a flexible approach by conserving what is useful in science. Ecology is in a unique position to be the cornerstone of a new science of resource management that synthesizes the best of the old and new wisdom towards a more sustainable future. But ecology would first have to extricate itself from the older utilitarian, 'control over nature' tradition of resource management (Gadgil and Berkes 1991).

What would be the reaction of a system in a case of reduced pressure on biological resources? We have little experience in this field, even if a great deal of experience has been gained in nature management systems during the last decade.

11.3.4.3 *The question of common property of natural resources*

The use of the term 'common property' has been controversial. For some scientists it means resources that are not amenable to private appropriation: they are free goods, not owned by anyone, such as marine resources, including fisheries. As a result, they are open-access and freely available to any user. An alternative view considers that the term 'common property' should be restricted to communally owned resources that are managed through communal arrangements for allocation among co-owners.

The 'tragedy of the commons' model (see 11.1.7 and 11.2.3) still persists in the conventional wisdom of many resource managers, and is also dominant in models of development exported to Third World countries. It led a generation of fishery managers and other resource managers to believe that absolute governmental controls needed to be established over both the resource and the user, and blinded them to the possibility of managers and resource users working together, rather than against one another. However, valuable natural resources are almost never open-access but are managed under traditional rules. Many case studies indicate that co-operation for communal interest more frequently occurs (Berkes 1989). Recent literature on common property rejects a deterministic 'tragedy of the commons' (Ostrom 1990; Stevenson 1991). The common property approach reverses the traditional emphasis of resource management, which has been on the resource rather than on the people, and starts with an analysis of the local property rights regime.

For some authors, appropriation is not property (Weber and Reveret 1993). The appropriation of a resource or an ecosystem may be understood under five components: (1) *representations*: the way each society perceives nature; part of the group culture; (2) *uses*: the use of natural resources is not always dictated by economic purposes; taboos exist everywhere; (3) *access to resource and control of access*: access is often regulated by customary institutions, myths, historical rights or traditional regulations, and may be individual or collective, permanent or temporary; (4) *transfer modalities*: that is, the way rights are transferred from one generation to another; (5) *re-partition and sharing*: the resource, or the benefit of the resource, may be distributed amongst all individuals or according to social status.

More research is needed on a global analysis of appropriation and use regimes. They are not well known partly because of the confusion between common resources and open access, though analyses of the management of common resources are becoming more numerous (Berkes *et al.* 1989; Bromley and Cernea 1989). However, before we consider new resource management systems we need to know the extant systems and understand the choices behind them.

11.3.4.4 *Predicting the consequences of social and economic changes on biological diversity*

One of the major challenges is to understand and adapt ourselves to natural, economic and political variabilities (Henry 1990), and to develop a flexible and adaptative approach to management. We can have a greater impact on the way people are using resources than we can on the resources themselves. An increasing population pressure is likely to occur, but we do not know to what extent. What kind of changes should we expect in consumption? How do groups extrapolate the future use of biological resources, and how do use rates change as biological, social, economic and cultural factors change? Is it possible to forecast future social behaviour and political options and/or is it feasible? There are so many unanswered questions about the future of humanity that it is difficult to forecast the future of biodiversity in relation to human needs and expectations. However, we need urgently to reinforce collaborations between social and biological sciences to gather at least enough information not to be unprepared.

11.3.4.5 *Knowledge-based systems*

Models of the dynamics of biodiversity under the impacts of natural and human-induced disturbances might provide a better way of managing ecosystems and resources. However, models built for explanation or prediction have not been very successful when applied to whole ecosystems.

A subsidiary goal of modelling activities could be to combine the various rules and generalizations developed through the long experience of ecologists and resource managers to make them available in a systematic way. They could then be applied to situations where less experienced managers may be faced with problems of making decisions with inadequate data. Such 'expert' systems do not provide definitive answers, but may act as a reminder of some of the principles that need to be considered and some of the interactions that might occur.

11.3.4.6 *Development and transfer of technologies relevant to the sustainable use of biological diversity*

One of the most consistent of the Agenda 21 themes, and one of the most intractable of issues, concerns access to technology (Rath and Herbert-Copley 1993). Among the proposals under consideration are: to increase the flow of information about environmentally friendly technologies; to increase industrial self-regulation; to increase the importance of markets in allocating values; and to promote improvements in environmental performance of industry in the South. This issue was widely discussed during the intergovernmental meeting of scientific experts held in Mexico in 1994 (UNEP 1994). It ranges from environmental impact assessment techniques to ecosystem

management techniques and integrated land use, biotechnologies, new and renewable sources of energy techniques, less wasteful lifestyles, consumption and production patterns, family planning techniques and economic and financial instruments.

The issue of access to technologies is about how to develop endogenous capacity to assess, adopt, manage and apply environmentally improved technologies. However, there are difficulties in identifying appropriate kinds of 'clean' or environmentally sound technologies to promote in developing countries. Environmental sustainability has not been a major consideration among mainstream innovation policy and management researchers (Winn and Roome 1993), and the literature on 'green' innovation policies is relatively small and dispersed among the literature on environmental management, environmental economics, risk assessment and economics of innovation.

Much of the literature on environmentally sound industrial innovation suffers from the difficulty of identifying and describing those variables linking the technical and social dimensions that are accessible to management, policy or political interventions. Mechanisms and instruments of deliberate social choice, especially ones that are feasible under regimes of democratic governance, are a relatively unknown part of the non-market selection environment.

11.4 Future prospects

11.4.1 Introduction

The world is an uncertain place. A strong interest remains in understanding what might take place in the future, although science has largely assumed the role of fortune-teller. However, with our limited understanding of the biotic and abiotic systems of the Earth and our even more limited understanding of human behaviours and cultures, forecasting is at best an inexact science. In fact, it is unclear to what extent our evolving understanding of systems can accurately 'back-cast' (*sensu* Kates *et al.* 1990), let alone forecast. Furthermore, predictions of the future vary depending on the forecaster's culture, religion, experience and temperament.

Modern fortune-tellers can be distributed along a spectrum with the 'Malthusian pessimists' at one end and the 'technological optimists' at the other (Goodwin 1994). The Malthusians tend to think it very likely that human civilization will collapse and human life, if it goes on at all, will return to the sort that Thomas Hobbes characterized as 'solitary, poor, nasty, brutish and short'. According to this position, no group of inventions or investments can permit us to continue living in the style, and at the level of material affluence, taken for granted by industrial societies today. We have so harmed the natural environment that ecological and economic collapse are inevitable, resulting

in the collapse of populations and civilizations, and perhaps followed by a regrouping at a much lower level of resource use and civilization. The Club of Rome report *The Limits to Growth* (1972), for example, predicted that population growth, resource exhaustion and pollution would bring about the collapse of human society by the early twenty-first century.

At the other extreme, technological optimists speculate that technological advances will rescue us, and that an ever-improving base of material well-being will continue to provide humanity with the option of continuing its experiments in freedom, justice and understanding. Many see no need to tamper with consumer behaviour, believing that any shortcomings of today's energy economy can be modified on the supply side. Simon and Kahn (1984) argue that the twenty-first century will indeed bring higher living standards and reduced human impacts on the environment as a result of technological advance and policy innovation.

Given the many possible and feasible views of the future, Goodwin (1994) suggests that a sensible course of action would be the following:

1. Given the lack of credibility attached to the predictions of either end of the spectrum, we need to prepare for many kinds of futures simultaneously – including that predicted by the pessimists and that to which the optimists look forward.
2. We should try to maximize the possibility that our preferred set of possibilities is realized, while taking steps to ensure against even a small probability of the most pessimistic scenarios being realized.
3. We should continue to refine our understanding of the competing predictions, both by adding to our knowledge about the events that will determine the relevant characteristics of the future, and by familiarizing ourselves with the terms of debate over why these events should lead one way or the other.

Speculation about and preparation for the future have necessarily taken place on two related but distinct dimensions. The first involves understanding the degree to which past human actions have set in motion irreversible and on-going change in the natural and physical environments, altering the range of options faced by human communities. The second involves the capacity of human societies to understand, adapt and respond to environmental change, a function of the cultural, social, economic and political contexts in which they operate.

11.4.2 Trends

11.4.2.1 Population and resources

Optimistic as well as pessimistic forecasters of the world's future recognize increasing demand by expanding human

populations as a source of immense stress on biotic and abiotic resources and systems. A key factor in assessing future demand is our ability to predict accurately population size decades in the future. The remarkably accurate prediction of today's population by demographers in the early 1970s is a tribute to their technical skill (McNeely and Ness 1995) and should give us some confidence in current estimates of global population over the next few decades.

The world population in 1990 has been estimated as 5.29 billion, 78% occurring in LDC (less developed countries, effectively all countries excluding Europe, North America, Japan, Australia and New Zealand). The significant increases anticipated in total world population in the coming decades are largely uncontended and two sophisticated analyses arrive at similar 'middle' scenarios: by 2025 world population will stand at 8.5–9.0 billion people (UN figures, quoted by WRI, UNEP, UNDP 1990; Lutz *et al.* 1993). The latter authors used three components of population change – fertility, mortality and migration – and using various estimates of the range that these three components could realistically take, developed nine population scenarios. Although these resulted in a wide range of possible outcomes, three conclusions were consistent:

- World population will continue to grow and by 2030 will have increased by at least 50%, and may even have doubled in size. The 'central' scenario suggests an increase of 80% with a population of 9.5 billion (Table 11.4-1).
- Developing countries will account for a greater share of the world population and by 2030 will have increased from 78% of world population in 1990 to 86%. Under all scenarios, Africa's share of the population will increase most rapidly (the central scenario estimates Africa's population will increase from 12% of world population in 1990 to 19% in 2030 and 26% in 2100 (Table 11.4-1).
- All populations will become older and the more rapidly fertility declines the faster populations will age.

The world's population is likely to double in the next 60 years, even if fertility rates fall in virtually every developing country (Jolly and Torrey 1993). If the demographers' consensus holds true, we are about half-way towards a level population of between 8 and 12 billion people, barring a major catastrophe (Kates *et al.* 1990).

Rising human populations mean an inevitable expansion in human demands on the resources of the planet. Moreover, per capita demand for biotic resources has also increased, so that the increase in direct exploitation has been exponential rather than linear. The human species

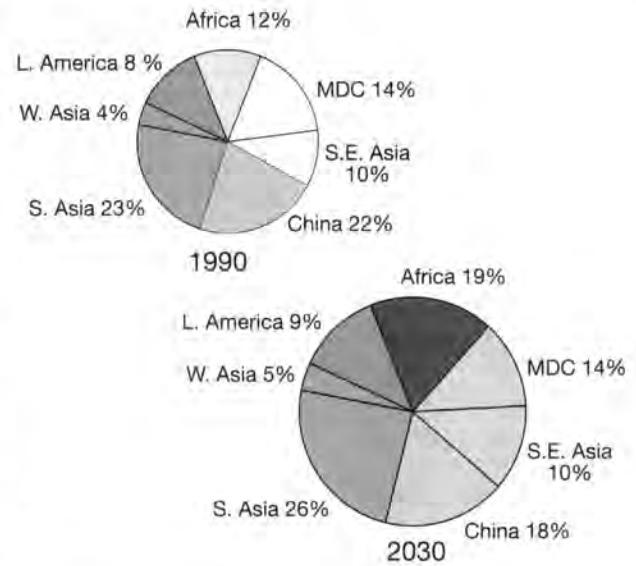

Figure 11.4-1: Regional distribution of world population under the central scenario (Population Network Newsletter No. 23, 1993).

now appropriates some 40% of the net primary productivity of terrestrial systems (Vitousek *et al.* 1986), much of it as a result of food production (Brown 1994). Between 1950 and 1984, per capita grain production increased by 40%. Between 1950 and 1990, per capita supply of beef and mutton increased by 26%. In addition, world fish catches underwent a 4.6-fold increase between 1950 and 1989, doubling per capita production of seafood. World consumption of wood also increased 2.5-fold between 1950 and 1991, per capita consumption increasing by a third during this period (Durning 1994). As with food consumption, most of the growth in total and per capita wood consumption has occurred in the developing world.

Some indicators suggest that ecosystem and resource limits are already being reached. World fish harvests peaked at 100 million tonnes in 1989, and by 1993 had declined 7% from 1989 levels. Growth in grain production has slowed since 1984, with per capita output falling 11% by 1993. World economic growth has slowed from over 3% annually in the decade 1950–60 to just over 1% in the decade 1980–90 and less than 1% from 1990 to 1993. The Worldwatch Institute, extrapolating from historical data, forecasts that 'If current trends in resource use continue and if world population grows as projected, by 2010 per capita availability of rangeland will drop by 22% and the fish catch by 10%. The per capita area of irrigated land, which now yields about a third of the global food harvest, will drop by 12%. And cropland area and forestland per person will shrink by 21% and 30%, respectively' (Postel 1994).

The potential for further expansion of cropland area is thought to be small. Current figures show that roughly one-third of global land area is used in food production, 1.5 billion ha of this being used as arable land (Kendall and

Pimental 1994; Doos 1994). This current land area will decline as expanding global populations compete with agriculturalists for land for urban and industrial purposes and as land degradation takes its toll. The above authors, in agreement with WRI (1994), conclude that while there is a further potential for conversion of land to cropland (in the order of 1.5–1.7 billion ha) the areas with the best potential for cropland are already being used in this way; to realize any further expansion of arable land will involve the conversion of marginal areas such as tropical forests, steep hillsides and semi-arid regions which have relatively fragile resources – and a great deal of the world's biodiversity. These areas are inherently unsuitable for crop production due to various physical and chemical soil constraints or unreliable rainfall.

Current trends in resource use and population growth are not, of course, perfect predictors of the future. Indeed, population growth is expected to level off by the end of the twenty-first century, and growth in food production has slowed in the last decade, with much of the remaining growth achieved by increasing output per area. Another disturbing trend, however, has been the rising concentration of income world-wide. From 1960 to 1989, the share of world income going to the poorest 20% of its population declined from 2.3% to 1.4%, while the share of income going to the richest 20% increased from 70.2% to 82.7% (United Nations Development Programme 1992). In other words, while per capita consumption is actually declining

in many parts of the developing world, 83% of world income is concentrated in the hands of 'biosphere people' whose disproportionate share of disposable income allows them access to increasing quantities of consumer goods.

11.4.2.2 Changes in terrestrial and aquatic ecosystems

Humans have already greatly modified the Earth's surface. Ecosystems that have been substantially transformed, managed and utilized constitute about half the land surface of the ice-free Earth. Moreover, the rate of global land-use and land-cover change is accelerating. Conversion to cropland contributes to much of this land cover change; half of the area of cropland world-wide was added during the last 90 years, with croplands in the tropics doubling in area in the last 50 years. Rates of forest loss in the tropics are currently increasing by an estimated 4% to 9% annually (Houghton 1994).

Although land-use change outside the tropics is relatively limited, changes in characteristics other than area continue to occur, including loss of biomass and carbon storage (Houghton 1994; Ojima *et al.* 1994). Habitat disturbance and other anthropogenic factors may also contribute to species invasions or successful introductions of exotic species. The addition of species may have wide-ranging effects on community composition and dynamics, and alter productivity, soil structure, nutrient cycling and water chemistry (see discussion in Chapter 11.2).

Table 11.4-1: Total population size (in millions) in 12 world regions under the central scenario.

Region	Year					
	1990	2010	2030	2050	2070	2100
Northern Africa	140	226	332	440	529	595
Sub-Saharan Africa	502	924	1 499	2,097	2 561	2 700
North America	277	325	376	420	475	577
Central America and the Caribbean	147	219	289	342	370	371
South America	294	407	516	604	667	727
Western and Central Asia	197	312	442	553	632	682
South Asia	1 191	1 806	2 428	2 874	3 065	2 855
China and Hong Kong	1 159	1 469	1 722	1 873	1 945	1 968
Southeast Asia	518	735	937	1 076	1 129	1 082
Japan, Australia and New Zealand	144	158	160	158	154	151
Eastern Europe	345	368	380	385	392	427
Western Europe	377	368	380	385	392	427
Developing regions	4 149	6 097	8 167	9 859	10 897	10 980
Industrialized regions	1 142	1 255	1 333	1 378	1 437	1 582
World total	5 291	7 352	9 499	11 238	12 334	12 562

Biotic communities are also modified by the removal of animal and plant species (as noted in 11.2.3.4). The size of the this trade is staggering. At present, nearly 22 000 species are already threatened, including about 10% of all birds and mammals (McNeely *et al.* 1989); direct exploitation is one of the most important threats (WCED 1987). Although many areas of apparently natural vegetation remain, large animals on which many plant species are ecologically dependent may have been hunted out by humans (Redford 1992). The result may well be the eventual ecological collapse, or at least profound change, of these areas.

Not only will land areas continue to be affected, but so too will marine and freshwater areas. Marine ecosystems are increasingly affected by logging of forests and mangroves, siltation, dredging and channelization, pollution, shoreline development, oil and gas development and other human modifications, as well as introduction of exotic species and direct offtake of fisheries (Norse 1993). As L'vovich and White (1990 in Wolman 1993) have shown, human activities have also significantly altered the global distribution of runoff in rivers. They estimate an increase over a period of 300 years of about 20% in base flow and a decrease of 16% in surface runoff as a result of anthropogenic activities. More dramatic is a 300% predicted increase in consumptive use of water in irrigated agriculture over that of the last 300 years.

Habitat loss, modification and fragmentation are widely considered the most important causes of loss of biological diversity, with most current attempts to estimate and project the rate of species loss based on reductions in habitat area (WCMC 1992). Recent work (Tilman *et al.* 1995) has documented what the authors refer to as the 'extinction debt' associated with habitat destruction, in which the rate of extinction increases as a function of the area of habitat that has already been destroyed. For instance, destruction of an additional 1% of habitat causes the extinction of eight times more species if 90% versus 20% of a region has already been destroyed. Furthermore, an unanticipated effect of this habitat destruction may be the selective extinction of the best competitors – those species that are often the most efficient users of resources and major controllers of ecosystem functions. Thus, this extinction debt may have dramatic effects on the ecosystems of the future and the ability of these ecosystems to deliver vital services to human populations.

Human-induced change has shifted from the agricultural transformation of the surface of the Earth to industrial mobilization of materials and energy, to the current mix of agricultural, industrial and advanced-industrial transformation. As this range has expanded, so has the secondary interaction among the changes and hence the complexity of the problems that they pose for biological systems. The impacts of human-induced change are no

longer local or regional, but rather global, adding to the difficulty of assessing the human impacts on biodiversity and predicting the future.

Most global-scale impacts of human-induced change have been quite recent, particularly those dealing with biogeochemical cycles. For example, high-temperature industrial emissions alone now multiply the annual natural releases of arsenic by a factor of 3, of cadmium by 7, of mercury by 10 and of lead by 25 (Kates *et al.* 1990). Galloway *et al.* (1994) predict that by 2020, emissions of fixed nitrogen from fossil fuel and biomass burning are expected to increase over 1980 levels by 25% over North America, by more than half over the oceans of the Northern Hemisphere, and by at least 100% in the developing areas. Less than one-third of this increase is accounted for by population growth; the remainder will be achieved through greater per capita emissions, particularly in the developing world. These increases in nitrogen deposition have a number of effects, including fertilization of terrestrial and marine ecosystems, acidification, and increases in emissions of nitric oxide and nitrous oxide (see also Section 6).

Chameides *et al.* (1994) found that three regions of the northern mid-latitudes, which they termed 'the continental-scale metro-agro-plexus' currently dominate global industrial and agricultural productivity. Although they cover less than a quarter of the Earth's land surface, they account for most of the world's commercial energy consumption, fertilizer use, production of food crops and food exports. They also account for more than half the world's atmospheric nitrogen oxide emissions and, as a result, are prone to ground-level ozone pollution during the summer months. On the basis of a global simulation of atmospheric reactive nitrogen compounds, it is estimated that about 10% to 35% of the world's grain production may occur in parts of these regions where ozone pollution may reduce crop yields.

Exposure to yield-reducing ozone pollution may triple by 2025 if rising anthropogenic nitrogen oxide emissions are not abated. Although the current loss in crop yields from ozone pollution appears to be only a few per cent of the total loss, this may well change in the coming decades. Nitrogen oxide emissions predicted for 2025 not only intensify pollution but also enhance pollution in agricultural regions of the developing world. For 2025, they estimated that as much as 30% to 75% of the world's cereals may be grown in regions with ozone above the 50 – 70 ppbv threshold, which suggests that the agricultural losses may increase significantly. Further, this increased pollution effect will be occurring at a time when growing populations in developing countries will be straining food production capacities.

11.4.2.3 Climate change

The most complex manifestation of human-induced global change is that of the Earth's climate. The debate over the effects of ozone depletion and airborne particulates

(producing a cooling influence) and greenhouse gases (producing a warming influence) has produced a plethora of scientific material on the subject (summarized and assessed in Houghton *et al.* 1990). In an attempt to deal with the uncertainty in the prediction of the effects of climate change, IPCC has brought together a group of statements on various climate change issues which represents the degree of consensus on these issues (Table 11.4-2). Many climatologists believe that the 'greenhouse effect', caused by the observed accumulation of carbon dioxide, methane, nitrous oxide and chlorofluorocarbons in the atmosphere, is likely to raise mean world temperatures by about 2 °C by 2030 and mean sea levels by around 30–50 cm on a comparable time scale (Warrick *et al.* 1988). By the end of the next century, global average surface temperatures are predicted by the IPCC (1992) to increase by 2–6 °C with an attendant rise of sea level of 0.5–1.5 m. Such a change could be 10 to 50 times as fast as the natural average rate of temperature change since the end of the last glaciation (Schneider 1989). These changes could bring increased frequency and destructiveness of hurricanes (Emanuel 1987); more protracted droughts, longer and hotter heatwaves, and more severe rainy periods; and significant changes in the area of the great ice sheets of Antarctica (Frolich 1989).

Although the nature and causes of the greenhouse effect remain hotly contested (e.g. Bryson 1993), the scale and complexity of potential changes has led to a desperate scramble to foresee the future. Large-scale extinctions have

occurred in the past as a result of major climatic changes, cataclysmic disturbances and human activities (Crowley and North 1988; Gates 1993). Although there is little scientific consensus on the impacts of apparent current changes, it appears highly likely that global warming and associated disturbance events, particularly when coupled with human population growth and accelerating rates of resource use, will bring further losses in biological diversity (IUCN 1986; Gates 1993).

If predictions of a rapid temperature rise are realized, the effects of global change on patterns of human settlement, production and resource consumption will be dramatic. The effects of increased concentrations of atmospheric carbon dioxide and other greenhouse gases on climate will be particularly evident in northern latitudes. Rising temperatures are expected to bring about a poleward shift of cereal cropping in the major grain-producing – and exporting – areas of the Northern Hemisphere and an overall decline in grain production, and may reduce livestock production as a result of heat stress. Impacts on agriculture in the tropics are more difficult to anticipate because they are more vulnerable to the unknown effects of warming on the amount and distribution of precipitation. Agricultural pests and diseases may increase their geographic ranges, severity or both, as temperature and humidity rise (Parry and Jiachen 1991; Gates 1993).

Sea-level rise may also result in the loss of farmlands directly and through increased saltwater intrusion in coastal regions. For each centimetre rise in sea level, beaches may

Table 11.4-2: Degree of consensus on various climate change issues (WRI 1994).

Issue	Statement	Consensus
Basic characteristics	Fundamental physics of the greenhouse effect	Virtually certain
	Added greenhouse gases add heat	Virtually certain
	Greenhouse gases increasing because of human activity	Virtually certain
	Significant reduction of uncertainty will require a decade or more	Virtually certain
	Full recovery will require many centuries	Virtually certain
Projected effects by mid-21st century	Large stratospheric cooling	Virtually certain
	Global-mean surface precipitation increase	Very probable
	Reduction of sea ice	Very probable
	Arctic winter surface warming	Very probable
	Rise in global sea level	Very probable
	Local details of climate change	Uncertain
	Tropical storm increases	Uncertain
Details of next 25 years	Uncertain	

Virtually certain: nearly unanimous agreement among scientists and no credible alternative view.

Very probable: roughly a 9 out of 10 chance of occurring.

Probable: roughly a 2 out of 3 chance of occurring.

Uncertain: Hypothesized effect for which evidence is lacking.

erode a metre landward and storm surges, a major erosional force, will increase. For every 10 cm rise, saltwater wedges in estuaries and tidal rivers may advance a kilometre; and any sea-level rise will increase salinity intrusion into coastal freshwater aquifers (NAS 1987; Parry and Jiachen 1991). In addition, these changes will affect human settlements through changes in the availability of nearshore and brackish water organisms (Ray *et al.* 1992), important food sources for humans and other species.

Changes in cropping and crop location, livestock husbandry, irrigation, fertilizer use, pest control and soil management may enable human societies to maintain global levels of food production. However, it is likely that the frequency of both short-term and long-term crises in regional food supply will increase (Parry and Jiachen 1991). Moreover, the direct and indirect feedback effects (Ojima *et al.* 1994) of change of land use and technology on climate change are impossible to predict.

Major changes in global vegetation cover are also expected to occur in response to global climate change, primarily as a result of changing temperature and precipitation (Gates 1993). Schlesinger (1991), for example, predicts that rising temperature and precipitation will result in the expansion of boreal forests, but overall forest area is expected to contract, with grasslands and deserts increasing in extent. In North America, Europe, Asia and southern Africa, desert and other areas of sparse vegetation may expand at the expense of grasslands, shrublands and prairies. On the other hand, shrubby vegetation may spread into areas of sparse vegetative cover in southern Africa, Saudi Arabia and Australia (Woodward 1992).

More difficult to predict are the multiple interactions among changes in temperature and precipitation, soil quality and nutrients, and increase carbon dioxide. Although researchers know very little about the responses of vegetation to an increase in CO₂, laboratory studies increasing CO₂ concentrations have produced higher yielding wheat, larger sugar beets, and faster-growing radishes (Fajer *et al.* 1989). On the other hand, plants fertilized with CO₂ may be larger and grow faster but are less nutritious, so that insect pests must consume more to achieve their normal rate of growth and may pose a greater threat to crops and vegetation (Pain 1988a). Other observations suggest that plants respond to high CO₂ concentrations and may become more efficient in their use of water, thus contributing to the spread of shrubby vegetation into more barren regions of east and south Africa, Saudi Arabia and Australia (Fajer *et al.* 1989). In three sub-alpine conifers (*Pinus flexilis*, *P. longaeva*, *P. aristata*), greatly increased tree growth rates observed since the mid-nineteenth century exceed those expected from climate trends but are consistent in magnitude with global trends in CO₂ concentrations, especially in recent decades

(LaMarche *et al.* 1984). The IPCC (Schlesinger 1991) concludes that the growth effects of increased CO₂ will be greatly outweighed by the effects of temperature change, but few laboratory or field experiments have been conducted to evaluate such interactions.

A growing body of research has also examined the possible effects of climate change on individual species and biotic communities. This research suggests that biological communities will change and shift in complex and unpredictable ways as the geographical distributions of species are altered individually rather than in community units (Conner 1986). Further, because species are interrelated, any advantage falling to a given species in a closed system will affect other species in ways that are not always predictable. The rate of species invasions and extinctions is likely to accelerate further, bringing about complex changes in species compositions and interactions (Lodge 1993). Thus, rather than causing a simple northward or uphill shifting of ecosystems with all of their inhabitants intact, climate changes will serve to reorganize biological communities. For example, small changes in temperature alone may differentially alter the spacial distribution of predator and prey species in marine ecosystems (Murawski 1993). The 1982–3 El Niño event gave Galapagos increased rainfall by a factor of ten, with a resultant increase in seed production and caterpillar abundance. Ground finches responded to the increase in food supply by producing up to ten egg clutches instead of the usual one to five, increasing population size by a factor of four (Gibbs and Grant 1987). On the other hand, oceanic productivity was low, so that many seabirds did not breed. The Galapagos penguin and the flightless cormorant populations were reduced by 49% and 77%, respectively (Valle and Coulter 1987).

In forest ecosystems, rainfall and seasonality as well as temperature may be influential, particularly if they cause major changes in fruit or seed production. Further, the responses of forests to climate change may depend as much on the indirect effects of climate and vegetation on soil properties (Pastor and Post 1988). The ability of animal and plant species to shift their ranges in response to climate change also depend on dispersal mechanisms. Significant changes in temperature could occur during the life-time of some long-lived tree species; trees that disperse light, wind-blown seeds or drop seeds carried by animals may be able to disperse more than others (Peters 1992). On the other hand, tree species dependent on animals for pollination or seed dispersal may be affected by the changing ranges of animal species.

Peters and Lovejoy (1992) identify a number of mechanisms through which species and communities are likely to be affected as a result of the direct and indirect impacts of climate change. Populations located near the edge of a species' range, narrowly endemic species, and

endangered species that exist only in reserves or other extremely limited habitats, are especially vulnerable to global vegetation shifts. Species that are already threatened by direct exploitation and habitat loss and degradation are likely to be particularly susceptible to new threats. Coastal communities may be inundated as sea levels rise, while altitudinal shifts brought about by increased temperatures would reduce or even eliminate the ranges of montane and alpine species, many of which are already relictual, having been isolated by past climate changes. In hybrid zones such as those reviewed by Barton and Hewitt (1989), where genetically distinct populations meet, mate and produce hybrids, climate change may favour some species but cause the extirpation of others.

Because climate change is expected to be greatest at high latitudes, Arctic communities are also expected to undergo particularly rapid changes. Many of Europe's most productive wildlife habitats are in the far north, where algae, bacteria and other microscopic organisms grow on the undersides of sea ice during the spring. As the ice breaks up with the approach of summer, the organisms are released into the water, where they support a series of food webs that include large species such as whales, polar bears and seals. An increase of 5 °C over the next 50 years could melt even the permanent Arctic ice (Pain 1988a), bringing fundamental changes to polar ecosystems. Alexander (1992) notes that the melting of sea ice could also affect marine mammals that use ice floes for rest, travel and reproduction. If the ozone hole over the North Pole becomes firmly established, these impacts could be greatly magnified: El Sayed (1988) predicts that observed damage to the sensitivity of some plankton species by increased ultraviolet radiation would occur.

Severe temperature changes at northern latitudes may also have negative implications for species dependent on the timing of ice melt. Under normal conditions, snow and ice melt in Northern Europe over a period of several weeks, with the acidic meltwater draining through the soil, neutralizing it before it runs into lakes and rivers. An earlier and faster melt would cause the meltwater to run over the soil and into rivers, introducing a flood of acid water at a time when many animals are at their most vulnerable stage (e.g. eggs or fish fry). In addition, less water would be available in the following months, and with the warmer summer, water is likely to be in short supply. The pools and shallow lakes of the taiga and tundra – home to large populations of migratory water-birds – may become a far less productive habitat (Pain 1988).

Temperature change will also affect animal species directly. Dawson (1992) notes that animals that react to thermal stress by evaporating water may be negatively affected by rising temperatures and decreased water availability, while ectotherms are likely to experience extreme changes in metabolic and other bodily functions in

response to relatively small temperature changes. Rising ambient temperature may result in decreased fertility and fetal survival in mammals. Fish, reptiles and invertebrates that are subject to environmental sex determination may also be affected directly by rising temperatures. For example, higher temperatures produce more males of alligators and crocodiles and more females of some turtles, thereby enabling sex ratios to be adjusted in response to particular environmental conditions (Head *et al.* 1987).

Migratory species dependent on climate and prey availability throughout their migratory pathways are also acutely sensitive to the direct and indirect effects of global change (Pain 1988; Myers and Lester, 1992). In the Western Hemisphere, for instance, shore-birds such as sanderlings and plovers spend the winter in South America and travel north to breed in the Arctic in summer, stopping in Delaware Bay to feed on the eggs of horseshoe crabs that arrive and lay their eggs at the same time each year. If the timing of horseshoe crab egg-laying were to be disrupted, then the effects on the migrants could lead to a late arrival in the Arctic, missing the summer population explosion of the Arctic insects that is required to provide the hatchlings with sufficient food (Pain 1988).

11.4.2.4 Implications of global change

The role of change in ecological systems is increasingly recognized by natural scientists. The current paradigm, termed the 'flux of nature' or 'non-equilibrium paradigm', emphasizes process rather than end points, in contrast to the previous 'balance of nature' or the 'equilibrium' paradigm. The flux of nature acknowledges constant change, contending that natural communities have multiple stable states (Pickett *et al.* 1992). This approach is endorsed by plant ecologists such as Primack and Hall (1992), who concluded from their research in Asia that the forests they studied were characterized by unstable local populations of some common species and a rapid turnover of rare species. Condit *et al.* (1992) concluded that all biotic communities undergo constant flux as populations or individual species expand, contract, go extinct locally and re-migrate in response to endogenous ecological and evolutionary change and exogenous forcing.

Holling (1986) points out that the constant change occurs on an infinite number of spatial scales – from tree falls to the impacts of meteors, and temporal scales – from continental drift to sunrise and sunset. Variability and instability are indeed the traits necessary to retain the resilience of ecosystems, or their ability to adapt to disturbance through rapid shifts to alternate stable states or through evolutionary organizational change. An important implication of this view is that reductions in natural variability lead to fragility and lessen the likelihood that disturbance will bring about a transition to an alternate equilibrium.

Anthropogenic factors are of course among the exogenous forcing agents prompting change in ecological systems. Indeed, not only has the rate and scale of human-induced global change increased dramatically, but it is often acknowledged that human activity has modified the environment from a set of systems characterized by flexibility and constant flux, toward one that is more fragile and increasingly vulnerable to cataclysmic events. For example, tree species differ in their genetic variability, and those that have more variable populations might be able to respond with greater facility to changing climates (Davies and Zabinski 1992). Yet human-induced change through harvesting, habitat alteration or climate change tends to reduce the genetic diversity of individual species. Successful adaptation to climate change may also depend to a great extent on the ability of species to disperse to new areas, but this ability is increasingly impeded by human-induced landscape change (Peters 1992; Ryan 1992; Quinn and Karr 1993).

Human populations have already exerted fundamental influences on biological diversity and the Earth's capacity to support and maintain such diversity. It appears inevitable that changes already wrought will bring further losses of biodiversity in the future. However, changes are also integral to human populations, and in turn are often a response to shifts in biotic and abiotic systems. The following sub-chapter will assess current viewpoints on the ability of individuals, institutions and societies to evolve and adapt in response to the changes already under way in natural systems.

11.4.3 Human adaptations

Since the 1970s, an expanding body of literature has heightened awareness of the ecological impacts of economic development, and of their increasing severity. However, it is also increasingly recognized that environmental change is not only a consequence of affluence; it is also a cause and effect of poverty (WCED 1987). Malthusian forecasts indeed often present a scenario in which ecological collapse hits the poor first and hardest, causing famine and disease in developing countries on a scale surpassing anything yet experienced by the human species. In an era of global ecological and economic integration, the impacts of the crisis will be felt worldwide, inevitably affecting industrialized countries as well (Kaplan 1994).

Optimistic forecasts typically begin with a recognition that the needs of the developing world are tremendous, and those needs must be met, for humanitarian even more than for political reasons (MacNeill *et al.* 1991). It is therefore clear that continuing development will be necessary to meet the basic needs of present and future human populations (IUCN, WWF and UNEP 1980; WCED 1987). Optimistic scenarios envision several possible mechanisms

for averting global crisis, including continued technological development in response to growing population and resource constraints, sacrifice of future growth in consumption on the part of wealthy nations in order to allow future growth in the developing world (Goodland *et al.* 1991), and direct transfers of resources and technology to developing countries (Pearl 1989). Less clear is whether appropriate changes can and will be made in the policies and institutions that will determine patterns of growth and development.

11.4.3.1 The benefits of technology

Technological optimists often argue that even given recent evidence of the pace and scale of environmental change, human societies can continue to achieve quantitative and qualitative economic development through advances in science and technology. Technological optimism is typically linked to the economic arguments, for as Daly (1991) points out, in an era in which natural capital is the limiting factor to economic development, logic dictates that we maximize its supply and productivity. Environmental investment makes good economic sense; for example, Dogse and von Droste (1991) note that a US\$4.5 billion per year investment in soil protection world-wide would reduce annual agricultural losses by some US\$26 billion over a 20-year period. Furthermore, the world's shift from command to market economies offers greater opportunities for research and investment, since market economies are generally more open to change in response to signals of ecological distress (MacNeill *et al.* 1991; Ausubel 1993).

Technological innovation undoubtedly has the potential to stretch dramatically the limits of existing resources and systems in order to meet the needs of present and future human populations, and to alleviate many of the ecological and economic stresses caused by growing human populations and rising per capita resource consumption. Crop improvements and continuing developments in irrigation and pest control are likely to allow rising productivity as well as reducing known environmental impacts; for example, research is now under way to develop drought-resistant cassava and crops suitable for production on acidic soils (El-Sharkawy 1993; Rao *et al.* 1993). Continuing increases in food supply can also be maintained through increased aquacultural production as well as diversification of seafood consumption. Timber consumption can be reduced dramatically simply by further development of technologies to reduce waste or to mass-produce woodless paper (Postel 1994).

The effects of industrial emissions can also be reduced. For example, Goodland (1991) points out that the technology is available to reduce greatly the energy requirements of industry and other economic activity, so that carbon emissions can be reduced without necessarily implying a reduction in standards of living. To illustrate

this point, he notes that since 1973, Japan has increased its output by 81% without increasing energy use. Mills *et al.* (1991) conclude that even allowing for continued economic growth, by the year 2000 global greenhouse gas emissions can be reduced by 10% from current levels, at significant net economic benefit, through implementation of available energy-efficiency improvements. The impacts of ozone pollution on crop production can also be reduced by cutting the use of fossil fuels, limiting losses of nitrogen fertilizers from soils, implementing nitrogen oxide emission controls, and developing ozone-resistant crops. Enhanced networks for monitoring air quality throughout the world to assess the extent and severity of ozone pollution on continental scales will aid in evaluating the benefits of these mitigating strategies (Chameides *et al.* 1994).

As the rate and scale of global change has increased, so has the technological response. In the future, resource frontiers may expand beyond the Earth itself (e.g. Louis *et al.* 1993). In the shorter term, one of the most dramatic manifestations of technological response to resource limitations is biotechnology. Biotechnology, for example, offers the prospect of boosting crop yields with lower inputs of energy, water and pesticides. In the short term, potential advances include modification of food crops to increase resistance to insects, viruses and fungus; to improve processing quality or reduce spoilage; and to improve nutritional content. Fermentation and enzyme technology are already used in the manufacture of animal growth hormones to increase milk production or induce faster growth and production of leaner meat. In the long term, biotechnology may help to offset the impacts of global change on food supply, for example by producing staple crops that are resistant to drought, heat and other environmental stresses. New reproductive techniques for livestock, such as embryo transfer to stimulate production of multiple eggs for artificial insemination or cloning, could boost the reproductive rate of desirable species and reduce susceptibility to disease (Teale 1993; WRI 1994).

Biotechnology also offers the possibility of new production techniques that reduce emissions of chemicals and metals into the environment. Researchers have discovered that a completely biodegradable natural plastic is produced by some types of bacteria, which can be grown in large batches to harvest the plastic. Eventually, it may be possible to insert the genes into crop plants from which plastic could be harvested. Mass production of natural plastics could replace petroleum-based products in the market-place as well as easing problems of solid waste disposal (WRI 1994; Frederick and Egan 1994). Production of ethanol from waste materials, microbial coal desulphurization, and algae-fuelled combustion could reduce emissions to the atmosphere of chemicals contributing to acid rain and the greenhouse effect.

Biological elements are also used to detect organic

chemicals, pesticides and mercury in the environment, while bioremediation is increasingly used as a technology for cleaning polluted sites of metals and pesticides and treating acid drainage from coal mines. Biofilters are used to remove volatile organic compounds from industrial emissions, while bioleaching can lessen the environmental impacts of mining by enhancing recovery of minerals and reducing the release of metals into the environment (Frederick and Egan 1994).

It is becoming increasingly clear, however, that even rapid advances in productive and environmental remediation may not be sufficient. For example, increasing aquacultural output on the scale needed would require vast amounts of water and feed, and accelerate loss of coastal mangrove habitat (WCMC 1992; Brown 1994). Furthermore, the energy use and habitat modification associated with aquaculture also contribute to changes in the Earth's atmosphere and climate, which will in turn bring about dramatic changes in coastal ecosystems.

Biotechnology also brings its own set of problems and issues. In the past, human activities have resulted in biodiversity loss through the introduction of exotic species, a problem that could recur on a grander scale with the introduction of transgenic species. Altered organisms may out-compete other species in the environments in which they are released, or spread their altered genes by reproducing with native species (Pimental *et al.* 1989; Hoffman 1990; WRI 1994). Just as the Green Revolution was accompanied by hidden economic and environmental costs, it is possible that the Biotechnology Revolution will bring with it environmental consequences that have not yet been anticipated.

11.4.4 Constraints on human adaptations

11.4.4.1 Problems of uneven development

Technological solutions are also limited by their uneven availability. Not only is access to resources and skills unevenly distributed in the present, but the costs of new technology are likely to be prohibitive for many developing countries, so that future development will preserve the existing international economic structure for decades to come (Theys 1987). The first products of biotechnology research, for example, are just becoming available after 20 years of research, but research and development are concentrated in industrialized nations. Furthermore, much of the work in this area is directed toward high-value crops cultivated in developed nations, rather than the subsistence crops of tremendous importance to the developing world. Many of the products of biotechnology are likely to compete with tropical export commodities, further weakening the position of developing countries in international markets (WRI 1994).

The developed world is also much more likely to absorb successfully the economic costs associated with global climate change, and to have access to the benefits of biotechnology and other mitigative technologies that will allow the maintenance of high standards of living. Although there have been few attempts to date to compare human responses to climate change in developed and developing countries, Mooney *et al.* (1993) point out that high incomes in North America will facilitate mobility and adaptation in response to global change. By contrast, Fuentes and Muñoz (1993) hypothesize that climate change will force small-scale Chilean agriculturalists to intensify agricultural production on steep slopes and increase secondary activities such as logging and mining, thus intensifying the environmental impact of current land-use practices. Indeed, land-use and land-cover change are expected to outweigh the effects of climate change in South America. Low-income agricultural households in the developing world will be particularly vulnerable to the increasing frequency of extreme climatic events as well as temperature change, although forecasting of the effects on agricultural production has primarily been conducted in developed countries (Parry and Jiachen 1991).

11.4.4.2 *Prices, politics and alternative models of development*

Many observers argue that increasing supply from available resources, mitigating ecological damage associated with human activities, and developing adaptive technologies depend in large part on the ability to reform economic pricing and markets. Markets and prices must not only account for the environmental costs of production and consumption, but also compensate economic factors for the environmental benefits of resource conservation (McNeely 1988; Von Droste and Dogse 1991). Brenton (1994) considers that sustainable development will not emerge from 'dense webs of regulation' or the old command and control approach to environmental conservation, but only when conditions create more democracy, greater economic prosperity and a market that works for, rather than against, the interests of biodiversity. However, it is increasingly clear that the process of market reform and 'getting prices right' involves much more than simply freeing the market. Markets are the creation of human cultures, policies and institutions and are therefore subject to the many limitations of human understanding and politics.

The problem of scientific uncertainty is almost universal in the development of appropriate economic and environmental policy. According to Ludwig *et al.* (1993), the complexity and natural variability of biological and physical systems mean that levels of resource exploitation must be set by trial and error, with over-exploitation often not detectable until it is severe or even irreversible. Scientific consensus on the impacts of exploitation is

seldom achieved, even after the resource has collapsed. Furthermore, even when considerable scientific evidence exists that a given practice or technology will prove ecologically destructive, certainty has not proved sufficient to prevent the unsustainable use of resources. 'Resource problems are not really environmental problems: they are human problems that we have created at many times and in many places, under a variety of political, social and economic systems' (Ludwig *et al.* 1993: 549).

The development of appropriate economic and environmental policies to deal with biodiversity problems is thus hindered not only by problems of scientific certitude, but also by lack of understanding of the driving forces underlying individual and collective human behaviour and the relationships among human behaviour and global change. For example, only relatively recently has a body of evidence emerged on land-use and land-cover change that attempts to identify the social, economic and political forces that determine land-use patterns, and the understanding of relationships between land-use and global environmental change (Ojima *et al.* 1994). One of the contributions of this multidisciplinary research is the recognition that the fundamental causes of land-use and land-cover change may originate far from the ecosystem, or even region, affected. Regional and local responses to these causes vary widely depending on available resources and on local political, social and economic conditions, and further research is needed to determine local and regional variations in the human dynamics of global change (Kummer and Turner 1994; Skole *et al.* 1994; Collier *et al.* 1994).

One of the problems that this raises for appropriate environmental policy is 'scale mismatch', in which human responsibility does not match the spatial, temporal or functional scale of natural phenomena (Lee 1993). Adjustment of short-term, specialized human behaviours to account for their broader long-term ecological consequences depends in part on improved understanding of those consequences, but ultimately depends on politics (Holdgate 1991) – developing the institutions, management styles and policies that link individuals with their impacts on the global environment. Another growing body of research focuses on the development of diverse and context-specific institutional arrangements that correct such mismatches of scale and reduce the human conflicts they produce (Ostrom 1990; Bromley 1992; Haas *et al.* 1993).

11.4.4.3 *Building the capacity to adapt to change*

In the short term, policy-makers may be forced to respond to calls to limit human impacts on the Earth in ways suggested by the best available information and technology, even in the absence of consensus on human and natural systems. Given the scale of expected human-induced global change and the limitations of natural and

social science in predicting the future, some observers suggest that the major challenge in decades to come will be to adjust to the unexpected (Theys 1989). Planning methods for the uncertain and the unexpected involve adjusting the values for which ecosystems are managed, and adjusting the management styles adopted to achieve those values.

First, successful human adaptation to global change may depend on ecosystem management for the values of variability and resiliency, rather than for predictability, as has been the trend in the past. The maintenance of biological diversity is itself an important contributor to variability and resiliency, and many of the methods proposed for biodiversity conservation have important implications for global change. Walker (1989) suggests, for example, that conservation areas should maintain the elements of heterogeneity and variability that allow for change. Efforts to stabilize an ecosystem or to preserve an individual plant or animal species may be counterproductive, since ecosystem processes are the most critical value in conservation. Ryan (1992) applies this concept to intensively managed systems as well, noting that diversification of products and production methods within a management area also improves the capacity to adapt to change.

Second, several researchers have argued that planning for the uncertain and the unexpected can best be achieved by adopting a management style that is flexible, adaptive and experimental (Holling 1986). Holling argues that political decisions typically involve quick fixes for quick solutions, designed to maintain an imperfectly understood system in a constant state. The result is greater ecosystem fragility and higher stakes for future policy and management. The alternative of adaptive management is designed explicitly for decision-making in the face of uncertainty.

The principles of adaptive management may be described as follows: 'consider a variety of plausible hypotheses about the world; consider a variety of possible strategies; favour actions that are robust to uncertainties; hedge; favour actions that are informative; probe and experiment; monitor results; update assessments and modify policy accordingly; and favour actions that are reversible' (Ludwig *et al.* 1993: 549). Holling (1994) suggests a number of research strategies for experimentation in short-term change variables and monitoring of long-term shifts in ecosystem processes: experimentation and monitoring that combine perspectives from both the natural and social sciences may contribute greatly to our understanding of the human impact on global ecosystems.

Social and institutional learning is often an extremely slow process, and the scale and pace of changes in global biodiversity are increasing rapidly. However, the

possibility also exists for rapid change in human behaviour. For example, smokeless fuel regulations were adopted in response to killer smogs in London in the 1950s, and strong energy conservation measures were prompted by the oil crisis of the 1970s (Western 1989). More recently, abrupt shifts in management policies in response to ecological crises in a number of settings, from North America to the Baltic Sea, are also described by Gunderson *et al.* (1995; cited in Holling 1994). Thus while the unexpected may characterize the future, there are precedents for rapid leaps in the evolution of human capacity to modify human impacts on global ecosystems.

11.4.4.4 Uncertainty

The future is uncertain. We do not understand how little we know, nor what future citizens will value. H.G. Wells (1902), writing just before the Wright Brothers' first powered flight, was prescient regarding high-speed highways but could not imagine that airplanes might be important a dozen years later in World War I. Today we may be making similar errors in our valuation of ecosystems. Arguments for preservation of ecosystems such as rain forests include their use as a resource for medicinal chemicals, for preserving species, and for preserving indigenous cultures and knowledge systems. Additional arguments may emerge. For example, computer scientists are starting to explore adaptive, evolutionary, neo-biological designs based on close observations of ecosystems (Kelly 1994).

References

- Agger, P. and Brandt, J. 1988. Dynamics of small biotopes in Danish agricultural landscapes. *Landscape Ecology* 1: 227–240.
- Ahern, J. and Boughton, J. 1994. Wildflower meadows as suitable landscapes. In: Platt, R.H., Rowntree, R.A. and Muick, P.C. (eds), *The Ecological City: Preserving and restoring urban biodiversity*. 172–187. University of Massachusetts Press, Amherst.
- Ajjad, A.M., Mehl, K., Korsbrette, A.V., Dolgov, V.A., Tretyak, N.A. and Yaragina, N.A. 1992. Trophic relationships and feeding-dependent growth in the North-east Arctic cod. In: Bogstad, B. and Tjelmeland S. (eds), *Interrelationships Between Fish Populations in the Barents Sea*. 45–58. Institute of Marine Research, Bergen, Norway.
- Alcorn, J.B. 1989. Process as resource. *Advances in Economic Botany* 7: 31–63.
- Alcorn, J. B. 1993. Indigenous peoples and conservation. *Conservation Biology* 7: 424–426.
- Alexander, V. 1992. Arctic marine ecosystems. In: Peters, R.L. and Lovejoy, T.E. (eds), *Global Warming and Biological Diversity*. 221–232. Yale University Press, New Haven, Conn.
- Allan, D.J. and Flecker, A.S. 1993. Biodiversity conservation in running waters: identifying the major factors that threaten destruction of riverine species and ecosystems. *Bioscience* 43: 32–43.

- Allen, J.C., and Barnes, D.F. 1985. The causes of deforestation in developing countries. *Annals of the Association of American Geographers* 75: 163–184.
- Anderson, A.E. (ed.) 1990. *Alternatives to Deforestation: A sustainable use of the Amazon Rainforest*. Columbia University Press, New York.
- Anderson, V. 1991. *Alternative Economic Indicators*. Routledge, London.
- Angelstam, P. and Mikusinski, G. 1994. Woodpecker assemblages in natural and managed boreal and hemiboreal forest – a review. *Annales Zoologica Fennici* 31: 157–172.
- Angermeier, P.L. 1995. Ecological attributes of extinction-prone species: Loss of freshwater fishes of Virginia. *Conservation Biology* 9: 143–158.
- Angermeier, P.L. and Karr, J.R. 1994. Biological integrity vs. biological diversity as policy directives: protecting biotic resources. *BioScience* 44: 690–697.
- Angermeier, P.L. and Williams, J.E. 1994. Conservation of imperiled species and reauthorization of the Endangered Species Act of 1973. *Fisheries* 19: 26–29.
- Anonymous. 1989. *The Atmospheric Transport of Contaminants into the World's Oceans*. GESAMP Reports and Studies 48.
- Anthony, D.W. 1990. Migration in archaeology: the baby and the bathwater. *American Anthropologist* 92: 895–914.
- Arom, S. et al. 1993. *La science sauvage. Des savoirs populaires aux ethnosciences*. Inédit Sciences, Editions du Seuil, Paris.
- Ashton, A.H. and Mitchell, D.S. 1986. Aquatic invading species. In: Groves, R.H. and Burdon, J.J. (eds), *Ecology of Biological Invasions*. 34–56. Cambridge University Press, Cambridge.
- Ashton, P.S. and Mitchell, D.S. 1989. Aquatic plants: patterns and modes of invasion, attributes of invading species and assessment of control programmes. In: Drake, J.A., Mooney, H.A., di Castri, F., Groves, R.H., Kruger, F.J., Rejmánek, M. and Williamson, M. (eds), *Biological Invasions: A global perspective*. 111–147. SCOPE 37. John Wiley, New York.
- Atkinson, I.A.E. 1985. Spread of commensal species of *Rattus* to oceanic islands and their effects on island avifaunas. In: Moors, P.J. (ed.), *Conservation of Island Birds*. 35–84. ICBP Technical Publication No. 3.
- Atlas, E. and Giam, C.S. 1981. Global transport of organic pollutants: ambient concentrations in the remote marine atmospheres. *Science* 211: 163–165.
- Ausubel, J.H. 1993. 2020 vision. *The Sciences* 33: 14–19.
- Awad, M. 1962. Nomadism in the Arab lands of the Middle East. In: *The Problems of the Arid Zone*. 325–39. Arid Zone Research No. 18, UNESCO, Paris.
- Ayensu, E. 1983. The world's diminishing plant resources. In Jain, S.K. and Mehra, K.L. (eds), *Conservation of Tropical Plant Resources*. Botanical Survey of India, Calcutta.
- Aylward, B. and Barbier, E.B. 1992. Valuing environmental functions in developing countries. *Biodiversity and Conservation* 1: 34–50.
- Axelrod, D.I. 1985. The rise of the grassland biome, Central North America. *Botanical Review* 51: 163–201.
- Baker, H. 1970. *Plants and Civilization*. Macmillan, London.
- Balain, D.S. 1992. Animal genetic resources for sustainable agriculture. In: Jana and Swaminathan, M.S. (eds), *Biodiversity: Implications for global food security*. Macmillan, New Delhi.
- Baldock, D. 1990. *Agriculture and Habitat Loss in Europe*. WWF International CAP Discussion Paper Number 3. World Wide Fund for Nature, Gland, Switzerland.
- Balee, W. 1985. Ka'apor ritual hunting. *Human Ecology* 13: 485–510.
- Barel, C.D.N., Dorit, R., Greenwood, P.H., Fryer, G., Hughes, N., Jackson, P.B.N., Kawanabe, H., Lowe-McConnell, R.H., Nagoshi, M., Ribbink, A.J., Trewavas, E., Witte, F. and Yamaoka, K. 1985. Destruction of fisheries in Africa's lakes. *Nature* 315: 19–20.
- Barton, N.H. and Hewitt, G.M. 1989. Adaptation, speciation and hybrid zones. *Nature* 341: 497–503.
- Barzetti, V. (ed.) 1993. *Parks and Progress*. IUCN, IDB, Washington, DC.
- Basappanavar, C.H. 1993. Fire: the tragedy of Nagarhole. *Sanctuary Asia* 13.
- Baumgartner, T.R., Soutar, V. and Ferreira-Bartrina, V. 1992. *CalCOFI Report 33*.
- Bayush, T. 1991. *Community Management of Crop Genetic Resources in the Enset-Complex Farming Systems of Southern Ethiopia: A case study from Sidamo Region*. MSc thesis, NORAGRIC, Agricultural University of Norway.
- Bellon, M.R. 1991. The ethnecology of maize variety management: a case study from Mexico. *Human Ecology* 19: 389–418.
- Bellon, M.R. and Brush, S.B. 1994. Keepers of maize in Chiapas, Mexico. *Economic Botany* 48: 196–209.
- Bennett, B.A., Smith, C.R., Glaser, B. and Maybaum, H.L. 1994. Faunal community structure of a chemoautotrophic assemblage on whale bones in the deep northeast Pacific Ocean. *Marine Ecology Progress Series* 108: 205–223.
- Bennett, J.W. 1976. *The Ecological Transition: Cultural anthropology and human adaptation*. Pergamon Press, New York.
- Berck, R. 1979. Open access and extinction. *Econometrica* 47: 877–882.
- Bergeret, A. 1993. Discours et politiques forestières coloniales en Afrique et Madagascar. *Revue française d'histoire d'outre-mer* No. 298: 23–47.
- Berglund, B.E. 1969. Vegetation and human influence in South Scandinavia during Prehistoric time. *Oikos* 12 (Suppl): 9–28.
- Berglund, B.E., Larsson, L., Lewan, N., Olsson, E.G.A. and Skansjö, S. 1991. Ecological and social factors behind the landscape changes. In: Berglund, B.E. (ed.), *The Cultural Landscape During 6000 Years*. 425–448. *Ecological Bulletin* 41.
- Berkes, F. 1979. An investigation of Cree Indian domestic fisheries in northern Quebec. *Arctic* 32: 46–70.
- Berkes, F. 1987. Common property resource management and Cree Indian fisheries in subarctic Canada. In: McCay, B.J. and Acheson, J.M. (eds), *The Question of the Commons*. 66–91. University of Arizona Press, Tucson.
- Berkes, F. (ed.) 1989. *Common Property Resources: Ecology and community-based sustainable development*. Belhaven Press, London.
- Berkes, F., Feeny, D., McCay, B.J. and Acheson, J.M. 1989. The benefits of the commons. *Nature* 340: 91–93.
- Berkes, F. and Taghi Farvar, M. 1989. Introduction and overview. In: Berkes, F. (ed.), *Common Property Resources: Ecology and community-based sustainable development*. 1–17. Belhaven Press, London.

- Berry, B.J.L.** 1990. Urbanization. In: Turner, B.L., Clark, W.C., Kates, R.W., Richards, J.F., Mathews, J.T. and Meyer, W.B. (eds), *The Earth as Transformed by Human Action*. 103–121. Cambridge University Press, Cambridge.
- Beryand, M.E.** 1991. *Air Pollution*. Kluwer, Dordrecht.
- Beverton, R.J.H.** 1990. Small marine pelagic fish and the threat of fishing; are they endangered? *Journal of Fish Biology* **37** (Supplement A): 5–16.
- Beverton, R.J.H.** 1993. The Rio Convention and rational harvesting of natural fish resources: the Barents Sea experience in context. In: Sandlund, O.T. and Schei, P.J. (eds), *Norway/UNEP Expert Conference on Biodiversity*. 44–63. NINA, Trondheim.
- Bhagwati, J.** 1993. The case for free trade. *Scientific American* **269**: 42–48.
- Bilsborrow, R.E.** and Okoth-Ogendo, H.W.O. 1992. Population driven changes in landuse in developing countries. *Ambio* **21**: 37–45.
- Binford, M.W.** and M.J. Buchenau. 1993. Riparian greenways and water resources. In: *Ecology of Greenways*. 69–104. University of Minnesota Press, Minneapolis.
- Bisby, F.A.** 1994. Global master species databases and biodiversity. *Biology International* **29**: 33–40.
- Bisby, F.A.**, Russell G.F. and Pankhurst, R.J. (eds) 1993. *Designs for a Global Plant Species Information System*.
- Biswas, M.R.** 1994. Agriculture and environment: a review, 1972–1992. *Ambio* **23**: 192–197.
- Blaikie, P.** 1985. *The Political Economy of Soil Erosion in Developing Countries*. Longman, New York.
- Blank, L.W.** 1985. A new type of forest decline in Germany. *Nature* **314**: 311–314.
- Boef, W. de, Amanor, K., Wellardf, K. and Bebbington, A.** 1993. *Cultivating Knowledge: Genetic diversity, farmer experimentation and crop research*. Intermediate Technology Publications.
- Bond, W.J.** 1993. Keystone species. In: Mooney, H.A. and Schulze, E.D. (eds), *Biodiversity and Ecosystem Function*. 237–253. Springer-Verlag, Berlin.
- Boon, P.J.**, Callow, P. and Petts, G.E. (eds) 1992. *River Conservation and Management*. John Wiley, Chichester, UK.
- Borhidi, A.** 1988. Vegetation dynamics of the savannization process on Cuba. *Vegetatio* **77**: 177–183.
- Bormann, F.H.**, Likens, G.E. and Melillo, J.M. 1977. Nitrogen budget for an aggrading northern hardwood forest ecosystem. *Science* **196**: 881–893.
- Bose, A.** 1991. *Demographic Diversity of India: 1991 Census*. B.R. Publishing, Delhi.
- Boserup, E.** 1965. *The Conditions of Agricultural Growth: The economics of agrarian change under population pressure*. Aldine, Chicago.
- Boulding, K.E.** 1973. Zoom, gloom, doom and room. *The New Republic* **169** (6): 25–27.
- Boyden, S.** 1992. *Biohistory: The interplay between human society and the biosphere, past and present*. Parthenon, London.
- Boyden, S.** and Dovers, S. 1992. Natural-resource consumption and its environmental impacts in the western world: Impacts of increasing per capita consumption. *Ambio* **21**: 63–69.
- Brandon, K.** and Wells, M. 1992. Planning for people and parks: Design dilemmas. *World Development* **20**: 557–570.
- Bratton, S.P.** 1982. The effects of exotic plant and animal species on nature preserves. *Natural Areas Journal* **2**: 3–12.
- Braudel, F.** 1979a. *Civilisation Matérielle, Economie et Capitalisme*. Tôme 1. *Les structures du quotidien: le possible et l'impossible*. Collins, Paris.
- Braudel, F.** 1979b. *Civilisation Matérielle, Economie et Capitalisme*. Tôme 2. *Le jeu de l'échange*. Collins, Paris.
- Braudel, F.** 1979c. *Civilisation Matérielle, Economie et Capitalisme*. Tôme 3. *Le temps du monde*. Collins, Paris.
- Brenton, T.** 1994. *The Greening of Machiavelli: The evolution of international environmental politics*. Earthscan/Royal Institute of International Affairs, London.
- Breymeyer, A.I.** 1990. Managed grasslands and ecological experience. In: Breymeyer, A.I. (ed.), *Managed Grasslands Regional Studies*. Elsevier, Oxford.
- Breytenbach, G.J.** 1986. Impact of alien organisms on terrestrial communities with emphasis on communities of the south-western Cape. In: Macdonald, I.A.W., Kruger, F.J. and Ferrar, A.A. (eds), *The Ecology and Management of Biological Invasions in Southern Africa*. Proceedings of the National Synthesis Symposium on the ecology of biological invasions. 229–238. Oxford University Press, Cape Town.
- British Petroleum**, 1993. *BP Statistical Review of World Energy*. British Petroleum, London.
- Brockie, R.E.**, Loope, L.L., Usher, M.B. and Hamann, O. 1989. Biological invasions of island nature reserves. *Biological Conservation* **44**: 9–36.
- Bromley, D.W.** (ed.) 1992. *Making the Commons Work*. Institute for Contemporary Studies Press, San Francisco.
- Bromley, D.** and Cernea, M.B. 1989. *The Management of Common Property Natural Resources. Some conceptual and operational fallacies*. World Bank Disc. paper, PPR. N.57.
- Brooke, R.K.**, Lloyd, P.H. and de Villiers, A.L. 1986. Alien and translocated vertebrates in South Africa. In: Macdonald, I.A.W., Kruger, F.J. and Ferrar, A.A. (eds), *The Ecology and Management of Biological Invasions in Southern Africa*. Proceedings of the National Synthesis Symposium on the ecology of biological invasions. Oxford University Press, Cape Town.
- Brown, J.H.** 1971. Mammals on mountain tops: nonequilibrium insular biogeography. *American Naturalist* **105**: 164–167.
- Brown, L.** (ed.) 1985. *State of the World 1985: A Worldwatch Institute report on progress toward a sustainable society*. W.W. Norton & Co., New York.
- Brown, L.R.** 1994. Facing food insecurity. In: Brown, L.R. et al. *State of the World 1994*. 177–197. W.W. Norton & Co., New York.
- Brown, M.** and Wyckoff-Baird, B. 1992. *Designing Integrated Conservation and Development Projects*. Biodiversity Support Program, Washington DC.
- Brush, S.B.** 1991. A farmer-based approach to conserving crop germplasm. *Economic Botany* **45**: 153–165.
- Bryson, R.A.** 1993. Simulating past and forecasting future climates. *Environmental Conservation* **20**: 339–346.
- Bucher, J.B.**, and Bucher-Wallin, I. (eds). 1989. *Air Pollution and Forest Decline: Proceedings of the International Meeting for Specialists in Air Pollution Effects of Forest Ecosystems*,

- Vols. 1 and 2. Eidgenössische Anstalt für das Förstliche Versuchswesen, Birmensdorf.
- Burger, J.** 1990. *The Gaia Atlas of First People*. Doubleday, New York.
- Burgess J.** 1994. *The Environmental Effects of Trade*. OCDE, Paris.
- Burnett, G.W. and Stilwell, H.B.** 1990. National park and equivalent reserve creation in French and British Africa. *Society and Natural Resources* **3**: 229–241.
- Burney, D.A.** 1993. Recent animal extinctions: Recipes for disaster. *American Scientist* **81**: 530–541.
- Burrows, N.D. and Christensen, P.E.S.** 1991. A survey of aboriginal fire patterns in the western desert of Australia. In: Nodvin, S.C. and Waldrop, T.A. (eds), *Ecological and Cultural Perspectives*. Proceedings of an International Symposium, Knoxville, Tennessee, 20–24 March 1990, Southeastern Forest Experimental Station, NC.
- Bush, M.B. and Flenley, J.R.** 1987. The age of the British chalk grassland. *Nature* **329**: 434–436.
- Butman, C.A., Carlton, J.T. and Palumbi, S.R.** 1995. Whaling effects on deep-sea biodiversity. *Conservation Biology* **9**: 462–464.
- Caddy, J.F.** 1993. Contrast between recent fishery trends and evidence for nutrient enrichment in two large marine ecosystems: the Mediterranean and the Black Seas. In: Sherman, K., Alexander, L.M. and Gold, B.D. (eds), *Large Marine Ecosystems: Stress mitigation and sustainability*. 21. AAAS Press, Washington, DC.
- Cairns, M.A. and Lackey, R.T.** 1992. Biodiversity and management of natural resources: the issues. *Fisheries* **17**: 6–10.
- Campbell, D.D.** 1975. On the conflicts between biological and social evolution and between psychology and moral tradition. *American Psychologist* **30**: 1103–1126.
- Carew-Reid, J.** 1993. Learning to care for the people. *People and Planet* **2**: 6–9.
- Carlton, J.T.** 1989. Man's role in changing the face of the ocean: biological invasions and implications for conservation of nearshore environments. *Conservation Biology* **3**: 265–273.
- Carlton, J.T. and Geller, J.B.** 1993. Ecological roulette; the global transport of non-indigenous marine organisms. *Science* **261**: 78–82.
- Carmichael, D.L., Hubert, J., Reeves, B. and Schanche, A.** 1994. *Sacred Sites, Sacred Places*. Routledge, London.
- Carson, R.** 1962. *Silent Spring*. Fosset Crest, New York.
- Caseldine, C. and Hatton, J.** 1993. The development of high moorland on Dartmoor: fire and the influence of Mesolithic activity on vegetation change. In: Chambers, F.M. (ed.), *Climate Change and Human Impact on the Landscape*. 119–131. Chapman and Hall, London.
- Cassidy, C.M.** 1980. Nutrition and health in agriculturalists and hunter-gatherers: a case study of two prehistoric populations. In: Jerome, N.W., Kandel, R.F. and Pelto, G.H. (eds), *Nutritional Anthropology: Contemporary approaches to diet and culture*. Redgrave, New York.
- Caulfield, C.** 1984. *In the Rainforest. Report from a strange, beautiful, imperiled world*. The University of Chicago Press, Chicago.
- Caughley, G.** 1994. Directions in conservation biology. *Journal of Animal Ecology* **63**: 215–244.
- Cavalli-Sforza, L.L., Menozzi, P. and Piazza, A.** 1993. Demic expansions and human evolution. *Science* **259**: 639–646.
- CEPAL (Comisión Económica para América Latina).** 1982. *Economía campesina y agricultura empresarial*. Siglo Veintiuno Editores, Mexico, D.F.
- Chagnon, N.A.** 1988. Life histories, blood revenge, and warfare in a tribal population. *Science* **239**: 985–992.
- Chaitanya, K.** 1992. The Earth as sacred environs. In: *Indigenous Vision: Peoples of India attitudes to the environment*. 35–48. India International Centre Quarterly, New Delhi.
- Chameides, W.L., Kasibhatla, P.S., Yienger, J. and Levy, H. II.,** 1994. Growth of continental-scale metro agro plexus, regional ozone pollution, and world food production. *Science* **264**: 74–77.
- Chandran, M.D.S. and Gadgil, M.** 1993. 'Kans' – Safety forests of Uttara Kannada. In: Brandl, H. (ed.), *Proceedings of IUFRO Meeting on Forest History*. 49–57. Abteilung Betriebswirtschaft Nr. 40, Freiburg.
- Chaney, W.R., and Basbous, M.** 1978. The cedars of Lebanon: witness of history. *Economic Botany* **32**: 118–123.
- Chauvet, E. and Decamps, H.** 1989. Lateral interactions in a fluvial landscape: the River Garonne, France. *Journal of the North American Benthic Society* **8**: 9–17.
- Chew, K.K.** 1990. Global bivalve shellfish introductions. *Journal of the World Aquaculture Society* **21**: 9–22.
- Chia, L.S., Mayfield, C.I. and Thompson, J.E.** 1984. Simulated acid rain induces lipid peroxidation and membrane damage in foliage. *Plant, Cell and Environment* **7**: 333–338.
- Ciriacy-Wantrup, S.V. and Bishop, R.C.** 1975. 'Common property' as a concept in natural resources policy. *Natural Resources Journal* **15**: 713–727.
- Clapp, J.** 1994. The toxic waste trade with less industrialised countries: economic linkages and political alliances. *Third World Quarterly* **15**: 505–518.
- Clark, C.W.** 1989. Bioeconomics. In: Roughgarden, J., May, R.M. and Levin, S.A. (eds.), *Perspectives in Ecological Theory*. 275–286. Princeton University Press, Princeton, NJ.
- Clutton-Brock, J.** 1981. *Domesticated Animals from Early Times*. British Museum of Natural History, London.
- Cobb, C.W.** 1989. The index of sustainable economic welfare (Appendix). In: Daly, H.E. and Cobb, J.B. (eds), *For the Common Good*. Beacon Press, Boston.
- Cody, M.L.** 1986. Diversity, rarity and conservation in Mediterranean-climate regions. In: Soulé, M.E. (ed.), *Conservation Biology: The science of scarcity and diversity*. 122–152. Sinauer Associates, Cambridge, Mass.
- Cohen, M. and Armelagos, G.** 1984. *Paleopathology at the Origins of Agriculture*. Academic Press, Orlando, Fla.
- Collier, G.A.** 1990. Seeking food and seeking money: changing relations in a highland Mexican community. *United Nations Research Institute for Social Development Discussion Paper* 11. UNRISD, Geneva.
- Collier, G.A., Mountjoy, D.C. and Nigh, R.B.** 1994. Peasant agriculture and global change. *BioScience* **44**: 398–407.
- Collins, N.M.** 1980. The effect of logging on termite (Isoptera) diversity and decomposition processes in lowland dipterocarp. In: Furtado, J.I. (ed.), *Tropical Ecology and Development*.

- Proceedings of the Vth International Symposium of Tropical Ecology. The International Society of Tropical Ecology, Kuala Lumpur.
- Collins, N.M., Sayer, J.A. and Whitmore, T.C.** 1991. *The Conservation Atlas of Tropical Forests. Asia and the Pacific*. Macmillan, New York.
- Condit, R., Hubbel, S.P. and Foster, R.B.** 1992. Short-term dynamics of a Neotropical forest. *BioScience* **42**: 822–828.
- Coon, S.C.** 1971. *The Hunting Peoples*. Nick Lyons Books, New York.
- Coppoio, G.** 1995. The threatened Galapagos bulimulid snails: an update. In: Kay, E.A. (ed.), *The Conservation Biology of Molluscs*. Proceedings of a Symposium held at the 9th International Malacological Congress, Edinburgh, Scotland, 8–11. Occasional Paper of the Species Survival Commission No. 9. IUCN, Gland.
- Corlett, R.** 1992. Conserving the natural flora and fauna in Singapore. In: Huat, C.B. and Edwards, N. (eds), *Public Space: Design, use and management*. 128–137. Singapore University Press, Singapore.
- Costanza, R. (ed.)** 1991. *Ecological Economics: The science and management of sustainability*. Columbia University Press, New York.
- Cowgill, G.L.** 1975. On causes and consequences of ancient and modern population changes. *American Anthropologist* **77**: 505–525.
- Cox, S.J.B.** 1985. No tragedy on the commons. *Environmental Ethics* **7**: 49–61.
- Craig, P.P. and Glasser, H.** 1993. *Transfer Models and Explicit Uncertainty: An approach to intergenerational 'Green Accounting'*. Paper presented at a National Academy of Sciences workshop on Valuing Natural Capital for Sustainable Development. Woods Hole, Mass. To be published by the NAS.
- Crosby, A.W.** 1986. *Ecological Imperialism: The biological expansion of Europe 900–1900*. Cambridge University Press, Cambridge.
- Crowley, T.J. and North, G.R.** 1988. Abrupt climate change and extinction events in earth history. *Science* **240**: 996–1002.
- Cruz, M.C., Meyer, C., Repetto, R. and Woodward, R.** 1992. *Population Growth, Poverty and Environmental Stress: Frontier migration in the Philippines and Costa Rica*. World Resources Institute, Washington, DC.
- CSIRO.** (1995). *Conference on Nature Conservation: The role of networks*. Surrey Beatty and Sons, Chipping Norton, NSW.
- Cumming, D.H.M., Du Toit, R.F. and Stuart, S.N.** 1990. African Elephants and Rhinos. *Status Survey and Conservation Action Plan*. IUCN, Gland.
- Cushing, D.H.** 1980. The decline of the herring stocks and the gadoid outburst. *Journal du Conseil International de l'Exploration de la Mer* **39**: 70–81.
- Daly, H.E.** 1990. Toward some operational principles of sustainable development. *Ecological Economics* **2**: 1–6.
- Daly, H.E.** 1992. Free trade, sustainable development and growth: Some serious contradictions. *Eco-decision*, June: 10–13.
- Daly, H.E. and Cobb, J.B., Jr** 1989. *For the Common Good: Redirecting the economy towards community, the environment and a sustainable future*. Merlin Press, London.
- Dankelman, I.** 1993. Women, children and environment: implications for sustainable development. In: Steady, F.C. (ed.), *Women and Children First*. Schenkman Books, Rochester, Vermont.
- Darling, F.F.** 1956. Man's ecological dominance through domesticated animals on wild lands. In Thomas, W.L., Jr (ed.), *Man's Role in Changing the Face of the Earth*. 778–787. University of Chicago Press, Chicago.
- Dasgupta, D.S.** 1983. *The Control of Resources*. Harvard University Press, Cambridge, Mass.
- Dasmann, R.F.** 1975. National parks, nature conservation, and 'future primitive'. *Ecologist* **65**: 164–167.
- Dasmann, R.F.** 1988. Toward a biosphere consciousness. In: Worster, D. (ed.), *The Ends of the Earth*. 277–288. Cambridge University Press, Cambridge.
- Davidson, D.R.** 1992. Energy issues in sub-Saharan Africa: Future Directions. *Annual Review of Energy and Environment* **17**: 359–403.
- Davies, N.** 1981. *Human Sacrifice in History and Today*. William Morrow, New York.
- Davis, M.B. and Zabinski, C.** 1992. Changes in geographical range resulting from greenhouse warming: effects on biodiversity in forests. In: Peters, R.L. and Lovejoy, T.E. (eds), *Global Warming and Biological Diversity*. 297–308. Yale University Press, New Haven, Conn.
- Davis, S.H.** 1977. *Victims of the Miracle: Development and the Indians of Brazil*. Cambridge University Press, Cambridge.
- Dawson, W.R.** 1992. Physiological responses of animals to higher temperatures. In: Peters, R.L. and Lovejoy, T.E. (eds). *Global Warming and Biological Diversity*. 158–170. Yale University Press, New Haven, Conn.
- de Groot, R.S.** 1992. *Functions of Nature. Evaluation of nature in environmental planning, management and decision making*. Wolters-Noordhoff, Groningen.
- de Klemm, C. and Shine, C.** 1993. *Biological Diversity Conservation and the Law*. IUCN, Gland.
- Delcourt, P.A., Delcourt, H.R., Morse, D.F. & Morse, P.A.** 1993. History, evolution and organization of vegetation and human culture. In: Martin, W.H., Boyce, S.G. & Echternacht, A.D. (eds.) *Biodiversity of the Southeastern United States*. 47–79. John Wiley, New York.
- Delong, R., Gilmartin, W.G. and Simpson, J.G.** 1973. Premature births in California sea lions: Association with high organochlorine pollutant residue levels. *Science* **181**: 1168–1170.
- Denevan, W.M.** 1992. *The Native Population of the Americas in 1492*, 2nd edn. University of Wisconsin Press, Madison.
- Desaigues, B. and Point, P.** 1993. *Economie du patrimoine naturel: La valorisation des bénéfices de protection de l'environnement*. Economica, Paris.
- Devillers, P.** 1988. Agricultural changes in scrub and grassland. In: Park, J.R. (ed.), *Environmental Management in Agriculture – European Perspectives*. Belhaven Press, London.
- de Young and Rose.** 1993. *Canadian Journal of Fisheries and Aquatic Sciences* **50**: 2729–2741.
- Diamond, J.M.** 1985. Introductions, extinctions, exterminations, and invasions. In: Case, T.J. and Diamond, J.M. (eds.), *Community Ecology*. 65–79. Harper and Row, New York.

- Diamond, J.M.** 1989. The present, past and future of human-caused extinctions. *Philosophical Transactions of the Royal Society of London, B* **325**: 469–477.
- Diamond, J.M.** 1991. *The Rise and Fall of the Third Chimpanzee*. Vintage, London.
- Diamond, J.M.** 1994. Ecological collapses of ancient civilizations: the golden age that never was. *Bulletin of the American Academy of Arts and Sciences* **47**: 37–59.
- Diamond, J.M.** and Veitch, C.R. 1981. Extinctions and introductions in the New Zealand avifauna: cause and effect? *Science* **211**: 499–501.
- di Castri, F.** 1989. History of biological invasions with special emphasis on the Old World. In: Drake, J.A., Mooney, H.A., di Castri, F., Groves, R.H., Kruger, F.J., Rejmánek, M. and Williamson, M. (eds), *Biological Invasions: A global perspective*. 1–26. SCOPE 37. John Wiley, Chichester.
- di Castri, F., Vernhes Robertson, J.** and Younès, T. 1992. Inventorying and monitoring biodiversity. A proposal for an international network. *Biology International*, special issue No. 27.
- di Castri, F.** and Younès, T. 1994. Diversitas: yesterday, today and a path towards the future. *Biology International* **29**: 3–23.
- Dickson, R.R.**, and Brander, K.M. 1993. *Fish Oceanography* **2**: 124–153.
- Dionne, E.J.** 1993. Free trade is on a collision course with democracy. *International Herald Tribune*, 1 April 1993.
- Dirks, R.** 1980. Social responses during severe food shortages and famine. *Current Anthropology* **21**: 21–44.
- Dodd, J.L.** 1994. Desertification and degradation in sub-Saharan Africa: the role of livestock. *BioScience* **44**: 28–34.
- Dogsé, P.** and von Droste, B. 1990. *Debt-for-Nature Exchanges and Biosphere Reserves*. UNESCO, Paris.
- Döös, B.R.**, 1994. Environmental degradation, global food production, and risk for large-scale migrations. *Ambio* **23**: 124–130.
- Douglas, I.** 1990. Sediment transfer and siltation. In: Turner, B.L., Clark, W.C., Kates, R.W., Richards, J.F., Mathews, J.T. and Meyer, W.B. (eds), *The Earth as Transformed by Human Action*. 215–234. Cambridge University Press, Cambridge.
- Dove, M.R.** 1986. Man, land and game in Sumbawa: Some observations on agrarian ecology and development policy in Eastern Indonesia. *Singapore Journal of Tropical Geography* **5**: 112–124.
- Dove, M.R.** 1993. A revisionist view of tropical deforestation and development. *Environmental Conservation* **20**: 17–24.
- Dover, N.** and Talbot, L.M. 1987. *To Feed the Earth: Agroecology for sustainable development*. World Resources Institute, Washington, DC.
- Drake, J.A., Mooney, H.A., di Castri, F., Graves, R.H., Kruger, F.J., Rejmánek, M.** and Williamson, M. (eds) 1989. *Biological Invasions: A global perspective*. SCOPE 37. John Wiley, Chichester.
- Dudley, N.** 1992. *Forests in Trouble: A review of the status of temperate forests worldwide*. Worldwide Fund for Nature, Gland.
- Dugan, P.J.** (ed.) 1990. *Wetland Conservation: A review of current issues and required action*. IUCN, Gland.
- Durning, A.T.** 1992. *How Much is Enough? The Consumer Society and the Future of the Earth*. EarthScan Publications, London.
- Durning, A.T.** 1994. Redesigning the forest economy. In: Brown, L.R. et al., *State of the World 1994*. 22–40. W.W. Norton & Co., New York.
- Dynesius, M.** and Nilsson, C. 1994. Fragmentation and flow regulation of river systems in the northern third of the World. *Science* **266**: 753–762.
- Eaton, S.B., Shostak, M.** and Konner, M. 1988. *The Paleolithic Prescription*. Harper and Row, New York.
- Eder, J.F.** 1987. *On the Road to Tribal Extinction: Depopulation, deculturation, and adaptive well-being among the batak of the philippines*. University of California Press, Berkeley.
- Edgerton, R.B.** 1992. *Sick Societies: Challenging the myth of primitive harmony*. The Free Press, New York.
- Egidius, E., Hansen, L.P., Jonsson, B.** and Nævdal, G. 1991. Mutual impact of wild and cultured Atlantic salmon in Norway. *Journal du Conseil International de l'Exploration de la Mer* **47**: 404–410.
- Ehrenfeld, D.** 1988. Why put a value on biodiversity? In: Wilson, E.O. and Peter, F.M. (eds), *Biodiversity*. 212–216. National Academy Press, Washington, DC.
- Ehrlich, P.R.** 1989. Discussion: ecology and resource management – is ecological theory any good in practice? In: Roughgarden J., May, R.M. and Levin, S.A. (eds), *Perspectives in Ecological Theory*. 306–318. Princeton University Press, Princeton, NJ.
- Ehrlich, P.R.** and Ehrlich, A.H. 1981. *Extinction: The causes and consequences of the disappearance of species*. Random House, New York.
- Ehrlich, P.R.** and Ehrlich, A.H. 1990. *The Population Explosion*. Simon and Shuster, New York.
- Ekins, P.** 1993. The sustainability question: Are there limits to economic growth? *Traces* 36–39.
- Elder, D.** and Pernetta, J. (eds), 1991. *Oceans. A Mitchell Beazley, World Conservation Atlas*. Mitchell Beazley, London.
- Ellen, R.** 1982. *Environment, Subsistence and Systems: The ecology of small-scale social formations*. Cambridge University Press, New York.
- Ellis, W.S.** 1990. A Soviet sea lies dying. *National Geographic* **177**: 73–93.
- Elmes, G.W.** and Thomas, J.A. 1992. Complexity of species conservation in managed habitats: interaction between *Maculinea* butterflies and their ant hosts. *Biodiversity and Conservation* **1**: 155–169.
- El-Sayed, S.Z.** 1988. Fragile life under the ozone hole. *Natural History* **10**: 73–80.
- El-Sharkawy, M.A.** 1993. Drought-tolerant cassava for Africa, Asia, and Latin America. *BioScience* **43**: 441–451.
- Elton, C.S.** 1958. *The Ecology of Invasions by Animals and Plants*. Methuen, London.
- Emanuel, K.A.** 1987. The dependence of hurricane intensity on climate. *Nature* **326**: 483–485.
- Eney, A.B.** and Petzold, D.E. 1987. The problem of acid rain: an overview. *The Environmentalist* **7**: 95–103.
- ESCAP.** (Economic and Social Commission for Asia and the Pacific) 1990. *State of the Environment in Asia and the Pacific 1990*. United Nations, Bangkok, Thailand.

- Evans, P.G.H.** 1987. *The Natural History of Whales and Dolphins*. Facts on File Publications, New York.
- Fairhead, J.** and Leach, M. 1993. Contested Forests: Modern conservation and historical landuse of Guinea's Ziama Reserve. Working paper 7, Connaissance et organization locale agro-ecologique, Conakry, Guinea.
- Fajer, E.D., Bowers, M.D. and Bazzaz, F.A.** 1989. The effects of enriched carbon dioxide atmospheres on plant-insect herbivore interactions. *Science* **243**: 1198-1200.
- Food and Agriculture Organization of the United Nations.** 1990a. *Commodity Year Book, 1989*. FAO, Rome.
- FAO.** 1990b. *Review of the State of the World Fishery Resources*. FAO Fish Circ 710 Rev. 7.
- FAO.** 1992. *FAO Year Book*. Vol. 45. 1991. FAO, Rome.
- FAO.** 1993. *Forest Resources Assessment, 1990: Tropical Countries*. FAO Forestry Paper 112. FAO, Rome.
- Feeny, D., Berkes, F., McCay, B.J. and Acheson, J.M.** 1990. The tragedy of the commons: twenty-two years later. *Human Ecology* **18**: 1-19.
- Feeny, D., Picht, H. and Ostrom, V.** 1993. *Rethinking Institutional Analysis and Development*. Institute for Contemporary Studies Press, San Francisco.
- Ferguson, R.B.** 1989. Ecological consequences of Amazonian warfare. *Ethnology* **28**: 249-264.
- Fisher, R.** 1992. *Contact and Conflict: Indian-European relations in British Columbia 1774-1890*, 2nd edn. University of British Columbia Press, Vancouver.
- Flannery, K.** 1973. The origins of agriculture. *Annual Review of Anthropology* **2**: 271-310.
- Frank, A., Galgan, V. and Petersson, L.R.** 1994. Secondary carbon deficiency, chromium deficiency, and trace element imbalance in the moose: effect of anthropogenic activity. *Ambio* **23**: 315-317.
- Frankel, O.M. and Soulé, M.E.** 1981. *Conservation and Evolution*. Cambridge University Press, Cambridge.
- Frederick, R.J. and Egan, M.** 1994. Environmentally compatible applications of biotechnology. *Bioscience* **44**: 529-535.
- Freedman, B.** 1989. *Environmental Ecology: The impacts of pollution and other stresses on ecosystem structure and function*. Academic Press, San Diego.
- Freudenberger, M.S.** 1993. Regenerating the gum Arabic economy: local-level resource management in northern Senegal. In: Friedmann, J. and Rangan, H. (eds), *In Defense of Livelihood*. 52-78. Kumerian Press, West Hartford.
- Freudenberger, M.S. (ed.)** 1993. *Institutions and Natural Resource Management in the Gambia: A Case Study of the Foni Jarrol District*. LTC Research Paper No. 114.
- Friedel, M.H., Foran, B.D. and Stafford Smith, D.M.** 1990. Where the creeks run dry or ten feet high: pastoral management in arid Australia. In: Saunders, D.A., Hopkins, A.J.M. and How, R.A. (eds), *Australian Ecosystems: 200 years of utilization, degradation and reconstruction*. Proceedings of the Ecological Society of Australia 1990-16. Surrey Beatty and Sons Ltd, Chipping Norton, NSW.
- Frissell, C.A.** 1993. Topology of extinction and endangerment of native fishes in the Pacific North-West and California. *Conservation Biology* **7**: 342-354.
- Frolich, R.** 1989. The shelf life of Antarctic ice. *New Scientist*, Nov. 62-65.
- FSI (Forest Survey of India).** 1987. *State of Forest Report 1987*. FSI, Dehra Dun.
- Fuentes, E.R. and M. R. Munoz.** 1993. Global warming and human impacts on landscapes of Chile. In: Mooney, H.A., Fuentes, E.R. and Kronberg, B.I. (eds), *Earth System Responses to Global Change: Contrasts between North and South America*. 329-346. Academic Press, San Diego.
- Fuller, R.J., Hill, D. and Tucker, G.M.** 1991. Feeding the birds down on the farm: perspectives from Britain. *Ambio* **20**: 232-237.
- Fürer-Haimendorf, C. von.** 1982. *Tribes of India: The struggle for survival*. University of California Press, Berkeley.
- Gadgil, M.** 1987. Diversity: cultural and biological. *Trends in Ecology and Evolution* **2**: 369-373.
- Gadgil, M.** 1993. Of life and artifacts. In: Kellert, S. and Wilson, E.O. (ed.), *The Biophilia Hypothesis*. 365-377. Island Press, Washington, DC.
- Gadgil, M. and Berkes, F.** 1991. Traditional resource management systems. *Resource Management and Optimization* **18**: 127-141.
- Gadgil, M. and Chandran, M.D.S.** 1992. Sacred Groves. In: *Indigenous Vision: Peoples of India attitudes to the environment*. 183-187. India International Centre Quarterly, New Delhi.
- Gadgil, M. and Guha, R.** 1992. *This Fissured Land: An ecological history of India*. Oxford University Press, Delhi.
- Gadgil, M. and Meher Homji, V.M.** 1985. Land use and productive potential of Indian savannas. In: Tohill, J.C. and Mott, J.J. (eds), *Ecology and Management of the World's Savannas*. 107-113. The Australian Academy of Sciences, Canberra.
- Gadgil, M., Berkes, F. and Folke, C.** 1993. Indigenous knowledge for biodiversity conservation. *Ambio* **22**: 151-156.
- Galloway, J.N., Levy H. II, and Kasibhatia, P.S.** 1994. Year 2020: consequences of population growth and development on deposition of oxidized nitrogen. *Ambio* **23**: 120-123.
- Gammon, J.R., Johnson, M.D., Mays, C.E., Schiappa, D.A., Fisher, W.L. and Pearman, B.L.** 1983. *Effects of Agriculture on Stream Fauna in Central Indiana*. EPA.600/S3-83-020, Environmental Research Laboratory, US Environmental Agency, Corvallis, Oregon.
- Gandar, M.V.** 1982. The dynamics and trophic ecology of grasshoppers in a South African savanna. *Oecologia* **54**: 370-378.
- García, S.** 1994. The precautionary principle: Its implications in capture fisheries management. *Ocean and Coastal Management* **22**: 99-125.
- Gates, D.M.** 1993. *Climate Change and its Biological Consequences*. Sinauer Associates, Sunderland, Mass.
- GESAMP (Joint Group of Experts on the Scientific Aspects of Marine Pollution).** 1990. *The State of the Marine Environment*. Regional Seas Reports and Studies, 115. UNEP, Nairobi.
- Gibbs, H.L. and Grant, P.R.** 1987. Ecological consequences of an exceptionally strong El Niño event on Darwin's finches. *Ecology* **68**: 1735-1746.
- Gimingham, C.H. and de Smidt, J.T.** 1983. Heaths as natural and semi-natural vegetation. In: Holzner, W., Werger, M.J.A. and Ikusima, I. (eds), *Man's Impact on Vegetation*. 185-199. Junk Publishers, The Hague.

- Gjosæter, H.** 1995. Pelagic fish and the ecological impact of the modern fishin industry in the Barents Sea. *Journal of the Arctic Institute of North America* (in press).
- Gliwicz, J., Goszczynski, J. and Luniak, M.** 1994. Characteristic features of animal populations under synurbanization – the case of the blackbird and of the striped field mouse. In: Barker, G.M., Luniak, M., Trojan, P. and Zimny, H. (eds), *Proceedings of the Second European Meeting of the International Network for Urban Ecology*. 237–244. *Memorabilia Zoologica* 49, Warsaw.
- Glowka, L., Burhenne-Guilmin, F., Synge, H., McNeely, J.A., and Gündling, L.** 1994. *A Guide to the Convention on Biological Diversity*. IUCN, Gland.
- Goldsmith, E., Allen, R., Allaby, M., Davull, J. and Lawrence S.** 1972. A blueprint for survival. *The Ecologist*.
- Goldsmith, F.B.** 1973. The ecologist's role in ther development for tourism: A case study in the Caribbean. *Biological Journal of the Linnean Society* 5: 265–287.
- Goodland, R., Daly, H. and El Serafy, S.** (eds), 1991. *Environmentally Sustainable Economic Development: Building on Brundtland*. UNESCO, Paris.
- Goodman, A.H. and Armelagos, G.J.** 1988. Childhood stress and decreased longevity in a prehistoric population. *American Anthropologist* 90: 936–943.
- Goodman, M.M. and Brown, W.L.** 1988. Races of corn. In: Sprague, G.F. and Dudley, J.W. (eds), *Corn and Corn Improvement*. 33–79. American Society of Agronomy, Madison, Wis.
- Gómez-Pompa, A. and A. Kaus.** 1992. Taming the wilderness myth. *BioScience* 42: 271–279.
- Goudie, A.** 1993. *The Human Impact on the Natural Environment*, 4th edn. Blackwell, Oxford.
- Gould, S.J.** 1989. *Wonderful Life: The Burgess Shale and the nature of history*. Penguin Books, London.
- Grainger, A.** 1992. *Controlling Tropical Deforestation*. Earthscan, London.
- Grassle, J.F. and Maciolek, N.J.** 1992. Deep-sea species richness: Regional and local diversity estimates from quantitative bottom samples. *American Naturalist* 139: 313–341.
- Grassle, J.F. and Sanders, H.L.** 1973. Life histories and the role of disturbance. *Deep-Sea Research* 20: 643–659.
- Graveland, J., van der Wal, R., van Balen, J.H. and van Noordwijk, A.J.** 1994. Poor reproduction in forest passerines from decline of snail abundance on acidified soils. *Nature* 368: 446–448.
- Grigg, D.B.** 1974. *The Agricultural Systems of the World: An evolutionary approach*. Cambridge University Press, Cambridge.
- Grove, R.H.** 1992. Origins of western environmentalism. *Scientific American*, July: 22–27.
- Grzimek, B.** 1990. *Grzimek's Encyclopædia of Mammals*. Vol. 5. McGraw-Hill, New York.
- Gunderson, L., Holling, C.S. and Light, S.** 1995. *Bridges and Barriers to the Renewal of Ecosystems and Institutions*. Columbia University Press, New York (in press).
- Haas, P.M., Keohane, R.O. and Levy, M.A.** (eds) 1993. *Institutions for the Earth: Sources of effective international environmental protection*. The MIT Press, Cambridge, Mass.
- Hails, C.J.** 1992. Improving the quality of life in Singapore by creating and conserving wildlife habitats. In: Huat, C.B. and Edwards, N. (eds), *Public Space: Design, use and management*. 138–158. Singapore University Press, Singapore.
- Hallpike, C.R.** 1977. *Bloodshed and Vengeance in the Papuan Mountains: The generation of conflict in tauade*. Clarendon Press, Oxford.
- Hamilton, L.S.** 1993. *Ethics, Religion and Biodiversity*. The Whitehorse Press, Cambridge.
- Hammer, M., Jansson, A. and Jansson, B.O.** 1993. Diversity change and sustainability: implications for fisheries. *Ambio* 22: 97–106.
- Hammerton, D.** 1972. The Nile river – A case history. In: Oglesby, R.T., Carlson, C.A. and McCann, J.A. (eds), *River Ecology and Man*. 171–214. Academic Press, New York.
- Hamre, J.** 1994. Biodiversity and exploitation of the main fish stocks in the Norwegian–Barents Sea ecosystem. *Biodiversity and Conservation* 3: 473–492.
- Hannah, L., Lohse, D., Hutchinson, C., Carr, J.L. and Lankerani, A.** 1994. A preliminary inventory of human disturbance of world ecosystems. *Ambio* 23: 246–250.
- Hanson, J.S., Malanson, G.P. and Armstrong, M.P.** 1990. Landscape fragmentation and dispersal in a model of riparian forest dynamics. *Ecological Modelling* 49: 277–296.
- Happold, D.C.D.** 1995. The interactions between humans and mammals in Africa in relation to conservation: a review. *Biodiversity and Conservation* 4: 395–414.
- Hardin, G.** 1968. The tragedy of the commons. *Science* 162: 1243–1248.
- Harner, M.** 1977. The ecological basis for Aztec sacrifice. *American Ethnologist* 4: 117–135.
- Harris, L.D.** 1984. *The Fragmented Forest*. University of Chicago Press, Chicago.
- Haug, T., Kroyer, A.B., Nilssen, K.T., Ugland, K.I. and Aspholm, P.E.** 1991. Harp seal (*Phoca groenlandica*) invasions in Norwegian coastal waters: age composition and feeding habits. *ICES Journal of Marine Sciences* 48: 363–371.
- Hausfarter, G., and Hardy, S.B.** (eds), 1984. *Infanticide: Comparative and evolutionary perspectives*. Aldine, New York.
- Hawksworth, D.L.** 1990. The long-term effects of air pollution on lichen communities in Europe and North America. In: Woodwell, G.M. (ed.), *The Earth in Transition*. 45–64. Cambridge University Press, Cambridge.
- Head, G., May, R.M. and Pendleton, L.** 1987. Environmental determination of sex in the reptiles. *Nature* 237: 198–199.
- Hecht, S.** 1990. *Tropical Deforestation in Latin America: Myths, dilemmas and reality*. Paper presented at the System-wide Workshop on Environment and Development Issues in Latin America, University of California, Berkeley.
- Hecht, S. and Cockburn, A.** 1989. *The Fate of the Forest: Developers, destroyers, and defenders of the Amazon*. Verso, London.
- Heggberget, T.G., Johnsen, B.O., Hindar, K., Jonsson, B., Hansen, L.P., Hvidsten, N.A. and Jensen, A.J.** 1993. Interactions between wild and cultured Atlantic salmon: a review of the Norwegian experience. *Fisheries Research* 18: 123–146.
- Heiser, C.B.** 1973. *Seed to Civilization: The story of Man's food*. W.H. Freeman, San Francisco.
- Helle, E., Olson, M. and Jensen, S.** 1976. PCB levels correlated

- with pathological changes in seal uteri. *Ambio* **5**: 261–263.
- Henny, C.J., Blus, L.J., Gregory, S.V. and Stafford, C.J.** 1980. PCBs and organochlorine pesticides in wild mink and river otters from Oregon. *World Wide Fur Bearer Conference Proceedings*.
- Henriksen, A., Kämäri, J., Posch, M., and Wilander, A.** 1992. Critical loads of acidity: Nordic surface waters. *Ambio* **21**: 356–363.
- Henry, C.** 1990. Efficacité économique et impératifs éthiques: l'environnement en copropriété. *Revue Economique* **41**.
- Herskovits, M.J.** 1972. *Cultural Relativism: Perspectives in cultural pluralism*. Random House, New York.
- Hewitt de Alcantara, C.** 1991. La economía política del maíz en México. *Comercio Exterior* **41**: 955–970.
- Heywood, V.H.** 1987. The changing role of the botanic garden. In: Bramwell, D., Hamann, O., Heywood, V.H. and Syngé, H. (eds), *Botanic Gardens and the World Convention strategy*. 3–18. Academic Press, London.
- Heywood, V.** 1989. Patterns, extents and modes of invasions by terrestrial plants. In: Drake, J.A., Mooney, H.A., di Castri, F., Groves, R.H., Kruger, F.J., Rejmánek, M. and Williamson, M. (eds), *Biological Invasions: A global perspective*. 31–51. SCOPE 37. John Wiley, New York.
- Heywood, V.H. and Stuart, S.N.** 1992. Species extinctions in tropical forests. In: Whitmore, T.C. and Sayer, J.A. (eds), *Tropical deforestation and Species Extinction*. 91–118. Chapman and Hall, London.
- Hibon, A., Triomphe, B., Lopez-Pereira, M.A. and Saad, L.** 1992. *Rainfed Production in Mexico: Trends, constraints, and technological and institutional challenges for researchers*. CIMMYT Economics Working Paper 92-30. Mexico, D.F.
- Hickerson, H.** 1965. The Virginia deer and intertribal buffer-zones in the upper Mississippi valley. In: Leeds, A. and Vayda, P. (eds), *Man, Culture and Animals*. 43–65. American Association for the Advancement of Science, Washington, DC.
- Hildrew, A.G., Townsend, C.R., Francis, J. and Finch, K.** 1984. Cellulolytic decomposition in streams of contrasting pH and its relationship with invertebrate community structure. *Freshwater Biology* **14**: 323–328.
- Hindar, K., Ryman, N. and Utter, F.** 1991. Genetic effects of cultured fish on natural fish populations. *Canadian Journal of Fisheries and Aquatic Science* **48**: 945–957.
- Hobbs, R. and Saunders, D.** 1991. *Nature Conservation 2: The Role of Corridors*. Surrey Beatty and Sons, Chipping Norton, NSW.
- Hoffman, C.A.** 1990. Ecological risks of genetic engineering of crop plants. *BioScience* **40**: 434–437.
- Hohl, A. and Tisdell, C.A.** 1993. How useful are environmental safety standards in economics? The example of safe minimum standards for protection of species. *Biodiversity and Conservation* **2**: 168–181.
- Holcik, J.** 1991. Fish introductions in Europe with particular reference to its Central and Eastern part. *Canadian Journal of Fisheries and Aquatic Science* **48** (Suppl. 1): 13–23.
- Holdgate, M.W.** 1986. Summary and conclusions: characteristics and consequences of biological invasions. *Philosophical Transactions of the Royal Society of London, B* **314**: 733–742.
- Holdgate, M.W.** 1991. The environment of tomorrow. *Environment* **33**: 14–40.
- Holdren, J.P.** 1986. Energy and the human predicament. In: Smith, K.R., Fesharaki, F. and Holdren, J.P. (eds), *Earth and the Human Future: Essays in honor of Harrison Brown*. 124–160. Westview Press, Boulder, Colorado.
- Holling, C.S.** 1986. Resilience of ecosystems: local surprise and global change. In: Clark, W.C. and Munn, R.E. (eds), *Sustainable Development of the Biosphere*. 292–317. Cambridge University Press, Cambridge.
- Holling, C.S.** 1994. Investing in research for sustainability. *Environmental Applications* **3**: 552–555.
- Holmes, J.H.** 1976. Extensive grazing in Australia's dry interior. In: Holmes, J.J. (ed.), *Man and the Environment: Regional perspectives*. 24–48. Longman Cheshire Ltd, Melbourne.
- Hough, W.** 1926. *Fire as an Agent in Human Culture*. United States National Museum Bulletin **139**: 1–270.
- Houghton, J.T., Jenkins, G.J. and Ephraums, J.J.** (eds) 1990. *Climate Change: The IPCC Scientific Assessment*. Cambridge University Press, Cambridge.
- Houghton, R.A.** 1994. The worldwide extent of land-use change. *BioScience* **44**: 305–313.
- Howarth, R.B.** 1990. Economic Theory, Natural Resources, and Intergenerational Equity. PhD thesis, Energy and Resources Program, University of California, Berkeley.
- Hoyt, E.** 1992. *Conserving the Wild Relatives of Crops*, 2nd edn. IBPGR, IUCN and WWF.
- Hudson, W.E.** (ed.) 1991. *Landscape Linkages and Biodiversity*. Island Press, Washington, DC.
- Hufschmidt, M.M., James, D.E., Meister, A.D., Bower, B.T. and Dixon, J.A.** 1983. *Environment, Natural Systems, and Development: An economic valuation guide*. Johns Hopkins University Press, Baltimore, Md.
- Humphries, S.E., Groves, R.H. and Mitchell, D.S.** 1994. Plant invasions: Homogenizing Australian Ecosystems. In: Moritz, C. and Kikkawa, J. (eds), *Conservation Biology in Australia and Oceania*. Surrey Beatty and Sons, Chipping Norton, NSW.
- Hutchinson, T.C., and Meema, K.M.** (eds), 1987. *Effects of Atmospheric Pollutants on Forests, Wetlands and Agricultural Ecosystems*. Ecological Sciences Vol. 16, Springer-Verlag, Berlin.
- Huxley, A.** 1984. *Green Inheritance*. Collins, Harvill.
- Hynes, H.B.N.** 1960. *The Biology of Polluted Waters*. Liverpool University Press, Liverpool.
- Hynes, H.B.N.** 1970. *The Ecology of Running Waters*. University of Toronto Press, Toronto.
- IDA (International Development Association).** 1992. *The Environment in IDA's Operations*. IDA 10 Technical Note 4: April.
- Ignatieva, M.E.** 1994. Investigation of the flora of St Petersburg's green areas. In: Barker, G.M., Luniak, M., Trojan, P. and Zimny, H. (eds), *Proceedings of the Second European Meeting of the International Network for Urban Ecology*. 139–142. *Memorabilia Zoologica* 49, Warsaw.
- India International Centre Quarterly.** 1992. *Indigenous Vision: Peoples of India attitudes to the environment*. IIC, New Delhi.
- International Commission on Large Dams.** 1988. *World Register of Dams* (1988 updating). International Commission on Large Dams, Paris.
- International Monetary Fund (IMF).** 1994. *World Economic Outlook*. IMF, May 1994, Washington, DC.

- Irvine, D.** 1989. Succession management and resource distribution in an Amazonian rain forest. *Advanced Economic Botany* **7**: 223–237.
- IUCN.** 1993. *1994 IUCN Red List of Threatened Animals*. IUCN, Gland.
- IUCN.** 1994. *Report of the Global Biodiversity Forum*. IUCN, Gland.
- IUCN and UNEP.** 1980. *World Conservation Strategy*. IUCN, Gland.
- IUCN/UNEP/WWF.** 1980. *World Conservation Strategy: Living Resource Conservation for Sustainable Development*. IUCN, UNEP and WWF.
- IUCN/UNEP/WWF.** 1991. *Caring for the Earth*. IUCN, Gland.
- Jackson, P. and Kemf, E.** 1994. *Wanted Alive: Tigers in the wild*. 1994 WWF Species Status Report, World Wide Fund for Nature, Gland.
- Jakobsson, J.** 1992. *ICES Marine Science Symposium* **195**: 291–315.
- Janzen, D.H.** 1987. Insect diversity of a Costa Rican dry forest: why keep it, and how? *Biological Journal of the Linnean Society* **30**: 343–356.
- Janzen, D.H.** 1988. Tropical dry forests: the most endangered major tropical ecosystem. In: Wilson, E.O. and Peter, F.M. (eds), *Biodiversity*. 130–137. National Academy Press, Washington, DC.
- Janzen, D.H., and Martin, P.S.** 1982. Neotropical anachronisms: the fruits the gomphotheres ate. *Science* **215**: 19–27.
- Järvinen, O., Kuusela, K. and Väisänen, R.** 1977. Effects of modern forestry on the number of breeding birds in Finland in 1945–1975. *Silvia Fennica* **11**: 284–294.
- Jarvis, P.H.** 1979. The ecology of plant and animal introductions. *Progress in Physical Geography* **3**: 187–214.
- Jenkins, M. and Oldfield, S.** 1992. *Wild Plants in Trade*. Traffic International, Cambridge, UK.
- Johannes, R.E.** 1978. Traditional Marine Conservation Methods in Oceania and their Demise. *Annual Review of Ecology and Systematics* **9**: 349–364.
- Johannes, R.E.** 1981. *Words of the Lagoon: Fishing and marine lore in the Palau District of Micronesia*. University of California Press, Berkeley.
- Johns, A.D.** 1985. Selective logging and wildlife conservation in tropical rain-forest: problems and recommendations. *Biological Conservation* **31**: 355–375.
- Johns, A.D.** 1992. Species conservation in managed tropical forests. In: Whitmore, T.C. and Sayer, J.A. (eds), *Tropical Deforestation and Species Extinction*. 15–54. Chapman and Hall, London.
- Johnsen, B.O. and Jensen, A.J.** 1986. Infestation of Atlantic salmon, *Salmo salar*, by *Gyrodactylus salaris* in Norwegian rivers. *Journal of Fish Biology* **29**: 233–241.
- Jolly, C.L. and Torrey, B.B.** (eds) 1993. *Population and Land Use in Developing Countries*. National Academy Press, Washington, DC.
- Jonsson, B., and Fleming, I.A.** 1993. Enhancement of wild salmon populations. In: Sundnes, G. (ed.), *Human Impact on Self-Recruiting Populations*. 209–238. The Royal Norwegian Society of Sciences and Letters Foundation, Tapir Publishers, Trondheim.
- Jonsson, B., Andersen, R., Hansen, L.P., Fleming, I.A. and Bjorge, A.** 1993. Sustainable Development and Biodiversity. *NINA Utredning* **48**: 1–22.
- Jorgensen, T.** 1992. Long-term changes in growth of North-east Arctic cod *Gadus morhua* and some environmental changes. *ICES Journal of Marine Sciences* **49**: 263–277.
- Joshi, N.V. and Gadgil, M.** 1991. On the role of refugia in promoting prudent use of biological resources. *Theoretical Population Biology* **40**: 211–229.
- Kalpavriksh, 1991.** *The Delhi Ridge Forest: Decline and Conservation*.
- Kangle, R.P.** 1969. *Arthasasthra*. University of Bombay, Bombay.
- Kaplan, R.D.** 1994. The coming anarchy. *The Atlantic Monthly*, 44–76.
- Kappelle, M., Kennis, P.A.F., and De Vries, R.A.J.** 1995. Changes in diversity along a successional gradient in a Costa Rican upper montane *Quercus* forest. *Biodiversity and Conservation* **4**: 10–34.
- Karr, J.R.** 1991. Biological integrity: a long-neglected aspect of water resource management. *Ecological Applications* **1**: 66–84.
- Kates, R.W., Turner, B.L. and Clark, W.C.** 1990. The great transformation. In: Turner, B.L., II, Clark, W.C., Kates, R.W., Richards, J.F., Mathews, J.T. and Meyer, W.B. (eds), *The Earth as Transformed by Human Action*. 1–17. Cambridge University Press, New York.
- Keiser, R.L.** 1986. *Friend by Day, Enemy by Night: Organized vengeance in a Kohistani Community*. Holt, Rinehart and Winston, Fort Worth, Texas.
- Kelly, K.** 1994. *Out of Control: The rise of neo-biological civilization*. Addison Wesley, Reading, Mass.
- Kempf, E.** 1993. *The Law of the Mother: Protecting indigenous peoples in protected areas*. World Wide Fund for Nature, Gland, Switzerland and Sierra Club Books, San Francisco.
- Kendall, H.W. and Pimental, D.** 1994. Constraint of the expansion of the global food supply. *Ambio* **23**: 198–205.
- Khan, A.U.** 1994. History of decline and present status of natural tropical thorn forest in Punjab. *Biological Conservation* **67**: 201–210.
- Kimmins, H.** 1992. *Balancing Acts: Environmental issues in forestry*. University of British Columbia Press, Vancouver.
- Kock, K.-H.** 1994. Fishing and conservation in southern waters. *Polar Record* **30**: 3–22.
- Köhler-Rollefson, I.** 1993. Traditional pastoralists as guardians of biological diversity. *Indigenous Knowledge and Development Monitor* **1**: 14–16.
- Koppes, C.R.** 1988. Efficiency, equity, aesthetics: shifting themes in American conservation. In: Worster, D. (ed.), *The Ends of the Earth*. 230–251. Cambridge University Press, Cambridge.
- Koslow, J.A., Hanley, F. and Wicklund, R.** 1988. Effects of fishing on reef fish communities at Pedro Bank and Port Royal Cays, Jamaica. *Marine Ecology – Progress Series* **43**: 201–212.
- Kothari, A.** 1994a. *Agricultural Biodiversity: Luxury or necessity?* Seminar 418, June.
- Kothari, A.** 1994b. Environment and the New Economic Policies. In *Alternative Economic Survey 1993–1994*. Public Interest Research Group, New Delhi.
- Kothari, A.** 1995. Environment. In *Alternative Economic Survey 1994–1995*. Wiley Eastern Ltd, New Delhi.

- Kotlyakov, V.M.** 1991. The Aral Sea Basin: a critical environmental zone. *Environment* **33**: 4–9, 36–38.
- Kouki, J.** (ed.) 1994. Biodiversity in the Fennoscandian boreal forests: natural variation and its management. *Annales Zoologici Fennici* **31**: 3–4.
- Kull, K.** and Zobel, M. 1991. High species richness in an Estonian wooded meadow. *Journal of Vegetation Science* **2**: 711–714.
- Kummer, D.M.** and Turner, B.L., II, 1994. The human causes of deforestation in Southeast Asia. *BioScience* **44**: 323–328.
- Kuran, T.** 1988. The tenacious past: Theories of personal and collective conservation. *Journal of Economic Behaviour and Organization* **10**: 143–171.
- La Marche, V.C., Jr.**, Graybill, D.C., Fritts, H.C. and Rose, M.R. 1984. Increasing atmospheric carbon dioxide: tree ring evidence for growth enhancement in natural vegetation. *Science* **225**: 1019–1021.
- Lamprey, H.** 1975. The integrated project on arid lands. *Nature and Resources* **14**: 2–11.
- Lattimore, O.** 1951. *Studies in Frontier History: Collected Papers, 1928–1958*.
- Laughlin, C.D., Jr.** and Brady, I.A. (eds, 1978). *Extinction and Survival in Human Populations*. Columbia University Press, New York.
- Law, R.** and Grey, D.R. 1989. Evolution of yields from populations with age-specific cropping. *Evolutionary Ecology* **3**: 343–359.
- Lawrence, D.C., Leighton, M.** and Peart, D.R. 1995. Availability and extraction of forest products in managed and primary forest around a Dayak village in West Kalimantan, Indonesia. *Conservation Biology* **9**: 76–88.
- Lawry, S.** 1991. *Tenure Policy Toward Common Property. Natural et la restitution des droits aux paysans: Quelques conditions pour inverser la dégradation écologique au Sahel*. International Institute for Environment and Development, London.
- Le, K.** 1994. Influence of livestock grazing on grasshopper (Orthoptera: Acrididae) diversity in the inner Mongolian steppes. *Chinese Biodiversity* **2**: 9–17.
- Lee, K.N.** 1993. Greed, scale mismatch, and learning. *Ecological Applications* **3**: 560–564.
- Lee, R.B.** and Devore, I. (eds) 1968. *Man the Hunter*. Aldine Publishing Co., New York.
- Leach, G.** 1987. *Household Energy in South India*. Elsevier Applied Science, Essex.
- Lean, G., Hinrichsen, D.** and Markham, A. 1990. *Atlas of the Environment*. Arrow Books Ltd., London.
- Le Duc, J.P.** 1990. *Illicit Trafficking in Animals and Plants: A Lucrative Form of Crime*. ICPR, May–June 1990.
- Leidy, R.A.,** and Fiedler, P.L. 1985. Human disturbance and patterns of fish species diversity in the San Francisco Bay Drainage, California. *Biological Conservation* **33**: 247–267.
- Lele, S.M.** 1991. Sustainable development: A critical review. *World Development* **19**: 607–621.
- Lenski, G.** and Lenski, J. 1978. *Human Societies: An Introduction to Macrosociology*. McGraw-Hill, New York.
- Levin, S.A.** 1989. Analysis of risk for invasions and control programmes. In: Drake, J.A., Mooney, H.A., di Castri, F., Groves, R.H., Kruger, F.J., Rejmánek, M. and Williamson, M. (eds), *Biological Invasions: A global perspective*. 425–432. SCOPE 37. John Wiley, New York.
- Levy, S.** and van Wijnbergen, S. 1991. Maize and the Mexico–United States Free Trade Agreement. Unpublished manuscript.
- Lidell, W.D.** and Ohlhorst, S.L. 1993. Ten years of disturbance and change on a Jamaican fringing reef. In: Richmond R.H. (ed.), *Proceedings of the Seventh International Coral Reefs Symposium*. 144–150. University of Guam Press, Mangilao, Guam.
- Likens, G.E.** 1989. Some aspects of air pollutant effects on terrestrial ecosystems, and prospects for the future. *Ambio* **18**: 172–178.
- Linares, O.F.** 1976. ‘Garden hunting’ in the American tropics. *Human Ecology* **4**: 331–349.
- Lindenbaum, S.** 1972. Sorcerers, ghosts and polluting women: an analysis of religious belief and population control. *Ethnology* **11**: 241–253.
- Loehle, C.** 1991. Managing and monitoring ecosystems in the face of heterogeneity. In: Kolasa J. and Pickett, S.T.A. (eds), *Ecological Heterogeneity*. Ecological Studies 86. 144–159. Springer-Verlag, New York.
- Lodge, D.M.** 1993. Species invasions and deletions: Community effects and responses to climate and habitat change. In: Kareiva, P.M., Kingsolver, J.G. and Huey, R.B. (eds), *Biotic Interactions and Global Change*. 367–387. Sinauer Associates, Sunderland, Mass.
- Loftus, R.** and Scherf, B. (eds), 1993. *World Watch List for Domestic Animal Diversity*. Food and Agriculture Organization of the United Nations, Rome.
- Loganathan, B.G.** and Kannan, K. 1994. Global organochlorine contamination trends: an overview. *Ambio* **23**: 187–191.
- London Environment and Economic Centre (LEEC).** 1992. *The International Tropical Timber Trade and Forest Conservation*. Prepared by the LEEC for the UK Tropical Forest Forum.
- Londo, G.** 1990. Conservation and management of semi-natural grasslands in Northwestern Europe. In: Bohn, U. and Neuhäusl, R. (eds), *Vegetation and Flora of Temperate Zones*. 69–77. Academic Publishing, The Hague.
- Loope, L.L.** and Mueller-Dombois, D. 1989. Characteristics of invaded islands, with special reference to Hawaii. In: Drake, J.A., Mooney, H.A., di Castri, F., Groves, R.H., Kruger, F.J., Rejmánek, M. and Williamson, M. (eds), *Biological Invasions: A global perspective*. 257–274. SCOPE 37. John Wiley, Chichester.
- Loope, L.L.,** Sanchez, P.G., Tarr, P.W., Loope, W.L. and Anderson, R.L. 1988. *Biological Conservation* **44**: 95–118.
- López-Martín, J.M.,** Louise-Olmo, J. and Imnano, S.P. 1994. Organochlorine residue levels in the European mink in northern Spain. *Ambio* **23**: 294–295.
- Loucks, O.L.** 1994. Sustainability in urban ecosystems: beyond an object of study. In: Platt, R.H., Rowntree, R.A. and Muick, P.C. (eds), *The Ecological City: Preserving and Restoring Urban Biodiversity*. 49–68. University of Massachusetts Press, Amherst.
- Louis, J.,** Matthews, M.S. and Guerrieri, M.L. 1993. *Resources of Near-Earth Space*. University of Arizona Press, Tucson.

- Lowe-McConnell, R.H.** 1993. Fish faunas of the African Great Lakes: origins, diversity, and vulnerability. *Conservation Biology* **7**: 634–643.
- Ludwig, D., Hilborn, R. and Walters, C.** 1993. Uncertainty, resource exploitation, and conservation: lessons from history. *Ecological Applications* **3**: 547–549.
- Lundin, G.C. and Linden, O.** 1993. Coastal ecosystems: Attempts to manage a threatened resource. *Ambio* **22**: 468–473.
- Luniak, M.** 1994. The development of bird communities in new housing estates in Warsaw. In: Barker, G.M., Luniak, M., Trojan, P. and Zimny, H. (eds), *Proceedings of the Second European Meeting of the International Network for Urban Ecology*, 257–268. *Memorabilia Zoologica* 49, Warsaw.
- Lutz, W., Prinz, C. and Langgassmer, J.** 1993. World populations projections and possible ecological feedbacks. *POPNET* **23**: 1–11.
- Mabbutt, J.A.** 1985. Desertification of the world's range lands. *Desertification Control Bulletin* **12**: 5–11.
- McCay, B.J. and Acheson, J.M.** (eds) 1987. *The Question of the Commons*. University of Arizona Press, Tucson.
- McCloskey, J.M. and Spalding, H.** 1989. A reconnaissance-level inventory of the amount of wilderness remaining in the world. *Ambio* **18**: 221–227.
- Macdonald, I.A.W.** 1992. Global change and alien invasions: implications for biodiversity and protected area management. In: Solbrig, O.T., van Emden, H.M. and van Oodt, P.G.W.J. (eds), *Biodiversity and Global Change*. Monograph 8. 198–207. International Union of Biological Sciences, Paris.
- Macdonald, I.A.W. and Frame, G.W.** 1988. The invasion of introduced species into nature reserves in tropical savannas and dry woodlands. *Biological Conservation* **44**: 67–94.
- Macdonald, I.A.W. and Jarmen, M.L.** (eds) 1984. *Invasive alien organisms in the terrestrial ecosystems of the fynbos biome, South Africa*. South African National Scientific Programmes Report No.85. CSIR Foundation for Research and Development Council for Scientific and Industrial Research, Pretoria.
- Macdonald, I.A.W., Loope, L.L., Usher, M.B. and Hamann, O.** 1989. Wildlife conservation and the invasion of nature reserves by introduced species: a global perspective. In: Drake, J.A., Mooney, H.A., di Castri, F., Groves, R.H., Kruger, F.J., Rejmánek, M. and Williamson, M. (eds), *Biological Invasions: A global perspective*. 215–255. SCOPE 37. John Wiley, Chichester.
- Macdonald, I. A.W. and Richardson, D.M.** 1986. Alien Species in terrestrial ecosystems of the fynbos biome. In: Macdonald, I.A.W., Kruger, F.J. and Ferrar, A.A. (eds), *The Ecology and Management of Biological Invasions in Southern Africa*. Proceedings of the National Synthesis Symposium on the ecology of biological invasions. Oxford University Press, Cape Town.
- McGovern, T.H., Bigelow, G., Amorasi, T. and Russell, D.** 1988. Northern islands, human error, and environmental degradation: A view of social and ecological change in the medieval North Atlantic. *Human Ecology* **16**: 227–270.
- Machlis, G.E. and Forester, D.J.** 1992. *The Relationship between Socio-economic Factors and Biodiversity Loss: First efforts at theoretical and quantitative models*. Presented at biodiversity and Managed Landscapes: Theory and Practise, Sacramento, Calif.
- Mack, R.N.** 1989. Temperate grasslands vulnerable to plant invasions: characteristics and consequences. In: Drake, J.A., Mooney, H.A., di Castri, F., Groves, R.H., Kruger, F.J., Rejmánek, M. and Williamson, M. (eds), *Biological Invasions: A global perspective*. 155–173. SCOPE 37. John Wiley, Chichester.
- MacKenzie, D.** 1986. Crayfish pesticide decimates Spanish birds. *New Scientist*, 16 October.
- MacKenzie, J.J., and El-Ashry, M.T.** 1989. *Air Pollution's Toll on Forests and Crops*. Yale University Press, New Haven, Conn.
- MacKinnon, J. and MacKinnon, K.** 1986a. *Review of Protected Areas system in the Indo-Malaysian Realm*. IUCN, Gland.
- MacKinnon, J. and MacKinnon, K.** 1986b. *Review of the Protected Areas System in the Afrotropical Realm*. IUCN, Gland.
- McMillen, W.** 1981. *Feeding Multitudes*. Interstate Printers and Publishers, Danville, Ill.
- McNeely, J.A.** 1988. *Economics and Biological Diversity: Developing and using economic incentives to conserve biological resources*. IUCN, Gland.
- McNeely, J.A.** 1993. Biodiversity, Conservation and development in Asia: protected areas can contribute to local communities. In: Xiapu, (ed.), *Proceedings of the First Conference on National Parks and Protected Areas of East Asia*, 47–63. Chinese Academy of Sciences, Beijing.
- McNeely, J.A.** 1994. Lessons from the Past: Forest and Biodiversity. *Biodiversity and Conservation* **3**: 3–20.
- McNeely, J.A., Harrison, J. and Dingwall, P.** 1994. *Protecting Nature: Regional Reviews of Protected Areas*. IUCN, Gland.
- McNeely, J.A., Miller, K.R., Reid, W.V., Mittermeier, R.A., and Werner, T.B.** 1990. *Conserving the World's Biological Diversity*. IUCN, Gland.
- McNeely, J. and Ness, G.** 1995. *People, Parks and Biodiversity: Issues in population–environment dynamics* (in press).
- McNeely, J.A. and Pitt, D.** (eds) 1985. *Culture and Conservation*. Croom Helm, London.
- MacNeill, J., Winsemius, P. and Yakushiji, T.** 1991. *Beyond Interdependence: The meshing of the world's economy and the Earth's ecology*. Trilateral Commission, Oxford University Press, Oxford.
- McPherson, E. G.** 1994. Cooling urban heat islands with sustainable landscapes. In: Platt, R.H., Rowntree, R.A. and Muick, P.C. (eds), *The Ecological City: Preserving and restoring urban biodiversity*. 151–171. University of Massachusetts Press, Amherst.
- Markham, A.** 1994. *A Brief History of Pollution*. Earthscan, London.
- Magnuson, J.J.** 1990. The invisible present. *BioScience* **40**: 495–501.
- Malanson, G.P.** 1993. *Riparian Landscapes*. Cambridge University Press, Cambridge.
- Malingreau, J.P. and Tucker, C.J.** 1988. Large-scale deforestation in the southeastern Amazon basin of Brazil. *Ambio* **17**: 49–55.
- Mangel, M.** 1993. Effects of high-seas driftnet fisheries on the northern right whale dolphin. *Lissodelphis borealis*. *Ecological Applications* **3**: 221–229.

- Mangelsdorf, P.C.** 1974. *Corn: Its origin, evolution and improvement*. Harvard University Press, Cambridge, Mass.
- Mann, K.H. and Lazier, J.R.N.** 1991. *Dynamics of Marine Ecosystems*. Blackwell Scientific Publications, Boston.
- Mannion, A.M.** 1991. *Global Environment Change*. Longman, New York.
- Mannion, A.M.** 1992. Acidification and eutrophication. In: Mannion, A.M. and Bowlby, S.R. (eds), *Environmental Issues in the 1990s*. 177–195. John Wiley, Chichester.
- Marquardt, K.** 1993. *Animal Scam*. Regnery Gateway, Washington, DC.
- Marshall, E.M.** 1959. *The Harmless People*. Knopf, New York.
- Martin, P.S. and Klein, R.G.** (eds), 1984. *Quaternary Extinctions: A prehistoric revolution*. University of Arizona Press, Tucson.
- Maser, C.** 1988. *The Redesigned Forest*. R. and E. Miles, San Pedro, Calif.
- Mason, C.F.** 1989. Water pollution and otter distribution: a review. *Lutra* 2: 97–131.
- Matthews, E.** 1983. Global vegetation and land use: new high resolution databases for climate studies. *Journal of Climatology and Applied Meteorology* 22: 474–487.
- Maybury-Lewis, D.** 1992. *Millennium: Tribal wisdom and the modern world*. Viking Press, New York.
- Meyer, W.B. and Turner, B.L., II.** 1992. Human population growth and global land-use/cover change. *Annual Review of Ecology and Systematics* 23: 39–61.
- Miller, B.D.** 1981. *The Endangered Sex: Neglect of female children in rural north India*. Cornell University Press, Ithaca, NY.
- Miller, R.R., Williams, J.D. and Williams, J.E.** 1989. Extinctions of North American fishes during the past century. *Fisheries* 14: 22–38.
- Mills, E., Wilson, D. and Johansson, T.** 1991. Beginning to reduce greenhouse gas emissions need not be expensive: examples from the energy sector. In: Jäger, J. and Ferguson, H.L. (eds), *Climate Change: Science, impacts and policy*. Proceedings of the Second World Climate Conference. 311–328. Cambridge University Press, Cambridge.
- Mills, J.A. and Jackson, P.** 1994. Killed for cure: a review of the worldwide trade in tiger bone. A Traffic Network Report. Traffic International, Cambridge.
- Mills, J.A. and Servheen, C.** 1991. *The Asian Trade in Bears and Bear Parts*. World Wildlife Fund, Washington, DC.
- Mitchell, D.** 1984. Predatory warfare, social status, and the North Pacific slave trade. *Ethnology* 23: 39–48.
- Montanez, C. and Warman, A.** 1985. *Los productores de maíz en Mexico: Restricciones y alternativas*. Centro de Ecodesarrollo, Mexico, D.F.
- Mooney, H.A., and Drake, J.A.** (eds), 1986. *Ecology and Biological Invasions of North America and Hawaii*. Springer-Verlag, Berlin.
- Mooney, H.A., Vitousek, P.M. and Matson, P.A.** 1987. Exchange of materials between terrestrial ecosystems and the atmosphere. *Science* 238: 926–932.
- Mooney, H.A., Fuentes, E.R. and Kronberg, B.I.** (eds), 1993. *Earth System Responses to Global Change: Contrasts between North and South America*. Academic Press, San Diego.
- Morton and Baynes.** 1985.
- Mott, J.J. and Tothill, J.C.** 1994. Degradation of savannah woodlands in Australia. In: Moritz C. and Kikkawa, J. (eds), *Conservation Biology in Australia and Oceania*. Surrey Beatty and Sons Ltd, Chipping Norton, NSW.
- Mowbray, D.L.** 1986. Pesticide Control in the South Pacific. *Ambio* 15 (1).
- Moyle, P.B.** 1976. Fish introductions in California: history and impact on native fishes. *Biological Conservation* 9: 101–118.
- Moyle, P.B. and Leidy, R.A.** 1992. Loss of biodiversity in aquatic ecosystems: Evidence from fish faunas. In: Fiedler, P.L. and Jane, S.K. (eds), *Conservation Biology: The theory and practice of nature conservation, preservation, and management*. 127–169. Chapman and Hall, New York.
- Muir, D.C.G., Wagemann, R., Hargrave, B.T., Thomas, D.J., Peakall, D.B. and Norstrom, R.J.** 1992. Arctic marine ecosystem contamination. *Science of the Total Environment* 122: 75–134.
- Mukhopadhyay, P. and D'Souza, R.** 1994. *Watery Dreams and Unfulfilled Promises: How beneficial are large-scale irrigation projects?* Kalpavriksh, New Delhi.
- Munro, J.L.** 1983. *Caribbean Coral Reef Fishery Resources*. ICLARM Studies and Reviews 7. ICLARM, Manila.
- Munro, J.L. and Smith, I.** 1984. Management strategies for multi-species complexes in artisanal fisheries. *Proceedings of the Gulf and Caribbean Fisheries Institute* 36: 127–141.
- Murawski, S.A.** 1993. Climate change and marine fish distributions: forecasting from historical analogy. *Transactions of the American Fisheries Society* 122: 647–658.
- Myers, K.** 1986. Introduced vertebrates in Australia, with emphasis on the mammals. In: Groves, R.H. and Burdon, J.J. (eds), *Ecology of Biological Invasions*. 120–136. Cambridge University Press, Cambridge.
- Myers, N.** 1979. *The Sinking Ark: A new look at the problem of disappearing species*. Pergamon Press, Oxford.
- Myers, N.** 1988. Threatened biotas: 'hotspots' in tropical forests. *The Environmentalist* 8: 187–207.
- Myers, N.** 1989. *Deforestation Rates in Tropical Forests and Their Climatic Implications*. A Friends of the Earth Report. FOE, London.
- Nabhan, G.P., Rea, A.M., Hardt, K.L., Mellink, E., and Hutchinson, C.F.** 1982. Papago influences on habitat and biotic diversity; Quitovac Oasis Ethno-Ecology. *Journal of Ethno Biology* 2: 124–143.
- Naiman, R.J.** (ed.) 1992. *Watershed Management*. Springer-Verlag, New York.
- NAS (National Academy of Sciences).** 1987. *Responding to Changes in Sea Levels: Engineering Implications*. Marine Board, National Research Council, National Academy Press, Washington, DC.
- Neel, J.V.** 1970. Lessons from a 'primitive' people. *Science* 170: 815–822.
- Neiring, W.A.** 1990. Human impacts on the south Florida wetlands: the Everglades and Big Cypress Swamp. In: Woodwell, G.M. (ed.), *The Earth in Transition*. 463–475. Cambridge University Press, Cambridge.
- Nelson, R.K.** 1989. Hunters and animals in a native land. *Orion*, Spring: 49–53.

- Nelson, K.**, and Soulé, M. 1987. Genetic conservation of exploited fishes. In: Ryman, N. and Utter, F. (eds), *Population Genetics and Fishery Management*. 345–368. Washington Sea Grant Program/University of Washington Press, Seattle and London.
- Nerem, R.S.** 1995. Global mean sea-level variations from TOPEX/POSEIDON altimeter data. *Science* **268**: 708–710.
- Neumann, R.P.** and Machlis, G.E. 1989. Land-use and threats to parks in the Neotropics. *Environmental Conservation*. **16**: 13–18.
- Nicholson-Lord, D.** 1987. *The Greening of the Cities*. Routledge and Kegan Paul, London.
- Nickerson, N.H.**, Dobbertein, R.A. and Jarman, N.M. 1989. Effects of power-line construction on wetland vegetation in Massachusetts, USA. *Environmental Management* **13**: 477–483.
- Nitecki, M.H.** (ed.) 1984. *Extinctions*. University of Chicago Press, Chicago.
- Norgaard, R.B.** 1990a. Three dilemmas of environmental accounting. *Ecological Economics* **1**: 303–314.
- Norgaard, R.B.** 1992. *Sustainability and the Economics of Assuring Assets for Future Generations*. Policy Research Working Paper 832. The World Bank, Washington, DC.
- Norse, E.A.** (ed.) 1993. *Global Marine Biological Diversity. A strategy for building conservation into decision making*. Island Press, California.
- North, S.G.**, Bullock, D.J. and Dulloo, M.E. 1994. Changes in the vegetation and reptile populations on Round Island, Mauritius, following eradication of rabbits. *Biological Conservation* **67**: 21–28.
- Northridge, S.P.** 1991. *Driftnet Fisheries and their Impacts on Non-Target Species: A world-wide review*. Report to Marine Resources Assessment Group, London.
- Noss, R.F.** 1991. Landscape connectivity: different functions at different scales. In: Hudson, W.E. (ed.), *Landscape Linkages and Biodiversity*. Island Press, Washington, DC.
- Noss, R.F.** 1993. Wildlife Corridors. In: Smith, D.S. and Hellmund, P.C. (eds), *Ecology of Greenways*. 43–68. University of Minnesota Press, Minneapolis.
- Nvorteva, P.** 1971. The synantrophy of birds as an expression of the ecological cycle disorder caused by urbanization. *Annales Zoologici Fennici* **8**: 547–553.
- Odgaard, B.V.** 1994. The Holocene vegetation history of northern West Jutland, Denmark. *Opera Botanica* **123**: 1–171.
- OECD.** 1985. *The State of the Environment, 1985*. Organisation for Economic Cooperation and Development, Paris.
- Office of Technology Assessment.** 1987. *Technologies to Maintain Biological Diversity*. Office of Technology Assessment, Washington, DC.
- Ojima, D.S.**, Galvin, K.A. and Turner, B.L., II, 1994. The Global impact of land-use change. *BioScience* **44**: 300–304.
- Oldfield, S.** 1988. *Buffer Zone Management in Tropical Moist Forests: Case studies and guidelines*. IUCN, Gland.
- Oliver, W.L.R.** (ed.) 1993. *Pigs, peccaries and hippos. Status survey and conservation action plan*. IUCN, Gland.
- Olson, S.L.** 1989. Extinction on islands: man as a catastrophe. In: Western, D. and Pearl, M. (eds), *Conservation for the Twenty-First Century*, 50–53. Oxford University Press, New York.
- Olsson, E.G.A.**, Reinhammar, L.G. and Sørmland, E. 1995. Biogeographical pattern and conservation biology of an endangered grassland plant species, *Pseudorchis albida* (L.) A. and D. Løve (*Orchidaceae*) (in press).
- O'Neal, M.J.** 1993. *The Roar of the Crowd: How television and people power are changing the world*. Times Books, New York.
- Oostermeijer, J.G.B.**, Van't Veer, R. and den Nijs, J.C.M.. 1994. Population structure of the rare, long-lived perennial *Gentiana pneumonanthe* in relation to vegetation and management in the Netherlands. *Journal of Applied Ecology* **31**: 428–438.
- Opole, M.** 1993. Revalidating women's knowledge on indigenous vegetables: implications for policy. In: de Boef, W., Amanor, K. and Wellard, K. (eds), *Cultivating Knowledge*. Intermediate Technology Publications, Amsterdam.
- Orians, G.H.**, Brown, G.M., Kunin, W.E. and Swierzbinski, J.E. (eds), 1990. *The Preservation and Valuation of Biological Diversity*. University of Washington Press, Seattle.
- Osman, S.M.** 1991. Wings of Destiny. *WWF-India Quarterly* **76**. January–March.
- Ostrom, E.** 1990. *Governing the Commons: The evolution of institutions for collective action*. Cambridge University Press, Cambridge.
- Otto, J.** and Elbow, K. 1993. *Into the Woods: Natural forests management experiences in Niger*. Paper prepared for Liz Claiborn-Art Ortenburg Foudation Workshop on Community-Based Conservation, Airlie, Va.
- Owen-Smith, N.** 1987. Pleistocene extinctions: the pivotal role of megaherbivores. *Paleobiology* **13**: 351–362.
- Padoch, C.** 1993. Fruits of diversity. *Pacific Discovery* **46**: 30–35.
- Pain, S.** 1988a. How the heat trap will wreak ecological havoc. *New Scientist*, October: 22.
- Pain, S.** 1988b. No escape from the global greenhouse. *New Scientist*, November: 38–43.
- Painter, M.** 1988. Co-management with whom? Conservation and development in Latin America. Paper presented to the symposium, *Culture: The Missing Component in Conservation and Development*. April 8–9 1988. Washington, DC.
- Parry, M.** and Jiachen, Z. 1991. The potential effects of climate changes on agriculture In: Jäger, J. and Ferguson, H.L. (eds), *Climate Change: Science, impacts and policy. Proceedings of the Second World Climate Conference*. 279–309. Cambridge University Press, Cambridge.
- Pastor, J.** and Post, W.M. 1988. Response of northern forest to CO₂-induced climate change. *Nature* **334**: 55–58.
- Pauly, D.**, Silvestre, G. and Smith, I.R. 1989. On development, fisheries and dynamite: a brief review of tropical fisheries management. *Natural Resource Modelling* **3**: 307–329.
- Peakall, D.B.** 1975. PCBs and their environmental effects. *CRC Critical Reviews in Environmental Control* **5**: 469–508.
- Pearce, D.**, Barbier, E. and Markandya, A. 1990. *Sustainable Development: Economics and environment in the Third World*. Edward Elgar Ltd., London.
- Pearce, D.**, Markandya, A. and Barbier, E. 1989. *Blueprint For a Green Economy*. Earthscan, London.
- Pearce, D.** and Moran, D. 1994. *The Economic Value of Biodiversity*. Earthscan and IUCN, London.
- Pierce, F.** 1992. *The Damned*. The Bodley Head, London.

- Pearl, M.** 1989. How the developed world can promote conservation in emerging nations. In: Western, D. and Pearl, M. (eds), *Conservation for the Twenty-first Century*. 274–283. Oxford University Press, New York.
- Peluso, N.L.** 1992. *Rich Forest, Poor People: Resource Control and Resistance in Java*. University of California Press, Calif.
- Pereira, H.C.** 1973. *Land Use and Water Resources in Temperate and Tropical Climates*. Cambridge University Press, Cambridge.
- Peters, R.L.** 1992. Introduction. In: Peters, R.L. and Lovejoy, T.E. (eds), *Global Warming and Biological Diversity*. 3–14. Yale University Press, New Haven, Conn.
- Peters, R.L. and Lovejoy, T.E.** 1992. *Global Warming and Biological Diversity*. Yale University Press, New Haven, Conn.
- Peterson, B.J., Hobbie, J.E., Hershey, A.E., Lock, M.A., Ford, T.E., Vestal, J.R., McKinley, V.L., Hullar, M.A.J., Miller, M.C., Ventullo, R.M. and Volk, G.S.** 1985. Transformation of a tundra river from heterotrophy to autotrophy by addition of phosphorus. *Science* **229**: 1383–1386.
- Petts, G.E.** 1994. *Impounded Rivers: Perspectives for ecological Management*. John Wiley, Chichester.
- Pickett, S.T.A., Parker, V.T. and Fiedler, P.L.** 1992. The new paradigm in ecology: implications for conservation biology above the species level. In: Fiedler, P.L. and Jain, S.K. (eds), *Conservation Biology*. 65–88. Chapman and Hall, New York.
- Pimentel, D., Hunter, M., LaGro, J. et al.** 1989. Benefits and risks of genetic engineering in agriculture. *BioScience* **39**: 606–610.
- Pimm, S.L., and Gilpin, M.E.** 1989. Theoretical issues in conservation biology. In: Roughgarden, J., May, R.M. and Levin, S.A. (eds), *Perspectives in Ecological Theory*. 287–305. Princeton University Press, Princeton, NJ.
- Pinedo-Vásquez, M. and Padoch, C.** 1993. Community and governmental experiences in protecting biodiversity in the lowland Peruvian Amazon. In: Potter, C.S. et al. (eds), *Perspectives on Biodiversity: Case studies of genetic resource conservation and development*. AAAS, Washington, DC.
- Pinedo-Vásquez, M., Zarin, D., Jipp, P. and Chota-Inuma, J.** 1990. Use-values of tree species in a communal forest reserve in Northeast Peru. *Conservation Biology* **4**: 405–417.
- PIRG.** 1994. *Alternative Economic Survey 1993–94*. Public Interest Research Group, New Delhi.
- Pitcher, T.J., and Hart, P.J.B.** 1982. *Fisheries Ecology*. Croom Helm, London.
- Place, F. and Hazell, P.** 1993. Productivity effects of indigenous land tenure systems in sub-Saharan Africa. *American Journal of Agricultural Economics* **75**: 10–19.
- Platt, R.H., Rowntree, R.A. and Muick, P.C.** 1994. *The Ecological City: Preserving and restoring urban biodiversity*. University of Massachusetts Press.
- Policansky, D.** 1993. *Lecture notes in Biomathematics* 99: 2–18. Springer-Verlag, Berlin.
- Phongsuwan, N. and Chansang, H.** 1993. Assessment of coral communities in the Andaman Sea (Thailand). In: Richmond R.H. (ed), *Proceedings of the Seventh International Coral Reefs Symposium*. 114–121. University of Guam Press, Mangilao, Guam.
- Poore, D. and Sayer, J.** 1991. *The Management of Tropical Moist Forest Lands – Ecological Guidelines*, 2nd edn. IUCN, Gland, Switzerland and Cambridge, UK.
- Porter, W.P., Hindsdill, R., Fairbrother, A., Olson, L.J., Jaeger, J., Yuill, T., Bisgaard, S., Hunter, W.G. and Nolan, K.** 1984. Toxicant–disease–environment interactions associated with suppression of immune system, growth, and reproduction. *Science* **224**: 1014–1017.
- Posey, D.A.** 1982. The keepers of the forest. *Garden* **6**: 18–24.
- Posey, D.A.** 1985. Indigenous management of tropical forest ecosystems: The case of the Kayapo Indians of the Brazilian Amazon. *Agrofor. Syst.* **3**: 139–158.
- Posey, D.A.** 1990. The science of the Mebengokre. *Orion*, Summer: 16–23.
- Postel, S.** 1994. Carrying capacity: Earth's bottom line. In: Brown, L.R. et al. (eds), *State of the World 1994*, 3–21. W.W. Norton and Co., New York.
- Precoda, N.** 1991. Requiem for the Aral Sea. *Ambio* **20**: 109–114.
- Price, C.** 1989. *The Theory and Application of Forest Economics*. Basil Blackwell, Oxford.
- Primack, R.B. and Hall, P.** 1992. Biodiversity and forest change in Malaysian Borneo. *BioScience* **42**: 829–837.
- Prins, C.** 1984. How much biomass is available for energy in Europe? In: Hasnain, S. (ed.), *Fifth Canadian Bioenergy R and D Seminar*. 11–22. Elsevier Science Publishers, London.
- Pyne, S.** 1982. *Fire in America. A cultural history of wildland and rural fire*. Princeton University Press, Princeton, NJ.
- Quinn, J.F. and Karr, J.R.** 1993. Habitat fragmentation and global change. In: Kareiva, P.M., Kingsolver, J.G. and Huey, R.B. (eds), *Biotic Interactions and Global Change*. 451–463. Sinauer Associates, Sunderland, Mass.
- Quinn, M.A., Patricia, S. and Charles, H.** 1993. Effects of grasshopper density and plant composition on growth and destruction of grasses. *Environmental Entomology* **22**: 993–1002.
- Rahmani, A.** 1989. The Greater Adjutant Stork. *Newsletter for Birdwatchers* **29** (3–4).
- Ramakrishnan, P.S.** 1992. *Shifting Agriculture and Sustainable Development: An Interdisciplinary Study from North-Eastern India*. UNESCO, Paris and Parthenon, Carnforth, UK.
- Ramakrishnan, P.S. and Vithousek, P.M.** 1989. Ecosystem-level processes and the consequences of biological invasions. In: Drake, J.A., Mooney, H.A., di Castri, F., Groves, R.H., Kruger, F.J., Rejmánek, M. and Williamson, M. (eds), *Biological Invasions: A global perspective*. 281–296. SCOPE 37. John Wiley, New York.
- Rambo, A.T.** 1985. Primitive polluters: Semang impact on the Malaysian tropical rain forest ecosystem. *Anthropological Papers*, 76. Museum of Anthropology, University of Michigan, Ann Arbor.
- Ranganathan, V., Rao, S.S. and Prabhu, G.S.** 1993. *Demand and Supply of Fuelwood in Karnataka*. Indian Institute of Management, Bangalore.
- Rao, I.M., Zeigler, R.S., Vera, R. and Sarkarung, S.** 1993. Selection and breeding for acid-soil tolerance in crops. *BioScience* **43**: 454–465.
- Raphael, M.C. and White, M.** 1984. Use of snags by cavity-nesting birds in Sierra Nevada. *Wildlife Monographs* **86**: 1–66.
- Rapp, A.** 1977. Desertification. In: Gregory, K.J. and Walling, D.E. (eds), *Human Activity and Environmental Process*. 425–443. John Wiley, Chichester.

- Rappaport, R.A.** 1984. *Pigs for the Ancestors: Ritual in the ecology of a New Guinea people*. Yale University Press, New Haven, Conn.
- Rath, A.** and Herbert-Copley, B. 1993. *Green Technologies for Development: Transfer, trade and cooperation*. International Development Centre, Ottawa.
- Rawat, A.S.** (ed.) 1991. *History of Forestry in India*. Indus Publishing Company, New Delhi.
- Ray, G.C.** Hayden, B.P., Bulger, A.J. Jr, and McCormick-Ray, M.B. 1992. Effects of global warming on the biodiversity of coastal-marine zones. In: Peters, R.L. and Lovejoy, T.E. *Global Warming and Biological Diversity*, 91–104. Yale University Press, New Haven, Conn.
- Redclift, M.** 1987. *Sustainable Development: Exploring the contradictions*. Methuen, London.
- Redford, K.H.** 1990. The ecologically noble savage. *Orion*, Summer: 25–29.
- Redford, K.H.** 1992. The empty forest. *BioScience* **42**: 412–422.
- Redford, K.H.** and Robinson, J.G. 1987. The game of choice: patterns of Indian and colonist hunting in the Neotropics. *American Anthropologist* **89**: 650–667.
- Reed, C.A.** (ed.) 1977. *Origins of Agriculture*. Mouton, The Hague.
- Reed, D.** 1992. *Structural Adjustment and the Environment*. Earthscan, London.
- Regan, T.** 1983. *The Case for Animal Rights*. University of California Press, Berkeley.
- Reichel-Dolmatoff, G.** 1976. Cosmology as ecological analysis: a view from the rainforest. *Man* **11**: 307–318.
- Reid, W.V.** 1992. How many species will there be? In: Whitmore, T.C. and Sayer, J.A. (eds), *Tropical Deforestation and Species Extinction*. 55–74. Chapman and Hall, New York.
- Reid, W.V.** and Miller, K.R. 1989. *Keeping Options Alive: The scientific basis for conserving biodiversity*. World Resources Institute, Washington, DC.
- Reid, W.V.** and Trexler, M.C. 1991. *Drowning the National Heritage: Climate change and US coastal biodiversity*. World Resources Institute, Washington, DC.
- Reijnders, P.** 1986. Reproductive failure in common seals feeding on fish from polluted coastal waters. *Nature* **324**: 456–457.
- Reinhammar, L.-G.** 1995. Evidence for two distinct species of *Pseudorchis* (Orchidaceae) in Scandinavia. *Nordic Journal of Botany* (in press).
- Rejmánek, M.** 1989. Invasibility of plant communities. In: Drake, J.A., Mooney, H.A., di Castri, F., Groves, R.H., Kruger, F.J., Rejmánek, M. and Williamson, M. (eds), *Biological Invasions: A global perspective*. 369–383. SCOPE 37, John Wiley, New York.
- Renman, G.** and Mörtberg, U. 1994. Avifauna – relation to size, configuration and habitat conditions of green urban areas in Stockholm. In: Barker, G.M., Luniak, M., Trojan, P. and Zimny, H. (eds), Proceedings of the Second European Meeting of the International Network for Urban Ecology, 245–256. *Memorabilia Zoologica* 49, Warsaw.
- Repetto, R.** 1988. *The Forest for the Trees? Government Policies and the Misuse of Forest Resources*. World Resources Institute, Washington DC.
- Reutergårdh, L.** 1988. Identification and distribution of chlorinated organic pollutants in the environment. *National Swedish Environmental Protection Board Report* 3465: 1–2.
- Richards, R.P.,** Kramer, J.W., Baker, D.B. and Krieger, K.A. 1987. Pesticides in rainwater in the northeastern United States. *Nature* **327**: 129–131.
- Richards, J.F.** 1990. Land transformation. In: Turner, B.L. et al. (eds), *The Earth as Transformed by Human Action*. 163–178. Cambridge University Press, Cambridge.
- Ricker, W.E.** 1981. Changes in the average size and average age of Pacific salmon. *Canadian Journal of Fisheries and Aquatic Sciences* **38**: 1636–1656.
- Rijnsdorp, A.D.** 1991. Changes in fecundity of female North Sea plaice *Pleuronectes platessa* L. between three periods since 1900. *ICES Journal of Marine Sciences* **48**: 253–280.
- Rindos, D.** 1984. *The Origins of Agriculture: An evolutionary perspective*. Academic Press, New York.
- Risser, P.G.** (ed.) 1991. *Long-term ecological research*. SCOPE 47, John Wiley, New York.
- Roberts, L.** 1990. Zebra mussel invasion threatens US waters. *Science* **249**: 1370–1372.
- Robinson, J.G.** and Redford, K.H. 1991. *Neotropical Wildlife Use and Conservation*. University of Chicago Press, Chicago.
- Rolston, H.** 1993. God and endangered species. In: Hamilton, L.S. (ed.), *Ethics, Religion and Biodiversity*. 40–64. The Whitehorse Press, Cambridge.
- Roosevelt, A.** 1989. Resource management in Amazonia before the conquest: beyond ethnographic projection. *Advances in Economic Botany* **7**: 30–62.
- Rosseland, B.O.,** Staurnes, M. and Eldhuset, T.D. 1990. Environmental effects of aluminium. *Environmental Geochemistry and Health* **12**: 17–27.
- Rosseland, B.O.** and Staurnes, M. 1994. Physiological mechanisms for toxic effects and resistance: an ecophysiological and ecotoxicological approach. In: Steinberg, C.E.W. and Wright, R.W. (eds), *Acidification of Freshwater Ecosystems: Implications for the future*. 227–246. John Wiley, London.
- Rubenstein, D.H.** 1987. Cultural patterns and contagion: epidemic suicide among Micronesian youth. In: Robillard, A.B. and Marsella, A.J. (eds), *Contemporary Issues in Mental Health Research in the Pacific Islands*. Social Science Research Institute, Honolulu, Hawaii.
- Ruddle, K.E.** and Johannes, R.E. 1985. *The Traditional Knowledge and Management of Coastal Systems in Asia and the Pacific*. UNESCO Regional Office for Science and Technology for Southeast Asia, Jakarta, Indonesia.
- Ruddle, K.E.,** Hviding, and Johannes, R.E. 1992. Marine resource management in the context of customary tenure. *Marine Resource Economics* **7**: 249–273.
- Rudel, T.K.** 1989. Population, development, and tropical deforestation: a cross-national study. *Rural Sociology* **54**: 327–338.
- Ryan, J.C.** 1992. *Life Support: Conserving biological diversity*. Worldwatch Paper 109. Worldwatch Institute, Washington, DC.
- Ryman, N.,** and Ståhl, G. 1980. Genetic changes in hatchery stocks of brown trout (*Salmo trutta*) *Canadian Journal of Fisheries and Aquatic Science* **37**: 82–87.
- Ryman, N.** 1991. Conservation genetics considerations in fishery management. *Journal of Fisheries Biology* **39** (Supplement A): 211–224.

- Ryman, N., Utter, F. and Laikre, L.** 1994. Protection of aquatic biodiversity. In: Voigtlander, C.W. (ed.), *The State of the World's Fisheries Resources. Proceedings from the World Fisheries Congress, Plenary Session, Athens, Greece, 3-8 May, 1992.* 92-115. Oxford and IBH Publishing Co., New Delhi.
- Sadik, N.** 1992. *The State of World Population 1992.* United Nations Population Fund, New York.
- Salaman, R.N.** 1949. *The History and Social Influence of the Potato.* Cambridge University, Press, Cambridge.
- Salcedo, S., García, J.A. and Sarnaga, M.** 1993. Política agrícola y maíz en México: hacia el libre comercio norteamericano. *Comercio Exterior* **43**: 302-310.
- Saldirriaga, J.G., West, D.C., Tharp, M.L. and Uhl, C.** 1988. Long-term chrono-sequence of forest succession in the upper Rio Negro of Columbia and Venezuela. *Journal of Ecology* **76**: 938-958.
- Saunders, D.A., Hobbs, R.J. and Margules, C.R.** 1991. Biological consequences of ecosystem fragmentation: a review. *Biological Conservation* **5**: 18-32.
- Saulei, S.M.** 1984. Natural regeneration following clear-fell logging operations in the Gogol valley, Papua New Guinea. *Ambio* **13**: 351-354.
- Sawyer, J.** 1993. *Plantations in the Tropics: Environmental concerns.* IUCN, Gland.
- Sayer, J.A. and Wegge, P.** 1992. Biological conservation issues in forest management. In: Blockhus, J.A., Dillenbeck, M., Sayer, J.A. and Wegge, P. (eds), *Conserving Biological Diversity in Tropical Managed Forests.* 1-4. IUCN, Gland, Switzerland and Cambridge, UK.
- Sayer, J.A. and Whitmore, T.C.** 1991. Tropical moist forests: destruction and species extinction. *Biological Conservation* **55**: 199-214.
- Scheper-Hughes, N.** 1987. *Child Survival: Anthropological Perspectives on the Treatment and Mal-Treatment of Children.* D. Reidel, Dordrecht.
- Schiffman, P.M.** 1994. Promotion of exotic weed establishment by endangered Giant Kangaroo Rats (*Dipodomys ingens*) in a California grassland. *Biodiversity and Conservation* **3**: 524-537.
- Schindler, D.W.** 1988. Effects of acid rain on freshwater ecosystems. *Science*, **239**: 149-157.
- Schlager, E. and Ostrom, E.** 1992. Property rights regimes and natural resources: A conceptual analysis. *Land Economic* **68**: 249-262.
- Schlesinger, W.H.** 1991. Climate, environment and ecology. In: Jäger, J. and Ferguson, H.L. (eds), *Climate Change: Science, impacts and policy.* Proceedings of the Second World Climate Conference. 371-378. Cambridge University Press, Cambridge.
- Schlosser, I.J.** 1991. Stream fish ecology: a landscape perspective. *BioScience*, **41**: 704-712.
- Schmid, J.A.** 1994. Wetlands in the urban landscape of the United States. In: Platt, R.H., Rowntree, R.A. and Muick, P.C. (eds), *The Ecological City: Preserving and restoring urban biodiversity.* 106-136. University of Massachusetts Press, Amherst.
- Schneider, S.H.** 1989. The greenhouse effect: science and policy. *Science* **243**: 771-781.
- Schreckenberg, K. and Hadley, M.** 1991. *Economic and Ecological Sustainability of Tropical Rain Forest Management.* MAB Digest 8. UNESCO, Paris.
- Schweitzer, J.** 1992. Conserving biodiversity in developing countries. *Fisheries (Bethesda)* **17**: 35-38.
- Scott, D.A. and Poole, C.M.** 1989. *A Status Overview of Asian Wetlands.* Asian Wetland Bureau, Kuala Lumpur, Malaysia.
- Sharma, D.** 1991. Quarrying threatens India's tigers. *New Scientist* 28, September: 16.
- Shaw, R.P.** 1989. Rapid population growth and environmental degradation: ultimate versus proximate factors. *Environmental Conservation* **16**: 199-208.
- Shepherd, P.A.** 1994. A review of plant communities of derelict land in the city of Nottingham, England and their value for nature conservation. In: Barker, G.M., Luniak, M., Trojan, P. and Zimny, H. (eds), *Proceedings of the Second European Meeting of the International Network for Urban Ecology.* 129-138. *Memorabilia Zoologica* 49, Warsaw.
- Shiva, V.** 1991. *The Violence of the Green Revolution: Third World agriculture, ecology and politics.* Third World Network, Penang.
- Shiva, V., Anderson, P., Schucking, H., Gray, A., Lohmann, L. and Cooper, D.** 1991. *Biodiversity: Social and Ecological perspectives.* World Rainforest Movement, Malaysia.
- Siitonen, J.** 1994. Decaying wood and saproxylic coeloptera in two old spruce forests: a comparison based on two sampling methods. *Annales Zoologica Fennici* **31**: 89-95.
- Simberloff, D. and Cox, J.** 1987. Consequences and costs of conservation corridors. *Conservation Biology* **1**: 63-71.
- Simon, J.L. and Kahn, H.** (eds), 1984. *The Resourceful Earth: A Response to Global 2000.* Basil Blackwell, New York.
- Singer, S.** 1991. *The Earth Religion: Reawakening the human animal.* ABACE Publications, Grass Valley, Calif.
- Skibniewska, H.** 1994. An urban designer's view of the ecological problems of the city. In: Barker, G.M., Luniak, M., Trojan, P. and Zimny, H. (eds), *Proceedings of the Second European Meeting of the International Network for Urban Ecology.* 11-14. *Memorabilia Zoologica* 49, Warsaw.
- Skogland, T.** 1990. Density dependence in a fluctuating wild reindeer herd: maternal vs. offspring effects. *Oecologia Vol.* 442-450.
- Skole, D. and Tucker, C.** 1993. Tropical deforestation and habitat fragmentation in the Amazon: satellite data from 1978-1988. *Science* **260**: 1905-1909.
- Skole, D.L., Chomentowski, W.H., Salas, W.A. and Nobre, A.D.** 1994. The human dimensions of deforestation in Amazonia. *BioScience* **44**: 314-322.
- Smith, A.H., and Berkes, F.** 1991. Solutions to the 'tragedy of the commons': sea urchin management in St Lucia, West Indies. *Environmental Conservation* **18**: 131-136.
- Smith, C.R.** 1992. Whale falls: Chemosynthesis on the deep seafloor. *Oceanus* **35**: 74-78.
- Smith, C.R., Kukert, H., Wheatcroft, R.A., Jumars, P.A. and Deming, J.W.** 1989. Vent fauna on whale remains. *Nature* **341**: 27-28.
- Smith, E.A.** 1983. Anthropological applications of optimal foraging theory: A critical review. *Current Anthropology* **24**: 625-640.

- Smith, D.S.** and Helmund, P.C. (eds), 1993. *Ecology of Greenways*. University of Minnesota Press, Minneapolis.
- Smith, R.C. et al.** 1992. Ozone depletion: ultraviolet radiation and phytoplankton biology in Antarctic Waters. *Science* **255**: 952–959.
- Smith, S.H.** 1972. Factors of ecologic succession in oligotrophic fish communities of the Laurentian Great Lakes. *Journal of the Fisheries Research Board of Canada* **29**: 717–730.
- Solbrig, O.T.** 1991. *From Genes to Ecosystems: A research agenda for biodiversity*. IUBS, Paris.
- Solleiro, J.L., Del Valle, M.C. and Sánchez, I.L.** 1993. La innovación tecnológica en la agricultura Mexicana. *Comercio Exterior* **43**: 353–369.
- Soulé, M.E.** 1991. Conservation: tactics for a constant crisis. *Science* **253**: 744–750.
- Soulé, M.E. and Kohm, K.A.** (eds), 1989. *Research Priorities for Conservation Biology*. Island Press, Washington, DC.
- Soulé, M.E. and Simberloff, D.** 1986. What do genetics and ecology tell us about the design of nature reserves. *Biological Conservation* **35**: 19–40.
- Soulé, M.E. and Wilcox, B.A.** 1980. *Conservation Biology: An evolutionary–ecological approach*. Sinauer Associates, Sunderland, Mass.
- Sprugel, D.G.** 1991. Disturbance, equilibrium and environmental variability: What is 'natural' vegetation in a changing environment? *Biological Conservation* **58**: 1–18.
- Steele, J.H. and Henderson, E.W.** 1984. Modelling long-term fluctuations in fish stocks. *Science* **224**: 985–987.
- Stein, D.** 1988. Burning widows, burning brides; the perils of daughterhood in India. *Pacific Affairs* **61**: 465–485.
- Stevenson, A.C. and Thompson, D.B.A.** 1993. Long-term changes in the extent of heather moorland in upland Britain and Ireland: palaeoecological evidence for the importance of grazing. *The Holocene* **3**: 70–76.
- Stevenson, G.G.** 1991. *Common Property Economics: A general theory and land use applications*. Cambridge University Press, Cambridge.
- Stewart, O.C.** 1956. Fire as the first great force employed by man. In: Thomas, W.L., Jr (ed.), *Man's Role in Changing the Face of the Earth*. 115–133. University of Chicago Press, Chicago.
- Stokes, K., Law, R. and McGlade, J.** (eds), 1993. *The Evolution of Exploited Populations*. Springer-Verlag, Berlin.
- Stuart, S.N. and Collar, N.J.** 1988. *Birds at Risk in Africa and Related Islands: The causes of their rarity and decline*. Proceedings of the Sixth Pan-African Ornithological Congress.
- Suzuki, D. and Knudtson, P.** 1992. *Wisdom of the Elders*. Bantam Books, New York.
- Swanson, T. and Barbier, E.** 1992. *Economics for the Wild*. Earthscan, London.
- Swanson, F.J., Gregory, S.V., Sedell, J.R. and Campbell, A.G.** 1982. Land–water interactions: the riparian zone. In: Edmonds, R.L. (ed.), *Analysis of Coniferous Forest Ecosystems in the Western United States*. 267–291. US/IBP Synthesis Series 14. Hutchinson–Ross, Stroudsburg, Pa.
- Swart, R. de, Ross, L., Peter, S., Vedder, L.J., Timmerman, H.H., Heisterkamp, S., Van Loveren, H., Vos, J.G., Joseph, G., Reijnders, P.J.H. and Osterhaus, A.D.M.E.** 1994. Impairment of immune function in harbor seals (*Phoca vitulina*) Feeding on fish from polluted waters. *Ambio* **23**: 155–159.
- Sweezy, P. and Magdoff, H.** 1989. Capitalism and the environment. *Monthly Review* **41**: 1–10.
- Swift, M.J. and Anderson, J.M.** 1992. Biodiversity and ecosystem function in agricultural systems. In: Schultz, E.D. and Mooney, H.A. (eds), *Biodiversity and Ecosystem Function*. 15–42. Springer-Verlag, Berlin.
- Tainter, J.A.** 1988. *The Collapse of Complex Societies*. Cambridge University Press, Cambridge.
- Taylor, K.I.** 1988. Deforestation and Indians in the Brazilian Amazonia. In: Wilson, E.O. and Peter, F.M. (eds), *Biodiversity*. 138–144. National Academy Press, Washington, DC.
- Teale, A.** 1993. Improving control of livestock diseases. *BioScience* **43**: 475–483.
- Teran, S. and Rasmussen, C.H.** 1995. Genetic diversity and agriculture strategy in 16th century and present-day Yucatecan Milpa agriculture. *Biodiversity and Conservation* **4**: 363–381.
- The Crucible Group.** 1994. *People, Plants and Patents*. International Development Research Centre, Ottawa.
- Theys, J.** 1987. 21st century: Environment and resources. *E.E.R.* **1**: 3–11.
- Thirgood, J.V.** 1981. *Man and the Mediterranean Forest: A history of resource depletion*. Academic Press, London.
- Thomas, W.L. Jr.** (ed.) 1956. *Man's Role in Changing the Face of the Earth*, Vols. 1 and 2. University of Chicago Press, Chicago.
- Thorbjarnarson, J.** 1992. *Crocodiles. An action plan for their exploitation*. IUCN, Gland.
- Tilman, D., May, R.M., Lehman, C.L. and Nowak, M.A.** 1995. Habitat destruction and the extinction debt. *Nature* (in press).
- Tolba, M.K., El-Kholy, O.A., El Hinnawi, E., Holdgate, M.W., McMichael, D.F. and Munn, R.E.** (eds), 1992. *The World Environment 1972–1992: Two decades of challenge*. Chapman and Hall, London.
- Tregear, T.R.** 1970. *An Economic Geography of China*.
- Trojan, P.** 1994. The shaping of the diversity of invertebrate species in the urban green spaces of Warsaw. In: Barker, G.M., Luniak, M., Trojan, P. and Zimny, H. (eds), Proceedings of the Second European Meeting of the International Network for Urban Ecology. 167–175. *Memorabilia Zoologica* 49, Warsaw.
- Tuan, Y.**, 1970. *The World's Landscapes: China*.
- Turke, P.W.** 1990. Which humans behave adaptively, and why does it matter? *Ethology and Sociobiology* **11**: 305–339.
- Turnbull, C.** 1972. *The Mountain People*. Simon and Schuster, New York.
- Turner, B.L., Clark, W., Kates, R., Richards, J., Mathews, J.T. and Meyer, W.B.** 1991. *The Earth as Transformed by Human Action*. Cambridge University Press, Cambridge.
- Turner, I.M., Tan, H.T.W., Wee, Y.C., Bin Ibrahim, A., Chiew, P.T. and Corlett, R.T.** 1994. A study of plant species extinction in Singapore: lessons for the conservation of tropical biodiversity. *Conservation Biology* **8**: 705–712.
- Tvedten, L. and Hersoug, B.** (eds), 1992. *Fishing for Development*. The Scandinavian Institute of African Studies, Uppsala, Sweden.
- Ucko, P.J. and Dimbleby, G.W.** 1969. *The Domestication of Plants and Animals*. Gerald Duckworth, London.
- Udvardy, M.D.F.** 1975. *A Classification of the Biogeographical Provinces of the World*. IUCN Occasional Papers No. 18. IUCN, Gland.

- United Nations.** 1989. *World Economic Survey 1989*. UN Department of Public Information, New York.
- UNDP.** 1992. *Human Development Report*. Oxford University Press, New York.
- UNDP.** 1992. *Human Development Report 1992*. Oxford University Press, New York.
- UNEP.** 1991. *Status of desertification and the implementation of the Plan of Action to combat Desertification*. 1978–1984. UNEP, Nairobi.
- UNEP.** 1992. *The State of the Environment, 1972–1992: Saving Our Planet*. UNEP, Nairobi.
- UNEP.** 1994. *Report of the open-ended intergovernmental meeting of scientific experts on biological diversity*. UNEP/CBD/IC/2/11.
- UNFPA.** 1992. *A World in Balance: State of world population*. UNFPA, New York.
- Usher, M.B., Kruger, F.J., Macdonald, I.A.W., Loope, L.L. and Brockie, R.E.** 1988. The ecology of biological invasions into nature reserves: an introduction. *Biological Conservation* **44**: 1–8.
- USNRC.** 1992. *Conserving Biodiversity. A research agenda for development agencies*. National Academy Press, Washington, DC.
- Vader, W., Anker-Nilssen, T., Bakken, V., Barrett, R. and Strann, K.B.** 1990. Regional and temporal differences in breeding success and population development of fish-eating seabirds in Norway after collapses of herring and capelin stocks. *Transactions of the 19th IUGB Congress, Trondheim 1989*: 143–150.
- Väisänen, R., Biström, O. and Heliövaara, K.** 1993. Sub-cortical coleoptera in dead pines and spruces: is primeval species composition maintained in managed forests? *Biodiversity and Conservation* **2**: 95–113.
- Valle, C.A. and Coulter, M.C.** 1987. Present status of the flightless cormorant, Galapagos penguin and greater flamingo populations in the Galapagos Islands, Ecuador, after the 1982–83 El Niño. *The Condor* **89**: 276–281.
- Van den Oever, P.** 1993. Women's roles, population issues, poverty and environmental degradation. In: de Boef, W., Amanor, K. and Wellard, K. (eds), *Cultivating Knowledge*. Intermediate Technology Publications, Amsterdam.
- Veitch, C.R.** 1985. Methods of eradicating feral cats from offshore islands in New Zealand. In: Moors, P.J. (ed.), *Conservation of Island Birds*. 125–143. ICBP Technical Publication No. 3.
- Vesely, J.** 1994. Effects of acidification on trace metal transport in fresh waters. In: Steinberg, C.E.W. and Wright, R.W., (eds.), *Acidification of Freshwater Ecosystems: Implications for the Future*. 141–151. John Wiley, London.
- Vincent, J.R.** 1992. The tropical timber trade and sustainable development. *Science* **256**: 1651–1655.
- Vinther, M.** 1994. Incidental catch of harbour porpoise (*Phocaena phocaena*) in the Danish North sea gill-net fisheries – preliminary results. *North Sea Quality Status Report*, North Sea Task Force Meeting, Elbetoft, April 18–21.
- Vitousek, P.M., Ehrlich, P.R., Ehrlich, A.H. and Matson, P.A.** 1986. Human appropriation of the products of photosynthesis. *BioScience* **36**: 368–373.
- Vitousek, P.M., Walker, L.R., Whiteaker, L.D., Mueller-Dombois, D. and Matson, P.A.** 1987. Biological invasion by *Myrica faya* alters ecosystem development in Hawaii. *Science* **238**: 802–804.
- von Broembsen, S.L.** 1989. Invasions of natural ecosystems by plant pathogens. In: Drake, J.A., Mooney, H.A., di Castri, F., Groves, R.H., Kruger, F.J., Rejmánek, M. and Williamson, M. (eds), *Biological Invasions: A global perspective*. 77–82. SCOPE 37. John Wiley, New York.
- Waage, J.K.** 1991. Biodiversity as a resource for biological control. In: Hawksworth, D.L. (ed.) *The Biodiversity of Microorganisms and Invertebrates: Its role in Sustainable Agriculture*. 149–163. CAB International, Wallingford, UK.
- Waggoner, P.E.** 1994. *How Much Land Can Ten Billion People Spare for Nature?* Report 121. Council for Agricultural Science and Technology, Ames, Iowa.
- Walker, B.** 1989. Diversity and stability in ecosystem conservation. In: Western, D. and Pearl, M. (eds), *Conservation for the Twenty-first Century*. 121–130. Oxford University Press, New York.
- Walker, H.J.** 1990. The coastal zone. In: Turner, B.L., Clark, W.C., Kates, R.W., Richards, J.F., Mathews, J.T. and Meyer, W.B. (eds), *The Earth as Transformed by Human Action*. 271–294. Cambridge University Press, Cambridge.
- Waples, R.S.** 1991. Genetic interactions between hatchery and wild salmonids: lessons from the Pacific Northwest. *Canadian Journal of Fisheries and Aquatic Science* **48** (Supplement 1): 124–133.
- Ward, E.** 1993. *Indigenous Peoples: Between human rights and environmental protection*. The Danish Centre for Human Rights, Copenhagen.
- Ward, J.V. and Stanford, J.A.** 1979. *The Ecology of Regulation Streams*. Plenum Press, New York.
- Warrick, R.A., Jones, P.D. and Russell, J.E.** 1988. *The Greenhouse Effect, Climatic Change and Sea Level: An overview*. Paper prepared for Commonwealth Expert Group on Climatic Change and Sea Level Rise. London, May 1988.
- Watkins, L.H.** 1991. *Air Pollution and Road Vehicles*. Transport and Road Research Laboratory State-of-the-Art Review 1. HMSO, London.
- Way, J.M.** 1977. Roadside verges and conservation in Britain. *Biological Conservation* **12**: 65–74.
- WCMC.** 1992. *Global Biodiversity: Status of the Earth's living resources*. Chapman and Hall, London.
- Weber, J. and Reveret, J.P.** 1993. Biens communs: les leurre de la privatisation. *Le Monde Diplomatique, Collection Savoirs n. 2: Une terre en renaissance*, 71–73.
- Wee, Y.C. and Corlett, R.C.** 1986. *The City and the Forest*. Singapore University Press, Singapore.
- Welcomme, R.L.** 1992. The conservation and environmental management of fisheries in inland and coastal waters. *Netherlands Journal of Zoology* **42**: 176–189.
- Wells, S.M.** 1995. The extinction of endemic snails (Genus *Partula*) in French Polynesia: is captive breeding the only solution? In: Kay, E.A. (ed.), *The Conservation Biology of Molluscs*. Proceedings of a symposium held at the 9th International Malacological Congress, Edinburgh, Scotland. 24–27. Occasional Paper of the Species Survival Commission No. 9. IUCN, Gland.

- Western, D.** 1989. Population, resources and environment in the twenty-first century. In: Western, D. and Pearl, M. (eds), *Conservation for the Twenty-first Century*, 11–25. Oxford University Press, New York.
- Westman, W.E.** 1990. Detecting early signs of regional air pollution injury to coastal sage scrub. In: Woodwell, G.M. (ed.), *The Earth in Transition*, 323–346. Cambridge University Press, Cambridge.
- Weston, D. and Wright, R.M. (eds.)** 1994. *Natural Connections: Perspectives in community-based conservation*. Island Press, Washington, DC and Covelo, California.
- Wells, H.G.** 1902. *Anticipation of the Reaction of Mechanical and Scientific Progress Upon Human Life and Thought*. 5th edn. Chapman and Hall, London.
- Wharton, C.** 1968. Man, fire, and wild cattle in Southeast Asia. *Proceedings of the Annual Tall Timbers Fire Ecology Conference* 8: 107–167.
- White, P.T.** 1994. Rice, the essential harvest. *National Geographic* 185 (5): 48–79.
- Whiteley, D.** 1994. The state of knowledge of the invertebrates of urban areas in Britain with examples taken from the city of Sheffield. In: Barker, G.M., Luniak, M., Trojan, P. and Zimny, H. (eds), *Proceedings of the Second European Meeting of the International Network for Urban Ecology*, 207–220. *Memorabilia Zoologica* 49, Warsaw.
- Whitmore, T. and Sayer, J. (eds)**, 1992. *Tropical Deforestation and Species Extinction*. Chapman and Hall, London.
- Whitmore, T.C.** 1984. *Tropical Rainforests of the Far East*, 2nd edn. Clarendon Press, Oxford.
- Whittaker, R.H. and Likens, G.E.** 1975. The Biosphere and Man. In: Leath, H. and Whittaker, R.H. (eds), *Primary Productivity and the Biosphere*, 305–328. Springer-Verlaag, Berlin.
- Wilcove, D.S., McLellan, C.H. and Dobson, A.P.** 1986. Habitat fragmentation in the Temperate Zone. In: Soulé, M.E. (ed.), *Conservation Biology: The science of scarcity and diversity*, 237–256. Sinauer Associates, Sunderland, Mass.
- Wilkinson, C.R.** 1993. Coral reefs of the world are facing widespread devastation: Can we prevent this through sustainable management practices? In: Richmond R.H. (ed.), *Proceedings of the Seventh International Coral Reefs Symposium*, 11–21. University of Guam Press, Mangilao, Guam.
- Wilkinson, C.R. and Buddemeier, R.W.** 1994. *Global Climate Change and Coral Reefs: Implications for People and Reefs*. IUCN, Gland.
- Wilson, A.D.** 1990. The effect of grazing on Australian ecosystems. In: Saunders, D.A., Hopkins, A.J.M. and How, R.A. (eds), *Australian Ecosystems: 200 Years of Utilization, Degradation and Reconstruction*. Proceedings of the Ecology Society of Australia 1990–16. Surrey Beatty and Sons, Chipping Norton, NSW.
- Wilson, E.O.** 1984. *Biophilia*. Harvard University Press, Cambridge, Mass.
- Wilson, E.O.** 1985. The biological diversity crisis: a challenge to science. *Issues in Science and Technology* (Fall): 20–29.
- Wilson, E.O., and Peter, F.M. (eds)**, 1988. *Biodiversity*. National Academy Press, Washington, DC.
- Winn, S.F. and Roome, N.J.** 1993. RandD management responses to the environment: Current theory and implications to practices and research. *RandD Management* 23: 147–160.
- Wittfogel, K.A.** 1957. *Oriental Despotism: A comparative study of total power*. Yale University Press, New Haven, Conn.
- Wolking, F. and Plank, S.** 1981. *Dry Grasslands of Europe*. Council of Europe, Strasbourg.
- Wolman, M.G. and Fournier, F.G.A. (eds)**, 1987. *Land Transformation in Agriculture*. SCOPE 32. John Wiley, New York.
- Wood, D. and Linne, J.** 1993. Dynamic management of domesticated biodiversity by farming communities. In: Sandlund, O.T. and Schei, P.J. (ed.), *Proceedings of the Norway/UNEP Expert Conference on Biodiversity*.
- Woodley, S.L., Kay, J. and Francis, G.** 1993. *Ecological Integrity and the Management of Ecosystems*. St Lucie Press.
- Woodward, F.I.** 1992. A review of the effects of climate on vegetation: Ranges, competition, and composition. In: Peters, R.L. and Lovejoy, T.E. (eds), *Global Warming and Biological Diversity*, 105–123. Yale University Press, New Haven, Conn.
- Worede, M. and Mekbib, H.** 1993. Linking genetic resource conservation to farmers in Ethiopia. In: Boef, W. de, Amanor, K., Wellardf, K. and Bebbington, A. (eds), *Cultivating Knowledge. Genetic Diversity, Farmer Experimentation and Crop Research*, 78–84. Intermediate Technology Publications, Amsterdam.
- World Commission on Environment and Development (WCED)**, 1987. *Our Common Future*. Oxford University Press, Oxford.
- World Conservation Monitoring Centre (WCWC)**, 1992. *Global Biodiversity: Status of the Earth's living resources*. Chapman and Hall, London.
- World Resources Institute (WRI)**, 1994. *World Resources 1994–1995. A guide to the global environment*. Oxford University Press, Oxford.
- WRI, IUCN, UNEP**, 1992. *Global Biodiversity Strategy: Guidelines for Action to Save, Study, and Use Earth's Biotic Wealth Sustainably and Equitably*. WRI, IUCN, UNEP, Washington, DC.
- WRI, UNEP, UNDP**, 1990. *World Population Prospects*. Population studies, 120.
- Wynne, G., Avery, M., Campbell, L., Gubbay, S., Hawkswell, S., Juniper, T., King, M., Newbery, P., Smart, J., Steel, C., Stones, T., Stubbs, A., Taylor, J., Tydeman, C. and Wynde, R.** 1995. *Biodiversity Challenge*, 2nd edn. Royal Society for the Protection of Birds, Sandy, UK.
- Yoffee, N. and Cowgill, G.H.** 1988. *The Collapse of Ancient States and Civilization*. University of Arizona Press, Tucson.
- Zaret, T.M., and Paine, R.T.** 1973. Species introduction in a tropical lake. *Science* 182: 449–455.
- Zinsser, H.** 1934. *Rats, Lice and History*. Little, Brown, and Co., New York.

The Economic Value of Biodiversity

C. PERRINGS

Authors:

E.B. Barbier, G. Brown, S. Dalmazzone, C. Folke, M. Gadgil, N. Hanley, C.S. Holling, W.H. Lesser, K.-G. Mäler, P. Mason, T. Panayotou, C. Perrings, R.K. Turner, M. Wells

CONTENTS

Executive Summary	827	12.4 The problem of risk and uncertainty	858
12.1 Economic value and biodiversity	829	12.4.1 Distinguishing risk and uncertainty	858
12.1.1 Introduction	829	12.4.2 Risk and uncertainty in environmental decision-making	862
12.1.2 Market failure, policy failure and the problem of externality	830	12.4.2.1 Scenario analysis	863
12.1.3 Poverty, discounting and value	831	12.4.2.2 Extended scenario analysis (sensitivity analysis)	863
12.1.4 The value of diversity	832	12.4.2.3 Monte Carlo analysis	863
12.1.5 Biodiversity and ecosystem functions	833	12.4.2.4 Worst-case scenario	863
12.1.6 Concluding remarks	834	12.4.3 The precautionary principle and safe minimum standards	863
12.2 Use and nonuse value	835	12.4.4 Concluding remarks	864
12.2.1 A typology of values	835	12.5 The valuation of species and habitats: empirical results	865
12.2.2 Value, ethics and equity	836	12.5.1 Introduction	865
12.2.3 Social and cultural differences in the perception of value	837	12.5.2 The value of genetic resources and biotechnology	869
12.2.4 Use value: species versus habitats	839	12.5.3 The value of species	872
12.2.5 Use value: habitats versus ecosystems	841	12.5.4 Estimates of the value of parks and protected areas	876
12.2.6 Concluding remarks	843	12.5.5 Concluding remarks	878
12.3 The valuation of biodiversity: theory and methodology	844	12.6 The valuation of ecosystem functions: empirical results	878
12.3.1 Introduction	844	12.6.1 The indirect value of biological resources	878
12.3.2 Stated preference methods: contingent valuation and contingent ranking	845	12.6.2 Estimates of the use value of forests	879
12.3.2.1 Contingent valuation	845	12.6.3 The total value of forests	887
12.3.2.2 Contingent ranking	846	12.6.4 Valuation and policy	888
12.3.3 Revealed preference methods: travel cost and random utility models	848	12.6.5 Concluding remarks	889
12.3.3.1 The travel cost model	848	12.7 Valuation in the conservation of biodiversity	890
12.3.3.2 The hedonic travel cost model	850	12.7.1 The goals of conservation	890
12.3.3.3 The random utility model	850	12.7.2 Protected areas, conservation and development	891
12.3.4 Production function approaches	851	12.7.3 Incentives and the appropriation of value: the local problem	893
12.3.5 Revealed preference and opportunity cost	856	12.7.3.1 Structural adjustment programmes and policies	894
12.3.5.1 Change in productivity method	856	12.7.3.2 Raising local benefits	895
12.3.5.2 Change in earnings method	856	12.7.3.3 Lowering local opportunity costs	895
12.3.5.3 Defensive or preventative expenditures method	856	12.7.3.4 Lowering forest protection costs	895
12.3.5.4 Replacement cost method	856	12.7.3.5 Water fees as conservation incentives	895
12.3.5.5 Substitution or proxy method	857	12.7.3.6 Internalizing ecotourism benefits	896
12.3.5.6 The shadow project method	857	12.7.3.7 Reforestation incentives	896
12.3.5.7 Compensation cost method	857		
12.3.5.8 Benefits transfer	857		
12.3.6 Concluding remarks	857		

12.7.3.8 Differential land-use tax	896	The global problem	898
12.7.3.9 Environmental bonds	896	12.7.4.1 Global environmental markets	899
12.7.3.10 Forest compacts	897	12.7.5 Incentives, property rights and the distribution of wealth	902
12.7.3.11 Carbon offsets	897	12.7.6 Concluding remarks	903
12.7.3.12 Transferable development rights	897		
12.7.3.13 Other instruments	898		
12.7.4 Incentives and the appropriation of value:		References	904

EXECUTIVE SUMMARY

The simplification of managed ecosystems in agriculture, forestry and aquaculture has provided humankind with important biological resources: foods and fibres. It has also had major effects on biodiversity. These effects are largely external to the market (they are not reflected in market prices) and so are ignored by resource users. The existence of external costs is said to be evidence of market failure.

The importance of the gap between the market price of environmental resources and their value to individuals and societies is only gradually coming to be understood. The causes of the gap are much better understood. One of these is ignorance or uncertainty about the social consequences of private actions. A second is a structure of rights that encourages people to ignore the known social consequences of their actions (the so-called 'tragedy of the commons' is an example of this). A third is government policy which not only fails to correct externalities, but makes the problem worse (through, for example, destumping subsidies in agriculture and forestry). This is evidence of policy failure. Together, market and policy failures are the main underlying causes of biodiversity loss.

To resolve the problems of market and policy failure we need first to evaluate their consequences. As the value that different individuals and different societies place on resources is measured by their willingness to forgo the benefits of alternative uses for the same resources, this requires the valuation of biological resources in alternative uses. Values vary with the preferences, culture, ethical values and world views of the people concerned, as well as the technology available to them. They also vary with the distribution of income and assets. Poor people are often willing to pay less for biodiversity conservation than rich people, not necessarily because they care less, but because they have fewer resources.

Valuation can be seen as a method of determining the relative importance of the environmental consequences of economic activities. It helps environmental authorities to make informed decisions about biodiversity conservation where there are alternative ways of treating resources. It helps, for example, to determine what development opportunities different societies need to give up if they wish to protect biological resources. Economists generally use one of two methods to estimate the value of non-marketed resources. They use either surrogate markets

to reveal the value people implicitly place on the resource, or simulated markets to get resource users to state their values explicitly.

The value of biological resources in use may be direct (they are used in consumption or production) or indirect (they support resources which have direct value). Biological resources also have non-use or passive use values stemming from the fact that we may care about others (or other species). Many domesticated biological resources are traded on markets, and their direct use values (such as crops, livestock and timber) are reflected in their market prices. Others derive value from their role in supporting marketed resources. A number of modern crop varieties and livestock strains, for example, contain genetic material incorporated through plant breeding from related wild or weedy species, or from more primitive genetic stocks. Biotechnology has increased the scope for gene transfer between unrelated species.

The use value of biodiversity is generally an indirect use value, and derives from the role of the mix of species in supporting either individual organisms (the value of habitat) or ecological services (the value of ecosystem functions). This includes ecological functions, protection functions, waste assimilation functions and wider functions such as microclimatic stabilization and carbon storage. Tropical forests, for example, provide not only the direct use values of timber, other forest products, medicinal plants, plant genetics, hunting and fishing, recreation and tourism: they also provide indirect use values of forests including habitat provision, soil conservation and soil productivity (through nutrient cycling), soil conservation and watershed protection with derivative services of water supply and storage, flood control, micro-climatic effects and carbon sequestration. These environmental functions all indirectly support economic activity and human welfare. The mix of species in an ecosystem enables that system both to provide the flow of ecosystem services and to maintain that flow over a range of environmental conditions. It has, in this sense, insurance value.

The current use of biological resources on the basis of market signals is both inefficient and inequitable. It leads to losses in social welfare that bear most heavily on the poorer members of this generation and will bear on all members of future generations. The appropriate policy

response is to develop institutions and incentives that will (a) confront resource users with the full social cost of their behaviour, and (b) enable those who invest in conservation to appropriate the benefits. Traditional approaches to protected areas have sometimes worked against the interests of local populations by removing traditional rights of access to, and benefits of, the resources in protected areas and by removing responsibility for management of the area from local people.

To be effective in an evolving ecological-economic

system, institutions need to be adaptive, i.e. able to respond to environmental feedbacks before those effects cause the system to break down. It may be necessary to bound economic activity to minimize the risk of irreversible damage to ecosystems on which human activity depends. But although preserving biodiversity through nature reserves and other protected areas may be an important short-term step where biological resources are under immediate threat, it is not feasible to protect critical ecological systems by excluding human users of wild resources.

12.1 Economic value and biodiversity

12.1.1 Introduction

Earlier sections of this Assessment have described what is currently known about the ecological importance of biodiversity. This Section considers what is currently known about its social importance; its 'value' to human society. The two things are not necessarily the same. That is, it does not follow that if biodiversity is important to the functioning of some ecological system it will automatically be valuable to society, or vice versa. The value of biodiversity to society depends on many things besides its ecological significance, and these things tend to vary from one country to another and one culture to another. Different societies place different values on biological resources, just as they do on other resources. Social preferences, technology, and the distribution of income and assets all influence perceptions of value. This section considers what lies behind the value placed on biodiversity by different societies.

The question is important because the value of biodiversity determines not just the sense of its 'worth' in any given society, but the way it is used or abused. The organisms that make up global biodiversity are part of the resources available to society, and their allocation between competing uses depends on their relative value. Whether the value of biological resources stems from their usefulness in production or consumption, from their cultural significance or from some notion of their right to exist, it will determine how much biodiversity is conserved. We need to understand the value of biodiversity if people are to understand both what is driving the present loss of biodiversity and what may be done to conserve it.

More particularly, the rationale for valuing environmental resources in general, and biodiversity in particular, lies in the perception that the signals generated by the market system – prices – are leading to excessive rates of biodiversity loss. Private resource users are encouraged to deplete biological resources even though it is against the interests of both local and global societies that they should do so. From an economic perspective, the allocation of biological resources on the basis of market signals is inefficient. It is also inequitable. Market allocation of biological resources has led to losses in collective well-being, and these losses are distributed in a way that is unjust from the perspective of both the poorer members of this generation and all members of future generations. Many environmentalists have reached the same conclusion. The advantage of an economic approach to the valuation of biological resources is that it provides a means of quantifying the error, and testing its sensitivity to assumptions made about the distribution of income and assets and the weight given to consumption by members of future generations. An economic approach also indicates how markets might be reformed to remove the current

sources of bias, and where it is not possible to reform markets, how governments might intervene to correct the signals to private resource users. It also indicates how and where economic activity may be constrained so as to protect biological resources that are important for maintaining the options open to future generations.

It is worth emphasizing this last observation. The problem of biodiversity conservation requires much more than just 'getting the prices right'. The allocation of property rights and the liberalization of markets are not panaceas. Both may improve the efficiency with which biological resources are allocated, but neither can ensure the alignment of private and social costs, and neither can protect the interests of either poorer members of this generation or all members of future generations.

The idea that the value of biological resources is a reflection of their social cost, the opportunities forgone by society by committing such resources in some way, is what makes the concept an economic one. The term 'value' clearly means different things to different people, and discussion about environmental values is often dominated by differences in the concept of value employed. Indeed, the debate over environmental values often turns on whether values are considered as ethical judgements or equivalence measures, i.e. whether environmental values are statements of principle or a reflection of social costs (Turner and Pearce 1993; Pearce 1994a). If we are interested in committing resources to biodiversity conservation, however, it is difficult to avoid the latter. It is neither possible nor sensible to conserve everything. Hence we have to ask, how much biodiversity should be conserved? Which species, habitats or ecosystems should be conserved first? How should conservation be linked to development?

Economic measures of value are not in fact blind to ethical judgements. The value accorded by society to biodiversity conservation may be driven by moral or ethical concerns. It may, for example, be driven by an altruistic interest in the welfare of other humans or other species. Moral or ethical concerns, like tastes and preferences, can be translated into a willingness to commit resources to conserve biodiversity. The process of valuation merely makes explicit something that is currently implicit. In some cases it does so by eliciting direct statements of preference. In others it does so by using actual behaviour to reveal preference. Societies which cannot or will not place a monetary value on human life, for example, nevertheless commit resources to health and safety which reveal their willingness to pay to save life. The implicit value of human life is said to be revealed by their behaviour. Similarly, societies which cannot or will not explicitly value biodiversity nevertheless make decisions involving the loss of diversity which reveal their willingness to accept compensation for that loss. Since different societies have

$$\begin{array}{l}
 \text{TEV} = F(\overbrace{\text{DUV, IUV, OV, QOV}}^{\text{use value}}, \overbrace{\text{BV, EV}}^{\text{passive use or non-use value}}) \\
 \\
 \text{TV} = G(\overbrace{\text{PV}}^{\text{non-anthropocentric instrumental value}}, \overbrace{\text{TEV}}^{\text{anthropocentric value}})
 \end{array}$$

Where:

- TV = Total Environmental Value
- TEV = Total Economic Value
- DUV = Direct Use Value
- IUV = Indirect Use Value
- OV = Option Value (including bequest value)
- QOV = Quasi Option Value
- BV = Bequest Value
- PV = Primary Value
- EV = Existence Value

Figure 12.1-1: Total Environmental Value and Total Economic Value.

different endowments – and so different levels of income – the resources committed to biodiversity conservation will vary regardless of preferences. Rich and poor countries may value biodiversity conservation relative to other things in much the same way, but will commit different amounts to conservation. The valuation of biological resources and the diversity of those resources reveals both their relative importance in a given society and the society's ability to pay for them. It is important to understand both things.

Many economists have settled for a taxonomy of the value of environmental resources, sometimes called 'total economic value' (TEV), which distinguishes between direct and indirect use values and a remainder, sometimes termed non-use value but increasingly termed passive use value. The components of value are illustrated schematically in Figure 12.1-1. Direct and indirect use value frequently embody ethical positions. People consume or refrain from consuming some products because they think that it is 'right' to do so. The following chapters illustrate just how important such considerations can be. Passive use value is almost entirely driven by ethical considerations precisely because it is disinterested value.

Passive use value of biological resources (Brown 1990; Randall 1991) exists where individuals who do not intend to make use of such resources would nevertheless feel a 'loss' if they were to disappear. They may wish to see species conserved 'in their own right' (for the benefit of the species themselves); or they may be interested in retaining use options for other humans now or in the future. Passive or non-use value has been argued at various times to

include all of the following: bequest value, the value of keeping a resource intact for one's heirs (Krutilla 1967); option value, the value of the option to make use of the resource in the future (Weisbrod 1964); 'quasi-option' value, the value of the future information protected by preserving a resource (Arrow and Fisher 1974; Henry 1974; Fisher and Hanemann 1983) and existence value, the value conferred by assuring the survival of a resource (Krutilla 1967; Pearce and Turner 1990).

As an equivalence measure, value refers to the sacrifices that people need to make when using a resource, noting that protection for any one of these reasons is as much a use as harvest. It is measure of how much they need to forgo, or pay, for using a resource. More formally, the value to the individual of using a biological resource in some way is equal to the value of the opportunities forgone by the individual in so doing. This is referred to as the private opportunity cost of that resource. The value to society of using the resource in the same way, its social opportunity cost, is equal to the value of the opportunities forgone by the society in so doing. As this section makes clear, the two things are not necessarily the same. The opportunity cost to the individual of using a resource in some way is not necessarily the same as the opportunity cost to society. What individuals need to pay is not necessarily equal to what society has to forgo. Indeed, this is precisely why the valuation of biological resources is an important part of their conservation.

Economic value and economic scarcity are closely related concepts. Resources whose social opportunity cost or economic value is zero are said to be non-scarce. People can use as much as they like of such resources without forgoing anything at all. They are 'free'. All other resources are said to be scarce. The problem is, however, that many biological resources are free to private users but not to society. They are accordingly treated as non-scarce when in fact they are scarce. Many other biological resources are available to individuals at a private cost – the market price for those resources – that is below their social opportunity cost. They are accordingly treated as less scarce than they really are. The reasons for this are discussed in the next section.

12.1.2 Market failure, policy failure and the problem of externality

Economists are concerned about biodiversity precisely because market prices are unreliable indicators of social cost. The reason why the market price of some biological resource may not reflect its social cost is that it may not capture all of the effects of its use. Such effects are then said to be external to the market, and are taken as evidence of market 'failure'. External effects, or externalities, are a consequence of two things: dependence on a common environment (such as an airshed or watershed), and the

absence of some forum (market) in which to negotiate the value of those effects. Dependence on a common environment does not, of course, imply that all parties are affected equally by actions which generate externalities. Following Dasgupta (1991), it is useful to distinguish between two types of externality. Reciprocal externalities are those in which all parties using some resource impose external costs on all others. This is the classical problem of the commons. Unidirectional externalities are those in which the external costs or benefits of resource use are 'one way' (for example, upstream users of a resource can inflict damage on downstream users, but not vice versa). Both imply a structure of rights such that individual resource users are, in a sense, authorized to ignore the costs they impose on others.

There is a very wide range of rights currently conferred by law or custom on the users of biological resources, and these rights vary both from one country to another, and from one species to another. For example, rights with respect to migratory or otherwise mobile organisms typically differ from those with respect to stationary organisms. People very often 'own' land or its vegetational cover, but seldom 'own' migratory species which may cross their land. If the rights that people have allow them to ignore the consequences of their own actions on others, the private cost of the use of biological resources will differ from the social cost (private value will differ from social value), and resources will be misallocated. Rational individuals faced with prices that do not reflect the social cost of resources will make decisions that may be both inefficient and unfair from the point of view of society.

Other factors behind the divergence of private and social costs of biotic resources are those that make existing markets ineffective. This includes ignorance, uncertainty, the distribution of income and assets, the strategic market behaviour of economic agents and, most importantly, the way in which governments intervene in those markets. It is argued, for example, that the system of administered prices in many agricultural markets has at once distorted the private cost of biological resources and, in the case of the less developed economies at least, has reduced rural incomes (Pearce *et al.* 1988; McNeely 1988). Destumping subsidies in agriculture and stumpage fees or royalties in forestry, for example, are argued to have encouraged deforestation at excessive rates, both in terms of rates of felling in timber concessions and in the clearance of ever more marginal land for agricultural purposes (Warford 1987; Repetto 1989; Barbier *et al.* 1991). Subsidies designed to promote cash cropping as a means of increasing export revenue are argued to have resulted in leaching, soil acidification, and loss of soil nutrients, and to the reduction in the resilience of key ecosystems (Grainger 1990). Where pricing or other policies fail to close the gap

between private and social value, economists tend to refer to policy failure. Together, market failure and policy failure are the main underlying causes of biodiversity loss.

There is still a great deal to be done to establish where the biases in the set of prices confronting resource users lie. The implicit subsidy on agricultural land offered by traditional (common or communal) land tenure systems may, in many cases, be a more important source of bias than the price of agricultural outputs or non-land inputs (Githinji and Perrings 1993; though see Berkes *et al.* 1994 for counter-examples). In all cases, however, the main effect of a bias in the private cost of biological resources is that users do not accord them the weight they should. This is, of course, exactly the point made by environmentalists. The purpose of a valuation exercise is to establish what the weight should be if the interests of the whole of society are taken into account.

12.1.3 Poverty, discounting and value

Part of the problem in evaluating external effects is to determine the weight given to any future costs and benefits of resource use. This involves the question of how future costs and benefits should be discounted. The notion of discounting is quite intuitive. That is, most people have a reasonable intuition about the value they would place on something delivered in a year's time compared to its value delivered today, and so a reasonable intuition about how they would discount the future. The problem here is that discounting has ethical implications. Discounting implies that the welfare of future generations counts less than the welfare of the present generation. In fact, the ethics and rationality of discounting future costs and benefits are two of the most debated areas in economics (see Goodin 1982; Hanley and Spash 1994 for some of the points at issue). Moreover, given the enormous implications of the rate of discount in the use made of environmental resources, it is not at all surprising that these debates have continued longer in environmental economics than elsewhere. It is, moreover, easy to see where the moral qualms induced by discounting come from. The higher the rate of discount the greater, in general, is the rate at which natural resources, including species, are optimally depleted. The higher the rate of discount, the less interesting are the costs of present activities visited on future generations. The higher the rate of discount, the more uncertainty is screened out of the information relevant to the decision-making process.

It is not always the case that higher interest rates (the relevant discount rate for most investment projects) imply higher rates of depletion of renewable environmental resources. By depressing demand for investment funds, high interest rates can reduce the rate of exploitation of renewable resources (Pearce *et al.* 1990; Rowthorn and Brown 1994). Nevertheless, the iron law of the discount rate – by which species with a growth rate less than the rate

of discount will be optimally driven to extinction unless the growth in the value of the species compensates for the difference, or their extraction is regulated – has brought more opprobrium on economists than almost any other proposition in economics.

Despite this, the arguments of the 1970s against discounting on the grounds that it induces individuals to inflict harm on future generations (Randers and Meadows 1973; Myrdal 1975) have fewer and fewer echoes in recent work, and those who still hold to the view (e.g. Daly and Cobb 1989) acknowledge that a low discount rate is not sufficient to prevent harm being inflicted on future generations. It is now widely recognized that discount rates equal to the marginal productivity of the asset base may be ethically 'neutral'. Indeed, even those most concerned about the intergenerational equity implications of current environmental practices, argue that equity should be satisfied through intergenerational transfers, and not through the discount rate (Norgaard and Howarth 1991; Norgaard 1991).

Whatever method is used to uncover the private value of biological resources, this will be the same as the social value only if there are no externalities, if there is perfect information, if there are no biases in the formation of expectations, and if all future costs and benefits are discounted at the social rate. Since there is no reason to believe that these conditions will hold in even the simplest case, there is also no reason to believe that the private valuation of ecological services is an adequate approximation of the social value of those services.

Both information about future effects and the rate at which they are discounted turn out to be sensitive to the level of market income. Information is not costless. The poor may understand the value to them of using biological resources in familiar ways, but may not understand the value of the same resources to society under different technologies. The poor, by definition, are able to command less information than the rich. In addition, there is a strong relationship between income and the rate at which people discount the future. Because what matters is consumption today, people in poverty tend to discount the future costs of resource use at a very high rate, so distorting the private value they place on future effects (Perrings 1989a). For similar reasons, poverty turns out to be positively correlated with high rates of population growth, or at least with high rates of fertility – with all that this implies for pressure on environmental resources (Dasgupta 1993).

In addition, poverty turns out to be closely related to the same market and policy failures that lie behind the gap between private and social value. There is considerable evidence that a major source of poverty amongst the users of natural resources in many of the least resilient ecosystems has been due to manipulation of the set of prices they face. In some cases, such manipulation reflects

government intervention. It has, for example, been observed that a major effect of price intervention in agricultural markets in the less developed economies has been the reduction of producer incomes (cf. Warford 1987). In other cases – those which interested Sen (1981) in his work on poverty and famines, for example – such manipulation has reflected the strategic behaviour of producers in free markets. Both have had the same effect. In meeting their immediate consumption needs, the poor have been compelled to ignore the potential future consequences of the use they have made of environmental resources. It has been privately rational for them to ignore the future damage they do to both habitats and species.

An additional 'cause' of poverty is the distribution of assets, whether marketed or non-marketed. It is well understood that those with 'uneconomic' holdings of land and other natural resources, and who have no other source of income, will tend to over-exploit those holdings. It is of some concern, therefore, that there has been a marked and continuing tendency for the distribution of both assets and income to widen over time in many of the low income countries, reflecting both the erosion of traditional rights of access to the resource base and increasing human population pressure (see Ghai and Radwan (1983) for an example from sub-Saharan Africa). It turns out that gender is an important factor in this trend. Female-headed households typically have access to a much smaller asset base than male-headed households, and it is not coincidental that relative poverty in the sense of relative deprivation is reckoned to bear most heavily on women (UNDP 1990). In addition, the lower the security of tenure attaching to the use of an asset, the higher tends to be the rate at which the future costs of resource use are discounted: i.e. the lower the incentive to manage it on a sustainable basis.

12.1.4 The value of diversity

Later chapters in this Section distinguish clearly between direct and indirect values. Direct values stem from the direct consumption of resources. Indirect values stem from the fact that some resources, though not directly consumed, are nevertheless necessary to the production of resources that are directly consumed. Indirect effects are much more likely to be external to the market than direct effects. Biodiversity, because its value is indirect, tends to fall into this category. Where the value of particular organisms often stems from their use in consumption or production, or their 'totemic value', the value of the mix of organisms lies in its role in supporting the productivity of the system from which individuals are extracted. To see the origin of this value, however, we recap the role of biodiversity in ecosystems discussed in detail in Sections 5 and 6.

Although any ecosystem contains hundreds to thousands of species interacting amongst themselves and with their

physical environment, the emerging consensus is that the system is driven by a small number of biotic and abiotic variables on whose interactions the balance of species are, in a sense, carried along (Holling 1992). This has led to the characterization of species as either 'drivers' or 'passengers', with some species becoming 'drivers' only occasionally and under particular conditions that trigger their key structuring function. There is certainly empirical evidence that the deletion of some species appears to have minimal effect on the functioning of ecosystems, whilst the deletion of others triggers a fundamental transformation from one ecosystem type to another, e.g. from forest to grassland, or grassland to a shrubby semi-desert (Walker *et al.* 1969; Holling 1973). There are, however, insufficient long-term studies to show whether the presence or absence of rare species may cause slower, more subtle shifts in ecosystem structure or function.

The fundamental point is that only a small set of structuring processes made up of biotic and physical processes are critical in forming the structure and overall behaviour of ecosystems, each of which dominates over a definable range of scales in space and time. These processes are supported by groups of species, each of which includes several species of plants or animals having complementary functions with respect to the processes concerned. Examples include the set of grass species that maintain the productivity and resilience of savannahs (Walker *et al.* 1969), or the set of insectivorous birds that mediate budworm outbreak dynamics in the eastern boreal forest (Holling 1988). Indeed, there is growing evidence that the great complexity and diversity within many ecosystems can be traced to a small number of critical structuring processes mediated either by individual 'keystone' species (Paine 1966) or by sets of species (Holling *et al.* 1995).

The implication of this is that the resilience of ecosystems depends on the range of species capable of supporting the critical structuring processes of those systems under different environmental conditions – conditions that subject the system to different degrees of stress and different magnitudes of shock. Some individual species and some sets of species have greater ecological value under the current state of nature than others, but this does not imply that all other species are redundant (in excess supply) and hence of no value. The importance of the mix or diversity of species for the resilience of ecosystems lies precisely in the fact that species which are passengers under one state of nature may have a key structuring role to play under other states of nature.

A change in the composition of species that affects any one of the key structuring processes may have profound consequences for the ability of an ecosystem to provide economically valued ecological services. The ecological impact of biodiversity loss is conditional on the link

between the species and the critical processes of the ecosystem concerned. Whether the deletion of some species does affect such processes is a function of the number of alternative species that can 'take over' a particular function when an ecosystem is perturbed (Schindler 1988, 1990b). Evidence from aquatic ecosystems suggests that the most sensitive components of food webs, energy flows and biogeochemical cycles are those where the number of species carrying out that function is very small (Schindler 1990a).

These remarks are more relevant for terrestrial systems or for aquatic systems dominated by substrate (nearshore ecosystems with abundant recruitment, coral reefs or shallow freshwater lakes) than for open pelagic marine systems. The latter have different physical properties of land and air on the one hand, and water on the other. A hierarchy of structures, similar to that in forests, occurs in the oceans. These structures are produced by physical forces and result in a nested set of levels that increase in scale from turbulence, to waves, to eddies, to gyres. As in a forest, animals respond by adapting to the structure of those levels – for example, phytoplankton to fine scales, predatory fish to coarse. In oceans, however, pelagic organisms cannot control the structure of marine systems (Steele 1985, 1989). The physical properties of water and absence of fixed substrate leave no alternative except for pelagic organisms to adapt to variability imposed by physical processes.

12.1.5 Biodiversity and ecosystem functions

All concepts of diversity imply some measure of distance between the elements of a set (Weitzman 1995), but the particular measure of distance judged to be relevant depends on the significance of diversity. Some estimates of the 'ecological' value of biodiversity, for example, assume that the relative value of each species depends directly on the phylogenetic distance between species (Vane-Wright *et al.* 1991). The focus on the complementarity between the functions of species supporting critical structuring processes, over a range of environmental conditions, implies that the relevant concept of diversity is functional diversity.

While functional diversity implies a particular measure of distance between species, it is more difficult to identify and classify than other categories of diversity. This is partly because functional diversity can refer to two rather different concepts: the diversity of the ecological functions performed by different species, and the diversity of species performing a given ecological function. By the first concept it is a measure of the number of species required for a given process. By the second concept, it is a measure of the number of species supporting the structuring set of processes under different environmental conditions (Schindler 1990a). Where the issue is the relation between

Box 12.1-1: The value of the loss of functional diversity.

A major problem confronting livestock owners is the large inter-annual variation in fodder production in response to variation in rainfall. This may vary five-fold or more from one year to the next (Barnes 1979). In these circumstances economic decisions with respect to stocking and offtake levels have resulted in a significant change in the functional diversity and hence the resilience of many rangelands.

Specifically, grazing patterns have led to two major changes in the diversity of the range. The first is well documented and well understood. It involves the loss of perennial grasses and their replacement by annuals, which vary far more in response to fluctuations in rainfall. The second involves the disruption of a more subtle ecological mechanism to counteract inter-annual variation in production: a high phenological diversity in the grass sward. In systems not subject to grazing pressure there tend to be approximately even amounts of early-, mid- and late-season grasses. This means that there is about the same amount of grass able to respond to rainfall whenever it occurs in the season (Walker 1988). However, in systems subject to heavy grazing pressure, the loss of early-season palatable species means an increase in the relative amount of later-growing species (Silva 1987). Where this occurs the loss in phenological diversity means that in years of mostly early-season rains, production will be less than expected even though there may still be roughly the same amount of grass cover. The grass sward still appears to be healthy, and the average biomass is much the same. But because the functional diversity of the range has been reduced, the inter-annual variation in fodder production tends to be greatly exaggerated.

As an illustration, McNaughton (1985) has shown that in the Serengeti grasslands those communities which vary least in year-to-year production show relatively greater changes in species contribution to biomass. In other words, communities exhibiting varying species responses to a fluctuating environment tend to be most constant in terms of primary production. The same set of species are present all the time, but different species contribute to biomass at different rates depending on environmental conditions. Assuming, for purposes of illustration, that the only output of interest is the liveweight gains of stock grazing the range, the economic value of the change in diversity is readily determined from the change in liveweight gains associated with the reduction in average biomass caused by the loss of grass species.

diversity and ecosystem resilience it is the second concept that is important. But where we seek the value of functional diversity in general, it is intuitive that both things are important: the complementarity between species supporting the critical structuring processes of a system under given environmental conditions, and the range of species capable of supporting the same processes under different environmental conditions.

One of the difficulties in measuring functional diversity in the second sense is that the range of species capable of performing particular functions under different environmental conditions is not readily observable. Nevertheless, for many important cases, the value of the loss of functional diversity may be obtained by indirect methods. Box 12.1-1 illustrates this for the example of semi-arid rangelands. In general, the value of the functional diversity of species depends on the value of all of the ecological services provided by those species and the degree of complementarity between them in the provision of those services. This value depends on the range of environmental conditions over which the system may have to operate.

12.1.6 Concluding remarks

Section 12 is divided into two parts. The first part, comprising Chapters 12.2 to 12.4, discusses the methods by which economists are currently trying to uncover those

values indicated in Figure 12.1-1 that are not captured in market prices. These chapters review the state of the art on the valuation of both individual biological resources and the mix of resources in particular ecosystems and habitats. The second part, comprising Chapters 12.5 to 12.7, discusses current estimates of the value of biodiversity using these methods and draws out some of the policy implications of the section. Although the focus of the Section is on valuation and estimates of value, it is important to underline the point that valuation is interesting only as an adjunct to policy. It is important to understand the value of individual resources and the mix of resources if we are to understand how much biodiversity should be conserved. But there is no merit in valuation for its own sake.

The main points to be kept in mind in reading these chapters are the following.

- The **proximate causes** of excessive biodiversity loss are to be found in harvesting, land conversion, and pollution activities. The **underlying causes** are to be found in the incentives to individual users of biological resources to ignore the effects of their behaviour on the rest of society, i.e. the **private** and **social** value of resource use differ.
- The **private value** of a biological resource in some use is the value of the opportunities forgone by the user:

its **private opportunity cost**. The **social value** of the same resource, its **social opportunity cost**, is the value of the opportunities forgone by society as a whole.

- The value that individuals and societies place on the conservation of biodiversity is measured by their willingness to forgo the benefits of alternative uses for the same resources. This is reflected in one of two measures: a measure of their **willingness to pay** to acquire a benefit or satisfy some rule or code of behaviour, or their **willingness to accept** compensation for the loss of a benefit.
- Willingness to pay or willingness to accept compensation vary with the **preferences, culture, ethical values** and **world views** as well as the **technology** available to individuals and societies.
- Willingness to pay or willingness to accept compensation is also highly sensitive to **income**. Poor people are willing to pay less for biodiversity conservation than rich people, not because they necessarily care less, but because they have fewer resources. Poor people are also less able to command the information needed to understand the long-term benefits of conservation, and to accept the short-term sacrifices needed to realize those benefits. They have fewer options.

12.2 Use and non-use value

12.2.1 A typology of values

The preceding chapter observed that biological resources and the diversity of those resources have both use and non-use value. This chapter reviews what is currently understood about each type of value. In the treatment of use value a distinction is drawn between the value of the mix of species in (a) supporting one or more organisms (the value of habitat) and (b) supporting the provision of the economically interesting range of ecological services (the value of ecosystem functions). Use values include, as we have seen, both direct and indirect values. Direct use values are the values derived from direct use or interaction with a biological resource or resource system. In contrast, the indirect or derived value of biological resources and ecological systems stems not from direct interaction or use but from the role of these resources and systems in supporting or protecting economic activity. The main objective of attempts to estimate the use value of habitats and ecological systems is, in fact, their indirect value.

The concept of indirect value implies that even though some organisms have no immediate use in consumption they may be necessary to the production of organisms that do have an immediate use. For example, forest litter

invertebrates may not be used themselves, but may be essential to the regeneration of forests from which timber is extracted. Trees and forest litter invertebrates, in this example, would be said to be complementary inputs in the production of timber. As inputs, both derive value from the value of timber produced. The value of trees is direct. They are the immediate source of timber. The value of the litter invertebrates is indirect. Their various functions contribute to the growth of trees. Hence, whether the end users of timber recognize the value of litter invertebrates or not (whether they are priced in the market or not), any actions that interfere in the functions performed by litter invertebrates will involve costs in terms of timber forgone.

The typology described in Chapter 12.1 (Figure 12.1-1) distinguishes between two types of use value and two types of non-use or passive use value in nature. Neither form of use value is in itself controversial, but a substantial debate has been in progress for some time over the meaning and significance of non-use or passive use value in nature. Some environmental philosophers (biocentrists) have interpreted this value as 'inherent worth': an intrinsic value that is completely separate from the human–environment valuation relationship. According to this position non-human biota, and perhaps even non-sentient things, have moral interests or rights to existence (Turner *et al.* 1994; Turner and Pearce 1993). An extreme version of bioethics would make environmental rights absolute and therefore not open to trade-offs on the basis of a 'deep ecology' meta-ethical principle. Use values, on the other hand, are relative and linked to individuals and their preferences or needs. Hence, if more biodiversity conservation is chosen the opportunity to satisfy other preferences or needs is foreclosed. So all resource allocation policy decisions incur opportunity costs (i.e. forgone alternatives). Thus the use value of biodiversity is not absolute, it is relative and as such can be balanced (in a cost–benefit assessment) against other 'good' things or 'worthy' causes that individuals may want to use or support.

An important point in this context is therefore whether individuals treat environmental services as 'commensurable' with ordinary produced goods and services. Sagoff (1988), for example, claims that they do not, and argues that social decision-making should not be based on commensurability (see also Blamey and Common 1994). A majority of environmental economists would argue that such commensurability does exist, as long as the overall life-support regulatory functions of the environment are not threatened.

It is not, however, necessary to ascribe absolute value to environmental conservation/preservation in order to provide more safeguards against biodiversity loss than currently exist. Such extra safeguards could be justified in terms of 'Q-altruism' motivations (Randall 1991; Randall

and Stoll 1983). Here, moral principles recognizing the 'interests' of non-human species and their supporting habitats could be used to buttress a case for extra, but not unlimited, sacrifices incurred to better safeguard biodiversity. The values expressed are still anthropocentric but relate to the perceived interests of other species. Bequest motivations underpinned by an inter-generational equity concern would add further support to biodiversity conservation enhancement.

The largely philosophical debate over the need for and composition of an adequate environmental ethic has become rather sterile. This is the case because the discussion has focused on use value versus non-anthropocentric intrinsic value in nature, i.e. relative versus absolute valuations. In the real world of pragmatic policy-making the instrumental–intrinsic distinction is usefully maintained only if it is interpreted solely in an anthropocentric (human centred) way. Thus a case for biodiversity conservation should be supported not only on the grounds of the significant amount of human use value that is at stake, but also because this allows society to set things aside (Pearce *et al.* 1990; Turner 1993) and exempt them from use. According to Hargrove (1992) this would reflect 'our desire as individuals, as a society, and as a historically evolved culture to value some things non-instrumentally and to set them aside and protect them from exploitation'. The question then becomes what 'things' should be set aside and should this be at any cost?

The motivations behind non-use or passive use value are some combination of: individuals; perceived benefits; altruism towards friends, relatives or others who may be users (vicarious use value); altruism towards future generations of users (bequest value); and altruism toward non-human nature in general (existence value). But several questions remain to be answered, including what precisely is meant by altruistic motives and behaviour and which values involve use of the resource and which do not. We do not yet have anything like a full picture of the mutually exclusive set of motivations underlying individual preferences for environmental goods.

All altruistic motivations involve improvements in an individual's welfare. According to Kahneman and Knetsch (1992a) altruism is thus no more than the purchase of moral satisfaction, a 'warm glow effect', and is a self-regarding motivation. On the other hand, existence value has been argued to involve a moral 'commitment' (Sen 1977) which is not in any way all self-interested. Commitment can be defined in terms of a person choosing an act that he or she believes will yield a lower level of personal welfare to him/her than an alternative that is also available. The person does not directly desire to reduce their own welfare, but that adherence to one's moral commitments will be as important as personal economic welfare maximization and may conflict with it. Thus the human valuer recognizes an

intrinsic 'moral resource' value in non-human nature and is prepared to give up scarce resources to conserve such nature, even though no use or *in situ* contact is contemplated. They are also unlikely to accept compensation for the loss of environmental resources, especially if the resources have the characteristics of uniqueness and non-substitutability. According to Sagoff (1988) this is because individuals are here acting as citizens and not consumers. Clearly there are difficult theoretical and philosophical issues so far left unresolved in the non-use valuation debate. The citizen/consumer dichotomy, for example, is far from clear cut, and operating in citizen mode does not have to preclude recognition of the economic costs and benefits involved. The results of empirical studies of the existence value of a range of biological resources (reported in Chapter 12.5) indicate just how wide a variation in response has been observed, and this reflects on at least some of these issues.

12.2.2 Value, ethics and equity

The costs of biodiversity loss and consequent ecological degradation are not distributed equally. Biodiversity loss raises issues of both intra-generational and inter-generational equity. The poorest individuals and societies often face the largest relative losses from biodiversity loss and ecosystem degradation. Many low- and lower-middle income developing countries are very dependent on natural resources (both in their domestic economic activities and in their export trade) (Barbier 1994a). For most low-income economies a sustainable development path requires careful management of the natural resource base so that 'natural' capital is not over-depreciated and future economic progress inhibited. A further worrying trend in developing economies is the concentration of the poorest groups in 'ecologically fragile' zones – areas where environmental damage threatens economic welfare (Barbier *et al.* 1994). This means that the poorest income groups tend to be at the greatest risk from the effects of biodiversity loss. Because the underpinning ecosystems in these areas are relatively less resilient, the problems of threshold effects, ecosystem collapse and scarce resources may be particularly severe for these poor households.

Similarly, any change in biodiversity that affects ecological functioning and resilience has implications for future generations (an inter-generational equity concern). The conversion and modification of ecosystems by the current generation may mean that 'less' biodiversity is available for future generations. The current generation may be making future generations unavoidably worse off by reducing the opportunities available to them. This may increase the cost of maintaining ecosystem functions.

The Brundtland Report argued that, 'Humanity has the ability to make developments sustainable – to ensure that it meets the needs of the present without compromising the

ability of future generations to meet their own needs' (WCED 1987). By this criterion, where biodiversity loss is unavoidable, future generations should be compensated for any costs they incur. The mechanism by which the current generation can ensure that the future is compensated, and is not therefore worse off, is the transfer of capital (including natural biodiversity). To anticipate the conclusions of the section, it is worth noting that the inter-generational equity goal can be achieved by strategies aimed at fostering an efficient, diversified and ecologically sustainable economy; by maintaining natural capital stocks, and in particular 'critical' natural capital that is non-substitutable and therefore the loss of which is irreversible (i.e. a 'constant capital' rule); by adopting safe minimum standards and the precautionary principle which suggests 'risk averse' behaviour in the face of uncertainty and lack of full scientific knowledge; and finally by adopting policies that enhance ecological, social and economic diversity so that the next generation is left with an equivalent resource endowment (allowing for some trading between different forms of capital) and opportunities for social and economic activity (Young 1992, 1993).

The ethical argument at the core of the inter-generational equity proposition is that future generations have a right to expect an inheritance (capital bequest) sufficient to allow them the capacity to generate for themselves a level of well-being no less than that enjoyed by the current generation. The requirement is therefore for an inter-generational social contract that guarantees the future the same 'opportunities' that were open to the past. Philosophers have put forward two ethical positions which can be seen as supportive of the constant natural capital rule (although they would also buttress a constant capital rule given smooth substitution between the different forms of capital). The first is known as the 'Lockean Standard' view, after the philosopher John Locke. This lays down that each generation should leave 'enough and as good for others'. A more modern view, known as the 'justice as opportunity' view, holds that the present generation does not have a right to deplete the economic and other opportunities afforded by the resource base. Since the resource base cannot literally be passed on 'intact', what is proposed is that future generations are owed compensation for any reduction (caused by the current generation) in their access to easily extracted and conveniently located natural resources. If justice is to prevail, the future's loss of productive potential must be compensated for (Page 1992; Pasek 1993).

Bequest value may be particularly significant for populations local to an ecosystem or natural environment who currently enjoy many of its benefits. Such individuals tend to want to see their way of life or intimate association with the ecosystem ('a sense of place') passed on to their heirs and future generations in general.

Bequest motives have not been seen as 'core values' in the conventional economic model. Nevertheless, a minority of economists have long suggested that the self-interested model of human behaviour is too simplistic (e.g. Harsanyi 1955; Sen 1977). Various forms of self-serving and social altruism have also been modelled by economists (Collard 1978; Margolis 1982; Sugden 1984; Andreoni 1990) and must in some sense be necessary for existence value to be present. Charity contributions and voluntary work are also evidence that self-interest and free riding need not be the only human traits. It also seems likely that peer group and local community 'pressures' influence charitable behaviour within the constraints of prices and individual income levels. Andreoni's (1990) analysis of charitable donations as private benefits and the 'warm inner glow' effect has been used by Kahneman and Knetsch (1992a, b) to suggest that these contributions are a substitute source for the services linked to the non-use environmental values. But Smith (1993) has countered that if people have 'warm glow' and altruistic motives for charity-giving, all that means is that charity is a mixed public/private good.

Bequest motivation and value related to biodiversity conservation fit neatly into the 'justice as opportunity' view. The basic argument is 'contractarian' in philosophical terms. The philosopher John Rawls has used contractarian philosophy in order to formulate principles of justice chosen by rational and risk-averse individual representatives from contemporary society in an 'original position' (the negotiations) and generating from behind what he calls a 'veil of ignorance' (i.e. individuals are assumed not to know to which stratum of society they themselves belong). The contractarian approach is therefore based on actual or hypothetical negotiations that are said to be capable of yielding mutually agreeable principles of conduct, which are also binding upon all parties. One of the principles that Rawls derives is known as the 'difference principle' or maximin criterion. What it boils down to is the guarantee of an acceptable standard of living for the least well off in contemporary society (Rawls 1972). Other writers have since sought to place the maximin criterion in an inter-generational context (Page 1983; Norton 1989). In this context the rule becomes one of passing on over time an 'intact' resource base. The constant capital assets rule, or the constant natural capital assets rule, would therefore be relevant to this inter-generational equity case (Pearce *et al.* 1991, Ch. 11).

12.2.3 Social and cultural differences in the perception of value

It should be noted that both sides of the ethical debates over bequest and existence values are grounded in a particular world view that has emerged but recently in human history – i.e. some 6000 years ago with the establishment of towns in fertile river valleys under settled

cultivation (Lenski and Lenski 1978). In what follows we indicate how this view differs from others that have existed in the past and that still exist in some societies. This world view is characteristic of large-scale societies, heavily dependent on resources brought from considerable distances. It is a world view that is characterized by the denial of sacred attributes in nature, a characteristic that has its roots in Greek philosophy, and became firmly established about 2000 years with the Judaeo-Christian-Islamic religious traditions (White 1967).

For much of human history, people have lived in small-scale, kin-based societies; attempting to obtain a subsistence from their immediate surroundings. All of humanity lived in such societies of hunter-gatherers or horticulturalists until the beginning of irrigated agriculture 6000 years ago. Much of the Earth's surface was still covered by them until the European expansion beginning five centuries ago. (Crosby 1986; Cavalli-Sforza *et al.* 1994). It is only now that such societies are finally disappearing (Lee and DeVore 1968; Diamond 1992). The world view of such societies tends to be strikingly different from the modern world view. In particular, the values assigned by such societies to biodiversity are grounded on very different premises.

The stylized facts are as follows. In such societies a relatively small number of people, many of them related to each other, tend to be in face-to-face contact over long periods, often their whole lifetimes. Their relationships to each other are moulded by ties of altruism and reciprocal help (Trivers 1971; Wilson 1978). With hunting, gathering, fishing and low-input agriculture and animal husbandry as the mainstay of subsistence, the people are also closely tied to the natural resources of their immediate environments. They therefore tend to view themselves as members of a community that not only includes other humans, but also plants and animals as well as rocks, springs and pools. People are then members of a community of beings – living and non-living. Their relationships with other community members, be they trees, birds or mountain peaks are moulded by the relationships with other human members of the communities, as recipients of altruistic or mutualistic favours. Thus rivers may be viewed as mothers; the Ganges of India is Gangamai, mother Ganga to inhabitants of the Gangetic plains, and has probably been viewed so for millennia. Animals may be treated as kin; thus antelopes are brothers to the followers of the Bishnoi sect of Rajasthan and Haryana in northwestern India (Sankhala and Jackson 1985). The Koyukan people of Alaska believe that the key to the success of a good bear hunter lies in the respect he shows towards his victims (Nelson 1993).

The manifold restrictions and taboos on the way nature is to be treated (grass burnt, honey collected or deer hunted) are an expression of respect for other non-human members of the community of beings.

Anthropologists have documented such practices; that they are a significant component of the ways in which hunter-gatherer-subsistence cultivator-pastoral people relate to their environment is widely acknowledged (McNeely and Pitt 1985). What is disputed is whether such respect, such restraints, are best viewed as irrational, superstitious practices with no significant implications for conservation of biodiversity, or whether they are to be viewed as practices evolved by societies through a long-term process of trial and error actively to promote sustainable use of biological resources and conservation of biodiversity. In favour of the first view is the mounting evidence of many extinctions of larger birds and mammals by hunter-gatherer-horticulturalist colonists of the Americas, Madagascar, New Guinea, New Zealand and the Polynesian islands (Diamond 1994). But, such extinctions by new colonizers may also be reflections of a long period of striking roots in a locality and of gradual accumulation of experience of how nature responds to human use that must elapse before societies can culturally evolve effective traditions of restraints on resource use (Gadgil and Guha 1992; Gadgil, Berkes and Folke 1993; Gadgil 1995). Thus the early settlers of Madagascar were probably responsible for extinction of some of the largest species of lemurs, but the remaining species then came to be treated as sacred animals, protected against hunting, and so survived to the modern times when the influence of Christianity led to the gradual loss of traditional protection (Jolly 1980) (see Section 11.1.2 for further discussion). Indeed, on balance it appears reasonable to conclude that the many restraints on the use of natural resources that include protection everywhere to keystone resource species such as fig trees protection to highly susceptible stages such as birds breeding communally at a heronry, and protection to entire biological communities of sacred sites such as sacred groves or ponds, may have evolved culturally in response to the need to ensure more sustainable use of biological populations and conservation of biological diversity (Gadgil and Berkes 1991) (also see Sections 11.1, 11.2 and 13.6 for further discussion).

Nelson (1993) and Diamond (1993) have observed that such restrictions on the use of natural resources are often against the short-term interests of individuals – as are environmental regulations in modern societies. There exists, therefore, a private incentive to flout such social conventions, to violate the taboos, and this cannot be contained solely by respect for non-human fellow members of a community of beings. Compliance in such societies is typically assured through two devices: fear of the wrath of offended nature spirits and social sanctions against offenders. Thus traditionally Gangtes, a group of shifting cultivators in the state of Manipur in northeastern India, feared that violation of taboos against cutting of sacred groves may lead to illness or death, even if no other

humans detect the violation. If, however, other group members detected the violation, the offender had to sacrifice a pig to placate the nature spirit; the pig was then shared in a feast with all group members (Hemam and Gadgil, pers. obs.).

Unlike the modern world view people living in such communities do not see the world, living or non-living, natural or artificial, as a warehouse of commodities. They do not see themselves as free to so deploy resources at their disposal as to maximize the satisfaction obtained from enjoyment of such commodities. Rather they value plants, animals, other natural elements as deserving of respect by people, and are afraid of adverse consequences if they violate culturally prescribed norms as to how these non-human elements are to be treated.

This approach came to be rejected as large-scale societies developed following intensification of agriculture and the emergence in society of groups no longer dependent on the natural resources of any particular locality. Such groups have little motivation to ensure sustainable use of the biological resources of any given locality, since they have the option of drawing on the resources of other localities, or of substituting less for more scarce resources (Gadgil and Guha 1992).

Large-scale societies dominated by such groups slowly came to embrace a new world view, and a new value system. This perspective, especially as elaborated in the Judaeo-Christian tradition, set humans not as part of a wider community of beings, but apart. It came to view nature as totally dedicated to the fulfilment of human wants, at the pleasure of people (White 1967). Eastern cultures with religious traditions such as Buddhism, Jainism and Hinduism did not depart as drastically from the perspective of humans as members of a community of beings including other living and non-living elements. So Hindus continue to protect primates, permitting the survival of tens of thousands of *Macaca radiata*, *Macaca mulatta* and *Presbytis entellus* in the thickly settled countryside of India. This countryside is also dotted by hundreds of thousands of *Ficus religiosa* trees. Buddhist shrines in southeast Asia have temple groves attached to them, as do Shinto shrines in Japan. This does not at all mean, however, that these Asian societies have not permitted large-scale erosion of their biological diversity, whether in India or Thailand (Lohmann 1991; Gadgil and Guha 1992).

Societies dominated by Islam, and especially by Christianity, have gone farthest in setting humans apart from nature and in embracing a value system that has converted the world into a warehouse of commodities for human enjoyment. In the process, not only has nature lost its sacred qualities, but most animal species that have a positive symbolic value in other human cultures have acquired very negative connotations in the European culture (Lawrence 1993). Conversion to Christianity has

meant an abandonment of an affinity with the natural world for many forest dwellers, peasants, fishers all over the world (Caulfield 1984). The northeastern hill states of India bordering China and Myanmar supported small scale, largely autonomous shifting cultivator societies until the 1950s. These people followed their own religious traditions which included setting apart between 10 and 30% of the landscape as sacred groves and ponds. Most of these people were drawn into the larger market economy and converted to Christianity by the late 1950s. On so converting to a religious belief system that rejects assignment of sacred qualities to elements of nature, they began to cut down the sacred groves, to bring the land under cultivation, as well as to market rattan and timber. However, they gradually discovered that this led to serious difficulties, especially as the fires set during the slash-and-burn cycle now often spread to their settlements, burning down houses. Many of these people have therefore re-established the sacred groves, although now they are termed safety forests instead (Malhotra 1990; Hemam and Gadgil, pers. obs.). The system of social sanctions against violation of these newly instituted safety forests is, however, identical to that which supported the protection of sacred groves in pre-Christian times. There are many other examples of spontaneous reassertion of protection to forest tracts by local tribal and peasant communities in other parts of India as well.

The establishment of protected areas is the modern equivalent of this. In modern societies, as in traditional ones, protected areas serve the longer-term interests of the members of society. The difference between them lies in the way in which nature is regarded, and in the trade-offs that are regarded as permissible. That is, the difference lies in the beliefs and traditions that determine how nature is regarded in each. Some, however, would argue that these differences may not be fundamental. Indeed Wilson (1984, 1993) believes that humans have an inherent inclination to affiliate with life and life-like processes and that these innate tendencies may be a basis for an appropriate ethic of care and conservation of nature, especially the diversity of life.

12.2.4 Use value: species versus habitats

In all societies, the most visible economic value of biological resources arises from the use of domesticated and wild resources in production and consumption. Such direct uses of biological resources comprise both consumptive uses, e.g. through agriculture, hunting, fishing, grazing or harvesting, etc., and non-consumptive uses, e.g. through recreation, tourism or research and education. Thus, as the names imply, consumptive uses usually entail the exploitation and harvesting of domesticated and wild resources in the production and consumption of economic 'goods', whereas non-consumptive uses can be classified as economic 'services' provided by these resources.

Domesticated biological resources are also an important source of direct use value in many production and consumption activities, including agriculture, mariculture, plantation forestry and tree crops, livestock rearing and pharmaceuticals. In most of these uses, the initial 'genetic material' may originally have been derived from wild resources; however, thanks to modern breeding methods, biochemistry, research and development efforts, the potential uses of 'domesticated' biological resources and material are multiplied and the productivity gains vastly increased. Later chapters in this section report estimates of a range of direct-use values of domesticated biological resources.

However, this is not to say that the 'pool' of domesticated biological resources and genetic material is now, or will ever be, completely independent of the stock of wild resources. There is mounting concern that *ex situ* conservation – the use of zoos, botanic gardens, breeding programmes, germplasm 'laboratories', gene or seed banks and other methods of maintaining species and genetic stocks away from their natural habitats – is not sufficient for sustaining all the domesticated biological resources that we require. For example, Weissinger (1990) stresses the importance of *ex situ* conservation through germplasm technologies in maintaining genetic diversity, but he also acknowledges that such methods cannot conserve the whole range of an organism's diversity; rather they preserve a sample of it. Moreover, this sample is necessarily incomplete. It represents only a portion of the population at the moment of its extraction. This implies that we may not know all the 'useful' properties of wild resources and that we may need to augment continually our existing stock of domesticated resources, genetic material and varieties through appropriating more biological 'raw material' from organisms and their habitats.

Some components of the direct value of such species have already been indicated, including their potential to sustain and improve agriculture; to provide opportunities for medical discoveries and industrial innovations; and to preserve choices for addressing as yet unforeseen problems and opportunities for future generations. Genes transferred to domestic crop plants from their wild relatives can increase yields, improve quality, provide resistance to pests and diseases, extend growing ranges, permit wide hybridization between crop species or between them and related wild species and so on. The major reserve of genetic diversity necessary for the development (and biological protection) of future agricultural plantation and forest crops for the humid tropics resides in the natural forests.

The case for focusing on habitats rather than species is very strong, even if one is interested only in the genetic pool. Indeed, the conservation of biological diversity in the tropics is largely a matter of conserving entire habitats rather than individual species of flora and fauna (Whitmore 1990; Terborgh 1992). First, given the multiplicity and

diversity of species in habitats such as tropical forests and coral reefs there are economies of scale in protecting several species concurrently: the opportunity cost of protecting additional species once one is protected are very low or zero if their habitat is co-terminous. While some species may be more vulnerable than others and require extra protection, by and large, the (marginal) costs of protecting additional species fall precipitously once a habitat is protected for the preservation of one species. Conservation of biological diversity is a public good not only from the standpoint of the beneficiaries but also from the standpoint of the species themselves! (You cannot protect one without protecting others which share the same habitat). The importance of recognizing this fact is that the additional benefits accrued from the conservation of all or most of the species in a habitat may justify the conservation of larger areas, which increases the probability of survival under unfavourable natural conditions, such as changes in temperature and rainfall, and anthropogenic impacts such as air pollution, acid rain and encroachment.

A second reason why conserving habitats is preferable to conserving species is that we are not certain which species are likely to turn out to be the most valuable or for that matter valuable at all. Habitat conservation has an information or quasi-option value in that it keeps our options open until more information becomes available.

A third reason is the complexity of interactions and mutual interdependence among species in tropical habitats, together with our limited understanding of these interactions. This makes it necessary to protect many species to ensure the protection of one. Thus, even if we are not interested in certain species directly as an end in themselves, we may still have to protect them as a means to protecting the species we are interested in. Since these other species are themselves dependent on yet other species for survival, soon the need for the protection of the entire habitat becomes inevitable. The conservation of biological diversity is a joint production function with many protected species as its joint inputs and outputs. The larger the number of species protected, the higher is the probability of survival of the particular species we want to protect. At the limit, full protection of the entire habitat maximizes the probability of survival, assuming that we know enough to delineate the habitat area and that no shifts in habitat take place due to climate changes such as global warming. The interaction of ecological and economic factors would determine the cut-off point between 'critical' and 'non-critical' habitats.

A fourth reason is the relatively narrow range of habitats of several tropical species and the irreversibility of destruction of tropical habitats. Severe modification of a limited number of fragile habitats is likely to result in massive extinction of species since both the capacities of the species to adapt to a new environment and of habitats to

recover their original ecosystem are severely limited. This contrasts with many temperate species which tend to have wide ranges of latitude, temperature and moisture regimes and to exist in habitats that tend to be less fragile than tropical habitats and easier to rehabilitate or 'recreate'. The implication is that for tropical biodiversity conservation a quasi-option value should be imputed to the avoidance of irreversible destruction or severe modification of 'critical' habitats rather than to the (temporary) protection of individual species from extinction. If we knew which species would become valuable and we could protect them *ex situ*, the opportunity costs would have been substantially lower, but we do not have that 'luxury'.

A final reason for adopting a 'habitat' rather than a 'species' approach to the conservation of tropical biodiversity anticipates the next Section. It is the associated non-biodiversity benefits from habitat preservation, such as watershed protection, harvesting of non-timber forest products and attraction of recreational and scientific tourism (Panayotou and Ashton 1992). These are joint products of habitat conservation but not of species conservation *per se* except for the latter to some degree. In this sense, biodiversity conservation may be thought of as a joint production function with joint inputs and joint outputs. These joint products are of particular importance as a source of livelihood and foreign exchange to developing countries and hence a more compelling reason for conserving biodiversity than the protection of individual species. While the latter is a primary object of biodiversity conservation from the standpoint of developed countries, it is only a by-product from the standpoint of developing countries; it is an added benefit to the host country only to the extent that the ensuing global benefits can be captured through tourism, royalties or international transfers (Panayotou 1992). Carbon sequestration is an additional global by-product of habitat preservation for the purpose of protecting biodiversity that may or may not be internalized to the developing country that hosts tropical forests. However, the adoption of a habitat approach to species conservation does internalize a significant portion of the benefits to the host country through watershed protection, sustainable production of non-timber forest products and enhanced opportunities for local and international tourism. Consideration of these additional benefits has three implications: (a) the conservation of a larger area maybe justified, (b) a somewhat different mix of conservation areas may be chosen to include critical watersheds, tourist attractions, etc. thereby reducing the opportunity costs of conservation, and (c) the motivation of the host country to set aside and protect habitats is thereby enhanced.

For a combination of ecological and economic reasons, therefore, biodiversity conservation in the tropics is a matter of identifying and protecting critical habitats.

However, setting aside land as protected habitat for the conservation of biodiversity and other associated benefits has significant opportunity costs in terms of forgone benefits from alternative land uses. Hence it is necessary to value both the benefits from habitat conservation and the opportunity cost to determine the demand and supply price of biodiversity and the optimum level of biodiversity conservation.

12.2.5 Use value: habitats versus ecosystems

The conservation of individual species implies the conservation of their habitats. But the value of ecosystems extends well beyond their role as habitat for particular species. In what follows we consider how the biodiversity in an ecosystem is related to the provision of the full range of ecological services for which that system may be valued. Since biodiversity, like habitat, is a public good, it is notoriously difficult to obtain reliable statements of willingness to pay for its conservation. This shows up in the value estimates reported later in this section. However, we can leave this problem to one side for now, focusing on the source of the derived value of the mix of species in the provision of ecosystem services.

Our starting point here is the idea that the use value of the composition of species lies in its role in maintaining the flow of services obtained from an ecosystem over a range of environmental conditions. This requires the specification of an appropriate 'production function' describing the relationship between inputs and outputs (Smith 1991; Perrings *et al.* 1993). Specifically, it requires that the individual species in an ecosystem are conceptualized as inputs to the production of useful goods and services. Their value, like the value of other inputs, derives from the value of the goods and services they support. If an output depends on the contribution of a different set of organisms under one possible state of nature than it does under another, and if the output has value under both states of nature, then both sets of organisms will have derived value. The use of this approach requires an analysis that is as much ecological as it is economic. The ecological analysis is needed to identify the role diversity plays in maintaining the structure and function of ecosystems. The economic analysis is needed to derive the value to individuals and societies of the function of ecosystems in the production of goods and services from this information. Both analyses are necessary.

One of the major 'risks' associated with the loss of biodiversity is that present ecosystems and ecosystem processes might be transformed into new configurations with unknown consequences for human welfare. To the extent that biodiversity supports ecological services in the face of variable environmental conditions it has indirect value: the value of ecological resilience. Note that resilience has a very particular meaning here. It is a measure of the magnitude of disturbance that can be

absorbed before the system changes its structure by changing the variables and processes that control behaviour. Such changes – from forest to grassland, from savannah to shrublands, from grassland to desert, for example – reflect a loss of structural resilience (implying an increase in the vulnerability of the system to variability in environmental conditions and a loss of predictability).

This differs from the traditional concept of resilience in ecology discussed in Sections 5 and 6, though both refer to properties of the stability of a system. Resilience in the traditional sense is a measure of resistance to disturbance and speed of return to the equilibrium state of an ecosystem (Pimm 1984; O'Neill *et al.* 1986). This may be called 'equilibrium resilience'. The term as it is used in the previous paragraph may be termed 'structural resilience'. In contrast to equilibrium resilience, it measures the limits of the stability of a system, and may be defined for any state of that system, however far from equilibrium (Holling 1973). The consequences of those different aspects were first contrasted by Holling (1973) for ecological systems, in order to draw attention to the paradoxes between efficiency and persistence, constancy and change, order and disorder. In ecological systems characterised by hierarchical structures, each with distinct spatial and temporal frequencies, and with different abiotic and biotic processes that control different functional states, structural resilience may be the more relevant concept.

The value of biodiversity from this perspective lies in the role of the composition of species in maintaining the critical processes of terrestrial ecosystems (where most of the threat to biodiversity lies) over a range of states of nature. This reflects the emergence of a consensus among a subset of community and systems ecologists who deal with regional-scale systems and the interactions of processes across scales. This consensus identifies three propositions concerning the structure and dynamics of terrestrial ecosystems: that the diversity and complexity of ecological systems can be traced to a small set of biotic and abiotic processes, each operating over different scale ranges (Holling 1992; Holling *et al.* 1995); that animals and plants can shape their ecosystems (Schindler 1977; McNaughton *et al.* 1988); and that species dynamics (and so biodiversity) tend to be more sensitive to stress than are ecosystem processes (Schindler 1990b; Vitousek 1990). Despite a background of disagreement about the role of ecosystem complexity in ecosystem stability, this has led this subset of community and systems ecologists toward the view that there does exist a reasonably well defined relationship between functional diversity and ecosystem resilience. In supporting ecosystem resilience the functional diversity of species provides a means of minimizing the risks of fluctuating environmental conditions. Biodiversity conservation may therefore be thought of as a means of managing uncertainty, and hence the value of biodiversity includes a significant insurance component.

There is, however, a dynamic interdependency between economy and ecosystem. The properties of biophysical systems are part of the constraints set which bounds economic activity. The constraints set is linked to economic activity which is exploiting environmental assets (extraction, harvesting, waste disposal, non-consumptive uses) and feedbacks then occur which influence economic and social relationships. As the evolution of the economy and the evolution of the constraints set are interdependent, 'co-evolution' is thus a crucial concept (Common and Perrings 1992).

Norton and Ulanowicz (1992) advocate a hierarchical approach to natural systems (which assumes that smaller subsystems change according to a faster dynamic than do larger encompassing systems) as a way of conceptualizing problems of scale in determining biodiversity policy. For them, the goal of sustaining biological diversity over multiple human generations can only be achieved if biodiversity policy is operated at the landscape level. The value of individual species, then, is mainly in their contribution to a larger dynamic and significant financial expenditure may not always be justified to save ecologically marginal species. A central aim of policy should be to protect sufficient 'chunks' of ecosystem necessary to maintain the system's functioning, rather than individual species conservation *per se*.

Ecosystem health (stability and resilience or creativity), interpreted in terms of an intuitive guide, is useful in that it helps focus attention on the larger systems in nature and away from the special interests of individuals and groups (Norton and Ulanowicz 1992). The full range of public and private instrumental and non-instrumental values all depend on protection of the processes that support the health of larger-scale ecological systems. Thus when a wetland, for example, is disturbed or degraded, we need to look at the impacts of the disturbance on the larger level of the landscape. A successful policy will encourage a patchy landscape.

The 'integrity' of an ecosystem is more than its capacity to maintain autonomous functioning (its health): it also relates to the retention of 'total diversity' (Norton 1992), i.e. the species and interrelationships that have survived over time at the landscape level. A number of ecological services and functions can be valued in economic terms, while others cannot because of uncertainty and complexity conditions. Taking wetlands as our example, these systems provide a wide array of functions, services and goods of significant value to society – storm and pollution buffering, flood alleviation, recreation and aesthetic services, etc. We can therefore conceive of 'valuing' a wetland as essentially valuing the characteristics of a system. Since it is the case that the component parts of a system are contingent on the existence and continued proper functioning of the whole, then putting an aggregate value on wetlands and other ecosystems is quite a complicated matter.

Economic values may not capture the full contribution of component species and processes to the aggregate life-support functions provided by ecosystems (Gren *et al.* 1994). Furthermore, some ecologists argue that some of the underlying functions of ecological systems which are basic to the ecological functions cannot be taken into account in terms of economic values. Total Economic Value will therefore underestimate the true value of ecosystems. The prior value of the ecosystem structure has been called 'primary value' and consists of the system characteristics upon which all ecological functions depend. Their value arises in the sense that they produce functions which have value (secondary value). The secondary functions and values depend on the continued 'health', existence, operation and maintenance of the ecosystem as a whole. The primary value notion is related to the fact that the system holds everything together (and is thus also referred to as a 'glue' value) and as such has, in principle, economic value. This is unmeasurable in terms of consumer preferences and so the social value of an ecosystem exceeds the sum of the values of the individual functions (Turner and Pearce 1993). It can also be argued that a healthy ecosystem contains an ecological redundancy capacity and there is thus an 'insurance' value in maintaining the system at some 'critical' size in order to combat stress and shocks over time.

12.2.6 Concluding remarks

To summarize:

- The direct use value of biological resources derives from their direct role in consumption or production. Agriculture, forestry and fisheries are all based on the direct use value of foods and fibres.
- The indirect use value of biological resources stems from the fact that they are necessary to the production of resources which have direct use value.
- The value of the mix of biological resources, biodiversity, is an indirect use value. It derives from the role of the mix of species in (a) supporting one or more organisms (the value of habitat) and (b) supporting the provision of the economically interesting range of ecological services (the value of ecosystem functions).
- The value of ecosystem functions is sometimes referred to as a secondary value, in contrast with primary value – the value of the system characteristics upon which all ecosystem functions depend.
- The non-use or passive use values of biological resources derive from: altruism towards friends, relatives or others who may be users (vicarious use value); altruism towards future generations of users (bequest value); and altruism toward non-human

users (existence value). It may often be framed by the individual either in terms of rights assigned to others or in terms of codes of behaviour.

- The social value of an ecosystem exceeds its private or market value as conventionally calculated because of the following factors:
 1. The full complexity and coverage of the underpinning 'life-support' functions of healthy evolving ecosystems are currently not precisely known in scientific terms. A number of indirect use values within systems therefore remain to be discovered and valued.
 2. Because the range of secondary values (use and non-use) that can be (in the main) instrumentally derived from an ecosystem is contingent on the prior existence of such a healthy and evolving system, there is in a philosophical sense a 'prior value' that could be ascribed to the system itself. Such a value would not, however, be measurable in conventional economic terms and is non-commensurate with the economic (secondary) values of the system.
 3. The continued functioning of a healthy ecosystem is more than the sum of its individual components. There is a sense in which the operating system yields or possesses 'glue' value, i.e. value related to the structure and functioning properties of the system which hold everything together.
 4. A healthy ecosystem also contains a redundancy reserve, a pool of latent keystone species/processes which are required for system maintenance in the face of stress and shock. Both factors 3 and 4 could, in principle, be valued.

Estimation of the total value of wetlands, forests, etc. involves complex problems to do with system boundaries, scale, thresholds and value component aggregation. Given the inevitable uncertainties involved, a precautionary (risk averse) approach based on maximum ecosystem conservation is a high priority. So in this sense the primary value concept (in terms of value dimensions 1, 3 and 4 above) is directly relevant to the conservation versus development policy debate. A 'healthy' ecosystem is seen as being valuable beyond benefits that can be computed simply in terms of consumptive preferences. Self-organizing systems maintain a degree of stable functioning across time. They provide a sufficiently stable context to which human individuals and cultures can adapt their practices. Ethically it could be argued that sustainability could be interpreted as requiring that no

generation has a right to destabilize the self-organizing systems that provide the context for all human activity and therefore possess 'primary' value (Costanza *et al.* 1992).

This does not, however, mean that all environmental assets have unmeasured value and therefore all assets should be protected. Rather it is the on-going 'healthy' system that possesses primary value and this requires biodiversity conservation at the landscape scale. There is still, however, the thorny problem of actually deciding, on a rational basis, the 'scale' from which to manage environmental public goods. The 'scale' choice problem is in fact a public policy decision and as such is underdetermined by the mere provision of scientific information. Available scientific information contains inaccuracies and uncertainties such that it is not possible to specify minimum viable populations and minimum habitat sizes for the survival of species (Hohl and Tisdell 1993). Biodiversity conservation decisions, for a considerable time to come, will have to include ethical considerations. It has been concluded that 'society may choose to adopt the safe minimum standard not because it results from a rigorous model of social choice, but simply because individuals in the society feel that the safe minimum standard is the 'right thing to do'' (Bishop and Ready 1991). But let us not forget the significant use value that biodiversity possesses. A suitable comprehensive and long-term view of use value – one that protects ecosystems' services by protecting the health and integrity of systems over the long term – is probably sufficient to realize the case for more biodiversity conservation and will carry with it aesthetic and intrinsic moral values as well (Turner 1988a; Costanza *et al.* 1992). Adoption of the safe minimum standard and the precautionary principle also shifts the burden of justification to those who would destroy biodiversity because of their development activities.

12.3 The valuation of biodiversity: theory and methodology

12.3.1 Introduction

It is clear from the foregoing discussion of the components of the demand for biodiversity that its valuation is far from trivial. This is partly due to the very well recognized problems of the non-existence of well-functioning markets for many biological resources, and the public good nature of biodiversity. Both things imply that there is no ready index of value. Both also imply that the social value of biological resources cannot in general be derived from a simple aggregation of their value to individuals in society, the sum of their private values. Moreover, if individuals have distinct preferences as consumers and citizens, estimation of the social value of biological resources with at least some of the attributes of a public good is doubly problematic.

Where decision-making households or firms are so small that no single agent can influence price, and where markets are well-functioning, each actor responds quantitatively to exogenous price changes and it is possible to use market observations to characterize their behaviour in response to price changes and other exogenous influences. However, we are rarely able to obtain behavioural observations directly from markets for environmental resources because these markets typically do not exist. Economists therefore pursue one of two alternative strategies. The first, referred to as stated preference methods, avoids conventional markets and searches simulated markets. By this is meant that a survey instrument is designed in which a market-like situation is constructed. Respondents record choices in the light of hypothetically changed circumstances and the data are used to value environmental amenities and other goods or services. This avenue of attack has various generic names. The fact that there is no settled title reflects its youthful origins. It is sometimes called 'direct' or stated preference, because the analyst circumvents the market and goes directly to the wellspring of taste formation. At other times the distinction is made between a 'simulated' and a real market. 'Constructed market' is a more recent arrival.

The second strategy is to infer values from data on behavioural changes in actual markets related in some way to the missing markets for environmental resources. Travel cost, hedonic valuation and production function approaches are examples. Illustratively, through econometric analysis, the analyst separates the money value of an environmental amenity from the market price of residential property, of which air quality, for example, is but one characteristic. Alternatively, although there may be no market value for a wilderness area its value can be derived by analysing the demand for trips to the area, by those who face different costs per trip. Again, the value of the wilderness is separated from the value of the composite commodity, a trip. More generally, the value of an environmental amenity is 'indirectly' obtained from or 'revealed' by the demand for a related good/service.

Biological resources are a critical constituent in many marketed goods. In these cases such resources have direct or indirect use value. But the point has been made in earlier chapters that people also value natural resources irrespective of their own use of them. Some people have strong positive feelings about the existence of wild game in Africa and elsewhere. They are deeply concerned that the existence of rhinoceros and other species is threatened, so much so that they willingly contribute money toward preservation of these species. Some know that they will never themselves see those species in the wild but nonetheless contribute money to increase the chance that they will be available for future generations to enjoy. Existence and bequest values are strong motivating forces for understanding non-use values.

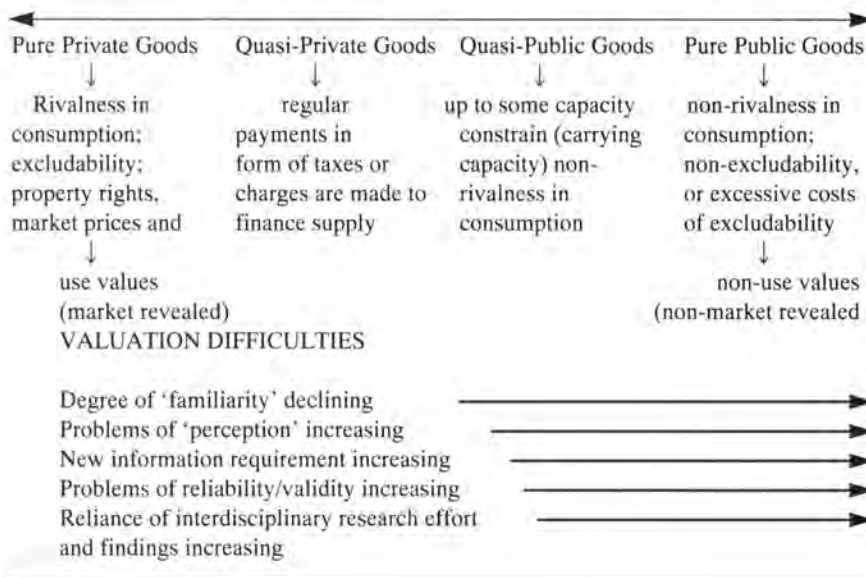

Source: Turner (1993).

Figure 12.3-1: Environmental Commodities Spectrum and the Valuation Problem.

In both approaches the problem of valuation is exacerbated by the public good nature of biodiversity. In economic terms pure public goods differ from private goods because they are non-rival in consumption terms (i.e. consumption of the good by one individual does not preclude consumption by others) and non-exclusive (i.e. having provided the good it is impossible, or excessively costly, to operate any exclusion mechanism). In practice there are very few pure public goods but many environmental goods and services fall between the polar public and private good cases. Thus so-called international common pool resources (e.g. fisheries and migratory species such as wildfowl and whales) have in the past been non-exclusive, open-access resources which have appeared to be also non-rival. Excessive exploitation and consequent depletion has resulted because of open access and the fear that exploitation would eventually become 'congested'; and most of this type of resources has now become a rival/contestable good. International management of these resources including regulation of exploitation is generally necessary to prevent open access depletion.

It turns out that the public good nature of biodiversity creates a particularly intractable set of problems for its valuation. These are discussed in the context of particular examples below, but they may be illustrated schematically. Figure 12.3-1 relates the difficulty of valuing environmental resources to the public good nature of those resources.

12.3.2 Stated preference methods: contingent valuation and contingent ranking

12.3.2.1 Contingent valuation

Contingent valuation and contingent ranking are two major techniques developed by social scientists for estimating non-market values. Contingent ranking is discussed momentarily. Put briefly, the contingent valuation method (CVM) involves asking respondents hypothetical questions about their monetary valuation of a situation, here involving a biodiversity issue. For example, (Whitehead 1993):

Suppose that a [US\$10] contribution...would be needed to support and fund the loggerhead sea turtle program. Would you be willing to contribute [US\$10] each year to the 'Loggerhead Sea Turtle Preservation Trust Fund'...?

There is, of course, more to the CVM than this. It involves conducting a survey by mail, telephone or personal interview which has three essential components.

First, background information about the natural resource setting and circumstances is provided. The respondent is advised about the quantity, quality and duration of change in the natural resources.

Second, a payment instrument is chosen. In the example above, the respondents were asked to contribute to a hypothetical fund. In the Exxon Valdez oil spill case, respondents were asked to vote for a referendum resulting in a tax increase in the study done for the State of Alaska

(Carson *et al.* 1992). In other surveys, the payment vehicle is an increase in product price. For example, harvest restrictions to preserve wild salmonid species in the Pacific Northwest could increase retail salmon prices. Throughout the process, focus groups and other means are used to understand what is and isn't being understood. The background information and payment vehicle are not independent elements. The researcher must take great care in characterizing a plausible and acceptable scenario. Illustratively, respondents will refuse to respond, or respond inappropriately, if they hate taxes and the vehicle is a tax change; if they don't believe a cost incident on producers will be passed on to them; if they think a special purpose public building fund for a limited duration will be used for purposes other than improving biodiversity, will be extended longer than was stated or will be spent wastefully – liberties they may have observed public authorities to have committed in similar situations in the past. The challenge is to devise a credible instrument.

Third, a method of elicitation is chosen. One approach, called open-ended, asks the respondent to state a maximum amount he/she is willing to pay (or to receive). A second approach, illustrated above in the case of turtles, is called dichotomous choice, in which a respondent is asked whether, for example, he/she would pay X dollars for the environmental change (or no change) in question. The amount, X , is systematically varied across the sample population. Other approaches exist (Carson *et al.* 1995).

More than 2000 studies using the CVM (Carson *et al.* 1995) have been conducted throughout the world and the number is growing rapidly. However, comparatively few relate to biodiversity (Portney 1994; Hanemann 1994; Diamond and Hausman 1994). Research bearing on endangered or unique species, in addition to the study of loggerhead sea turtles (Whitehead 1993), includes the value of preserving the whooping crane population at the Arkansas National Wildlife Refuge in Texas for viewers and non-viewers, estimated by Stoll and Johnson (1984) and Bowker and Stoll (1988). Hagemann (1985) valued blue whales, bottlenose dolphins, California sea otters and northern elephant seals. Brown and Henry (1993) estimated the value of preserving elephants in Kenya. Boyle and Bishop (1987) estimated the value of preserving the striped shiner, a Wisconsin endangered species. Boyle and Bishop (1986) also have estimated the existence value for eagles (also an endangered species in Wisconsin) focusing, in part, on whether respondents view eagles or not. The last three studies vary in detail and in the exact concept of existence value measured but they closely resemble each other in such important considerations as survey delivery (mail questionnaire); payment vehicle (contribution to a fund/foundation); and type of question (dichotomous choice and open-ended). In addition, Spash and Hanley (1995) and Hanley *et al.* (1995) have evaluated the

problem of information in the valuation of biodiversity. The results of some of these surveys are reported in Chapter 12.5.

Hagen *et al.* (1991) and Rubin *et al.* (1991) differ from the three studies above. The first set of authors estimated the value of preserving the Northern spotted owl using a tax and price increase scenario and the latter study used a payment card format with a matrix of annual values to elicit an open-ended maximum willingness to pay value for the Northern spotted owl. The estimated values varied by more than a factor of five between these studies for reasons difficult to characterize precisely because the study designs exhibited great variations in details.

12.3.2.2 Contingent ranking

The contingent ranking method is a step-sister to the contingent valuation method; relatively few have been carried out. The distinctive ingredient in a contingent ranking study is a menu of alternatives. The respondent is asked to rank one or more, up to all, of the options in order of preference. The researcher identifies a set of important attributes or characteristics common to each item on the menu and the amount by which one or more of the attributes differ for each option on the menu. For example, in order to value different endangered species, a researcher might think that taxonomic distinctiveness is important, such as monotypic or subspecies, taxonomic class such as mammal, bird, other, and some measure of size such as mass or length to capture 'charismatic megafauna'. For economic valuation, a money metric is necessary. This is achieved, say, by introducing the cost of a preservation programme. Thus both cost and one or more levels of preservation would have to be specified for each item on the menu. Basically the respondent is comparing added money cost with added pay-off measured in additional physical characteristics. The respondent ranks highest that option which provides the 'biggest bang for a buck'. Clever survey design aided by competent econometric analysis allows the researcher to conclude which menu, policy choice, species, etc. is the most valued, second most valued, etc. One can also estimate the value of a marginal improvement in chance of survival, population size, and other characteristics such as habitat complexity, if 'complexity' can be described in a manner which respondents can order.

A feeling for the level of complexity that can be encompassed by contingent ranking methods is illustrated by an early and ambitious model outside the realm of biodiversity. Beggs *et al.* (1981) valued the characteristics of automobiles, with particular emphasis on electric power. There were 16 items on the menu, each of which had nine attributes. Respondents were asked to rank the various options!

There are not enough data to compare the contingent valuation method with the contingent ranking method, but

two observations seem reasonable. First, it would seem to be easier to order two alternatives in the contingent ranking situation compared to choosing whether an option or policy is worth at least a given money value. As the number of required ordinal rankings increases, the advantage of contingent ranking over contingent valuation decreases. Second, non-market valuation studies continuously have to defend in design and concept against the phenomenon variously called part-whole bias, warm glow or embedding. If one is asked to value biodiversity or an improvement in the state of biodiversity, the respondent may have a mental model that fails to distinguish between this specific element and the value of a more encompassing concept such as environmental improvement or altruism. If a respondent has a propensity to embed or to have a warm glow, then it is easier for him/her to agree to pay a specified amount for a given environmental improvement than not. Put differently, one might expect the response to a maximum willingness to pay question to have a monetary value which includes an embedding component in it. Matters are different in the contingent ranking approach because it is marginal in nature. If one is an embedder or has a warm glow, this should exist for every option. Contingent ranking is designed to elicit the marginal change in valuation, i.e. the difference between two options. In this case, all or most of the embedding present should fall out when, in effect, the value of one option is subtracted from another.

Contingent valuation and ranking techniques, or more euphemistically, values estimated from simulated markets are very controversial within the economics profession. It is predisposed to favour market observations. Kenneth Arrow captured the issue nicely when he said that '[V]erbal answers don't hurt the way cash payments do' (in Cummings *et al.* 1986). Some have argued that values obtained from the CVM should play no role in policy analysis (Hausman 1993). Critical evaluation has been heightened, now that the technique has been legally authorized in the United States for use in natural resource damage assessment. Controversy about its applicability in the *Exxon Valdez* damage assessment legal proceedings led to the formation of the NOAA panel on contingent valuation which comprised two Nobel prize winners in economics and others (Arrow *et al.* 1993). Their report lays down criteria that a proper study using the CVM should meet in the context of a legal suit involving enormous sums of money. To satisfy their standards, a survey would cost millions of dollars. Adherents to their criteria would reject data from the US Census because a mail survey is used. Readers interested in the issue can review the litany of biases it is important to avoid (Cummings *et al.* 1986; Mitchell and Carson 1988; Hausman 1993). The extraordinary intellectual ferment that has been generated is exciting and reflects what should be expected when a promising research method is in early stages of

development. One cannot simply stand aside for years until the issues are settled, unless one is prepared to leave non-use values unmeasured. An alternative is to fashion an interdisciplinary research design, including critics in the process. Even then, the task is not easy. Here are two illustrative issues. What is the optimal amount of information to provide, keeping in mind that people who purchase market goods have a distribution of information about these goods? Responses vary with the level of information provided (Irwin *et al.* 1992; McClelland and Schulze 1993).

What elicitation method is best? It has been argued that it is harder and takes more information, to respond to an open-ended, maximum willingness to pay question, than it takes to answer a dichotomous choice question, so the latter approach is now more popular. Statistically, it is not very efficient to know that one values viewing elephants either more or less than US\$100. In response, a technique known as double bounded dichotomous choice has been developed. If a respondent says yes to the first value, he/she is asked to respond to a higher specified value and if the response is no, then a lower value is offered. This technique is popular. Responses to an open-ended design are virtually always lower by several multiples, when the goods are non-market (Schulze *et al.* 1994). Moreover, the double bounded approach has brought further difficulties. Analytically, responses to the first question should have the same distribution as responses to the second question. Thus far, this has not been the case (McFadden and Leonard 1993; Brown *et al.* 1994; Cameron and Quiggin 1994; Alberini 1994). In fact, the mean of the second response tends to be smaller. Why? Maybe it is because of an old problem in new clothing, starting point bias, where the number a respondent first sees influences the response. In any event, it is much too soon to know whether a design innovation can remove the problem. New evidence from experimental economics criticizes the double bounded approach on the grounds that, in experimental designs, it gives an overestimate of market values, more closely approximated by responses to an open-ended design question (Schulze *et al.* 1994). However, estimates of value from open-ended questions tend to overestimate but to a lesser degree than the close-ended question format.

Finally, rarely is policy-making a binary choice. Usually, debate in public forums encompasses a variety of options in which a bit more improvement in biodiversity can be obtained for a bit more expenditure. Not many CVM studies exhibit this design feature. To this end, it behoves researchers to design studies that inform them about how economic value varies with scale of effort. It is likely that the public places a different value on reducing the probability of extinction by ten points, from 30 to 40% chance of survival than they place on improving survivability from 80 to 90%. Thus a successful and

well-designed study provides a total benefit function which captures how total benefits vary as one or more measures of biodiversity captures are changed

According to some analysts, the economic literature which seeks appropriately to define and measure existence value as part of a comprehensive valuation framework has arrived at a consensus view that both use value and non-use value can be distinguished formally using standard welfare measures from neoclassical economic theory (Larson 1993). Other analysts highlight the differences that have emerged in the literature (Lant 1994). A number of writers also seem to agree that existence value can only be measured by survey methods (contingent valuation methods). Since existence values involve neither personal consumption of derived products nor *in situ* contact, economists have used a special structure of preferences to model existence value. They have assumed either so-called 'weak separability' or 'strong separability' between the non-market good that is the subject of existence value motivated by individuals and market goods. When preferences take these forms, the non-market good cannot be identified via conventional market demand theory and analysis. Existence value of the non-market good cannot therefore be measured by indirect observation of the individual's behaviour and the only option is direct questioning via surveys.

Larson (1993) has questioned some of this consensus thinking and in particular argues that in a number of real world choice situations neither 'weak' nor 'strong' separability assumptions are very realistic. Instead it is likely in a number of situations that changes in the level of the public good will give rise to existence value that is traceable in principle from observed changes in behaviour (spending money and/or time in reading about or protesting in some way about the environmental change, e.g. species or habitat loss or degradation). It remains to be seen whether valuation techniques other than contingent valuation (or proxy measures such as debt-for-nature swap expenditures) can adequately capture aspects of existence value. Some economists and many non-economists also question whether in practice contingent valuation methods can yield reliable measures of existence value. The methods are both expensive and demanding on researchers if acceptable reliability and validity testing protocols are to be met.

12.3.3 Revealed preference methods: travel cost and random utility models

We now consider the indirect or revealed preference methods for eliciting the private value of environmental resources. Direct methods involve direct measurements of utility, using some form of stated preference approach. In contrast, indirect methods seek to recover estimates of individuals' willingness to pay (WTP) for environmental

quality by observing their behaviour in related markets. In the hedonic pricing example already referred to, the related market for urban air quality is the housing market, and economists seek to infer individuals' valuation of air quality improvements by considering their behaviour in this market. In the travel cost model, the analyst infers the value people place on an outdoor recreational site through their expenditure on travel to the site. The random utility model also makes use of travel expenditures. Both travel cost and random utility models can be used to estimate the value of individual species, but their usefulness in valuing biodiversity itself may be viewed as being rather limited. Hedonic pricing methods would seem to offer very little scope for the valuation of biodiversity, so are not included in this section: see Hanley and Spash (1994) for a description of these methods. Dose-response and production function models (described elsewhere in this chapter) are also usually categorised as indirect valuation methods.

12.3.3.1 The travel cost model

The travel cost model (TCM) is one of the oldest approaches to environmental valuation, first used by Wood and Trice in 1958, and popularized by Clawson and Knetsch (1966). The method involves using travel costs as a proxy for the price of visiting outdoor recreational sites. A statistical relationship between observed visits and the cost of visiting is derived, and used to derive a surrogate demand curve from which consumers' surplus per visit-day can be measured (by integrating under this curve). The method has been widely used in both the USA and the UK for valuing the non-market benefits of outdoor recreation, especially recreation associated with national parks and public forests (Bowes and Krutilla 1989). Recent developments of the technique allow the welfare effects of changing the characteristics of a site to be analysed. An excellent recent survey of the method may be found in Fletcher *et al.* (1990).

The travel cost method assumes *weak complementarity* between the environmental asset and consumption expenditure. This implies that when consumption expenditure is zero, the marginal utility of the public good is also zero. So if travelling to a forest becomes so expensive that no one goes any more, the marginal social cost of a decrease in the quality of that forest is also zero. The TCM cannot therefore estimate non-use values (although see Larson (1992) for a contrary argument). As has already been remarked in this section, an implicit assumption also made in most travel cost studies is that the representative visitor's utility function is 'separable' in the recreation activity being modelled. This means that, if the activity of interest is fishing, then the utility function is such that demand for fishing trips can be estimated independently of demand, say, for cinema trips (alternative leisure activities) or for heating oil (alternative marketed

non-leisure goods). Finally, like all other valuation methods, the TCM assumes the existence of utility functions where the environment appears in a similar manner to other goods. In particular, the assumption is made that individuals are willing to trade off changes in environmental quality against changes in other goods or income. For a contrary view, see Sagoff (1988), Blamey and Common (1994) and Spash and Hanley (1995).

The simplest version of the travel cost model involves collecting data on visits to a site (V) from different parts of the surrounding country (zones, i), and explaining the visit rate per capita (V_i/P_i) as a function of travel costs, C_i . These costs are assumed to be some function of both distance and time spent travelling (travelling time is often allocated a positive value to reflect the scarcity of leisure time); and of socio-economic variables S_i :

$$V_i/P_i = F(C_i, S_i) \quad (1)$$

By predicting how visits per capita will fall as travel costs rise, a demand curve can be traced out for each zone, up to the cost at which visits become equal to zero (although in some functional forms of equation (1), visits will only approach zero asymptotically). Alternatively, visits per time period by a given individual j to a site (VPA _{j}) may be used as the dependent variable, with the C and S terms becoming specific to that individual.

Many problems exist with such a simple model of the benefits of a single site. Most notably, the effects of other substitute sites are not included (Hof and King 1982). This could be corrected by estimating, instead of equation (1):

$$V_i/P_i = F(C_i, S_i, X_i) \quad (2)$$

where X_i is a vector of 'prices' (that is, visiting costs) for other, substitute sites (Caulkins *et al.* 1986). Alternatively, equation (2) may be estimated simultaneously for a group of sites (for example, all public forests within a region) (Burt and Brewer 1974). Again, VPA may be the dependent variable rather than V/P .

Several problems exist with the model. These include, first, the value of travel/leisure time. Some authors (Chevas *et al.* 1989) have argued that a distinction should be made between the 'commodity value' of time (time spent on-site that generates utility); and the opportunity cost of time, which may be in terms of forgone earnings (in a minority of cases) or forgone recreational opportunities. Chevas *et al.* find the commodity value of time to be positive but small, and call for this to be netted out from the opportunity cost of time in calculating consumers' surplus. The choice of a value for the cost of travel time can cause significant changes in consumers' surplus estimates. Such changes can also be caused by the choice of dependent variable (V/P or VPA). Garrod and Willis (1991) obtain estimates of

consumers' surplus per visit day for UK forests which range from £1.44 to £2.60 for V/P , and £0.12 to £0.96 for VPA. In informal recreation settings recall errors may be a problem in VPA data. Changes in consumers' surplus can also be brought about by the selection of functional form for the visit-travel cost equation. Hanley (1989) reports a variation from £0.32 per visit (quadratic), £0.56 (semi-log independent), £1.70 (semi-log dependent) and £15.13 (log-log) for visits to Achray Forest in Central Scotland.

Another problem with the simple travel cost model considered here is that of multi-purpose trips. It may be necessary to distinguish 'meanderers' from 'purposeful visitors' in the sample of visitors to a site. The former describes those for whom a visit to the site in question is only part of the purpose for their journey. The latter term describes those for whom a visit to the site is the sole purpose of their trip. Consider people visiting a lake in a national park, who are also going on to visit a forest in the same national park. Clearly, some of the travel cost for such meanderers should be excluded from the minimum value they place on a visit to the lake, because they are also going to visit the forest during the same trip. Some of their travel costs should be apportioned to the lake, but how much? There are three options. The first is to ask people to score the relative importance of a visit to the lake; that is, relative to their enjoyment of the entire trip. This score, expressed as a number between 0 and 1, can be used to weight their total travel cost (e.g. Hanley and Ruffell 1993). Second, meanderers may be excluded from the TCM analysis and a per visit consumers' surplus figure, based on these functions, computed. This average visitor consumers' surplus can then be aggregated across all visitors. This assumes, however, that meanderers, on average, value the site no less highly than purposeful visitors. Finally, separate demand functions could be estimated for each group.

Finally, Randall (1994) has made a somewhat more fundamental criticism of the TCM. This is that the researcher's measure of costs may be very different from the cost perceived by the recreationalist. It is this perceived cost (which is largely subjective) that influences the decision on whether or not to visit a site. Yet the researcher cannot measure this perceived cost. It may well differ from the researcher's estimate of it (if, for example, the researcher's estimate of the value of leisure time differs from the value perceived by the recreationalist). Thus the researcher may make incorrect inferences about the revealed value of the recreation site.

On many occasions, policy-makers are more interested in the value of changing the characteristics of a site rather than the value of the site in total. The travel cost model can be used for such calculations. A good example relates to changes in fishing quality at freshwater fishing sites. Two approaches may be distinguished: first, a 'varying

parameter' model, whereby travel cost equations are initially estimated across a group of fishing sites. The travel cost coefficients from these equations are then regressed on the site characteristics (such as water quality, catch rates) across the sites in the sample.¹ This enables the welfare gain associated with changing one of these characteristics to be estimated (Vaughn and Russell 1982; Smith *et al.* 1983). In the second approach, characteristics are used as shift variables in the visits–travel cost relationship. This was the approach taken by Loomis *et al.* (1986) to measure recreational fishing losses due to hydroelectric developments.

12.3.3.2 The hedonic travel cost model

The Hedonic Travel Cost Model (HTC) also attempts to place values on the characteristics of recreational resources. It was first proposed by Brown and Mendelsohn (1984), and has been applied to forest characteristics by Englin and Mendelsohn (1991) and to coastal water quality by Bockstael *et al.* (1987). The method is implemented as follows. First, respondents to a number of sites (e.g. forests) are sampled to determine their zone of origin. Levels of physical characteristics (such as broadleaved/conifer areas and the percentage of forest as open space) are recorded for each site. Next a travel cost function is estimated for each zone:

$$C(Z) = c_0 + c_1z_1 + c_2z_2 + \dots + c_mz_m \quad (3)$$

where $C(Z)$ are travel costs, z_1 is distance to site, $z_2 \dots z_m$ are characteristics, and $c_0 \dots c_m$ are coefficients to be estimated. A separate regression is performed for each zone of origin, so that each will have a vector of coefficients $\{c_0 \dots c_m\}$ associated with it. For a given characteristic m , the utility maximizing individual will choose visits such that the marginal cost of the characteristic (the coefficient c_m) is just equal to the marginal benefit to him/her. These marginal costs will vary, for a given characteristic, across zones of origin. As the forest (for example) is assumed to be a public good (and thus consumption of its recreational opportunities is non-rival), the marginal social value is the sum of all individual (zonal) marginal values. In Englin and Mendelsohn (1991), some of these marginal values are negative, implying that the individual would drive further to have less of the good. This is explained by Englin and Mendelsohn as being related to either undesirable characteristics (such as clear-cut), or cases where the individual is over-satiated with a desirable characteristic. In Bockstael *et al.*, most of the marginal values which were thought *a priori* to be positive turned out to be negative in the estimation.

The second stage of the Brown–Mendelsohn approach is to estimate a demand curve for each characteristic. This is done by regressing site characteristic levels (the dependent variable) against the predicted marginal cost of that characteristic (which is implicitly the marginal value as explained above), and socioeconomic variables for each zone of origin. A separate regression is run for each characteristic. The expectation is that the coefficient on the marginal cost variable will be negative, so that as the level of a characteristic rises, people are unwilling to pay as much for each further increment. Englin and Mendelsohn find this to be so for ten out of eleven characteristics modelled.

However, the HTC method has dropped somewhat out of favour with environmental economists due to a number of problems, highlighted in papers by Bockstael *et al.* (1981) and Smith and Kaoru (1987). First, the marginal value of a characteristic in the HTC method is given by the extra costs individuals are prepared to spend to enjoy, for example, a river with a higher amenity value than a less-visited, lower amenity site closer to home. Yet these relative values (that the clean river costs more to visit than the dirty river) are an accident of nature, in that the clean river just happens to be further away. Bockstael *et al.* give the example of the valuation of two characteristics of lakes, namely scenic beauty and fish catch. If fish catch increases with distance from a major population centre but scenic beauty simultaneously declines, then a positive price (value) for scenic beauty will not be found. Many authors have in fact found negative prices for characteristics which would be expected to have positive marginal values (see above). These difficulties have led some researchers to seek an alternative method of valuing site characteristics, with current research interest being centred on the random utility model of recreational demand.

12.3.3.3 The random utility model

The random utility model of recreational demand (Bockstael *et al.* 1987; Coyne and Adamowicz 1992; Adamowicz *et al.* 1994) shares a theoretical foundation with some stated preference approaches, in particular the dichotomous choice variant of CVM. This is that utility is assumed to be composed of an observable, deterministic component and a random error term. Travel cost and characteristics data are collected for a number of substitute sites in an area. The probability that a given individual will visit site i rather than site j can then be calculated, dependent on the costs of visiting each site and their characteristics, relative to the characteristics of all sites in the individual's choice set. In turn, estimates of the welfare effects of changing a characteristic can be arrived at. Bockstael *et al.* estimate a random utility model for choice of saltwater beach sites in the Boston area, and show that sites with higher pollution levels, higher noise levels, and

¹These two steps can, in fact, be combined by specifying interaction terms between characteristics and travel costs in the initial equation: see Hanley and Ruffell (1993).

more crowding are less likely to be chosen. They also estimate a 'count' model which predicts how many trips will be made in total to all beaches in the area. Combining these models they are able to calculate the money value of benefits associated with reducing oil, chemical oxygen and faecal coliform pollution levels at all sites in the study area.

The reliability and validity of travel cost models have been addressed in a number of ways, including the use of the 'convergent validity' criterion, whereby travel cost estimates for one site are compared with contingent valuation estimates for the same site (e.g. Sellar *et al.* 1985; Smith and Desvougues 1986). Another interesting approach has been the use of meta-analysis. This involves trying to explain statistically the variation in consumers' surplus per visit across a large number of travel cost studies, according to the manner in which each was carried out. Smith and Kaoru (1990) were able to explain 43% of the variation in consumers' surplus figures across a sample of TCM studies, and also predict the effect on consumers' surplus of, for example, employing a particular functional form or treatment of travel time. Thus, the consumers' surplus figures from travel cost studies are unlikely to be random numbers with no link to the value of a site: this is reckoned to be of some comfort to policy-makers wishing to use such figures.

The indirect valuation methods covered in this section have the advantage that inference is based on actual market behaviour, so that the biases associated with direct valuation methods such as contingent valuation are not a problem. Indirect methods as a group do, however, have their own set of disadvantages. First, with particular reference to the TCM, the values estimated are not only just use values, they are the subset of use values which consist of tourist visits. They cannot account for either the essential services provided by ecosystems in terms of stabilization, resilience to shocks, and assimilation of undesirable substances, or the actual and potential medical uses which diverse flora and fauna serve. The methods, moreover, apply only to ecosystems that have scenery or wildlife sufficiently spectacular to attract visitors. If an inaccessible or unremarkable ecosystem attracts no visitors, then no value can be attached to it, or rationale for its preservation derived, using the TCM.

Ethicists and philosophers have made the argument that the valuation of biodiversity in monetary terms is nonsensical, since it implies a trade-off between the survival of a species and some quantity of a commercially traded good. The argument would certainly be persuasive if a monetary valuation did indeed reveal a trade-off in circumstances where no trade-off was possible (all species were assigned the absolute right of survival, as they might be in a biocentric perspective). But it is worth underlining the fact that monetary valuation does not necessarily imply that individuals are willing to make trade-offs of this sort. Many individuals would no sooner trade off the life of a

non-human organism against some traded good than they would trade off the life of a human. There are resources that are perfect complements to all other resources, whether because they are necessary to the production or consumption of all other resources or because people refuse to trade them off for moral, religious or ethical reasons.

It is worth adding that rejection of valuation overlooks the fact that it can be a more effective means to the end of conservation than an appeal to moral principles. At present, species are being lost at a rate of around 1–11% per decade (Reid 1992). Arguably, it is not the over-application of economic criteria to biodiversity and ecosystems, but the failure to apply them consistently which leads to this destructive and unsustainable state of affairs. Destruction of the forest can thus be objected to purely on the grounds of productive efficiency without recourse to either consumer valuation or ethics. If, alternatively, it can be shown that the ongoing consumer surplus from an ecosystem is greater than the potential return from its destruction, then this also provides concrete grounds for its defence. The grounds are purely in terms of human interest, and these being the terms in which policy-makers are accustomed to reasoning, are more likely to achieve positive results for conservation.

Destruction of ecosystems can occur when poor countries cannot justify the investment in conservation, even when the return is high. Eating the seed grain with unsustainable land use can be rational if problems of survival are so acute that the future carries virtually no weight in the decision-making process. Given that many of the benefits of biodiversity preservation are international and global, while most of the costs are direct and local, indirect valuation has an important role to play in highlighting the extent to which international institutions might be expected to finance conservation.

12.3.4 Production function approaches

In Chapter 12.2 it was noted that many biological resources and natural systems were being used directly in production as inputs or used indirectly in the sense that ecological functions and resources were supporting or protecting economic activity. Where such values are reflected in market prices and behaviour, then the various 'revealed preference' approaches suggested in the previous section may be adequate as valuation techniques, all of which use information about a marketed good to infer the value of a related non-marketed good. The previous section discussed travel cost and recreational demand which are examples of this form of surrogate market valuation that attempt to estimate the derived demand by households for environmental quality.

In this section, we are interested in another type of surrogate market valuation that is particularly useful for the valuation of non-marketed values associated with

biological resources and ecosystems that protect or support economic activity. This is the production function approach.² It consists of a two-step procedure. First, the physical effects of changes in a biological resource or ecological function on an economic activity are determined. Second, the impact of these environmental changes is valued in terms of the corresponding change in the marketed output of the corresponding activity. In other words, the biological resource or ecological function is treated as an 'input' into the economic activity, and like any other input, its value can be equated with its impact on the productivity of any marketed output.

More formally, if Q is the marketed output of an economic activity, then Q can be considered to be a function of a range of inputs:

$$Q = F(X_1, \dots, X_k, S) \quad (4)$$

For example, a common ecological function of mangroves is the support of offshore fisheries by serving both as a spawning ground and as a nursery for fry. The area of mangroves in a coastal region, S , may therefore have a direct influence on the catch of mangrove-dependent species, Q , which is independent from the standard inputs of a commercial fishery, X_1, \dots, X_k . Including mangrove area as a determinant of fish catch may therefore 'capture' some element of the economic contribution of this important ecological support function.

Applying the production function approach to the various indirect use values of biological resources and systems may prove a useful method of estimating these non-marketed – but often significant – economic values. However, it is extremely important that the relationship between any environmental regulatory function and the economic activity it protects or supports is well understood.

² The production function approach discussed here is related to the *household production function* approach, which is a more appropriate term for those surrogate market valuation techniques based on the derived demand by households for environmental quality. That is, by explicitly incorporating non-marketed environmental functions in the modelling of individuals' preferences, household expenditures on private goods can be related to the derived demand for environmental functions (Bockstael and McConnell 1981; Smith 1991). Some well-known techniques in applied environmental economics – such as travel cost, recreation demand, and hedonic pricing models (see previous section) – are based on the household production function approach. The *dose-response technique* is also related to the production function and household production function approaches; however, dose-response models are generally used to relate environmental damage (i.e. pollution; off-site impacts of soil erosion) to loss of either consumer welfare (i.e. through health impacts) or property and productivity (i.e. through damage to buildings, impacts on production).

Mäler (1991) distinguishes between applications of the production function approach. When production, Q , is measurable and either there is a market price for this output or one can be imputed, then determining the marginal value of the resource is relatively straightforward. If Q cannot be measured directly, then either a marketed substitute has to be found, or possible complementarity or substitutability between S and one or more of the other (marketed) inputs, X_1, \dots, X_k , has to be specified explicitly. Although all these applications require detailed knowledge of the physical effects on production of changes in the resource, S , and its environmental functions, applications that assume complementarity or substitutability between the resource and other inputs are particularly stringent on the information required on physical relationships in production. Clearly, co-operation is required between economists, ecologists and other researchers to determine the precise nature of these relationships.

Applications of the production function approach may be most straightforward in the case of single use systems, i.e. resource systems in which the predominant economic value is a single regulatory function, or a group of ecological functions providing support or protection for an economic activity in concert. For example, Ellis and Fisher (1987) use this approach to model explicitly the environmental function of Gulf Coast estuarine and wetland systems in support of the commercial blue crab fishery. Taking the sum of consumers' and producers' surpluses as the measure of economic value, they hypothesize that an increase in wetland area increases the abundance of crabs and thus lowers the cost of the catch. The value of the wetlands' support for the fishery – which in this case is equivalent to the value of increments to wetland area – can then be imputed from the resulting changes in consumers' and producers' surplus.

In the Ellis and Fisher model, equation (4) above assumes the specific Cobb-Douglas form

$$Q = AX^a S^b, \quad (5)$$

where Q is the quantity of crab catch in pounds, X is effort measured by traps set and S is area of wetlands. The corresponding cost function is:

$$C = WA^{-1/a} S^{-b/a} Q^{1/a}, \quad (6)$$

where W is the unit cost of effort and S is determined exogenously. Assuming an iso-elastic demand for crabs and either private ownership or optimal public management (i.e. price equals marginal cost in both cases), Ellis and Fisher solve the two-equation model for the incremental value of the wetlands' support function.

However, employing the Ellis and Fisher model for the blue crab fishery, Freeman (1991) has made the important

additional point that the values imputed to the wetlands are influenced by the market conditions and regulatory policies that determine the conditions of access and rate of utilization of the fishery. For example, under open access, rents in the fishery would be dissipated, and price would be equated to average and not marginal costs. As a consequence, producer surplus is zero and only consumer surplus determines the value of increased wetland area. When the demand for crabs is inelastic, the social value of an increase in area is higher under open access than under optimal regulation, whereas the wetlands are more valuable under optimal regulation when demand is elastic. This result stems from the role of price changes in allocating welfare gains between producers and consumers: in the case of optimal regulations, part of the consumers' gain is a transfer from producer surplus, whereas under open access and zero producer surplus, any reduction in the price of fish associated with the average cost curve shifting down (in response to an increase in wetland area) results in a gain in consumer surplus and increased wetland value.

Freeman also calculates the social value of the marginal product of wetland area, which is given by:

$$VMP_S = bPQ/S, \quad (7)$$

where P is the price of crabs. As optimal regulation should lead to a higher price than open access, an inelastic demand means that VMP_S is higher under optimal regulation.

These different impacts of market conditions and regulatory policies for the production-function approach to valuing biological resources and systems are common, where there is open access exploitation and imperfect markets for resources. As argued by Barbier (1994b), this may be a prevalent feature of resource systems in tropical regions. In the case of multiple use systems – i.e. resource systems in which a regulatory function may support or protect many different economic activities, or which may have more than one regulatory ecological function of important economic value – applications of the production function approach may be slightly more problematic. In

Box 12.3-1: Economic value of mangrove system, Bintuni Bay, Irian Jaya, Indonesia.

Ruitenbeek (1992) uses a modified production function approach to evaluate the trade-offs between different forestry options for a mangrove system in Bintuni Bay, Irian Jaya, Indonesia. The options range from preserving the mangroves through a cutting ban to various forestry development options involving partial, selective and clear-cutting operations. An important feature of the analysis is that it tries to incorporate explicitly the linkages between loss of mangroves and their ecological functions and the productivity of economic activities. For example, the mangroves may support many economic activities, such as commercial shrimp fishing, commercial sago production and traditional household production from hunting, fishing, gathering and cottage industry; they may also have indirect use value through controlling erosion and sedimentation, which protects agricultural production in the region; and they have an indirect role in supporting biodiversity. To the extent that the ecological linkages in terms of support or protection of these activities are strong, then the opportunity cost of forestry options that lead to the depletion or degradation of the mangroves will be high. Thus, the 'optimal' forest management option – whether clear cutting, selective cutting or complete preservation – depends critically on the strength of the ecological linkages.

In the absence of any ecological data on these linkages, Ruitenbeek developed several different scenarios based on different linkage assumptions. This essentially amounted to specifying the relationship between Q and S in the production function for each productive activity at time t , Q_{it}

$$Q_{it}/Q_{i0} = (S_{t,\tau}/S_0)^a,$$

where S_t is the area of remaining undisturbed mangroves at time t , and a and τ are impact intensity and delay parameters respectively. $Q_{i0} = Q_{it}(t=0)$ and $S_0 = S_t(t=0)$. For example, for fishery–mangrove linkages, a moderate linkage of $a = 0.5$ and $\tau = 5$ would imply that shrimp output varies with the square root of mangrove area (e.g. a 50% reduction in mangrove area would result in a 30% fall in shrimp production), and there would be a delay of 5 years before the impact takes effect. If no ecological linkages are present, i.e. there is no indirect use value of mangroves in terms of supporting shrimp fishing, then $a = 0$. At the other extreme, very strong linkages imply that the impacts of mangrove removal are linear and immediate, i.e. $a = 1$ and $\tau = 0$.

The results of the analysis are depicted in the following table. Based on this outcome, Ruitenbeek concluded that the assumption of no environmental linkages is unrealistic for most economic activities related to the mangroves. Moreover, given the uncertainty over these ecological linkages and the high costs associated with irreversible loss if environmental linkages prove to be significant, then only modest selective cutting (e.g. 25% or less) of the mangrove area was recommended.

Box 12.3-1 cont.

Indonesia – total economic value of a mangrove system under varying environmental linkages

Economic value of Mangrove System, Bintuni Bay, Irian Jaya, Indonesia

(Net present value in billions of 1991 Rp; 7.5% discount rate) 2000 Rp = US\$ 1

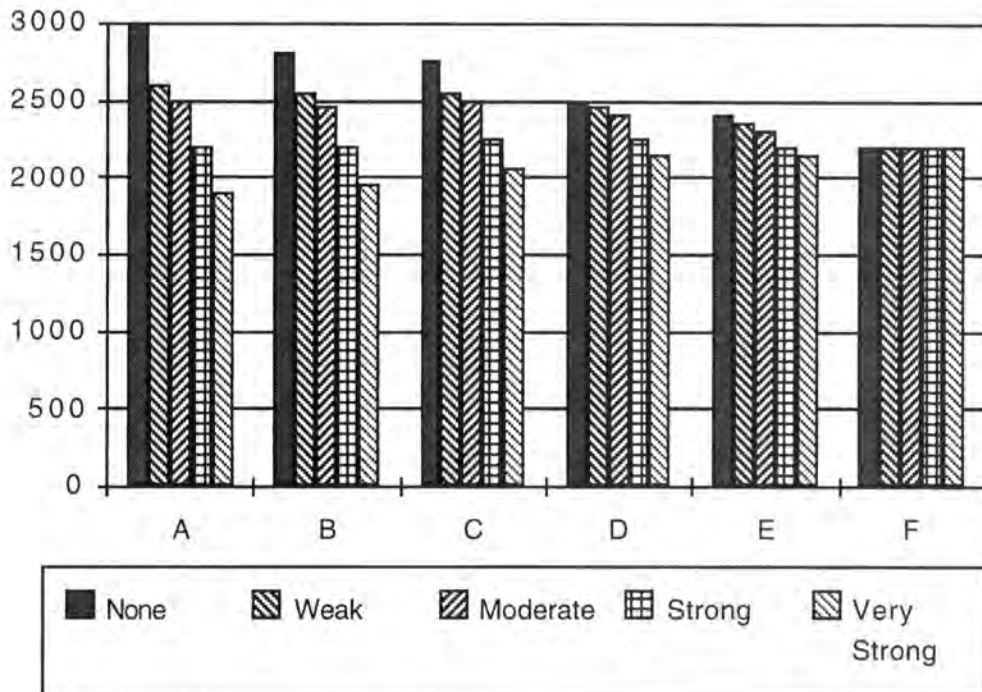

Environmental linkages – none to very strong

- A = 20 year clear cut of mangrove forest
- B = 30 year clear cut of mangrove forest
- C = 80% selective cut of mangrove forest
- D = 40% selective cut of mangrove forest
- E = 25% selective cut of mangrove forest
- F = Ban on cutting of mangrove forest

Total net benefits include economic returns from (a) woodchip production from mangrove forest cutting, (b) commercial shrimp and by-catch fish production, (c) commercial sago production, (d) traditional household production from hunting, fishing, gathering and manufacturing, (e) imputed benefit of erosion control, and (f) capturable biodiversity.

Source: Ruitenbeek (1992).

particular, assumptions concerning the ecological relationships among these various multiple uses must be carefully constructed (see Box 12.3-1).

There are clearly major difficulties in specifying ecological-economic relationships for the application of the production function approach to estimating indirect use values in multiple use resource systems. Two major problems are the 'double-counting' and 'trade-offs' between various direct and indirect use values, which arise whenever

analysts attempt to 'aggregate' the various direct and indirect use values arising from multiple use resource systems.

Aylward and Barbier (1992) provide an example of both on-site and off-site double-counting in terms of the nutrient retention function of a coastal wetland. Coastal wetlands often absorb organic nutrients from sewage and other waste emitted into waterways further upstream. Suppose that the nutrients held by the wetland are indirectly supporting both shrimp production within the wetland area and the growth

Table 12.3-1: Comparison of present value net economic benefits Kano River Project Phase I and Hadejia-Jama'are floodplain, Nigeria.¹

	(8%, 50 yrs)	(8%, 30 yrs)	(12%, 50 yrs)	(12%, 30 yrs)
Per hectare²				
HJF (N/ha)	1276	1176	872	846
KRP (N/ha)	233	214	158	153
Per Water Use³				
HJF (N/10 ³ m ³)	366	337	250	242
KRP (N/10 ³ m ³)	0.3	0.3	0.2	0.2

1. N7.5 = US\$1, 1989/90.

2. Based on a total production area of 730 000 ha for Hadejia-Jama'are floodplain (HJF) and a total crop cultivated area of 19 107 ha in 1985/6 for the Kano River Project Phase I (KRP).

3. Assumes an the annual average river flow into Hadejia-Jama'are floodplain (HJF) of 2549 Mm³ and an annual water use of 15 000 m³ per ha for the Kano River Project Phase I (KRP).

Source: Barbier *et al.* 1991.

of fish fry that supply an offshore fishery. If the full value of the shrimp production is already accounted for as a direct use value of the wetland's resources, adding in the share of the nutrient retention service as an indirect value and aggregating these values would double-count this indirect use. In other words, the value of shrimp production already 'captures' the value-added contribution of nutrient retention. Trade-offs between two or more indirect use values of a given ecosystem may also occur. For example, Barbier *et al.* (1991) illustrate why it is necessary to account for such trade-offs in their analysis of the Hadejia-Jama'are floodplain in Northern Nigeria (Table 12.3-1). The floodplain supports a number of important agricultural, forestry and fishing activities within the area of natural flooding. The floodplain also contributes to the recharge of groundwater, which is in turn drawn off by numerous small village wells throughout the region for domestic use and agricultural activities. However, concerns have recently been expressed about the excessive water use of pump-irrigated wheat production within the floodplain. Increasing use of the floodplain water to support this activity may mean less water available for natural groundwater recharge – and thus for village wells outside the floodplain. If there are trade-offs between the two environmental support functions, then adding the full value of the wetland's contribution to pump-irrigated wheat production within the floodplain to the full value of groundwater recharge of wells in neighbouring regions would overestimate the total benefit of these two environmental functions.

In fact, Barbier *et al.* (1991) were unable to value the contribution of groundwater recharge from the floodplain to economic activities in neighbouring regions. However, they were able to use a hydrological model of the wetlands

to estimate the productivity of agriculture, fuelwood and fishing activities within the floodplain area, and to compare the results with the returns per cubic metre of water diverted to an upstream irrigation project (see Table 12.3-1). Moreover, the floodplain benefits were adjusted for the 'unsustainability' of much pump-irrigated wheat production within the flooding area. The results suggest that, even without considering the economic benefits of the groundwater recharge function, diverting water for upstream development does not make much economic sense if it is detrimental to the natural flooding system downstream. These examples illustrate some important uses as well as limitations of the production function approach to economic valuation of biological resources and systems. Further examples of this approach can be found in Chapter 12.5.

Finally, dose-response models rely on tracing the effect of physical changes in environmental characteristics on marketed goods and services. A key intermediate stage in this is the behavioural response of producers to the change in the environment. Suppose that farmers in the USA find that higher tropospheric ozone levels are depressing yields of a particular crop due to foliar damage. These farmers may simply opt to produce less of this crop; or they may opt to grow different, less sensitive (but also, one assumes, less profitable) crops. This behavioural change must be captured in the dose-response model. One way of accomplishing this is the econometric route discussed above. A powerful alternative is mathematical programming models, the simplest (and most widespread) of which are linear programming (LP) routines. LP allows producers to find their profit maximizing output mix under a very wide range of price information and physical limits

on production. These limits can include those set by environmental conditions. For a full discussion of the relative merits of LP and econometric approaches to dose-response models, see Hanley and Spash (1994).

12.3.5 Revealed preference and opportunity cost

We conclude by summarizing the remaining widely used revealed preference methods, most involving some estimate of opportunity cost for another recent review see Filion and Adamowicz (1994).

12.3.5.1 Change in productivity method

If forests that are conserved as biodiversity habitats contribute to agricultural productivity through soil and water conservation, windbreak function and flood control, the loss of forests would result in a change (fall) in agricultural productivity downstream. The opportunity cost, or net value of the lost production (quantity times price minus saved production cost), constitutes a measure of the watershed (use) value of habitats to agriculture. The valuation of lost output due to deforestation or gain of output due to reforestation is done by applying market prices to the estimated output change. Any change in the cost of production is deducted from the change in gross value to obtain the net value of productivity changes which constitutes the true value of the forests' environmental services to agriculture. Indeed, in human welfare terms, the change in net social benefit resulting from environmental (or other) change is measured by the sum of the changes in producer surplus (profit) and consumer surplus (net consumer satisfaction). It must be stressed that this is the correct measure of welfare change due to environmental (or other) change, regardless of which method of valuation we use. All valuation methods aim to ascertain peoples' willingness to pay for an environmental improvement or to avoid an environmental damage or willingness to accept compensation to tolerate an environmental damage. In the example of agricultural production loss due to deforestation, the lost profit or producer surplus represents farmers' maximum willingness to pay to avoid the damage (or to accept to tolerate it); the lost consumer surplus represents the consumers' maximum willingness to pay for the same purpose.

The productivity change method can be used to obtain measures of most of the forests' direct and indirect use values, including timber production, non-timber forest products, tourism, water and soil conservation, etc. For example, the value of the ecological function of a forest in the catchment area of a hydroelectric dam can be measured by the net value of the change in the hydropower production due to sedimentation, traceable to change in the forest cover. Similarly, the net value of lost water-based

transport services or of tourist visits are measures of the value of the corresponding services of the forests.

12.3.5.2 Change in earnings method

This is very similar to the change in productivity approach except that we estimate directly the impact of the habitat loss on earnings (incomes or wages). In the case of farming we may estimate directly the change in farming incomes through econometric estimation of agricultural profit functions. In the case of workers who lose days of work due to environmental or related health damage, we can use the lost earnings as a measure of the value of the damage (or the affected people's willingness to pay to avert it).

12.3.5.3 Defensive or preventive expenditures method

This method measures people's valuation of the ecological services of the forests and other habitats by observing how much people are actually spending to prevent its loss or to defend themselves from the consequences of its loss. Farmers, for example, may contribute to a forest conservation or reforestation fund or they may defend their fields against soil loss through terracing or against floods through dikes and drainage systems. The observed defensive (or preventive) expenditures provide a measure of the farmers' valuation of the relevant ecological service of the forest. This method of valuation is applicable to forest services for which the beneficiaries (victims) perceive the benefits (damages) and take steps to secure (prevent) them. It suffers from a number of limitations stemming from its implicit assumptions that (a) actual preventive or defensive expenditures are representative of the affected population; (b) that environmental benefits and costs are perceived and responded to without undue delay; (c) preventive and defensive expenditures are effective and worth doing, and (d) there are no capital constraints and capital market imperfections that prevent a response. These are serious limitations and apply equally to the related method of replacement cost.

12.3.5.4 Replacement cost method

In many cases people may allow the environmental service of the forest to be lost and the damage (e.g. soil loss) to occur and attempt to replace or restore productivity through the increase of other inputs (e.g. fertilizer or irrigation). Similarly, hydropower lost to sedimentation may be replaced by the construction of another hydrodam or a coal-powered station. Tourist enterprises may attempt to restore lost recreational services of forests by planting trees or relocating to another area. The relocation cost method is a variant of the replacement cost method. By directly observing how much people are spending to replace the lost forest service or to relocate to avoid the damages from its loss, we can arrive at a judgement (or a monetary measure) of its value. It must be stressed that

this is a minimum or lower bound use value and it certainly does not include option or existence value. All limitations discussed in connection with the preventive/defensive expenditures method apply also to the replacement/relocation method.

12.3.5.5 Substitution or proxy method

This is closely related to other revealed preference methods but it is distinct in that it is not based on observed behaviour but on a surrogate market, the market of the closest substitute. The value of fuelwood to users is approximated by the price of the next best alternative (e.g. kerosene of equal calorific value; the value of soil loss by the cost of fertilizer needed to replace it; the value of non-marketed forest products such as fruits and medicines, by their marketed substitutes). Similarly, the value of a watershed in terms of regulation of water flows and water storage can be approximated by the cost of construction and operation of a dam that performs similar functions (minus any other economic benefits, plus any environmental costs related to the dam). But since we cannot directly observe the 'price' of the dam as we do with kerosene or fertilizer, this example fits better in the following closely related valuation method.

12.3.5.6 The shadow project method

The shadow project is an institutional judgement about the replacement cost of environmental assets or services. A particular environmental service of the forest is valued by designing and costing one or more shadow projects that provide for substitute environmental services to compensate for the potential loss. A plantation, a dam, a zoo, a park, a gene bank, etc., are some of the shadow projects that could be designed and costed as devices for valuing particular services of a habitat. This presupposes that it is feasible to replace damaged environmental services; a very strong assumption when it comes to complex ecological systems and poorly understood hydrological and atmospheric effects, and totally inappropriate in the case of species extinction. There are, however, shadow projects that can fully compensate for natural habitat loss as when another natural habitat of similar attributes under imminent threat of destruction could be saved in exchange. The cost of saving the latter can be used as a proxy for the value of the former. (Of course, ideally one may wish to try to preserve both).

From the standpoint of valuation, the cost of the project that fully compensates for natural resource injury or conversion will be no less than the minimum acceptable monetary compensation (i.e. willingness to accept). Determining the project that compensates exactly for natural resource loss or injury presents interesting ecological and public choice problems.

12.3.5.7 Compensation cost method

When a shadow project is not simply hypothetical (a valuation device), but actually serving also as a compensation device, the shadow project becomes a means of operationalizing the concept of sustainability at the individual resource or project level. In terms of project appraisal, while the hypothetical shadow project affects only the economic analysis of the project, the actual shadow project affects both the economic and the financial analysis. All the limitations discussed above apply plus the fact that compensation projects are likely to have their own adverse environmental impacts that should be fully costed and compensated for. Despite its limitations, the compensation approach when properly applied is both a useful valuation device and an instrument for internalizing the environmental costs of projects that result in habitat loss; where compensation is infeasible or uneconomic, the project is rejected.

12.3.5.8 Benefits transfer

Finally, benefits transfer is currently being argued by some to offer the potential to estimate economic values more quickly and less expensively than through the methods discussed in this Chapter (we are indebted to Fern Filion for the information reported in this subsection). Benefits transfer is accomplished by using values estimated from previous economic studies (usually referred to as results from a 'study site') and applying them to current policy and programme needs (usually referred to as a 'policy site'). For the estimates at the study site to be transferable, it must be possible to identify a number of valuation studies for which the 'study site' and 'policy site' characteristics are similar regarding the biodiversity in question. This matching of study and policy sites depends on establishing an explicit transfer protocol.

One attempt to do this is an initiative by Environment Canada with the US EPA to establish an Environmental Valuation Reference Inventory (EVRI). The initiative includes the designing and testing of a valuation database and defensible transfer protocol in support of benefits transfer in biodiversity conservation. As with the revealed preference methods reported in this Chapter, benefits transfer uses existing observations (though not necessarily observations on existing markets) to estimate the value of non-marketed resources. Moreover, as with hedonic pricing methods it assumes sufficient similarity in the supply and demand functions in the study and policy sites to make the transfer credible. This is a very stringent condition. While the approach has the attraction of being very low cost by comparison with other methods it cannot avoid the biases in those other methods, and it can only be as useful as the similarity condition allows.

12.3.6 Concluding remarks

To summarize the main points in this Chapter:

- **Valuation** is a method for determining the importance of environmental consequences of economic activity that are not taken into account in market transactions.

- Valuation makes it possible for resource users and environmental authorities to make informed decisions about the allocation of resources to biodiversity conservation. However, valuation does not necessarily imply that resource users should always trade off biological resources and commercially traded goods. Some individuals would no sooner trade off the life of a non-human organism against some traded good than they would trade off the life of a human. There are resources that are **perfect complements** to all other resources, whether because they are necessary to the production or consumption of all other resources or because people refuse to trade them off for moral, religious or ethical reasons.
- Biodiversity is a **public good**. It is therefore **non-exclusive** and **non-rival** in consumption, at least up to some capacity constraint. That is, up to a point the addition of more people does not reduce the benefits to any user. Nor does it exclude any other user. However, beyond that point the costs of additional people may increase very sharply.
- The public good nature of biodiversity complicates valuation. While the information requirements are higher, the reliability of data is lower, and people have a strategic interest in understating their willingness to pay to acquire benefits (the **free-rider problem**).
- There are two main approaches to estimating the value of non-marketed environmental effects of economic activity: (a) the use of **surrogate markets** to **reveal preferences** of resource users, and (b) the use of **simulated markets** to get resources users to **state preferences**. The main examples of these approaches are described in the Chapter.
- the probability distribution of all possible outcomes is also known.

By contrast, the outcome of an action is said to involve uncertainty when:

- the set of all possible outcomes of that action is unknown; and/or
- the probability distribution of the outcomes of the action is unknown (Dow 1993).

This chapter considers how the valuation of biodiversity is affected by incomplete information of each type, and hence how decisions involving incomplete information are made.

Most scientists would probably argue that biodiversity loss is characterized more by uncertainty than by risk. However, economic analysis deals more with risk than with uncertainty. Indeed, the theory of decision-making under uncertainty is much less well developed than the theory of decision-making under risk. The dominant approach to the analysis of risk in economics is the 'expected utility' approach by which individuals are assumed to evaluate a risky prospect in terms of the mathematical expectation of the value or utility to them of the prospect. The approach is described in Box 12.4-1. How well this approach explains real attitudes to risk has long been disputed. The empirical evidence suggests that many of the fundamental assumptions or axioms of the approach do not reflect reality. There is evidence, for example, that individual attitudes to risk are highly sensitive to income, and hence that attitudes to risk are not nearly as consistent as is assumed in the expected utility approach. People tend to be risk averse at low levels of income and risk averse or risk loving at high levels of income (Friedman and Savage 1948). While there have been no studies of attitudes to the particular risks associated with biodiversity loss, this observation would indicate that people place a lower weight on the biodiversity risks of economic activity the more affluent they become!

People also turn out to have asymmetric attitudes to gains and losses. Three such effects turn out to be important to the valuation of biodiversity: the reference point effect, preference reversal, and differences between willingness to pay (WTP) and willingness to accept (WTA). Empirical research has shown that individual decisions in the face of risk are frequently based on a reference point, usually represented by the initial endowment or status quo. Prospect theory (Kahneman and Tversky 1979) suggests that outcomes are interpreted by agents in terms of the reference point of their current asset position. It emphasizes the relevance of loss aversion. The aggravation experienced as a consequence of a loss often appears to be greater than the increase in utility due to a

12.4 The problem of risk and uncertainty

12.4.1 Distinguishing risk and uncertainty

Many of the effects of the reduction in biodiversity, in both the short and long term, are characterized by incomplete information. When individuals and societies value such resources they often do so in the knowledge that their understanding of the effects of their loss is imperfect. Indeed, people's understanding of the future effects of biodiversity loss is, if anything, less than their understanding of the future effects of climate change. How does this affect their valuation of biological resources? This chapter considers the ways in which incomplete information influences both the valuation of biodiversity and the decision-making process.

Economists typically distinguish between two classes of incomplete information: 'risk' and 'uncertainty'. The outcome of an action is said to involve risk where:

- the set of all possible outcomes of that action is known; and

gain of the same amount (the utility function is steeper for losses than for gains). Experimentally, similar behaviour has been observed when two prospects are designed in such a way that one implies a high probability of obtaining a modest gain, and the other implies a low probability of a remarkable gain. In this case people systematically choose the less risky situation in a direct choice (reveal a higher WTP for it), but place a higher value on the second alternative (reveal a higher WTA for it) if they were to sell it.³ What makes this behaviour important in the context of the valuation of biodiversity is that it suggests that individuals might be expected to assign much greater weight to the loss of a biological resource (say a species) than they would to an equivalent gain. This effect has not, however, been tested in work on the valuation of biodiversity loss.

Another source of difficulty for the expected utility approach is that empirical evidence suggests that attitudes to different prospects may not be independent, as is assumed in the approach. The famous Allais paradox,⁴ for example, turns out to be a special case of a general pattern known as 'common consequence effect'. This holds that if there are only two options of equal probability, the better off individuals would be in the event of one option, the more risk averse they became over the other (see, for instance, MacCrimmon and Larsson 1979; Kahneman and Tversky 1979; Karmarkar 1974, 1978; McCord and de Neufville 1983, 1984).

³ This phenomenon was first reported by psychologists Slovic and Lichtenstein (1971). Further evidence has been provided by Lindman (1971), Mowen and Gentry (1980), Pommerehne *et al.* (1982), Reilly (1982) and Berg *et al.* (1983).

⁴ This is one of the best-known examples of empirical evidence against the expected utility model. The paradox can be illustrated by the following example (Machina, 1989; p. 22). The problem involves obtaining the subjects' preferred option from each of the following two pairs of gambles:

a_1 : 1.00 chance of US\$1 000 000
versus

a_2 : 0.10 chance of US\$5 000 000
0.89 chance of US\$1 000 000
0.01 chance of US\$0

and

a_3 : 0.10 chance of US\$5 000 000
0.90 chance of US\$0
versus

a_4 : 0.11 chance of US\$1 000 000
0.89 chance of US\$0

According to the expected utility hypothesis, a risk averse individual (relatively steep indifference curves) would prefer a_1 in the first pair and a_4 in the second pair, while a subject with relatively flat indifference curves would choose the gambles a_2 and a_3 . However, it has been found that most subjects choose a_1 in the first pair and a_3 in the second. This implies that indifference lines are not parallel but rather that they 'fan out'.

It is also now well understood that the power of the expected utility hypothesis declines as the probabilities of outcomes tend to unity or to zero. In the former case the probability of an 'almost sure' event tends to be approximated by certainty. In the latter case, people facing a 'very unlikely' event tend either to overestimate the probability or to identify it with zero. What this means is that for very low probabilities the weighting function is not defined. In the liability insurance markets it has been found that for cases in which the probability is very low but the potential loss is very high insurers demand a risk premium that makes the rates exceed the expected losses. At the same time, the insured are willing to pay less than predicted by expected utility calculations (Katzman 1988). This aspect has been widely dealt with in the literature on environmental liability insurance (see, for instance, Farley 1982; Martz and Bryson 1983; Sterling 1984). Many of the risks associated with biodiversity loss, like the 'risks' associated with climate change, are potentially catastrophic but of low probability, and hence difficult to deal with in expected utility terms.

Finally, an important part of the difficulty in valuing the risks of biodiversity loss derives from the fact that biodiversity has many of the characteristics of a public good. Empirical differences in estimates of willingness to pay and willingness to accept may well reflect the reference point effect already described in this chapter, but they also reflect the valuers' perception of the availability of substitutes for the resources under consideration. While considerable investment is now taking place in the development of private substitutes for at least the genetic and pharmaceutical properties of biological resources (through pharmaceutical research and development, biotechnology and the establishment of genetically defined intellectual property rights) there is little evidence that private substitutes can be found for the ecosystem functions lost in the process of species deletion.

In many situations the lack of information or insufficient experience do not allow individuals to know the probabilities to be attached to the different alternatives they face when making a choice. This kind of incomplete information is addressed in different ways in the literature. One approach, due to Savage (1954), is to use subjective expected utility. In this approach decision-makers handle the lack of information by formulating subjective opinions about the likelihood of the future consequences of their decisions. In both the subjective and ordinary expected utility approaches decision-makers are led by the knowledge of a probability distribution – the only difference being that one distribution is subjective and the other objective. In the subjective expected utility approach, complete ignorance is addressed through the assignment of equal probabilities to all states of nature (the so-called principle of indifference or insufficient reason) (Arrow and

Box 12.4-1: The expected utility hypothesis.

The expected utility hypothesis arose from the observation of the inadequacy of the mere expected value as a measure for the attractiveness of a risky prospect.^a It is based on the assumption that individuals evaluate a risky prospect in terms of the mathematical expectation of the utility induced by the prospect. Thus, the attractiveness of a gamble offering the payoffs (x_1, \dots, x_n) with probabilities (p_1, \dots, p_n) is evaluated not by the expected value of the payoffs,

$\bar{x} = \sum_{i=1}^n x_i p_i$, but by the expected utility associated with those payoffs: $EU = \sum_{i=1}^n U(x_i) p_i$, where $U(\cdot)$ is what is termed a von Neumann–Morgenstern utility function.^b

The von Neumann–Morgenstern utility function assumes that preferences between prospects are transitive, continuous and independent,^c which makes it simple to characterize individual attitudes toward risk. If individuals are averse to risk, for example, their von Neumann–Morgenstern utility function is concave. Indeed, it is possible to refer to concavity, linearity, and convexity of the von Neumann–Morgenstern utility function as, respectively, risk aversion, risk neutrality and risk loving.

Concave utility function of a risk averter

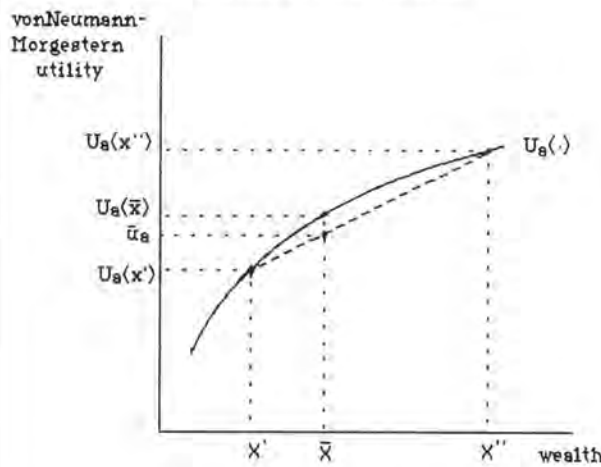

Convex utility function of a risk lover

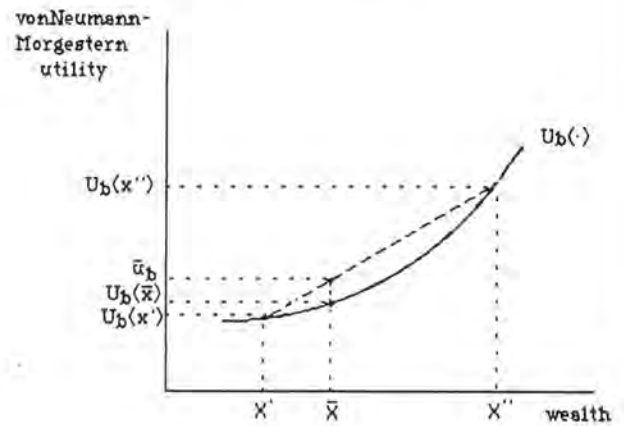

^a A prospect can be defined as a vector of probabilities that given states of the world will occur, with the corresponding vector of the outcomes associated with such states of the world.

^b It differs from the ordinal utility function of standard consumer theory in that the only transformations to which it can be subjected are positive linear ones, i.e. transformations that do not affect the shape of the function itself. The von Neumann–Morgenstern utility function $U(\cdot)$ can thus be replaced by any other $\bar{U}(\cdot)$ which is cardinally equivalent, in the sense that:

$$\bar{U}(\cdot) = \alpha U(\cdot) + \beta$$

for some multiplicative constant $\alpha > 0$ and an arbitrary additive constant β .

^c These three properties are embodied in the following axioms:

- (i) Complete-ordering axiom. For the two alternatives A and B one of the following must be true: the consumer either prefers A to B, prefers B to A, or is indifferent between them. The consumer's evaluation of alternatives is transitive if, preferring A to B and B to C, they prefer A to C.
- (ii) Continuity axiom. Let A be preferred to B and B to C. The axiom asserts that there exists some probability p , $0 < p < 1$, such that the consumer is indifferent between outcome B with certainty and a lottery (p, A, C) .
- (iii) Independence axiom. Let A be preferred to B, and C be any outcome whatever. If one lottery L_1 offers outcomes A and C with probabilities p and $1 - p$ respectively, and another L_2 offers the outcomes B and C with the same probabilities p and $1 - p$, the consumer will prefer L_1 .

Hurwicz 1972). But this presumes knowledge of the full range of possible outcomes, and the lack of such a knowledge is just what distinguishes genuine uncertainty from risk.

To account for genuine uncertainty (where the consequences of any choice are a function of unknown states of nature, and there exist no historical precedents and no *a priori* information on which to assign subjective

Box 12.4-2: Models of Fundamental Uncertainty.

As the loss of biodiversity involves fundamental uncertainty as distinct from risk, it is interesting to consider how this is currently being treated in the literature. Much of the development of Shackle's ideas is due to Vickers (1978, 1994) and Katzner (1989a, b). Earl (1983) absorbed it into the framework of behavioural economics, and it is also evident in other discussions of decision-making in ignorance (Georgescu-Roegen 1971; Arrow and Hurwicz 1972). Shackle's main concern is the agent's behaviour when facing a decision that is 'unique' and 'crucial': unique, in the sense that it relates to a particular decision-maker at a particular point of time, and to a set of characteristics unlikely to be replicated anywhere else in the system; and crucial in the sense that, once it is carried out, the pattern of the system as a whole is altered, and it is no longer possible to go back and repeat the same conditions. It is assumed that decision-makers imagine an incomplete collection of states of the world seen as possible consequences of their choice, and form non-probabilistic opinions about their possible occurrence. To each of such states decision-makers relate a measure of the degree of disbelief they would experience at their occurrence. The extent to which they believe an hypothesis may occur is bounded by their perception of what can happen, consistent with what they know about physical and economic processes.

The degree of disbelief is also referred to as *potential surprise*. There exist potential surprise density functions, each defined over possible outcomes associated with a particular decision, and all highly personal and subjective. Nonetheless, they are assumed to be precisely specified and well defined. These functions map all the subsets of the incomplete list of states of nature into a closed interval $\{0,1\}$, as with a probability distribution. Katzner (1986) introduced the concept of 'potential confirmation' as complementary to that of potential surprise. This is the proper expression of uncertainty, within the Shackleian framework, to be compared with probability. Both the set of imagined possible states of the world and the potential surprise function, depending on the individual's evolving informational status, are unique to each moment of historical time.

Despite the similarities, the potential surprise density function cannot be considered equivalent to an inverted probability density function (potential surprise is not equal to 'one minus probability'). Since the set of imagined possible states is not necessarily the complete collection of all possible outcomes, it need not be that the potential surprise associated with the residual hypothesis is unity. The individual's beliefs may be such that he does not exclude the occurrence of an unimagined outcome. Hence, the sum of the potential surprises of a hypothesis and its antithesis may be different from one (Katzner 1995).

The set of available choices is ordered by an 'attractiveness function' which is constructed by the decision-makers on the basis of their own cognition. It measures the extent to which each outcome gets the attention of the decision-maker and reflects both utility outcomes and potential surprise. Maximization of the attractiveness subject to the potential surprise density function forces the decision-maker to focus his attention on two particular outcomes: respectively the best and the worst among the least potentially surprising ones. The former is what Shackle refers to as 'focus gain', and the latter as 'focus loss' of a decision. They can be considered as the parallel, in a non-probabilistic context, of a choice's expected benefit and expected cost. So possible outcomes with high associated costs will be taken into more careful consideration the smaller is the potential surprise they involve. The introduction of a decision function over the set of pairs of focus gains and losses then permits the subject to make a choice from them.

probabilities to the different states of nature) some economists are developing alternative approaches. Much of this work is stimulated by the separate ideas of Shackle (1955, 1969), Abbott (1955) and Simon (1957) (see Box 12.4-2). The last two acknowledged that limits and lags inherent in individual learning process about the dynamic environment in which decisions are to be taken, resulted in a more limited rationality, usually referred to as *bounded rationality*. Such limitations force agents to pursue 'satisficing' rather than optimizing behaviour. On the other side, Shackle argued for a complete change in the decision model.

The treatment of uncertainty in the Shackle approach does not require estimates of the probability distribution of

outcomes. However, if (1) such estimates do exist and the problem has become 'routine' in the sense that all functions remain constant over time, and (2) none of the sources of bias discussed in the previous subsections are present, then the potential benefits and costs of a decision (what is referred to as its focus gain and focus loss) may approximate the expected benefits and costs of that decision in utility terms. If the set of possible outcomes of a decision and the probability distribution of those outcomes are both known, then the decision will certainly be routine in the sense of Shackle. In this case the outcome may very well be similar to the optimal outcome under an expected utility approach. However, if the decision-maker's attention is drawn to some particular outcome (as it tends to be in,

say, the aftermath of a disaster) then the decision-making process will become non-routine, and the Shackle outcome will be very different from the expected utility outcome. More importantly, the implicit valuation of the resources concerned will be different from the valuation derived from an expected utility approach. Indeed, the Shackle approach indicates that any valuation of biological resources will necessarily be highly context-dependent. It will depend less on the opportunity cost of committing the resource to some use, than on the range of factors that draw the decision-maker's attention to the particular use whose focus loss and focus gain are being evaluated.

12.4.2 Risk and uncertainty in environmental decision-making

If decision-makers face risky situations, then what criteria should they employ? A natural choice following on from expected utility theory is to make use of expected values, with some adjustment for risk aversion (or, less usually, risk seeking) on the part of those affected by the decision. Thus if a nuclear power station involves a quantifiable risk of serious leakage, and if monetary values can be placed on damages should leakage occur, then the expected value of the damages can be calculated as simply the product of the probability of an accident occurring and the value of damages should an accident occur. If expected values can be calculated for risky costs and benefits, then an 'expected net present value' for any project /policy where this information is available can also be calculated within the framework of cost benefit analysis (CBA). Risk attitudes are allowed for by either adjusting the discount rate upwards by a 'risk premium', if risk aversion is desired⁵; or by finding the 'certainty equivalent' of the expected damages (that certain level of damage which would give the same disutility as the uncertain, expected level of damage).

However, the empirical evidence on people's attitudes to environmental risk discussed above raises questions about the value of such an approach. For example, McDaniels *et al.* (1992) refer to 'dread' as the phenomenon which increases subjective risk assessments connected with, for example, nuclear power or toxic waste disposal; lower 'dread' events such as car accidents are subject to under-assessment of risks. Econometric analysis has shown that risk rating has a higher effect on willingness to pay for risk-reduction measures in infrequent high dread situations, than in frequent low dread situations. Unless the analyst has information on these subjective preferences, the outcome may be inefficient. Finding the public's perception of risk is in itself difficult: Loomis and du Vair (1993) show that different ways of portraying the same risk reduction to

individuals (in this case, from improving safety at hazardous waste sites) produce statistically different estimates of willingness to pay for the risk reduction.

Second, the expected utility framework may not describe very well how individuals rank or value risky alternatives. Evidence suggests that individuals value different sorts of risks differently, even if the expected values are equal. For example, the degree of familiarity and the extent to which respondents are 'in control' of the risk have been shown to be important (Knetsch 1993). Individuals are more averse to risks beyond their control (as are the risks of biodiversity loss or climate change) than they are to risks in their control. But their willingness to pay to avoid risks will be influenced by the degree to which they can capture the benefits of risk reduction: i.e. by the public good nature of the risk. Where they can capture the benefits of risk reduction, individuals tend to take actions that influence either the magnitude of (usually undesirable) events should they occur, or the probability that they will occur. The former action is termed 'self-insurance' and the latter 'self-protection'. Other species behave in the same way. Where they cannot capture the benefits of risk reduction, as in many publicly funded programmes to reduce the risks of, for example, carbon emissions, they tend to understate their willingness to pay for a reduction in risk.

The treatment of risk in project/policy appraisal has also been concerned with the extent to which individuals, firms or society as a whole can reduce risk by diversifying. This is easy to imagine for a financial investment: investing money in a single stock seems likely to be riskier than investing money in several stocks, having some regard for the expected covariance of their returns. The Capital Asset Pricing Model, one of the principal theories of finance, states that investors will only be rewarded by the market for that part of the risk which cannot be diversified away by holding an 'efficient' portfolio of assets. Swanson (1992) has likened the preservation of biodiversity to such a portfolio effect, and refers to this as an insurance service. If different species vary in their sensitivity to environmental change, then reducing the variety of species 'held' by society in its portfolio is akin to increasing the risk that society bears. Homogeneity increases risk, although it may also (as in agriculture) increase financial returns, at least in the short run. Increasing diversity reduces overall risk at the expense of lower financial gain, although, as the reader will be well aware by now, the true economic benefits of biodiversity preservation exceed those recorded in market transactions.

A second feature of risk reduction via diversification is the effect on the discount rate. Arrow and Lind (1970) argued that, as the number of people bearing a risk goes towards infinity, the risk premium each demands goes to zero. Since many, if not all, of the Earth's citizens bear the risks associated with biodiversity loss, it might be argued

⁵ See Hanley (1992) for a summary of the debate on whether or not this is good practice.

that those decisions about biodiversity preservation made using CBA should use a risk-free discount rate. This would be incorrect, however (Brown 1983). To the extent that the costs of biodiversity loss are non-rival in consumption (such as an increase in the threat of global extinction), then the number of persons bearing the loss has no effect on the cost to each in this worst of all cases. If this is accepted, then the risk premium should not be deducted from the discount rate.

In many cases uncertainty is such that we cannot calculate expected net present values (NPV) since the range of possible outcomes and/or their probabilities is unknown. In the case of the construction of a nuclear power plant, for example, a certain, scientifically calculated risk can be attached to the occurrence of a serious accident. The full consequences of such an accident, however, in terms of monetary loss, human suffering and duration of the effects, is necessarily uncertain. Likewise, the consequences of an action which causes loss of biodiversity may not be foreseen until after the action has been taken. (This necessitates particular care when the action will be irreversible). An example of unforeseen consequences is the experience of Bangladesh which, between 1977 and 1989, exported frogs for the growing Western (particularly American) market. By 1988 exports had reached 50 million per year, earning US\$10.5 million in foreign exchange. However, the fact that frogs, by eating waterborne paddyfield pests, performed an essential function, was not reflected in the market and was therefore overlooked. By 1989 when the government introduced a ban on exports, the frog population was estimated to have fallen to 400 million and, to compensate, farmers were importing \$30 million of the worst quality pesticides, annually. That the net economic effect of frog exports was negative, is plain. The damage to watercourses and health is unestimated.

The export of frogs from Bangladesh is an example of a decision without historical precedent. In Shackle's terms it was one in which the choice options, imagined states of the world, potential surprise function, utility and attractiveness functions were all peculiar to the decision moment. The decision involved fundamental uncertainty, and the actual outcome turned out to be very different from the expected outcome. The question considered below is what options were open to decision-makers if they had wished to take the fundamental uncertainty associated with the decision into account.

12.4.2.1 Scenario analysis

This involves taking each known state of the world, and calculating NPV assuming this state of the world actually exists. In this case, 'pay-offs' (that is, costs and benefits) must be calculable for each state of the world that it has been possible to identify. In practice, the analyst would limit attention to a subset of known states of the world,

choosing, perhaps, extreme values (pessimistic and optimistic) and values thought most likely. Different decision-theoretic rules such as maximin or minmax regret can be applied to such a pay-off matrix in order to identify the desired course of action.

12.4.2.2 Extended scenario analysis (sensitivity analysis)

This involves seeing by how much NPV changes as the state-of-the-world changes; particular attention is paid to that point at which NPV changes sign; and to determining the variable to which NPV is most sensitive. If uncertainty exists over many parameters of the decision, then the major weakness of sensitivity analysis is that it proceeds on a *ceteris paribus* basis.

12.4.2.3 Monte Carlo analysis

This involves specifying frequency distributions for each parameter, and then simulating simultaneous changes in all parameter values according to random sampling from these distributions.

12.4.2.4 Worst-case scenario

In this approach the worst case is assumed to be the true scenario. In this case, the highest level of environmental damage that could conceivably result from the loss of a habitat type in a particular country, for example, would be assumed to be the true level, and a CBA would be carried out on this basis. This effectively implies use of a maximin regret principle, which is similar to a precautionary principle.

12.4.3 The precautionary principle and safe minimum standards

Environmentalists often argue that where the costs of current activities are uncertain, but are potentially both very high and irreversible, society should take action before the uncertainty is resolved, since the costs of not taking action may well be greater than the costs of preventative or anticipatory action taken now (Taylor 1991). The policy of taking action before uncertainty about possible environmental damages is resolved has been referred to as the 'precautionary principle'. The principle is argued to have originated in Germany as the concept of '*Vorsorgeprinzip*' (Haigh 1993), and has been defined in the Declaration of the Third Ministerial Conference on the North Sea as:

...action to avoid potentially damaging impacts of substances that are persistent, toxic and liable to bioaccumulate even where there is no scientific evidence to prove a causal link between effects and emissions (quoted in Haigh op.cit.).

The stress is thus on the avoidance of potentially damaging actions in the face of uncertainty about future

outcomes; a deliberate act of risk reduction. More recently, the principle has been broadened to include the concept of 'ecological space': that is, of not '...pushing all actions to the limits of ecological tolerance'. Haigh (1993) argues that instances of the precautionary principle (PP hereafter) being applied include the Montreal Protocol on substances likely to damage the ozone layer; the North Sea conference decision to reduce polluting inputs to the North Sea by 50% by 1995; and the EC agreement to reduce CO₂ emissions. Indeed, the 1874 Alkali Act, often cited as one of the first pieces of environmental legislation in the UK, did not insist on *proof* that gases discharged from factories actually caused deleterious health effects, before they could be subject to control. More recently in the UK, the 1990 White Paper, *This Common Inheritance* states the PP as a first principle of environmental policy.

The PP, which can be extended to many areas of environmental management, thus seems to be a widely accepted principle for wise environmental management. Indeed, it has also been argued to be an essential part of any sustainable development strategy, in the 1990 Bergen Declaration (signed by 84 countries as a follow-up to the Brundtland Commission report). The PP has also been advocated for decisions over the preservation of biodiversity (Myers 1992). However, two qualifications have emerged. First, the Rio summit called for all countries to apply the PP, but only '...according to their capabilities', implying that the costs of actions under the PP should be considered, and might be deemed too great for some (poorer) countries. Second, the UK Government in the 1990 White Paper referred to above, stated that the PP should only be applied '...if the balance of likely costs and benefits justifies it' (paragraph 1.18). There is thus some requirement for the benefits of implementing the PP to be in a sense proportional to the costs. This second restriction is rather more severe, since to apply it would involve some estimates of the probabilities of different possible outcomes being known, that these outcomes could be physically described, and that they could be valued in monetary terms. But if this were so, then a more formal application of cost-benefit analysis could guide policy analysis: the PP would be incorporated in the treatment of risk (for example, by giving greater weight to the worst possible outcomes).

However, it should be noted that some have taken acceptance of the PP to mean that society should have as a firm objective the total elimination of activities where uncertain environmental damages are involved (Taylor 1991). Examples of such bans do exist: for example, the banning of the disposal of radioactive wastes in the deep ocean, and the incineration of toxic wastes at sea. Alternatively, the PP could be taken to mean the minimization of inputs of any effluent to any ecosystem. However, the economist might worry that the costs of either banning the disposal or minimizing the input of

effluent would be disproportionately large, and incur unnecessarily high opportunity costs for society. For example, deciding to enforce a 50% reduction in fossil fuel emissions now, in line with the most pessimistic predictions about the damages associated with, and the extent of, global warming would involve very high costs in terms of losses in current social welfare. Accepting the PP also assumes that the worst environmental outcome will definitely occur, which as Grout (1981) has argued is unreasonable if this is only one of a (very large) number of possible outcomes.

There is a close link between the precautionary principle described above, and the safe minimum standards (SMS) approach, proposed by Ciriacy-Wantrup (1968) and Bishop (1978). The SMS approach involves setting quantitative and qualitative minimum limits for, in this case, biodiversity preservation. These limits are then upheld unless the social opportunity costs of doing so are 'unacceptably high'. What constitutes an unacceptable opportunity cost is to be decided either by policy-makers, on behalf of the electorate, or by the electorate directly through public forum. The SMS approach has been characterized as a means of minimizing maximum possible losses to society in the face of (1) uncertainty over the benefits of (biodiversity) preservation; and (2) the irreversible nature of environmental losses. Hanley *et al.* (1991) suggest that the existence of policies that protect a safety net of habitat types, such as the Sites of Special Scientific Interest in the UK, are an example of the SMS principle in use. Sites of Special Scientific Interest may be lost if the costs of preserving them are too high in terms of the government's conservation budget, but the presumption is in favour of their protection, regardless of any cost-benefit analysis. More generally, SMS scheme places the onus on those wishing to allow environmental losses to prove that the opportunity costs of preservation are 'too high'.

12.4.4 Concluding remarks

In summary, there are four points about the incomplete information associated with the effects of biodiversity loss that are important to the valuation of biological resources:

- Many of the short and long-term effects of the reduction in biodiversity are characterized by incomplete information. Two classes of incomplete information are considered: **risk** and **uncertainty**. Risk exists where the set of all possible outcomes of an action and the probability distribution of those outcomes is known. Uncertainty exists where the set of all possible outcomes of that action, and/or the probability distribution of the outcomes of the action is unknown.
- Some of the consequences of a change in biodiversity involves risk. Most consequences involve uncertainty,

particularly where the changes concerned are irreversible and the evolutionary response of the natural system is unpredictable.

- Consequences that involve risk may be commercially insurable. Consequences that involve uncertainty may not be commercially insurable. A **precautionary** approach to uncertain consequences is to protect the capacity of the system to absorb them.
- The ecological redundancy in current biodiversity has an **insurance value**, in that it enables the system to maintain the flow of ecosystem functions under changing environmental conditions. A precautionary approach is to apply **safe minimum standards** involving quantitative and qualitative minimum limits for biodiversity preservation. The **SMS** approach has been characterized as means of minimizing maximum possible losses to society in the face of (1) uncertainty over the benefits of (biodiversity) preservation and (2) the irreversible nature of environmental losses.

There are several reasons why treatment of the environmental 'risks' associated with biodiversity loss within expected utility framework is problematic. First, as mentioned above, even when the increase/decrease in risk that will result from an action is known, the device used to convey this risk to the individual in a valuation exercise can significantly affect the value that is placed on its reduction. The Loomis and du Vair study considers risk which is well defined, and for which the costs and benefits of reduction pertain to the individual concerned. But consistent responses cannot be obtained even for risks such as these. Valuations of increased risk due to biodiversity loss must necessarily be more vague still, both because of free-rider effects in the gains from reduced risk (the public good problem again) and because of uncertainty over the gains themselves. That is, the extent to which a given reduction in local biodiversity loss reduces global (and even local) risk is uncertain and therefore difficult to value, even in the absence of information constraints and problems of perception.

Maintenance of biodiversity does reduce risk. As species are progressively lost, the risk that some disaster threshold may be reached with the next loss is an increasing one. In agriculture, for example, genetic diversity in cultivated crops and reserve species ensures that yields may be maintained over a wider range of environmental conditions. However, conservation as a risk-reducing device has two features that set it apart from more common risk reducers such as financial insurance. These are the fact that many outcomes of biodiversity loss are fundamentally uncertain, and that biodiversity is a public good. The fact that the benefits of conservation do not all accrue to the conservationist means that the level of conservation

resulting from a cost-benefit exercise could be economically inefficient.

The irreversible nature of biodiversity loss and the uncertainty of its effects on future generations both favour adoption of the precautionary principle. Indeed, it is not wholly misleading, given the importance of biodiversity to life-support systems, to think of its conservation in terms of Pascal's Wager (as in Orr 1992). Pascal's Wager refers to a dilemma over whether or not to believe in God. In this case, the assumption is that the implication of believing is that one behaves virtuously and thus forgoes some wicked pleasures (!). Pascal's conclusion is that there is nothing to lose, and everything to gain, by believing in God. If one believes, and it turns out at the end of the day that God does not exist, then no damage has been done and life has moreover been lived virtuously (although, of course, at the cost of forgone wicked pleasures). If God does exist then eternal damnation has been escaped. Likewise, if ecosystems and biodiversity are conserved and it turns out that the risks from their destruction would not be so great after all, global society has still conserved valuable assets which yield much in terms of production and pleasure (although, by implication, we would forgo certain development benefits). If, on the other hand, it were to transpire that continued biodiversity loss spelt doom for life as we know it, then by conserving rather than destroying biodiversity, we have saved everything. The point should, however, be re-emphasized that, over the long run, preserving biodiversity *might* imply larger losses in welfare than it generates, especially if forgone development benefits turn out to be high and the importance of diversity turns out to be low.

12.5 The valuation of species and habitats: empirical results

12.5.1 Introduction

Our previous discussion of the available methodologies for the valuation of biodiversity have included occasional examples of value estimates for species, habitats and ecosystem functions. In Chapters 12.5 and 12.6 we focus on the results of empirical research on valuation. Given the nature of the research the results are far from systematic. Valuation research has tended to be driven by popular concern for charismatic mammals or birds, visually imposing habitats, and major pollution events such as the *Exxon Valdez* oil spill. Although the theoretical literature suggests the importance of refocusing on ecosystem functions, empirical research along these lines is still in its infancy.

Chapter 12.5 discusses estimates of the value of charismatic species and habitats arrived at through the use of both revealed and stated preference methods. Chapter 12.6 then considers estimates of the value of broader

ecosystem functions. The results discussed here derive from a wide range of valuation techniques. Our intention is more to give a sense of what may be achieved using these techniques, and what their limitations are, than to give credence to any one set of estimates.

Many biological resources are transacted directly on domestic or international markets. Indeed, commercial uses of resources are important for both developed and developing countries. This suggests that some direct use values of domesticated and wild resources will be reflected in the prices of 'marketed' goods and services. However, because governments and individuals can more readily perceive the economic value of marketed products (and services) of biological resources than the value of non-commercial and subsistence direct uses, the result can be a bias towards the development of the commercial use and exploitation of biological resources. This may mean not only that, for example, commercial fishing, forestry and agricultural operations may be preferred to subsistence operations but also that many natural ecosystems and habitats may be converted to other uses, including the cultivation and harvesting of domesticated species (see Box 12.5-1). The latter problem is particularly prevalent in tropical countries, where many of the world's remaining

reserves of wild resources are under mounting pressure from habitat conversion and over-exploitation (see Swanson and Barbier 1992; Barbier *et al.* 1994 for further examples).

Table 12.5-1 offers estimates of the economic value of the direct use of wild resources in a variety of economic activities. These can be highly significant, even in developing countries. If proper accounting of these values occurs, then 'sustainable management' of wild resources and their habitats may make more economic sense. The result may be less conversion of natural areas to alternative uses. For example, Barnes and Pearce (1991) demonstrate that full consideration of the commercial and non-commercial use values of different wildlife management operations in Botswana, such as small-scale group harvesting, ostrich farming, crocodile farming, tourism, safari hunting and game ranching would make these various wildlife management options more economically attractive compared to using the same game areas for cattle ranching. Similarly, Barbier *et al.* (1991) show that the direct uses of the Hadejia-Jama'are floodplain in Northern Nigeria for fishing, fuelwood and recession agriculture – much of which is for subsistence consumption by rural households – appear to offer much higher economic returns when

Table 12.5-1: Estimates of direct use value of selected wild resources in developing countries.

Activity/Use	Estimated value (\$US)	Source
Pre-ban ivory exports, Africa	\$35–45 million/year	Barbier <i>et al.</i> (1990)
Tropical non-coniferous forest product exports	\$11 billion/year	Barbier <i>et al.</i> (1994b)
Fruit/latex forest harvesting, Peru	\$6330/ha	Peters <i>et al.</i> (1989)
Sustainable timber harvesting, Peru	\$490/ha	
Buffalo range ranching, Zimbabwe	\$3.5–4.5/ha	Child (1990)
Wetlands fish and fuelwood, Nigeria	\$38–59/ha	Barbier <i>et al.</i> (1991)
Viewing value of elephants, Kenya	\$25 million/year	Brown and Henry (1993)
Ecotourism, Costa Rica	\$1250/ha	Tobias and Mendelsohn (1991)
Tourism, Thailand	\$385 000–860 000/year	Dixon and Sherman (1990)
Research/education, Thailand	\$38 000–77 000/year	
Tourism, Cameroon	\$19/ha	
Genetic value, Cameroon	\$7/ha	Ruitenbeek (1989)
Pharmaceutical prospecting, Costa Rica	\$4.81 million/product	Aylward (1993)

Sources: see references.

Box 12.5-1: The value of gum arabic.

The gum arabic tree (*Acacia senegal*) is a naturally occurring species in the Sudano-Sahel region that serves a variety of valuable economic and ecological functions. The gum produced by the tree – the ‘gum arabic’ – is widely sought after in industrialized countries for use as an emulsifier in confectionery and beverages, photography, pharmaceuticals and other manufacturing industries. In addition, the *A. senegal* tree provides fodder for livestock, fuelwood and shade. There are also numerous indirect benefits associated with these trees; for example, its extensive lateral root system reduces soil erosion and runoff, as a leguminous tree it fixes nitrogen which encourages grassy growth for livestock grazing, it serves as a windbreak and is important in dune fixation. For these reasons, the tree is the preferred species in bush–fallow rotation and intercropping farming systems prevalent in the arid West of Sudan. On a larger scale, across the Sudano-Sahelian region, the gum arabic ‘belt’ acts as a buffer against desertification.

The choice by farmers in Sudan to incorporate gum arabic trees in their farming systems will depend on whether the above benefits from a gum arabic based system exceed those of alternative systems. The potentially high financial rate of return to a gum arabic-based farming system coupled with its important environmental benefits would seem to imply that such a system would be ideal for combating desert encroachment and rehabilitating the gum belt of Sudan. However, in recent decades, the real producer price of gum arabic in Sudan has fluctuated considerably, as has the relative price of gum to its competitor cash crops (sesame, groundnuts) and even food crops (sorghum, millet). Farmers’ share of the export value of gum also remains low, which has been one reason for the recent increase in smuggling of gum to neighbouring countries.

An economic analysis was conducted of six representative cropping systems containing gum arabic cultivation in Sudan (Barbier 1992). The results are indicated in the following table.

Economic analysis of six cropping systems, Sudan (1989/90 Sudanese Pounds per Feddan, 10% Discount Rate)

	<i>Acacia senegal</i> ¹	Sorghum	Millet	Groundnuts	Sesame	All crops
BN	2 989.57	4 606.83	2 931.58	–	–	10 527.98
WN	3 923.82	–432.99	486.30	5 330.92	8 605.12	17 913.17
NK	1 471.36	–	2 091.77	–	6 020.94	9 584.07
SK	882.99	1 644.44	–	13 109.44	13 776.95	29 413.82
ND	1 240.87	–	2 363.89	9 687.69	–	13 292.45
SD	1 884.02	3 830.80	3 775.60	9 715.61	–	19 206.03
All	2 412.27	2 392.83	9 460.92	9 467.67	16 656.25	

BN = Blue Nile Province, clay soils, largeholder;
 WN = White Nile Province, sandy soils, smallholder;
 NK = North Kordofan Province, sandy soils, smallholder;
 SK = South Kordofan Province, clay soils, largeholder;
 ND = North Darfur Province, sandy soils, smallholder;
 SD = South Darfur Province, sandy soils, smallholder;
 All = Average of all six systems.

1. Total NPV from gum, fuelwood and fodder, except for Blue Nile and South Kordofan (gum only).

Source: Barbier (1992).

Although the analysis shows that all six systems are economically profitable, the relative profitability of gum compared to other crops in each system is generally lower than that of other crops – except in the Tendelti system of the White Nile where field crop damage occurs frequently. In most systems there are initial losses due to the need to establish gum gardens before they begin producing. This would suggest that maintaining the real producer price of

Box 12.5-1 cont.

gum by removing distortions in the market, as was assumed in the analysis, is a necessary economic incentive to encourage gum cultivation. However, despite the lower relative returns to cultivating gum arabic, there are several reasons why converting land under *A. senegal* to cultivating annual crops may not be desirable:

- some land under *A. senegal* may not be suitable for growing annual crops, resulting in very low and fluctuating yields;
- fallowing land may be important to maintain its fertility; gum arabic is the ideal cash crop for this purpose;
- the environmental benefits of gum arabic trees (e.g. control of erosion/runoff, wind breaks, dune fixation, nitrogen fixation) were not included in the analysis, and these may be significant in maintaining the yields of field crops within the farming systems;
- the role of the gum belt in controlling desertification certainly is significant in supporting and protecting farmingsystems in the region, and although this collective benefit cannot be captured in an analysis of individual systems, traditional farming communities in the gum belt region are very much aware of this benefit;
- risk-averse farmers may desire some of their land to be held under gum cultivation, because the returns to gum – although lower than the maximum expected returns from the cash crops – may be less variable under stressful environmental and climatic conditions;
- gum cultivation provides cash income to farmers outside of the growing season for cash crops.

In other words, the estimated rate of return understates the value of this particular resource precisely because it does not take into account the indirect value of the resource in the provision of a range of ecological functions other than the gum itself.

compared to upstream irrigation developments that are diverting water away from the floodplain. Finally, Peters *et al.* (1989) have shown that in a Peruvian rain forest the discounted financial returns from non-timber harvesting of fruit and latex plus selective cutting of timber easily exceed the returns from alternative operations, such as clear-cutting timber, plantation cultivation and cattle ranching.⁶

Now consider the position in the more developed economies. The various valuation estimates of Table 12.5-2 reflect the fact that the use of natural areas and resources tends to differ between developed and developing countries. For example, Barbier (1994b) notes that many tropical wetlands are being directly exploited, often through non-marketed or 'informal' economic activity, to support human livelihoods, e.g. through fishing, hunting, fuelwood extraction, and so forth. If they occur at all, recreational use and tourism are generally limited in comparison. In contrast, in temperate wetlands direct exploitation to support livelihoods – except perhaps commercial fishing, forestry or hunting and trapping in some areas – is on the whole less important compared to recreational, tourism and amenity values.

⁶ Although widely cited, the valuation estimate of Peters *et al.* (1989) has been recently criticized by Godoy *et al.* (1993) for being inaccurate.

Several studies have shown that recreational and other non-marketed direct use values derived from wild resources and ecosystems can be substantial in developed countries and often compare favourably with competing commercial uses of the same resource. Willis (1991), for example, estimated the total recreational value of the Forestry Commission estate of Great Britain to be around US\$79.5 million per year, whereas total annual timber sales from the estate amount to around US\$106.6 million. Hyde and Daniels (1988) also demonstrate that correct valuation and comparison of recreational use and timber production on public forest lands is important for determining the optimal use of these lands in terms of these competing market and non-marketed outputs. Similarly, Loomis *et al.* (1991) compare the economic benefits of deer hunting versus cattle ranching in the Sierra Nevada, California, through estimating the value of forage areas to deer hunters as opposed to ranchers. Coyne and Adamowicz (1992) applied the random utility model to the valuation of the site characteristics for alternative Bighorn sheep (*Ovis canadensis*) hunting sites. Data came from a mail survey of registered hunters in Alberta. This survey gave information on socioeconomic characteristics, home location of hunter, number of hunting trips, and choice of site. This gave 423 'choice occasions' when particular sites were chosen by particular hunters. A multi-nomial logit model (Greene 1990) showed that

Table 12.5-2: Estimates of Direct Use Value for Selected Wild Resources in Developed Countries.

Activity/Use	Estimated value (\$US)	Source
All freshwater fish stocks, Norway	\$128–204/adult/year	Strand (1981a) ¹
Recreational sport fishing, USA	\$2 703–4 281/person/year	Bockstael <i>et al.</i> (1987)
Recreational moose hunting, Norway	\$296/hunter/year	Soedal (1989) ¹
Recreational elk hunting, USA	\$12.74–58.33/hunter	Brookshire <i>et al.</i> (1980)
Commercial marsh and estuarine fisheries, USA	\$317–845/acre	
Fur trapping in marshlands, USA	\$151–401/acre	Bergstrom <i>et al.</i> (1990)
Coastland wetlands site amenities, USA	\$1 992–23 848	Shabman and Bertelson (1979)
Wetlands recreation amenity, UK	\$100.5–210/visitor	Bateman <i>et al.</i> (1993)
Timber sales income, UK	\$106.6 million/year	
Recreational use of forests, UK	\$79.5 million/year	Willis (1991)
Timber stumpage value from public forests, USA	\$38.72–83.54/thousand board feet	
Recreation use of public forests, USA	\$16.24/recreation-visitor-day	Hyde and Daniels (1988)
Recreation value of wilderness areas, USA	\$76/visiting household/year	Walsh <i>et al.</i> (1984)

1. Summarized in Navrud (1991) and Navrud (1992: Ch. 6).

Source: see references.

hunters' choice of site depended mainly on travel costs, total sheep population and crowding (number of hunters per unit area). This model also enabled the welfare effects of changes in these characteristics to be calculated. It was concluded that hunters would suffer a US\$7254 decrease in welfare per season if the resident sheep population fell by 10%. Complete closure of any site was also valued; these values ranged from around \$25 000 to \$4000 per season.

12.5.2 The value of genetic resources and biotechnology

Nearly all modern crop varieties and some highly productive livestock strains contain genetic material recently incorporated from related wild or weedy species, or from more primitive genetic stocks still used and maintained by

traditional agricultural peoples. Likewise, both cultivated and wild biota are important contributors to the pharmaceutical and health industries. Two-fifths of all modern US pharmaceutical products contain one or more naturally derived ingredients (Oldfield 1984). It has been estimated that at least half of the increase in agricultural productivity realised this century is directly attributable to 'artificial selection, recombination and intraspecific gene transfer procedures' (Woodruff and Gall 1992). What has already been called the *gene revolution* by genetic engineers and biotechnologists has created an important expectation about the scope for maintaining or even increasing agricultural productivity in a situation where the human population is forecast to double in size by the end of the next century.

In agriculture, genetic resources are used in two ways: (1) selecting certain species or populations for domestication and cultivation, and (2) genetically improving economically important species. The vulnerability of agriculture due to the narrow genetic base of most major crop plants has attracted considerable interest in genetic variation of domesticated species. More than 90% of the human food supply derives from a handful of grasses (wheat, rice, corn and oats), nightshades (tomato and potato), mammals (cattle, sheep and pigs), and birds (chickens and ducks) (Woodruff and Gall 1992). Their narrow genetic base is a major cause of disease and pest epidemics, and the result is a boom-and-bust cycle of agricultural yields. In that sense, the most important contribution from genetics to agricultural productivity comes from the location and use of genes for resistance to crop pests and pathogens. Disease-resistant crop varieties are currently grown on 75% of all USA croplands (Oldfield 1984).

The value of genetic diversity in this case lies in the fact that it provides the raw material for desirable genetic traits in crops. For example, mechanized harvesting of tomatoes was facilitated by a gene for a jointless fruit stalk. In nature this gene occurs only in a single population of a related species of tomato unique to the Galapagos Islands. The introduction of mechanized harvesting has meant a multi-million dollar saving for the tomato industry. The sugarcane industry had been on the brink of complete collapse on several occasions because of the *mosaic virus*, until the problem was solved by introducing resistance to it from wild relatives (*Saccharum spontaneum*). Wild coffee has been found which is resistant to the *rust* that has already devastated former coffee producing regions such as Sri Lanka, India, Java, the Philippines, etc., and wild sources of cacao have saved the industry from devastating *witches broom* (Oldfield 1984). In order to improve livestock populations, genetic resources have been used for obtaining traits that exhibit greater productivity, better resistance to pests, or specific adaptations to harsh environments. Furthermore, a multitude of species of plants, fungi, animals and microbes produce pharmacologically active substances such as alkaloids and glycosides used in Western medicine, and they cannot be considered apart from the genes and the organisms responsible for their production.

The value of genetic resources, like the value of other resources, is a function of both human preferences and technology. Recent changes in biotechnology are analysed elsewhere in this Assessment. It is clear, however, that these changes have altered both the direct usefulness (and so use value) of genetic resources, and the potential indirect consequences (externalities) of their use. For example, biotechnology makes gene transfer possible both within species and between unrelated species, increasing the utilization potential of genetic resources and hence their

value. Biotechnology, in the form of bioassays, has reduced the time and cost of screening for pharmaceutical and other uses, increasing the value of the underlying genetic resources. On the other hand, anything that raises the value of plant material may increase collection pressures, possibly leading in poorly controlled areas to over-exploitation and species loss. The indirect effects of biotechnology can be divided into secondary effects, those caused by the initial adjustments, and tertiary effects, encompassing subsequent adjustments. As a hypothetical example, biotechnology that replaced a broad spectrum synthetic pesticide with a more specific and less costly biopesticide would be expected to foster greater biodiversity of animal life in the area. This would be the secondary effect. However, as a consequence of lower costs, farmers might increase the area farmed, potentially degrading regional biodiversity, or alternatively they might reduce the land area farmed, with beneficial effects on biodiversity. These would be tertiary effects. Another example of a tertiary effect of biotechnology involves the production of pharmaceuticals. Better medicines have led to population increase which is linked with environmental degradation and biodiversity loss. However, because of their speculative nature, or because specific connections are unclear, tertiary effects receive limited attention.

There is at present very limited field experience with the products of biotechnology. In terms of the definition used in this Assessment, very few species altered by biotechnology are currently in commercial use. Consequently most indirect impacts of biotechnology applications cannot be analysed directly but rather must be assessed from related past experiences. Of these, the Green Revolution is perhaps the most relevant. Owing to the nature of the data, what can be projected most clearly of change is its direction, less clearly its magnitude. Productivity increases attributed to the Green Revolution have resulted in the same amount of food, feed and fibre being produced in the 1990s on about 40% less land than would have been required using 1960s technology. It is possible that biotechnology will have similar effects, although the reality will not be known for many years. Improvements in the feed conversion of animals (including fish) will reduce the land requirements to support the production of meat, milk and eggs. General outcomes, consistent with all types of productivity increase, include using less but better quality land, and reduced pressure for cultivating new land.

While this implies that the genetic resources embedded in the Green Revolution crops have direct value, it is not as clear what it implies for the value of the genetic resources in the supplanted crops. Traditional varieties are the result of millennia of selection by farmers, and are a major source of genetic diversity in agriculture and of genetic resources for plant breeding. Much use of such landraces ended with

Table 12.5-3: *Examples of the productivity contributions of wild relatives of crops.*

Crop	Found in	Effect on production
Wheat	Turkey	Genetic resistance to disease; valued at US\$50 million per year
Rice	India	Wild strain proved resistant to grassy stunt virus
Barley	Ethiopia	Protects California's US\$160 million per year crop from yellow dwarf virus
Hops	N. Europe	Added US\$15 million to British brewing industry in 1981 by improving bitterness
Beans	Mexico	Genes from the wild Mexican bean used to improve resistance to the Mexican bean weevil which destroys as much as 25% of stored beans in Africa and 15% in South America
Grapes	Texas	Texas rootstock used to revitalise the European wine industry in the 1860s after a louse infection

Source: see references in WCMC (1992).

the Green Revolution, when so-called improved varieties replaced the local varieties. For example, whereas Philippine farmers at one time used hundreds or even thousands of rice varieties, two varieties accounted for 90% of the area planted in one recent year (National Research Council 1993b, Ch. 1; Friis-Hansen 1994). Further improvements in varieties as a result of biotechnology are feared to displace yet more traditional varieties, exacerbating the loss of biodiversity and increasing the vulnerability of genetically uniform crops. The extent of this possible problem and appropriate management solutions are not clear.

The aggregate direct use value of biological resources and genetic material as 'raw materials' in agriculture can be approximated by the potential returns on investments in research and development of biotechnologies that may generate animal and crop breeds of potential value. The returns on this investment can be extremely high in some cases. For example, US public and private expenditure on corn breeding research in 1984 totalled US\$100 million and earned an estimated return of \$190 million. Studies that have estimated directly the contribution of genetic improvements to crop production also suggest that this value is substantial. For example, in the 1980s in the United States, the value of increased productivity of all crops from introducing new cultivars amounted to around \$1.0 billion per year. In Asia, the contribution of improved rice and wheat varieties through the Green Revolution was estimated to be \$1.5 and \$2.0 billion per year, respectively

(see WCMC (1992) for references to these studies and further discussions). Although many of these improvements have occurred through research and development finds from the existing genetic stock, in some notable cases this stock has had to be augmented by new 'finds' appropriated from wild relatives of existing crops – often to improve disease and pest resistance (see Table 12.5-3).

The appropriation of new genetic material and biological resources from the wild is also important in a number of other economic activities. For example, pharmaceutical companies are becoming increasingly interested in the potential biochemical properties of tropical species and varieties for developing new drugs. Based on data from Costa Rica, Aylward (1993) estimates that the net private returns to pharmaceutical prospecting of biological resources is around \$4.8 million per new drug developed. Over 50% of these royalty returns could realistically be allocated to biodiversity protection in Costa Rica. Such royalty arrangements may become more common as the value-added contribution of biological resources as new sources of genetic material in pharmaceutical development and other commercial products receives more attention.

An increasing number of examples illustrate that the productivity of 'integrated' domesticated and natural systems may be an improvement over monocultures. In southern Chile, for example, a combined aquaculture system based on seaweed, mussels and salmon production in coastal waters not only reduces resource use, waste problems and other environmental impacts, but if

effectively managed, will also transform excess nutrients from domestic sources into biomass and marketable products. The long-term productivity of the integrated system is an improvement over the unsustainable cage farming of salmon in monocultures (Folke and Kautsky 1992). Similarly, Lugo *et al.* (1993) demonstrate that forest plantations in Puerto Rico can be developed on converted old-growth forest land with a minimal loss of biological diversity. The resulting plantation forest could be exploited fully for both commercial timber and non-wood products.

It should be emphasized that the change in resource values as a result of biotechnology has important distributional implications. Unlike the Green Revolution's plant science, modern biotechnology is not available to those who cannot pay for it, i.e. most developing countries. It is in any case not currently well adapted to the problems of, for example, developing country agriculture. Overall spending on biotechnology research for the South is at least an order of magnitude lower than for the North. All this is despite the fact that the genetic capital which services much of the biotechnology industry leaves developing countries often free of charge (failure to protect intellectual property rights), only to return in the form of expensive new seeds, drugs and other patented items. The Convention on Biodiversity, signed at Rio de Janeiro in 1992, recognizes the validity of the unfair treatment complaints voiced by developing countries and stipulates that such countries should receive compensation for the export of their germplasm. This would go some way towards allowing developing countries to appropriate some or all of the contribution of their sovereign genetic material to global values.

Individual countries may also face difficulties, because although particular ecosystems are located within their sovereign boundaries the functions and services that flow from these ecosystems extend out beyond such boundaries. Examples include the support of mangroves for marine fisheries, the regional and global climatic influence of forest systems and the protection and water supply functions of major watershed systems. Ecological functions and services are therefore non-exclusive and contestable and thus have characteristics of common pool resources. Much will depend here on whether individual countries can directly capture a significant proportion of the function/service flow on their own territory and how important such instrumental values are to the local/regional/national economy. If biodiversity conservation loses out to national development activities then ecosystem function/service loss avoidance is possible only via compensation from developed to developing countries (Brown *et al.* 1993).

One way this might be done is via debt-for-nature-swaps. The swap works in the following way. An interested conservation agency buys up some of the developing country's international debt ('secondary' debt) on the

world's money markets. The debt is often priced at less than its face value because there is a risk that the indebted country will not pay the debt back. The conservation agency then promises to dispose of the debt in return for a promise from the indebted country that it will look after a conservation area, e.g. as a national park or a sustainably managed timber resource. Value appropriation mechanisms such as actual debt-for-nature swaps also provide an opportunity to find an approximate estimate of non-use values (existence value). By looking at what the conservation agency actually pays and the biodiversity areas conserved, a very rough approximation of the 'per hectare' value can be derived. On this basis global existence value for tropical forests would be in the order of US\$5 per hectare (Pearce and Moran 1994). There have been a number of debt-for-nature swaps so far, ranging from Bolivia to the Philippines and Zambia (Pearce and Warford 1993). Other value appropriation mechanisms are analysed in Chapter 12.6.

12.5.3 The value of species

In the late 1980s there was a dispute about the role of trade bans in the conservation of biodiversity. Most prominent amongst the trade bans being canvassed by the proponents of conservation was the ban on the ivory trade. Poaching was widespread and elephant populations in Africa were plummeting as a consequence. Some believed that the most effective way to save the elephant was to ban trade. To this end, some conservationists felt that it would be useful in the debate to have an estimate of the economic value of viewing elephants. The viewing value, to be sure, is only one component of the non-consumptive use value of preserving African elephants, but it is a start. A survey was designed to estimate the viewing value of elephants by tourists on safari in Kenya in 1988 (Brown and Henry 1993). The payment vehicle adopted was a lump sum increase in the respondent's safari cost of US\$100.⁷ A small sample size of 52 did not permit variation in the dollar amount across respondents. Those surveyed were also asked the maximum willingness to pay, in an open-ended question format. Sixty five per cent of the sample responded affirmatively to the dichotomous choice question. The average of the responses

⁷ The exact form of question and the open-ended version are:
Suppose that the current population of elephants can be maintained if additional foot, vehicle and aerial patrols are operated on a sustained and regular basis in the parks. If these patrols can be supported by a special 100 dollar annual permit (or included in each visitor's safari costs), are you willing to support this permit fee?

NO, I am not willing to pay \$100 for this permit.

YES, I am willing to pay \$100 for this permit.

I am willing to pay a maximum of _____ for this permit.
(Express this in U.S. dollars or specify in one of the currency equivalents in the table below).

Box 12.5-2: The Northern Spotted Owl.

In this study, respondents were offered a menu of five policies. Associated with each policy were three attributes: the number of acres of ancient forest protected, the number of Northern spotted owl pairs preserved and their probability of survival (or extinction); and the cost of implementing the policy (an extract from the survey appears below). Survey respondents, paid for their time, had read the subject matter and responded to questions about biodiversity, the ancient forest and Northern spotted owls before confronting the contingent ranking problem.

Survey results from just over 100 respondents were analysed using a conditional logit model (McFadden 1973, 1983; Maddala 1983) which is the standard method used by natural scientists for studying dose–response phenomena. From the parameters estimated in the analysis, it was possible to estimate that each household in the Pacific Northwest was willing to pay a lump sum of at least \$12.50 for improving the Northern spotted owl's probability of survival by 1%, from 85 to 86%, for example. They were willing to pay a lump sum amount of at least \$50 for a one million acre improvement in ancient forests preserved. These estimates are not additively separate because providing an acre of habitat is valuable in its own right and further contributes to the survival of the owl.

*Extract from the Northern Spotted Owl CV Survey***CHOOSING YOUR PREFERRED PRESERVATION PROGRAM**

There is a multitude of other options possible for protecting the northern spotted owl and the ancient forest. For now though, assume that the government must select one of the preservation options. Even if none of the options are very attractive, one must be chosen. Note that everyone across the country will pay roughly the same amount for northern spotted owl and Pacific Northwest Ancient Forest preservation once an option is selected. On the next page please choose the cost of the one option that you would want the federal government to adopt. In making your choice, be sure to consider (a) how well the problem is solved by the option compared to the other options, and (b) how much the option costs your household.

Q28. Please select the option and the amount of money your household consequently would be willing to pay to protect the northern spotted owl and the Pacific Northwest Ancient Forest. (Circle the number of the *single* best answer.)

1. **\$1 per year for ten years** to manage the spotted owl.
 - Protect 1.5 million acres (21%) of ancient forest habitat.
 - Protect 450 northern spotted owl pairs (13%).
 - The northern spotted owl would have a 2% chance of surviving in the wild for the next 150 years (a 98% chance of becoming extinct).
2. **\$32 per year for ten years** to preserve some additional ancient forests.
 - Protect 2.1 million acres (30%) of ancient forest habitat.
 - Protect 1,000 northern spotted owl pairs (29%).
 - The northern spotted owl would have a 5% chance of surviving in the wild for the next 150 years (a 95% chance of becoming extinct).
3. **\$68 per year for ten years** to preserve half of the remaining ancient forests.
 - Protect 3.4 million acres (49%) of ancient forest habitat.
 - Protect 1,600 northern spotted owl pairs (46%).
 - The northern spotted owl would have a 72% chance of surviving in the wild for the next 150 years (a 28% chance of becoming extinct).

Box 12.5-2 cont.

4. **\$107 per year for ten years** to preserve most of the remaining ancient forests.

- Protect 5.2 million acres (77%) of ancient forest habitat.
- Protect 1,900 northern spotted owl pairs (54%).
- The northern spotted owl would have a 81% chance of surviving in the wild for the next 150 years (a 19% chance of becoming extinct).

5. **\$148 per year for ten years** to preserve almost all of the remaining ancient forests.

- Protect 7 million acres (100%) of ancient forest habitat.
- Protect 2,400 northern spotted owl pairs (69%).
- The northern spotted owl would have a 90% chance of surviving in the wild for the next 150 years (a 10% chance of becoming extinct).

If the estimated willingness to pay per household to preserve biodiversity is known, it can be scaled up by the number of households to obtain a total willingness to pay for biodiversity. How many households are there? More to the point, what is the extent of the market for this particular form of preservation of biodiversity? Respondents in the Northwest, specifically in the Puget Sound region of Washington, were the source of the estimated values above. There is very little research available regarding the spatial uniformity of non-use values for specific natural resources in general and species in particular.

To learn more about the value gradient with distance, the same survey was administered to more than 100 respondents in Colorado, about 1000 miles distant (Brown *et al.* 1994, unpublished). Interestingly, perhaps provocatively for sure, Colorado residents do not appear to value the ancient forest and the spotted owl in the Pacific Northwest, apart from maintaining the status quo. They would rather spend money to preserve biodiversity closer to home.

It would be instructive to compare the estimated total economic benefits and total economic costs of preserving the owl and the ancient forest at different levels of preservation. However, present uncertainty over the spatial variability of household values make this effort fairly speculative. Comparing the actual policy choice and alternative options with the optimal level determined by economic criteria is precluded until better estimates are available.

to the open-ended question was \$89 and the median value was \$100. Converting the sample values to the adult safari population yielded values of \$22–\$30 million per year depending on the choice of median or mean value and size of population on safari.⁸

While there can be debate about the precise meaning of biodiversity, no one would cavil about including endangered or threatened species such as the Northern Spotted Owl in the Pacific Northwest in the definition. Few would want to exclude the ancient forest in the same region as an important ingredient of its biodiversity. That is fortunate because there is a study by Brown *et al.* (1994) which values the Northern spotted owl and its ancient forest habitat (see Box 12.5-2). It is a rare application of the contingent ranking technique to the area of biodiversity.

The determination of existence value from the revealed preferences of individuals or groups in expenditures on conservation is limited to actual conservation issues which often concentrate on emblematic and charismatic species or

habitats. Yet the loss of environmental quality and biodiversity would lessen human welfare in other ways. These existence values are often elicited through contingent valuation survey techniques. The willingness to pay for the preservation of particular species, simply for the perceived welfare loss from the non-existence of these species, is shown in Table 12.5-4 for a number of endangered species. The surveys on which these estimates have been made often attempt to compare existence values with other use values, and find in general that existence value may be in the same order of magnitude as other values. In the case of

⁸ The viewing value of elephants was also estimated using an alternative method, the travel cost technique, which relies on differences in rates of participation associated with different travel costs to estimate economic value (consumer's surplus) over and above actual expenditures. Estimates of annual value using this technique varied between \$23 and \$27 million annually, depending on choice of total population taking a safari in 1988.

Table 12.5-4: Existence valuations for endangered species and prized habitats.

Country	Species or habitat	Expressed value (1990) (US\$ 1990 per person per year)
<i>Species</i>		
Norway	Brown bear, wolf and wolverine	15.0
USA	Bald eagle	19.1
	Striped shiner	5.0
	Grizzly bear	18.5
	Bighorn sheep	8.6
	Whooping Crane	6.5
	Wild Turkey	11.4
	Salmon	7.6
	Coyote	5.1
	Blue whale	9.3
	Bottlenose dolphin	7.0
	California sea otter	8.1
	Northern elephant seal	8.1
	Humpback whales	40–64
	Northern spotted owl (linked to old growth forest habitat)	21
	Sweden	300 forest-related animal and plant species
<i>Habitat valuation</i>		
USA	Grand Canyon visibility	27.0
	Colorado wilderness	9.3–21.2
Australia	Nadgee Nature Reserve	28.1
	Kakadu Conservation Zone	40–93
UK	Sites of Special Scientific Interest ¹	40
	Lowland wetland bog	300
Norway	Conservation of rivers	59–107
	Preservation of coniferous forests	90–140
Sweden	Recreational and virgin forest areas	3–4
	All natural forests in Sweden	5–8

1. Conservation designation.

Source: Based on Samples *et al.* (1986), Boyle & Bishop (1987), Bowker & Stoll (1988), Stevens *et al.* (1991), Brown *et al.* (1993), Navrud (1992, 1993), and Directorate for Nature Management (1992).

preservation of endangered species, the studies by Samples *et al.* (1986) hypothesize that the expressed valuation is largely non-use existence value when respondents are informed of the endangered status of the species.

In the conservation of biodiversity there are inevitably trade-offs with other economic activities, yet existence and option values can often alone be of the same order of magnitudes as these competing uses. An example of such a study is the willingness to pay for preservation of a lowland bog area in the north of Scotland under threat from

commercial monoculture afforestation (Hanley and Craig 1991). The willingness to pay for preservation benefits of US\$300 per hectare, implicitly represents the discounted future stream of both use and non-use benefits.

If existence values are of the same order of magnitude as other indirect and non-consumptive use values, then evidence of these values indicates the scale of existence values. For charismatic species such as elephants, for example, the value elicited in contingent valuation surveys for their preservation partially represents non-consumptive

viewing values and future options to this, but also partially represents pure existence value (Brown and Henry 1993). In a contingent valuation of game viewing of elephants in Kenya, Brown and Henry (1993) elicit willingness to pay for maintenance of elephant populations using a hypothetical park entrance fee. Their results show that visitors gain approximately \$25–\$30 million per year in consumer surplus (value over what they actually pay) for viewing elephants, a proportion of which is likely to be existence value. On wider habitat protection, Moran (1994) shows that the consumer surplus attached to non-consumptive use of Kenya's protected areas by foreign visitors (as a subset of all users) is presently approximately \$540 million. As with the preservation of Scottish wetlands study, conservation of these areas therefore represents a sustainable utilization of resources, as these consumer surplus estimates are greater than estimated opportunity costs of preservation (i.e. other alternative economic activities) (Moran 1994). However, this is only a relevant policy measure if mechanisms are devised to capture existence and other non-use values.

Not all aspects of the natural world or all species are perceived in anthropocentric terms as having positive intrinsic value. In other words, observational and empirical evidence suggests negative existence values for some species. For example, festivals and cultural events in the USA focus on making undesirable native species locally extinct. These include rattlesnake 'round-ups' in Texas and elsewhere, and the shooting of prairie dogs in Colorado. Although the justification for these events often stresses the economic and supposed ecological 'benefits', they also are justified in terms of potential human welfare (an indirect use and option 'value') and by a general aversion to the species (Weir 1992).

Surveys of the motivational bases of hostile attitudes to invertebrates find that invertebrates are associated with disease and agricultural damage (an indirect use or option valuation again), but also that hostility is promoted by perceptions of invertebrates having no identity or consciousness (Kellert 1993). This is strong anthropocentrism; in other words invertebrate species do not have the same intrinsic rights as, say, mammals, and the 'desire for sterile home environments and modern theories of disease transmission may exacerbate human fears, particularly in highly urbanized, industrial societies' (Kellert 1993; p. 852). The policy implications of this aversion and the negative existence values of species would seem to be to provide information on their ecological importance within whole ecosystems and therefore the importance (primary value) of a whole system evolving in a 'healthy' condition.

12.5.4 Estimates of the value of Parks and protected areas

An increasing number of studies in recent years have applied various valuation methods to value Parks and other protected areas. Here we select a small sample of these

studies to illustrate the use of different valuation methods in valuing different forest products, services and functions of tropical forest habitat and to provide a sense of the range of values that are obtained compared with traditional forest values.

Tobias and Mendelsohn (1991) have estimated the value of ecotourism in the Monteverde Cloud Reserve in Costa Rica using the travel cost method. This study avoided the problem of meanderers by studying only Costa Rican visitors, for whom the sole purpose of the journey was to visit the site in question, the Monteverde Cloud Forest Biological Reserve. Costa Rica's 71 Cantons were used as observations, and visitation rates and the cost of travel were calculated for each one. Demand for the site was estimated as a function of price, population density and illiteracy rate, yielding the expected coefficients, negative, positive and negative, respectively. The average consumer surplus for the sample was estimated at US\$35, which, extrapolated over the entire visitor population and using a real rate of interest of 4%, yields a net present value for recreational use of the forest of \$1250 per hectare. The World Bank estimates that activities related to tourism world-wide approaches \$2 trillion annually. Ecotourism is emerging as one of the fastest growing components of this industry, with as many as 235 million individuals participating in 1988, resulting in economic activity estimated at \$233 billion. More than half of this ecotourism was related to animals (Filion *et al.* 1994).

This is probably an underestimate since foreign consumer surplus is assigned the domestic value; in fact it is almost certainly higher, and growth in visitation rates is not accounted for. Even so, since the preservation cost of Costa Rican rain forest is between \$30 and \$100 per hectare, this measure of value alone would appear to provide a clear justification for expansion of the conservation programme. They obtained a net present value of ecotourism benefits (consumer surplus) for both domestic and foreign visitors totalling US\$8 million for the 10 000 ha reserve or \$1250 per hectare. This compares very favourably with a \$30–\$100 per hectare price of agricultural land in surrounding areas. Therefore, conversion of forest land to agriculture in the area would result in a social loss of \$1000 per hectare, while expansion of the reserve would generate a substantial social gain. Yet, if the ecotourism value of the forest is not internalized to local landowners, expansion of the parks is uneconomic in private terms.

Munasinghe (1993) presents the preliminary results from a World Bank study that assesses the costs and benefits across different socioeconomic groups resulting from the creation of Mantadia National Park in Madagascar (see Kramer *et al.* (1992) and Kramer (1993) for more details on this study). Like many other tropical developing countries, Madagascar is one of the world's most ecologically rich

countries, but is also one of the world's most economically poor countries. In response to the severe threat of forest degradation and biodiversity loss, Madagascar is considering creating additional parks and national reserves. To offset the opportunity costs imposed on local people by park creation and to increase the likelihood of forest protection, nature tourism and buffer zone activities have been included in some park projects.

Two of the more important and more difficult to measure economic impacts of national park creation are the costs incurred by local villagers and the benefits received by foreign tourists. The opportunity cost approach, travel cost method and contingent valuation approach were used to assess these values in the new Mantadia National Park. To estimate the proportion of travel expenditure which should be attached to the site in question, a series of questions was prepared regarding costs, itinerary, willingness to pay for the site, as well as economic and sociodemographic characteristics. The preliminary results are summarised in Table 12.5-5.

The *opportunity costs of park creation* incurred by local villagers include the forgone benefits they previously derived from the forest, such as fuelwood, fish, animals, grasses, and fertile land for shifting agriculture. A survey of 351 households in 17 villages within a 7.5 km radius of the park boundary was conducted. The survey indicated that most households engage in shifting cultivation and rely on forest clearance for their land. In addition, they obtain significant quantities of fuelwood, crayfish, crab, tenrec and frog from the forest. Using market prices in conjunction with estimates of the quantity of products extracted from the forest, the opportunity costs to villagers of losing access to Mantadia National Park were estimated to be US\$91 per household/year on average, or \$556 010 in present value terms for all households. This was considered an upper estimate of the benefits derived by local villagers

from the park, as it does not take into account access to alternative forest resources outside the park.

In addition, a *contingent valuation method (CVM)* survey established that on average a compensation of 108 kg of rice will make the villagers as well off with the park as without the park. For all households covered by the survey, this implies a necessary one-time compensation of approximately \$673 078 for all use and non-use benefits that the villagers derive from the park. A *travel cost* study was also administered to tourists visiting the nearby small Perinet Forest Reserve, adjacent to Mantadia National Park. The CVM and travel cost studies of tourists yielded estimates of the net present value of tourism benefits associated with the park amounting to \$796 870 and \$2.16 million, respectively.

Dixon and Sherman (1990) have estimated the value of biodiversity of the Khao Yai Park in Thailand at \$4.8 million per year and its ecotourism value in the range of \$0.4–\$1.0 million per year. These values compare favourably with the almost \$7 million a year loss of income to villagers from traditional users forgone due to the park. On the benefit side, the watershed and carbon sequestration value of the forest were not estimated, nor were the non-use values. On the opportunity cost side, the value of forgone timber harvesting was similarly left undetermined.

Barbier *et al.* (1994) note several important lessons for economic valuation of the costs and benefits of a forest land-use option that can be drawn from the Mantadia study. First, valuation techniques need to be adapted to local situations – in this case rice was used as the basis for measuring the value of forest benefits forgone by villagers through the establishment of the protected area. Second, careful application of valuation techniques in relevant decision-making situations can provide useful indications of which forest values are being affected by the choice of land use. However, it is important to keep in mind what is

Table 12.5-5: Valuation of biophysical reserves in Madagascar.

Items valued	Valuation technique	Aggregated net present value (20 years and 10% DR)
1. Direct use benefits of forest by local villagers – agriculture, fuelwood, crayfish, crab, tenrec, frog	Opportunity cost (production function approach)	US\$566 070
2. Net benefit of forest for local villagers – including use and non-use costs and benefits	Contingent valuation	US\$673 078
3. Direct use benefits of tourists – tourism benefits only	Travel cost	US\$796 870
4. Net benefit of park creation for tourists – may include tourism and other perceived benefits and costs of park creation, e.g. lemur conservation	Contingent valuation	US\$2 160 000

Source: based on Munasinghe (1993) and Kramer (1993).

actually being measured by the valuation technique, e.g. direct use benefits, net benefits including use and non-use benefits, etc., and the reliability of the data and methodologies in assessing these different benefits. Even more important, although this study was concerned with the establishment of a protected area to conserve biological diversity, it did not assess the role of the biodiversity of the forest in maintaining ecosystem functioning and resilience. Consequently, it could not determine whether loss in biodiversity through direct exploitation of the forest by the villagers would have affected their ability to sustain these uses over time. We now consider the results of studies that have widened the range of effects to be valued.

12.5.5 Concluding remarks

Many domesticated **biological resources** are traded on markets, and their direct use values (such as crops, livestock and timber) are reflected in their market prices. The production of such commodities, however, depends on a range of non marketed environmental inputs. This chapter has reported current estimates of the value of these non-marketed inputs. Several general observations can be made about these estimates.

- Nearly all modern crop varieties and some highly productive livestock strains contain genetic material incorporated through plant breeding, from related wild or weedy species, or from more primitive genetic stocks. The direct use value of **genetic diversity** lies in the fact that it provides the raw material for desirable genetic traits in crops or livestock.
- **Biotechnology** has increased the utilization potential of genetic resources, and hence their direct use value, by making gene transfer possible both within species and between unrelated species. **Bioassays** have reduced the time and cost of screening for pharmaceutical and other uses, also increasing the value of the underlying genetic resources.
- The aggregate direct use value of genetic material, as 'raw materials' in agriculture can be approximated by the potential return on investments in research and development of biotechnologies that generate animal and crop breeds of potential value. The returns on this investment can be extremely high in some cases.
- Amongst **wild biological resources**, the direct use value can be highly significant, even in developing countries. In particular, charismatic species such as elephants have high **non-consumptive, option, and existence** values which may be partly captured through park fees.
- The local benefits of biodiversity conservation are generally exceeded by the local opportunity costs

(forgone development benefits). The opportunity costs of park creation to local villagers include the forgone benefits they previously derived from the forest, such as fuelwood, fish, animals, grasses, and fertile land for shifting agriculture. This discourages conservation. Conservation requires an incentive structure that raises the local benefits. For some ecosystems, where global values dominate local values, international transfers are needed to correct market and policy failures.

12.6 The valuation of ecosystem functions: empirical results

12.6.1 The indirect value of biological resources

Indirect use values comprise mainly the environmental functions of natural areas – ecological functions such as nutrient cycling, protection functions such as ground cover for key watersheds, waste assimilation functions such as the retention or de-toxification of pollution, and wider functions such as microclimatic stabilization and carbon storage. These environmental functions all indirectly support economic activity and human welfare, and are generally the *regulatory functions* performed by ecosystems (see Table 12.6-1). If the role of individual species in mediating such regulatory functions is understood, then it is, in principle, possible to derive the indirect use value of such species. For example, elephants are known to have an essential ecological role in African savannahs and forests through diversifying ecosystems, dispersing seeds, reducing bushlands, expanding grasslands and reducing tsetse fly, all of which may be of value to livestock grazing (Western 1989).

Indeed, the relationship between individual organisms and ecosystem functioning is key to the concept of indirect use value. Each ecosystem is composed of a number of physical, biological and chemical components such as soil, water, plant and animal species and nutrients. Processes among and within these components result in specific types of *ecosystem function* or property such as nutrient cycling, biological productivity, hydrology and sedimentation. All such ecological functions are important in maintaining the overall performance and integrity of the ecosystem, in particular its fundamental role in supporting and sustaining the various living organisms dependent on it.

These interactions, or *life-support functions*, in turn generate many ecological resources and services that are of fundamental value as they sustain human societies and existence (see Table 12.6-1). As indicated in the previous Chapter, the kind of ecological resources and services derived from production, carrier and information functions generate economic benefits in the form of direct use values. The regulation (or regulatory) functions tend to generate

Table 12.6-1: Ecosystem functions and their uses.

Regulation functions	Production functions	Carrier functions	Information functions
Providing support for economic activity and human welfare through:	Providing basic resources, such as:	Providing space and a suitable substrate inter alia for:	Providing aesthetic, cultural and scientific benefits through:
– protection against harmful cosmic influences	– oxygen	– habitation	– aesthetic information
– climate regulation	– food, drinking water and nutrition	– agriculture, forestry, fishery, aquaculture	– spiritual and religious information
– watershed protection and catchment	– water for industry, households, etc.	– industry	– cultural and artistic inspiration
– erosion prevention and soil protection	– clothing and fabrics	– engineering projects such as dams and roads	– educational and scientific information
– storage and recycling of industrial and human waste	– building, construction and manufacturing materials	– recreation	– potential information
– storage and recycling of organic matter and mineral nutrients	– energy and fuel	– nature conservation	
– maintenance of biological and genetic diversity	– minerals		
– biological control	– medicinal resources		
– providing a migratory, nursery and feeding habitat	– biochemical resources		
	– genetic resources		
	– ornamental resources		

Sources: Barbier *et al.* (1994); based on de Groot (1992); Ehrlich and Ehrlich (1992); Folke (1991); Odum (1975).

values more indirectly, through their support and protection of various economic activities located outside the ecosystem but nevertheless dependent on its proper ecological functioning.

Table 12.6-2 reports the results of a few studies of indirect use values from various regions and ecosystems. Once again, these are in the nature of snapshots, but the method could be used to generate time series that would enable policy-makers to identify trends.

12.6.2 Estimates of the use value of forests

Tropical moist forests harbour between two-thirds and three-quarters of the world's species. However, we emphasize that the remarks made about tropical forests

apply, *mutatis mutandis*, to other habitats. The particular problem posed by the conversion of tropical forests is that while human-made plantations maintain rainfall regimes and cycle carbon at rates similar to those of indigenous forests, genetic resources are eliminated when indigenous forest is converted to plantations. Conservation of genetic resources should be evaluated along with other goods and services provided by forests, and should form an integral part of land use and management. This is not to say that all forests should be preserved. The aim of conservation should be to optimize the provision of ecological and other services and this does not necessarily imply the preservation of the existing resource in all its facets.

Table 12.6-2: Estimates of the indirect use value of ecological functions.

Resource/function	Estimated value (US\$)	Source
Cameroon		
Watershed protection of fisheries	\$54/ha	
Control of flooding by forests	\$23/ha	
Soil fertility maintenance by forests	\$8/ha	Ruitenbeek (1989)
Philippines		
Watershed protection of marine tourism	\$13.9–19.2 million	Hodgson and Dixon (1988)
Watershed protection of fisheries	\$6.2–8.1 million	
USA		
Water-yield augmentation of managed forests	\$232–388/acre	Bowes and Krutilla (1989)
Brazil		
Carbon storage by forests	\$1300/ha/year	Pearce (1990)
Indonesia		
Support by mangroves of agriculture, fishing and cottage industries	\$536 million	Ruitenbeek (1992)
Sweden		
Nitrogen reduction by restored wetlands	\$18.7/kg N-reduction	Gren <i>et al.</i> (1994)

Tropical forests provide a diverse range of functions and services, including sustainable timber production, non-timber forest products, soil conservation and watershed protection, habitat for biodiversity, homeland for indigenous people, recreational services, amelioration of microclimate, and carbon fixation and sequestration. While all of these functions and services have positive economic value that contributes to human well-being, they are rarely taken into account when land-use and forest management decisions are made. Certain forest values, such as timber production and the potential use of forest land for agriculture, tend to dominate forestry decisions while indirect values, such as the forests' ecological functions, biodiversity and value to indigenous people, are routinely ignored for reasons that range from the difficulty of quantification and valuation to their public good aspects (market failure) to perverse incentives (policy failure). The most direct and tangible uses of forests (timber production and conversion to farmland) are either potentially threatening to the forests' existence or outright

incompatible with it, while the forests' ecological services, which go ignored, are consistent with (in fact, requisite for) the forests' existence in a fairly pristine state.

The total economic value of tropical forests as habitats consists of the sum of their use and non-use values with due consideration of any trade-offs or mutually exclusive uses or functions. The use values may be direct or indirect, current or future (expected or optional). Direct use values include non-timber forest products, medicinal plants, plant genetics, hunting and fishing, recreation and tourism, and education and human habitat, because all of these products and services involve direct use of the forest. Indirect use values include soil conservation and soil productivity (through nutrient cycling), watershed protection with derivative services of water supply and storage, flood control, etc., microclimatic effects and carbon sequestration. Unlike the direct use values, indirect use values do not require physical access to the habitats, but mere physical existence of the forest in good condition. A third category of use value is the option value – the

potential value of habitats for future (direct or indirect) use. It is an insurance premium that people may be willing to pay to ensure supply and opportunity to use in the future. Of course this value is positive only if demand is expected to exist in the future (certain) and supply is uncertain. In the case of habitats, this value is likely to be positive.

Traditionally, many of the indirect use values and non-use values of tropical forests have been ignored, partly because of the difficulty of estimating such values and the lack of mechanisms to incorporate them into decision-making, but most importantly because of the limited appreciation of the importance of the values to ecological sustainability and human welfare. Even direct uses, such as the production of non-timber forest products and the value of forests as human habitats, especially for indigenous people, have not played an important role in tropical forest use decisions. The labelling of non-timber products as minor forest products is a measure of the low significance attached to products and *a fortiori* to services other than timber.

We begin by considering the estimates of value derived from a comprehensive cost-benefit analysis (CBA) of the Korup Project in Cameroon. The Korup Project is an ongoing programme to promote conservation of the rain forest in Korup National Park in Southwest Province, Cameroon. As indicated in Table 12.6-3, the net benefits of the Korup protected area project in terms of sustained forest and subsistence use, tourism, genetic value, watershed protection, control of flooding and soil maintenance, all compare favourably with the opportunity costs of forestry and other development options, thus generating a substantial overall net benefit to Cameroon.

In addition, the analysis not only indicates the range of values that may need to be assessed in deciding whether it is worthwhile establishing protected areas for conservation but also illustrates the procedure for valuing alternative tropical forest land-use options. The CBA includes not only the direct operating and capital costs of the Project but also the *opportunity costs* of lost timber earnings from forgoing clear-cutting (lost stumpage value) and lost production from the six resettled villages (lost forest use). Against this must be weighed the benefits of the project in the form of sustained forest use beyond the year 2010 when the forest would otherwise have disappeared, replacement subsistence production of the resettled villagers, tourism, minimum expected genetic value of biological resources in terms of pharmaceuticals, chemicals, agricultural crop improvements, etc., and environmental functions – watershed protection of fisheries, control of flooding and soil fertility maintenance. Also included are ‘induced’ benefits, agricultural and forestry benefits of the project’s development initiatives in the buffer zone. The external trade credit shows a positive benefit to Cameroon of direct external funding of the project. ‘Uncaptured genetic value’

Table 12.6-3: Cameroon – cost-benefit analysis of the Korup Project.

Base Case Result	
(NPV £ 000, 8% Discount Rate)	
Direct costs of conservation	-11 913
Opportunity costs	-3 326
- Lost stumpage value	-706
- Lost forest use	-2 620
Direct benefits	11 995
- Sustained forest use	3 291
- Replaced subsistence production	977
- Tourism	1 360
- Genetic value	481
- Watershed protection of fisheries	3 776
- Control of flood risk	1 578
- Soil fertility maintenance	532
Induced benefits	4 328
- Agricultural productivity gain	905
- Induced forestry	207
- Induced cash crops	3 216
Net benefit – project	1 084
Adjustments	6 462
- External trade credit	7 246
- Uncaptured genetic value	-433
- Uncaptured watershed benefits	-351
Net benefit – Cameroon	7 546

Source: Ruitenbeck (1989).

is a negative adjustment reflecting the fact that Cameroon will be able to capture only 10% of the genetic value through the licensing structures and institutions that it has in place, and ‘uncaptured watershed benefits’ indicates that some of the watershed protection benefits will flow to Nigeria and not Cameroon. Thus the analysis indicates that the Korup Project offers substantial net economic benefits as a land-use option at the project level and to Cameroon as a whole.

The analysis also reveals some of the pitfalls of economic valuation of non-market environmental values, particularly ecological functions (Aylward and Barbier 1992). The watershed protection functions of the Korup rain forest serve two important regulatory functions: flood control and maintenance of an onshore fishery. Ruitenbeck calculates the value of both functions through the damage

costs avoided approach. Using estimates for the share of local economic output likely to be lost by flooding and for the periodicity of major floods, Ruitenbeek concludes that the damage costs with full deforestation would be US\$1.58 million. Similarly, the value of maintaining the onshore fishery is estimated to be worth \$3.78 million. The latter figure is essentially the total value of the fishery downstream to Cameroon, which is eventually adjusted for the 'uncaptured' benefits of \$0.35 million to Nigerian fishermen.

However, the ecological assumptions behind the damage cost methodology used in valuing the flood control function are not clear and possibly incorrect. First, an implicit assumption in the analysis is that the fishery would be a total loss if the Korup Forest were removed. Valuable though the watershed protection function may be, it is unlikely to be so essential that the entire fishery would be eliminated by the loss of this function. In fact it is probable that the low rates of deforestation projected by the CBA scenario may have a proportionately smaller impact on the fishery than that implied by a more rapid rate. This points out that the rate of deforestation may be one factor determining the extent of the damage done to the fishery when the watershed protection function is fully destroyed.

In addition, the rationale for assuming that the damage function produces linearly increasing costs to fishery production as the absolute area deforested increases is also questionable. Ruitenbeek assumes that the damage costs he calculates for total deforestation are divisible by segments corresponding to the proportionate size of the area deforested each year. It may be that the amount of deforestation and concurrent degradation of the protection function causes little damage up to some threshold amount of degradation at which considerable damage is incurred. A final point of criticism derives from Pearce (1990), who cautions against assuming that deforestation itself leads to the loss of functions such as flood control or fishery maintenance. Instead it is the ensuing landuse that is all-important in determining the extent of damage to the protection function.⁹

In comparison, a cost-benefit analysis of fisheries and tourism versus logging activities in Bacuit Bay, Palawan, Philippines (see Table 12.6-4), indicates a more valid approach to valuing the downstream impacts of forest degradation and depletion (Hodgson and Dixon 1988). It also provides an excellent example of the economic value of conserving biological diversity – although in this case it is not the loss of forest biodiversity but the damage to coral diversity of downstream sedimentation that is one of the critical environmental costs of deforestation.

The authors trace the impact of sedimentation resulting from logging activities through to its impact on coral cover, coral diversity and fish production in the coastal area of Bacuit Bay, as well as the loss of marine tourism resulting from decline of the coral reef and increased sedimentation of the water. Thus the analysis is essentially a comparison of the alternative uses of the terrestrial and marine areas within the Bacuit Bay system. However, it can easily be reinterpreted as a study of the land-use options for the forested area lying within the drainage basin of Bacuit Bay. For example, Hodgson and Dixon essentially compare the option of continued logging in the drainage basin area of the bay with an alternative scenario where the downstream economic benefits of fisheries and tourism undertaken in the bay are protected from sediment pollution by a logging ban in the drainage basin.

The dependence of fish on both coral cover and diversity establishes a potential link between forest degradation, ensuing sedimentation of coastal waters, changes in coral diversity and fish biomass. Using regression analysis Hodgson and Dixon found that 100 million tonnes per km² of annual sediment deposition led to one coral species extinction per year. This extinction was in turn correlated with a decrease in fish biomass of 0.8%. The negative impact of 400 million tonnes per km² deposition per year on coral cover was calculated to cause a 2.4% decrease in fish biomass. Similarly, as marine tourism is dependent on pristine coral reefs and seas, the decline in coral cover and diversity as well as the increased sedimentation and turbidity in coastal waters is expected to affect tourism revenues drastically. Both these impacts indicate the damages to the watershed protection function provided by the forest that result from continued clear-cut logging in the drainage basin. As shown in Table 12.6-4, these damages are highly significant, and suggest that the option of banning logging in the drainage basin is the preferred option – even though timber revenues would be sacrificed.

Peters *et al.* (1989), using the productivity/earnings method, have estimated the value per hectare of Peruvian forest (at Mishane, RioNanay), under alternative uses. They obtain a net present value of US\$6300 per hectare for non-timber forest products (fruit and latex) harvesting, \$490 for sustainable timber production, \$1000 for timber clear cutting, \$3184 for plantation harvesting and \$2960 for cattle ranching. Clearly, for this particular forest the highest value use is the sustainable harvesting of non-timber forest products. Of course, to arrive at the total economic value of the forest, its indirect use values (ecological) and non-use values must also be included as they are consistent with sustainable non-timber product harvesting. It is not clear how representative their sample was or if timber was shadow-priced to account for underpricing.

Anderson (1987) has demonstrated that the valuation and inclusion of the environmental benefits in the appraisal of

⁹ Ruitenbeek (1992) has conducted an excellent analysis of different scenarios for wood chip exploitation of mangroves in Bintuni Bay, Irian Jaya, Indonesia that follows this approach. For further discussion and review see Chapter 12.3.

Table 12.6-4: Philippines – logging versus fishing and tourism in Palawan.

Base case	1986 US \$ '000, NPV of 10-year sum of gross revenues		
	Option 1	Option 2	Option 1 - 2
NPV (10%)			
Tourism	25 481	6 280	19 201
Fisheries	17 248	9 108	8 140
Logging	0	9 769	- 9 769
Total	42 729	25 157	17 572
NPV (15%)			
Tourism	19 511	5 591	13 920
Fisheries	14 088	7 895	6 193
Logging	0	8 639	- 8 639
Total	33 599	22 125	11 474

Option 1: Further logging banned in the Bacuit Bay drainage basin.

Option 2: Continued logging in the Bacuit Bay drainage basin, with timber depleted in 5 years.

Source: Hodgson and Dixon (1988).

forestry projects can increase substantially the economic rate of return of forestry investments. Specifically in the case of Northern Nigeria, the author has demonstrated that taking only the wood benefits into account results in uneconomic rates of return (and negative NPV) for both shelterbelts and farm forestry projects. When the environmental benefits of these projects such as the increase in soil fertility, the reduction of soil erosion and non-wood products are included, both types of projects become economically viable with social rates of return between 13 and 22%.

Ecotourism benefits are a major component of the total economic value of protected tropical habitats. Mercer *et al.* (1994), using travel cost and contingent valuation methods, have estimated the nature tourism benefit associated with establishment of the 10 000 hectare Mantadia National Park in Madagascar already referred to in this chapter. Mantadia provides a habitat to many endemic species, including several species of lemur. The travel cost method was used to estimate changes in ecotourists, consumer surplus resulting from the creation of a new park, which will improve the quality of ecotourism to Madagascar, while considering competing ecotourism destinations. The study estimated that creation of the park will result in increases of consumer surplus in the range of US\$0.77–2.24 (in present value terms at 4% discount rate)

depending on the expected level of quality improvement, e.g. more trails, nature education centre, trained guides. The values quoted above are for quality improvements in the range of 50–100%. The contingent valuation study estimated the willingness of nature visitors to Madagascar to pay for inclusion of the new National Park in their visit to the country. The average willingness to pay was estimated at \$65 per household for a total discounted present value of \$6.34 million. The higher values obtained by the CVM were expected and can be explained partly by their inclusion of non-use values (especially existence value) in addition to the recreational use value. The TCM is also known to underestimate willingness to pay for environmental improvements and in this particular case the value of the travel time was not included in the CVM, resulting in further underestimation of the consumer surplus from the new park. On the other hand, the CVM is likely to have overestimated the use value of the new park because, unlike the TCM, it did not explicitly control for substitute sites (competing destinations).

The Mercer *et al.* study implies an ecotourism value of habitat in the range of US\$224–\$634 per hectare or an annual value of \$9–25/ha over a 25 year period. These figures compare favourably with the opportunity costs of the park obtained by Kramer *et al.* (1994). The authors estimate the opportunity costs of the establishment of the

park using two alternative methods: (a) the value of forgone uses of the forest to the villages around the park (forgone earnings/benefits method) based on household cash-flows, constructed from a socioeconomic survey, and (b) direct questioning of the villagers on their willingness to accept compensation for the lost access to and benefits from the forest to be declared a National Park. The benefits to the villagers from the forest, to be lost as a result of the creation of the park, include fuelwood, other forest products and shifting cultivation. The forgone benefits method gave an average figure of losses of \$91 per household per year, or an aggregate net present value for all affected households of \$566 000 (at 10% discount rate).

The contingent valuation asked villagers for their willingness to accept compensation in the form of rice in order to be as content after the creation of the park as before when they could use the forest for collection of fuelwood and various forest products and for shifting cultivation. The respondents were asked to consider various aspects of the forests, both positive (e.g. protection from flooding and soil erosion) and negative (e.g. wildlife as destroyer of crops) in expressing their willingness to accept. The average willingness to accept was thus estimated at \$108 worth of rice per year, per household, or an aggregate net present value of \$673 000 (at 10% discount).

Converting these values on a per hectare basis we obtain an opportunity cost of US\$57/ha and a willingness to accept (WTA) of \$67/ha which are only a fraction of the ecotourism value of the forest as estimated by the Mercer *et al.* study. Even if we use a 4% discount rate to capitalize the villagers' losses and WTA to make them strictly comparable to the ecotourism benefits, they are still between 22 and 75% of the ecotourism benefits. However, the establishment of the park will have other benefits such as carbon sequestration, as well as costs to establish it and protect it.

Estimation of the forest benefits to local populations is indispensable to biodiversity conservation for several reasons: (a) local benefits that are enhanced and sustained by the establishment of a protected habitat serve to complement the biodiversity and other related benefits, making the establishment of the protected area less costly and more beneficial; (b) local benefits that are incompatible with biodiversity conservation and would be foreclosed by it constitute part of the overall cost of conservation and must be deducted in establishing the net value of the protected habitat; (c) forgone local benefits due to the establishment of a protected area constitute the minimum level of compensation needed to ensure the co-operation of the local population (otherwise the conservation area will be either unfeasible or too costly to maintain). It is the minimum level of compensation, because the local population may assign a greater value to their access to the

forest than is revealed by the value of the products and services derived from it. Their willingness to accept compensation obtained through contingent valuation surveys represents more fully their valuation of the forest access.

For example, Campbell (1993) has estimated the value of woodland resources to a local population in Zimbabwe using (a) a mixture of replacement and production value methods and (b) contingent valuation. The first method valued fruits and other wild foods, fuelwood, construction materials from the forests, and crop and livestock production attributable to the woodlands, and arrived at an average value of US\$223–\$267 per household per year or \$53–68 per hectare per year. Contingent valuation of these products plus ecological, social, and health services of the woodlands produced a mean value per household of \$537, or \$96–\$153/ha/yr based on average woodland availability in the range of 3.5–5.6 ha per household. What is not known is whether the current uses of woodlands are sustainable: if they are not sustainable these values are overestimates of local benefits. Biodiversity and ecological functions may be diminished by excessive harvesting of fuelwood, fruits, construction materials and fodder. Creation of biodiversity reserves would enhance biodiversity values as well as other indirect values such as ecological functions and non-use values such as existence value but would reduce (or even eliminate) use values such as fuelwood collection, grazing and timber harvesting. Precise estimation of the trade-offs is necessary to determine the combination of uses that maximize the woodlands' global net present value and the necessary compensation (transfers) for lost local benefit.

Again, the above values are not comprehensive. For example, the local benefits need to include the value of subsistence hunting, estimated at US\$2.6 per hectare per year by Murindagomo (1988), as well as the value of nature tourism based on wildlife resources associated with the woodlands. On the global benefit side, the value of woodlands ought to include not only the value of biodiversity but also the value of stored carbon, estimated by Bojo (1993) to have a present value of \$200 per hectare (or \$20/ha/yr) using Nordhaus's (1991) rather conservative carbon reduction costs.

Brown and Pearce (1994) estimate the (net) carbon released from deforestation of secondary and primary tropical forests to be in the range of 100–200 tonnes per ha. At a 'central' value of US\$20 per tonne, for global-warming-related damage (Fankhauser 1995), deforestation of one hectare of natural forest results in global warming damage of \$2000–4000, even after allowing for carbon fixation by alternative land uses. These estimates suggest a present value of forest as carbon sequester in the range of \$2000–\$4000 per ha. Inclusion of this value among the forestry benefits is likely to make many reforestation and

Table 12.6-5: Direct use values of tropical forest.

Location	Value (\$/ha/year)	Comments	Source
Venezuela	0.75	Experimental caiman harvest.	Thorbjarnarson (1991)
Korup National Park	1.06	Net present value of forgone gross benefits from hunting = \$2.7 m at a 5% discount rate; area = 126 000 ha; hunting said to be non-sustainable.	Ruitenbeck (1988); Infield (1988)
Mudumalai Sanctuary, South India	3.0	0.02 elephants/ha at \$1 500 per elephant. Excludes cost of domestication and training. Price refers to a domesticated animal. Assume a 10% discount rate.	Sukumar (1989) and pers. comm.
Ituri Forest, Zaire	0.50-3.18	318 kg of game/km ² of primary forest or 50 kg/km ² in climax forest at \$1/kg. Estimate leaves out costs. Price is for prized meats.	Wilkie (1989); Wilkie and Curran (1991)
Amazon, Brazil	4.8	Estimate is gross return/ha/year; flora only.	Schwartzman (1989)
Sarawak, Malaysia	8.00	Values wildlife in 1km ² .	Caldecott (1987)
Maya Biosphere Reserve, Guatemala	10.00	550 000 ha produce c. \$5.5 m/year in exports of chichle, xate palm and allspice; gross value.	Nations (1992)
Western Amazonia	5-16	Gross value varies by the size of the extraction area (150-300 ha).	Hecht (1992)
Cross River National Park, Nigeria	16.50	Yearly income from hunting, gathering, trapping = \$826, Naira/person = \$108; population = 38 300; area = 250 000 ha. Gross value.	Ruitenbeck (1989)
Iquitos, Peru	16-22	Based in part on villager's diaries.	Padoch and de Jong (1989)
Iquitos, Peru	20	Potential value of about 6 spp of latex and fruits.	Pinedo-Vasques <i>et al.</i> (1992)
Hantana, Sri Lanka	50	50 randomly chosen households surveyed in 3 villages; used contingent valuation and opportunity cost approach; estimate leaves out cost of extraction.	Abeygunawardena and Wickramasinghe (1992)
Kalimantan, Indonesia	53	Includes kermel, charcoal, and feed meal of babassu palm. Unclear if returns net or gross.	Anderson <i>et al.</i> (1991)
Combu Island, Guama River, Brazil	79	\$3171/year/family; average of 5 families in 1984-8. Estimate is gross value and includes only semi-wild cacao, acai and rubber. Assumes each family worked 40 ha of forest.	Anderson and Ioris (1992)
Tamil Nadu, India	80	Fuel and fodder.	Appasamy (1993)
Brazil	97	Value of Brazil nuts only (\$/ha): collector's price = 97; exporter's price = 176; retail price = 1059.	Mori (1992)
Para, Brazil	110	Value after selective thinning of competitors and pruning of acai palm.	Anderson (1990)
Veracruz, Mexico	116	Estimate leaves out lumber and coffee.	Alcorn (1989)
Amazon, Ecuador	120	Values wildlife over 500 km ² .	Pauca and Gardner (1981)
India	117-144	Gross benefits; includes fruits, herbs and medicinal plants.	Chopra (1993)
Iquitos, Peru	420	Values the inventory in 1 ha, includes only plants.	Peters <i>et al.</i> (1989)
Belize	36-166	Medicinal plants; 5% discount rate.	Balick <i>et al.</i> (1992)

Source: Godoy *et al.* (1993).

Table 12.6-6: Hypothetical value of all mutually compatible use values in tropical forests.

Region and country	Conversion	Timber Production	Non-timber Production	Soil and Water Conservation	Recreation and Tourism	Carbon Sequestration	Biodiversity	Source
Latin America								
Brazil	605 ranching	—	1100	—	—	1625–3500 ^c	85 ^d	Browder (1988); Anderson (1990)
Peru	2960–3184 ranching	490–1001	6330	—	—	1625–3500 ^c	—	Peters <i>et al.</i> (1989)
Africa								
Cameroon cocoa	1248	10–101 ^a	33	75	17	2520 ^c	6–92 ^b	Ruitenbeek (1989)
Asia								
Malaysia rubber	3370–5660	1541	228–595	—	—	2950–3682	—	Vincent (1991); Vincent and Hadi (1990); Krutilla (1991)
Phillipines farming	875	1415	—	312–637	—	2520 ^c	—	Paris and Ruzicka (1991)
Thailand eucalyptus	1082–2575	—	—	367	203–410 ^f	3342	220 ^c	Tongpan and Panayotou (1990); Panayotou and Para-suk (1990); Dixon and Sherman (1990)
Hypothetical tropical country	1850 1500 ^g	1541 444 ^g	412	475	307	3000	220	

^a Depending on the timing of timber harvest (1991 vs 2010–2040).

^b Lower value: 'patentable' genetic value; higher value: external trade credit used here as surrogate for existence value.

^c Lower figure based on a value of US\$10 per ton of carbon (World Bank 1991); higher figure based on a value of \$28 per ton of carbon (Krutilla 1991).

^d Existence value (Pearce 1990).

^e Existence and option value.

^f Tourist expenditures.

^g Other incidental values.

Source: Panayotou (1992).

forest conservation projects economically viable (even at market discount rates), that would otherwise be uneconomic. The key here is the development of mechanisms for the appropriation and the internalization of these global values to the forest owners or decision-makers.

Table 12.6-5 summarizes the values per hectare of tropical forest per year obtained by studies in various parts of the tropics. They are all partial rather than total economic values; they consist mainly of direct use values

and ignore indirect use and non-use values. Yet, in many cases these values are substantial and compare favourably with returns from alternative uses, except for the outright liquidation of the forest and conversion of the land to other uses. Even with regard to the latter the picture changes for most tropical forests if all direct and indirect use and non-use values are included in the valuation of tropical forests. Table 12.6-6 presents a hypothetical example of the order of magnitude expected if one were to include all mutually

Table 12.6-7: Evidence of existence value for biodiversity conservation in Mexico.

Type of Evidence	Organisation	Area Involved	Size (ha)	Amount of transaction (US \$)	WTP per hectare (US \$)
Debt-for-nature swap	Conservation International	Selva Lacandona; Montes Azules (Chiapas)	385 000	4 000 000	10.38
Donations to nature conservation organisations	Amigos de Sian Ka'an (Cancun, Quintana Roo)	Sian Ka'an biosphere reserve (Quintana Roo)	528 147	34 000	0.06 ^a , 0.05
	Pronatura (Mexico City)		Not Available	809 622 ^b ,	NA
On-site evidence, visitors' survey		Barranca del Cobre (Chihuahua)	450,000	100 100	4.4 ^c .
US contributions to biodiversity conservation projects in Mexico	World Resources Institute, Washington DC	Several areas ^d .	190 869 000	5 528 809 (1989 US \$)	0.029

^a The first figure is the total amount of donations for 1992; Sian Ka'an report that only 10% of donors have actually visited the reserve.

^b The figure refers to total 1992 receipts of Pronatura, including donations and other sources of income.

^c A survey carried out in Barranca del Cobre suggests a WTP/person/year related to existence value of US\$1.82. Multiplying this by the number of visitor per annum (55 000 in 1992) gives a total of US\$100 100; and at a 5% discount rate, a present value of US\$4.4

^d Areas involved in the calculation are those contained in a WRI biodiversity projects database.

Source: Adapted from Abramovitz (1991), Adger *et al.* (1995).

compatible use values in the valuation of one hectare of tropical forest. (While the individual values are obtained from valuation studies of actual sites, their aggregation into one value is illustrative only because the sites are not strictly comparable.)

12.6.3 The total value of forests

A first attempt to arrive at the total economic value of tropical forest habitats, inclusive of use and non-use values, is made by Castro (1994) drawing on value estimates by Constantino and Kishor (1993) and World Bank (1994). The author arrived at an average total economic value for the tropical wildlands of Costa Rica of US\$102–\$214 per hectare per year, or a net present value of \$1278–\$2871 per hectare (using a discount rate of 8%). Multiplying these values with Costa Rica's 1.3 million ha of the wildlands, they put the annual value of the country's wildlands in the range of \$133–\$278 million and their net present value in the range of \$1.7–\$3.7 billion, of which 34% accrues to Costa Rica and 66% to the global community.

A more recent valuation study (Kaosard *et al.* 1994) of the Khao Yai Park in Thailand combined travel cost and contingent valuation methods to estimate both the use and

non-use values of the park. It arrived at a total economic value of US\$80 million per year or \$400/ha. This value does not include the non-use value to non-residents of Thailand nor does it include carbon sequestration values. Yet it compares favourably with the average returns from agricultural land of \$250 per hectare. The average willingness of Thai users to pay to protect the Khao Yai park was \$32 per person per year and of non-users \$8 per person per year. If we assume the same existence values among users and non-users, a quarter of the user's willingness to pay of users was for non-use values. While no survey of foreign users and non-users was carried out, it cannot be assumed that their willingness to pay to protect the park is zero.

In a contingent valuation study of Pennsylvania citizens, Griffith (1991) found that the average non-user of tropical forests was willing to pay US\$28 to protect them. Since a non-user is defined as one who has never visited nor intends to visit tropical forests, this value can be interpreted as a purely existence value. As one would expect, the average Pennsylvania user of tropical forests was willing to pay a lot more, estimated at \$72, to protect the rain forests. Assuming again that users and non-users hold the same

existence values, as much as 40% of the user's willingness to pay is a non-use value. De Groot (1994) based on research in the Darien MP (Panama) and literature data arrived at a total economic value of tropical forests of US \$500 per ha per year for all quantifiable functions of this rain forest area.

The available developed country evidence (summarized above) suggests that non-users have typically indicated values in the range US\$5–\$64 per annum per person for wild species, while per annum WTP for scenic and wilderness areas range between \$3 and \$140. Existing studies provide indicative values where a full range of studies is not possible for every habitat type or for each endangered species. The wisdom of transferring benefit estimates from other similar sites continues to be the subject of scrutiny in valuation literature (Brookshire and Neill 1992). Most valuation studies relate to the US or other developed countries. The results are context and culture-specific and have a limited applicability across all countries.

Table 12.6-7 presents elements of revealed value for a sample of transactions related to natural area conservation for Mexico's forests. Mexico is species-rich: its tropical moist forests contain 5000 vascular plant species as a lower bound estimate (Toledo *et al.* 1992), with all habitats containing 20 000 to 30 000 plant species (WCMC 1992; Bye 1993). Reported elements of existence value include contributions to conservation organizations and programmes, a tourism survey, and debt for nature swaps. On the basis of this evidence, indicative values would appear to be in the range US\$0.03–\$10.4 per hectare. Mexico's protected areas cover approximately 5.8 million hectares and range from tropical evergreen rain forest to arid desert areas. This range of existence values relates to only some of the range of Mexican habitats, highlighting the issue that existence value is context-specific and rises with increasing threat to the habitat.

As reported by Pearce and Moran (1994), the range of implicit values is from US\$0.01 to just over \$4 per hectare globally. The idea of valuing the biodiversity conserved through debt for nature transactions is that the payment made reflects some kind of willingness to pay on the part of the conservation body purchasing the debt. Different debt for nature transactions result in different implicit valuations since the nature of the 'good' being bought varies with the quality of the area protected and the land management strategies involved.

12.6.4 Valuation and policy

If biological resources are to be effectively and sustainably managed, the consensus amongst economists is that there is an urgent need to value the totality of goods and services (including non-use values) provided by ecosystems. Existing estimates of the value of ecological services,

including the value of tropical habitats, are not only partial but are also based on current use patterns. They also assume that ownership, access and use of forest resources remain unchanged. There is a need for normative valuation to determine the ownership and access regimes, and the configuration and combination of uses that will maximize the net present value of ecosystems from different perspectives: local, national and global. Furthermore, estimation of current values and their capitalization over time at a fixed discount rate assumes that neither these values nor the rate of discount will change over time. As incomes grow, as technology and tastes change, certain use values (e.g. fuelwood and non-timber products) may diminish while others such as ecotourism values may increase. Indirect values such as ecological services and non-use (existence) values are likely to increase as incomes rise and the supply of habitats and biodiversity are reduced. On balance we would expect conservation values to rise relative to development values (Krutilla and Fisher 1985; Barrett 1992). On the other hand, to the extent that environmental concerns produce an environmental drag on the economic growth, the discount rate ought to be lower in the future than at present (Weitzman 1994). The implication of both the growth in relative conservation values and of the lower future discount rates is a higher net present value for conserved habitats.

It has already been observed that people from different cultures and different income levels value environmental resources differently. Attitudes to conservation are culturally specific. There is, as was remarked in Chapter 12.2, evidence that conservation in some 'traditional' societies carries a higher relative weight than in many 'modern' societies. But differences in empirical estimates of value based on willingness to pay are dominated by differences in income. This is partly because environmental amenity is a superior or luxury good, and partly because measures of willingness to pay are first and foremost measures of ability to pay. In modern societies, it appears that the higher the income, the greater the willingness to pay for conservation. This can be shown by the high income level of people who belong to organizations such as the US-based National Audubon Society, Wilderness Society and The Nature Conservancy. In traditional societies, even though conservation may have a very high relative value, low mean incomes imply low levels of willingness to pay.

The point has been made repeatedly that, because of the subjective nature of the valuation process in all cultures, the private valuation of ecosystems need not be correlated with the social opportunity cost of the services deriving from those systems. Indeed, it is often the case that higher non-use values are correlated with lower use values. For example, many of the national parks in North America are on land of low accessibility and/or low biological productivity, e.g. the American and Canadian Rockies, the

South Dakota 'Badlands', the canyon areas of Colorado and Arizona, and the Florida Everglades. In contrast, the most fertile land, the Great Plains, has the lowest aesthetic value. This is also true in Australia, where reserved land is sometimes very low in biological productivity. Traditionally, people seem to value grassland ecosystems less than mountains and forests, although there is a growing appreciation of prairies in the United States. It is also the case that the preservation of grasslands with a large variety of 'big-game' living on them, as in East, Central and Southern Africa and South Dakota, has been high on the conservation agenda.¹⁰ A preference for savannah forests and grasslands rather than denser forests may be found in northern Australia, where aborigines set fire to plant growth given the opportunity.

People who value wilderness preservation highly in general may value alternative ecosystems differently. Evidence of these priorities can be seen in the periodic surveys that environmental groups may carry out among their members. The Sierra Club, a large conservation advocacy group in the USA, can show that their members have consistently felt very strongly about ANWAR (Alaskan National Wildlife Arctic Refuge), although most have not visited the northern slope of Alaska and do not plan to. Many valuations also run contrary to the scarcity of the resource. Some people value arctic or desert wilderness much more highly than tropical or temperate wilderness, even though pristine Arctic and severely arid ecosystems are in relative abundance.

The fact that economists agree on the importance of estimating the true value or social opportunity cost of ecosystem use does not, therefore, imply that the outcome will necessarily provide a ranking of ecosystems that is consistent with the ranking obtained from an ecological analysis. This is partly because of the existence of non-use values, but it is also because many of the methods devised to capture non-use values, particularly those based on stated preference or constructed markets, cannot correct for the distorting effects of the institutional and informational conditions that make the exercise necessary in the first place. Contingent valuation is designed to elicit the private valuation of resources for which no markets exist, and hence is based on a set of relative prices, and a distribution

of income and assets which are a consequence of the externalities that make valuation necessary.

The presence of non-use value may imply the existence of an important capturable benefit to conservation over and above its effect on the flow of useful goods and services. The latter form only a lower bound on the social value of biological resources. However, it is important to emphasize that these are precisely the values that are most likely to be missed if the method of valuation is one that relies on stated preferences. The point made in the introduction to this section is that if we are to uncover the value of biodiversity, the mix of organisms, we need to understand the role of species in mediating the key structuring processes of ecosystems over a range of environmental conditions. This requires specification of ecological-economic production functions, and work on these is at a very early stage in its development. It also requires that we obtain not just snapshots of the value of ecosystem functions, but time series that show how the value of such functions is changing.

12.6.5 Concluding remarks

- The value of ecosystems derives from their role as habitat, and in mediating ecological functions, protection functions, waste assimilation functions and wider functions such as microclimatic stabilization and carbon storage. These environmental functions all indirectly support economic activity and human welfare. Tropical forests, for example, provide a diverse range of functions and services. **Direct use values** of forests include timber, non-timber forest products, medicinal plants, plant genetics, hunting and fishing, recreation and tourism, and education and human habitat. **Indirect use values** of forests include soil conservation and soil productivity (though nutrient cycling), soil conservation and watershed protection with derivative services of water supply and storage, flood control, microclimatic effects and carbon sequestration. **Option values** include the potential value of habitats for future (direct or indirect) use.
- Where the conservation values of ecosystems are outweighed by their development value, loss of ecosystem function may be avoided only if there is a mechanism for enabling users to appropriate the benefits of conservation. Options include **debt-for-nature-swaps** and **transfers**, whether under bilateral or multilateral aid programmes or under the **Global Environment Facility**.
- Indirect and passive use values of ecological services are likely to increase as incomes rise, and the supply of habitats and biodiversity is reduced. This implies that **conservation values** may be expected to rise relative

¹⁰ A major US environmental organization, The Nature Conservancy, has been funding a number of prairie conservation projects in the US Midwest. Additional efforts to maintain prairies are sponsored by the main Chicago-area Arboretum in Batavia, Illinois, and by Fermi Laboratory, known as the National Accelerator Laboratory. These prairies provide reasonable examples of existence value. People cannot do anything in them except walk along certain paths. Access is free so that no one profits from them, and their recreational value is not captured in a market.

to development values. Conservation of genetic resources should be evaluated along with other goods and services provided by ecosystems, and should form an integral part of land use and management.

- Effective biodiversity conservation depends on the valuation of all goods and services provided by ecosystems in order to determine the configuration and combination of uses that best satisfy the interests of society.

12.7 Valuation in the conservation of biodiversity

12.7.1 The goals of conservation

The distinction between the private and social value of biological resources and the mix of those resources, biodiversity, turns out to be important for very practical policy reasons. The proximate causes of biodiversity loss are to be found, in the main, in the stresses which lead to a loss of ecosystem resilience (of which habitat destruction is a special case). But the underlying causes are to be found in the divergence between the private and social valuation of resource use. As is shown in Chapter 12.5, the cost of forest clearance to the user is frequently not the same as the cost of forest clearance to society, and the result is deforestation in excess of the socially optimal rate. Even though our ability to generate good estimates of the social value of biodiversity is still severely restricted, it is often possible to identify the direction of bias in the current conditions, and that is enough to motivate a change of policy in the right direction.

The policy implications of earlier Sections (5 and 6) on biodiversity in ecosystem functioning are simple but very powerful. They are that the principal objective in the biodiversity problem is not the preservation of a particular set of species now threatened with extinction, but the conservation of the resilience of those ecosystems on which human activity depends. It is this which underpins the ability of those systems to continue to provide valuable ecological services. And the value of biodiversity as distinct from the value of individual biological resources lies in its role in the provision of ecological services. Preservation and conservation are not the same thing.

In economic terms the demand for biodiversity derives from demand for such ecological services. An individual species harvested from some ecosystem may, for example, be valued for specific properties that make it useful in either production or consumption. But the biodiversity of that ecosystem will be valued because it is necessary to the production of the individual species. If not all species in an ecosystem are necessary for the health or resilience of that ecosystem, then not all species will be positively valued. Indeed, if the deletion of some species is judged to be necessary for the health of that system – the smallpox virus,

for example – then that species will be negatively valued (it will be a 'bad' from the point of view of humanity).

It is worth re-emphasizing that even if demand for species is motivated by their use in consumption or production, it still involves ethical judgements. One of these has already been alluded to. It relates to the rate at which the future costs of present actions are discounted. A second relates to the connection between the individual and the collectivity. We have already remarked that discounting implicitly involves ethical judgements about inter-temporal or inter-generational equity, and therefore about the responsibility that the present generation should bear for future generations (Goodin 1982). Positive discount rates (over and above the rate at which the flow of goods and services is increasing through economic growth or natural regeneration) imply, at the very least, indifference to the welfare of future generations. Dasgupta and Heal (1979), going further, argued that the discounting of the irreversible future costs of some decision implies that the impoverishment of future generations may be interpreted not just as an incidental outcome, but as a positively desirable result of the decision. Economists tend to be less critical of discounting of this sort – known as utility discounting – now. But the fact remains that utility discounting does involve an ethical judgement about inter-generational equity, and this does vary between countries and social groups as do other aspects of social and private preferences. Wherever the utility discount rate is inconsistent with the rate derived from the growth potential of the relevant capital stock, including the stock of natural resources, the sustainability of economic development is at risk.

The ethical problems raised by these two questions are the subject of a continuing debate. Indeed, they are a large part of what still divides economics and ecology. At issue is the view that if the existence of the component parts of a system is contingent on the health of the whole, as is the case in an ecological system, then the 'sovereignty' of any one component of the system – the consumer in this case – may only be exercised within bounds (Perrings and Opschoor 1994). Indeed, the responsibility that accompanies consumer sovereignty is what lies behind the call for a new ethic or morality to govern the relation between the individual and the public good (see, for example, Regan 1986; Wilson 1988; Przewozny 1991).

Protecting the interests of future generations has two major implications for policy that are worth making explicit. First, the aim of a strategy for the sustainable management of wild resources should not be to preserve those resources in the existing state, but to protect the capacity of the ecosystems to which they belong to function over a wide range of environmental conditions – to protect the resilience of those systems. The fact is that conservation does involve trade-offs in the same way as any other resource allocation strategy, and these need to be

considered directly. Preserving wild resources through nature reserves and other protected areas may be an important short-term step where such resources are threatened with immediate extinction, but it does not even begin to address the main problem. Nor is it feasible to protect the resilience of critical ecological systems by excluding human users of wild resources. The goal of a sustainability strategy should not be to protect all wild resources in some areas only and irrespective of cost (in terms of forgone development opportunities), but to ensure that development does not threaten critical biodiversity thresholds in all areas.

Second, it is necessary to create economic incentives that reduce the differences between the value of wild resources to the private individual and their value to society as a whole. That is, it is necessary to internalize the external costs of the use of biological resources. A precondition for this is the valuation of biological resources. But valuation clearly is not enough. What is also required is the development of effective institutions. To be effective in an evolving and only partly understood ecological-economic system, institutions have to be adaptive. Being adaptive means, among other things, being able to respond to environmental feedbacks before those effects challenge the resilience of the entire resource base, and the economic activity that depends on it. Institutions need to be constructed which safeguard the resilience and functionality of ecosystems by safeguarding the resources which support that resilience. That is, it is necessary to bound economic activity in a way that minimizes the risk of irreversible damage to the systems on which human activity depends. While many recent institutional innovations tend to do just the opposite, there are success stories from both traditional and contemporary societies from which we can learn. In the final chapter of this section we consider the policy implications of the valuation of biological resources discussed in earlier chapters.

We begin, however, with a cautionary note. While economists have begun to grapple with the valuation of non-marketed environmental resources, it should be clear from this review of the state of the art that we are a long way from having identified let alone addressed all the issues it raises. The current set of estimates reflects very large differences not just in valuation methodology, but also in the conceptualization of the problem. There is no consensus on the very important question of existence value, for example. Indeed, the jury is still out on both the conceptualization of use, passive use and non-use values, and the appropriate methodology for estimating these values.

A second point is that the economists' approach to valuation is driven by the perception that market prices induce an inefficient allocation of biological resources. But the criterion of efficiency – the objective against which to judge the performance of different societies – remains ill-

defined. Sustainable development is not a well-defined objective, though it is an often stated one. This is not, of course, a problem that is unique to the valuation of non-marketed resources, but if we are interested in determining the social opportunity cost (as distinct from the private value) of non-marketed environmental resources, it is one that has to be addressed.

12.7.2 Protected areas, conservation and development

It is still the case that most conservation efforts, both nationally and internationally, begin and end with the designation of protected areas (national parks, wildlife reserves and so on). The point was made earlier that while this may be a necessary part of any strategy to conserve biodiversity, it is far from sufficient. Conservation requires the protection of sufficient diversity to underwrite the resilience of ecological systems everywhere, not just in protected areas. Hence an important part of any strategy for the conservation of biodiversity is the generation of appropriate incentives for resource users both inside and outside protected areas. More particularly, it is necessary to generate appropriate incentives and to undertake specific initiatives at the local level to complement international, national or regional policies. In recent years this has led to revisions in the strategy for development and management of protected areas, with an emphasis on the need for local participation in conservation measures and the benefits they generate.

McNeely (1993) argues that the traditional approach to setting up protected areas and managing biological resources has sometimes worked against the interests of local populations. Their traditional rights of access to resources in protected areas are usually abrogated by the state. The responsibility for managing biological resources has often been removed from local people, communities and leaders and instead transferred to central government agencies in distant capitals. As a result, the mainly poor and rural communities in the vicinity of national parks and protected areas generally bear the brunt of the forgone economic opportunities associated with conservation measures – with little or no compensation in return. The consequence is often illegal and/or 'open access' exploitation of resources, and increased conflicts between local people and the state.

In recent years, the traditional 'top-down' approach to conservation management has been revised to encourage more community-based conservation. Two general approaches seem to have been advocated (Wells and Brandon 1993). First, *buffer zones* have been delineated and established around park boundaries, as sites for both conservation and development-related activities. Second, new approaches to park and protected area management are being promoted to encourage greater *local participation*. The result has been a proliferation of projects in recent

years attempting to link biodiversity conservation with community-based development.

Wells and Brandon (1992, 1993) have classified all these initiatives that attempt to enhance biodiversity conservation while simultaneously attempting to address the needs, constraints and opportunities of local people as *integrated conservation development projects* (ICDPs). They reviewed 23 of the leading ICDPs in Asia, Latin America and Africa in terms of their effectiveness in achieving their dual objectives of community-based development and biodiversity conservation.

On the whole, their conclusions are not encouraging. Despite its rapidly growing popularity, the overall contribution of the ICDP approach to biodiversity conservation has so far been limited. For example, the buffer zone approach has failed in part because most protected area management agencies have no legal authority to establish or manage buffer zones, outside or inside park boundaries. Similarly, attempts to encourage participation have faltered because most ICDPs have treated local people as passive beneficiaries of project activities and have not involved them in decision-making related to the process of change and development.

The relative ineffectiveness of ICDPs can be traced to four important factors:

- Most ICDPs have been operational for less than five years and are therefore at a relatively early stage of implementation.
- Many ICDPs are operating on very modest scales and with small budgets (some less than US\$50 000 annually), while attempting to implement ambitious and wide-ranging programmes aimed at poverty alleviation, environmental education and conservation in numerous small communities spread over large areas.
- Many ICDPs should be regarded as demonstration projects and cannot be expected to contribute significantly to biodiversity conservation as stand-alone initiatives; their value will largely come through showing what is possible and encouraging replication elsewhere.
- The ICDP approach is innovative and experimental; there are few precedents for linking conservation and development goals within single projects, and a period of learning and making mistakes is inevitable.

Nevertheless, Wells and Brandon (1993) conclude that in spite of these difficulties and shortcomings the ICDP approach should not be abandoned. ICDPs, they argued, 'must be reinforced and expanded simply because there seem to be no other choices... innovative, well-designed projects at carefully selected sites that constructively

address local people-park relationships are essential to the conservation of biodiversity and thus to sustainable development. Workable buffer-zone arrangements and more effective local participation will be key elements of such projects'.

Southgate and Clark (1993) take a slightly more pessimistic view of ICDPs, particularly with regard to biodiversity conservation in South America. The authors condemn the rather 'naive' view that people who live in tropical forests always have a strong economic interest in keeping habitats intact, and note that for proponents of ICDPs, the idea that local communities are not always willing partners in the campaign to save biological diversity is disheartening. Particularly in Amazonia, conflicts between locals, who resent the loss of access to resources, and park managers and supporters often grow acute, and rarely are these conflicts resolved in favour of conserving flora and fauna.

Where conservation is promoted, it is usually because of the potential for tourism development, e.g. the Galapagos National Park of Ecuador and the Mayan ruins at Tikal in the Petén tropical forests of Guatemala. Those officially designated natural reserves in South America that still remain relatively untouched will not be so for long. As local populations multiply and as infrastructure development begins to encourage settlement by outsiders, pressure on natural ecosystems will increase and the survival of parks and reserves may be threatened. Southgate and Clark argue that this process is not encouraging for ICDPs. Establishment of these initiatives to encourage participation by local populations must overcome powerful incentives for habitat and land conversion by the same communities. ICDP activities can themselves promote environmental degradation, e.g. improved roads, trails and infrastructure can make it easier for local people to penetrate previously inaccessible forests and protected areas.

In short, where the incentives for 'nutrient mining' and land conversion are strong among local communities, then successful implementation of ICDPs and park protection initiatives will be extremely difficult. Even attempts to set up extractive reserves or, buffer zones, or to demarcate park boundaries are unlikely to withstand the onslaught of loggers, farmers, ranchers and prospectors. Southgate and Clark suggest that natural ecosystems and protected areas can best be saved through promoting environmentally sound intensification of crop and livestock production in areas away from forest and agricultural frontiers.¹¹

¹¹ Southgate (1991) has conducted a statistical analysis that illustrates this point: in Latin American countries where crop and livestock yields have improved, land-use conversion has been mitigated, whereas in countries with poor productivity trends land conversion has increased.

Although field activities such as ICDPs are important for saving threatened habitats in developing countries, they are not sufficient and certainly not a substitute for improving sustainable production, income and employment in other areas, including urban zones and rural areas where agriculture is already well established. The authors claim that, unfortunately, most organizations are far more interested in seeing ICDPs and related initiatives funded and implemented than they are in projects to increase overall agricultural productivity.

The important focus of integrating economic development with biodiversity conservation is the generation of the correct incentives for biodiversity conservation while at the same time discouraging perverse incentives that work against conservation. Ultimately, this must operate at the *local level*, where the millions of farmers, hunters, herders, ranchers, fishing folk and harvesters interact with the natural environment every day. As argued by McNeely (1993), overcoming the damage caused by perverse incentives will require new initiatives to promote conservation, applied at a series of levels and in a number of sectors. Changing behaviour at the local level will require reasonably comprehensive packages of *direct incentives* (tax breaks, subsidies, grants, compensation for animal damage, interest-free loans, differential fees and differential access to resources), *indirect incentives* (the application of fiscal, service, social and natural resource policies to specific conservation problems) and *disincentives* (penalties, punishment and other forms of law enforcement accompanied by public information). ICDPs are clearly only part of the solution and should not be seen as the 'panacea' of biodiversity conservation, but they do provide an important lesson: conservation measures are likely to be most successful when they provide real and immediate benefits to local people.

More generally, under the right conditions, efforts to promote community-based conservation can be an effective indirect incentive that can form an important part of the overall 'package' comprising a biodiversity conservation strategy. Such efforts are diverse and can include building community-level conservation institutions, encouraging community involvement in both management and decision-making about resource use, promoting ideas of sustainable agriculture and forestry, conserving and promoting traditional knowledge, providing education to local people and providing special development actions to villages surrounding protected areas.

12.7.3 *Incentives and the appropriation of value: the local problem*

To illustrate the elements required of a local biodiversity conservation strategy, consider the case of tropical forests. Many governments have created economic incentives that powerfully accelerate the rate of deforestation, stimulating

rapid depletion of timber resources and encouraging the conversion of forest land to agriculture and other uses. These include inappropriate forest revenue systems which (a) leave enormous economic benefits to timber concessionaires, (b) provide little incentive for sustainable forestry, and (c) encourage highly selective and destructive harvesting (Repetto 1988). These policies are often compounded by poor enforcement of logging regulations and underemphasis on the non-timber products obtainable from tropical forests. To stimulate local economies, governments have overprotected timber mills and wood processors, leading to inefficient industries which exert strong pressure for enough logs to maintain their production levels irrespective of economic or environmental considerations (Repetto 1988; Repetto and Gillis 1988). Many governments have also nationalized their forest lands, superseding traditional rights of local authorities and communities. Although intended to strengthen control, this has more often undermined local rules governing access and use, removed local incentives for conservation, and granted responsibility to forestry agencies which are totally beyond their capacity to meet (Repetto 1988).

But in many countries, non-forestry policies have caused greater forest destruction than misguided or misapplied forestry policies (Repetto 1988). Most obvious are agricultural programmes under which forest is cleared for estate crops. Closely related are public investments in mining, dams, roads and other large infrastructure projects that destroy forests. Then come tax, credit and pricing policies that stimulate private investment in competing land uses. Generous government subsidies to competing land uses have resulted in the rapid conversion of forest lands, often to uses that are economically inferior and even non-viable without continuing government support. Large-scale agricultural settlements in forest areas, carried out at enormous cost to the government, have failed in several countries after deforesting huge areas (Repetto and Gillis 1988).

There are important connections between deforestation and failed development policies. Pressures on natural forests are reduced when communities achieve adequate growth in rural output and employment, begin to convert from wood as an energy source to electricity and petroleum products, and experience declining population growth rates as birth and death rates decline and young workers are drawn off into expanding urban industries. By contrast, economic stagnation and poverty inevitably accelerate deforestation (Repetto 1988). Economic policies that have retarded development include deeply overvalued exchange rates, negative real interest rates, and flagrantly distorted commodity prices. Such policies often impose heavy penalties on the rural sector as the prices of agricultural outputs are lowered, thereby attracting less private sector

capital, reducing employment and leading to further pressure on unconverted forest land (Repetto 1988).

In Latin America, generous incentives made available to promote extensive cattle ranches have acted as convenient tax shelters for corporations and wealthy investors. While investors have gained, the ranches have failed both economically and ecologically (Browder 1988; Binswanger 1989). Government-subsidized road construction has facilitated access to markets and further increased profits from logging and from converting forest lands for agriculture or grazing. Resettlement of people to the areas opened up by roads has often been seen as politically preferable to genuine land reform involving the redistribution of agricultural lands. Migrants often risk losing their title or other legal rights if they do not clear the forest. Such policies are common where governments in impoverished, overcrowded and polluted cities perceive sparsely populated forest lands as a means of reducing population pressure and providing new employment opportunities (McNeely 1988).

We have already indicated that current market prices do not reflect the environmental consequences of these policies. A corollary of this is that the systems of national accounts that inform both macroeconomic and microeconomic policies at the national level also neglect the environmental consequences of economic activity. The aim of national income accounting is to provide an information framework suitable for analysing the performance of the economic system. But there is a dangerous asymmetry in the way natural resources are measured in national income accounts. A country could exhaust its mineral forests, cut down its forests, erode its soils, pollute its aquifers, and hunt its wildlife and fisheries to extinction, but national income and economic growth as conventionally measured would not be affected. The implicit (inappropriate) assumption is that natural resources – including biodiversity – have no marginal value (Repetto *et al.* 1989).

Current evaluations of national economic performance and estimates of macroeconomic relationships are seriously distorted by failure to account for the depletion of natural resources such as biodiversity, forests, topsoils and fisheries, as well as energy and mineral reserves. Official statisticians and their clients have resisted the demand to reform inadequate national accounting systems, citing the need to refine methodologies and data collection (e.g. Ahmad *et al.* 1989; Lutz 1993). But natural resource accounting analyses by the World Resources Institute for Indonesia (Repetto *et al.* 1989), Costa Rica (Solórzano *et al.* 1991) and the Philippines (Cruz and Repetto 1992) have already highlighted the need to reassess the economic performance and development patterns of these countries, showing how natural resource assets were depleted to finance current consumption and the acquisition of relatively unproductive industrial capital. These exercises

show that natural resource depletion rates are often so great that even partial estimates for the principal sectors provide important insights into economic performance. Macroeconomic analyses based on accounting frameworks that ignore this information will almost inevitably lead to erroneous conclusions and faulty prescriptions.

12.7.3.1 Structural adjustment programmes and policies

National policies affecting the environment are not, of course, static. Many developing countries underwent economic reform necessitated by acute fiscal and current account deficits in the late 1970s and early 1980s, adopting World Bank and IMF prescriptions for structural adjustment. These packages were intended to change the whole set of relative prices facing producers and consumers, reform underlying institutional arrangements, affect overall levels of public sector investment in infrastructure, and promote private sector activities to increase employment (Reed 1992). So far, however, only a handful of studies have explored the fundamental and far-reaching environmental impacts of structural adjustment programmes (Cruz and Repetto 1992).

Reed (1992) describes numerous examples of economically inefficient use of natural resources and environmental degradation which can be linked to structural adjustment policies in Côte d'Ivoire, Mexico and Thailand, although these environmental impacts have proved variable – some good, some bad – and difficult to untangle. Three generalizable features emerged: (a) the reduction in public expenditure programmes imposed by fiscal restraints reduced the budgets of agencies protecting the environment, (b) reduced credit to small rural investors led to lower on-farm investments and declining agricultural yields, countering efforts to stabilise the agricultural frontier – particularly in the absence of effective land tenure systems, and (c) institutional constraints negated efforts to correct price distortions in the forestry, irrigation and energy sectors.

A recent analysis of the relationship between structural adjustment and the environment in the Philippines has challenged the conventional view that the most important environmental impact of the debt crisis of the early 1980s was to intensify resource exploitation for export production. In fact, the most serious result was massive unemployment and income decline attributable to the debt crisis and stabilization policies, which led to vastly increased numbers of workers migrating to the open access resources of the uplands and coastal areas, with consequent deforestation, soil erosion, destruction of coastal habitats and depletion of fisheries (Cruz and Repetto 1992).

The macroeconomic accounting frameworks and analytical models currently used by international development agencies generally assume away any possible environmental effects of macroeconomic policy instruments such as taxes, interest rates, tariffs and

exchange rates, and levels of public spending. Using such analytical tools, it is impossible even to examine whether particular policy changes would have beneficial, mixed or adverse effects on natural resource use and environmental quality. There is an acute lack of models that relate natural resource use and environmental impacts to macroeconomic policy change. Until these are developed and used, policies will continue to be based on assumptions of no environmental impact (Cruz and Repetto 1992).

Under current conditions in most developing countries, the remaining tropical forest habitats have less than an even chance of surviving the next several decades because of the simple but critical fact that the local benefits of conservation fall far short of local opportunity costs (Wells 1992; Panayotou 1994a). The local benefits from conserving forests are low because only a fraction of their direct value and associated goods and services (fuelwood, non-timber goods, and local watershed protection) accrue to the local populations. The rest accrue to distant beneficiaries outside the immediate local area (soil and water conservation, ecotourism and timber production) and outside the country (biodiversity, carbon sequestration).

The local opportunity costs of conserving forests in developing countries are relatively high because of (a) the general lack of the means (secure land title, access to credit, technology, etc.) to practice sustainable agriculture and to raise productivity on existing farmland and (b) the paucity of non-land-based economic activities and employment opportunities, especially in rural areas; and (c) the pervasiveness of direct and indirect subsidies for forest liquidation and land conversion to other uses, which artificially raise the private opportunity costs of conserving forests to local populations.

The shortfall of local benefits from conserving forests to cover the opportunity costs constitutes a very potent incentive for forest conversion and renders protection very difficult and costly to enforce. To conserve forests it is necessary to alter the incentive structure from one that favours forest depletion and conversion to one that favours conservation and sustainable management by raising the local benefits from forests and lowering opportunity costs. For each of the goods and services derived from or associated with biodiversity conservation, several economic and financial incentives could be devised to capture and internalize these benefits to local populations. The following is a small sample of domestic and international incentives and financing mechanisms for biodiversity conservation.

12.7.3.2 Raising local benefits

The benefits to local populations from conserving forests can be enhanced by (a) recognizing their special relationship to natural forests, sanctioning customary rights and containing access by outsiders and (b) internalizing to

the local communities the external (both national and global) benefits of forest conservation through mechanisms that fully value and transfer part of this value to the local population; and (c) by involving the local communities in the protection and management of forests.

12.7.3.3 Lowering local opportunity costs

The opportunity costs (forgone benefits) to local populations from forest conservation (non-depleting, non-converting forests) can be lowered substantially by (a) renewing the subsidies that artificially inflate these benefits from depletion and forest conversion (e.g. granting of title for land clearing, underpricing of timber concessions etc.); (b) providing the local populations with the means (land tenure, access to credit, technology and markets, education, etc.) to practice sustainable agriculture and raise productivity on existing cropland; and (c) by making available and accessible alternative non-land based employment opportunities, to rural populations through promotions of labour-intensive industries and investment in human resource development.

12.7.3.4 Lowering forest protection costs

Increasing the benefits and lowering the opportunity costs to local population of conserving forests would automatically lower the pressures on the remaining habitats and thereby reduce the costs of effective forest protection. These costs can be further reduced by directly involving the local populations (as forest guards, tour guides, collectors of non-timber forest products and scientific samples) in the protection and management of forests for sustainable production of goods and services. Involvement of local populations would lower the costs of effective protection because (a) they have intimate knowledge of the forests, its functions and the threats it faces; (b) they are continuously present and can be motivated to police themselves; and (c) being among the lowest socioeconomic groups, local communities can do the job at the lowest possible cost.

12.7.3.5 Water fees as forest conservation incentives

Watershed protection is a major service provided by tropical forest habitats. While local communities may derive some benefits from local watershed protection, the principal beneficiaries tend to be downstream farmers and urban and industrial centres who are protected from floods as well as supplied with naturally regulated and larger than otherwise quantities of water. Since these beneficiaries are currently not charged for the watershed services of national parks and protected forests, watershed protection and associated biodiversity conservation remain underfunded; and, since local populations receive no benefits from the watershed services of the forests they have no incentive to take these values into account in their behaviour towards

the forest. The watershed value of forests can be captured and internalized to the local population through efficient water and hydropower pricing that includes a watershed protection charge. The revenue from this charge is then passed to local communities and individuals entrusted with the protection of the forests in water catchment areas. At the minimum, water charges should be an important source of funding for conservation of major watersheds as well as an economic incentive for conserving scarce water resources. Dunoga Bone combined Irrigation and National Park System in Sulawesi, Indonesia, is an example of how water fees can serve as a financing mechanism for conserving biodiversity. A watershed protection charge, if included in the price of hydroelectricity in countries such as Costa Rica, El Salvador, Sri Lanka, Vietnam and Laos (which derive most of their electricity from hydro-power), can serve both as an incentive to conserve energy and as a financing mechanism for watershed protection and the development of alternative opportunities for shifting cultivators and other forest encroachers.

A variant of this mechanism is the issue of water rights to people living in watershed areas in exchange for protecting a specified piece of forest. Downstream farmers and urban centres can access the water of dams drawing from the catchment area by buying water or leasing water rights from the protectors of the watershed; others living in and around the catchment area who refrain from encroachment and destruction, while not actively involved in watershed protection, could also be given water rights but to smaller quantities of water.

12.7.3.6 Internalizing ecotourism benefits

The benefits from ecotourism associated with forest conservation often flow to distant beneficiaries in urban areas and overseas, while the local people resent these new claimants to their heritage. Under these conditions, encroachment tends to intensify rather than abate. Ecotourism can become an important incentive for conservation if a large portion of the derived benefits flow to the local population. This can be done not only by engaging local people as forest guards and tour guides but also by issuing ecotourism franchises to local communities and allocating a portion of ecotourism revenues to the development of alternative employment opportunities to reduce the pressure on tropical forests.

12.7.3.7 Reforestation incentives

An interesting forest conservation incentive operates in Costa Rica, known as the transferable forest conservation tax credit. Land owners who choose to keep their land under forestry (or plant native species) receive a tax credit (i.e. they can deduct part of the costs from their taxes). This scheme benefits particularly bigger, wealthy land holders who pay a significant amount of taxes. To enable small

land holders to share in the benefit of the scheme, the government introduced a transferable tax credit system: small-holders who keep their land under forests earn tax credit which they can sell to wealthy taxpayers with high taxes to offset. The annual nature of both the tax credit and the investment (maintenance of land under forest) provides a continuous incentive to keep land under forests. Yet, a differential land-use tax could have achieved the same result more directly without a financial cost to the government.

12.7.3.8 Differential land use tax

In Germany land uses are classified in a number of categories from environmentally most beneficial (e.g. natural forest) to environmentally most destructive (e.g. industrial site). A charge is imposed on the land-owner when he/she changes land use from a higher to a lower class. The more the steps of environmental downgrading, the more the charge (charge \times number of steps). For example, the charge for downgrading from natural forest to industrial site is far greater than from natural forest to managed forest. The effect of this differential land-use tax is to internalize the environmental costs of forest conversion and land-use change. Corresponding environmental upgrading of land (e.g. reversion of agricultural land to forest) may receive a subsidy.

12.7.3.9 Environmental bonds

Environmental performance bonds are economic instruments that aim to shift responsibility for controlling deforestation, monitoring and enforcement to individual producers and consumers who are charged in advance for the potential damage. Often the state is saddled with huge bills for reforestation after logging. Environmental bonds ensure that: (1) logging and extractive industries take adequate measures to minimize the environmental damage caused by their activities and preserve biodiversity values and ecological services; (2) they effect restoration of residual damage in the most cost-efficient manner; and (3) adequate funds are available for the restoration of damaged environments by anyone who fails to comply. Environmental performance bonds are increasingly employed in mining and logging concessions in Malaysia and other Southeast Asian concessions. Environmental bonds need not be a constraint on economic activity, as they can be invested in interest-bearing accounts or replaced by bank guarantees. It turns out that a variant of performance bonds has considerable potential not just in protecting society against the misuse of environmental public goods, but in reducing the uncertainty associated with innovative activities. It is possible to construct an economic incentive that will have the effect not of correcting for externalities observed *ex post*, but encouraging resource users to identify externalities *ex ante*.

Environmental Assurance Bonds have been recommended both as an insurance where problems of irreversibility and fundamental uncertainty prevent the actuarial assessment of the risks associated with the use of public environmental resources, and as incentives to resource users to research the environmental implications of their actions (Perrings 1989b; Costanza and Perrings 1990; Farber 1991).

12.7.3.10 Forest compacts

These are voluntary obligations (commitments) drawn and undertaken by individual developing countries with the support of developed countries to engage in policy reforms, conservation and investment programmes that would achieve specified targets of forest preservation and sustainable management over a specified period of time in exchange for the transfer of financial and technology resources from developed countries to support these reforms. The participating countries could in turn be given credit against CO₂ reduction and forest protection obligations undertaken under international conventions.

12.7.3.11 Carbon offsets

This is a special type of forest compact jointly drawn and implemented by a developed country entity such as a power utility and a developing country forest company, a Forestry Department or any other forest donor. Under this type of joint implementation, the power utility or other sources of CO₂ emissions finance a shift to reduced impact logging techniques, enrichment planting or reforestation or forest conservation in a developing country in exchange for credit for the carbon saved or sequestered by the funded forestry activity. The potential benefits are substantial (arising from differential costs of CO₂ reductions between developed and developing countries) and are shared between the parties involved (both private and public). While several such pilot offsets have been initiated in recent years (e.g. New England Electrical System with the Sabah Foundation; Applied Energy Systems of Virginia with Guatemala), North-South carbon offsets have not yet been sanctioned by governments and the global community as legitimate means of meeting CO₂ reduction obligation under the Climate Convention. The Conference of the Parties, meeting in Berlin 28 March-7 April 1995, adopted a resolution to permit a pilot phase of joint activities between the parties but with no credit to any party as a result of greenhouse emissions reduced or sequestered during the pilot phase. Despite this development, carbon offsets and other joint activities are receiving sufficient interest by both North and South to warrant further study and experimentation. Carbon offsets provide one mechanism through which the global value of carbon sequestration can be internalized to the local populations of developing countries.

12.7.3.12 Transferable development rights

A final measure worth discussion is the transferable development right (TDR) used for the preservation of historical sites, and more recently, proposed for conservation of biodiversity (Panayotou 1994b). Tropical countries could set aside habitats for biodiversity conservation and divide each habitat into a number of TDRs, corresponding to an area unit of, say, a hectare. Each TDR would state the location, condition, diversity, and a degree of protection of the habitat and any special rights that it conveys to the buyer/holder. TDRs could then be offered for sale both locally and internationally at an initial offer price that covers fully the opportunity cost of the corresponding land unit (i.e. the net present value of the income stream of the forgone development opportunity). It is preferable to start at a relatively high price to test the market, since undervaluation is irreversible (following sale) while overvaluation is reversible (following non-sale). If the price turns out to be too low to clear the market, i.e. to exhaust the supply of TDRs for a particular habitat, the price could be lowered to attract additional demand or the quality of the TDR could be enhanced by enlarging the area to include additional biodiversity values or by improving its protection and management.

The potential buyers of TDRs include local and international organizations, local and international foundations and corporations, developed country governments, chemical and pharmaceutical companies, scientific societies, universities and research institutions, even individuals in the developed countries who are environmentally minded. The motivation for purchasing TDRs would naturally vary among prospective buyers. Some may have direct use values such as prospecting for new chemicals or pharmaceuticals. Others may be expressing their non-use values through the purchase of TDRs. Some might even buy and hold TDRs if they expect them to rise in value as a result of decreasing supply and increasing demand due to population and income growth or change in tastes and increase in environmental awareness. Certainly every new discovery of a valuable new species, or even a new use of existing species found in a particular habitat would increase the value of the TDRs of that site.

One way in which developed countries can stimulate the demand for TDRs is by providing credits to domestic firms and property owners for the acquisition of TDRs from developing countries against domestic environmental regulations such as building codes, forest harvesting and replanting regulations, environmental emission standards, CO₂ emission controls, etc. A criticism of this method of stimulating the demands for TDRs might be that the conservation of tropical forests would have been accomplished at the expense of the domestic environment in the developed countries. One way around this problem is to tighten environmental regulations from current levels

and then provide offset credits for buyers and holders of TDRs. Another method is by introducing a conservation tax and then allowing people the option to pay this annual tax or purchase and hold TDRs in lieu of the tax. The great advantage of this financing mechanism for the conservation of tropical forests and biodiversity is that it makes the opportunity costs clear and provides a vehicle for the beneficiaries to pay them. The debt-for-nature swaps are rudimentary applications of tradable development rights without the full benefit of tradability and market competition.

12.7.3.13 Other instruments

Non-biodiversity-targeted instruments and incentive measures such as the air pollution trading programme in the USA or water pollution charges in France, may have as great an impact on biodiversity as do measures specifically targeted for biodiversity conservation. The implication is that existing policies could be modified or fine-tuned to improve their performance with respect to biodiversity protection. For example, the tradable fishery quota system introduced in countries such as New Zealand to limit overfishing and to conserve commercial fish species could be modified to reduce the impact of incidental catches on other species and the inter-relationship of species with other aquatic wildlife.

12.7.4 Incentives and the appropriation of value: the global problem

Local market failure describes the inability of existing markets to capture non-market and non-use values of forests, wetlands, etc. within the context of a country or a local area. But there are missing global markets as well. We consider two such global markets which are highly relevant to biodiversity: existence value possessed by individuals in one country for wildlife and habitat in other countries, and the carbon storage values of tropical forests. Global appropriation failure (GAF) arises because these values are not easily captured or appropriated by the countries in possession of biological diversity.

Chapters 12.2 and 12.5 offered the results of some global existence value studies for particular species and habitats based on contingent valuation methods, for several countries. While it is not possible to argue definitively that similar kinds of expressed values will arise for the protection of biodiversity in other countries or for other species, even a benchmark figure of US\$10 per annum for the rich countries of Europe and North America would produce a fund of \$4 billion per annum. This is a significantly larger sum than that which will be available to the Global Environment Facility in its operational phase under the two Rio Conventions and its continuing role in capturing global values from the international water context; and in its role as provider of extra biodiversity conservation

under the Rio Convention (Pearce and Brown 1994).

All forests store carbon so that, if cleared for agriculture, there will be a release of carbon dioxide which will contribute to the accelerated greenhouse effect and hence global warming. In order to derive a value for the 'carbon credit' that should be ascribed to a tropical forest, we need to know (a) the net carbon released when forests are converted to other uses, and (b) the economic value of one tonne of carbon released to the atmosphere. Carbon will be released at different rates according to the method of clearance and subsequent land use. The data suggest that, allowing for the carbon fixed by subsequent land uses, carbon released from deforestation of secondary and primary tropical forest is of the order of 100–200 tonnes per hectare.

The carbon released from burning tropical forests contributes to global warming and recent work suggests a 'central' value of US\$20 of damage for every tonne of carbon released (Fankhauser and Pearce 1994). On this basis, converting an open forest to agriculture or pasture would result in global warming damage of \$600–1000 per hectare; conversion of closed secondary forest would cause damage of \$2000–3000 per hectare; and conversion of primary forest to agriculture would give rise to damage of \$4000–4400 per hectare (Brown and Pearce 1994).

It also seems to be the case that these 'carbon credit' values are larger than many development benefits that would accrue from forest conversion. This suggests that there is scope for a global bargain. The conserved forest is worth more to the global community than it is in its converted state to local 'developers'. If the industrialized countries can transfer a sum of money greater than the converted forest land value but less than the damage cost from global warming, there are mutual gains to be obtained.

The economic valuation of ecosystems and their function and service values is far from complete but it may well be that for some assets, such as forests, global values dominate local values. The implication of this is that schemes for international transfers will be needed to supplement the correction of both local market failures and domestic distortionary practices that contribute to deforestation. Uncertainty remains because the science of global warming has yet to uncover definitive proof of the scale and severity of global climate change impacts. Thus the carbon storage benefits are still probabilistic. Secondly, we do not have a comprehensive set of reliable and valid global existence value estimates for biodiversity. This leaves the issue of appropriation: how are the economic values to be turned into cash, technology or commodity flows to make them 'real' to those who make land-use decisions that cause biodiversity loss?

One of the main difficulties to be faced is that there is much less scope for correcting market failure in international markets than in national markets. Trade

barriers in the industrialized world often exacerbate environmental pressures in developing countries by impeding export of labour-intensive manufactures and forcing these countries to increase exports of unprocessed natural resource-based commodities, thus imposing pressure on indigenous natural resource systems including biodiversity. Eliminating these trade barriers would have significant economic and environmental benefits. Output would expand in labour-intensive processing industries, enabling developing countries to add more value to their exported primary materials and drawing off labour from rural areas into higher-productivity manufacturing employment at a faster rate. Faster employment growth would mitigate poverty and poverty-related environmental problems while growth in alternative sources of foreign exchange earnings would mitigate the over-exploitation of natural resources for export (Repetto 1993).

While export crops may be biologically no more damaging than other crops, it is frequently the case that exporters have little scope for appropriate pricing of domestic environmental resources. Northern demand for the output of Southern environmental resources is frequently cited as a major cause of environmental degradation. For example, about 3 million hectares in the Netherlands are devoted to agriculture. But a Dutch 'resource consumption audit' has revealed that another 13 million hectares (an area three times the size of the Netherlands) in other countries is required to meet the demand for domestic consumption and re-export of agricultural products. Increased Dutch demand for tapioca (dried cassava root) has helped stimulate a significant increase in Thailand's cassava production, which is argued to have contributed to extensive deforestation in northeast Thailand. Other large-scale forest losses can be linked to increasing Dutch imports of soybean from Brazil and oil palm from Malaysia (Netherlands National Committee for IUCN 1988, cited in WRI/IUCN/UNEP 1992: p. 52).

The problem in this case, as in the many others cited in this section, is that the environmental costs associated with the production of traded products in developing countries

are not being included in product prices. If all developing countries were to include the costs of environmental protection in the prices of their exports, especially to the North, they would be able to finance environmental protection (Repetto 1993). However, if any one developing country were to do so it would risk losing competitiveness.

12.7.4.1 Global environmental markets

There are, none the less ways in which international market failure can be corrected through creating global environmental markets (GEMs) (the following remarks on failure correction derive from Pearce 1994b). To begin with, it is useful to distinguish between private and public ventures, and between those that are regulation-induced and those that are spontaneous market initiatives. Public regulation-induced activity arises because of international agreements, such as the Biodiversity and Climate Change conventions; see Table 12.7-1 (Brown *et al.* 1993; Pearce and Brown, 1994). The US Government announced the Forest for the Future Initiative (FFI) in January 1993 under which carbon offset agreements will be negotiated between the USA and several countries, including Mexico, Russia, Guatemala, Indonesia and Papua New Guinea. The aim is for the US Environmental Protection Agency to broker deals involving the private sector.

While not strictly a private enterprise trade, in the Netherlands, the state electricity generation board (SEP) established a non-profit-making enterprise in 1990. FACE (Forests Absorbing Carbon dioxide Emissions) aims to sequester an amount of CO₂ equivalent to that emitted by one 600 MW power station. This is estimated to require some 150 000 hectares: 5000 ha in the Netherlands, 20 000 ha in central Europe and 125 000 ha in tropical countries. At the end of 1993 the actual area had risen to 180 000 ha with the additional area in tropical countries.

In the USA, offset deals are currently not directly linked to legislation, but several have occurred which are clearly a mix of anticipation of regulation and 'global good citizenship' (Newcombe and de Lucia 1993). These include

Table 12.7-1: A schema for global environmental markets.

	Regulation-induced	Spontaneous markets
Public/official ventures	Examples: government-to-government measures under joint implementation provisions of the Rio treaties: Norway, Mexico, Poland, GEF	Examples: government involvement in market ventures: Swiss Green Export aid; debt-for-nature swaps
Private sector ventures	Examples: carbon offsets against carbon taxes and externality adders	Examples: purchase of exotic capital; Merck and Costa Rica

the New England Power Co. investment in carbon sequestration in Sabah, Malaysia, through the reduction of carbon waste from inefficient logging activities. The forest products enterprise is run by Innoprise. New England Power estimate that some 300 000 – 600 000 tonnes of carbon (C) will be offset at a cost of below US\$2 tC. Rain Forest Alliance will assist in monitoring the project. New England Power regard the Innoprise project as the first of a series aimed at assisting with the Corporation's plan to reduce CO₂ emissions by 45% by the year 2000. PacifiCorp, an electricity utility in Oregon, is considering reforestation projects and urban tree planting programmes in the US, and an international sequestration project (Dixon *et al.* 1993). Two pilot projects have been announced: (a) a rural reforestation project in Southern Oregon which funds planting subject to a constraint of no harvesting for 45–65 years, at an estimated cost of around \$5 tC; and (b) an urban tree programme in Salt Lake City, Utah at a provisionally estimated cost of \$15–30 tC sequestered. Tenaska Corporation is considering sequestration projects in the Russian boreal forests. Ultimately, some 20 000 ha of forests may be created in the Saratov and Volgograd regions at a cost of \$1–2 tC. Russian partners in the venture include the Russian Forest Service, the Ministry of Ecology and others. Tenaska is also planning reforestation projects in Washington State to complement a project in Costa Rica.

While these investments are aimed at CO₂ reduction, sequestration clearly has the potential for generating joint benefits, i.e. for saving biodiversity as well through the recreation of habitats. Much depends here on the nature of the offset. If the aim is CO₂ fixation alone, there will be a temptation to invest in fast-growing species which could be to the detriment of biodiversity. It is important therefore to extend the offset concept so that larger credits are given for investments that produce joint biodiversity–CO₂ reduction benefits.

Newcombe and de Lucia (1993) have drawn attention to another potentially very large private trade which has global environmental benefits. Investment by the private sector in the developing world is invariably constrained by risk factors such as exchange rate risks, repayment risks, political risks and so on. In so far as this investment benefits the global environment, as with, say, the development of natural gas to displace coal, the existence of the risks reduces the flow of investment and hence the global environmental benefits. But these risks might be shared ('brought down') by having an international agency, such as the Global Environment Facility, provide some funds or services that help reduce the risk. Given the scale of private investment flows, the potential here is enormous. Nor is there any reason why it should not benefit biodiversity, either indirectly as a joint benefit of other investments, e.g. raising agricultural productivity and hence reducing the pressure for land degradation, or directly through afforestation schemes.

Financial transfers may take place without any regulatory 'push'. The consumer demand for green products has already resulted in companies deciding to invest in conservation either for direct profit or because of a mix of profit and conservation motives. The Body Shop is an illustration of the mixed motive, as is Merck's royalty deal with Costa Rica for pharmaceutical plants and Pro-Natura's expanding venture in marketing indigenous tropical forest products. There is, in other words, an incentive to purchase or lease 'exotic capital' in the same way as a company would buy or lease any other form of capital. More generally, environmental sensitivity is becoming a more pronounced feature of private business sector operations, e.g. the 'Environmentally Responsible Business' movement, increased use of environmental audits, eco-labelling of products and the publication of company environmental policy statements.

The deal between Merck and Co., the world's largest pharmaceutical company, and INBio (the National Biodiversity Institute of Costa Rica) is already well documented and studied (Reid *et al.* 1993). Under the agreement, INBio collects and processes plant, insect and soil samples in Costa Rica and supplies them to Merck for assessment. In return, Merck pays Costa Rica US\$1 million plus a share of any royalties should any successful drug be developed from the material supplied. The royalty agreement is reputed to be of the order of 1–3% and is to be shared between INBio and the Costa Rican Government. Patent rights to any successful drug would remain with Merck. Biodiversity is protected in two ways – by conferring commercial value to the biodiversity, and through the earmarking of some of the payments for the Ministry of Natural Resources.

How far is the Merck–INBio deal likely to be repeated? Several caveats are in order here to offset some of the enthusiasm over this single deal. First, Costa Rica is in the vanguard of biodiversity conservation, as its strong record in debt-for-nature swaps shows. Second, the country has a strong scientific base and a considerable degree of political stability. Both of these characteristics need to be present and their combination is not typical of developing countries. Third, the economic value of such deals is minimal unless the royalties are actually paid and that will mean success in developing drugs from the genetic material. The chances of such developments are small – perhaps one in 1000–10 000 of plant species screened (Pearce and Moran 1994). INBio has undertaken to supply 10 000 samples under the initial agreement. There is, therefore, the probability of one such drug being developed. But successful drugs could result in many hundreds of millions of dollars in revenues. Finally, there are two views on the extent to which deals of this kind could be given added impetus by the Biodiversity Convention. The convention stresses the role of intellectual

property rights in securing conservation and is sufficiently vaguely worded for there to be wide interpretation of its provisions. But it also appears to threaten stringent conditions concerning those rights and technology transfer and it remains to be seen how the relevant protocols are worded. If so, parties to the convention may find private deals being turned into overtly more political affairs with major constraints on what can be negotiated (Blum 1993).

Other examples of direct deals on 'biodiversity prospecting' include California's Shaman Pharmaceuticals (Brazil and Argentina) and the UK's Biotics Ltd. (general purchase and royalty deals), while Mexico and Indonesia are looking closely at the commercialization of biodiversity resources.

The demand for direct investment in conservation is not confined to the private sector. The demand for conservation by NGOs is revealed through debt-for-nature swaps, which are further examples of these exotic capital trades (for an overview see Pearce and Moran 1994; Deacon and Murphy 1994).

A great variety of trades is possible, involving both the public and private sectors. For example, consider the general area of resource franchise agreements (RFAs). The general principle of RFAs is that specific land uses in defined zones are restricted ('attenuated') in return for the payment of a premium. At one extreme, if all land uses other than outright preservation are forbidden, the premium equals the rental on the land that would arise in the 'best' development use. If some uses are restricted, the premium will tend to be equal to the differential rent between the unrestricted 'highest and best' use and the rental on the restricted use. The minimum supply price offered by colonizers and host governments will be this differential rent. The demand price will be determined by global willingness to pay for the benefits of attenuating land uses. This is the essence of the comparison made earlier between land prices and global warming damage estimates, for example. Payment of the premium would be, say, annual since an 'up front' payment could result in the host country renegeing on the understanding after payment is received. To secure compliance, annual payments would be made in order that they can be suspended in the event of non-compliance.

Such trades are not without their problems. The earlier example of carbon storage values compared land prices with the present value of global warming damage from a tonne of carbon dioxide. Two discount rates are embedded in this comparison: the farmer's and the world's. If payments have to be annual, the present values need to be annuitized. Since it is the farmer who has the property rights, his discount rate will dominate. The relevant comparison will be between annual willingness to pay and annual willingness to accept a premium. Another issue relates to the successional uses of land. The logger should effectively pay a price for land that reflects not just the logging value, but also a residual price if

the land can be sold on to ranchers and farmers. Markets need to work fairly well for the conservation and development values to be compared.

Several authors have suggested franchise-type agreements (Sedjo 1992; Panayotou 1994b). Such development rights could become tradable, just as joint implementation schemes could become open to subsequent bargains leading to a full emissions trading programme. The potential buyers could range from local conservation groups through to international conservation societies, corporations, governments and so on, with motives ranging from profiting from sustainable use through to scientific research and good citizenship images. Panayotou (1994b) suggests that corporations in developed countries could be given credit for buying into such tradable rights, e.g. through relaxations on domestic regulatory obligations. Measure against the *status quo* this obviously has the disadvantage of 'trading' environmental quality between developed and developing country economies, a problem that has brought criticism on joint implementation proposals already. Nonetheless, the approach could be utilized in the event of tighter developed country restrictions being contemplated.

The incentives that are required to conserve biological resources and diversity at the local level usually require commensurate policies at the national level. A *national or regional conservation strategy* can be an effective means of reviewing such policies, and of determining what shifts are required to achieve national objectives for biodiversity conservation. The following steps are a necessary component of such a strategy (McNeely 1993).

1. Quantify and bring to the attention of policy-makers the many economic and financial benefits of integrating rural development activities with conservation of biological resources and diversity.
2. Identify both conflicts and potential for co-operation between the various activities of agriculture, fisheries, forestry, conservation and rehabilitation of degraded lands.
3. Formulate legislation consonant with the socioeconomic patterns of the target group and the natural resources being utilized, both to institute a system of penalties and rewards and to ensure that incentives carry the power of law.
4. Review policies and legislation in other sectors for possible applications to conservation of biodiversity and community involvement in such work.
5. Devise effective incentives to accelerate integrated development to close any gap between what the

individual sees as an investment benefit and what the government considers to be in the national interest.

6. Establish new administrative structures for managing biological resources. While those resources contained within strictly protected areas are usually government controlled (in theory), biological resources in buffer zones, coastal areas, national forests and communal areas are often 'open access' resources and need to be brought into some form of management regime.
7. Develop the capacity of local communities to participate in conservation efforts so as to ensure that these measures are more likely to yield immediate and real benefits to local people.

12.7.5 Incentives, property rights and the distribution of assets

Given the emerging consensus amongst community and systems ecologists about system structure and functioning, the major implication of an economic approach to the problem of biodiversity loss is that it should be concerned less with the preservation of the status quo than with the maintenance of sufficient biodiversity to assure the resilience of ecosystems delivering services of value to humanity. Much of the non-economic literature on biodiversity loss has tended to focus on the preservation of species now threatened with extinction due to the loss of habitat. But if we are concerned with the sustainability of resource use, then we are generally concerned with something rather different. Species loss is important primarily because it threatens the resilience of the ecological systems on which humankind collectively depends.

Since the non-existence of markets is a major cause of the divergence between the private and social cost of species deletion, and since the non-existence of markets reflects the incompleteness of property rights, it is not surprising that one option for ensuring against excessive species depletion is the allocation of property rights in order to create markets. This is particularly appropriate where the problem is one of local depletion as a consequence of some unidirectional externality. Though biodiversity in general is in the nature of a public good, many species and even more local populations are both exclusive and rival in consumption. Similarly, though many aspects of the biosphere are in the nature of public goods, many ecosystems and ecosystem services are similarly exclusive and rival in consumption. If it is possible to generate markets in these, it may be possible to eliminate one source of discrepancy between private and social cost. This is, of course, subject to the usual restrictions concerning the numbers of people party to an externality, and the costs of negotiation. It should also be borne in mind that the word 'market' can mean something

much more general than the locus of price-based transactions. It includes, for example, all those institutions that facilitate the negotiation between the parties affected by some action (Dasgupta 1991; Dasgupta and Mäler 1991).

There are innumerable potential candidates for a solution involving the creation of markets through the allocation of rights, some of which have been discussed above. In each case the optimal solution has to take into account not only the incentive effects of the proposed allocation of property rights, but also whether they meet the wider objectives of society. Property rights evolve in different circumstances to meet a range of institutional and cultural conditions and a specific set of social objectives. Hence one is interested in asking whether there exists a modification that will prevent the over-utilization of environmental resources, either (a) without conflicting with these original conditions or objectives, or (b) by meeting the needs of changes in both institutions and conditions.

This often depends on the distributional impact of any change in the structure of property rights. We have repeatedly drawn attention to the importance of both market and non-market income in the private valuation of resources, and have remarked on the potential for income effects to dominate the private valuation of resources, the rate at which the future costs of present activity are discounted, and the amount of information acquired in the decision-making process. The distribution of assets in any given case will have considerable bearing on the distribution of market and non-market income, and so on the private valuation of resources. The point here is that the reallocation of property rights implies the redistribution of assets, since no allocation takes place in a vacuum. Indeed, in our earlier discussion of the effectiveness of incentives to local producers, we have assumed that this will depend on a redistribution of assets in favour of the poorer resource users.

Similarly, the indirect threat to biodiversity of high levels of indebtedness in the low-income countries is what lies behind various proposals to reduce the debt burden of those countries, including the proposals to swap debt for 'nature' – some of which have been reviewed in Chapter 12.5 for their implicit valuation of the resources. At the micro-economic level, there is a further reason to be concerned about the level and distribution of income apart from its effect on the information sought in the decision-making process and the rate at which future costs are discounted. At very low levels of income the probability that the income effects in price changes will be perverse rises. In other words, an increase in the private cost of some environmental resource may lead to an increase in its usage rather than a decrease. As a result, the goals of a price policy designed to promote biodiversity conservation by reducing pressure on ecosystems may be compromised by the effects of that policy on income (Perrings 1991). This is why income transfers are a necessary part of instruments used to change the incentives to private resource users.

A common characteristic of many ecosystems is that resources are non-exclusive in their use: they are in the nature of local (congestible) public goods. Hence markets in the resources will not tend to develop naturally. Property rights can still be allocated to environmental public goods, but in this case they should be restricted to usufructual or user rights. Harvesting quotas, emission permits and the development rights discussed earlier in this chapter are all examples of such rights.

Given the uncertainty associated with the future environmental effects of increasing levels of use of these resources, and the potential for 'overshooting' ecological thresholds and the irreversibility of the effects of overshooting, the best means of assuring the ecological sustainability of economic activity lies in the application of safe minimum standards of environmental access. It has been argued that the rational response to the irreversibility of environmental effects is to slow down the rate of environmental exploitation (Henry 1974; Miller 1981). Where the existence of thresholds means that unknown irreversible effects may be catastrophic, the same models indicate that it is prudent not just to slow down the rate of exploitation where this approaches critical thresholds, but to stop it.

Notice, though, that even though the application of safe minimum standards of environmental access appears to limit the scope of the market in conserving biodiversity, it actually heightens the need for the economic valuation of biological resources. The role of valuation in this case is twofold: to help in the identification of the right level of biodiversity protection and to help establish the financial incentive needed to secure that level of protection. Since any level of an environmental protection involves some cost, what is needed is an estimate of the benefits to society of protection at different levels. Similarly, since any level of protection implies a corresponding level of demand for environmental resource, what is needed is an estimate of the resource 'price' that will generate such a level of demand.

A special set of problems surrounds the regulation of access to resources in which there is no clear central authority, sometimes referred to as the global commons. In reality, access to every public good involves a political process, in the course of which users cede rights to some decision-making regulatory authority. However, this is most obviously a difficulty in the case of ecological services that extend across a number of juridical boundaries, such as, for example, the upper atmosphere. Global biodiversity is in the same category. A considerable amount of work has now been done on the strategic behaviour of participants to international environmental negotiations, and the conditions necessary to achieve a co-operative outcome (Barrett 1990, 1994; Dasgupta and Mäler 1991). Work on the strategic behaviour of parties to international negotiations over common property resources, and the more familiar compensation principle, suggest the importance of transfers

as instruments of international environmental policy and this is in fact the basis of the Global Environment Facility.

The critical questions from an economic policy perspective concern the distribution of the benefits of biodiversity conservation between individual users of biological resources, nation states, regional groupings and the international community. It is the fact that the private and social costs of biodiversity depletion differ that creates the problem of excessive biodiversity loss in the first instance. But, as Barrett (1994) shows, it is the distribution of the social costs of depletion that determines how effectively the problem may be addressed. The link that is now being emphasized between functional diversity and ecological resilience is significant precisely because of its implications for the distribution of the social costs of biodiversity depletion. If the main implications of biodiversity depletion lie in the genetic information losses associated with species or population deletion, then it follows that the main social costs of biodiversity loss are indeed global. However, if the main implications of biodiversity depletion lie in the loss of ecosystem resilience, then the main social costs of biodiversity loss will be ecosystem-specific. That is, to a large extent they will manifest themselves in the same physical system as that in which the losses were incurred.

This point seems to us to be of considerable importance. If it is understood that a large part of the social costs of biodiversity are local, not only is the problem easier to address at a national level, but the relative value of the transfers needed to induce international co-operation is also reduced. Species deletion at private hands may still involve both information and insurance costs that are incurred by the global community, but if the main external costs of private actions leading to loss of functional diversity accrues to other users of the same ecosystem, the optimal policy response is a local one.

12.7.6 Concluding remarks

We conclude by restating what seem to be the most important observations on the link between valuation, policy and the conservation of biodiversity:

- The allocation of biological resources on the basis of current market signals is **inefficient** and **inequitable**. It leads to losses in social welfare. Moreover, these losses are distributed in a way that bears most heavily on both the poorer members of this generation and all members of future generations. An appropriate strategy for biodiversity conservation should address both the efficiency and equity issues. Valuation is an essential element of this.
- The valuation of biological resources provides a means of (a) quantifying the costs of market and policy failure, (b) testing its sensitivity to assumptions

made about the distribution of income and assets and the weight given to consumption by members of future generations, (c) identifying where markets might be reformed to remove the current sources of bias, (d) showing, where it is not possible to reform markets, how governments might intervene to correct the signals to private resource users, and (e) indicating how and where economic activity can be constrained so as to protect biological resources that are important for maintaining the options open to future generations.

- Efficiency and equity both require the development of effective **institutions** and **incentives** that will (a) confront resource users with the full social cost of their behaviour, and (b) enable those who invest in conservation to appropriate the benefits.
- Traditional approaches to protected areas have sometimes worked against the interests of local populations by removing traditional rights of access to the resources in protected areas and the benefits of that access, thereby taking responsibility for management of the area away from local people.
- To be effective in an evolving ecological-economic systems, institutions need to be **adaptive**, i.e. able to respond to environmental feedbacks before those effects challenge the resilience of the entire resource base, and the economic activity that depends on it.
- Institutions need to safeguard the resilience of ecosystems by safeguarding the biological resources which support that resilience. It is necessary to **bound economic activity to minimize the risk of irreversible damage** to ecosystems on which human activity depends. The rational response to the irreversibility of environmental consequences of economic activity is to slow down that activity. Where the existence of thresholds means that unknown irreversible effects may be catastrophic, the rational response is to stop it.
- Preserving biological resources through nature reserves and other protected areas may be an important short-term step where biological resources are under immediate threat. But it is not feasible to protect critical ecological systems by excluding human users of wild resources.

References

- Abbott, L. 1955. *Quality and Competition*. Columbia University Press, New York.
- Abeygunawardena, P. and Wickramasinghe, W.A.R. 1992. An economic evaluation of non-timber products of Hantana Forest, In: Gunagina, H.P.M. (ed.), *Multi-Purpose Tree Species in Sri Lanka: Research and development. Proceedings of the Second Regional Workshop*. Organized by the National Research Committee in Multi Purpose Trees Species, Winrock International, F/FRED, Bangkok, Thailand, 5-7 April, 1992.
- Abramovitz, J.N. 1991. *Investing in Biological Diversity: US research and conservation efforts in developing countries*. World Resources Institute, Washington, DC.
- Adamowicz, W.L., Louviere, J. and Williams, M. 1994. Combining Stated and revealed preference methods for valuing environmental amenities. *Journal of Environmental Management* 26.
- Adger, W.N., Brown, K., Cervigni, R. and Moran, D. 1995. Total economic value of forests in Mexico. *Ambio* 24: 286–296.
- Ahmad, Y., El Sarafy, S. and Lutz, E. (eds) 1989. *Environmental Accounting for Sustainable Development*. World Bank, Washington, DC.
- Alberini, A. 1994. *Testing Distributional Assumptions with Discrete Choice Contingent Valuation Data*. Resources for the Future, Washington, DC.
- Alcorn, J. 1989. An economic analysis of Huastec Mayan agroforestry management. In: Browder, G. (ed.), *Fragile Lands of Latin America: Strategies for sustainable development*. Westview Press, Boulder, Colo.
- Anderson, A.B. 1990. extraction and forest management by rural inhabitants in the Amazon estuary. In Anderson, A.B. (ed.) *Alternatives to Deforestation: Steps toward sustainable use of the Amazon rain forest*. Columbia University Press, New York.
- Anderson, A.B. and Ioris, E.M. 1992. The logic of extraction: resource management and income generation by extractive producers in the Amazon estuary. In Redford, K.H. and Padoch, C. (eds), *Conservation of Neotropical Forests: Working from traditional resource use*. Columbia University Press, New York.
- Anderson, A.B., May, P. and Balick, M. 1991. *The Subsidy from Nature: Palms, forests, peasantry, and development on an Amazon Frontier*. Columbia University Press, New York.
- Anderson, D. 1987. The economics of afforestation; a case study in Africa. *World Bank Occasional Paper No 1*. Johns Hopkins University Press, Baltimore.
- Andreoni, J. 1990. Impure altruism and donations to public goods: a theory of warm glow giving. *The Economic Journal* 100: 464–477.
- Appasamy, P. 1993. Role of non-timber forest products in a subsistence economy: the case of a joint forestry project in India. *Economic Botany*, 47.
- Arrow, K.J. and Fisher, A.C. 1974. Environmental preservation, uncertainty, and irreversibility. *Quarterly Journal of Economics* 88: 312–319.
- Arrow, K.J. and Hurwicz, L. 1972. An optimality criterion for decision-making under ignorance. In: Carter, C.F. and Ford, J.L. (eds), *Uncertainty and Expectations in Economics*. 1–11. Blackwell, Oxford.
- Arrow, K.J. and Lind, R. 1970. Uncertainty and the evaluation of public investment decisions. *American Economic Review* 60: 364–378.
- Arrow, K.J., Solow, R. Portney, P.R., Leamer, E.E., Radner, R. and Schuman, J. 1993. *Report of the NOAA Panel on Contingent Valuation*, January.
- Aylward, B.A. 1993. The economic value of pharmaceutical

- prospecting and its role in biodiversity conservation. *LEEC Discussion Paper 93-05*. International Institute for Environment and Development, London.
- Aylward, B.A.** and Barbier, E.B. 1992. Valuing environmental functions in developing countries. *Biodiversity and Conservation* **1**: 34-50.
- Balick, M.** and Mendelsohn, R.O. 1992. Assessing the economic value of traditional medicines from tropical forests. *Conservation Biology* **6**.
- Barbier, E.B.** 1992. Rehabilitating gum arabic systems in Sudan: economic and environmental implications. *Environmental and Resource Economics* **2**: 341-358.
- Barbier, E.B.** 1994a. Natural capital and the economics of environment and development. In: Jansson, A.M., Hammer, M. and Costanza, R.A. (eds), *Investing in Natural Capital: The ecological economics approach to sustainability*. Island Press, New York.
- Barbier, E.B.** 1994b. Valuing environmental functions: tropical wetlands. *Land Economics* **70** (2): 155-173.
- Barbier, E.B., Adams, W.M.** and Kimmage, K. 1991. Economic valuation of wetland benefits: The Hadejia-Jama'are Floodplain, Nigeria. *LEEC Discussion Paper 91-02*. IIED, London.
- Barbier, E.B., Burgess, J.C., Bishop, J.T.** and Aylward, B.A. 1994. *The Economics of the Tropical Timber Trade*. Earthscan, London.
- Barbier, E.B., Burgess, J.C.** and Folke, C. 1994. *Paradise Lost? The ecological economics of biodiversity*. Earthscan, London.
- Barbier, E.B., Burgess, J.C.** and Markandya, A. 1991. The economics of tropical deforestation. *Ambio* **20** (2): 55-58.
- Barbier, E.B., Burgess, J.C., Swanson, T.M.** and Pearce, D.W. 1990. *Elephants, Economics and Ivory*. Earthscan, London.
- Barnes, D.L.** 1979. Cattle ranching in the semi-arid savannas of east and southern Africa. In: Walker, B.H. (ed), *Management of Semi-Arid Ecosystems*, 9-54. Elsevier, Amsterdam.
- Barnes, J.** and Pearce, D.W. 1991. *The Mixed Use of Habitat*. Centre for Social and Economic Research on the Global Environment, London.
- Barrett, S.** 1990. The problem of global environmental protection. *Oxford Review of Economic Policy* **6** (1): 68-79.
- Barrett, S.** 1992. Economic-growth and environmental preservation. *Journal of Environmental Economics and Management* **23**(3): 289-300.
- Barrett, S.** 1994. The biodiversity supergame. *Environmental and Resource Economics* **4** (1): 111-122.
- Bateman, I.J., Langford, I.H., Willis, K.G., Turner, R.K.** and Garrod, G.D. 1993. The impacts of changing willingness to pay question format in contingent valuation studies: an analysis of open-ended, iterative bidding and dichotomous choice formats. *CSERGE Working Paper GEC 93-05*. Centre for Social and Environmental Research on the Global Environment, University of East Anglia, Norwich and University College London.
- Beggs, S., Cardel, S.** and Hausman, J. 1981. Assessing the potential demand for electric cars. *Journal of Econometrics* **16** (1): 1-19.
- Berg, J.E., Dickhaut, J.W.** and O'Brien, J.R. 1983. *Preference Reversal and Arbitrage*. Manuscript, University of Minnesota, September.
- Bergstrom, J.C., Stoll, J.R., Titre, J.P.** and Wright, V.L. 1990. Economic value of wetlands-based recreation. *Ecological Economics* **2**: 129-147.
- Berkes, F., Folke, C.** and Gadgil, M. 1994. Traditional ecological knowledge, biodiversity, resilience and sustainability. In: Perrings, C., Mäler, K-G., Folke, C., Holling, C.S. and Jansson, B.-O. (eds), *Biodiversity Conservation: Problems and policies*. Kluwer Academic Press, Dordrecht.
- Binswanger, H.** 1989. Brazilian policies that encourage deforestation in the Amazon. *Environment Department Working Paper No. 16*. World Bank, Washington DC.
- Bishop, R.** 1978. Endangered species and uncertainty: the economics of a safe minimum standard. *American Journal of Agricultural Economics* **60**: 10-18.
- Bishop, R.C.** and Ready, R.C. 1991. Endangered species and the safe minimum standard. *American Journal of Agricultural Economics* **73**: 309-12.
- Blamey, R.** and Common, M. 1994. Sustainability and the limits to pseudo-market valuation. In: van den Bergh, J.C.J.M. and Van der Straaten, J. (eds), *Concepts Methods and Policy for Sustainable Development: Critique and new approaches*. Island Press, New York.
- Blum, E.** 1993. Making biodiversity conservation profitable: a case study of the Merck/Inbio agreement. *Environment* **35**: 16-20, 38-45.
- Bockstael, N.E.** and McConnell, K.E. 1981. Theory and estimation of the household production function for wildlife recreation. *Journal of Environmental Economics and Management* **8**: 199-214.
- Bockstael, N.E., Hanemann, M.** and Kling, C. 1987. Estimating the value of water quality improvements in a recreational demand framework. *Water Resources Research* **23**(5): 951-960.
- Bockstael, N.E., Strand, I.E.** and Hanemann, W.M. 1987. Time and the recreation demand model. *American Journal of Agricultural Economics* **69** (2): 293-302.
- Bojo, J.** 1993. Economic valuation of indigenous woodlands in Zimbabwe. In: Bradley, P. and McNamara, K. (eds), *Living with Trees: A future for social forestry in Zimbabwe*. World Bank, Washington, DC.
- Bowes, M.D.** and Krutilla, J.V. 1989. *Multiple-Use Management: The economics of public forestlands*. Resources for the Future, Washington, DC.
- Bowker, J.M.,** and Stoll, J.R. 1988. Use of dichotomous choice nonmarket methods to value the whooping crane resource. *American Journal of Agricultural Economics* **70**: 372-381.
- Boyle, K.H.** and Bishop, R.C. 1987. Toward total valuation of Great Lakes fishery resources. *Water Resources Research* **5**: 943-950.
- Boyle, K.H.** and Bishop, R.C. 1986. *The Economic Valuation of Endangered Species in Wildlife*. Transactions of the Fifty-First North American Wildlife and Natural Resource Council.
- Brookshire, D.S.** and Neill, H. 1992. Benefit transfers: conceptual and empirical issues. *Water Resources Research* **28**: 651-655.
- Brookshire, D.S., Randall, A.** and Stoll, J.R. 1980. Valuing increments and decrements in natural resource service flows. *American Journal of Agricultural Economics* **62**: 478-488.
- Browder, J.** 1988. Public policy and deforestation in Brazilian

- Amazon. In: Repetto, R. and Gillis, M. (eds) *Public Policies and Misuse of Forest Resources*. Cambridge University Press, New York.
- Brown, G.M.** 1993. The economic value of elephants, with W. Henry. In: Barbier, E.B. (ed.), *Economics and Ecology: New frontiers and sustainable development*. Chapman and Hall, London.
- Brown, G.M.** 1990. Valuation of genetic resources. In: Orians, G.H. Brown, G.M. Kunin, W.E. and Swierbinski, J.E. (eds), *The Preservation and Valuation of Biological Resources*. 203–228. University of Washington Press, Seattle.
- Brown, G.M., Layton, D. and Lazo, J.** 1994. Valuing habitat and endangered species. *Discussion Paper 94-1* (January). Institute for Economic Research, University of Washington.
- Brown, G.M. and Mendelsohn, R.** 1984. The hedonic travel cost model. *Review of Economics and Statistics* **66**: 427–433.
- Brown, G.M., Layton, D. and Lazo, J.** 1994. *Valuing habitat and endangered species*. Unpublished research paper, NSF Grant SES-9213309.
- Brown, K., Adger, W.N. and Turner, R.K.** 1993. Global environmental change and mechanisms for north–south resource transfers. *Journal of International Development* **5**: 571–589.
- Brown, K. and Pearce, D.W.** 1994. The economic value of non-marketed benefits of tropical forests: carbon storage. In: Weiss, J. (ed.), *The Economics of Project Appraisal and the Environment*. 102–123. Edward Elgar, London.
- Brown, S.P.** 1983. A note on environmental risk. *Journal of Environmental Economics and Management* **6**: 282–286.
- Burt, O. and Brewer, D.** 1974. Estimation of net social benefits from outdoor recreation. *Econometrica* **39**: 813–827.
- Bye, R.** 1993. The role of humans in the diversification of plants in Mexico. In: Bye, R., Lot, A. and Fa, J. (eds) *Biological diversity in Mexico: Origins and distributions*. 707–31. Oxford University Press, New York.
- Caldecott, J.** 1987. *Hunting and Wildlife Management in Sarawak, Malaysia*. World Wide Fund for Nature, Washington, DC.
- Cameron, T.A. and Quiggin, J.** 1994. Estimation using contingent valuation data from a 'dichotomous choice with follow-up' questionnaire. *Journal of Environmental Economics and Management* **27**: 218–234.
- Campbell, B.M.** 1993. *The Monetary Valuation of Tree-Based Resources in Zimbabwe: Experience and outlook*. Paper prepared for FAO.
- Carson, R.T. et al.** 1992. A contingent valuation study of lost passive use values resulting from the Exxon Valdez oil spill. *Report to the Attorney General of the State of Alaska, Vol. 1, Natural Resource Damage Assessment, Inc.*, November.
- Carson, R.T. et al.** 1995. A bibliography of contingent valuation studies and papers. *Natural Resource Damage Assessment, Inc.*, La Jolla, Calif. (January).
- Castro, R.** 1994. The economic opportunity cost of wildlands conservation areas (EOCWCA): the case of Costa Rica. Thesis Proposal, Harvard University, Mass.
- Caulfield, C.** 1984. *In the Rainforest: Report from the strange, beautiful, imperilled world*. The University of Chicago Press, Chicago.
- Caulkins, P., Bishop, R. and Bouwes, N.** 1986. The travel cost model for lake recreation: a comparison of two methods for incorporating site quality and substitution effects. *American Journal of Agricultural Economics*, May: 291–297.
- Cavalli-Sforza, L.L., Menozzi, P. and Piazza, A.** 1994. *The History and Geography of Human Genes*. Princeton University Press, Princeton, NJ.
- Chevas, J.P., Stoll, J. and Sellar, C.** 1989. On the commodity value of travel time in recreational activities. *Applied Economics* **21**: 711–722.
- Child, B.** 1990. Assessment of wildlife utilisation as a land use option in the semi-arid rangeland of southern Africa. In: Kiss, A. (ed.), *Living with Wildlife: Wildlife resource management with local participation in Africa*. Technical Paper No. 130. The World Bank, Washington, DC.
- Chopra, K.** 1993. The value of non-timber forest products: an estimate from India. *Economic Botany* **47** (3): 251–7.
- Ciriacy-Wantrup, S.** 1968. *Resource Conservation: Economics and policies*. University of California, Berkeley.
- Clawson, M. and Knetsch, J.** 1966. *Economics of Outdoor Recreation*. Johns Hopkins University Press, Baltimore.
- Collard, D.** 1978. *Altruism and Economy: A study of non-selfish economics*. Martin Robertson, Salisbury.
- Common, M. and Perrings, C.** 1992. Towards an ecological economics of sustainability. *Ecological Economics* **6**: 7–34.
- Constantino, L. and Kishor, N.** 1993. *Forest Management and Competing Land Uses: An economic analysis for Costa Rica*. Latent Dissemination Note No. 7. The World Bank, Washington, DC.
- Costanza, R., Norton, B. and Haskell, B.** 1992. *Ecosystem Health: New goals for environmental management*. Island Press, Washington, DC.
- Costanza, R. and Perrings C.A.** 1990. A flexible assurance bonding system for improved environmental management. *Ecological Economics* **2** (1): 57–76.
- Coyne, A. and Adamowicz, W.** 1992. Modelling choice of site for hunting bighorn sheep. *Wildlife Society Bulletin* **20**: 26–33.
- Crosby, A.** 1986. *Ecological Imperialism: The biological expansion of Europe*. Cambridge University Press, Cambridge.
- Cruz, W. and Repetto, R.** 1991. *Accounts Overdue: Natural resource depreciation in Costa Rica*. World Resources Institute, Washington, DC.
- Cruz, W. and Repetto, R.** 1992. *The Environmental Effects of Stabilization and Structural Adjustment Programmes: The Philippines case*. World Resource Institute, Washington, DC.
- Cummings, R.G., Brookshire, D.S. and Schulze, W.D.** (eds) 1986. *Valuing Environmental Goods: An assessment of the contingent valuation method*. Rowman and Allanheld, Totowa, NJ.
- Daly, H. and Cobb, J.B.** 1989. *For the Common Good*. Beacon Press, Boston.
- Dasgupta, P.** 1991. The environment as a commodity. In: Blasi, P. and Zamagni, S. (eds), *Man-Environment and Development: Towards a global approach*. 149–180. Nova Spes International Foundation Press, Rome.
- Dasgupta, P.** 1993. *An Inquiry into Wellbeing and Destitution*. Oxford University Press, Oxford.
- Dasgupta, P. and Heal, G.M.** 1979. *Economic Theory and*

- Exhaustible Resources*. Cambridge University Press, New York.
- Dasgupta, P.** and Mäler, K-G. 1991. The environment and emerging development issues. In: *Proceedings of the World Bank Annual Conference on Development Economics 1990*. 101–131. World Bank, Washington, DC.
- Deacon, R.** and Murphy, P. 1994. The structure of environmental transaction: the debt-for-nature swap. Unpublished working paper. Department of Economics, university of California, Santa Barbara.
- de Groot, R.S.** 1992. *Functions of Nature: Evaluation of nature in environmental planning, management and decision making*. Wolters-Noordhoff BV, Groningen.
- de Groot, R.S.** 1994. Environmental functions and the economic value of natural ecosystems. In: Jansson, A.M., Hammer, M. and Costanza, R.A. (eds), *Investing in Natural Capital: The ecological economics approach to sustainability*. Island Press, New York.
- Diamond, J.** 1993. New Guineans and their natural world. In: Kellert, S.T. and Wilson, E.O. (eds), *The Biophilia Hypothesis*. 251–271. Island Press, Washington, DC.
- Diamond, J.M.** 1992. *The Rise and Fall of the Third Chimpanzee*. Vintage, London.
- Diamond, J.M.** 1994. Ecological collapses of ancient civilisation: the golden age that never was. *Bulletin of the American Academy of Arts and Sciences* **47**: 37–59.
- Diamond, P.A.** and Hausman, J.A. 1994. Contingent valuation: is some number better than no number? *Journal of Economic Perspectives* **8**: 19–44.
- Directorate for Nature Management.** 1992. *Biological diversity in Norway: A country study*. DN report 1992–56, Trondheim, Norway.
- Dixon, J.A.** and Sherman, P.B. 1990. *Economics of Protected Areas: A new look at benefits and costs*. Island Press, Washington, DC.
- Dixon, R.K.,** Andrasko, K.J., Sussman, F.A., Lavinson, M.A., Trexler, M.C. and Vinson, T.S. 1993. Forest sector carbon offset projects: near term opportunities to mitigate greenhouse gas emissions. *Water, Soil and Air Pollution* **70**: 561–577.
- Dow, S.** 1993. Uncertainty about uncertainty. *Discussion papers in Economics* 93/7. University of Stirling.
- Earl, P.E.** 1983. *The Economic Imagination: Towards a behavioural analysis of choice*. Wheatsheaf, Brighton.
- Ehrlich, P.R.** and Ehrlich, A.E. 1992. The value of biodiversity. *Ambio* **21**: 219–226.
- Ellis, G.M.** and Fisher, A.C. 1987. Valuing the environment as input. *Journal of Environmental Management* **25**: 149–156.
- Englin, J.** and Mendelsohn, R. 1991. A hedonic travel costs analysis for the valuation of multiple components of site quality: the recreation value of forest management. *Journal of Environmental Economics and Management* **21**: 275–290.
- Fankhauser, S.** 1995. *Valuing Climate Change: The economics of the greenhouse*. Earthscan, London.
- Fankhauser, S.** and Pearce, D.W. 1994. The social costs of greenhouse gas emissions. In: *OECD: The economics of climate change*. 71–86. OECD, Paris.
- Farber, S.J.** 1991. Regulatory schemes and self-protective environmental risk control: a comparison of insurance, liability, and deposit/refund systems. *Ecological Economics* **3** (3): 231–246.
- Farley, W.B.** 1982. Market risk assessment of catastrophic risks. In: Kunreuther, H.C. and Ley, E.V. (eds), *The Risk Analysis Controversy: An institutional perspective*. 195–202. Springer-Verlag, New York.
- Filion, F.** and Adamowicz, V. 1994. Socioeconomic evaluation of biodiversity. In: *Biodiversity Science Assessment team, Biodiversity in Canada: A science assessment*. 221–242. Environment Canada, Ottawa.
- Filion, F.,** Foley, J.P., and Jacquemot, A. 1994. The economics of global ecotourism. In: Munasinghe, M. and McNeely, J. (eds), *Protected Area Economics and Policy – Linking conservation and sustainable development*, The World Bank, Washington, DC.
- Fisher, A.C.** and Hanemann, W.M. 1983. Option value and the extinction of species. *Working Paper 269, Giannini Foundation of Agricultural Economics*. University of California, Berkeley.
- Fletcher, J.,** Adamowicz, W. and Graham-Tomasi, T. 1990. The travel cost model of recreation demand. *Leisure Sciences* **12**: 119–147.
- Folke, C.** 1991. Socioeconomic dependence on the life-supporting environment. In: Folke, C. and Kåberger, T. (eds), *Linking the Natural Environment and the Economy: Essays from the Eco-Eco Group*. Kluwer Academic Publishers, Dordrecht.
- Folke, C.** and Kautsky, N. 1992. Aquaculture with its environment: prospects for sustainability. *Ocean and Coastal Management* **17**: 5–24.
- Freeman, A.M.** 1991. Valuing environmental resources under alternative management regimes. *Ecological Economics* **3**: 247–256.
- Friedman, M.** and Savage, L.J. 1948. The utility analysis of choices involving risk. *Journal of Political Economy* **56**: 279–404.
- Friis-Hansen, E.** 1994. Conceptualizing *in situ* conservation of landraces. In: Krattiger, A.P. *et al.* (eds), *Widening Perspectives in Biodiversity*. IUCN, Gland.
- Gadgil, M.** and Berkes, F. 1991. Traditional resource management systems. *Resource Management and Optimisation* **18** (3–4): 127–141.
- Gadgil, M.** (1995). Traditional conservation practices. In: *Encyclopaedia of Environmental Biology*. Academic Press, New York (in press).
- Gadgil, M.,** Berkes, F. and Folke, C. 1993. Indigenous knowledge for biodiversity conservation. *Ambio* **22** (2–3), 151–155.
- Gadgil, M.** and Guha, R. 1992. *This Fissured Land: An ecological history of India*. Oxford University Press, New Delhi and University of California Press, Berkeley.
- Garrod, G.** and Willis, K. 1991. Some empirical estimates of forest amenity value. *Working Paper 13*. Countryside Change Centre, University of Newcastle-upon-Tyne.
- Georgescu-Roegen, N.** 1971. *The Entropy Law and the Economic Process*. Harvard University Press, Cambridge, Mass.
- Ghai, D.** and Radwan, S. (eds) 1983. *Agrarian Policies and Rural Poverty in Africa*. ILO, Geneva.
- Githinji, M.** and Perrings, C. 1993. Social and economic

- sustainability in the use of biotic resources in Sub-Saharan Africa. *Ambio* **22**: 110–116.
- Godoy**, Lubrowski and Markandya, A. 1993. A method for the economic valuation of non-timber tropical forest products. *Economic Botany* **47**: 3.
- Goodin**, R. 1982. Discounting discounting. *Journal of Public Policy* **2**.
- Grainger**, A. 1990. *The Threatening Desert - Controlling desertification*. Earthscan, London.
- Greene**, W. 1990. *Econometric Analysis*. MacMillan, New York.
- Gren**, I.-M., Folke, C., Turner, R.K. and Bateman, I.J. 1994. Primary and secondary values of wetland ecosystems. *Environmental and Resources Economics* **4**: 55–74.
- Griffith**, A.B. 1991. A contingent valuation analysis of the value of tropical rain forest protection by Pennsylvania citizens. MS thesis, Pennsylvania State University.
- Grout**, P. 1981. Social welfare and exhaustible resources. In: Butlin, J. (ed.), *Economics of the Environment and Natural Resource Policy*. Westview Press, Boulder, Colo.
- Hagemann**, R. 1985. *Valuing Marine Mammal Populations: Benefit valuations in a multi-species ecosystem*. National Marine Fisheries Service, Southwest Fisheries Center, La Jolla, Calif.
- Hagen**, D., Vincent, J. and Welle, P. 1991. Benefits of preserving old-growth forests and the northern spotted-owl. Unpublished Working Paper. Western Washington University, Bellingham, Wash.
- Haigh**, N. 1993. *The Precautionary Principle in British Environmental Policy*. Institute for European Environmental Policy, London.
- Hanemann**, W.M. 1994. Valuing the environment through contingent valuation. *Journal of Economic Perspectives* **8**: 19–44.
- Hanley**, N. and Ruffell, R. 1993. The valuation of forest characteristics. In: Adamowicz, W. and White, W. (eds), *Forestry and the Environment: Economic perspectives*. CAB International, Oxford.
- Hanley**, N. 1989. Valuing rural recreation benefits: an empirical comparison of two approaches. *Journal of Agricultural Economics* **40**: 361–374.
- Hanley**, N. 1992. Leaving Eden – to protect and manage the earth. *Journal of Environmental Management* **33** (4): 311–225.
- Hanley**, N. and Craig, S. 1991. Wilderness development decisions and the Krutilla–Fisher model: the case of Scotland's Flow Country. *Ecological Economics* **4**: 145–164.
- Hanley**, N., Munro, A. and Jamieson, D. 1991. *Environmental economics, sustainable development and nature conservation*. Report to the Nature Conservancy Council, Peterborough.
- Hanley**, N. and Spash, C. 1994. *Cost-Benefit Analysis and the Environment*. Edward Elgar Publishing, Cheltenham.
- Hanley**, N. Spash, C. and Walker, L. 1995. Problems in the valuation of biodiversity. *Environmental and Resource Economics* (in press).
- Hargrove**, C. 1992. Weak anthropocentric intrinsic value. *The Monist* **75**: 183–207.
- Harsanyi**, J.C. 1955. Cardinal welfare, individualistic ethics and interpersonal comparisons of utility. *Journal of Political Economy* **61**: 309–321.
- Hausman**, J.A. (ed.) 1993. *Contingent Valuation: A critical assessment, contributions to economic analysis*. North Holland Publishers, Amsterdam.
- Hecht**, S. 1992. Valuing land use in Amazonia: colonist agriculture, cattle, and petty extraction in comparative perspective. In: Redford, K.H. and Padoch, C. (eds), *Conservation of Neotropical Forests: Working from traditional resource use*. Columbia University Press, New York.
- Henry**, C. 1974. Investment decisions under uncertainty: the irreversibility effect. *American Economic Review* **64**: 1006–1012.
- Hodgson**, G. and Dixon, J.A. 1988. Logging versus fisheries and Tourism in Palawan. *East-West Environmental Policy Institute Occasional Paper No. 7*. East-West Center, Honolulu.
- Hof**, J. and King, D. 1982. On the necessity of simultaneous recreation demand equation estimation. *Land Economics* **58**: 547–552.
- Hohl**, A. and Tisdell, C.A. 1993. How useful are environmental safety standards in economics? – the example of safe minimum standards for the protection of species. *Biodiversity and Conservation* **2**: 168–181.
- Holling**, C.S. 1973. Resilience and stability of ecological systems. *Annual Review of Ecological Systems* **4**: 1–24.
- Holling**, C.S. 1988. Temperate forest insect outbreaks, tropical deforestation and migratory birds. *Memoirs of the Entomological Society of Canada* **146**: 21–32.
- Holling**, C.S. 1992. Cross-scale morphology, geometry and dynamics of ecosystems. *Ecological Monographs* **62**: 47–52.
- Holling**, C.S., Schindler, D.W., Walker, B.H. and Roughgarden, J. 1995. Biodiversity in the functioning of ecosystems: an ecological synthesis. In: Perrings, C., Folke, C. Holling, C.S., Jansson, B.O. and Mäler, K.G. (eds), *Biological Diversity: Economic and ecological issues*. 44–48. Cambridge University Press, Cambridge.
- Hyde**, W.F. and Daniels, S.E. 1988. Balancing market and non-market outputs on public forest lands. In: Smith, V.K. (ed.), *Environmental Resources and Applied Welfare Economics*. Resources for the Future, Washington, DC.
- Infield**, M. 1988. *Hunting, Trapping, and Fishing in Villages within and on the Periphery of the Korup National Park*. World Wide Fund for Nature Publication 3206/A9.6, London.
- Irwin**, J. R., McClelland, G. H. and Schulze, W. D. 1992. Hypothetical and real consequences in experimental auctions for insurance against low-probability risks. *Journal of Behavioural Decision Making* **5**: 107–116.
- Jolly**, A. 1980. *A World like Our Own: Man and Nature in Madagascar*. Yale University Press, New Haven, Conn.
- Kahneman**, D. and Knetsch, J.L. 1992a. Valuing public goods: the purchase of moral satisfaction. *Journal of Environmental Economics and Management* **22**: 57–70.
- Kahneman**, D. and Knetsch, J.L. 1992b. Contingent valuation and the value of public goods: reply. *Journal of Environmental Economics and Management* **22**: 90–94.
- Kahneman**, D. and Tversky, A. 1979. Prospect theory: an analysis of decision under risk. *Econometrica* **47**: 263–291.
- Kaosard**, M., Patmasiriwat, D., DeShazo, J.R. and Panayotou, T. 1994. *Green Finance: A case study of Khao Yai*. Draft Final Report for the Natural Resources and Environment Program,

- Thailand Development Research Institute and Harvard Institute for International Development.
- Karmarkar, U.S.** 1974. The effects of probabilities on the subjective evaluation of lotteries. *MIT Sloan School Working Paper*.
- Karmarkar, U.S.** 1978. Subjectively weighted utility, a descriptive extension of the weighted utility model. *Organisational Behaviour and Human Performance* **21**: 61–72.
- Katzman, M.T.** 1988. Pollution liability insurance and catastrophic environmental risk. *Journal of Risk and Insurance* **55**: 75–100.
- Katzner, D.W.** 1986. Potential surprise, potential confirmation and probability. *Journal of Post Keynesian Economics* **9**: 58–78.
- Katzner, D.W.** 1989a. The Shackle–Vickers approach to decision-making in ignorance. *Journal of Post Keynesian Economics* **12**: 237–259.
- Katzner, D.W.** 1989b. The comparative statics of the Shackle–Vickers approach to decision-making in ignorance. In: Fomby, T.B. and Seo, T.K. (eds), *Studies in the Economics of Uncertainty: in honour of Joseph Hadar*. Springer-Verlag, Berlin.
- Katzner, D.W.** (1995), *Time, Ignorance and Uncertainty in Economic Models*. University of Michigan Press (in press).
- Kellert, S.R.** 1993. Values and perceptions of invertebrates. *Conservation Biology* **7**: 845–855.
- Knetsch, J.L.** 1993. Resource economics: persistent conventions and contrary evidence. In: Adamovics, W.L., White, W. and Phillips, W.E. (eds), *Forestry and the Environment*. CAB International, Oxford.
- Kramer, R.A.** 1993. *Tropical Forest Protection in Madagascar*. Paper prepared for Northeast Universities Development Consortium, Williams College, 15–16 October.
- Kramer, R., Munasinghe, M., Sharma, N., Mercer, E. and Shyamsunder, P.** 1992. *Valuing a Protected Tropical Forest: A case study in Madagascar*. IVth World Congress on National Parks and Protected Areas, Caracas, Venezuela, 14–16 February.
- Kramer, R.A., Sharma, N., Shyamsunder, P. and Munasinghe, M.** 1994. Cost and compensation issues in protecting tropical rainforests: case study of Madagascar. *Environment Department Working Paper*, World Bank (forthcoming 1994)
- Krutilla, J.V.** 1967. Conservation reconsidered. *American Economic Review* **57**: 778–786.
- Krutilla, J.V.** 1991. *Environmental Resource Services of Malaysian Moist Tropical Forests*. Resources for the Future, Washington, DC.
- Krutilla, J.V. and Fisher, A.** 1985. *The Economics of Natural Environments*. Resources for the Future, Washington, DC.
- Lant, C.L.** 1994. The role of property rights in economic research on US wetlands policy. *Ecological Economics* **11**: 27–34.
- Larson, D.** 1992. Further results on willingness to pay for nonmarket goods. *Journal of Environmental Economics and Management* **23**: 101–122.
- Larson, D.M.** 1993. On measuring existence value. *Land Economics* **69**: 377–388.
- Lawrence, E.T.** 1993. The sacred bee, the filthy pig, and the bat out of hell: animal symbolism as cognitive Biophilia. In: Kellert, S.T. and Wilson, E.O. (eds), *The Biophilia Hypothesis*. 301–344. Island Press, Washington, DC. and Shearwater Books, Covelo, Calif.
- Lee, R.B. and DeVore, I.** (eds) 1968. *Man the Hunter*. Aldine, Chicago.
- Lenski, G. and Lenski, J.** 1978. *Human Societies: An introduction to macrosociology*. McGraw-Hill, New York.
- Lindman, H.** 1971. Inconsistent preferences among gambles. *Journal of Experimental Psychology* **89**: 390–397.
- Lohmann, L.** 1991. Who defends biological diversity?: conservation strategies and the case of Thailand. In: Shiva, P., Anderson, H., Schucking, A., Gray, L., Lohmann, D. and Cooper (eds), *Biodiversity: Social and ecological perspectives*. World Rainforest Movement, Penang, Malaysia.
- Loomis, J. and du Vair, P.** 1993. Evaluating the effect of alternative risk communication devices. *Land Economics* **69** (3): 287–298.
- Loomis, J., Loft, E., Updike, D. and Kie, J.** 1991. Cattle–deer interactions in the Sierra Nevada: a bioeconomic approach. *Journal of Range Management* **44**: 23–38.
- Loomis, J., Sorg, C. and Donnelly, D.** 1986. Economic losses to recreational fisheries due to small head hydro development. *Journal of Environmental Management* **22**: 85–94.
- Lugo, A., Parrotta, J.A. and Brown, S.** 1993. Loss in species caused by tropical deforestation and their recovery through management. *Ambio* **22** (2–3): 106–109.
- Lutz, E.** (ed.) 1993. *Towards Improved Accounting for the Environment*. World Bank, Washington, DC.
- McClelland, G.H. and Schulze, W.D.** 1993. Insurance for low-probability hazards: a bimodal response to unlikely events. *Journal of Risk and Uncertainty* **7**: 95–116.
- McCord, M. and Neufville, R. de** 1983. Empirical demonstration that expected utility analysis is not operational. In: Stigum, B. and Wenstøp, F. (eds), *Foundations of Utility and Risk Theory with Applications*. Reidel, Dordrecht.
- McCord, M. and Neufville, R. de** 1984. Utility dependence on probability: an empirical demonstration. *Large Scale Systems* **6** (February): 91–103.
- MacCrimmon, K.R. and Larsson, S.** 1979. Utility theory: axioms versus paradoxes. In: Allais, M. and Hagen, O. (eds), *Expected Utility Hypotheses and the Allais Paradox*. 333–409. Reidel, Dordrecht.
- McDaniels, T., Kamlet, M. and Fischer, G.** 1992. Risk perception and the value of safety. *Risk Analysis* **12** (4): 495–503.
- McFadden, D.** 1973. Conditional logit analysis of qualitative choice behaviour. In: Zarembka, P. (ed.), *Frontiers in Econometrics*. Academic Press, New York.
- McFadden, D.** 1983. Qualitative response models. In: Griliches, Z. and Intriligator, M.D. (eds), *Handbook of Econometrics*. North-Holland, Amsterdam.
- McFadden, D. and Leonard, G.** 1993. Issues in the contingent valuation of environmental goods: methodologies for data collection and analysis. In: Hausman, J. (ed.), *Contingent Valuation: A critical assessment*. North Holland, Amsterdam.
- Machina, M.J.** 1989. Choice under uncertainty: problems solved and unsolved. In: Hey, J.D. (ed.), *Current Issues in Microeconomics*. Current Issues in Economics Series, 1. 12–46. St Martin's Press, New York.

- McNaughton, S.J.** 1985. Ecology of a grazing ecosystem: the Serengeti. *Ecological Monographs* **55**: 259–294.
- McNaughton, S.J.,** Guess, R.W. and Seagle, S.W. 1988. Large mammals and process dynamics in African ecosystems. *BioScience* **38**: 791–800.
- McNeely, J.** 1988. *The Economics of Biological Diversity: Developing and using economic incentives to conserve biological resources*. IUCN, Gland, Switzerland.
- McNeely, J.** 1993. Economic incentives for conserving biodiversity – lessons for Africa. *Ambio* **22** (2–3): 144–150.
- McNeely, J.A.** and Pitt, D. (eds) 1985. *Culture and Conservation*. Croom Helm, Dublin.
- Maddala, G.S.** 1983. *Limited-Dependent and Qualitative Variables in Econometrics*. Cambridge University Press, Cambridge.
- Mäler, K.-G.** 1991. The production function approach. In: Vincent, J.R., Crawford, E.W. and Hoehn, J.P. (eds), *Valuing Environmental Benefits in Developing Countries*. Special Report 29. Michigan State University, East Lansing.
- Malhotra, K.C.** 1990. Village supply and safety forest in Mizoram: a traditional practice of protecting ecosystem. In: *Abstracts of V International Congress of Ecology*. 439.
- Margolis, H.** 1982. *Selfishness, Altruism, and Rationality: A theory of social choice*. Cambridge University Press, Cambridge.
- Martz, H.F.** and Bryson, M.C. 1983. On combining data for estimating the frequency of low-probability events. *Nuclear Science and Engineering* **83**: 267–280.
- Mercer, E.** Kramer, R., and Sharma, N. 1994. Rain forest tourism: estimating the benefits of creating a national park in Madagascar. Submitted to *Forest Science*.
- Miller, J.** 1981. Irreversible land use and the preservation of endangered species. *Journal of Environmental Economics and Management* **8**: 19–26.
- Mitchell, R.C.** and Carson, R.T. 1988. *Using Surveys to Value Public Goods: The contingent valuation method*. Resources for the Future, Washington, DC.
- Moran, D.** 1994. Contingent valuation and biodiversity conservation in Kenyan protected areas. *Biodiversity and Conservation* **3**: (in press).
- Mori, S.A.** 1992. The Brazil nut industry: past, present, and future. In: Plotkin, M.J. and Famolare, L.M. (eds), *Sustainable Harvest and Marketing of Rain Forest Products*. Island Press, Washington, DC.
- Mowen, J.C.** and Gentry, J.W. 1980. Investigation of the preference reversal phenomenon in a new product introduction task. *Journal of Applied Psychology* **65**: 715–722.
- Munasinghe, M.** 1993. Environmental economics and biodiversity management in developing countries. *Ambio* **22**: 126–135.
- Murindagomo, F.** 1988. Preliminary Investigation into Wildlife Utilisation and Land Use in Angwa, Mid-Zambezi Valley, Zimbabwe. MPhil thesis, University of Zimbabwe, Harare.
- Myers, N.** 1992. Population/environment linkages: discontinuities ahead. *Ambio* **21**: 116–118.
- Myrdal, G.** 1975. *Against the Stream*. Vintage Books, New York.
- National Research Council Board on Agriculture.** 1993. *Lessons from the Past: Forests and biodiversity*. IUCN, Gland.
- Nations, J.D.** 1992. Xateros, chicleeros, and pimenteros: harvesting renewable tropical forest resources in the Guatemalan Peten. In: Redford, K.H. and Padoch, C. (eds), *Conservation of Neo-Tropical Forests: Working from traditional resource use*. Columbia University Press, New York.
- Navrud, S.** 1991. Norway. In: Barde, J.-P. and Pearce D.W. (eds), *Valuing the Environment: Six case studies*. Earthscan, London.
- Navrud, S.** (ed.) 1992. *Pricing the European Environment*. Scandinavian University Press/Oxford Press.
- Navrud, S.** 1993. Economic value of biological diversity in Norway. *Scandinavian Forest Economics* **34**: 74–97.
- Nelson, R.** 1993. Searching for the lost arrow: physical and spiritual ecology in the hunter's world. In: Kellert, S.T. and Wilson, E.O. (eds), *The Biophilia Hypothesis*. 201–228. Island Press, Washington, DC.
- Newcombe, K.** and de Lucia, R. 1993. *Mobilising Private Capital Against Global Warming: A business concept and policy issues*. Global Environment Facility, Washington, DC.
- Nordhaus, W.D.** 1991. To slow or not to slow: the economics of the greenhouse effect. *Economic Journal* **101**: 835–840.
- Norgaard, R.B.** 1991. Sustainability as intergenerational equity: the challenge to economic thought and practice. *Asia Regional Series, Internal Discussion Paper IDP 97*. World Bank, Washington, DC.
- Norgaard, R.B.** and Howarth, R.B. 1991. Sustainability and the rate of discount. In: Costanza, R. (ed.), *The Ecological Economics: The science and management of sustainability*. Columbia University Press, New York.
- Norton, B.G.** 1989. Intergenerational equity and environmental decisions: a model using Rawls' Veil of Ignorance. *Ecological Economics* **1** (2): 137–159.
- Norton, B.G.** 1992. Sustainability, human, welfare and ecosystem health. *Environmental Values* **1**: 97–111.
- Norton, B.G.** and Ulanowicz, R.E. 1992. Scale and biodiversity policy: a hierarchical approach. *Ambio* **21**: 244–249.
- Odum, E.P.** 1975. *Ecology*. Holt-Saunders, New York.
- Oldfield, M. L.** 1984. *The Value of Conserving Genetic Resources*. US Department of the Interior. National Park Service, Washington, DC.
- O'Neill, R.V.,** DeAngelis, D.L., Waide, J.B. and Allen, T.F.H. 1986. *A Hierarchical Concept of Ecosystems*. Princeton University Press, Princeton, NJ.
- Orr, D. W.** 1992. Pascal's Wager and economics in a hotter time. *Ecological Economics* **6** (1): 1–6
- Padoch, C.,** and de Jong, W. 1989. Production and profit in agroforestry: an example from the Peruvian Amazon. In: Browder, J.G. (ed.), *Fragile Lands of Latin America: Strategies for sustainable development*. Westview Press, Boulder, Colo.
- Page, T.** 1992. Intergovernmental justice as opportunity. In: Maclean, D. and Brown, P. (eds), *Energy and the Future*. Littlefield.
- Paine, R.T.** 1966. Food web complexity and species diversity. *The American Naturalist* **100**: 65–75.
- Panayotou, T.** 1992. Protecting Tropical Forests. *Development Discussion Paper*. HIID, Cambridge, Mass.
- Panayotou, T.** 1994a. Conservation of biodiversity and economic development. In Perrings, C., Mäler, K.-G., Folke, C., Holling,

- C.S. and Jonsson, B.-O. (eds), *Biodiversity Conservation: Problems and policies*. Kluwer, Dordrecht.
- Panayotou, T.** 1994b. Conservation of biodiversity and economic development: the concept of transferable development rights. *Environmental and Resource Economics* 4: 95–110.
- Panayotou, T.** and Ashton, P. 1992. *Not By Timber Alone: Economics and ecology for sustaining tropical forests*. Island Press, Washington, DC.
- Panayotou, T.** and Parasuk, V. 1990. *Land and Forest: Protecting demand and managing encroachment*. Thailand Development Research Institute, Bangkok.
- Paris, R.** and Ruzicka, I. 1991. Barking up the wrong tree: the role of rent appropriation in sustainable tropical forest management. *ADB Environment Office Occasional Paper No.1*. Asian Development Bank, Manila.
- Pasek, J.** 1993. Philosophical aspects of intergenerational justice. In: Giersch, H. (ed.), *Economic Progress and Environmental Concerns*. Springer-Verlag, Berlin.
- Pauca, A.** and Garnder, A. 1981. *Establishment of a Scientific Research Station in the Yasuni National Park of the Republic of Ecuador*. National Zoo, Washington, DC.
- Pearce, D.W.** 1990. An economic approach to saving the tropical forests. *LEEC Discussion Paper 90–05*. London Environmental Economics Centre, London.
- Pearce, D.W.** 1994a. Commentary. *Environment and Planning A* 26: 1329–1338.
- Pearce, D.W.** 1994b. Global environmental value and the tropical forests: demonstration and capture. Paper prepared for *Forestry and the Environment: Economic Perspectives II*, Banff National Park, Alberta, Canada, October 1994.
- Pearce, D.W., Barbier, E.B.** and Markandya, A. 1988. Environmental economics and decision-making in sub-Saharan Africa. *LEEC Paper 88–01*. London Environmental Economics Centre, London.
- Pearce, D.W., Barbier, E.B.** and Markandya, A. 1990. *Sustainable Development*. Earthscan, London.
- Pearce, D.W., Barbier, E.B., Markandya, A., Barrett, S., Turner, R.K.** and Swanson, T. 1991. *Blueprint 2*. Earthscan, London.
- Pearce, D.W.** and Brown, K. 1994. Saving the world's tropical forests. In: Brown, K. and Pearce, D.W. (eds), *The Causes of Tropical Deforestation*. 2–26 UCL Press, London.
- Pearce, D.W.** and Moran, D. 1994. *The Economic Value of Biological Diversity*. Earthscan, London.
- Pearce, D.W.** and Turner, R.K. 1990. *Economics of Natural Resources and the Environment*. Harvester Wheatsheaf, Hemel Hempstead, UK.
- Pearce, D.W.** and Warford, J. 1993. *World Without End*. Oxford University Press, Oxford.
- Perrings C.** 1989a. Environmental bonds and environmental research in innovative activities. *Ecological Economics* 1: 95–110.
- Perrings, C.** 1989b. An optimal path to extinction? Poverty and resource degradation in the open agrarian economy. *Journal of Development Economics* 30: 1–24.
- Perrings, C.** 1991. Questioning the market solution: income effects, poverty, and the management of environmental resources in low income countries. In: Blasi, P. and Zamagni, S. (eds), *Man, Environment and Development: Towards a global approach*. 210–226. Nova Spes International Foundation Press, Rome.
- Perrings C.** and Opschoor J.B. 1994. The loss of biological diversity: some policy implications. *Environmental and Resource Economics* 4: 1–12.
- Perrings, C., Folke, C.** and Mäler, K.-G. 1993. The ecology and economics of biodiversity loss: the research agenda. *Ambio* 22: 201–211.
- Peters, C., Gentry, A.** and Mendelsohn, R. 1989. Valuation of an Amazonian Rainforest. *Nature* 339: 655–656.
- Pimm, S.L.** 1984. The complexity and stability of ecosystems. *Nature* 307: 321–326.
- Pinedo-Vasques, M.,** and Jip, D.Z. 1992. Economic returns from forest conversion in the Peruvian Amazon. *Ecological Economics* 6.
- Pommerehne, W.W., Schneider, F.** and Zweifel, P. 1982. Economic theory of choice and the preference reversal phenomenon: a re-examination. *American Economic Review* 72 (June): 569–574.
- Portney, P.R.** 1994. The contingent valuation debate: why economists should care. *Journal of Economic Perspectives* 8: 3–18.
- Przewozny, B.** 1991. Ethics and the environment. In: Blasi, P. and Zamagni, S. (eds), *Man-Environment and Development: Towards a global approach*. 47–58. Nova Spes International Foundation Press, Rome.
- Randall, A.** 1994. The Travel Cost Method. *Land Economics* 70 (1): 88–96.
- Randall, A.** 1991. Total and nonuse values. In: Braden, J.B. and Kolstad, C.D. (eds), *Measuring The Demand for Environmental Quality*. 303–322. North Holland, Amsterdam.
- Randall, A.** and Stoll, J. 1983. Existence values in a total valuation framework. In: Row, R.D. and Chestnut, L.G. (eds), *Managing Air Quality and Scenic Resources at National Parks and Wilderness Areas*. Westview Press, Boulder, Colo.
- Randers, J.** and Meadows, D. 1973. The carrying capacity of our global environment: a look at the ethical alternatives. In: Daly, H.E. (ed.), *Toward a Steady State Economy*. W.H. Freeman, San Francisco.
- Rawls, J.** 1972. *A Theory of Justice*. Oxford University Press, Oxford.
- Regan, D.H.** 1986. Duties of preservation. In: Norton, B.G. (ed.), *The Preservation of Species*. 195–225. Princeton University Press, Princeton, NJ.
- Reid, W.** 1992. How many species will there be? In: Wilson, E. (ed.), *Biodiversity: Papers from a National Forum*. National Academy Press, Washington, DC.
- Reid, W.V., Laird, S.A., Meyer, C.A., Gamez, R., Sittenfeld, A., Janzen, D., Gollin, M.** and Juma, C. 1993. *Biodiversity Prospecting: Using genetic resources for sustainable development*. World Resources Institute, Washington, DC.
- Reilly, R.J.** 1982. Preference reversal: further evidence and some suggested modifications of experimental design. *American Economic Review* 72 (June): 576–584.
- Reed, D.** (ed.) 1992. *Structural Adjustment and the Environment*. Westview Press, Boulder, Colo.
- Repetto, R.** 1988. *The Forest for the Trees: Government policies and the misuse of forest resources*. World Resources Institute, Washington, DC.

- Repetto, R.** 1989. Economic incentives for sustainable production. In: Schramme, G. and Warford, J.J. (eds), *Environmental Management and Economic Development*. 69–86. Johns Hopkins for the World Bank, Baltimore.
- Repetto, R.** 1993. *Trade and Environment Policies: Achieving complementarities and avoiding conflicts*. World Resources Institute, Washington, DC.
- Repetto, R.** and Gillis, M. (eds) 1988. *Public Policies and the Misuse of Forest Resources*. Cambridge University Press, Cambridge.
- Repetto, R.,** Magrath, W., Wells, M., Beer, C. and Rossini, F. 1989. *Wasting Assets: Natural resources in the national income accounts*. World Resources Institute, Washington, DC.
- Rowthorn, B.** and Brown, G. 1994. Biodiversity, economic growth and the discount rate. *Discussion Series 94–02*. Department of Economics, University of Washington, Seattle.
- Rubin, J.,** Helfand, G. and Loomis, J. 1991. A benefit–cost analysis of the northern spotted owl. *Journal of Forestry* **89**.
- Ruitenbeek, H.J.** 1988. *Social Cost-Benefit Analysis of the Korup Project, Cameroon*. World Wide Fund for Nature Publication 3206/A14.1, London.
- Ruitenbeek, H.J.** 1989. *Economic Analysis of Issues and Projects Relating to the Establishment of the Proposed Cross River National Park (Oban Division) and Support Zone*. World Wide Fund for Nature, London.
- Ruitenbeek, H.J.** 1992. *Mangrove Management: An Economic Analysis of Management Options with a Focus on Bintuni Bay, Irian Jaya*. Environmental Management Development in Indonesia Project. Environmental Reports, No. 8.
- Sagoff, M.** 1988. *The Economy of the Earth*. Cambridge University Press, Cambridge.
- Samples, K.C.,** Dixon, J.A. and Gowen, M.M. 1986. Information disclosure and endangered species valuation. *Land Economics* **62**: 306–312.
- Sankhala, K.S.** and Jackson, P. 1985. People, trees and antelopes in the Indian desert. In: McNeely, J.A. and Pitt, D. (eds), *Culture and Conservation: The human dimension in environmental planning*. 205–210. Croom Helm, Dublin.
- Savage, L.J.** 1954. *Foundations of Statistics*. John Wiley, New York.
- Schindler, D.W.** 1977. Evolution of phosphorus limitation in lakes: natural mechanisms compensate for deficiencies of nitrogen and carbon in eutrophied lakes. *Science* **195**: 260–262.
- Schindler, D.W.** 1988. Experimental studies of chemical stressors on whole lake ecosystems. Baldi Lecture. *Verh. Internat. Verein. Limnol.* **23**: 11–41.
- Schindler, D.W.** 1990a. Experimental perturbations of whole lakes as tests of hypotheses concerning ecosystem structure and function. *Proceedings of 1987 Crafoord Symposium. Oikos* **57**: 25–41.
- Schindler, D.W.** 1990b. Natural and anthropogenically imposed limitations to biotic richness in freshwaters. In: Woodwell, G. (ed.), *The Earth in Transition: Patterns and Processes of Biotic Impoverishment*. 425–462. Cambridge University Press, Cambridge.
- Schulze, W.,** McClelland, G., Waldman, D. and Lazo, J. 1994. Information, context, and bias in contingent valuation. Working paper. Washington State University.
- Schwartzman, S.** 1989. Extractive reserves in the Amazon. In: Browder, J.G. (ed.), *Fragile Lands of Latin America: Strategies for Sustainable Development*. Westview Press, Boulder, Colo.
- Sedjo, R.A.** 1992. Preserving biodiversity as a resource. *Resources* **106**: 26–29.
- Sellar, C.,** Stoll, J. and Chevas, J.P. 1985. Validation of empirical measures of welfare change. *Land Economics* **61** (2): 156–175.
- Sen, A.K.** 1981. *Poverty and Famines: An essay on entitlement and deprivation*. Oxford University Press, Oxford.
- Sen, A.K.** 1977. Rational fools: a critique of the behaviour foundations of economic theory. *Philosophy and Public Affairs* **16**: 317–344.
- Shabman, L.** and Bertelson, M.K. 1979. The use of development value estimates for coastal wetland permit decisions. *Land Economics* **55** (2): 213–222.
- Shackle, G.L.S.** 1955. *Uncertainty in Economics*. Cambridge University Press, Cambridge.
- Shackle, G.L.S.** 1969. *Decision, Order and Time in Human Affairs*. Cambridge University Press, Cambridge.
- Silva, J.** 1987. Responses of savannas to stress and disturbance: species dynamics. In: Walker, B.H. (ed.) *Determinants of Tropical Savannas*. 141–156. IRL Press, Oxford.
- Simon, H.A.** 1957. *Administrative Behaviour*, 2nd edn. MacMillan, New York.
- Slovic, P.** and Lichtenstein, S. 1971. Comparison of Bayesian and regression approaches to the study of information processing in judgement. *Organisational Behaviour and Human Performance* **6** (November): 649–744.
- Smith, V.K.** 1991. Household production functions and environmental benefit estimation. In: Braden, J.B. and Kolstad, C.D. (eds), *Measuring The Demand for Environmental Quality*. 41–76. North Holland, Amsterdam.
- Smith, V.K.** 1993. Non market valuation of environmental resources: an interpretative appraisal. *Land Economics* **69**: 1–26.
- Smith, V.K.** and Desvousges, W. 1986. *Measuring Water Quality Benefits*. Kluwer Nijhoff, Boston.
- Smith, V.K.** and Kaoru, Y. 1987. The hedonic travel cost model: A view from the trenches. *Land Economics* **63** (2): 179–192.
- Smith, V.K.** and Kaoru, Y. 1990. Signals or noise? Explaining the variation in recreation benefit estimates. *American Journal of Agricultural Economics* (May): 419–433.
- Smith, V.K.,** Desvousges, W. and McGivney, M. 1983. Estimating water quality benefits: an econometric analysis. *Southern Economic Journal* **50**: 422–437.
- Soedal, D.P.** 1989. The recreational value of moose hunting in Norway: towards modelling optimal population density. *Scandinavian Forest Economics* **30**: 62–78.
- Solórzano, R.,** de Camino, R., Woodward, R., Tosi, J., Watson, V., Vásquez, A., Villalobos, C., Jiménez, J., Repetto, R. and Cruz, W. 1991. *Accounts Overdue: Natural resource depreciation in Costa Rica*. World Resources Institute, Washington, DC.
- Southgate, D.** 1991. Tropical deforestation and agricultural development in Latin America. *LEEC Discussion Paper 91–01*. London Environmental Economics Centre, London.
- Southgate, D.** and Clark, H.L. 1993. Can conservation projects save biodiversity in South America? *Ambio* **22** (2–3): 163–166.

- Spash, C.** and Hanley, N. 1995. Preferences, information and biodiversity preservation. *Ecological Economics* **12**: 191–208.
- Steele, J.H.** 1985. A comparison of terrestrial and marine systems. *Nature* **313**: 355–358.
- Steele, J.H.** 1989. A view from the oceans. *Oceanus* **32**: 4–9.
- Sterling D.C.** 1984. Environmental impairment liability: an insurance perspective. In: Long, J.D. and Randall, E.D. (eds), *Issues in Insurance, American Institute for Property and Liability Underwriters*, Vol. 2. Malvern, Pa.
- Stevens, T.H., Echeverria, J., Glass, R.J., Hager, T. and More, A.M.** 1991. Measuring the existence value of wildlife: what do CVM estimates really show? *Land Economics* **674**: 390–400.
- Stoll, J.R. and Johnson, L.A.** 1984. Concepts of value, nonmarket valuation and the case of the whooping crane. *Transactions of the Forty-Ninth North American Wildlife and Natural Resources Conference* **49**: 382–393.
- Strand, J.** 1981. Valuation of freshwater fish populations as a public good in Norway. *Working Paper*. Department of Economics, University of Oslo.
- Sugden, R.** 1984. Reciprocity: the supply of public goods through voluntary contributions. *Economic Journal* **94**: 772–787.
- Sukamar, R.** 1989. *The Asian Elephant: Ecology and management*. Cambridge University Press, Cambridge.
- Swanson, T.** 1992. Economics of a biodiversity convention. *Ambio* **21** (3): 250–257.
- Swanson, T. and Barbier, E.B.** 1992. *Economics for the Wilds: Wildlife, wildlands, diversity and development*. Earthscan, London.
- Taylor P.** 1991. The Precautionary Principle and the Prevention of Pollution. *ECOS* **124**: 41–46.
- Terborgh, J.** 1992. *Diversity and the Tropical Rain Forest*. Scientific American Library, New York.
- Thorbjarnarson, J.H.** 1991. An analysis of the spectacled caiman (*Caiman crocodilus*) harvest program in Venezuela. In: Redford, K.H. and Robinson, J.G. (eds), *Neotropical Wildlife Use and Conservation*. University of Chicago Press, Chicago.
- Tobias, D. and Mendelsohn, R.** 1991. Valuing ecotourism in a tropical rainforest reserve. *Ambio* **20** (2): 91–93.
- Toledo, V.M., Batis, A.I., Becerra, R., Martinez, E. and Ramos, C.H.** 1992. Products from the tropical rainforests of Mexico: An ethnoecological approach. In: Plotkin, M. and Famolare, L. (eds), *Sustainable Harvest and Marketing of Rainforest Products*. 99–109. Conservation International, Washington DC.
- Tongpan, S. and Panayotou, T.** 1990. Natural resources for a sustainable future: spreading the benefits, deforestation and poverty: can commercial and social forestry break the vicious circle? *Research Report No.2*. TDR Year End Conference, 8–9, December 1990, Ambassador City Jomtien, Chon Buri.
- Trice, A.H. and Wood, S.E.** 1958. Measurement of recreation benefits. *Land Economics* **24**: 195–207.
- Trivers, R.L.** 1971. Evolution of reciprocal altruism. *Quarterly Review of Biology* **46**: 35–57.
- Turner, R.K.** 1988a. Wetland conservation: economics and ethics. In: Collard, D. et al. (eds), *Economics, Growth and Sustainable Environments*. MacMillan, London.
- Turner, R.K.** (ed.) 1988b. *Sustainable Environmental Management: Principles and practice*. Belhaven Press, London.
- Turner, R.K.** (ed.) 1993. *Sustainable Environmental Economics and Management*. Belhaven Press, London.
- Turner, R.K. and Pearce, D.W.** 1993. Sustainable economic development: economic and ethical principles. In: Barbier, E.B. (ed.), *Economics and Ecology*. Chapman and Hall, London.
- Turner, R.K., Pearce, D.W. and Bateman, I.** 1994. *Environmental Economics: An elementary introduction*. Harvester, New York.
- United Nations Development Programme.** 1990. *Human Development Report 1990*. Oxford University Press, Oxford.
- Vane-Wright, R.I., Humphries, C.J. and Williams, P.H.** 1991. What to Protect? Systematics and the agony of choice. *Biological Conservation* **55**: 235–254.
- Vaughn, W. and Russell, C.** 1982. The value of a fishing day: an application of the varying parameter model. *Land Economics* **58** (4): 450–463.
- Vickers, D.** 1978. *Financial Markets in the Capitalist Process*. University of Pennsylvania Press, Philadelphia.
- Vickers, D.** 1994. *Economics and the Antagonism of Time*. University of Michigan Press, Ann Arbor.
- Vincent, J.R.** 1991. tropical timber trade, industrialization and policies. Paper for 1991 USAID/ASIA Environment and Agriculture Officers Conference, held in Colombo, Sri Lanka, 9–13, September 1991.
- Vincent, J.R. and Hadi, Y.** 1991. Deforestation and agricultural expansion in peninsular Malaysia. Development Discussion Paper No. 396, Harvard Institute for International Development, Cambridge, Mass.
- Vitousek, P.M.** 1990. Biological invasions and ecosystem processes: towards an integration of population biology and ecosystem studies. *Oikos* **57**: 7–13.
- Walker, B.H.** 1988. Autecology, synecology, climate and livestock as agents of rangelands dynamics. *Australian Range Journal* **10**: 69–75.
- Walker, B.H., Ludwig, D., Holling, C.S. and Peterman, R.M.** 1969. Stability of semi-arid savanna grazing systems. *Ecology* **69**: 473–498.
- Walsh, R., Loomis, J. and Gillman, R.** 1984. Valuing option, existence and bequest demands for wilderness. *Land Economics* **60**: 14–29.
- Warford, J.** 1987. *Environment and Development*. World Bank/IMF Development Committee, Washington, DC.
- Weir, J.** 1992. The sweetwater rattlesnake round-up: a case study in environmental ethics. *Conservation Biology* **6**: 116–127.
- Weisbrod, B.** 1964. Collective consumption services of individual consumption goods. *Quarterly Journal of Economics* **77**: 71–77.
- Weissinger, A.K.** 1990. Technologies for germ plasm conservation ex situ. In: Orians, G.H., Brown, G.M., Kunin, W.E. and Swierbinski, J.E. (eds), *The Preservation and Valuation of Biological Resources*. 3–31. University of Washington Press, Seattle.
- Weitzman, M.** 1994. On the 'environmental discount rate'. *Journal of Environmental Economics and Management* **6** (2).
- Weitzman, M.L.** 1995. Diversity functions. In: Perrings, C., Folke, C., Holling, C.S., Jansson, B.O. and Möler, K.G. (eds), *Biological Diversity: Economic and ecological issues*. 21–43. Cambridge University Press, Cambridge.
- Wells, M.** 1992. Biodiversity conservation, affluence and poverty

- mismatched costs and benefits and efforts to remedy them. *Ambio* **21**(3): 237–243.
- Wells, M.P. and Brandon, K.E.** 1992. *People and Parks: Linking protected area management with local communities*. The World Bank, Washington, DC.
- Wells, M.P. and Brandon, K.E.** 1993. The principles and practices of buffer zones and local participation in biodiversity conservation. *Ambio* **22** (2–3): 157–172.
- Western, D.** 1989. The ecological value of elephants: a keystone role in African Ecosystems. In: *The ITRG Report, The Ivory Trade and the Future of the African Elephant*. Prepared for the Second Meeting of the CITES African Elephant Working Group, Gabarone, Botswana, July.
- White, L.** 1967. The historical roots of our ecological crisis. *Science* **155**: 1203.
- Whitehead, J.C.** 1993. Total economic values for coastal and marine wildlife: specification, validity, and valuation issues. *Marine Resource Economics* **8**: 119–132.
- Whitmore, T.C.** 1990. *An Introduction to Tropical Rain Forest*. Clarendon, Canada.
- Wilkie, D.S.** 1989. Impact of roadside agriculture on subsistence in the Ituri Forest of Northeastern Zaire. *American Journal of Physical Anthropology* **78**.
- Wilkie, D.S. and Curran, B.** 1991. Why do Mbuti hunters use nets? ungulate hunting efficiency of archers and net hunters in the Ituri Rain Forest. *American Anthropology* **93**.
- Willis, K.** 1991. The recreational value of the forestry commission estate in Great Britain: a Clawson–Knetsch travel cost analysis. *Scottish Journal of Political Economy* **38**: 58–75.
- Wilson, E.O.** 1978. *On Human Nature*. Harvard University Press, Cambridge, Mass.
- Wilson, E.O.** 1984. *Biophilia: The human bond with other species*. Harvard University Press, Cambridge, Mass.
- Wilson, E.O.** 1988. *Biodiversity*. National Academy Press, Washington, DC.
- Wilson, E.O.** 1993. Biophilia and the conservation ethic. In: Kellert, S.T. and Wilson, E.O. (eds), *The Biophilia Hypothesis*. Island Press, Washington, DC. and Shearwater Books, Covelo, Calif.
- Woodruff, D.S. and Gall, G.A.E.** 1992. Genetics and conservation. *Agriculture, Ecosystems and Environment* **42**: 53–73.
- World Bank.** 1991. *The Forest Sector: A World Bank Policy Paper*. World Bank, Washington, DC.
- World Bank.** 1994. *Costa Rica Forest Sector Report*. World Bank, Washington, DC.
- World Commission on Environment and Development,** 1987. *Our Common Future*. Oxford University Press, Oxford.
- World Conservation Monitoring Centre,** 1992. *Global Biodiversity: Status of the Earth's Living Resources*. Chapman and Hall, London.
- WRI/IUCN/UNEP.** 1992. *Global Biodiversity Strategy*. World Resources Institute, Washington, DC.
- Young, M.D.** 1992. *Sustainable Investment and Resources*. Parthenon Publishing, Carnforth, UK and UNESCO, Paris.
- Young, M.D.** 1993. Some practical implications of inter-generational equity, the precautionary principle, maintenance of natural capital and the discount rate. *CSIRO Working Document 93/5*, Canberra.

Measures for Conservation of Biodiversity and Sustainable Use of its Components

K. MILLER, M.H. ALLEGRETTI, N. JOHNSON AND B. JONSSON

Lead Authors:

K. Miller, N. Johnson (Chapter 13.1); N. Johnson (Chapter 13.2); N. Johnson, B. Jonsson (Chapter 13.3); R. Hobbs, E. Lleras (Chapter 13.4); M. Wells (Chapter 13.5); C. de Klemm (Chapter 13.6); K. Miller (Chapter 13.7)

Contributors:

M. Allegretti, M. Altieri, C.V. Barber, F. Berkes, R.J.H. Beverton, A. Bjordal, T. Boyle, S. Bragdon, J. Caldecott, R.A. Caulfield, H. Ceballos-Lascurain, A.L. Decicco, S.R. Edwards, D. Farrier, A.H. Ghosh, A.N. Gillison, E. Gómez, L.P. Hansen, V.H. Heywood, K. Hindar, M. Iwanaga, D. Janzen, K. Kangwana, A. Kothari, R. Langvatn, S.M. Lanou, K. MacKinnon, P. Maitland, A. Mariante, J. Paine, G. Power, R.B. Primack, F.E. Putz, W.V. Reid, C. Shine, S. Singh, S. Stuart, T. Whitten, H.G. Wilkes

CONTENTS

Executive Summary	919		
13.0 Introduction	923		
13.1 A framework for managing biodiversity	923		
13.1.1 Introduction	923		
13.1.2 Context for biodiversity management	925		
13.1.3 Methods and tools for biodiversity management	925		
13.1.4 Approaches for managing biodiversity in a complex world	927		
13.1.4.1 Strategic planning	927		
13.1.4.2 Bioregional and ecosystem management programmes	929		
13.1.4.3 Adaptive management	931		
13.1.5 Conclusion	931		
References	931		
13.2 Defining priorities for conservation and sustainable use	932		
13.2.1 Introduction	932		
13.2.2 Genetically based methods for establishing priorities	933		
13.2.3 Species-based methods for establishing priorities	934		
13.2.4 Ecosystem-based methods for establishing priorities	936		
13.2.5 Integrative approaches for establishing priorities	937		
13.2.6 Experience in setting geographically-based priorities	938		
13.2.7 Principles for geographic priority setting	939		
13.2.8 Conclusion	940		
References	941		
13.3 Measures for sustainable use of biodiversity in natural resource management	943		
13.3.1 Introduction	943		
13.3.2 Managing biodiversity in agriculture	943		
13.3.2.1 Managing biodiversity in traditional agriculture	944		
13.3.2.2 Managing biodiversity in modern agriculture	948		
13.3.2.3 Managing agriculture impacts on natural resources	950		
13.3.3 Managing biodiversity in forestry	952		
13.3.3.1 Managing biodiversity in traditional forestry	952		
13.3.3.2 Managing biodiversity in commercial forestry	954		
13.3.3.2.1 Measures for the sustainable use and management of forest genetic resources	954		
13.3.3.2.2 Minimizing the impacts of forestry operations on biodiversity	956		
13.3.3.2.3 Biodiversity inventory and monitoring	958		
13.3.4 Managing biodiversity in fisheries	960		
13.3.4.1 Managing biodiversity in traditional fisheries	960		
13.3.4.2 Managing biodiversity in small-scale fisheries	962		
13.3.4.3 Managing biodiversity in large-scale fisheries	963		
13.3.4.4 Newly evolving practices in large-scale fisheries	964		
13.3.4.5 Managing biodiversity in aquaculture	965		
13.3.5 Managing wild flora and fauna	966		
13.3.5.1 Wildlife management	966		
13.3.5.2 International commerce in wild species	967		
13.3.5.3 Incentives for managing wild populations sustainably	968		
13.3.6 Biodiversity prospecting	969		
13.3.7 Managing impacts of tourism on biodiversity	970		
13.3.8 Managing impacts of urbanization and infrastructure on biodiversity	971		
13.3.8.1 Conserving biodiversity in urban areas	971		
13.3.8.1.1 Habitat types	971		
13.3.8.1.2 Species diversity in urban habitats	972		
13.3.8.1.3 Actions to conserve urban biodiversity	972		
13.3.8.2 Managing the impacts of infrastructure on biodiversity	973		
13.3.9 Conclusion	973		
References	974		
13.4 Protecting and restoring ecosystems, species, populations and genetic diversity	981		
13.4.1 Introduction	981		
13.4.2 Protecting ecosystems	982		
13.4.2.1 Protected areas	982		
13.4.2.1.1 Protected area classification, size, and distribution	982		
13.4.2.1.2 Managing biodiversity in protected areas	986		

13.4.2.1.3	Defining management objectives	987	13.6 Legal measures for sustainable use and protection of biodiversity	1036	
13.4.2.1.4	Effectiveness of protected areas for maintaining biodiversity	990	13.6.1	Introduction	1036
13.4.2.2	Managing corridors and natural habitat fragments	990	13.6.2	Customary and traditional legal measures	1037
13.4.2.2.1	Response of ecosystems to fragmentation	990	13.6.2.1	The nature of customary law	1037
13.4.2.2.2	Corridors in fragmented landscapes	992	13.6.2.2	Examples of customary law and biodiversity	1038
13.4.2.2.3	Protection and management of fragments	993	13.6.2.3	Customary law in transition	1039
13.4.2.3	Maintaining ecosystem functions and processes	993	13.6.3	National legislation	1039
13.4.3	Protecting species, populations and genetic resources	994	13.6.3.1	Regulatory measures	1039
13.4.3.1	Threatened and endangered species classifications and species management and recovery plans	995	13.6.3.1.1	Species-orientated legal measures	1039
13.4.3.1.1	Threatened and endangered species classifications	995	13.6.3.1.2	Regulating use of protected areas	1040
13.4.3.1.2	Management plans	995	13.6.3.1.3	Other area-based legal conservation actions	1041
13.4.3.1.3	Recovery plans	997	13.6.3.1.4	Land-use planning legislation	1041
13.4.3.1.4	IUCN Species Survival Commission Action Plans	997	13.6.3.1.5	Nature parks and protected landscapes	1041
13.4.3.2	<i>In situ</i> conservation of species, populations and genetic resources	998	13.6.3.1.6	Legal protection of representative habitat types	1042
13.4.3.3	<i>Ex situ</i> strategies	1000	13.6.3.1.7	Regulating processes and activities detrimental to biodiversity	1042
13.4.3.3.1	Botanical gardens	1000	13.6.3.1.8	Regulating access to genetic resources	1043
13.4.3.3.2	Zoos and aquaria	1001	13.6.3.2	Non-regulatory methods	1044
13.4.3.3.3	Gene banks	1002	13.6.3.2.1	Financial incentives	1044
13.4.3.3.4	<i>Ex situ</i> technologies	1003	13.6.3.2.2	Covenants	1044
13.4.4	Restoration and rehabilitation of species, populations and ecosystems	1004	13.6.3.2.3	Easements	1045
13.4.4.1	Restoration of species and populations	1004	13.6.3.2.4	Management agreements	1045
13.4.4.2	Ecosystem and landscape restoration	1007	13.6.3.3	Combining regulatory and voluntary measures	1045
13.4.5	Conclusion	1008	13.6.3.4	Environmental impact assessment and other legal institutions and procedures for conserving biodiversity	1046
References		1010	13.6.4	International law	1047
13.5 Social-economic strategies to sustainably use, conserve, and share the benefits of biodiversity		1016	13.6.4.1	Regional and sectoral treaties	1047
13.5.1	Introduction	1016	13.6.4.2	The Convention on Biological Diversity	1048
13.5.2	Social interventions at local and community levels	1017	13.6.4.3	Implementation and compliance	1050
13.5.2.1	Indigenous knowledge	1017	13.6.4.4	Interaction between national and international legislation	1051
13.5.2.2	Local participation	1018	13.6.5	Conclusion	1051
13.5.2.3	Methods of participatory inquiry	1020	References		1051
13.5.2.4	Community forest management	1022	13.7 Building capacity for biodiversity management		1052
13.5.2.5	Local people and protected areas	1024	13.7.1	Introduction	1052
13.5.3	Economic tools and incentives	1026	13.7.2	Human capacity	1052
13.5.3.1	Local economic incentives	1026	13.7.3	Institutional capacity	1053
13.5.3.2	Conserving and using non-timber forest products	1028	13.7.4	Infrastructure capacity	1057
13.5.3.3	Ecotourism	1028	13.7.5	Funding capacity	1057
13.5.3.4	Private reserves and private land leasing	1031	13.7.6	Conclusion	1060
13.5.4	Conclusion	1033	References		1060
References		1033	Acknowledgements		1061

EXECUTIVE SUMMARY

A growing number of countries are now party to the 1992 Convention on Biological Diversity and are taking steps to implement various articles of the treaty. An up-to-date assessment of a wide range of technical, social, economic and legal approaches available to achieve conservation and sustainable use, therefore, provides a timely contribution to conservation planning efforts around the world. Section 13 addresses specific methods available for the conservation, restoration and sustainable use of biodiversity and its components at the ecosystem, species and genetic levels. It also indicates new directions for improving the efficacy of current methods and strategies. Within the scope of this Section are approaches to help:

- plan and co-ordinate conservation efforts;
- sustainably use biodiversity within management systems such as forestry, fisheries and agriculture;
- protect and restore ecosystem, species and genetic diversity using a variety of in situ and ex situ methods;
- equitably share the benefits of biodiversity through social and economic instruments;
- provide a legal basis for conservation and sustainable use activities; and
- build human and institutional capacity to integrate measures at bioregional scales.

(13.1) The first chapter of this Section addresses the usefulness of developing a conceptual framework within which to organize the wide range of responses needed to conserve biodiversity and use it sustainably. In most places, biodiversity conservation has suffered from piecemeal and uncoordinated actions. The Convention on Biological Diversity calls for the development of intersectoral national biodiversity strategies and action plans (Article 6), and provides an opportunity to develop comprehensive and co-ordinated strategies for the conservation and sustainable use of biodiversity.

A conceptual framework should recognize that a range of public and private actors have roles and responsibilities to conserve living resources and use them sustainably, and that many different types of actions will be necessary to successfully maintain biodiversity. Such a framework can help integrate different methods and sectors involving

components as varied as: seed banks; protected areas; technical measures in forestry, agriculture and aquaculture; botanical gardens; on-farm conservation areas; legislation; and a variety of social, economic and political factors. Because of the complexity and uncertainty associated with the management of biodiversity, the use of strategic planning, adaptive management techniques, and bioregional and ecosystem management approaches should frame the choice of tools and techniques.

(13.2) Deciding which species and habitats have precedence in the allocation of limited financial, human and institutional resources is one of the most difficult aspects of conservation planning in the 1990s. Many methods of setting geographic priorities for a wide range of conservation objectives have been developed over the last decade. These include widely publicized schemes to identify global priorities on the basis of species richness and endemism at the country level (e.g. megadiversity countries), the regional level (biodiversity 'hotspots'), and the site level (e.g. endemic bird areas).

While these approaches provide limited guidance to international funders, setting priorities for the conservation and sustainable use of biodiversity at national and local levels will have more impact. Relatively few countries, however, have established clearly defined priorities that are actively used to guide biodiversity management activities or to direct government and donor resources. Where such priority-setting has occurred, the efforts have often been isolated from the policy process. They have lacked participation from key constituencies and have ignored social, economic, institutional and other factors that play a major role in conservation decisions. New approaches are emerging that are more participatory, integrate a wider range of biological and non-biological factors relevant to conservation threats and opportunities, and are more closely linked to clear conservation objectives and planning processes. While the effectiveness of these methods is not yet certain, growing genetic, species and habitat loss will leave fewer conservation options in coming decades. Thus, priorities set during the next decade are likely to influence conservation and sustainable use activities for decades to come.

(13.3) The next part of the Section assesses methods available to conserve biodiversity and use it sustainably in the context of natural resource management involving

agriculture, fisheries, forestry, tourism and biodiversity prospecting, among other activities. Some components of biodiversity owe their existence to human influence and manipulation; yet human use of resources has often led to simplification of ecological systems and reduction in biodiversity. Our ability to maintain biodiversity, therefore, is dependent upon finding methods to manage and use biodiversity sustainably in systems where the production of goods and services for human consumption is the principal objective.

Areas that practise traditional forms of agriculture, particularly in developing countries, are the largest repositories of crop and livestock genetic diversity. Much of the genetic diversity associated with traditional systems, however, is disappearing as large-scale, modern agricultural systems become more prevalent. Modern agriculture has offered tremendous gains in productivity through technological innovation and the widespread adoption of uniform, high-yielding varieties. Future gains in productivity will depend on improved management of genetic resources in time (e.g. gene banks) and space (e.g. crop-variety mosaics).

Genetic vulnerability for many of the world's most important food crops and animals appears to be growing. This is apparent even though we have an incomplete understanding of the magnitude of potential future losses in crop productivity caused by the narrowing of the genetic base for breeding. To meet the demands of a growing world population and simultaneously maintain biodiversity requires measures that:

1. conserve genetic diversity in existing domesticated plant and animal varieties;
2. identify and conserve wild species that, along with their genetic diversity and habitats, can improve agricultural productivity and adaptability in the face of environmental change; and
3. minimize the adverse impacts of agricultural practices on other ecosystems.

Traditional approaches to forest and fisheries management have also – intentionally or unintentionally – contributed to the maintenance of biodiversity. As in agriculture, however, traditional practices are disappearing rapidly. The intensification of forestry and fisheries management has led to dramatic increases in yield. This, in its turn, has caused significant interventions in natural disturbance regimes and species composition, and consequent reductions in biodiversity for many forestry and fisheries production areas. Forestry practices that mimic natural disturbance regimes such as fire, wind blow-downs, and pathogen outbreaks appear to offer the best

opportunities for maintaining biodiversity associated with forest ecosystems.

In fisheries, better monitoring of fish stocks and more selective fish capture methods have been shown to offer considerable hope for increasing the sustainability of harvest and the conservation of marine biodiversity. Social and economic measures, however, may be much more important than technical measures for ensuring sustainable use. For example, the assignment or recognition of clearly defined property rights and tenure systems is vital to sustainable use behaviour in forestry and fisheries (see also 13.5).

(13.4) Even as methods are being developed to use biodiversity sustainably, approaches are also being explored to protect ecosystems, species and genetic diversity – either in place (*in situ* methods can be used at all biological levels) or in specially designed facilities away from natural habitats (*ex situ* methods can be used for species and genetic diversity). These approaches are, in essence, the means by which we can protect biodiversity against the failure of the sustainable use measures described above (13.3).

The most effective way to conserve biodiversity, by almost any reckoning, is to prevent the conversion or degradation of habitat. The world's 10 000 protected areas have figured prominently in biodiversity conservation efforts. Reasonably accurate data on the number and size of protected areas are available for most countries, and gaps in the representation of major ecosystem types by country and biome are generally well understood. More specific information, however, on the effectiveness of protected areas in conserving elements of biodiversity is generally not available. For example, information on the biodiversity that is resident within protected areas, especially at the genetic level, even for plants and vertebrates, is inadequate for the vast majority of protected areas.

Protected areas, particularly in developing countries, have often yielded few economic benefits and instead have imposed substantial costs on local people. This has led to severe conflicts between conservation and economic development goals. The potential of many innovative protected area projects designed to integrate conservation and development objectives has been hampered by a number of factors. Among them are limited investment, inadequate use of the latest ecological and social science techniques, minimal attention to monitoring, and neglect of larger economic and sectoral policies. Recent assessments suggest that:

- local people must be involved in all phases of project design, implementation and evaluation;
- project objectives must be clearly defined;
- a wide array of human and organizational resources is needed across sectoral and disciplinary boundaries;
- baseline ecological, biodiversity, social and economic conditions must be characterized,

monitored and evaluated over time; and

- economic incentives for conservation should be designed with special attention paid to who benefits, how, and by how much.

Protected areas, because of constraints on size, representativeness and management effectiveness, must be augmented by protective measures elsewhere. Fragmentation of natural ecosystems is generally seen as one of the most critical threats to biodiversity world-wide. Protecting individual habitat fragments and natural habitat corridors within a matrix of more intensive human uses of the landscape (where sustainable use methods are employed, as described in 13.3) are likely to be important factors in the persistence of native biodiversity in many areas.

A wide array of techniques to conserve individual species, populations and genes must complement conservation efforts made at the landscape and ecosystem levels. *In situ* measures, such as habitat protection or in-field conservation, are generally more effective than *ex situ* conservation techniques. *In situ* management, however, faces two major limitations: (1) a lack of information on the conservation status and habitat needs of individual species, and (2) the considerable economic or opportunity costs for conserving individual species or populations.

A growing range of *ex situ* technologies associated with gene banks, zoos, botanical gardens and aquaria has rapidly expanded our capacity to preserve species and genetic diversity. However, none of the *ex situ* technologies is fail-proof. Depending on the technology, they are vulnerable to pests and disease, physical damage to facilities from natural causes (e.g. fires, floods, storms, etc.) and human events (e.g. war, economic decline, policy change, etc.). World-wide, for example, genebanks contain over 4 million unique samples of seeds, but a high percentage of these accessions have probably died because of poor maintenance and a lack of adequate storage facilities.

One way to compensate for the limitations of *ex situ* conservation measures is to deploy measures to restore and rehabilitate natural populations and ecosystems. A small number of endangered species (mostly mammals and plants) have been reintroduced successfully to natural habitats, sometimes after many years of survival only in captivity. The success rate, however, has been low. The more complex challenge of restoration ecology (restoring ecosystem processes and biological communities) is in its infancy and consists largely of *ad hoc* responses to particular problems. Clearer enunciation of the goals, techniques and theoretical framework of restoration ecology will lead to its inclusion as a major tool in biodiversity conservation.

(13.5) This chapter analyses the use of socioeconomic tools to manage biodiversity more effectively. Linking the benefits of biodiversity conservation to local peoples and

other interests that make decisions impacting the health of species and ecosystems is a key, often indispensable, component of successful conservation and sustainable use strategies. The use of socioeconomic tools in support of biodiversity management is a relatively recent phenomenon. The limited assessments of their effectiveness suggest that recognizing the value of local and indigenous knowledge, and improving local participation in planning, implementation and monitoring, are often keys to successful biodiversity management programmes.

Locally targeted economic incentives are also important. These can be used to increase the value people in developed and developing countries attach to biodiversity, and therefore the likelihood that they will embrace sustainable use and conservation practices. Relatively little, however, is known about the level at which economic incentives become effective under various conditions. For example, debate over the potential of non-timber forest products and ecotourism illustrates the difficulties in choosing appropriate local economic incentives. Clearly, however, local economic incentives are vital and more focused research is needed to provide a more realistic assessment of their role and importance.

(13.6) Incentives alone, however, will not always be enough to conserve and sustainably use biodiversity. Human activities will have to be regulated in some situations if biodiversity conservation is a societal goal. A range of legal and institutional tools can create economic incentives to conserve biodiversity directly and influence its management through regulatory action. Customary and traditional legal methods have served to promote the conservation and sustainable use of biodiversity, some of which have worked effectively for centuries in parts of Asia and Africa. These can remain a vital part of conservation and sustainable use strategies if they are not entirely supplanted by modern legal systems.

Modern legal and institutional tools for the protection and sustainable use of species and ecosystems have moved from a primary focus on regulatory measures to increased emphasis on encouraging voluntary systems based on contracts and incentives. Legal strategies have been stimulated by the provisions of the Convention on Biological Diversity, but they are only now beginning to address regulatory and incentive systems for controlling access to and distributing benefits from the sustainable use of genetic resources. One of the most important institutional changes required to enhance incentives and improve the acceptance of regulation is to establish an appropriate balance between national and local control over resources.

(13.7) Biodiversity management calls for higher levels of co-operation and co-ordination than are required in traditional sectoral approaches to natural resource management. In one way or another, biodiversity is an

important part of forestry, fisheries, agriculture, tourism and coastal zone management; and in turn, its conservation is affected by many other sectors. Integration of conservation and sustainable use measures is generally constrained by a lack of human, institutional and financial capacities to

implement and co-ordinate appropriate method combinations in the field. Little is known about the existing and additional capacity required in each of these areas to manage biodiversity adequately on a global basis. What is known suggests that substantial additional capacity is needed.

13.0 Introduction

Section 13 considers steps for conserving and sustainably using biodiversity, particularly in light of the articles in the Convention on Biological Diversity. Building on earlier sections that analyse how and why biodiversity is being lost (Sections 4, 5, 6, 11 and 12 in particular), Section 13 offers a review of the responses available to sustainably use and conserve ecosystems, species, populations, and genetic diversity. The section assesses a wide range of technical methods and social, economic, and legal measures relevant to the use and protection of the Earth's biotic wealth. The approaches described herein are representative, but not inclusive, of the thousands of approaches being used around the world. In the right combination, these methods can provide the opportunity to effectively counter threats to biodiversity noted in previous chapters. Within the broader context of sustainable development, such approaches are an essential basis for improving the human future.

Chapter 13.1 discusses the benefits of developing a conceptual framework to relate the wide array of methods necessary to sustainably use, conserve, and restore biodiversity at the national level. Several sets of issues are presented that relate to the interaction and effectiveness of conservation and sustainable use measures. These issues include the importance of:

1. integrating different types of approaches to ensure that the widest possible range of biodiversity and its components are sustainably used and conserved;
2. recognizing that the conservation and sustainable use of biodiversity are heavily influenced by social, cultural, economic and political attitudes and conditions; and
3. encouraging policy and institutional co-operation and co-ordination to achieve conservation goals and objectives.

Recognizing the complexity and uncertainty associated with biodiversity and its sustainable use and conservation, the use of strategic planning, adaptive management techniques and bioregional/ecosystem management approaches are emphasized.

Chapter 13.2 presents an overview of methods for setting priorities for biodiversity conservation, with an emphasis on their application at national levels. Deciding which species and habitats have precedence in the allocation of limited financial, human and institutional resources is a difficult but inevitable aspect of conservation planning in the 1990s. This chapter presents various types of approaches to priority setting, including examples of priority-setting efforts in practice.

Chapter 13.3 presents methods that maintain or facilitate the sustainable use of biodiversity within the context of human uses and management of natural resources,

including agriculture, forestry, fisheries, wild flora and fauna harvesting, biodiversity prospecting, and tourism. These methods are directed toward resource management systems in which the primary objectives are to use natural resources for human consumption and benefit, not to preserve biodiversity *per se*.

Chapter 13.4, on the other hand, discusses aspects of management systems where the conservation or restoration of biodiversity is a principle objective. Approaches are presented for a range of conservation systems including, among others, protected areas and natural habitat management, restoration ecology, zoos, botanical gardens, museums, and germplasm storage and maintenance facilities. These approaches are, in a sense, insurance against the limitations of the sustainable use methods presented in the previous chapter.

Whereas the measures presented in Chapters 13.2 to 13.4 are largely technical, Chapter 13.5 examines ways to address local social and economic issues relevant to sustainable use and conservation efforts. These approaches include using various types of social strategies such as greater use of local and indigenous knowledge, and improved participation in planning and management, and locally targeted economic incentives such as markets for non-timber forest products and ecotourism to create greater social and economic benefits from biodiversity. Such measures can be critical to the success of the technical measures previously discussed.

Chapter 13.6 considers legal measures that can be used to regulate activities with adverse impacts on biodiversity and to create the legal basis for implementing technical, social and economic methods to sustainably use and conserve biodiversity. Legal tools are considered in the context of both traditional legal systems and modern legal systems used at national and international levels.

Finally, Chapter 13.7 assesses human, institutional, infrastructure and financial capacities to carry out integrated and comprehensive biodiversity management programmes.

13.1 A framework for managing biodiversity

13.1.1 Introduction

The goal of biodiversity management is to 'strike the optimal balance between conserving the diversity of nature and advancing human sustainable living'. To effect sustainable development, governments, citizens, international organizations and businesses will have to co-operate in finding ways to support the essential processes of the planet, an effort that depends on maintaining biological diversity. 'Maintaining as much of the latter as possible has to be a social goal, and a large component of strategies for sustainability' (Holdgate 1994).

'Biodiversity management' is the human effort to plan and implement a set of approaches to:

1. protect and sustainably use biodiversity and biological resources, and ensure adequate sharing of benefits therefrom;
2. develop the human, financial, infrastructural and institutional capacity to address these objectives; and
3. establish the institutional arrangements necessary to foster the required co-operation and action by private and public sector interests.

Biodiversity management, as used here, seeks to maintain biodiversity for its associated material, social, cultural, spiritual and ecosystem values (see Section 12). It also includes the full range of management activities, from the preservation of species, their genetic traits, and the array of habitats and landscapes, through the restoration of ecosystems and the harvesting of plant, animal and microbial resources for human need, to the generation and distribution of benefits.

For the sake of consistency with the Convention on Biological Diversity, Section 13 will employ the term 'conservation' in its most restricted form to mean 'protection', leaving use and the sharing of benefits to be stated separately, as appropriate. This represents an important departure from the universally agreed-upon and adopted terminology of the *World Conservation Strategy*, where conservation was defined to embrace all three dimensions of protection, sustainable use and benefit sharing (IUCN/WWF/UNEP 1980).

Previous sections of this report have demonstrated that biodiversity is extraordinarily complex; that is, there are numerous elements involved and myriad interrelationships and interdependencies among them, many of which are poorly understood. Achieving the goal of balanced conservation, sustainable use and benefit sharing under these circumstances requires careful organization and focus of human enterprise.

The causes of biodiversity loss and impoverishment have been reviewed earlier in this assessment. The more obvious forces include various forms of habitat loss, pollution, over-exploitation and the introduction of invasive species (see Section 11). Behind these forces lie more complex causes that are often found within the very policies, laws and administrative arrangements established by governments and people. The Global Biodiversity Strategy (WRI/IUCN/UNEP 1992) identifies six fundamental causes of biodiversity loss (see Box 13.1-1). Actions taken to address immediate threats to biodiversity will have little effect unless they are supported by efforts to address the underlying causes that sustain the over-exploitation of species and destruction of habitats (see Section 12).

Success at meeting the objectives of biodiversity management – namely, protection, sustainable use, and benefit sharing – depends upon two things. First, policy-makers and managers need an adequate understanding of the social, political, economic and cultural context within

Box 13.1-1: Six fundamental causes of biodiversity loss.

1. Unsustainably high rates of human population growth and natural resource consumption.
2. Steadily narrowing spectrum of traded products from agriculture and forestry, and introduction of exotic species associated with agriculture, forestry and fisheries.
3. Economic systems and policies that fail to value the environment and its resources.
4. Inequity in ownership and access to natural resources, including the benefits from use and conservation of biodiversity.
5. Inadequate knowledge and inefficient use of information.
6. Legal and institutional systems that promote unsustainable exploitation.

Source: WRI/IUCN/UNEP (1992).

which these biodiversity management objectives are pursued. Second, they need to select tools and methods that show promise in meeting those ends.

Section 13 considers the context within which biodiversity management takes place and explores the various tools and methods presently available for taking action to meet biodiversity management objectives. This chapter presents a framework for action, consisting of three components:

1. the **context** for biodiversity management;
2. the **methods and tools** for action to manage biodiversity; and
3. **approaches** for biodiversity management programmes in a complex and uncertain world, including the preparation of strategies and action plans to integrate the planning and implementation of these methods and tools.

Chapters 13.2 to 13.6 assess the tools, methods and strategies available to manage biodiversity. The final chapter (13.7) closes Section 13 with a fifth component of the framework introduced in Chapter 13.1: the development of the human, institutional, infrastructural and financial **capacity** to manage biodiversity.

13.1.2 Context for biodiversity management

The content of a nation's biodiversity policies and plans will affect decisions on the choice of methods and tools that best fit that country's particular cultural, historical, social, economic and ecological reality.

The success of a biodiversity action programme will depend on being able to pull the components and disciplines together into an integrated approach. But, no matter how biologically or technically sound, action plans often fail where they ignore the vital role and influence of public awareness levels, fail to incorporate local and traditional knowledge, fail to address issues of poverty and economic development, and fail to consider contemporary policy issues.

The choice of methods and tools for biodiversity management will depend upon the given state of awareness and understanding in the general population, in the leadership of private and public agencies, and in government circles. Where awareness is low, initial activities and investments may need to focus on preparing and distributing information, sponsoring special events and establishing demonstration areas. Alternatively, where awareness is high, action may proceed directly to strengthen protected areas, develop biodiversity prospecting programmes or shift to sustainable forestry practices.

Local knowledge of rural and indigenous peoples can provide the management of biodiversity with long-term experience and observation. While modern agriculture, forestry and fisheries are vital to meet present and future demands for food and fibre, their potential to become more sustainable, and to preserve options for new opportunities such as pharmaceutical prospecting, can be enhanced by incorporating lessons from the past.

The best approach for biodiversity management will also vary considerably with a country's level of economic development. Obviously, a country that has a high proportion of its people living in poverty will face different priorities for the use of public funds from one with an affluent population. The competition for land and resources may be particularly high in a developing country, leading to conflict. For example, is a forest to be cleared for food production, or is it to be retained in its wild state for ecotourism, biodiversity prospecting and other uses? Which alternative can best offer benefits to support local people?

The effectiveness of biodiversity management also depends on the institutional and policy environment within which actions are taken. Many governments have negotiated internationally agreed treaties and conventions that limit and orientate the conservation and use of natural resources, including biodiversity. Nationally, policies may promote positive or negative actions for biodiversity conservation and use. All too often they stimulate –

intentionally or unintentionally – the conversion of important habitats, unsustainable use of biological resources, and pollution and environmental degradation.

Hence, the planning and implementation of biodiversity management may begin within a context that features a range of conflicts in the international and national arena. Obligations under international agreements may require action to reform national policies and develop positive responses. Alternatively, international agreements that may hinder the efforts of some countries to manage their biodiversity sustainably may require reforms or more flexible interpretation. For example, the ban on ivory trade supports conservation in East African countries, but challenges rural economic development and conservation in southern African countries.

Biodiversity management requires interdisciplinary skills. Biologists, economists, anthropologists, engineers, foresters, agriculturalists, marine scientists and an array of community organizers, field managers and administrators are needed to address the multiple dimensions involved.

Flexibility must be used to set the appropriate geographic extent of the area to be managed. Populations, species, habitats and ecosystems each have their own geographic ranges – boundaries that are typically distinct from the administrative and sectoral boundaries of local and national public agencies, private lands and communal territories.

Biodiversity management is multi-sectoral. Genetic diversity within harvested species and closely related wild relatives has contributed enormously to the productivity of agriculture, aquaculture, fisheries and forestry. The short-term biological productivity of forestry, fisheries and agriculture may not be strictly dependent on biodiversity in the broadest sense; however, decreasing diversity in ecosystems that support these sectors will at some point – it is not clear where – have adverse impacts on their resilience, productivity and stability. At the same time, these sectors, as well as those not directly tied to biological resources, such as transportation, manufacturing, energy and minerals, and health and sanitation, play significant and direct roles in reducing diversity at the ecosystem, species, populations and genetic levels.

13.1.3 Methods and tools for biodiversity management

There are many methods and tools available for the management of biodiversity. Some have been developed to protect or restore particular species, genetic strains or habitats. Others are used to produce goods and services sustainably from biological resources. Some are intended to facilitate the equitable distribution of benefits from the conservation and sustainable use of biodiversity. These approaches can be categorized in the following way:

1. **In situ approaches** include methods and tools that protect species, genetic varieties and habitats in the wild. Which actions are used depends on the management objective. Most often, *in situ* approaches involve the establishment or management of protected areas such as strict nature reserve/wilderness areas, national parks, national monuments/natural landmarks, habitat/species management areas, protected landscapes and seascapes, and managed resource protected areas (see 13.4.2.1) (IUCN 1994). However, *in situ* approaches also include wildlife management and resource protection strategies outside protected areas. In agriculture and forestry, *in situ* methods are sometimes used to protect genetic diversity in crops and trees in the field or forest.
2. **Ex situ approaches** include methods that remove plant, animal and microbial species and genetic varieties from their environment. This is done for breeding, storage, cloning or rescue in cases where either (1) habitats can no longer sustain these elements because of site alteration or transformation, or (2) materials can be used to facilitate research, experimentation and development of new products, and public awareness. Such methods include botanic and zoological gardens, mycological collections, museums, seed banks, tissue culture collections, etc. Because the organisms are maintained in artificial environments, *ex situ* methods isolate species from evolutionary processes. This problem can be partially addressed by linking *ex situ* interventions to *in situ* programmes wherever possible.
3. **Restoration and rehabilitation approaches** include methods that draw upon *in situ* and *ex situ* tools to re-establish species, genetic varieties, communities, populations, habitats and ecological processes. Ecological restoration usually involves the reconstruction of natural or semi-natural ecosystems on degraded lands including the reintroduction of most native species, while ecological rehabilitation involves the repair of ecosystem processes, such as nutrient cycling or hydrologic regimes, but not necessarily the recreation of a natural ecosystem and its full complement of species.
4. **Major land-use approaches** include tools and strategies in forestry, fisheries, agriculture, wildlife management and tourism to incorporate protection, sustainable use and equity criteria and guidelines into management objectives and practices. Since these land uses dominate most landscapes and the nearshore coastal zone, these approaches are often where the greatest returns on investments in biodiversity management will be found.
5. **Policy and institutional approaches** include methods that limit the use of land resources through zoning

schemes; use incentives and tax policy to foster particular land-use practices; create and enforce land tenure arrangements that promote stewardship, and establish easements and other arrangements between public agencies and private interests that seek to establish landscape characteristics favourable to biodiversity.

It is impractical to pursue sustainable use or protection measures for every single species since there are so many, each with relatively specific requirements. Instead, measures usually emphasize maintaining habitat conditions that support many – perhaps tens of thousands – of species. But even at ecosystem levels of organization, their highly variable and dynamic nature can call for different approaches according to habitat type, ecosystem function and other variables (see Sections 5 and 6). For example, maintaining grassland ecosystems may require interventions of fire on a regular basis since many grassland species reproduce only after such disturbances. In contrast, moist forests, in which species have not adapted to frequent fire, may need to be protected from fire.

Programmes to manage biodiversity in any given area will normally employ a set of mechanisms and tools that, taken together, manage various problems, threats and human demands. For example, the public and private institutions of a country might simultaneously:

- establish parks and reserves to protect and regulate the use of ecologically valuable and sensitive habitats;
- form seed banks and microbial culture collections to maintain viable samples of germplasm;
- foster practices in forestry, fisheries, rangelands, agriculture and tourism that protect soil biota and the range of species and varieties of the region while maintaining productivity;
- initiate projects that combine the technical tools of botanical and zoological gardens and on-farm activities to help restore degraded areas;
- a range of land-use planning and zoning tools in urban and rural areas; and
- institute associated laws, policies and administrative procedures to facilitate these measures.

A piecemeal approach, characterized by a disjointed list of activities and lack of co-ordination among implementing institutions, will fail to protect or sustainably use many valuable elements of biodiversity.

An integrated biodiversity programme is one that features:

- a set of approaches, tools and mechanisms (e.g. protected areas, seed banks, rural zoning) designed to

address threats (e.g. habitat conversion), problems (e.g. unsustainable use practices) and opportunities (e.g. fostering new enterprises through biotechnology);

- a combination of interrelated measures to produce needed material and economic goods, and ecological, cultural and spiritual services, for the least cost and intervention; and
- a whole strategy that can be placed within the social, economic, political and institutional context with minimum disruption. Where major reforms and new initiatives are needed, the disruption associated with establishing new institutions (or changing farming practices) may require some time for accommodation by agency employees and local residents.

The degree to which biodiversity and biological resources are used sustainably and conserved, will depend in large part on how these various approaches have been integrated.

13.1.4 Approaches for managing biodiversity in a complex world

Biodiversity management programmes can improve the odds of success in dealing with complexity and uncertainty by employing the following three approaches: strategic planning, managing at bioregional or ecosystem scales, and using adaptive management techniques.

In all three approaches, broad participation is vital to success. People in the public and private sectors, and a wide variety of institutions (e.g. natural resource management agencies, universities, museums, zoos, botanical gardens, non-governmental organizations, communities and business) can contribute a great deal to the planning and implementation of biodiversity management programmes. For example, experience with the preparation of national biodiversity strategies and action plans demonstrates that this is true in developed and developing countries alike (Miller and Lanou 1995). Other research (e.g. Kiss 1990; Lynch 1992; Wells 1995) suggests that only through participatory planning can local interests be expected to share responsibility for implementation.

13.1.4.1 Strategic planning

A planning process should identify vital links between biodiversity, environmental and human health, and the natural resource base that sustains livelihoods and provides new options for social and economic development. A productive biodiversity planning process can identify those activities and investments that most effectively strengthen these linkages. These are strategic considerations. Not simply a new 'add-on' to traditional planning, this process seeks nothing less than the integration of strategic biodiversity considerations throughout national development plans.

Article 6 of the Convention on Biological Diversity calls upon countries to 'Integrate, as far as possible and appropriate, the conservation and sustainable use of biological diversity into relevant sectoral or cross-sectoral plans, programmes and policies'. Clearly, responding to these provisions of the convention can serve as a comprehensive basis for planning and implementing an integrated programme for the protection and sustainable use of biodiversity.

National biodiversity strategies, action plans or programmes – as called for under Article 6 of the Convention on Biodiversity and in Agenda 21 – are intended to identify appropriate conservation and sustainable use measures and specify how they will be implemented. A growing number of countries (including Canada, Chile, Germany, Indonesia, Norway, the UK and Vietnam among others) have published or begun to develop national strategies and action plans. In most cases, these strategies and action plans represent the first planning tools that go beyond the piecemeal and incomplete efforts that have characterized conservation and sustainable use programmes in many countries prior to the stimulus of the convention.

While there is considerable variation in the approaches being followed by each country, the following distinctions between strategies and action plans are useful (Miller and Lanou 1995):

National Biodiversity Strategies are general policy instruments that identify strategic needs for the effective conservation of biodiversity. They draw upon descriptive and quantitative data and information to identify conservation goals and objectives, evaluate options to achieve goals, consider benefits and costs, and propose broad steps or policy actions that can be taken to improve conditions for biodiversity conservation.

Biodiversity Action Plans are frameworks used to identify more specific steps that can be taken by policy-makers, sectoral institutions and others to implement the national strategy. Action plans are practical documents specifying what protection and use measures will be taken; which institutions are responsible for which measures; what personnel, facilities; and finance will be employed; timetables; how NGOs and private organizations can be involved, and whether international co-operation is needed, and how it would be implemented.

A synthesis of the experience of 17 countries engaged in the preparation of national biodiversity strategies and action plans suggests that there are seven indicative steps to the biodiversity planning process. The UNEP-sponsored project outlines these steps, as shown in Box 13.1-2 (Miller and Lanou 1995).

These plans are **cyclical** in that they are constantly revolving around the seven steps outlined in Box 13.1-2. They are also **iterative**, leading to a continuous series of ever more detailed and specified versions of the plan over time, each version benefiting from new information and knowledge, further dialogue, expanding constituencies, and feedback from the implementation, monitoring and evaluation of past experience.

More significant than the product of planning – a written document or plan – is the **process** itself. Participants deeply involved in biodiversity planning often find that the greatest value in working in a strategic planning process is from the exercise itself. The first stages bring the stakeholders together, gather and evaluate information and

knowledge, define goals of common interest, and develop and adapt methods and tools to be used to achieve those goals. Other aspects include sharing responsibilities for actually implementing agreed plans and evaluating the results, having participating agencies, groups and individuals develop an understanding of biodiversity management goals and opportunities, and building a sense of ownership of the ensuing programmes.

As important as national biodiversity strategies, action plans and related programmes are in their own right, their impact will be greatest when they are part of broader strategies for long-term national development. Carew-Reid *et al.* (1994) provide examples of how biodiversity planning efforts can fit within a strategy for national sustainable

Box 13.1-2: Steps for strategic biodiversity planning.

1. **Getting organized.** Establish the institutional framework; designate leadership; create the participatory approach; form the interdisciplinary and inter-sectoral team; assign a budget.
2. **Assessment.** Gather and evaluate information on the status and trends of the nation's biodiversity and biological resources, laws, policies, organizations, programmes, budgets and human capacity. Create a preliminary statement of goals and objectives, identifying gaps, conduct a first review of options to close gaps, and make a rough estimate of costs and benefits and unmet needs associated with a national biodiversity programme.
3. **Developing a strategy.** Determine goals and operational objectives; analyse and select specific measures that will close the gaps identified in the assessment; further consult and modify until consensus is reached on acceptable targets and mechanisms; characterize stakeholders and what they can do; write a statement of the strategy, consisting of the actions and investments called for to meet the goals and objectives; at this stage consult closely with other conservation and development plans and sectors, including conducting a national dialogue with all interested stakeholders.
4. **Developing a plan of action.** Determine which organizations (public and private) will take charge of implementing specific activities included in the strategy, where, by what means, and with what resources (people, institutions, facilities and funds). Identify time phases for action.
5. **Implementation.** Launch activities and policies in practical terms. Partners take responsibility for particular elements of the plan and biodiversity planners become 'biodiversity implementors' in the key ministries, non-governmental organizations, communities, indigenous groups, business and industry involved in the planning process.
6. **Monitoring and evaluation.** Establish indicators of success, determining which organization(s) will monitor which factors and the methods that will be employed. Monitoring should track the status and trends of biodiversity (species, genes, and habitats and landscapes), implementation of policies and laws, implementation of specific strategic actions and investments, and the development of needed capacity (people, institutions, facilities and funding mechanisms).
7. **Reporting.** Determine what types of reports are needed, who is responsible for reporting, and agree on format, content and timing of the delivery of documents. Types of reports might include:
 - annual status reports to the national chief executive, parliament, and the people;
 - country study;
 - national strategy;
 - action plan;
 - five-year status report on biodiversity and biological resources; and
 - periodic reports to the Convention, the UN Sustainable Development Commission, and other international forums.

development that seeks to define and implement actions to improve and maintain the well-being of people and ecosystems. Other important works available to assist countries with strategic biodiversity planning include publications on: environmental impact assessments (World Bank 1991), country study guidelines (UNEP 1993), and the economics of biodiversity (McNeely 1988; Pearce 1993).

13.1.4.2 Bioregional and ecosystem management programmes

The effective protection, understanding and sustainable use of biodiversity and biological resources require that objectives are identified and actions are implemented at geographic and time scales consistent with the biological, social and economic processes affecting the achievement of those objectives. This approach to resource management is often referred to as bioregional management, ecosystem management, or landscape management. Only in this way can management provide for the flexibility and variety of options needed to accommodate human aspirations, while ensuring the protection of critical genetic, species and habitat diversity, and the maintenance of ecosystem services. For example, the conservation of migratory species requires that objectives be set and priorities established across broad geographic areas. Similarly, efforts to integrate conservation and development near a protected area require objectives that are set at a scale that can address such issues as marketing opportunities, the potential for migration of people to the region, and the resource needs of surrounding communities. Typically, conservation programmes are too small in scale to meet the habitat requirements of some species. More generally, objectives for conservation and resource management are too often identified at scales too small to make either economic or biological sense. For example, the cumulative effects of many small resource management decisions – each with minimal impact in its own right – can lead to significant landscape changes that are unappreciated at local levels.

Biodiversity conservation objectives can be addressed more successfully by expanding the area to be managed beyond protected areas, to the bioregion or landscape scale. This calls for co-operative arrangements with private landowners, local governments, communities and corporations, present in the region. By working with surrounding landowners and residents, biodiversity managers can better meet biodiversity management objectives.

Such 'bioregional' or 'ecosystem management' approaches are being put to the test in various parts of the world. In most cases, these approaches build upon existing protected areas or highly valued biodiversity sites, and establish institutional arrangements that encourage public

and private sector co-operation across whole landscapes. Ideally, a bioregional management programme will feature:

1. an **ecological** component consisting of areas protected for their biodiversity value and interconnected where possible by corridors of natural or semi-natural habitats;
2. an **economic** component that supports the sustainable management and use of natural resources in the matrix of farms, grazing lands, managed forests, industry, villages and infrastructure; and
3. a **social/cultural** component that facilitates the participation of local people in resource planning and decision-making and provides opportunities for people to meet a variety of social and cultural needs.

At the heart of such a programme lies a set of institutional mechanisms that enables the diverse public, civic and private interests to negotiate and implement their plans. These are complemented by support mechanisms from universities, and public, community and private agencies and other organizations that assist decision-making with information, knowledge and experience. Local residents, industry, and public agency leaders are encouraged to join in formulating a common vision for the region. Such a vision would identify needed actions and investments. The group would take responsibility for implementation, evaluation and monitoring of results.

Considerable experience in bioregional management has already been gained (e.g. Hudson 1991; Brown and Wyckoff-Baird 1992; Golley 1993; Aberley 1994; GAO 1994). Examples include the tri-country Waddensee programme along coastal Denmark, Germany and the Netherlands (Wadden Sea Assessment Group and Trilateral Working Group 1991); Greater Serengeti Ecosystem in Kenya and Tanzania (Tanzania Ministry of Tourism, Natural Resources and Environment 1991); La Amistad Biosphere Reserve in Costa Rica and Panama (Gobierno de Costa Rica 1990); Great Barrier Reef Marine Park Authority, Australia (Murdoch 1992); and Greater Yellowstone Ecosystem, United States (Rawlins 1994). Costa Rica has embarked on an ambitious strategy to develop bioregional management programmes centred on eight of its protected areas (see Figure 13.1-1). Within each of these regions, which extend beyond the formal protected areas, a variety of land uses and biodiversity management activities are planned (Gobierno de Costa Rica 1990).

One of the key institutional challenges in bioregional management is to establish an appropriate balance between national and local control over resource management (Miller 1995). Achieving an effective balance between the authority and responsibilities of various levels of government, from the national to the local, will often

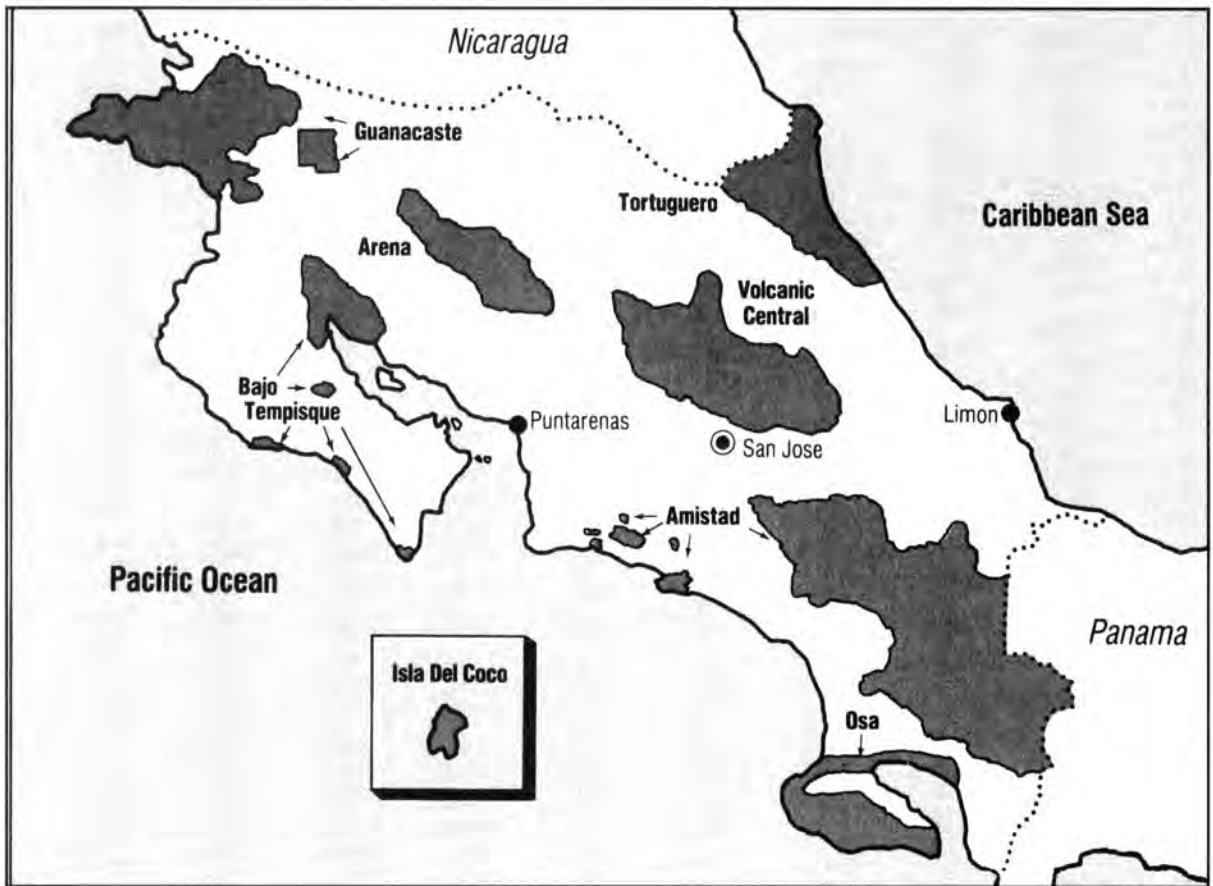

Figure 13.1-1: Bioregional management involving eight conservation areas in Costa Rica. (From WRI/IUCN/UNEP 1992.)

require steps to return or establish local ownership and tenure of resources, or to centralize certain rights and responsibilities. Centralization of management requires mechanisms for law enforcement and control; decentralization necessitates participation and joint management. Centralization can be important in protecting national interests or minority interest in the sustainable management and use of natural resources that might otherwise succumb to pressures for rapid depletion. Decentralization and the use of co-management strategies, on the other hand, enables local communities, private companies and non-governmental organizations (NGOs) to join governments in defining and implementing policies to conserve and use biological resources sustainably.

The North York Moors National Park in the United Kingdom serves as an example of a co-management arrangement (Statham 1994). There, farmers living within and around the park have the opportunity to collaborate with the parks agency to restore the hedgerow habitat that is vital to biodiversity management in the region. The park offers farmers a co-operative contract whereby farmers are paid to restore and maintain hedgerows of vegetation along designated boundaries of their fields and pasture lands.

While bioregional management offers opportunities to

address biodiversity protection, use and equity objectives in ways that can respond to the dynamic and unpredictable features of ecosystems and human society, challenges abound. Obstacles to the implementation of bioregional programmes include:

- a lack of mandates for public agencies to provide the leadership needed to organize such programmes;
- a lack of capacity to manage the various technical and administrative tasks involved in shifting to larger territories;
- the absence of incentives for stakeholders to become involved in defining and negotiating equitable arrangements;
- the inability of government programmes to adjust their investment and programme cycles to fit the social traditions, mechanisms and needs of residents;
- a lack of political will to establish or support the authority to integrate and co-ordinate existing institutions; and
- a failure to establish long-term funding mechanisms that compensate residents who trade off benefits or carry increased costs as a result of their co-operation (Miller 1995).

Nevertheless, a rapidly growing body of scientific literature and practical experience suggests that the relationship between scale – both geographic and temporal scales – and biodiversity management deserves much greater attention.

13.1.4.3 Adaptive management

Adaptive management practices can reduce uncertainty and improve resource management through time. The effectiveness of management practices that influence biodiversity is constrained by incomplete knowledge of biodiversity and by the dynamic nature of living systems. Establishing goals for the conservation of biodiversity and the sustainable use of its components is hindered by limited knowledge of such basic issues as the identity of most species, the role of specific components of biodiversity in various ecological processes, the vulnerability of ecosystem services to the loss of diversity, and the economic implications of changes in diversity. Goal setting and the attainment of goals is also hindered because biological systems are dynamic – populations of species evolve in response to selection pressures, the composition of ecological communities shifts with changes in climate, and species migrate into or are lost from particular communities. Consequently, even if a vision of a desirable future could be developed, the path to its fulfilment could not be mapped with precision. So too, human societies and their values change. For example, what society demands and expects from its forest resources today is quite distinct from 20 years ago (Gordon 1993). Biodiversity management is always undertaken in the face of substantial uncertainty.

Adaptive management is a technique for managing biological systems while also reducing uncertainty about the functioning of the systems and responding to the changing social, biological and physical environment. Gunderson *et al.* (1994) advocate 'adaptive management' measures that accept change as a basic reality and seek to plan with, around and through change.

The principal elements of adaptive management are:

1. that management interventions are made in an experimental manner so that the outcome of the intervention can be used to reduce uncertainty about the system;
2. that sufficient monitoring prior to and during the intervention enables detection of the results of the management intervention and thereby allows managers to learn from past experience; and
3. based on the feedback to managers, communities and other constituencies, management interventions are then refined.

Adaptive management techniques are also vital for biodiversity management since there is limited experience with many tools, methods and approaches. Because of this, assessments of their effectiveness are often incomplete or non-existent. The adaptive management approach, therefore, is particularly useful when decisions need to be made in the absence of data, where uncertainty is great, and where social and biological change are inevitable.

13.1.5 Conclusion

This chapter has shown that a comprehensive and integrated framework is vital to the complex task of managing biodiversity for conservation, sustainable use and benefit-sharing objectives. However, it is not enough simply to integrate an array of biodiversity management approaches into the planning process. Most actions to conserve, sustainably use, and share the benefits of biological resources are implemented in specific places where biodiversity and human activities are linked at many scales. Biodiversity management is not simply a question of establishing parks or reserves as islands of protection in a sea of unregulated agriculture, forestry, fisheries and urban development, or of setting up agricultural seed banks without links to on-farm conservation plots. Rather, biodiversity management includes the steps required to incorporate conservation and sustainable use practices within all components of the overall landscape, supported by policies, agreements and institutional arrangements that foster co-operation. The following chapters assess the tools, methods, approaches, and capacities required to manage biodiversity successfully within an integrated framework.

References

- Aberley, D.** 1994. *Futures by Design: The practice of ecological planning*. New Society Publishers, Philadelphia, Pa.
- Brown, M.** and Wyckoff-Baird, B. 1992. *Designing Integrated Conservation and Development Projects*. Biodiversity Support Program, Washington, DC.
- Carew-Reid, J., Prescott-Allen, R., Bass, S. and Dalal-Clayton, B.** 1994. *Strategies for National Sustainable Development: A handbook for their planning and implementation*. Earthscan, London.
- GAO.** 1994. *Ecosystem Management: Additional actions needed to adequately test a promising approach*. US Government Accounting Office, Washington, DC.
- Gobierno de Costa Rica,** Ministerio de Recursos Naturales, Energía y Minas. 1990. *Estrategia para el Desarrollo Institucional de La Reserva de La Biosfera 'La Amistad'*. Conservation International and Organization of American States, San José, Costa Rica.
- Golley, F.B.** 1993. *A History of the Ecosystem Concept in Ecology*. Yale University Press, New Haven, Conn.
- Gordon, J.C.** 1993. Ecosystem management: an idiosyncratic overview. In: Aplet, G.H., Johnson, N., Olson, J.T. and Sample,

- V.A. (eds), *Defining Sustainable Forestry*, 240–260. Island Press, Washington, DC.
- Gunderson, L.H., Holling, C.S. and Light, S.S.** 1994. Barriers broken and bridges built – a synthesis. In: Gunderson, L.H., Holling, C.S. and Light, S.S. (eds), *The Renewal of Ecosystems: Bridges and barriers*. 325–355. Columbia University Press, New York.
- Hudson, W.E.** 1991. *Landscape Linkages and Biodiversity*. Island Press, Washington, DC.
- IUCN.** 1994. *Guidelines for Protected Area Management Categories*. IUCN, Gland.
- IUCN/WWF/UNEP.** 1980. *World Conservation Strategy: Living resource conservation for sustainable development*. IUCN, Gland.
- Kiss, A. (ed).** 1990. *Living with Wildlife: Wildlife resource management with local participation in Africa*. Technical Paper No. 130. World Bank, Washington, DC.
- Lynch, O.** 1992. *Securing Community-based Tenurial Rights in the Tropical Forests of Asia. Issues and ideas*. World Resources Institute, Washington, DC.
- McNeely, J.** *The Economics of Biodiversity*. IUCN, Gland.
- Miller, K.R.** 1995. *Balancing the Scales: Managing biodiversity at the bioregional level*. World Resources Institute, Washington, DC.
- Miller, K.R. and Lanou, S.M.** 1995. *National Biodiversity Planning: Guidelines based on early experiences from around the world*. World Resources Institute, Washington, DC, United Nations Environment Programme, Nairobi, and The World Conservation Union, Gland, Switzerland.
- Murdoch, L.** 1992. *Discover the Great Barrier Reef Marine Park*. Bay Books, Pymble, Australia.
- Pearce, D.W.** 1993. *Economic Values and the Natural World*. Earthscan, London.
- Rawlins, C. (ed.)** 1994. *Sustaining Greater Yellowstone: A blueprint for the future*. Greater Yellowstone Coalition, Bozeman, Montana.
- Statham, D.C.** 1994. The farm scheme of North York Moors National Park, United Kingdom. In: Western, D., Wright, R.M. and Strum, S.C. (eds), *Natural Connections: Perspectives in community-based conservation*. 282–299. Island Press, Washington, DC.
- Tanzania Ministry of Tourism, Natural Resources, and Environment.** 1991. *Serengeti Regional Conservation Strategy*. United Republic of Tanzania Ministry of Tourism, Natural Resources and Environment, Dar es Salaam.
- UNEP.** 1993. *Guidelines for Country Studies on Biological Diversity*. United Nations Environment Programme, Nairobi.
- Wadden Sea Assessment Group and Trilateral Assessment Group.** 1991. *The Wadden Sea Status and Developments in an International Perspective*. Ministry of Environment, Copenhagen, Denmark.
- Wells, M.** 1995. Biodiversity conservation and local development aspirations: New priorities for the 1990s. In: Perrings, C., Mäler, K.G., Folke, C., Holling, C.S. and Jansson, B.O. (eds), *Biodiversity Conservation: Problems and policies*. 319–334. Kluwer Academic Press, Dordrecht.
- World Bank.** 1991. *Environmental Assessment Sourcebook*, 3 Vols. Technical Papers 139–141. The World Bank, Washington, DC.
- WRI/IUCN/UNEP.** 1992. *Global Biodiversity Strategy: Guidelines for action to save, study, and use earth's biotic wealth sustainably and equitably*. World Resources Institute, Washington, World Conservation Union, Gland, Switzerland, and the United Nations Environment Programme, Nairobi.

13.2 Defining priorities for conservation and sustainable use

13.2.1 Introduction

The development of strategic plans, including national strategies and action plans (see 13.1.4.1), will require choices to be made about resource allocation in order to maximize the long-term benefits that biodiversity can provide. Investments in the conservation and sustainable use of biodiversity, however, have rarely been made in a systematic, analytical and transparent manner. This chapter presents an overview of techniques for setting geographic priorities to conserve and sustainably use biodiversity.

All approaches to priority-setting are based on the assumption that the need for resources to conserve biodiversity will far outstrip the resources that are available. This assumption is expected to remain valid throughout the 1990s and beyond (Abramovitz 1994). Deciding which species and habitats have precedence in the allocation of limited financial, human and institutional resources is likely to remain a difficult but inevitable task for the foreseeable future.

Given the complexity of biodiversity and the range of values, perspectives and goals that influence how biodiversity is viewed, it is not surprising that there is no generally accepted universal scheme for establishing biodiversity priorities (Forey *et al.* 1994; Johnson 1995). Any set of conservation priorities reflects human values. In order to distinguish between the almost infinite variety of genes, species and ecosystems, priority-setters assign values to elements of biodiversity. These values may represent economic, scientific or social and cultural benefits from biodiversity that people and institutions consider most important for long-term conservation.

Most structured approaches to identifying biodiversity priorities have been focused on *where* actions are needed to protect biodiversity. Only a few efforts have been made to evaluate systematically *what* should be done in these areas. Many approaches were specifically designed to establish or revise protected area systems to best capture elements of biodiversity; many of the rest implicitly assume that some form of protection activity should take place in identified areas. It should, however, be noted that virtually all forms of geographically based priority-setting approaches can be used simply to identify where valuable biodiversity for a particular protection or sustainable use objective is located.

The geographic priority-setting approaches described here can, in theory, be used to identify where, geographically, to

focus changes in forest management policies and practices (see 13.3.3), how to target the collection of plant species for *ex situ* preservation and breeding, or where bioregional management efforts are most needed in order to integrate a wide range of conservation and sustainable use activities. Unfortunately, it is more difficult to assess what needs to be done as opposed to where something should be done. At the local and community level, rapid rural appraisal and other techniques are being used to identify the most effective or urgently needed actions (Shengji and Sajise 1995). At the national and international level, the requirements of the Convention on Biological Diversity have been used to analyse priorities in terms of what needs to be done (e.g. Rojas and Vallejo 1994) and a variety of countries have used various processes to do this while developing national biodiversity strategies and other national plans (see Miller and Lanou 1995). Many methods of setting geographic priorities for a wide range of conservation and sustainable use objectives have emerged over the last decade. Some are based on *genetic* analysis (i.e. use of genetic information to select populations or areas), some on *species* analysis (i.e. the distribution of particular species, aggregations of species, taxonomic groups and rates of species endemism), and some on *ecosystem* analysis (i.e. the distribution of distinct natural communities, ecosystems and ecosystem processes). These three categories of methods rely mainly on biological information, but may use any of the biological or social and institutional criteria (see Box 13.2-1). A fourth category comprises *integrative* methods that include significant consideration of economic, social and cultural factors in addition to biological factors.

No single priority-setting method fits all conservation objectives. For example, if the objective is to conserve a representative array of a country's natural ecosystems, a priority-setting approach that relies on species richness may neglect to represent important ecosystems that are relatively species-poor.

13.2.2 Genetically based methods for establishing priorities

Genetic variation underlies the more visible diversity of life that we see expressed in individuals and populations of a particular species, the different species themselves, and the higher taxonomic orders to which species belong. With the rise of biotechnology and the perception that genes are the grist for the next (or current) technological revolution, genetic diversity has become the focus of increased research – and also increased controversies over who 'owns' genetic resources and who benefits from their conservation.

Traditionally, efforts to characterize and conserve genetic diversity have been dominated by an emphasis on domesticated plants, particularly a few dozen agriculturally

Box 13.2-1: Criteria used for biodiversity priority-setting.

Any deliberate priority-setting effort uses various criteria to reduce the number of elements of biodiversity considered for priority status. The complexity of biodiversity and the number of ways of valuing it make a host of criteria theoretically possible, but only a handful of them are commonly used. Among the biological criteria are *richness* (the number of species – or ecosystems – in a given area), *rarity*, *threat* (degree of harm or danger), *distinctiveness* (how much a species differs from its nearest relative), *representativeness* (how closely an area represents a defined ecosystem), and *function* (the degree to which a species or ecosystem affects the ability of other species or ecosystems to persist).

Some priority-setting approaches use social, policy and institutional criteria as well. *Utility*, the most common non-biological criterion, points to biodiversity elements of known or potential use to humankind. Utility may be narrowly defined as economic value, but in a broader sense it can signify scientific, social, cultural or religious significance as well. *Feasibility*, often paramount in deciding how to allocate conservation resources, may be defined in political, economic, logistical or institutional terms. Considering feasibility along with biological criteria helps identify areas where actions are most likely to succeed. These criteria are newer entries to the field than biological criteria, but their use will increase alongside growing recognition that social, policy and institutional factors are crucial to conserving biodiversity.

Source: Johnson (1995).

important species. A growing number of agricultural research institutions have sought ways to limit genetic vulnerability – a uniformity of genotypes that leaves crops vulnerable to new environmental stresses, pests and disease – by preserving the range of genetic diversity found in crop species and their wild relatives. During the past 20 years, endangered species recovery programmes have stimulated considerable research on the genetic variability of remaining individuals and populations to find ways of ensuring that populations do not succumb to a combination of inbreeding and a narrowed genetic base. Others are interested in conserving genetic diversity within populations because of their potential for future utility (see Ledig 1988), or because a decline in diversity represents interference in the evolutionary process and the loss of evolutionary potential (see, for example, Mlot 1989; Hamilton 1993).

Genetic resources can be conserved *in situ* in reserves or special management areas, or in *ex situ* facilities such as seed banks, zoos, botanical gardens, aquaria, etc. Even as collectors take plant cuttings or shake seeds of a specimen into an envelope for *ex situ* preservation, or as conservation biologists protect the habitat of an animal population for *in situ* conservation, they are deciding which genes of a species are most likely to persist, especially if the species is rare or highly endangered. This is where genetically based approaches to identifying conservation priorities are needed. They are used to support three general objectives:

- to ensure that individuals representative of genetic variability within a species are included in conservation programmes;
- to help determine which population(s) contain the greatest genetic variation; and
- to conserve populations across their geographic range and the ecotypes in which they are found to ensure that co-adapted gene complexes (i.e. groups of alleles on one or more genes that adapt to the same selective pressures experienced in a particular environment), are conserved, and not just a representative sample of alleles.

Tools used for identifying genetically based conservation priorities range from simple surrogate measures of underlying genetic variation (e.g. variation in plant or animal morphology) to highly sophisticated molecular genetic techniques. In most cases, analysis of enzyme variants (allozymes) is used to gauge the overall genetic variability within a species, a population or a number of populations. Sampling strategies can be complex, and considerable debate about the advantages and disadvantages of different sampling techniques is seen in the literature. These issues are beyond the scope of this publication, and are discussed in detail elsewhere (see Schonewald-Cox *et al.* 1983; Hartl and Clark 1990; Falk and Holsinger 1991).

In most areas of the world, where information is scarce, species are numerous, and threats to diversity at all levels are acute, genetically based approaches should probably be viewed as a secondary strategy for identifying conservation priorities. Genetically based approaches should be used to 'fine-tune' priorities once the 'coarse filter' provided by ecosystem-based approaches (complemented by species-based approaches) has been applied. Woodruff (1992) suggests that ecological management is the cheapest and most effective way of conserving genetic diversity:

Genetic factors do not figure among the four major causes of extinction: overkill, habitat destruction and fragmentation, impact of introduced species, and secondary or cascade effects (Diamond 1989). Thus,

although genetic factors are major determinants of a population's long-term viability, conservationists can do more for a threatened population in the short-term by managing its ecology.

Nevertheless, genetically based approaches to identifying conservation priorities are pivotal in some circumstances. These include setting priorities for small, isolated populations; for genetically vulnerable species of high economic or other value; and for identification of individuals or populations for which there is no conservation alternative to *ex situ* preservation in the short term.

13.2.3 Species-based methods for establishing priorities

The species is the unit or element of the biodiversity spectrum – from genes to large-scale ecosystems – most commonly used by scientists and the public to represent biological variation (see also Sections 1 and 2). On the one hand, species are the most recognizable expression of taxonomic diversity. At the same time, species are the building blocks of ecosystems (McNeely *et al.* 1990). Not surprisingly, more biodiversity conservation efforts focus on species (populations of which are the immediate target of most conservation efforts) than on genes, communities or ecosystems. Likewise, most approaches to setting biodiversity-conservation priorities have relied heavily on the species as the basic unit for analysis.

The key feature of species-based approaches is their emphasis on the analysis of population sizes and geographic distributions of individual species to identify priorities. The species-based approach to setting priorities generally does not include analysis of biodiversity at higher levels of organization such as communities, ecosystems, ecosystem processes or biogeographic features. A species-based approach may express priorities in terms of specific sites or habitats, but the habitat is not necessarily chosen on the basis of its rarity or uniqueness. For example, the Kirtlands warbler (*Dendroica kirtlandii*) is one of the world's most endangered songbirds, and its nesting sites are a conservation priority. These nesting sites are found in jack pine (*Pinus banksiana*) forests in lower Michigan, a tree species that is widespread in upper Michigan, Minnesota and Canada. A species-based approach emphasizes the value of individual species. In this way it is different from ecosystem-based approaches, which emphasize the role of species interactions and ecological processes as factors important to the conservation and use of biodiversity and the role that ecosystem priorities can play in capturing a significant proportion of diversity at genetic and species levels. Species-based approaches usually emphasize conservation of individual species that are rare or endangered, or habitats characterized by a high degree of species richness and/or endemism. The first type of species-based approach often generates considerable

response from the general public and political authorities. In practice, individual species that are 'charismatic', 'flagship', or otherwise culturally prominent, and those that are endemic to a country or smaller area, tend to receive more attention than other species. Programmes to save the tiger, the giant panda, or the California condor are well-publicized examples of such single-species conservation priorities.

The second type of species-based approach is aimed at protecting habitats that are important to certain taxonomic groups. The best-documented world-wide examples to date are 221 endemic bird areas, which have unusual concentrations of restricted-range bird species (Bibby *et al.* 1992), and 234 centres of plant diversity, which have exceptional degrees of plant species richness and endemism (WWF and IUCN 1994–5).

Perhaps the most institutionalized system for ranking species-based conservation priorities is the one developed by The Nature Conservancy for use by its Natural Heritage programmes in all 50 US states and in Conservation Data Centres in 13 Latin American countries and several Canadian provinces (see Box 13.2-2), but there are numerous others.

A growing number of the Specialist Groups under the IUCN Species Survival Commission have developed ranking systems to evaluate the conservation needs for species, populations and habitats for distinct groupings of wild animal and plant species (Eudey 1987; Schreiber *et al.* 1989; Cumming *et al.* 1990; Stuart *et al.* 1990). Hawkes (1988) has developed a system for ranking economically useful plants.

Species-based approaches have a number of advantages. They allow one to focus selectively on the elements of biodiversity that are most endangered, or those that are most valued from a particular perspective. For example, the conservation of agricultural diversity relies on species-based approaches since ecosystem-based approaches do not pinpoint agriculturally important species, varieties or populations. Moreover, a focus on certain species may result in many others also being conserved. Examples include 'keystone species', which have a critical role in whole ecosystems, and 'charismatic megavertebrates', which are large and spectacular, and attract public attention. It is often easier to mobilize public opinion in support of such species than for more subtle ecosystem conservation priorities.

One problem with using species-based approaches to setting priorities is that the knowledge of variation at the species level and below is often poor. Therefore, it is difficult to conserve the representative genetic variation within a species. Another problem with species-based approaches is that action may occur only after it has been determined that a species is endangered – when it is too late or too costly to save a broad sample of the genetic

Box 13.2-2: Natural Heritage System priority ranking.

The Natural Heritage System uses a priority-ranking system to identify elements of natural diversity – plant and animal species, subspecies, and natural communities or habitats – that are most important for conservation. In practice, the ranking scheme is used primarily with species of vertebrates and plants (Master 1991). The species ranks are based on information about each species for a series of criteria including the known or estimated number, quality and condition of element occurrences (i.e. locations of sub-populations of the species); the estimated number of individuals; narrowness of range and habitat; trends in population and habitat; threats to the element; the element's fragility; and other factors (Master 1991). Using a 1–5 scale, this information is then used to assign a rank to the species at three separate scales – global, national, and state or province.

When the global, national and sub-national ranks are combined, the system allows for a rapid assessment of the species' known or probable threat of extinction or extirpation in a particular jurisdiction. For example, a species ranked G5/N2/S1 is extremely vulnerable to extirpation at the state or provincial level, vulnerable (but not critically) at the national level, and widespread and abundant globally with no threat of extinction.

In practice, The Nature Conservancy and its partners do not use the ranking system alone to set priorities. With each species or element record, information is included on recommendations for protection, inventory, research and management. These recommendations are frequently based on a number of site-specific facts and qualitative assessments of the species conservation needs and are crucial determinants of follow-up actions. In most cases, conservation actions are not directed at an individual species but instead focus on sites that have more than one priority species. To choose among such sites, The Nature Conservancy uses a 1–5 scale to assess 'site biodiversity significance ranks' and 'site protection urgency ranks'. The former focus on the overall condition, viability and representativeness of the sub-population while the latter assess the relative threat of destruction to the site.

variability of the species' populations. If entire ecosystems are threatened, not merely isolated species, the ecosystem approach is often preferred. Species-based approaches, however, need not be applied only when the species has become critically endangered.

Most species-based approaches to conservation assume that all species are taxonomically equivalent. For example, when species richness is used to identify priorities, each species is given equal weight as decisions are made about where to focus conservation efforts. This assumption is troubling for many biologists who believe that some species are more important than others. In particular, conserving species that are the only representatives of a genus, family or higher taxonomic group will do more to conserve biodiversity than saving species with many close relatives at the genus or family level (see also Section 7).

In recent years, a number of approaches to setting priorities have used systematics (the study of genetic and evolutionary relationships between species) as a major tool for determining conservation priorities. The key difference from other species-based approaches is that elements of biodiversity (i.e. species) are assigned value based on their taxonomic distinctiveness. In other words, given two highly threatened taxa, one a species not closely related to other living species (e.g. the panda), and one species closely related to other more common species (e.g. the Kirtlands warbler), it is the more taxonomically distinct panda that would be accorded higher priority.

Using cladistic analysis – classifying organisms on the basis of evolutionary relationships – and quantitative weighting techniques, a growing number of approaches have been developed to identify priorities, at least partly, on the basis of taxonomic distinctiveness (see Daugherty *et al.* 1990; May 1990; Vane-Wright *et al.* 1991, 1994; Faith 1994; Forey *et al.* 1994).

WORLDMAP is an example of a priority-setting tool based on the evaluation of taxonomic relationships (Williams and Humphrey 1994). It uses a specialized geographic information system (GIS) to identify iteratively the minimum number of areas to represent all distinct taxa (sometimes referred to as ‘attributes’ by systematists) within a region. Similar programmes, such as DIVERSITY (Faith and Walker 1994), CODA (Pressey *et al.* 1994) and ERMS (Margules *et al.* 1994), are being tested for the design of protected area networks and land-use suitability classification, particularly in Australia.

The use of systematics in priority-setting efforts is appealing because it provides a firm biological and evolutionary basis for conservation. Such approaches have the potential to maximize the conservation of evolutionary pathways that more traditional species-based approaches do not. The combination of quantitative measures of taxonomic distinctness with more familiar ecological considerations of abundance and geographic distribution is important for future conservation efforts (May 1990).

There are, however, serious limitations to using quantitative measures of species relationships to identify priorities (Johnson 1995). First, such approaches are even more limited by a lack of information than species-based

approaches – the cladistic relationships of the vast majority of organisms are unknown. Second, cladistic approaches are concerned mainly with conserving a representative genetic legacy of evolutionary history. While this is an important conservation objective, biodiversity has many conservation and use values that are independent of evolutionary history and taxonomic distinctiveness. Advances in systematics and the growing interest of systematists in conservation, however, suggest that the use of systematic tools to determine conservation priorities, in combination with other types of species- and ecosystem-based analysis, will expand in coming years.

Genetic- and species-based approaches to setting comprehensive conservation priorities are severely constrained by inadequate information for most areas of the world and for most species. Not only are there many more species than we thought there were ten years ago (see Section 3), but we have not been keeping up with the conservation needs of the few thousand known to be endangered. The rescue of those species has proved to be difficult, often ineffective, and extraordinarily expensive (Reid 1992). For these and other reasons, some approaches to setting conservation priorities are based on ecosystem or biogeographic classifications.

13.2.4 Ecosystem-based methods for establishing priorities

Ecosystem approaches to setting biodiversity-conservation priorities generally seek to protect most species within conservation areas that are representative of a region's natural habitats. Ecosystem approaches for identifying conservation priorities use multiple criteria such as species richness, endemism, abundance, uniqueness and representativeness, as well as considerations of the physical environment, ecological processes and disturbance regimes that help to define ecosystems.

The basic objective of most ecosystem-based approaches is to conserve the range of ecological conditions found within the geographic scale of interest. Ecosystem-based approaches are sometimes favoured because they can be used as a surrogate for detailed species knowledge. But ecosystem-based approaches also have value since they can protect habitats that might never be considered by species-based approaches. For example, ecological approaches may identify sites such as migratory resting and feeding habitats, or important areas for the exchange of energy and nutrients such as mangrove forests, which species-based approaches overlook. Ecosystem-based approaches therefore can include areas with ecological functions vital to biodiversity – areas not readily captured in priority analyses based on a species approach.

Ecosystem-based priority-setting has advanced considerably in recent years. For example, Dinerstein *et al.* (1995) have developed methods for assessing the

conservation potential of ecoregions in the Latin American and Caribbean area. The intention of this work is to build up a layered model of each ecoregion incorporating landscape features, patterns of species richness and endemism, critical habitats and protected areas, management activities, human demography, and other social, economic and political factors that collectively influence conservation priorities for the ecoregion. This approach builds upon existing analyses while also incorporating much additional information. A different approach, which relies on the use of expert opinion, has been developed by Conservation International (Olivieri *et al.* 1995) and collaborating national and local organizations to rapidly assess priorities within a major biome or biogeographic region (for example, the Atlantic coastal forest in Brazil). Teams of experts review existing data and integrate their own experience and knowledge to develop priorities for major taxonomic groups which are then synthesized into a set of priorities for action.

Ecosystem-based approaches to setting conservation priorities have a number of strengths. For example, if representative ecosystems are conserved in large areas, the vast majority of species and much of their genetic diversity will be protected. In addition, ecological processes (e.g. nutrient cycling, hydrological regulation, micro- and meso-climatic regulation, and the maintenance of disturbance regimes upon which many species depend) are essential to the survival of many species. Only ecosystem-based approaches are likely to ensure the protection of these vital links to biodiversity. Finally, ecosystem-based approaches help conservation to protect biodiversity across a full range of habitats and across a broad geographic spectrum that species-based approaches to conservation may overlook. If little is known about species distributions and endangerment, ecosystem-based approaches are the only realistic option for analysis.

Several problems are encountered in efforts to set priorities on an ecosystem basis. For example, what constitutes a 'natural' ecosystem? Many ecosystem-based approaches attach priority to natural habitats (e.g. MacKinnon and MacKinnon 1986a). In reality, however, all ecosystems have been influenced to varying degrees by human activity, ranging from the impact of global pollution to that of historical hunting, logging, farming or grazing. In some areas, such as Europe, the Mediterranean and Japan, virtually all ecosystems show signs of heavy modification by millennia of human use.

Nevertheless, it remains useful for many purposes to distinguish between 'natural' and 'artificial' habitats. The former are those dominated by indigenous species living in approximately the same proportions as would be expected in the absence of human interference, or are in the process of returning to those proportions following human disturbance, and which meanwhile comprise a viable

reservoir of indigenous species and gene pools (Caldecott 1995). Artificial habitats, by contrast, are those dominated by introduced species, or by built environments, or by indigenous species occurring in relative abundance that have been grossly altered by people (e.g. forest plantations).

Ecosystem-based priority-setting is constrained by the fact that ecosystems vary greatly and are poorly understood. Ecosystems are difficult to define since their size, composition, complexity and distribution change with scale in both time and space. Not surprisingly, ecologists differ in their descriptions and definitions of ecosystems: despite many attempts to classify them, there is still no internationally recognized standard. Most countries are still without a consensus classification scheme, although there are efforts in some, such as Australia, to develop 'biogeographic regionalizations' based on attributes of climate, geology, landform, vegetation, flora, fauna and land use (Margules *et al.* 1994).

Finally, ecosystem-based approaches to identifying priorities usually fail to include all rare or potentially endangered species. Localized species will sometimes be left out of priorities determined by ecosystem analysis, especially in the tropics where most species ranges are typically small. There will always be some need for individual species-protection programmes, even if comprehensive ecosystem protection or management programmes are implemented.

13.2.5 Integrative approaches for establishing priorities

Since Aristotle, science has often had a tendency to break down complex phenomena into component parts and treat them as if they have little relationship to each other. Biodiversity thus becomes genes, populations, species, communities and ecosystems, each with its separate constituent biological disciplines. The natural world is often viewed as standing quite apart from the human world – uncorrupted in the view of some, unharnessed in the view of others. Conservation priorities have frequently reflected these views: endangered species are to be protected in pristine natural habitats, protected areas sanitized of human influence.

However, during the past decade, reductionist ways of viewing nature and its biological composition have been challenged. Many ecologists, for example, believe biodiversity can be understood only by looking at all of the hierarchical levels and their interactions. At the same time, advances in ecology, palaeobiology and conservation biology are calling into question the very meaning of a 'natural' ecosystem. This has prompted some to go so far as to state that the overarching goal of ecological management should be to maximize human capacity to adapt to changing ecological conditions (e.g. Reid 1994), not some romantic notion of maintaining natural 'biological integrity'.

The more holistic views of biology, together with the realization that humans are almost everywhere an integral part of ecosystems, have begun to influence the way in which biodiversity–conservation priorities are set. These views emphasize the role that non-biological factors must play in setting conservation priorities, as well as the need to use diversified strategies that adapt to the myriad cultures and value systems around the world.

To accommodate the dynamic nature of ecosystems, integrative approaches to identifying biodiversity priorities emphasize looking across the entire landscape – protected and unprotected, natural and heavily modified. Such approaches seek to enhance the contribution biodiversity makes to human welfare, in addition to protecting certain areas from human activities. They emphasize the use of multiple biological and non-biological criteria. The objectives of such approaches are not only the preservation of biodiversity for its own sake, but maximizing life's capacity to adapt to changing conditions (e.g. climate change, sea-level change, altered species compositions, etc.). Often, it may be social, not biological, issues (the desire to have an environment that supports human welfare) that are the unifying force behind integrative approaches to identifying biodiversity conservation priorities. In practical terms, this means setting priorities in the human-dominated landscapes that are found over two-thirds of the Earth's land surface, and includes consideration of biodiversity conservation needs in urban and suburban environments (see McNeely *et al.* 1990).

Very few methods have been developed to identify conservation priorities outside of strictly 'natural' landscapes. Those that do exist are not so much methodologies for setting conservation priorities as criteria for assessing the social value of biodiversity in the landscape.

Perhaps the greatest limitation to the integrative approaches is that they may de-emphasize biodiversity values relative to other social, economic and political values. The consideration of non-biological factors as co-variables with biological factors can make it difficult to say whether a chosen priority is important mainly because of its biological values or because of the contribution of other variables. And, even where careful attention is paid to protecting the biological resources, it can be unclear which social, economic or political criteria are most important to conservation.

The main advantage of integrative approaches is that they link biodiversity to other natural resources and the values humans attach to them. This means that selected priorities will often have non-biological values that could strengthen political support for conservation actions. For example, a priority area that has significant watershed value or tourism potential (in addition to biodiversity value) may be more socially and politically viable than an

area selected solely for its biodiversity values. Integrative approaches, therefore, may minimize the narrowing of conservation priorities that often takes place when strictly biologically-based priorities are considered by policy-makers who are concerned about the economic, social or political implications of their decisions.

13.2.6 Experience in setting geographically-based priorities

The most visible efforts to establish conservation priorities in recent years have centred on identifying those parts of the world with the greatest biodiversity. These efforts are driven by several considerations.

1. Biodiversity is unevenly distributed around the world, with some nations having greater diversity than others, just as within a nation some ecosystems have more species than others.
2. Biological resources found in one area can have values of international or global significance, especially in terms of genetic resources for agriculture and pharmaceuticals.
3. Most of the world's species are found in the tropics where countries with limited capacity (e.g. personnel, institutions, facilities and funding) face enormous pressures on their biological resources.
4. Conserving biodiversity will require international investments to share the cost of maintaining biological resources whose benefits often flow beyond national borders.

Priority-setting schemes for identifying areas or sites of high conservation value based on a global or wide regional analysis have been developed by a number of authors. Some of these approaches include the 'hotspots' approach (Myers 1988, 1990), the 'megadiversity' countries approach (Mittermeier and Werner 1990), the conservation threat/potential approach (Dinerstein and Wikramanayake 1993), and an integrated priority-setting framework developed by a consortium of international conservation groups organized by the Biodiversity Support Program (BSP *et al.* 1995).

National and local biodiversity–conservation priority-setting has not received the level of attention that international priority setting has received. Relatively few countries have clearly defined conservation priorities, and even fewer have consensus priorities that are actively used to guide conservation activities or direct government and donor resources.

There are, however, a growing number of cases where priority-setting efforts have been applied specifically to influence the allocation of biodiversity-management resources at national or regional levels. These include reviews of protected area systems in the Afro-Tropical,

Indo-Malayan and Oceanian realms (MacKinnon and MacKinnon 1986a, b; Dahl 1986) which continue to be reviewed and updated (e.g. Braatz *et al.* 1992; SPREP 1992; MacKinnon 1994). Numerous national initiatives have also been undertaken including efforts in Brazil (IBAMA *et al.* 1991), Papua New Guinea (Swartzendruber 1993), Bulgaria (BSP 1994), the United States (Scott *et al.* 1993), Russia (Krever *et al.* 1994), Australia (Margules *et al.* 1994; Pressey *et al.* 1994), New Zealand (Atkinson 1994) and India (Daniels *et al.* 1991).

This work can be used to focus attention on sites that are consistently identified as being of special importance for biodiversity. Thus, there are already lists from some countries of sites that must be protected or managed sustainably if key components of their national biodiversity resources are to be retained. An example is provided by the 80–90 sites in Indonesia that were identified as vital by the country's National Conservation Plan (FAO 1982), and later studies by the Ministry of Transmigration (RePPProt 1990), the Ministry of Forests (MoF/FAO 1991), the Ministry for Environment (Government of Indonesia 1992) and the National Development Planning Agency (Government of Indonesia 1993). Locations where national and international priorities coincide in this way are logical candidates for investment in biodiversity management and protection.

Nearly all efforts to set priorities have focused on terrestrial areas, and marine ecosystems have been largely neglected. This probably reflects the terrestrial bias of biodiversity management in general. Priority-setting for coastal and marine biodiversity has also been hampered by a lack of biogeographic classification for marine ecosystems. Recent efforts have begun to address this problem at a global level.

The IUCN's Commission on National Parks and Protected Areas (CNPPA), the Great Barrier Reef Marine Park Authority (GBRMPA), and the World Bank launched an ambitious project in 1991 to identify priority areas for the conservation of marine biodiversity (Kelleher *et al.* 1995). The ultimate goal of the project – consistent with resolutions passed at major conservation forums such as the 1988 IUCN General Assembly – is to establish a global network of protected areas that includes all of the world's distinct marine ecosystems.

The CNPPA developed its own system based on biogeographical considerations (i.e. physical, vegetational and faunal characteristics) and political boundaries. The world's marine areas were divided into 18 regions, such as the wider Caribbean, Mediterranean, Southeast Pacific and Northeast Pacific. In the future, a better system based, for example, on the Large Marine Ecosystem (LME) concept (see Sherman and Laughlin 1992) may become available.

The CNPPA regional priorities for establishing or strengthening marine protected areas are limited to the dozen or so actions needed to conserve a representative

sample of all biogeographic zones within a regional network of MPAs. National priorities for new and strengthened MPAs are generally more numerous, depending on how comprehensive existing national MPA systems are. These areas have been mapped on a GIS database of the 18 marine regions by the World Conservation Monitoring Centre and will be available to any interested users.

The World Bank, which supported the CNPPA project, hopes to begin collaborating with governments, other bilateral and multilateral donor agencies, and NGOs to implement regional and national MPA projects. Eventually, these efforts will lead to the development of a globally representative network of MPAs as envisioned in the CNPPA report.

Although governments and donors are investing more in priority-setting efforts, it is not clear to what extent the resulting priorities influence decisions about where to invest resources in conservation and sustainable use activities. The MacArthur Foundation has invested US\$60 million since 1988 in biodiversity conservation programmes in eight priority geographic areas based largely on the Myers (1988) biodiversity hotspots (MacArthur Foundation 1995). Most private foundation donors, however, do not appear to use systematically derived priorities to allocate financial resources. Support by governments and bilateral and multilateral donors for geographic priority-setting is just beginning (see, for example, WCMC 1994; WWF 1994; Rojas and Valejo 1994; BSP *et al.* 1995). This support may signal that donors and governments are prepared to use well-established priorities to guide their activities and funding. However, the limited and recent experience with priorities thus far makes this difficult to assess.

13.2.7 Principles for geographic priority-setting

The most effective actions to conserve biodiversity will take place at the national, and even more so at the local, level. National and local capacities for the conservation and sustainable use of biodiversity are limited everywhere, especially in developing countries. Given these constraints, setting priorities at the national and local levels will have the greatest effect and should help influence and strengthen priorities set from an international perspective, increasing the use of international support resources. Priorities set at these levels are indispensable because they are more likely to:

- focus on specific conservation and sustainable-use objectives;
- specify species, ecosystems or sites;
- reflect national and local values and needs; and
- provide greater opportunity for participation by national and local government agencies, NGOs and communities.

The links between nationally and locally set priorities and actions on the ground are more direct than links between international priorities and site-specific management actions. Nationally determined priorities also indicate to international donor agencies and conservation organizations which ecosystems, habitats and species are considered most important from a national perspective, some of which may also be of international significance (e.g. potential World Heritage Sites, RAMSAR sites, biosphere reserves, etc.). In any case, most internationally set priorities, such as biodiversity 'hotspots' (Myers 1988, 1990) depend on further elaboration at national and local levels.

Johnson (1995) provides a simple set of principles to guide priority-setting processes for maximum effect (see Box 13.2-3). Several of the principles address the political need for participation and consultation in the priority-setting process. Others address largely technical considerations, and one or two might simply go under the heading of 'common sense'. A more extensive set of principles developed by participants at the 1992 Systematics and Conservation Evaluation Workshop held in London (see Forey *et al.* 1994 for papers presented) is summarized by Sullivan (1992).

Box 13.2-3: Principles for setting biodiversity conservation priorities.

1. Link biodiversity priorities with clear conservation goals and objectives.
2. Use a replicable, transparent process to develop credible priorities.
3. Clarify local, national and global biodiversity conservation priorities.
4. Evaluate the advantages and disadvantages of any chosen priority-setting scheme.
5. Make full use of relevant and available information.
6. Involve those responsible for implementing conservation actions in the priority-setting process.
7. Involve other constituencies, including local communities, in the priority-setting process.
8. Establish a process to revise or reassess priorities at regular intervals.
9. Consider how priorities fit in a policy and institutional context.
10. Link conservation priorities to other planning and policy processes such as national biodiversity strategies and action plans.

Source: Johnson (1995).

13.2.8 Conclusion

Several issues in particular are vital to using priority-setting effectively to support policies and strategies to sustainably use and conserve biodiversity (Johnson 1995). First, explicit objectives are essential both to provide guidance to the priority-setting process and to make clear which elements of biodiversity are included in the priorities and which are not. Second, biodiversity is important everywhere, and biogeographic representation should be an objective of initial efforts to set priorities. Third, the conservation of biodiversity is less a question of biology than of social, economic and political factors. Therefore, while priorities must be scientifically sound, their proponents should consider how priorities can have an impact in the social context in which conservation decisions are made. Fourth, priority setting must become an integral part of national biodiversity strategies, action plans and related policy and planning processes. This will require investing in national capacities to develop and implement comprehensive conservation priorities. At the international level, priority-setting should complement but not supersede nationally and locally determined biodiversity conservation priorities.

Most importantly, successful implementation of conservation priorities ultimately depends on the support of important biodiversity stakeholders – the public, and various government agencies – all of whom have social, economic and political needs they consider at least as important as maintaining biodiversity. The best way to ensure that priority-setting both informs and is informed by the range of actors who influence the fate of biodiversity is to develop an effective process for setting priorities. An effective priority-setting process, notwithstanding its technical integrity, is one that starts with clearly defined conservation goal(s) and objectives, is guided by the widest possible array of relevant information, provides opportunities for a wide range of government, academic, NGO, social and private sector institutions to be consulted or involved, and links priorities to discrete institutions, actions and constituencies.

Although biodiversity conservation priorities are most often intended to lead to the establishment of new protected areas, endangered species programmes, or *ex-situ* conservation programmes, geographically defined priorities can be used in other ways as well. For example, information on species and ecosystem distribution and trends, habitat quality, and human land-use and demographic patterns, could be correlated to land tenure and other policies (e.g. tax, agricultural subsidies, etc.) that contribute to ecological degradation. This would allow priority-setters to identify specific policy reforms that could help to sustainably use and conserve biodiversity outside traditional protected areas.

Similarly, cultural/demographic/land-use data (in conjunction with species and ecosystem information) could

be used to identify biologically important areas where people use natural resources in ways that are relatively compatible with biodiversity conservation. Strategies could then be developed to encourage the preservation of such land uses and protect them from rapid and ecologically destructive change.

There is no single formula for developing effective biodiversity conservation priorities. The process of setting priorities will vary between countries according to available information, local perceptions and development objectives. Priority-setting will increase in sophistication and more effective approaches and processes will emerge in the coming years. However, as WCMC (1994) notes, 'For most countries and the world as a whole. . . there is sufficient information on species richness and endemism to allow realistic decisions to be made on where these attributes are likely to be most pronounced, and where investment in safeguarding them would be most effective'. Priority-setting and revising earlier priorities will be a recurrent activity, not a one-time event. Therefore investments in building the information base, making appropriate technologies available (e.g. computer mapping and databases), defining participatory mechanisms, and training, will have long-term value and contribute significantly to the conservation and sustainable use of biodiversity, particularly if policy makers and donors pay attention.

References

- Abramovitz, J.N.** 1994. *Trends in Biodiversity Investments*. World Resources Institute, Washington, DC.
- Atkinson, I.** 1994. Ecological measures for conserving terrestrial biodiversity: a New Zealand perspective. In: Forey, P.L., Humphries, C.J. and Vane-Wright, R.I. (eds), *Systematics and Conservation Evaluation*. 63–80. Clarendon Press, Oxford.
- Bibby, C.J., Crosby, M.J., Heath, M.F., Johnson, T.H., Long, T.H., Sattersfield, A.J. and Thirgood, S.J.** 1992. *Putting Biodiversity on the Map: Global priorities for conservation*. International Council for Bird Preservation, Cambridge.
- Braatz, S., Davis, G., Shen, S. and Rees, C.** 1992. *Conserving Biological Diversity: A strategy for protected areas in the Asia-Pacific region*. World Bank Technical Paper No. 193. The World Bank, Washington, DC.
- BSP.** 1994. *Conserving Bulgaria's Biological Diversity: The Bulgarian National Biological Diversity Conservation Strategy*. Biodiversity Support Program, Washington, DC.
- BSP/CI/TNC/WCS/WRI/WWF.** 1995. *A Regional Analysis of Geographic Priorities for Biodiversity Conservation in Latin America and the Caribbean*. Biodiversity Support Program, Washington, DC.
- Caldecott, J.O.** 1995. *Designing Conservation Projects*. Cambridge University Press, Cambridge (in press).
- Cumming, D.H., DuToit, R.F. and Stuart, S.N.** 1990. *African Elephants and Rhinos: Status survey and conservation action plan*. IUCN Species Survival Commission African Elephant and Rhino Specialist Group. IUCN, Gland.
- Dahl, A.L.** 1986. *Review of the Protected Areas System in Oceania*. IUCN/UNEP, Gland.
- Daniels, R.J., Hegde, M., Joshi, N.V. and Gadgil, M.** 1991. Assigning conservation value: a case study from India. *Conservation Biology* 5: 464–475.
- Daugherty, C.H., Cree, A., May, J.M. and Thompson, M.B.** 1990. Neglected taxonomy and continuing extinctions of tuatara (*Sphenodon* spp.). *Science* 347: 177–179.
- Diamond, J.** 1989. Overview of recent extinctions. In: Western, D. and Pearl, M. (eds), *Conservation for the Twenty-first Century*, 37–41. Oxford University Press, New York.
- Dinerstein, E., Olson, D.M., Graham, D.J., Webster, A.L., Primm, S.A., Bookbinder, M.A. and Ledec, G.** 1995. *A Conservation Assessment of the Terrestrial Ecoregions of Latin America and the Caribbean*. The World Bank, Washington, DC.
- Dinerstein, E. and Wikramanayake, E.** 1993. Beyond 'Hotspots': how to prioritize investments to conserve biodiversity in the Indo-Pacific region. *Conservation Biology* 7: 53–65.
- Eudey, A.A.** 1987. *Action Plan for Asian Primate Conservation: 1987–1991*. IUCN Species Survival Commission Primate Specialist Group. IUCN, Gland.
- Faith, D.P.** 1994. Phylogenetic diversity: a general framework for the prediction of feature diversity. In: Forey, P.L., Humphries, C.J. and Vane-Wright, R.I. (eds), *Systematics and Conservation Evaluation*. 251–267. Clarendon Press, Oxford.
- Faith, D.P. and Walker, P.A.** 1994. *DIVERSITY: A Software Package for Sampling Phylogenetic and Environmental Diversity: A reference and user's guide*. Commonwealth Scientific and Industrial Research Organization (CSIRO) Division of Wildlife and Ecology, Canberra, Australia.
- Falk, D.A. and Holsinger, K.E.** 1991. *Genetics and Conservation of Rare Plants*. Oxford University Press, New York.
- FAO.** 1982. *National Conservation Plan for Indonesia*. United Nations Food and Agriculture Organization, Bogor, Indonesia.
- Forey, P.L., Humphries, C.J. and Vane-Wright, R.I. (eds)** 1994. *Systematics and Conservation Evaluation*. Clarendon Press, Oxford.
- Government of Indonesia.** 1992. *Indonesian Country Study on Biological Diversity*. Ministry of State for Population and Environment, Jakarta.
- Government of Indonesia.** 1993. *Biodiversity Action Plan for Indonesia*. Ministry of State for Population and Environment, Jakarta.
- Hamilton, L.S. (ed.)** 1993. *Ethics, Religion and Biodiversity: Relations between conservation and cultural values*. The White Horse Press, Cambridge, UK.
- Hartl, D.L., and Clark, A.G.** 1990. *Principles of Population Genetics*. Sinauer Associates, Sunderland, Mass.
- Hawkes, J.G.** 1988. *Ranking Plants of Economic Value for Conservation and Development*. A feasibility study for the IUCN Plants Conservation Office, Richmond, Surrey, UK.
- IBAMA/INPA/CI.** 1991. Workshop 90: Biological priorities for conservation in Amazonia. Map and legend prepared from January 1990 conference in Manaus sponsored by IBAMA, INPA, Conservation International, the New York Botanical Garden, the Smithsonian Institution, and the Royal Botanical Gardens. Conservation International, Washington, DC.
- Johnson, N.** 1995. *Biodiversity in the Balance: Approaches to*

- setting geographic conservation priorities. Biodiversity Support Program, Washington, DC.
- Kelleher, G., Bleakley, C. and Wells, S.** 1995. *A Global Representative System of Marine Protected Areas*. Great Barrier Reef Marine Park Authority (Australia) and IUCN Commission on National Parks and Protected Areas, Gland.
- Kremer, V., Dinerstein, E., Olson, D. and Williams, L.** 1994. *Conserving Russia's Biological Diversity: An analytical framework and initial investment portfolio*. World Wildlife Fund/US, Washington, DC.
- Ledig, F.T.** 1988. The conservation of diversity in forest trees. *BioScience* **38**: 471–479.
- MacArthur Foundation.** 1995. Update Memo: World Environment and Resources Program. No. 11. MacArthur Foundation, Chicago.
- MacKinnon, J.** 1994. *Analytical Status Report of Biodiversity Conservation in the the Asia-Pacific Region*. Asian Bureau for Conservation, Hong Kong.
- MacKinnon, J. and MacKinnon, K.** 1986a. *Review of the Protected Areas System in the Indo-Malayan Realm*. IUCN/UNEP, Gland.
- MacKinnon, J. and MacKinnon, K.** 1986b. *Review of the Protected Areas System in the Afro-tropical Realm*. IUCN/UNEP, Gland.
- McNeely, J., Miller, K.R., Reid, W.V., Mittermeier, R.A. and Werner, T.B.** 1990. *Conserving the World's Biological Diversity*. World Resources Institute, IUCN, World Bank, World Wildlife Fund, Conservation International. Washington, DC and Gland.
- Margules, C.R., Cresell, I.D. and Nicholls, A.O.** 1994. A scientific basis for establishing networks of protected areas. In: Forey, P.L., Humphries, C.J. and Vane-Wright, R.I. (eds), *Systematics and Conservation Evaluation*. 327–350. Clarendon Press, Oxford.
- Master, L.L.** 1991. Assessing threats and setting priorities for conservation. *Conservation Biology* **5**: 559–563.
- May, R.M.** 1990. Taxonomy as destiny. *Science* **347**: 129–130.
- Miller, K.R. and Lanou S.** 1995. *National Biodiversity Planning: Guidelines from early experience worldwide*. World Resources Institute, Washington, DC.
- Mittermeier, R.A. and Werner, T.B.** 1990. Wealth of plants and animals unites 'megadiversity' countries. *Tropicus* **4** (1): 1, 4–5.
- Mlot, C.** 1989. Blueprint for conserving plant diversity. *BioScience* **39**: 364–368.
- MoF/FAO.** 1991. *Indonesian Tropical Forestry Action Programme*. Ministry of Forestry and the United Nations Food and Agriculture Organization, Jakarta.
- Myers, N.** 1988. Threatened biotas: 'hotspots' in tropical forests. *Environmentalist* **8** (3): 1–20.
- Myers, N.** 1990. The biodiversity challenge: expanded 'hotspots' analysis. *Environmentalist* **10** (4): 243–256.
- Olivieri, S., Bowles, I.A., Cavalcanti, R.B., da Fonseca, G.A.B., Mittermeier, R.A. and Rodstrom, C.B.** 1995. *A Participatory Approach to Biodiversity Conservation: The regional priority-setting workshop*. Conservation International, Washington, DC.
- Pressey, R.L.** 1994. Land classifications are necessary for conservation planning but what do they tell us about fauna? In: Lunney, D., Hand, S., Reed, P. and Butcher, D. *Future of the Fauna of Western New South Wales*. 31–41. Royal Zoological Society of New South Wales, Sydney.
- Pressey, R.L., Bedward, M. and Keith, D.A.** 1994. New procedures for reserve selection in New South Wales: maximizing the chances of achieving a representative network. In: Forey, P.L., Humphries, C.J. and Vane-Wright, R.I. (eds), *Systematics and Conservation Evaluation*. 351–373. Clarendon Press, Oxford.
- Reid, W.V.** 1992. How many species will there be? In: Whitmore, T.C. and Sayer, J.A. (eds), *Tropical Deforestation and Species Extinction*. 55–74. Chapman Hall, London.
- Reid, W.V.** 1994. Setting objectives for conservation evaluation. In: Forey, P.L., Humphries, C.J. and Vane-Wright, R.I. (eds), *Systematics and Conservation Evaluation*. 1–14. Clarendon Press, Oxford.
- RePPProt.** 1990. *A National Overview from the Regional Physical Planning Program for Transmigration*. Ministry of Transmigration, Jakarta.
- Rojas, M. and Vallejo, N.** 1994. Establishing priorities for the conservation and sustainable use of biological diversity. Paper presented at the Second Global Biodiversity Forum, Nassau, Bahamas, 26–27 November 1994. IUCN, Gland.
- Schonewald-Cox, C.M., Chambers, S.M., MacBryde, B. and Thomas, L.** (eds) 1983. *Genetics and Conservation: A reference for managing wild animal and plant populations*. Benjamin/Cummings, Menlo Park, Calif.
- Schreiber, A., Wirth, R., Riffel, M. and Van Rompaey, H.** 1989. *Weasels, Civets, Mongooses, and their Relatives*. IUCN Species Survival Commission Mustelid and Viverrid Specialist Group. IUCN, Gland.
- Scott, J.M., Davis, F., Csuti, B., Noss, R.F., Butterfield, B., Grovers, C., Anderson, H., Caicco, S., D'Erchia, F., Edwards, C., Ulliman, J. and Wright, R.G.** 1993. Gap analysis: a geographic approach to protection of biological diversity. *Ecological Monographs* **123**: 1–41.
- Shenji, P., and Sajise, P.** 1995. *Regional Study on Biodiversity: Concepts, frameworks and methods*. Yunnan University Press, Kunming, China.
- Sherman, K. and Laughlin, T.** 1992. *The Large Marine Ecosystem (LME) concept and its application to regional marine resources management*. Marine Conservation Development Reports. IUCN, Gland.
- SPREP.** 1992. *The South Pacific Biodiversity Conservation Programme*. South Pacific Regional Environment Programme, Apia, Western Samoa.
- Stuart, S.N., Adams, R.J. and Jenkins, M.D.** 1990. *Biodiversity in Sub-Saharan Africa and its Islands: Conservation, management, and sustainable use*. IUCN Species Survival Commission, Gland.
- Sullivan, T.** 1992. Beyond hotspots: new approaches to setting priorities for the conservation of biodiversity. *Species* **18**: 13–15.
- Swartzendruber, J. F.** 1993. *Papua New Guinea Conservation Needs Assessment: Synopsis report*. Biodiversity Support Program, Washington, DC.
- Vane-Wright, R.I., Smith, C.R. and Nicholls, A.O.** 1994. Systematic assessment of taxic diversity by summation. In:

- Forey, P.L., Humphries, C.J. and Vane-Wright, R.I. (eds), *Systematics and Conservation Evaluation*. 327–350. Clarendon Press, Oxford.
- Vane-Wright, R.I., Humphries, C.J. and Williams, P.H. 1991. What to protect: systematics and the agony of choice. *Biological Conservation* 55: 235–254.
- WCMC. 1994. *Priorities for Conserving Global Species Richness and Endemism*. World Conservation Monitoring Centre, Cambridge.
- Woodruff, D.S. 1992. *Biodiversity Conservation and Genetics*. Proceedings of the 2nd Princess Chulabkorn Congress of Scientific Technology, Bangkok.
- Williams, P.H. and Humphries, C.J. 1994. Biodiversity, taxonomic relatedness, and endemism in conservation. In: Forey, P.L., Humphries, C.J. and Vane-Wright, R.I. (eds), *Systematics and Conservation Evaluation*. 269–287. Clarendon Press, Oxford.
- WWF. 1994. *Interim Measures for Conserving Biological Diversity*. World Wildlife Fund/UK, Godalming, Surrey, UK.
- WWF and IUCN. 1994–1995. *Centres of Plant Diversity: A guide and strategy for their conservation*. Vol. 1 (1994) (Europe, Africa, The Middle East and Southwest Asia). Vol. 2 (1995), Asia and the Pacific. Vol. 3 (in press), The Americas. World Wildlife Fund/UK, Godalming, and the World Conservation Union/IUCN, Gland.

13.3 Measures for sustainable use of biodiversity in natural resource management

13.3.1 Introduction

Human uses of biological resources, as discussed in Section 11, generally lead to the simplification of ecological systems and reduced biodiversity. Measures to maintain biodiversity, as a result, have frequently emphasized the separation of ecosystems, species and genetic resources from most human activities (e.g. establishment of protected areas, prohibitions on the harvesting of endangered species, preservation of germplasm in seed banks or cryogenic storage, etc.). However, it is simply not possible, nor in many cases desirable, to shield all genes, species and ecosystems from human influence. Human impacts have become part of the natural selection process and some components of biodiversity – agricultural genetic diversity, for example – owe their existence to human influence and manipulation.

Humans manipulate approximately 70% of the world's temperate and tropical ecosystems to produce 98% of their food and all of their wood products, according to Pimentel *et al.* (1992b), and only 5% of the temperate and tropical land area is totally uninhabited and unmanaged. Most terrestrial species, therefore, are found in the land area that is managed for agriculture, forestry and human settlements: in Germany, for example, only 35–40% of native species are found in protected areas (RSU 1985). Coastal and marine biodiversity is likewise predominantly found in areas where fishing and other human activities take place, albeit with less intensity and permanence than on land.

Therefore, maintaining biodiversity will depend on measures to use its components sustainably and to manage natural resources in ways that minimize adverse impacts on biodiversity. This chapter assesses methods that maintain biodiversity within the context of the human uses and management of natural resources including, among others, agriculture, forestry, fisheries, urban development and tourism. These measures take place within resource management systems in which the primary objectives are to use natural resources for human consumption and benefit, not the preservation of biodiversity *per se*. Measures in management systems where the principal objective is to preserve and restore biodiversity are presented in 13.4.

13.3.2 Managing biodiversity in agriculture

Agriculture – broadly defined to include cultivation of annual and perennial crops, animal husbandry, and grazing of domesticated livestock – depends on biodiversity for productivity and innovation. Plant and animal breeding, drawing on the genetic diversity of a handful of species in a variety of ecosystems, has enabled humans to develop thousands of domesticated varieties adapted to a wide range of environmental conditions and uses. Agricultural improvements, many of them based on the use and manipulation of biodiversity, have been the driving force behind human population growth and demographic change. And while agriculture has benefited enormously from biodiversity, its success has contributed increasingly to the loss of biodiversity. Land use for human food production now occupies over one-third of the world's land area – in 1991 cropland covered 11% of the world's land area, and permanent pasture 26% – and is the leading cause of habitat conversion on a global basis (WRI 1994).

Meeting the demands of an increasing world population and simultaneously maintaining biodiversity is an enormous challenge. To do so requires measures that:

1. conserve the genetic diversity found in existing domesticated plant and animal varieties and their related wild species;
2. identify and use wild species and genetic diversity to improve agricultural productivity and adaptability in the face of environmental change; and
3. minimize the adverse impacts of agricultural practices on agroecosystems and natural ecosystems.

Traditional and small-scale agriculture, especially in developing countries, is a major repository of agricultural genetic resources, and small farmers have played a major role as stewards of this legacy. Although small farmers have increasingly adopted relatively uniform modern high-yield crop varieties (HYVs), measures to use and maintain genetic diversity are still prominent in many traditional

agricultural systems, as discussed in 13.3.2.1. However, measures to use and conserve biodiversity sustainably within the context of large-scale/modern agricultural systems, as discussed in 13.3.2.2, will become increasingly important as these systems become more prevalent around the world. Measures to minimize conflicts between agricultural expansion and intensification and natural habitat conservation are presented in 13.3.2.3.

13.3.2.1 Managing biodiversity in traditional agriculture

Most of the world's farmers and most of the world's agricultural genetic diversity (see Figure 13.3-1) are found in developing countries where traditional farming systems are still common in many areas. Even in industrialized countries, traditional agricultural practices survive in some places. One of the distinguishing characteristics of these systems is their high degree of plant diversity in the form of polycultures and/or agro-forestry patterns. Subsistence farmers have traditionally minimized risk by planting several species and varieties of crops to stabilize yields over the long term.

Such practices have also served to promote diet diversity and maximize returns under low levels of external input and limited resources (Bartlett 1980; Altieri 1987). Tropical agro-ecosystems composed of agricultural and fallow fields, complex home gardens and agro-forestry plots commonly contain well over 100 plant species per field, which are used for construction materials, firewood,

tools, medicines, livestock feed and human food (Altieri and Hecht 1990; see also Section 11).

Genetic diversity in domesticated animals is also a common characteristic of traditional agricultural systems (Chacon and Gleissman 1982; Chang 1977).

Many traditional agro-ecosystems are located in major centres of crop diversity such as those first identified by the Russian botanist Vavilov in the 1930s and those more recently documented by Zeven and Zhukovsky (1975) and Harlan (1971). These centres contain most of the genetic diversity associated with major food crops (Prescott-Allen and Prescott-Allen 1983), and traditional agricultural systems in these areas maintain populations of variable and adapted landraces as well as wild and weedy relatives of crops.

For example, in the Andes, farmers cultivate as many as 50 potato varieties in their fields (Brush *et al.* 1981). Similarly, in Thailand and Indonesia, farmers maintain a diversity of rice varieties in their paddies, adapted to a wide range of environmental conditions, and regularly exchange seeds with neighbours (Altieri and Merrick 1987). The resulting genetic diversity heightens resistance to diseases that attack particular strains of the crop, and enables farmers to exploit different microclimates and soil conditions and derive multiple nutritional and other uses from genetic variation within species (Altieri 1987; Plucknett *et al.* 1987).

Many plants within or around traditional cropping systems are wild or weedy relatives of crop plants. Cycles

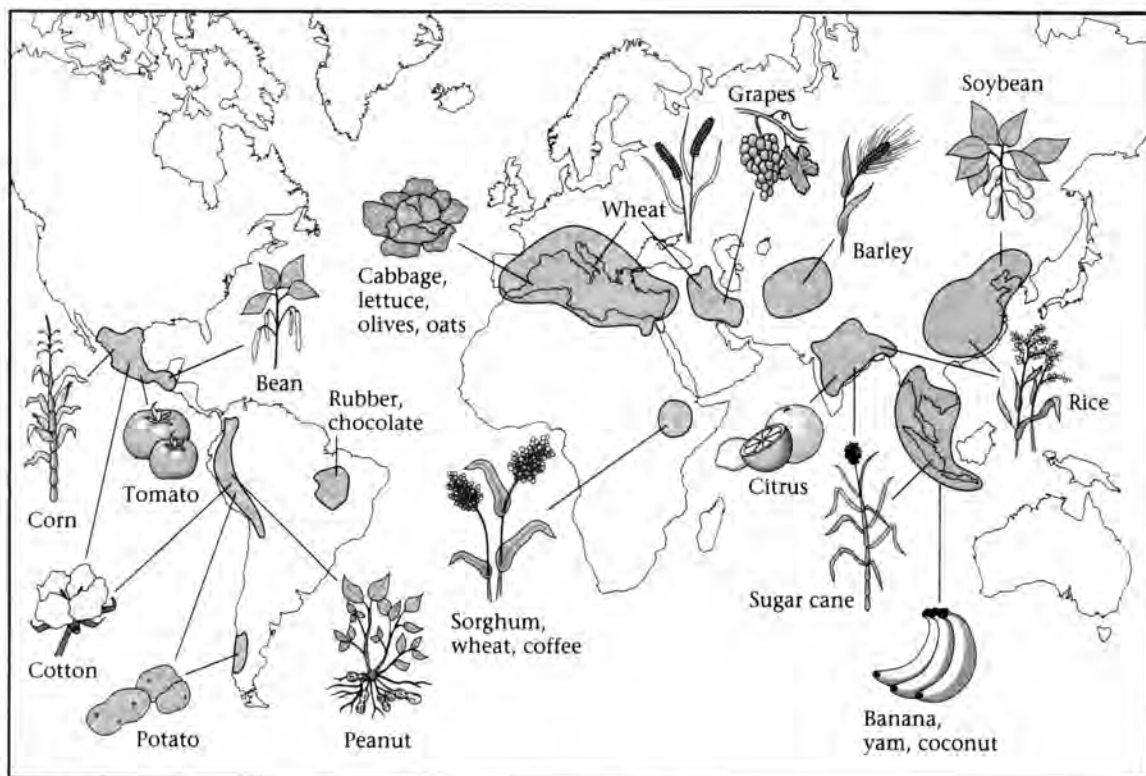

Figure 13.3-1: Centres of genetic diversity for major crops. (Source: Wilkes 1983.)

of natural hybridization and introgression have often occurred between crops and wild relatives, increasing the variability and the genetic diversity available to farmers. Through the practice of 'non-clean' cultivation, whether intentional or unintentional, farmers may increase the gene flow between crops and relatives ('introgression'). For example, farmers in Mexico allow *teosinte* to remain within or near cornfields, so that when the wind pollinates corn, some natural crosses occur and hybrid plants are produced (Wilkes 1977; Alcorn 1981; Chacon and Gliessman 1982; Brush *et al.* 1986). The extent of introgression between wild relatives and crops, however, is a subject of considerable uncertainty, and genetic investigations (at nuclear and cytoplasmic levels) are needed to resolve these controversies for maize (Benz *et al.* 1990), and probably for other crops as well.

A growing number of scientists have emphasized the need for *in situ* conservation of crop genetic resources and

for protection of the agro-ecosystems in which they occur. This allows for continued, dynamic adaptation of plants to the environment and for traditional management, especially in diversified agricultural areas where crops are often enriched by gene exchanges with wild or weedy relatives in fields or in adjacent natural ecosystems. Maintaining traditional agro-ecosystems and closely associated natural ecosystems is one strategy that can be used to preserve *in situ* repositories of crop germplasm (Altieri 1987; Altieri and Merrick 1987). The UN Food and Agriculture Organization's agreement on Farmers' Rights recognizes the important contributions made by traditional farmers to the development and maintenance of agricultural crop diversity, as part of the International Undertaking on Plant Genetic Resources Conservation (see Box 13.3-1).

Basing a rural development strategy on traditional farming, ethno-botanical knowledge, and agro-ecological techniques not only assures continual use and maintenance

Box 13.3-1: The International Undertaking on Plant Genetic Resources.

The International Undertaking on Plant Genetic Resources was adopted by an FAO conference resolution in 1983 as the first comprehensive, international, legally non-binding voluntary agreement concerning plant genetic resources. The undertaking seeks to 'ensure that plant genetic resources of economic and/or social interest, particularly for agriculture, will be explored, preserved, evaluated and made available for plant breeding and scientific purposes'.

Following the same resolution, the FAO Commission on Plant Genetic Resources was established as a permanent intergovernmental body through which countries monitor the implementation of the International Undertaking and advise FAO on its activities and programmes in the field of plant genetic resources. Currently, 110 countries adhere to the Undertaking and 122 are members of the commission.

Originally, the undertaking was based on 'the universally accepted principle that plant genetic resources are a heritage of mankind and consequently should be available without restrictions'. This concept has been qualified over the years in order to overcome the reservations to it. It now includes:

- an agreed interpretation which recognizes that plant breeders' rights (UPOV 1978 Convention) are not inconsistent with the undertaking;
- a recognition of the farmers' rights concept; and
- a reaffirmation that the concept of the heritage of mankind is subject to the sovereign rights of nations over their genetic resources and that farmers' rights will be implemented through an international fund for plant genetic resources.

These modifications have led to new qualifications on the principle of 'unrestricted access'.

Following Resolution 3 of the Nairobi Conference for the Adoption of the Agreed Text of the Convention on Biological Diversity, the above-described Global System for Plant Genetic Resources was identified as the context within which the outstanding issues of the Convention (i.e. access to existing *ex situ* collections and farmers' rights) should be addressed. The global system consists of a number of elements including the World Information and Early Warning System, the International Network of *Ex-Situ* Collections, and a voluntary International Code of Conduct for Plant Germplasm Collecting and Transfer. In 1993 the FAO conference adopted a resolution to revise the international undertaking and to harmonize it with the Convention on Biological Diversity. This process has begun since then and it is intended to convert the undertaking into a protocol to the Convention that will eventually bring under the convention framework the issues of access on mutually agreed terms to plant genetic resources for food and agriculture and the rights of providers of germplasm through the realization of farmers' rights.

of valuable genetic resources but also allows for the diversification of peasant subsistence strategies, a crucial issue in areas plagued by economic uncertainty (Clawson 1985; see Figure 13.3-2). By incorporating local crops and other native plant germplasm into the design of self-sustained agro-ecosystems, local genetic diversity is then available to farmers (Chang 1977). In recent years, there has been growing interest in community gene banks as a strategy for conserving and using crop biodiversity (see Box 13.3-2).

Trenbath (1992) and Ramakrishnan (1992) among others suggest that various measures can be effective in maintaining the genetic diversity associated with traditional agricultural systems, some of which are modified and presented below:

- establishing policy incentives (e.g. tax breaks, subsidies) so that farmers will retain some area planted to traditional (often mixed) cultivars, cultivated using traditional techniques where necessary to maintain genetic diversity;
- restricting the promotion of homogenous cultivars and exotic stock types by government and commercial interests when the rapid expansion of such cultivars and stock types is linked to significant genetic erosion and when small-scale farmers do not benefit appreciably from such promotions;
- making research on the benefits and costs of using varying numbers of cultivars and stock breeds within farmers' holdings under various levels of intensification a higher priority at national agricultural research centres;
- building capacity within government and NGO agricultural extension programmes to collect information on the diversity of domesticated genetic material, and to characterize the geographic distribution and rate of change associated with agricultural genetic diversity;
- establishing a cultivar registration system and a monitoring system to warn of impending losses of agricultural genetic resources, perhaps based on a combination of agricultural extension systems and networks of agricultural and rural development NGOs;
- training agricultural extension agents in the values of crop and domesticated animal diversity, including their role in encouraging local farmers to retain local cultivars and breeds, providing education on the value of genetic resources and their internationally recognized rights as owners of genetic resources;
- encouraging farmers to retain uncultivated strips within holdings as habitat for weedy relatives of crop

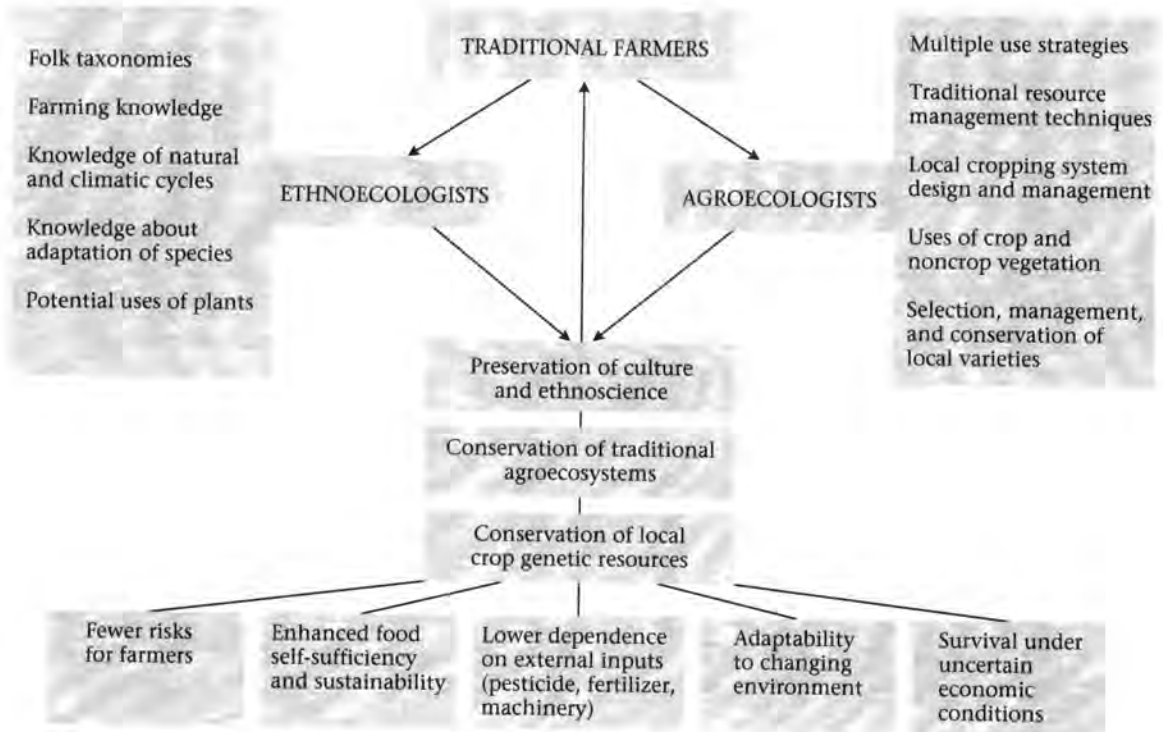

Figure 13.2-2: Traditional agricultural practices viewed from the perspectives of traditional farmers, ethnoecologists and agroecologists. (Source: Primack 1995.)

Box 13.3-2: Community gene banks.

In many parts of the world, farmers still make extensive use of traditional varieties or landraces. This may occur even when new cultivars are available, enabling farmers to grow varieties that are known to be adapted to particular agro-ecological niches or to meet specific uses for which the improved cultivars are not suited (e.g. Brush 1995). Such landraces are usually maintained by individual farmers, often subject to selection and experimentation and frequently exchanged within and between communities through traditional seed supply systems (Longley and Richards 1993).

Many communities have also developed methods of ensuring that their crop resources are maintained for use in emergencies or after natural disasters. These may take a variety of forms. In some Indian communities, sacred groves serve this purpose; in some Brazilian indigenous groups, individuals (often women) are charged with maintaining a secret resource of planting materials. In Ethiopia, community grain pits may be made in which different crop seeds are stored (Worede and Mekbib 1993).

A criticism of *ex situ* gene banks has been that they are inaccessible to farmers and communities. Designed to conserve the maximum crop diversity in secure conditions for long periods, they have been developed within the formal system and have had as one of their main concerns the provision of genetic resources to professional plant breeders. The formality of the system makes it difficult for local communities to have access to gene bank accessions. At the same time, communities have an interest and need to maintain their own crop resources for traditional farming areas and to obtain new crop germplasm with useful characteristics.

In the last few years, there has been growing interest in community gene banks, which offer a way of providing communities with the genetic resources they need to build on traditional practices and provide a link between 'formal' and 'informal' sectors. A number of developments are under way. In the Philippines, communities have become involved in the maintenance of traditional sweet potato material and the Zuni peoples in the United States have developed a community gene bank for their own traditional crop types (Nabham 1989).

What may be the most extensive programme of community-based gene banks has been developed in Ethiopia. The Plant Genetic Research Centre in Ethiopia (PGRC/E) has developed close links with farmers over many years, and they have collaborated in the maintenance and multiplication of landraces. Now, as part of a programme of on-farm maintenance of traditional Ethiopian landraces of crops such as barley, teff, lentils and chickpea, funded in part by the Global Environment Facility, a number of community gene banks are planned. They would be of simple construction and based in different regions of the country. They would be managed by the communities in collaboration with PGRC/E and hold local materials and new germplasm of potential interest to the farmers in their own crop-improvement programmes.

Community gene banks developed as a result of grass-roots action by communities and NGOs have the potential to play an increasingly significant role in the conservation and use of crop biodiversity. They can link farmers and communities with national *ex situ* collections, provide additional security for locally adapted materials, and provide a source of such material for on-farm breeding and crop improvement. They can also constitute an effective resource for on-farm maintenance of landraces ensuring that the inevitable changes in individual farmers' practices are to some extent buffered and that the resources continue to be available to the communities.

- plants – especially in areas known to be centres of origin or diversity for crop plants;
- establishing community seed banks and decentralized breeding programmes;
- providing farmers with a wider range of genetic diversity, crop varieties and species for their trial and selection;
- redesigning agro-forestry systems to incorporate ecological insights so that tree species and crop species can be more compatible;
- improving valley-land wet rice cultivation and other land-use systems such as home gardens by using appropriate crop species, transferring indigenous technology from one area to another, and redesigning or updating systems developed on the basis of traditional knowledge;
- strengthening traditional animal husbandry practices so that more effective recycling of waste between this sub-system and the cropping sub-system will result in more productive and diversified agro-ecosystem diversity;
- encouraging artisanal skills and products based on natural resources accessible to rural communities.

While traditional agriculture, especially in developing countries, is a major repository of crop genetic resources, traditional agricultural practices and the diverse genetic resources associated with them are disappearing rapidly (Gade 1969; Harlan 1975). Technical constraints, including the lack of well-distributed decentralized agricultural research centres that are linked closely to small farmers, together with scarce funds and human resources, mean that crop genetic diversity associated with traditional agricultural practices will continue to disappear at a rapid rate (Harlan 1987). There is, however, evidence that traditional cultivars and breeds will continue to survive in some areas even without outside funding or technical assistance. Several researchers (e.g. Brush 1991; Smith *et al.* 1992) have documented how small farmers combine planting cash crops for markets with raising traditional cultivars for household or local use.

With the growing realization that the more traditional *ex situ* approaches have serious limitations, *in situ* or 'on farm' conservation of diverse crop resources by custodial farmers has become an important issue in the past 20 years (Altieri and Merrick 1987; Plucknett *et al.* 1987; Hoyt 1988; Lleras 1992; Smith *et al.* 1992).

However, while being considered as the best method of conserving crop genetic resources (Brown 1982; Myers 1983) there are serious limitations to relying solely on traditional practices. Critics point out that proponents do not often spell out how to manage thousands of cultivars and local breeds of livestock (Hawkes 1977; Plucknett *et al.* 1987), and cite the moral problems of pressuring some farmers to grow low-yield land races while others plant commercial varieties. Some propose the use of government subsidies (e.g. Myers 1983; Smith *et al.* 1992), while others suggest that private financing and public and private technical support should be extended to encourage maintenance of traditional cultivars and breeds on working farms (Lleras 1994).

13.3.2.2 Managing biodiversity in modern agriculture

In the industrialized world, traditional agricultural systems and practices have been almost entirely replaced by large-scale, commercial systems (NAS 1972; NAS 1993). These large-scale systems are characterized by the use of high-yielding and genetically relatively homogenous plant cultivars and animal breeds, by large inputs of chemical fertilizers and pesticides, and by relatively little mixing of cultivars and animal breeds in the field (NAS 1993). In many parts of the developing world, large-scale commercial systems are becoming increasingly prevalent as well.

Because new arable land in the developing world will become steadily more scarce, higher yields will require the use of better agronomy dependent on a combination of more fertilizer, ploughing, irrigation, and improved plant

materials. All but the last are agricultural inputs that compete with a wide range of social and economic demands on meagre resources in developing countries (Wilkes 1992). Therefore, breeding for better crop plants and management of genetic resources in both time (gene banks) and space (crop-variety mosaics) will be the focal point around which most strategies to increase crop yields will develop (Wilkes 1992). Increased yield from the present cultivated land will reduce pressures to expand agricultural areas.

Ironically, as the human population has grown over the last 2000 years, and especially since the development of the science of genetics at the beginning of this century, we have depended on an increasingly shorter list of crops (Prescott-Allen and Prescott-Allen 1990). Although innovations in modern farming systems have greatly increased agricultural productivity, the biological support system that feeds humanity has narrowed. Driven by international market forces and reinforced by specifications of marketing organizations, supermarket chains, and even officials concerned with animal and crop health, farmers are under continuing pressure to narrow the spectra of crops and livestock they produce.

Four crops – wheat, rice, maize and potatoes – alone account for half of the calories consumed by humans (Prescott-Allen and Prescott-Allen 1990). The most productive and most easily stored/shipped plants (e.g. wheat, rice, maize, orange, apple, banana, etc.) dominate large-scale agricultural systems, and two dozen crops account for approximately 90% of the plant calories consumed by humans (Harlan 1975a). Today, a much-narrowed short-list of about 150 plant species with about a quarter of a million local races are critical to the food supply (Wilkes 1983). *Ex situ* and *in situ* conservation measures in agriculture should be focused on the sustainable management of this short-list (Altieri *et al.* 1987; Hoyt 1988; Wilkes 1989, 1991; Holden *et al.* 1993).

Measures to maintain or expand the diversity of those crops and animals used in modern agricultural systems are critical for several reasons. First, elite germplasm (in the form of high-yielding crops and breeds) has been adopted around the world. Both developed and developing nations are equally subject to genetic vulnerability, since essentially the same hybrids and high-yielding varieties have come to dominate the landscape within the last decade (NAS 1993). Second, these varieties need to be replaced on a frequent basis because pests and pathogens evolve quickly to exploit the new varieties (NAS 1993). To sustain present productivity in modern agriculture we require continued access to germplasm collections and reserve pools of germplasm to back up existing varieties (Duvick 1986), along with development of high-yield crop mixtures or multilines as an alternative to genetic uniformity and monocultures (Wolf 1986; Wilkes 1992).

Global food security is as good as the genetic base we conserve. Three categories of measures exist to preserve the genetic foundation of agriculture. The first is the protection of large tracts of natural ecosystems that contain (or might contain) wild relatives of important crop and domesticated animal species. In the second category are on-farm or *in situ* measures to use and protect rare or threatened cultivars and breeds and/or wild relatives of crop species. The third category consists of *ex situ* measures for the storage and maintenance of agriculturally relevant germplasm (Wilkes 1983; Plucknett *et al.* 1987; Brown *et al.* 1989).

In the first category, large tracts of natural habitats, including their populations of animals and plants, are preserved or managed principally for conservation objectives. In most cases, large-scale ecosystem protection will have little impact on the genetic resources of cultivated plants. The exceptions, however, can be important. For example, MAB (Man and the Biosphere) Reserves have sometimes been purposefully selected and planned to include important agricultural genetic resources in the form of wild relatives of major crop species and traditional cultivars. The Sierra de Manantlán Biosphere Reserve in Jalisco, Mexico, protects wild relatives of both maize and beans (Benz *et al.* 1990). The reserve also protects the fields and traditional agricultural practices of indigenous Indian cultivators from encroachment (Guzman and Illis 1991; Wilkes 1993a; see 13.4.2 for more information on measures for protected areas). Agriculture has tended to assume that wild relatives will be maintained by nature in wild habitats. This is ceasing to be the case in many areas, and agricultural interests will need to become more directly involved in identifying habitat conservation priorities (see 13.2) and contributing to the implementation of protection and sustainable use measures in priority areas (see 13.4).

In the second category, on-farm conservation, landraces and wild relatives are preserved in selected small areas, along with the genetic diversity generated where the two hybridize. These are evolutionary systems that are very difficult to simulate for plant breeding, and they should not be knowingly destroyed (Brush 1991; Wilkes 1991). Their long-term preservation may not be possible, but their disappearance can be slowed by monitoring and intervention measures (such as fencing) targeted at specific populations. This will allow more time for researchers to understand how these systems evolved. Considerable potential for creative institutional arrangements, as presented in 13.3.2.1 exist for village-level, small area, *in situ* preservation, especially in developing countries (Wilkes 1993b).

In the third category, *ex situ* measures are used for long-term storage of genetic materials, especially for cultivars, breeds, and wild relatives that are unlikely to persist on-farm or *in situ*. Gene banks have been the mode of

preservation for most crop genetic resources (Cohen *et al.* 1991; Holden *et al.* 1993). Gene banks and other forms of *ex situ* protection measures are more fully discussed in 13.4.4 and in Section 8.

Additional plant breeders are needed world-wide to build more diversity into the genetic resources of the world's most important crop and domesticated animal species. There are fewer practising plant breeders now than in the 1950s when the human population was half what it is today (Wilkes 1989; Collin and Phillips 1991). New areas of molecular genetics and biotechnology have attracted researchers and have been responsible, in part, for this decline. In addition, the role of gene banks has not been appreciated by the conservation community. At the same time, the agronomy community has not presented a strong case for the public support of plant genetic resource conservation. Following the yield leaps of the Green Revolution of the late 1960s, most of our plant breeding has been maintenance breeding to keep the yield close to the high levels achieved earlier (NAS 1993).

Genetic uniformity has been created as breeders have developed crops that have (1) rapid and uniform germination of seeds; (2) nearly simultaneous flowering; (3) nearly simultaneous maturation of harvest; (4) stature that promotes mechanical harvest; (5) product uniformity for taste and chemical composition, and (6) year-to-year stability of yield. Genetic changes, mutations, and new recombinations are always taking place in populations of pathogens and if a new genetic combination is virulent on a previously resistant plant host, it will spread across the entire host population if the latter is genetically uniform. With landraces, such genetic uniformity seldom extends beyond the fields of a single farmer or the fields of a village or district. With commercial seed, the uniformity may extend across nations and beyond (Wilkes 1993b).

Commercial agriculture needs a more diverse genetic mosaic of species to reduce genetic vulnerability within and between crops. Planting a crop in smaller blocks mixed with blocks of other crop species instead of planting one crop over large contiguous areas and/or planting several varieties of the same crop in mixed blocks over an area could create mosaics that would overcome some of the genetic vulnerability inherent in the use of uniform elite germplasm.

Positive actions to deal with genetic erosion, genetic vulnerability and the gene banks crisis involve the following initiatives (Wilkes 1992; NAS 1993):

1. New programmes to assess genetic erosion and vulnerability and to monitor the use and geographic distribution of elite germplasm.
2. The development (especially in the public sector) of totally new gene pools to act as genes in reserve to support the commercial breeder with alternatives.

3. Increases in training for the maintenance of plant genetic resources and the building of bridges to the greater conservation community. Genetic resources programmes should be engaged in pre-breeding and moving genes from the collections into enhanced materials.
4. More basic and applied research in order to more efficiently and effectively measure genetic distance between varieties, and improve evaluation techniques, especially those relating to the nature of resistance to pest and pathogens and pest–host interactions, in conjunction with early detection of changes in the virulence of pest and pathogens as well as shifts in the varietal picture.
5. Promotion of education to inform the food industry, farmers, seedsmen, plant breeders and others about the relationship of genetic and spatial diversity with regard to the potential for crop vulnerability and failure so that they can develop alternative management strategies to genetic uniformity. Such methods include parallel breeding, genes in reserve, enhancement breeding for gene pools, wide crosses, biotechnology and alternatives to monocultures such as crop rotation, crop mixtures, multiline resistance, pyramided resistance factors, manipulations of pest parasites, pest-trap crops, insecticides/fungicides and better monitoring.

Innovative new forms of support for such activities may be needed since national and international public financing for agricultural genetic resources conservation may actually be declining. Research taxes or other forms of compensation paid by large seed firms, agribusinesses and other large commercial interests that use genetic resources from local farmers or publicly maintained seed banks are one option to involve the private sector more fully in conservation activities from which they benefit, but for which they do not currently pay.

Because of its major role in ensuring global food security, the conservation and utilization of crop plant genetic resources have become major concerns of international efforts such as the FAO Commission on Plant Genetic Resources and the Consultative Group on International Agricultural Research. The unique utility aspect of crop plant conservation has not generally been understood and these genetic resources have been poorly supported and managed (NAS 1993). Genetic erosion and the short-term benefits gained from the use of elite germplasm have created the potential for genetic vulnerability in the long term (NAS 1993). When societies are no longer able to breed crops that can respond to and effectively meet changing conditions, they have lost the key to agricultural sustainability. It will be the positive

responses of crops to agricultural practices, pests, pathogens and social institutions that will determine the success of our attempts to feed ourselves and yet maintain agricultural systems that are sustainable (Wilkes 1992).

13.3.2.3 *Managing agricultural impacts on natural resources*

As well as practices to use and protect agricultural genetic resources as presented above (13.3.2.1 and 13.3.2.2), methods are also needed to ameliorate the negative environmental effects of agricultural practices on the natural resource base that sustains food production and the biodiversity of other ecosystems. Soil erosion, reduced diversity of invertebrates and soil microfauna, water contamination and depletion, and conversion of natural habitats are associated with agriculture in most temperate and tropical areas (see Section 11).

Around the world, degradation of agricultural land by erosion, salinization and waterlogging causes the irreversible loss of an estimated 6 million hectares each year (Pimentel 1993). While no systematic evaluation of the overall global status of human-induced soil degradation has been made, Tolba *et al.* (1992) conservatively estimate that 25% of agricultural land is affected by soil degradation. Soil loss rates in Europe and the United States range between 10 and 20 tonnes per hectare per year. In Asia, Africa and South America, cropland soil erosion ranges between 20 and 40 tonnes per ha per year (Pimentel *et al.* 1993). Erosion adversely impacts food production by reducing water availability, nutrients (e.g. N, P, K and Ca), and organic matter, and by restricting rooting depth as topsoil thins (El Swaify 1985). Annual food production losses as a result of land degradation may exceed 12 million tonnes of grain (FAO 1991b). Agricultural soil degradation, in addition to reducing crop productivity, contributes substantially to the degradation of other habitats and the loss of biodiversity. As much as 80% of the 11.6 million hectares of forest cleared annually is for agriculture, and Pimentel (1993) estimates that most of this conversion is to compensate for degraded agricultural lands. Sediments from erosion fill river beds, lakes and estuaries, and settle on nearshore coastal marine environments. This interferes with fish breeding, smothers coral, and accelerates the eutrophication of aquatic systems as nutrients associated with eroding soils enter the environment.

A variety of conservation technologies are available to minimize soil erosion. Most technologies are based on the principle that soil erosion and rapid water runoff can best be controlled by maintaining adequate vegetation cover. Depending on soils, slopes, crops and climate, soil conservation technologies include contour planting, strip cropping, crop rotations, terraces, mulches, no-till planting, ridge planting, grass strips, tree/shrub hedges,

agro-forestry, shelter-belts, and various combinations of these technologies. Matching the most effective technologies with specific soils, climates and topographies is a high priority area for future research (Pimentel 1993).

Agrochemicals (fertilizers, herbicides and pesticides) also have tremendous impacts on biodiversity. Fertilizers cause eutrophication in rivers, lakes and coastal areas as nitrate and phosphorus enrich aquatic environments. This leads to dense algal blooms, dramatically increasing biological oxygen demand and creating lethal conditions for many fish, invertebrates, plants and other forms of aquatic life.

While pesticide use world-wide is estimated to increase crop productivity by approximately 10% (Pimentel *et al.* 1992a), the abuse of these chemicals imposes enormous environmental costs and may limit agricultural gains. Pimentel and Levitan (1986) estimate that 90% of pesticides do not reach their target pests and instead contaminate land, water and air. Pesticides kill beneficial natural predators of agricultural pests, reduce microbial diversity associated with soil productivity, and harm humans, fish, birds and other wildlife. Pimentel *et al.* (1992a) conservatively estimate that the improper use of pesticides in the United States alone causes the death of at least 67 million wild birds, 14 million game fish, and unknown numbers of mammals, amphibians, reptiles and invertebrates each year.

Excessive use of pesticides also has adverse impacts on agriculture itself. Pimentel *et al.* (1992) estimate that the annual cost of pesticide losses in agriculture due to pesticide resistance in crop pathogens, loss of natural enemies of agricultural pests, honeybee and pollination losses, and crop and livestock losses from pesticide contamination, is at least US\$3 billion. Perhaps the most damaging losses come from the loss of soil invertebrates and micro-organisms essential to the structure and function of the soil. However, estimates cannot be made for these losses because no relevant quantitative data have been collected. World-wide, the growth of pesticide sales have been accompanied by growing resistance of pest species to pesticide use (Lean *et al.* 1990; see Figure 13.3-3). The proportion of crop losses in the United States due to insects has nearly doubled in 40 years despite a tenfold increase in the amount and toxicity of insecticides used (Pimentel *et al.* 1991b). Much of this is due to increased resistance of pests to insecticides, but other factors such as the increased use of monocultures, destruction of natural predators, and reduced use of crop rotations are involved as well.

Integrated pest management (IPM) and other strategies have been developed to address problems arising from pesticide use. IPM strategies may include the selective use of pesticides, greater use of biological controls (e.g. natural or introduced predators of pests), genetic resistance, and

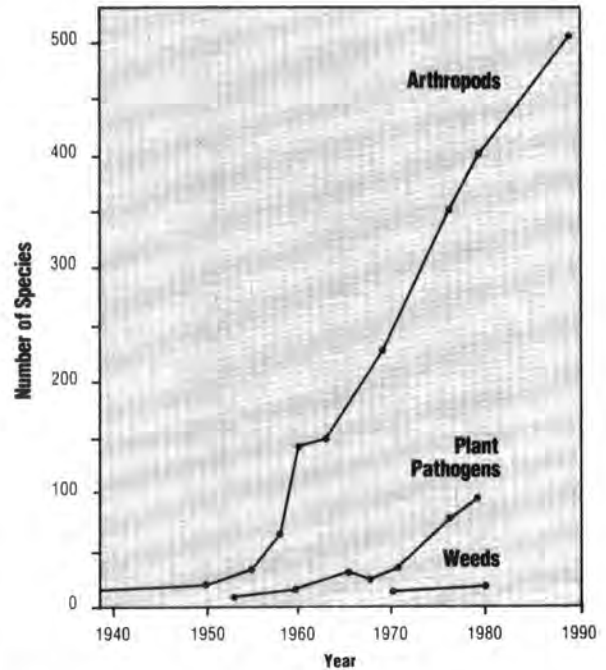
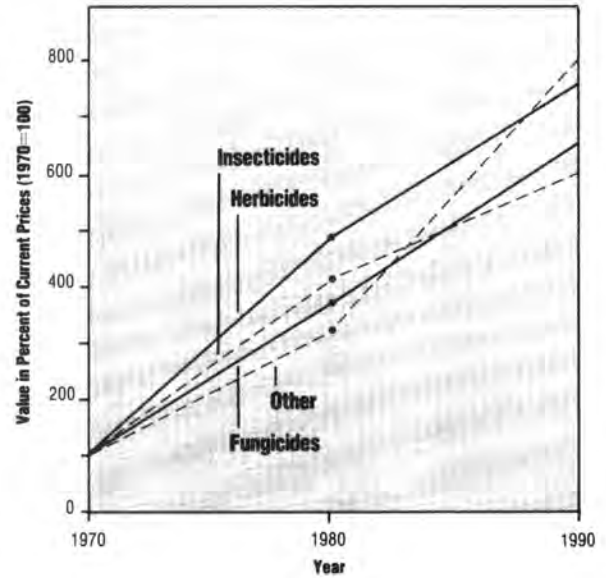

Figure 13.3-3: Dramatic world-wide growth in pesticide use since 1970 has been accompanied by pesticide resistance in a growing number of pest species. (Source: Lean *et al.* 1990.)

other management practices such as greater crop rotation and the use of varied planting, harvesting and irrigating schedules (Fulick and Fulick 1991). In Indonesia, the government introduced a large-scale IPM programme for subsidies on those that remained. A nationwide programme was established to show farmers how to conserve natural predators such as spiders, with spraying as a last resort. Within three years, farmers were using 90% less pesticide, rice yields were increasing, and less harm was being done

to the environment and biodiversity (Fulick and Fulick 1991). With training programmes and upgraded extension systems, other Asian countries have achieved varying degrees of success with IPM (Kenmore *et al.* 1987).

Actions to restrict the impact of agriculture on biodiversity include the following:

- supporting research and policies that encourage use of integrated pest management in order to protect wildlife and natural enemies of crop pests from damage by unnecessary spraying;
- avoiding dispersal of fertilizers and herbicides onto any relatively undisturbed habitat adjacent to agricultural fields, especially those adjacent to streams, rivers, lakes and wetlands;
- training extension agents to work with farmers in developing natural habitat conservation strategies;
- leaving some relatively undisturbed habitat on holdings to maintain overall biotic diversity, including wild species beneficial to agriculture;
- using native woody species when establishing wind-breaks or woodlots to check wind and water erosion of soil and nutrients on agricultural holdings;
- where agricultural expansion is inevitable, promoting the establishment of land-use planning policies and practices that direct expansion to areas where cultivation and grazing can be practised sustainably (i.e. areas where climate, soil, markets and infrastructure are suitable for long-term agriculture) and where unique biodiversity resources are not located.

13.3.3 Managing biodiversity in forestry

As with agriculture, the relationship between forestry and biodiversity is strong. Although the 'variety of life in the infrastructure of forests is immense, fragile, and still very poorly understood,' Wilson (1993) writes that enough is known to conclude that 'biodiversity is vital to healthy forests, while proper forest management is vital to the maintenance of biodiversity'.

This relationship was known, at least intuitively, to many traditional cultures around the world. Community forestry's roots pre-date the emergence of agricultural society (Johnson and Cabarle 1993). Traditional practices in community forestry encompass a wide range of forms including agro-forestry, sacred groves, forest gardens, collection of non-timber forest products, and highly selective timber felling, among others. Many of these forms include measures that maintain or even enhance

biodiversity. Although many measures for the sustainable use and management of biodiversity in traditional forestry systems are, like their counterparts in agriculture, rapidly disappearing, others are finding new roles in strategies to sustain forest resources. The role of measures to sustainably use and manage biodiversity in traditional forest management is presented in 13.3.3.1.

Modern silviculture, based on forestry systems first developed in Europe during the nineteenth century, has focused on timber productivity – often at the expense of biodiversity. In recent decades, ecology and other forest-related sciences have documented the links between forestry, ecosystem processes and biodiversity. Forestry around the world is undergoing a transformation as new measures are developed to maintain biodiversity within the practice of forestry (Aplet *et al.* 1993). Measures being used in large-scale forestry to manage and sustainably use biodiversity are presented in 13.3.3.2.

13.3.3.1 Managing biodiversity in traditional forestry

Research in many forest areas previously thought to be relatively pristine and unmanaged, particularly in the humid tropics, has yielded some striking results. The natural forests in many – even most – tropical areas today increasingly appear to be the product of human intervention, selection and management (Gómez-Pompa and Bainbridge 1991). Before European settlement, the species and ecological diversity in some forest areas in North America were also manipulated by native peoples (MacLeery 1992). Traditional forest management practices, where they still survive, remain important measures for maintaining and sustainably using biodiversity (see Section 11). The knowledge provided by these practices, and those that were dropped as cultures changed or disappeared, also provides lessons that may help modern forest management to become more sustainable in coming decades.

Agro-forestry – combining trees that provide food, fibre, fodder, medicine, and building materials with annual and perennial crops and livestock – is at the centre of most traditional forest management systems. In the Maya region of southern Mexico and Central America, agro-forestry consists of the selection, cultivation, introduction and protection of trees throughout the landscape. In present-day Maya towns, as many as 60 to 80 tree species can be found in an individual forest garden and as many as 200 species in a village (Herrera Castro 1990). These trees are used for building materials, firewood, food, medicine and fodder. Many of the trees are the same species found in nearby natural forest areas, while introduced species such as guava, banana, lemon, orange and other citrus species are also used. Gómez-Pompa *et al.* (1993) estimate that these forest gardens cover more than 25 000 hectares in the Yucatán, or approximately 10% of the region's forested area.

Trees are used in a multitude of other ways as well. Along the edges of or scattered in agricultural fields, an abundance of native nitrogen-fixing tree species and varieties, probably reflecting centuries of human selection and protection, are used to maintain soil fertility (Flores Guido 1987). Individual trees are selected and protected in *milpas* or clearings for crop production created in a shifting cultivation system, a practice thought to account for the high species diversity found in secondary forests on fallow lands. Leguminous trees are used as shade trees for cacao and coffee, a practice that lowers annual yield but extends the useful life of crop plants (Gómez-Pompa *et al.* 1993).

Natural forests are protected along trail networks, edges of *milpas*, and other areas. Strips of forest left along trails provide valued shade for travel, while belts of forest near *milpas* probably play an important role in regeneration on fallow lands (Gómez-Pompa and Bainbridge 1991). These forest belts undoubtedly provide habitat for many forest species and corridors for mammals and birds between larger natural forest areas.

Similar integrated traditional forest management systems are well documented in many other tropical regions, including the islands of Java, Sumatra and Borneo (Soemarwoto and Soemarwoto 1984; Michon *et al.* 1986; Padoch and Peters 1993), peninsular Malaysia (Whitmore 1975), the Catatumbo region of Colombia (Pinton 1985), Brazilian Amazonia (Posey 1984) and many other areas (see Alcorn 1990 for review). There are many examples of measures used in other systems.

- Dislodging grasses, preventing fires, and ringweeding pioneer species are techniques being used by local communities to regenerate deforested areas in the Philippines (Nasol 1994).
- Cultural beliefs, such as the conviction of the Kayapo in Brazil that old abandoned fields are full of spirits and should be avoided, or that medicinal plants can only be harvested by the medicine man, can, in effect, restrict over-exploitation of forest resources (Posey 1993).
- Many indigenous peoples exchange and spread useful species to forest openings, fallow fields and within forests to increase food diversity and the availability of other products – practices that probably increase overall biodiversity levels (Posey 1993).
- Planting of species attractive to game animals has, when the field is left because products are too high to harvest, assured that game animals will still be available (Posey 1993).
- Reliance upon older fields as sources of cultivars has been encouraged (Posey 1993).

Natural forest management – often defined by foresters as the controlled and regulated harvest of timber species in natural forests – has gained considerable attention as one of the most promising strategies for slowing tropical deforestation. In general, however, natural forest management has so far failed to live up to its potential for sustaining humid tropical forests (Poore *et al.* 1989). Many of the most promising initiatives in natural forest management are community-based and controlled (Poffenberger 1990; Perl *et al.* 1991). Most community-based natural forest management systems use the same silvicultural techniques that are used in natural forest management practices on concessions or on private lands (e.g. minimum diameter limits, selective harvesting, and either monocyclic rotations or multiple-entry polycyclic regimes). However, community-based systems are much more likely to integrate non-timber product harvesting, to use or market lesser-known tree species, and to impose seasonal or area restrictions on harvests to protect soil and water quality and protect wildlife (Johnson and Cabarle 1993).

While most community-based natural forest management projects are relatively recent in origin (most started in the 1980s and 1990s), there is indirect evidence to suggest that they are more sustainable and less damaging for wildlife than large-scale commercial operations. Several assessments (Buschbacher 1990; Uhl *et al.* 1990; Perl *et al.* 1991; Johnson and Cabarle 1993) of sustainability in natural forest management conclude that small-scale, community-controlled operations have generally demonstrated fewer adverse impacts on forest ecosystems than have large-scale commercial operations.

The advantages of local control include better policing and husbanding of local forest resources and a more equitable distribution of benefits. Closely knit communities deeply tied to the land they own tend to be committed to sustainability and to weather the vagaries of fluctuating markets and socio-political change with remarkable grace. Then, too, programmes designed to encourage community forestry generally cost less than government management of public lands – and often work better (Johnson and Cabarle 1993).

There are, however, problems and uncertainties with community forest management. Not all communities are equipped politically, financially and technically to manage extensive forest tracts. Many forests are remote from markets and services. Often, local land claims are not recognized by governments and are disregarded by outsiders. Few state forestry agencies and donors provide the short- or long-term investment needed to develop local capacity. Most investors prefer highly technical and capital-intensive forest operations that yield a quick return: these operations, however, lie outside the reach or interest

of community groups. Perhaps most important, national economic and development policies – especially in agriculture, energy, trade and finance – are often dictated by global market forces that encourage short-term profit-taking, which promotes land-use practices that endanger forests and local communities (Cabarle 1991; Colchester 1991).

Today, traditional systems of forest management are being joined with technical assistance provided by government forestry agencies (Poffenberger and McGeen 1994). These joint management programmes, especially in parts of Asia, do not seek to replace traditional forest practices but to augment them with help in forest management planning, silvicultural practices, and marketing (see Box 13.3-3; also 13.5.2.4). In most cases, successful joint management requires a significant transfer of responsibility from state agencies to villagers (see also 13.6.2).

13.3.3.2 Managing biodiversity in commercial forestry

Large-scale commercial forest management is widely practised today in tropical, temperate and boreal forests. Logging practices in these systems have often been criticized for their adverse impacts on biodiversity and on other non-timber resources found in forest ecosystems (e.g.

Uhl and Viera 1989; Johns 1992; Whitmore and Sayer 1992; Noss 1993). A range of measures, however, is available for the protection and sustainable use of biodiversity in commercial forestry. First, long-term sustainable forestry depends on measures to maintain the genetic diversity of forest trees so that forestry can respond to environmental changes (e.g. climate change) and biological changes (e.g. new pathogens or pests). Second, measures can be taken to minimize the impacts of logging on biodiversity and ecological processes. Third, biodiversity inventory and monitoring are vital tools (see Section 7) for adaptive management techniques that seek not only to produce fibre but also to maintain biodiversity and ecosystem services as well.

13.3.3.2.1 Measures for the sustainable use and management of forest genetic resources. The genetic diversity of some forest trees, especially those highly valued for timber, is being narrowed as tree populations are heavily impacted by intensive logging and natural forest ecosystems are converted to plantations or other uses. A review of the conservation status of forest trees by the US National Research Council (NRC 1991) concluded that nearly 500 temperate and tropical species are endangered (using IUCN guidelines), either world-wide or at least in

Box 13.3-3: Joint forest management in India.

In many parts of the world, traditional forms of forest management have been replaced by timber-orientated commodity production forestry. Often, this transformation has depleted forest species and left local communities with fewer resources to supply food, clothing, shelter and basic subsistence needs. For 125 years, Indian forest management policies emphasized state custody of forest resources, the development of plantations, and timber production from natural forests. These policies often failed to meet the needs of local communities and were biologically unsustainable. In the past 20 years, however, state forestry authorities and local communities have collaborated on the development of Joint Forest Management projects to meet demands on forest resources.

Before the advent of joint forest management policies in India, extensive areas of natural forest were being converted into plantation forests and deforestation rates approached 1.5 million hectares per year. Despite provisions in the 1980 Forest Conservation Act that restricted the felling of natural forests and emphasized the potential of non-timber forest products, high deforestation rates continued. In addition to being targets for the growing demand for commercial wood products, the forests were also under growing pressure from the 56 million people living in or around forests to supply daily needs. The custodial practices for forest preservation exercised by the state were no longer effective in controlling such demands.

In West Bengal, foresters realized that the future of *sal coppice* forests – once a major economic resource – was linked to local community participation in forest management and benefit sharing. Local communities were invited by the state to become partners in protecting natural forest land and aiding natural regeneration, for which they would receive harvesting rights to fuelwood and non-timber forest products (e.g. fruits, nuts, medicinal plants) and a 25% share of timber sale profits (SPWD 1992). The response was slow at first, but by the late 1980s, many communities throughout West Bengal were involved in Joint Forest Management projects.

Communities are now actively protecting and managing forest lands, deforestation rates have declined, and conditions for wildlife and biodiversity are improving. Convinced by the success of Joint Forest Management projects in West Bengal and elsewhere, India issued guidelines in 1990 to encourage all states to adopt Joint Forest Management procedures. There are now nearly 10 000 forest protection committees, responsible for the management of 2 million hectares of forest in ten Indian states.

significant portions of their ranges. Future forest productivity in the face of environmental change will, as with agriculture, depend on managing and using the genetic resources of forest trees.

The management of forest genetic resources lags behind that of agricultural genetic resources. The genetic architecture of forest trees is poorly understood, breeding is slow, and wide variations in physical, ecological and economic environments are factors to be considered in the use of available genetic variation (NRC 1991). A forest genetic resources group convened by the US National Research Council in the late 1980s (NRC 1991) concluded that 'no adequate global strategy exists for systematically identifying, sampling, testing and breeding trees with potential use'. The development of improved varieties of tree species for use in agriculture, rehabilitation of degraded lands, and industry has been given little attention: there is not even a unified list of trees with high potential for use. Such a list, according to the group, should contain at least double the 400 tree species known to have been tested or included in breeding programmes and should include at least ten times as many tropical species in breeding programmes. In particular, genetic resource conservation programmes are needed for species that are not found in reserves or protected areas, especially in the tropics.

The value of *ex situ* genetic conservation is limited by a number of factors in combination: naturally high levels of genetic diversity, the predominance of out-crossing breeding systems, long generation times, frequently low viability of stored propagules, and temporally and spatially variable environments. Strategies to counter genetic losses start with good silvicultural practices which avoid high-grading (cutting the largest or best specimens) or leave relatively undisturbed genetic reserves in production forest areas. Other strategies include collecting seeds and pollen for *ex situ* preservation in seed banks, establishing seed orchards, and increasing the genetic diversity of plantations. Ultimately, the most effective strategy is *in situ* preservation of natural forest stands large enough to maintain themselves through natural regeneration and to encompass natural disturbance events (e.g. fire) as well as other ecological processes and biotic interactions (i.e. evolutionary forces). Protected area systems therefore provide the best means for genetic conservation (Ledig 1988).

Both *ex situ* and *in situ* preservation will benefit from identifying priority populations to sample or save. Priorities for *ex situ* preservation strategies need to identify which populations and what number and distribution of populations need to be sampled. Effective *in situ* genetic conservation strategies must determine which populations to maintain and the size, distribution, and number of populations required to meet a number of objectives. These objectives include:

1. preserving a representative sample of among- and within-population variation;
2. protecting the genetic integrity of individual populations from genetic contamination (e.g. cross-breeding with genetically uniform plantation stands);
3. maintaining a dynamic equilibrium between inter- and intra-specific competition, including adequate range of age distribution, habitat availability for pollinating and seed-disseminating species, and the breeding system that shapes the species' genetic structure (Ledig 1986).

Similar approaches can be used to identify priority populations for both *ex situ* and *in situ* conservation. Genetic patterns in tree species are often completely unknown or known for only an unrepresentative fraction of a species' population. A common strategy in the absence of information is to preserve or sample populations in representative habitats, since they will probably include a maximum range of the species' genetic variability. Ledig (1986) stresses the importance of sampling marginal habitats where selection may have favoured novel variants.

The ideal strategy is to map geographic patterns of genetic variation over a species range and measure the extent of variability within populations. This, of course, requires good information on population distributions and considerable expense and effort to characterize genetic variability within populations. Technological innovations during the past decade have made surveying genetic variation much more practical, especially for species with small ranges or few populations. Once collected, samples can be characterized by using electrophoretic gel separation of enzymes that provide markers of genetic composition (allozymes) (see Section 2.2).

Genetic analysis can provide information critical to identifying priorities for the conservation of rare or endangered species limited to a handful of populations. For example, only two populations of Torrey pine (*Pinus torreyana*) remain, both of them located in southern California. Although both populations are believed to have lost much of their natural genetic variation, allozyme analysis revealed significant differences in the genetic make-up of the two populations (alleles differed at 8.5% of their gene loci). Therefore, conserving both populations is probably critical to their long-term persistence, especially because of the low level of genetic variability to begin with.

There are some common problems with most genetic resource reserves, irrespective of the objectives of management. Often the reserve size is too small, limiting the effective population size of the target species. Associated with this, distances between adjacent reserves are often large, which can result in problems of isolation and reduced gene flow. Depending on how the surrounding forest is managed, edge effects in small reserves may be so great as to significantly modify the habitat. Even when

conditions are adequate for the targeted species, they may not meet the requirements of mutualistic species, of which there may be many, especially in the tropics, but which are usually much less well understood. Further, smaller reserves maintain fewer animal species, some of which may serve as pollinators, seed dispersers or seed predators, and are essential for plant reproduction.

The NRC working group (NRC 1991) concluded that a global strategy combining *in situ* and *ex situ* methods is needed to conserve tree genetic resources. Their most important recommendations include:

- *In situ* and *ex situ* programmes to conserve, manage and use forest tree resources should be expanded to increase the number of species in management programmes at least tenfold.
- Long-term *in situ* genetic management plans should be developed, especially for tropical and subtropical species.
- Planted forests, or *ex situ* stands, should be used more often to serve as living seed banks and as test and evaluation stands.
- As a complement to *in situ* programmes, technologies should be developed and applied for pollen, seed and tissue culture preservation; long-term storage (e.g. cold storage) programmes are needed to back up *in situ* living stand genetic resource programmes.
- More emphasis should be placed on co-operative and co-ordinated exploration, collecting and testing programmes between countries, particularly for species with broad multinational ranges.
- Breeding and testing programmes should at least double the number of species with known potential value.
- Forest genetic resource programmes should conserve more species – especially those not found in effectively managed protected areas – that lack clear present or potential value and those that have little known potential value.
- Dramatically increased efforts are needed for accurate inventories of forest trees world-wide and to research the distribution and structure of genetic variation of forest trees, especially in the tropics.
- Tree genetic-resource management needs should be assessed within broader national forest plans, national biodiversity strategies, and agricultural

development strategies and priority programmes included in the funding and implementation of such programmes.

- A global database on the conservation status of tree genetic resources should be established to augment the limited national databases that exist and the valuable efforts of the FAO Panel of Experts on Forest Genetic Resources.

13.3.3.2.2 *Minimizing the impacts of forestry operations on biodiversity.*

While commercial logging in temperate and tropical forests rarely leads directly to deforestation, timber harvesting can have devastating impacts on forest ecosystems. Extensive damage to unharvested trees is common in many logging operations. For example, when less than 2% of the trees greater than 10 centimetres in diameter were harvested in an Amazonian floodplain forest, 26% of the remaining trees of equivalent size were seriously damaged or destroyed; forest canopy cover was reduced by 50%; and logging roads exposed 8% of the forest floor (Uhl and Viera 1989). Over time, damaged trees are more susceptible to pathogens (Putz 1993) and undamaged trees become more vulnerable to blow-downs in storms than un-logged forests (Johns 1992). In the temperate hardwood forests of the southeastern United States, evidence suggests that even 50–85 years after clear-cut logging, the herbaceous plant-species diversity of affected areas has yet to recover (Duffy and Meier 1992). The impact of logging on biodiversity, however, has been a contentious issue (see, for example, Elliott and Loftis 1993; Steinbeck 1993).

In both tropical and temperate forests, a growing body of evidence shows that logging disturbances tend to favour an increase in generalist or opportunistic invasive species, while species with specialized mature forest habitat requirements decline or disappear (Isabirye-Basuta and Kasenene 1987; Holloway *et al.* 1992; Thiollay 1992; Niemela *et al.* 1993; Frumhoff 1995). The effects of converting natural forests to plantations are, of course, much more dramatic (see, for example, Showalter and Means 1988). Logging operations can also have severe impacts on aquatic and marine systems. For example, protecting salmon and other anadromous fisheries has created enormous conflicts with forest policy in the northwestern United States and Canada (Barber *et al.* 1994).

The role of disturbances such as fires, hurricanes and wind-throws, and the role of ground debris, standing snags, and clumps of mature trees in regeneration, have been found to be critical in the maintenance of biodiversity and ecosystem integrity (Putz 1987). Foresters have tried to limit the role of natural impacts in forest ecosystems while environmentalists have tried to minimize logging impacts on forest systems.

Around the world, however, forest researchers are seeing evidence that eliminating disturbance can have adverse impacts on both biodiversity and forest productivity. For example, forest-fire suppression programmes and single-tree selection harvesting prescriptions are resulting in major disruptions of ecosystem processes and changes in forest composition from northern temperate pine forests to mahogany forests in the tropics: mahogany species and most pines, for example, require substantial canopy openings for regeneration (Snook 1989; Pfister 1993). Research shows that timber harvesting and silvicultural practices that mimic natural-stand and landscape-level dynamics will provide the best opportunities to maintain biodiversity in natural forest ecosystems (e.g. Hartshorn 1989; Franklin 1993; Noss and Cooperrider 1994).

To minimize the adverse impacts of forestry operations on biodiversity and to maximize the likelihood of sustainable use, timber harvesting methods and silvicultural practices are being developed that mimic natural-stand and landscape-level dynamics (see, for example, Aplet *et al.* 1993). Natural disturbance regimes, such as fire, pathogen outbreaks, wind damage, and other processes critical for maintaining species diversity, are used as models for designing harvesting plans and silvicultural treatments. Such methods can, depending on the forest ecosystem, range from clear-cutting large tracts of forest using heavy equipment to scarify the soil surface, to gently extracting single trees manually, with draft animals, or with an aerial system (e.g. sky-lines or helicopters). Rotation periods can also reflect natural temporal patterns, and stands of different ages (including protected old growth) can be distributed across the landscape in manners that reflect natural spatial patterns (see, for example, Harris 1984; Franklin 1993; Mladenoff *et al.* 1994).

Stand-level management plans in which canopy-tree replacement occurs primarily in small openings created by the death of single trees should include measures designed to assure that this disturbance regime is replicated as closely as possible. Such measures include directional felling and planned extraction of logs along rationally located skid trails and roads. Planning of extraction pathways can greatly reduce both logging damage and logging costs. Where ground-based extraction equipment is employed, the machines should be as small as possible, and logs should be winched for the longest distances possible to reduce the proportion of the area crushed by machinery. Aerial extraction systems, especially sky-line and helicopter yarding, and at-the-stump log processing (e.g. with portable sawmills) can also diminish logging damage.

Many of the deleterious environmental impacts of commercial logging operations are due to secondary effects such as hunting, forest colonization and conversion along logging roads, especially in tropical areas. Responsibility for these effects should be borne, at least to a large extent, by the people who most benefit from

logging. Providing field crews with adequate compensation and supplies so they do not have to hunt for subsistence or earn income by selling wildlife to markets can reduce the deleterious impacts of forestry operations on populations of large mammals and birds in remote tropical forest areas.

More specific measures to maintain biodiversity in areas managed for commercial forest production include:

- Establishing protected area systems, both inside and outside concession areas, that cover (a) representative areas of all forest types, (b) examples of those forests having high species diversity or high levels of endemism, and (c) forest habitats of rare and endangered species or species associations (Budowski 1984; Blockhus *et al.* 1992).
- Leaving larger forest patches with complex shapes and design patches of different successional classes adjacent to each other, thereby maximizing forest interior and landscape interspersion, both of which may facilitate seed dispersal and regeneration (Mladenoff and Pastor 1993).
- Using less intensive harvesting and management practices in forest areas adjacent to protected areas and other sensitive habitats, and in areas that may serve as corridors to nearby protected areas or natural habitat areas (Blockhus *et al.* 1992).
- Using interdisciplinary teams including foresters and economists joined by botanists, zoologists, conservation biologists or other appropriate specialists in plant and animal ecology to develop and monitor the implementation of forest management plans (Blockhus *et al.* 1992).
- Publicizing production forest boundaries, and marking boundaries to prevent harvesting in areas not designated for logging, and to protect genetic resource and habitat reserves designated within production forest areas (Blockhus *et al.* 1992).
- Involving local people, where appropriate, in forest management planning since their knowledge of forest resources and forest ecology can be valuable in developing sustainable forest management systems in commercial forest areas (Blockhus *et al.* 1992).
- Reducing disturbances that do not mimic the natural disturbances in that ecosystem (Blockhus *et al.* 1992).
- Establishing protected riparian forest strips along

rivers, streams, lakes and wetlands. While the size of these will vary according to the ecosystem and the intensity of harvest disturbance, general guidelines suggest these strips should be a minimum of 20 metres wide along perennial streams of less than 20 m width and at least 50 m wide along larger streams, rivers and lakes.

- Increasing uneven-aged management by extending harvest rotation times and aggregate cuts over time, to minimize induced edge effects and fragmentation and increase structural diversity, and leaving behind some dead trees and downed woody debris (Franklin and Forman 1987; Noss 1987; Harris 1984; Hansen *et al.* 1991; see Figure 13.3-4).
- Encouraging directional felling and planned extraction of logs along rationally located skid trails and roads. Planning of extraction pathways can greatly reduce both logging damage and logging costs (d'Silva and Appanah 1993).
- Using natural temporal patterns when considering rotation periods. Stands of different age (including protected old growth) should be distributed across the landscape in ways that reflect natural spatial patterns. Premature cutting should be prohibited and seed trees should be evenly distributed (d'Silva and Appanah 1993).
- Finally, consider using impact studies, registration of natural assets, and environmental audits that can be carried out on commercial forest lands – something that large forestry operations are increasingly using in a number of countries (Pott 1992).

Such guidelines should be viewed as provisional working hypotheses to be tested, revised, prioritized and adapted to region (b) and site-specific ecological conditions. Environmental damage related to logging and forest management activities is all too often excessive because of the lack of any planning and the absence of control over harvesting activities (see, for example, Jonsson and Lindgren 1990; Appanah and Wienland 1991). This continues to be a serious problem in many tropical areas, and occasionally also in temperate areas. Because such guidelines often mean harvesting timber at lower intensities, in smaller areas, or over extended rotation lengths, managing biodiversity in production forests will often be viewed as luxuries by timber producers.

There are, however, encouraging developments that auger well for managing biodiversity in forest production areas. Several international efforts, including the 'Montreal Process' and the 'Helsinki Process' which cover all temperate and boreal forest countries, have developed criteria and indicators for sustainable forest management,

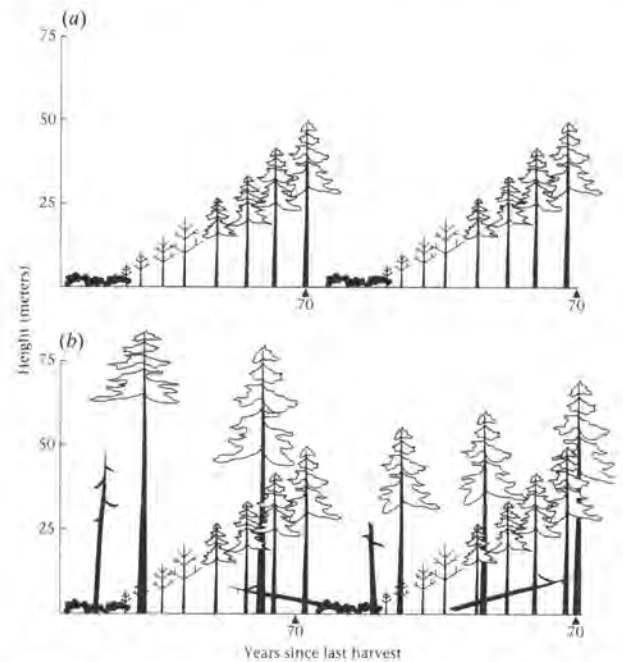

Figure 13.3-4: (a) Conventional clear-cutting methods in the US Pacific Northwest remove all trees from an area on a 70-year cycle, thus reducing the structural diversity and habitat for a wide range of species. (b) Proposed new practices maintain the structural diversity by leaving behind some old trees, standing dead trees, and fallen trees, and increasing rotation lengths. (Source: Hansen *et al.* 1991.)

including the conservation of biodiversity (Sizer 1994). Independent certification of forestry operations as being 'sustainably managed' has grown dramatically in recent years. The Forest Stewardship Council (FSC) has been organized to set minimum standards for independent certification, and the International Standards Organization (ISO) may develop standards for sustainably produced wood products as well. Several principles underlying the FSC accreditation of independent certifiers are relevant to the management of biodiversity (see Box 13.3-4).

13.3.3.2.3 Biodiversity inventory and monitoring. Adaptive management principles (continuous monitoring of key variables and revision of management activities; see 13.1) are essential to maintaining biodiversity in managed forests. Most evidence of the sustainability of natural forest-management systems remains unconvincing (see Johnson and Cabarle 1993). Vague management objectives and a lack of project monitoring undermine its credibility, and most projects do not last long enough to be useful as a basis for judging sustainability. Timber yield and natural regeneration rates are offered as 'evidence' of sustainability because most forest managers do not monitor anything else.

Besides integrating research and monitoring much more fully into their projects, forest managers need to track and monitor a wider range of ecosystem indicators. These could include:

Box 13.3-4: Forest Stewardship Council principles for sustainable forest management.

The Forest Stewardship Council (FSC) was established in 1993 to promote good forest management world-wide, based on a set of principles designed to ensure that all forests are managed in a way that is environmentally responsible, socially beneficial and economically sound. The main objective of the FSC is to link the 'green consumer', who may be willing to pay more for sustainably produced wood and wood products, with producers who are seeking to improve their forest management practices, obtain better market access and achieve higher revenues. The idea is to harness market forces to reach specific environmental goals. The FSC's main functions are to evaluate, accredit and monitor timber certification organizations that inspect forest operations and issue a label claiming that timber was produced sustainably and in accordance to the FSC's principles and criteria. The FSC Principles of Forest Management include:

Compliance with laws and FSC principles. Forest management systems shall respect all applicable laws of the country in which they occur, and international treaties and agreements to which the country is a signatory, and comply with all FSC principles and criteria.

Tenure and use rights and responsibilities. Long-term tenure and use rights to the land and forest resources shall be clearly defined, documented and legally established.

Indigenous peoples' rights. The legal and customary rights of indigenous peoples to own, use and manage their lands, territories and resources shall be recognized and respected.

Community relations and workers' rights. Forest management operations shall maintain or enhance the long-term social and economic well-being of forest workers and local communities.

Benefits from the forest. Forest management operations shall encourage the efficient use of the forest's multiple products and services to ensure economic viability and a wide range of environmental and social benefits.

Environmental impact. Forest management shall conserve biodiversity and its associated values, water resources, soils and unique and fragile ecosystems and landscapes and, by so doing, maintain the ecological functions and integrity of the forest.

Management plan. A management plan – appropriate to the scale and intensity of the operations – shall be written, implemented, and kept up to date. The long-term objectives of management and the means of achieving them shall be clearly stated.

Monitoring and assessment. Monitoring shall be conducted – appropriate to the scale and intensity of forest management – to assess the condition of the forest, yields of forest products, chain of custody and management activities, and their social and environmental impacts.

Maintenance of natural forests. Primary forests, well-developed secondary forests, and sites of major environmental, social or cultural significance shall be conserved. Such areas shall not be replaced by tree plantations or other land uses following harvest.

Plantations. Plantations shall complement, not replace, natural forests. Plantations should reduce pressures on natural forests (This is a draft principle not yet ratified by FSC membership).

(Source: FSC 1994.)

- **Regeneration:** indicators should reflect natural regeneration rates of important successional and dominant tree species.
- **Biodiversity:** indicators should, at a minimum, reflect the status of key pollinators and seed dispersers. However, since so little is known about the role of most species, it would be better to broadly monitor the status of a cross-section of biodiversity (plants, mammals, birds, invertebrates).
- **Microclimate:** temperature, humidity and soil moisture are crucial determinants of germination and seedling/sapling survival for most tree species and may be affected dramatically by forest-management activities.
- **Nutrients:** indicators should be used that can reflect mineral nutrients, soil organic nutrients, and soil microfaunal levels.
- **Hydrology and erosion:** indicators should measure soil-erosion rates, water quality, and hydrologic regimes.
- **Pathologies, wind, and fire:** outbreaks of insect pests and diseases, windfalls and blow-downs, fuel loading

and fire, and other potential threats to tree species, should be monitored.

Ideally, these indicators would be tracked regularly before, immediately after, and between harvests, and then compared with measurements in control areas. A basic research programme to correlate the impact of management activities with forest ecosystem health indicators will help forest managers balance resource-extraction levels, manage their intensities, and monitor forest health. Social and economic indicators could also be monitored in and around managed areas, since these factors may be more important leading indicators of concern to the maintenance of biodiversity than many biophysical indicators (see Reid *et al.* 1993).

Monitoring such indicators is easier said than done. Since commercial forestry operations are faced with economic constraints that rely heavily on cost-efficient methods of resource assessment, low-cost methods are needed to inventory and monitor production forest areas for impacts on biodiversity.

13.3.4 Managing biodiversity in fisheries

To an even greater degree than with forests, fisheries and the coastal and marine ecosystems that support them are treated as commonly owned resources. Sustainable harvesting of commonly owned aquatic resources has proved difficult, and it has become a truism that declining fisheries have become one of the most notable manifestations of Hardin's (1968) 'tragedy of the commons'. Over-fishing changes the relative species abundance as well as the demographic and genetic structure of populations (e.g. Ryman and Utter 1987; Ryman *et al.* 1994). In region after region, the familiar pattern of increasing catch, population depletion and collapse of a fishery is followed by a switch to exploiting more remote populations and often a switch to less valued species. Of the 176 major fish populations that the United Nations Food and Agriculture Organization (FAO) currently track, 30% are over-exploited. The situation in Europe may be worse where some 90% of North Atlantic fish stocks are being over-fished (Osherenko and Young 1993). With the world population expected to double by 2050 and rising expectations for quality of life, human demands for fish products will increase even as consumption on a per capita basis declines (FAO 1991). The only way to meet these demands is to use more sustainable fishing practices that minimize the risk of irreversibly harming ecosystem structure and essential processes (Beverton 1993).

13.3.4.1 Managing biodiversity in traditional fisheries

Conventional wisdom suggests that commonly owned resources can be sustainably used only if they are converted to private property, or alternatively, if government regulations are imposed. Two key characteristics of

fisheries, difficulty of exclusion and subtractibility (the capability of each user subtracting from the welfare of others), are commonly cited as the reasons for such choices (Berkes *et al.* 1989; Feeney *et al.* 1990). Recent findings in fisheries management (similar to findings in forestry, wildlife, rangeland and water resource management), however, suggest this may be a false choice. Examples from traditional and small-scale fisheries indicate that:

- there is no intrinsic reason why commonly owned resources such as fisheries are doomed to over-exploitation;
- sustainable management is possible under three general kinds of management regimes: private property, state property and communal property;
- examples of successful community-based fisheries and marine resources management are found in many cultures and areas around the world;
- two necessary conditions for successful community-based resource management are the ability to limit the access of outsiders and to make and enforce rules among community members; and
- conservation by self-interested users of a resource may be the most robust approach to sustainability. Incentives for users to conserve must, therefore, be built into any fishery management plan including traditional community-based approaches (McCay and Acheson 1987; Berkes 1989; Ostrom 1990; Bromley 1992).

Many traditional fishermen live in communities in which resource use is never unrestricted and property is never purely private or government-owned. These communities have instead evolved mechanisms of collective decision-making and conflict resolution, and informal regulations to limit non-sustainable practices (Johannes 1978; Ruddle *et al.* 1992). Based on evidence from traditional and artisanal (small-scale) fisheries, a new common property theory has emerged as a basis for more sustainable fisheries management. It emphasizes the role of traditional use rights and traditional knowledge and the importance of property rights and institutions, rather than the earlier emphasis on technical fisheries management and transforming or replacing traditional and small-scale fisheries with large-scale fisheries (Larkin 1988).

In Southeast Asia, traditional marine tenure systems function in various ways. For example, in parts of eastern Indonesia the traditional system of *sasi* or 'prohibition' includes a wide range of customary laws designed to ensure equitable opportunities for deriving both subsistence and economic incomes from coastal resources. These include community-enforced rules regarding the use of gear, times when fishing for particular species is allowed, and size limits. Sanctions for violations include fines, public

shaming, confiscation of fishing gear, corporal punishment, and even exile (Zerner 1994).

On Batanes Island in the northern Philippines, groups of *mataw* fisherman practice sacred rituals to respect their *vanua* or fishing ground, regulate access to the fishing grounds, and set individual daily catch limits (i.e. only nine per fishing trip) for migratory dolphin fish (*Coryphaena hippurus*). In addition, they regulate the fishing of bait species such as flying fish and bait shrimps and crabs to maintain the *mataw* fishing operation. Punishments and fines are prescribed for violations of the 'formal fishing laws' agreed upon for each fishing season (Mangahas 1994). Even where private ownership of fish-aggregating devices (FADs) for nearshore and offshore pelagic fish species such as tuna is recognized (as it is in many Asian fisheries), customary sharing systems may allow outsiders to fish with hooks and lines in the FADs when the owners are not fishing.

In North America, co-operative resource management (or co-management) is used by indigenous peoples in Canada, Alaska and some parts of the mainland United States. In these areas, indigenous communities share authority and responsibilities with federal and state agencies (Berkes *et al.* 1989). These co-operative management regimes are designed to maintain and reinvigorate indigenous systems of territoriality and social control that contribute to sustainable and equitable resource use (Young *et al.* in press). Native rights are recognized by a variety of treaties, acts, laws and regulations, which differ from place to place. Social scientists studying co-management regimes find that they typically include socially defined groups, territorial limits, patterns of use that are both socially reproducible and multi-dimensional, and collaborative mechanisms for effective and appropriate monitoring and regulation (Young *et al.* in press).

Three types of factors contribute to sustainable fisheries and marine resources management (including marine mammals) by traditional cultures in North America:

Unintentional factors. Limited financial resources restrict access to distant areas and limit the type of gear that can be used. This keeps catches lower than they might otherwise be and ensures that some waters are fished infrequently or not at all. As a result, refuge stocks and genetic diversity are maintained. Government policies and social changes have also concentrated populations in villages where schools, medical and support services are available, thus enhancing this effect.

Cultural factors. The concept of fishing for personal wealth or to enhance status in the community has been uncommon in many cultures: fishing was limited to catching only what was needed by the fisher, his family and others in the community. Seasonal patterns of

harvest evolved over time to maximize returns with minimum effort – for example taking salmon during spawning runs – in ways that may have the least impact on population structures. Taking only certain-sized fish may contribute to maintaining fish community structure (Berkes 1977; Hopper and Power 1991). Cultural factors, however, may become less important in the face of increasing costs associated with fishing.

Outside controls. Laws and regulations for conservation by state/provincial and federal authorities are often – though not always – accepted to help maintain fisheries and marine resources in the face of pollution, introduced species, and multiple outside demands on resources. These are imposed by non-indigenous organizations, often in the name of conservation (Collection Nordicana 1992).

The future of traditional fisheries and marine management is, however, uncertain in many parts of the world. Pollution in the Russian Arctic and elsewhere may pose significant risk to indigenous use of marine mammals. Political debates arising from uncertainty about the status of marine mammal populations reveal differences between indigenous and Western scientific knowledge systems (Bielawski 1992). In the International Whaling Commission deliberations about Alaskan bowhead whale stocks, indigenous knowledge and management systems have often been overlooked or dismissed by scientists (Huntington 1992). Changing ecological dynamics, introduction of new technologies, uncertainty about the status of marine mammal populations, the impacts of outside resource users and managers, and conflicts over hunting marine mammals, have dramatically altered Aleut relationships with sea otters and seals (Veltre and Veltre 1987). Ideological battles are waged over the appropriateness of killing marine mammals (Lyng 1991).

In tropical nearshore waters in Asia and Oceania, most traditional marine tenure and management systems are not well documented (Johannes *et al.* 1991), despite a resurgence in awareness and appreciation of such systems (Hatcher *et al.* 1990). Nevertheless, many fishery managers continue to assume that fishermen will overharvest the resource if left to their own devices. While such assumptions are not universally justified, community-based management in many areas is breaking down in the face of population growth, social and political disintegration, technology change, commercialization and habitat degradation and pollution (Berkes 1989; Ostrom 1990).

Traditional rights have become more ambiguous under these conditions and, in part because they are not clearly defined in government statutes, are the source of increasing disagreement over their interpretation (Pearse 1988). In North America the recent tendency has been to recognize

the special rights of native groups to fish for food but not necessarily to fish for trade or commerce. New agreements, land-claim settlements and regulations give precedence first to conservation, then to native food fisheries, before other uses can be entertained. The balance of rights between various users is unstable, nevertheless, and commercial and sport fisheries interests frequently engage in conflicts over traditional rights (Cooley 1963; Larkin 1979; Mullan *et al.* 1992).

Traditional practices and customs, however, are finding new life in revised legal frameworks and management systems for coastal management in some areas. For example, in the Moluccan islands of Indonesia the traditional *sasi* system is being reinterpreted by some government leaders and NGOs to help develop new approaches to coastal and marine management. Such approaches, if they are to be effective, will need extensive education efforts, administrative and legal reforms, resolution of potential tenurial conflicts over community-based marine management areas, and experimentation through the establishment of carefully designed and monitored pilot projects (Zerner 1994). Projects in the Philippines and South Pacific that integrate the idea of a totally restricted marine reserve with a marine conservation area under sustainable local controls (White 1989; Johannes *et al.* 1991) recognized by national and local government may hold wider promise for the sustainable use and management of marine biodiversity – at least in areas where traditional systems are still partially intact.

13.3.4.2 *Managing biodiversity in small-scale fisheries*

In most countries, small-scale fisheries are common. These fisheries use smaller boats and gear than large-scale deep-sea fisheries, but are not bound by the norms of traditional fisheries. The major problems of small-scale coastal fisheries are overfishing and the degradation of habitats such as coral reefs, seagrass beds, mangrove forests and estuaries (e.g. Pauly and Chua 1988). Several measures are used to address these problems. National fishery agencies normally regulate specific fishery resources through imposition of closed seasons, minimum sizes of organisms caught, regulation of mesh size, limitation on gear types, etc. However, because of the weak enforcement capabilities of many such agencies, there is often little compliance with these measures (Pauly *et al.* 1989).

Management interventions to abate further deterioration and rehabilitate degraded marine habitats include, for example, seagrass and mangrove replanting (Gan Boon 1993) and the setting up of artificial reefs. Unfortunately in many cases, setting up of artificial reefs has functioned more as a fish-attracting device, contributing further to overfishing rather than acting as a means of conserving and managing reef fisheries (e.g. de los Angeles and Pelayo 1993).

Many tropical countries have increased the establishment of multiple-use marine parks (Salm 1983; Kelleher and Kenchington 1984; McManus 1988; see also 13.4.1) in line with integrated coastal management programmes. There is little or no active management in many of these areas, however, and few of these conservation areas have been assessed for their effectiveness (Alcala 1988; Hatcher *et al.* 1990).

Water pollution has also contributed to the decline of fishery resources. While strict pollution-control policies have been adopted by national governments and coordinated through regional programmes, their success has been limited (reviewed in Portman *et al.* 1989; Brodie *et al.* 1990; Gómez *et al.* 1990; Sen Gupta *et al.* 1990).

In developing tropical countries, the failure of many conventional fisheries measures is ultimately caused by acute socioeconomic pressures (Pauly *et al.* 1989), pressures not easily addressed by better enforcement or narrowly focused policies. In a broad sense, fisheries management in Southeast Asia, for example, is challenged more by social and economic conditions ('people problems') than by a lack of suitable resource management tools. This is illustrated in the Philippines, where 3.5 million artisanal fishermen share about 50% of the country's fishery production (Smith 1979). Consequently, management of inshore tropical waters must include efforts to alleviate fishing pressure by developing alternative sources of livelihood for artisanal fishermen. This may include livelihoods that have no direct connection to the fisheries resource such as tourism, small business enterprises and household cottage industries, or it might mean developing aquaculture for food production (see 13.3.4.5). Aquaculture is also being used to restock depleted natural fisheries (see 13.3.4.5). Finally, public education is a critical component in the implementation of sustainable use and management measures (e.g. White 1989).

Community-based fishing co-operatives are increasingly advocated as a means of improving the livelihoods of small-scale fishermen and of strengthening local resource management, especially in the Caribbean and some Asian nations (Renard 1991; Poltan-de la Cruz 1993). In some areas, including the Turkish coastal fisheries (Berkes 1986), Maine lobster fisheries (Acheson 1975), and Japanese coastal fisheries, laws place the control of the local resource in the hands of community-based fishing co-operatives (Ruddle 1987). These initiatives are departures from prevalent forms of more centralized *de jure* state control of fisheries resources and *de facto* open access conditions on the water. Decentralization of resource management through the granting of some territorial use rights (García 1992), some of them closely akin to traditional marine tenure systems, may actually strengthen the sustainable use of fisheries.

For example, in the Philippines, the 1991 Local Government Code confers jurisdiction over marine areas within 15 kilometres of the shoreline to local governments and provides preferential rights for organized artisanal fishermen – in effect recognizing the limited ability of national and provincial governments to manage the resource effectively. This devolution of legal control has set in motion widespread community organizing, participatory applied research, and community-based management planning. It has also stimulated greater interest in, and use of, traditional knowledge and traditional marine tenure systems as part of contemporary management practices.

The common property framework suggests that property rights regimes may be combined in order to effectively address a particular resource management problem. Fishery regulations in parts of Europe, for example, are jointly developed and negotiated between governmental managers and local fishermen. In the Lofoten Islands cod fishery in Norway, the state empowers fishermen to update regulations and enforce them under the Lofoten Act of 1890 (Jentoft 1985).

Because of the widespread limits of governments to define, monitor and enforce suitable regimes to use and manage fisheries sustainably, the sharing of management power and responsibility between the state and the fishing community (co-operative management or co-management) is receiving increased attention around the world (Pinkerton 1989; Pomeroy 1993). The co-management model is particularly useful if management of the fishery is complicated by a diversity of users. To retain incentive structures for community-based conservation, such management approaches generally seek to include as little government regulation as necessary and as much local-level control as possible.

13.3.4.3 *Managing biodiversity in large-scale fisheries*

What are the obstacles to sustainable harvesting in large-scale fisheries? Scientific knowledge is often sufficient to indicate unambiguously the direction in which management should go – at least for major long-established fisheries. While information on living aquatic resources is limited for offshore fisheries in many developing (and some developed) countries, the most important obstacle is the lack of control over access to fisheries and fishing effort. The failure of politicians to address these factors has greatly limited management effectiveness. Fisheries managers and the fishing industry itself are only reluctantly coming to accept that technical measures alone (e.g. minimum mesh sizes of fishing gear) will rarely be sufficient to maintain or rebuild fisheries stocks. In some cases, they are also questioning the effectiveness of catch quotas where rigorous monitoring and enforcement are not in place.

In theory, fish populations can be harvested sustainably in large-scale fisheries with proper management. Even long-lived species (such as tuna or whales) have a high intrinsic rate of increase that should allow the harvest of surplus production (May 1976). In the 1950s, a substantial effort was mounted to develop quantitative theories of fisheries management that could be used to avoid stock depletion. For example, the development of surplus-yield models (Ricker 1954), which provided the foundation for cohort analysis, and dynamic pool models (Beverton and Holt 1957) were used to provide estimates of the maximum equilibrium catch or maximum sustainable yield (MSY). However, the surplus-yield models ignored population structure and contributed to the over-exploitation of some fisheries (Larkin 1977; Hilborn and Walters 1992). They are now held in some disrepute.

Modern dynamic pool models are a further development of Beverton and Holt's (1957) early models. These models include four main sub-models:

1. individual growth rate;
2. recruitment rate of the population;
3. natural mortality rate; and
4. fishing mortality rate.

Each sub-model can be broken down into complex and realistic systems that include demography, the effects of environmental variability, and interactions between the target population and predators, competitors and prey species. The goal of scientific management of large fisheries is to quantify the variables in the four sub-models, and based on this, estimate yield. This is, however, a difficult task. Even simple multi-species models are still not effective management tools in most systems, given current knowledge (Kock 1992).

Although the exact maximum sustainable yield is difficult to know before populations become overfished (Hilborn and Walters 1992), MSY has been a useful concept for discussing fishery management problems (Gulland 1989). It serves three distinct functions by providing a description of the status of fish stocks in relation to exploitation, a quantitative management objective that can be monitored, and a measure of the success of population management. Maximum sustained yield values, however, must be evaluated continuously to allow for the variation in population abundance that occurs in all natural systems because of demographic and environmental variability. Otherwise, population sizes may fall below ranges upon which the initial MSY values were based. When the demographic parameters of a harvested population are unknown and uncertainty in the estimates of the total population is high, the optimal strategy is to avoid large short-term harvests and set management objectives below MSY values that have been determined by incomplete or uncertain data.

Accurate yield estimates based on multispecies models are in most cases a future goal, not a current reality. Simpler methods are therefore needed to estimate MSY. According to Beverton (1993), optimal catch most often appears to be achieved when the spawning stock biomass is one-quarter to one-third that of the unfished size of the fish population. However, the unfished biomass is unknown in most heavily fished populations and, in any event, it is highly variable. A simple and more robust guide to MSY is a fishing rate of between one-and-a-half to twice the natural mortality rate. In sharks and rays (elasmobranchs), which are long-lived and have low fecundity, MSY is likely to be reached when fishing mortality is much closer to natural mortality rates (Beverton 1993).

If all stocks were fished close to their real MSY, most of the problems of overfishing and conservation would be resolved. However, it is possible to do even better than trying to fish at MSY. Because the response curve of yield is relatively flat in the region of MSY, it means that 95% of the expected MSY could be achieved with 30% less fishing and hence a 20% higher spawning stock biomass. This small sacrifice in expected yield makes good sense economically because it results in higher catch-per-unit effort, larger average size of fish caught, and reduced variability in catches. The larger stock would also provide a better cushion against inevitable regional and potential global climate changes.

In most stocks the reduction in population caused by harvesting at MSY would be less – often a great deal less – than the natural demographic variability that species are adapted to. Some modification of this simple principle is needed for fisheries with multispecies communities that have strong biological interactions, such as the cod, capelin and herring fisheries in the Barents Sea (Beverton 1993; Hamre 1994; Gjøsaeter 1995). In such cases, adaptive management informed by good science is essential for achieving a balanced harvest of the interacting species (Hilborn and Walters 1992).

13.3.4.4 *Newly evolving practices in large-scale fisheries*

Concern over the sustainable use of aquatic resources is not new. Since the turn of this century, numerous international conferences have been convened and several international fisheries management bodies have been established to address the need to develop fisheries management regimes that maintain stocks and protect other aquatic species (e.g. seabirds, marine mammals, sea turtles, etc.) from the effects of fisheries exploitation. Recently, FAO's Committee of Fisheries (COFI) developed the concept of 'responsible fishing' to encompass a broad range of principles for the sustainable management of marine resources, including biodiversity. These principles are intended to ensure the sustained yield of diverse fish stocks from oceanic, coastal and inland fisheries, and to ensure the maintenance of biodiversity.

Responsible fishing is based on a management regime with the following characteristics:

Development of more reliable scientific information.

Although there have been significant achievements in fish stock assessments, there is room for substantial improvement in data collection, statistical analysis, and the understanding of ecosystem interactions on the development of single stocks.

Better use of scientific information in management.

Total allowable catches (TAC) for fish stocks are set by the fisheries management agencies, often at levels higher than those recommended by resource biologists. There are many cases where this (mal)practice has resulted in overfishing and stock depletion.

Development of selective fish-capture methods.

Globally, 80 million metric tons of marine 'target species' are landed on an annual basis. However, recent estimates indicate that an additional 30 million tonnes of non-target fish (by-catch) are discarded annually – an amount equal to 25% of the target catch – because the species or size is non-marketable. Recent work has focused on the problem of by-mortality of fish and other organisms that are not actually caught but may suffer mortality after escapement from fishing gear. This mortality should be included in stock assessments and steps taken to reduce by-catch and by-mortality.

Combining fisheries regulations with better control measures.

Most major fisheries are now regulated by various means (quotas, minimum mesh size of gear, minimum legal fish size, time and area restrictions of fisheries, etc.). Together, the various regulations represent an important element of the responsible fishing concept. However, the success of these regulations is highly dependent on good control measures. The introduction of exclusive economic zones (EEZs) of 200 nautical miles has greatly improved the enforcement of fishery regulations, as the stocks within the EEZs are under jurisdiction of the respective coastal states.

Imposition of management and control on the high-seas fisheries.

Fisheries on the high seas – or parts of the oceans not covered by national EEZs – are not managed or controlled. This is particularly a problem for straddling stocks and highly migratory species that are distributed, at least partially, outside national EEZs and thus accessible for uncontrolled exploitation. This part-time access of the commons to otherwise nationally controlled fish populations is a major loophole in the proper management of these stocks. There is an urgent need for

the international community to find solutions to the jurisdiction and management of the high-seas fisheries.

These elements of responsible fishing are likely to be a cornerstone of future marine fisheries use. In addition, responsible fishing must include efforts to manage harvest levels and methods so that commercial fishing does not endanger other marine species. The use of turtle exclusion devices (TEDs) in the Gulf of Mexico shrimp fisheries, the banning of drift-net fishing in the Pacific, and a number of other efforts are steps in this direction. Other steps will need to include defining minimum biologically acceptable levels (MBALs) for populations of seabirds, marine mammals, and other non-target species, and then monitor the impact of fisheries harvests on these levels and adjust quotas and other management goals accordingly. New international mechanisms or existing global agreements, such as the Convention on Biological Diversity, should be used to obtain a general agreement on how marine biodiversity (i.e. non-commercial species) can be maintained under commercial fishery management regimes.

13.3.4.5 Managing biodiversity in aquaculture

Aquaculture is the farming of fish and other aquatic organisms (e.g. crustacea, molluscs, macro-algae) for food and other purposes. While only about 13% of the world's fish and other aquatic produce comes from aquaculture, it is growing rapidly; at 6–7% annually, it is currently the fastest-growing food production sector in the world (Pullin 1994). Despite this growth, aquaculture is relatively undeveloped compared to agriculture and capture fisheries from coastal, marine and inland waters. With global declines in capture fisheries, and limited growth in agricultural production, aquaculture will continue to expand rapidly in coming decades.

To sustain that expansion, the genetic diversity of farmed organisms must be managed sustainably. Aquaculture productivity also depends on a wide diversity of other aquatic organisms for food and for maintenance of water quality. Aquaculture, in turn, can have adverse impacts on the diversity of natural populations of aquatic organisms and the structure of ecosystems through the release of farmed organisms or, for example, the conversion of mangrove forest habitats to shrimp ponds.

Most aquaculture produce comes from about 200 species. For example, Pullin (1992) estimates that 95% of aquaculture production comes from 181 species – six seaweeds, 43 molluscs, 27 crustaceans and 105 finfish. Intraspecific genetic diversity, which is relatively well known in agriculture, is virtually unknown except for common carp (*Cyprinus carpio*), some salmonids and catfish, and more recently tilapias (Eknath *et al.* 1993).

Since domestication for most aquaculture organisms has not progressed far, most farmed organisms are close to wild

types (Pullin 1994). Genetic diversity, therefore, is a barely tapped resource for domestication and productivity improvements. A growing array of technologies, including gene transfer, is being used by fish breeders even before more conventional breeding methods (selective breeding and hybridization) have been applied to most species.

Aquatic biodiversity is being lost at alarming rates in natural systems, especially inland waters. For example, Moyle and Leidy (1992) estimate that at least 20% of freshwater species are already extinct or in serious decline. The vast majority of this decline has been caused by pollution, human-induced structural changes in aquatic habitats, and the release of introduced species. These losses will constrain efforts to evaluate the aquaculture potential of aquatic organisms. Indeed, it is now becoming difficult for fish breeders to locate and collect genetic materials from healthy or relatively undisturbed wild populations (Pullin 1988, 1994).

Documentation of wild genetic resources and threats to their survival is the first step toward implementing specific measures to protect the wild populations and their environments. The International Center for Living Aquatic Resources Management (ICLARM) and FAO have developed a database (FishBase) that now includes nearly half the world's finfish, including nearly all of those that are directly useful to humans. The database includes information on the degree and type of threats to fish species in addition to an array of taxonomic, genetic, physiological and ecological information on each species (Froese and Pauly 1994). Distributed on CD-ROM, this database is now being used by international, national and state/provincial management agencies in Europe, Africa, Asia, Latin America and the United States. Pullin (1994) suggests identifying opportunities to protect and sustainably manage endangered aquatic species, such as those found on FishBase, within larger programmes for protected areas and terrestrial wildlife species management.

Like agriculture and forestry, aquaculture can have serious adverse impacts on biodiversity, possibly even more so because of the connected fluid environment of aquatic ecosystems. The escape of captive-bred fish, for example, can contribute to the loss or depletion of wild stocks through predation, competition for food and breeding sites, the spread of disease, changes in water clarity or turbidity, and interbreeding with wild stocks (Billington and Herbert 1991). Risks of adverse environmental impacts are generally higher with exotic species than with indigenous species. In many countries, especially developing countries, there is virtually no active effort to prevent introductions, and quarantine measures for transferring stock are generally lacking.

The potential impacts of aquaculture on biodiversity have sparked fierce debates over the need for stricter measures to prevent intentional and accidental release of captive organisms. Legacies of escapes are widespread and often appear to be permanent. For example, the golden

snail (*Pomacea*) escaped from captivity in the Philippines and now infests over 400 000 hectares (Acosta and Pullin 1991). Such escapes can also affect aquaculture directly. Feral populations of a tilapia species initially favoured for aquaculture (*Oreochromis mossambicus*) have spread throughout the tropics and subtropics and are now hybridizing with one of the tilapia species (*O. niloticus*) currently preferred in aquaculture (Macaranas *et al.* 1986). The effects of hatchery programmes on wild stocks is vigorously debated, with some (e.g. Hilborn 1992) arguing that hatchery programmes are contributing to a serious loss of genetic diversity in wild populations, while others (e.g. Nehlsen *et al.* 1991) argue that many other factors could be responsible for genetic decline.

Broad overviews, such as that provided by Hindar *et al.* (1991) suggest that escapees from aquaculture pose a significant threat to genetic diversity in wild (and sometimes captive) populations of fish. The following measures, drawn from a number of sources (Billingsley 1981; Ryman 1981; Allendorf 1991; Hindar *et al.* 1991; Waples 1991; Hindar 1992; Hansen and Jonsson 1994), are recommended to maintain diverse stocks to improve aquaculture and minimize the adverse impacts of aquaculture on wild stocks:

Closed culture: better containment to prevent escape of the organism.

Sterilization: easily induced way of avoiding direct genetic effects.

Localization: locating farms away from wild populations, and choosing locations for sea ranching that minimize straying so as to reduce gene flow to wild populations.

Coastal parks: providing totally protected areas for valuable wild populations.

Reduced or selective fishing: protecting native populations by reducing fishing pressure or by directing that pressure toward cultured fish.

Restrictions on transport: reducing the spread of exotic genes and diseases by restricting transport of live fish and eggs.

Gene banks: counteracting extinction of local populations by the establishment of gene banks.

Minimal genetic differences from native populations: reducing effects of gene flow by minimizing the genetic differences between escaping or released fish and recipient wild populations.

Training of workers: basic training of aqua-culture workers (including non-specialists) to minimize the risk of accidental releases of organisms into aquatic ecosystems.

13.3.5 Managing wild flora and fauna

Wild animals and plants are harvested by people throughout the world for food, shelter, traditional

medicines, dyes, fibres, tools, religious purposes and cash income. Such harvests are motivated by cultural traditions, by survival needs, for cash income, and for recreation. Although there is no comprehensive source of data to document the full extent of trade in wild species products, Fitzgerald (1989) using CITES statistics estimated that the international trade in primates, ivory, orchids, reptile skins, furbearers and tropical fish was worth US\$5 billion in 1986. Moreover, hunting, sport fishing, and other uses of wild populations (e.g. mushroom collection) are at the centre of rapid growth in recreation and tourism in both developed and developing countries. For example, the US Fish and Wildlife Service estimates that wildlife-related recreation (e.g. hunting, fishing, birdwatching) in the states of Oregon and Washington contributes as much as US\$2 billion in direct and indirect benefits annually to the regional economy (USFWS 1988). See Section 12 for further discussion on the valuation of wild species.

While substantial research efforts and money are invested in many countries to manage game populations and sport fisheries, efforts are only now beginning to assess the impacts on biodiversity of many human uses of wild species. Again, as with sustainable forestry, agriculture and fisheries management, one of the keys to the successful management of wild species is restricting access to the harvest of wild populations.

13.3.5.1 Wildlife management

Harvesting wild plants and animals influences the composition, structure and functions of populations and ecological communities. Diversity and density may decrease due to selective harvesting of sex, age, size or other phenotypic types. Deer hunting, for example, is often targeted at large, dominant males. Before European settlement in North America, wapiti (*Cervus elaphus*) were opportunistically harvested without respect to sex and age. Since European settlement, harvesting has become more selective and targets older males. As a consequence of the new harvesting regime, the population structure has changed and individuals have experienced a decrease in longevity (Davis 1983).

Harvesting, however, can also maintain the vitality and productivity of a population, especially in the absence of natural predators. On St Matthew Island, Alaska, the introduction of reindeer, their rapid population growth and subsequent population crash indicates how a lack of management, including harvesting, can lead to problems (Klein 1968). Productivity is often maximized at an intermediate population density. Harvesting regimes, informed by data on demographic and population trends, may serve to maintain viable populations and healthy individuals as illustrated in Scandinavian cervid herds (see Box 13.3-5).

Early wildlife management models were based on the ecology of the individual species of interest. Management approaches now often recognize differences in the individual populations that are harvested (Caughley 1994). This, however, requires precise ecological information, which is frequently unavailable (Gross *et al.* 1992). In some cases, too, rare individuals of a certain phenotype or genetic composition may have effects on the population far beyond their relative biomass and numbers. Environmental variation causes much of the change in the size of a population and promotes the coexistence of genotypes or species in communities. Recent theoretical and empirical results have identified conditions that relate environmental variation to long-term population dynamics (Lubchenco *et al.* 1991). These findings are directing attention to the ways in which environmental fluctuations affect populations.

In addition to environmental change, harvested populations can rise and fall in relationship to other species and there is a need in wildlife management to develop multi-species models which should at least include the

harvested species and their resource base. Ideally, they should include *all* important associations related to the sustainable harvesting of the species of interest. Furthermore, wildlife management models should account for stochastic environmental factors such as weather conditions, which may affect the resource base for the target species.

Future management models should also include risk assessment for extinction in the context of changing environmental conditions (Lande *et al.* 1994). In cases where population estimates are uncertain, and detailed demographic data do not exist, the optimal long-term strategy is to harvest at less than maximum sustained yield (MSY) (see 13.3.4.3). Harvesting at the calculated MSY level should occur only when adaptive management techniques indicate what that level is.

13.3.5.2 International commerce in wild species

The export value of wildlife products is large. Based on the Fitzgerald (1989) estimate of international trade in exotic

Box 13.3-5: Management of cervid populations in Norway.

Since prehistoric times in Norway, cervids (moose, red deer and reindeer) have represented an important food resource for people, and have provided raw material for clothing and tools (Gjessing 1945; Ahlen 1965). Early settlements were often associated with extensive trap systems for cervids (drift fences, bow stands and pitfalls) operated and maintained through co-operative efforts (Gjessing 1945; Molmen 1988). The predictable occurrence of different species in space and time, and the potential catching capacity of the trap systems, influenced both the location and organization of the communities (Skogland and Molmen 1979; Langvatn 1990; Andersen 1991).

Today, the harvest of moose, red deer, reindeer and roe deer in Norway is regulated through permits issued by municipal wildlife boards, usually specifying sex and age categories of animals that can be shot each year. The number and specification of hunting permits issued are based on censuses, information on population structure, and habitat area.

Monitoring the demography, physical and reproductive performance, and habitat status of different cervid populations is a vital part of long-term sustainable management. A sub-sample of 10–20% of the animals harvested each year provides an accurate analysis of age distribution, cohort variation and reproduction (Skogland 1985, 1988; Langvatn and Albon 1986; Langvatn 1993; Albon *et al.* 1992; Andersen and Heim 1993; Saether and Heim 1993; Langvatn *et al.* 1995). Cervid populations exert a significant effect on vegetation, and may affect habitat structure and species composition in an area. Ongoing monitoring of the impact of cervid populations on their habitats is also an important part of a harvesting policy that focuses on the vitality and viability of cervid populations and concern for maintaining biodiversity in general.

Harvests of cervid populations entail potential threats to demographic as well as genetic diversity of the populations. The issuing of permits aims to avoid drastic fluctuations in population size, thus preventing genetic drift at low levels, and habitat deterioration and reduced performance of the individuals at high population densities. It attempts to harvest different sex and age categories approximately in proportion to their occurrence in the population (Gill 1990).

In recent decades moose, red deer and roe deer have expanded their geographic ranges and increased to their highest population levels in historical times. Expansion of natural and planted forests may be one factor that has enhanced environmental conditions for cervids, except for the reindeer which depend on open grassy tundra and meadows. Improved harvest patterns have also contributed to a more robust and productive demography in present cervid populations.

wildlife products, and considering the substantial but largely undocumented trade in non-timber forest products (e.g. rattan, fruits, dyes, mushrooms, crafts, etc.) and wild medicinal plants, Edwards (1995) believes the international trade in wild species rivals that of the forest and fisheries sectors.

The trade of wild fauna and flora is restricted under the Convention on International Trade in Endangered Species of Wild Flora and Fauna (CITES) to which 122 countries (as of July 1994) are Parties (see also 13.6). Species considered to be endangered are prohibited from trade and are listed in Appendix I of the Convention. Appendix II lists species (and products derived from them) that are allowed in international trade under specific guidelines and subject to monitoring and reporting in an effort to minimize the impact of legal trade on species survival. Approximately 675 species are listed in Appendix I, and Appendix II includes about 3700 species of animals and 21 000 species of plants, a figure that is imprecise because entire families, such as orchids, and genera are listed.

Trade in species listed in Appendix II is regulated through the issue of export permits, when there is a determination that the harvest of the species or product has not been detrimental to the survival of the species in the wild. In most cases, however, exporting countries do not have the capacity to make such a finding. Rather than make a determination for each permit, many countries have resorted to using an export quota for the species (often based on previous years' export records) as a basis for controlling harvests.

Virtually all countries participate in the trade of Appendix II listed species. Most of the reported exports come from a handful of countries in Asia (e.g. Indonesia, Philippines, Thailand), South America (e.g. Argentina, Bolivia and Guyana) and Africa (e.g. Cameroon, Tanzania and Mali) (WRI 1992). Historically, the principal markets for wild flora and fauna were in the United States and European countries. However, the majority of the trade is now directed at several Asian countries (e.g. Japan, Singapore, Hong Kong, China and Taiwan), while the United States and a few European countries (e.g. Germany, Belgium, France, Austria, Italy and the United Kingdom) import most of the rest.

As commerce in wild species has become more regulated and controlled, captive management or cultivation of species has begun to replace supplies traditionally harvested from the wild. Butterfly ranching in Papua New Guinea is a successful example where ranching has produced economic benefits and protected the wild resource. In this case larvae are collected from the wild, food plants are cultivated by rural villagers, and the 'captive stock' are cared for and harvested just prior to metamorphosis. The Government of Papua New Guinea assists communities in marketing their products, and the

income goes to the villagers. Other examples of successful ranching include green iguana lizards in Central and South America (Ocana *et al.* 1988) and crocodiles in Papua New Guinea, although a lack of market development has limited their potential (Edwards 1995).

13.3.5.3 Incentives for managing wild populations sustainably

In most countries wild resources are the property of the state and access is subject to state regulations. In developing countries, the people living closest to wild resources will have the greatest influence over their conservation. Where people are poor, or where enforcement is absent, wild species will often be harvested irrespective of legal regulations. Given these realities, two conditions must be addressed in national policies:

1. the people living with the resources should have sufficient incentives to conserve, and
2. resource users must be accountable for their actions.

Rights to harvest wild species can be conveyed through property ownership. In this situation, the owner of the land has the legal right to use all resources on the land including wildlife and plants. Alternatively, usufruct (limited) rights to wild resources can be granted by government on public lands. In either case, the rights should convey responsibilities in relation to a defined management plan and should include periodic reviews of performance to ensure accountability.

In cases where landholders have the responsibility for managing of wild resources (either on privately owned land or on communal lands), there is some evidence that this has improved the status of the wild resource more than has public management. For example, the government in Zimbabwe has actively promoted a policy of 'private ownership' of wildlife. As a result, 75% of ranches in Zimbabwe derive some income from wildlife, and overall the amount of private land dedicated to wildlife management has been increasing at 6% per year, according to a recent survey (Martin 1994). Today, national parks account for less than 30% of the country's managed wildlife estate while privately owned and communal lands account for nearly 50% (Cumming 1991).

To compete with other forms of land use, the value of wild species harvests must be factored into land-use planning decisions. Policies in some areas are contributing to the conversion of natural habitats that may be more valuable for wildlife or wild plant harvesting. In Zimbabwe, research indicates that lands managed for wildlife will generate up to 30 times more income from sport hunting, wildlife viewing, and meat, hides and other products, than the same land would generate if used for cattle ranching (Bond 1993).

Recent research from Kenya, however, suggests that the opportunity costs may exceed the benefits of some of the

country's best-known wildlife reserves and protected areas (Norton-Griffiths and Southey 1995), although Kenya has not diversified its wildlife sector in ways – sport hunting is banned, for example – that could enhance revenues (Edwards and Allen 1992). This illustrates one of the major difficulties in the management of wild resources: the price of a single species product in most cases cannot reflect habitat management costs. However, amortizing these costs across an array of species and products, over a number of years, may make the investment economically feasible. Multiple uses of wild species or habitats add value to the resource. Likewise, given the vicissitudes of market demands for wild products, it is not advisable (nor probably sustainable) for a management programme to be based on a single species. In Zimbabwe, for example, an elephant may be harvested for meat, used to make a variety of wildlife products, marketed for sport hunting, and promoted for tourism. Successful crocodile farming operations in various countries have incorporated tourism and sale of breeding stock into their business activities. Each additional use adds to the potential value of the resource and increases the incentive to maintain and manage the resource.

The value of wild habitats and their species to rural communities is often overlooked in national policy. Rural people can be (and often already are) allies – not adversaries – in the sustainable management of wild resources. Government agencies and NGOs will need to invest heavily in working with local communities to educate and train residents to be wildlife managers and to use wildlife to meet their social and economic development goals. In the few places where this has been done, such as Zimbabwe's Campfire Programme (Child 1994), wildlife and biodiversity have not only held their own but actually increased.

13.3.6 Biodiversity prospecting

The search for wild species whose genes can yield better crops and new medicines – sometimes called 'biodiversity prospecting' – has created a rapidly growing new industry. Already, pharmaceutical companies are screening the genetic storehouses found in Costa Rica, Brazil, Micronesia, China and other biologically diverse countries, as well as forest habitats in temperate countries and hydrothermal vents deep under the sea. Without appropriate legislation, benefit-sharing arrangements and technical guidelines, this 'gene rush' may do little to conserve ecosystems and provide few if any benefits to the people living in or near them. Done well, though, bioprospecting can bolster both economic and conservation goals while advancing medical and agricultural needs to sustain growing human populations (Lash 1993).

For decades, ecologists and environmentalists have argued that agricultural, pharmaceutical and other commercial applications of biodiversity should help justify

its conservation. Since the mid-1960s, however, industry investment in natural products research had been small, even declining during the 1970s (Reid *et al.* 1993). As noted above in Section 11, in September 1991, Costa Rica's National Biodiversity Institute (INBio) – a private, non-profit organization – and the US-based pharmaceutical firm Merck & Co., Ltd. announced an agreement that helped reverse this trend. The agreement provides US\$1.135 million to INBio from Merck to conduct research and sampling of wild plants, insects and microorganisms in exchange for chemical extracts which Merck could screen for potential pharmaceutical applications. If any commercial products resulted, Merck agreed to pay INBio royalties which INBio will use to further its inventory and research, and to support a fund for the management of Costa Rica's national parks (Reid *et al.* 1993). Since then, a growing number of biodiversity prospecting agreements have been negotiated between industry, research institutions and governments around the world.

The dramatic changes taking place in the use of biodiversity in the agricultural and pharmaceutical industries are primarily the result of advances in gene transfer and biochemical screening technologies. Breeders can now move genes from unrelated species into agricultural crops through genetic engineering. For example, breeders are now screening plant extracts for antifungal or antiviral activity, isolating and transferring the genes responsible for those chemicals into elite crop lines within a matter of days (Reid *et al.* 1995). In the pharmaceutical industry, natural products drug discovery processes have traditionally required substantial quantities of material. Advances in techniques for extraction, screening, fractionation and chemical identification now require much less material and are much less costly. Samples of only 200–500 g of dry plant material are now needed to isolate, elucidate the structure of, and test a novel plant metabolite, instead of the 100 kg or more that may have been needed a decade ago. Where the screening of 10 000 samples would have cost US\$6 million in the mid-1980s, it now costs only US\$150 000 (Reid *et al.* 1995). And, tissue and cell culture – the 'next frontier' of natural products research – now allows small samples of plants to be collected and screened without any need to return for additional supplies (see Section 10 for discussion of biotechnologies).

The potential of biodiversity prospecting to adversely impact genes, species and ecosystems is much less than that of many practices in agriculture, forestry and fisheries. Unregulated biodiversity prospecting, however, can speed the destruction of a species. In one particularly notable case, the entire adult population of the shrub *Maytenus buchananii* – the source of the anti-cancer compound maytansine – was harvested (27 215 kg) in Kenya by the US National Cancer Institute for testing in its drug

development programme (Oldfield 1984). To avoid such problems, research agreements, such as those specified under the Philippines Presidential Executive Order on Biodiversity Prospecting (Reid *et al.* 1995), can specify ecological and population studies to determine limits for sample collections. All collections must be approved in accordance with these limits.

The greater challenges are to implement mechanisms to equitably share the benefits of biodiversity prospecting and to invest some of those benefits in biodiversity conservation. This is complicated by the new ways in which biotechnology generates wealth and the lack of legal and institutional experience to ensure that benefits are equitably shared.

The economic value of wild biological diversity is increasing because of biotechnologies. Any organism is now a source of chemical and genetic innovation with potential application in the agriculture, pharmaceutical or industrial chemical industries. And, the cost of working with new genetic material or identifying and isolating new chemicals is decreasing rapidly. Ironically, while the economic value of genetic resources in general is rising, the same is not true for the commercial value of any given species or extract. This is because the technological advances that make biodiversity prospecting feasible have greatly increased the effective supply of species. Plant breeders no longer have to restrict their search for new genes to crop relatives, or even to the plant kingdom. In the near term, there is competition among firms for access to a relatively small number of quality suppliers of raw biochemical and genetic material. Over the long term, the large supply of material and decreasing costs of natural product research are likely to hold the 'market' value of samples of raw materials very close to the direct labour cost of obtaining the sample (Reid *et al.* 1995). In other words, most of the benefits from biodiversity prospecting will not come from finding raw materials: they will come from developing those materials into commercial applications.

The keys to sharing the benefits that flow from biodiversity prospecting will depend on two issues. First, how can mechanisms be designed and implemented to target benefits to countries and communities that conserve their biodiversity and make it available for biodiversity prospecting? Second, how can countries build the research and commercial capacity to make use of their own genetic resources? The Convention on Biological Diversity addressed these issues by reaffirming the sovereign rights of nations to their biodiversity, establishing the right of nations to regulate access to genetic resources, and creating technology-transfer mechanisms. The legal aspects of regulating genetic access are discussed in 13.6.3.1.

13.3.7 Managing the impacts of tourism on biodiversity

Tourism has become one of the largest economic activities in the world – if not the largest. In developing countries alone, it

generated US\$62.5 billion in 1990. Throughout the world, international arrivals of visitors were estimated at nearly 450 million people in 1990, generating nearly US\$3.5 trillion. This amount is greater than that generated by the global agriculture, automobile or steel manufacturing industries (WTO 1991, 1992). The rapid growth in tourism has produced more infrastructure, increased pollution, put unsustainable demands on local environments, and created adverse impacts on biodiversity. In many coastal areas, for example, strings of high-rise hotels stretch for kilometres along beaches that not long ago might have been diverse habitats of coastal forest, mangroves, seagrass beds and coral reefs.

But tourism, particularly ecotourism or nature tourism, is also seen as a force to help the sustainable use and protection of biodiversity, since the wildlife and natural habitats that draw visitors also generate significant income and foreign exchange in some parts of the world. And this influence will increase, as nature tourism is one of the fastest-growing elements of tourism, increasing at a rate of 7% annually (Filion *et al.* 1992). In Kenya, for example, tourism is the country's largest earner of foreign exchange: nearly all its visitors come to visit the national parks and view wildlife (McNeely *et al.* 1992). Nature tourism is also a tremendous economic force in Costa Rica and a growing number of other countries, and may be valued at US\$50 billion world-wide by the turn of the century. Tourism, therefore, is both a benefit and a curse to the sustainable use and protection of biodiversity.

The big challenges in minimizing the impact of 'mass tourism' on biodiversity lie with problems such as sewage treatment in coastal areas, site selection of hotels, pollution caused by large fleets of tour buses, impacts of scuba divers on coral reefs, and environmental issues posed by golf courses, waste treatment of big resort hotels, etc. Ecotourism can contribute to pressures on biodiversity through serious trail erosion, cutting down trees for fuelwood, inappropriately sited infrastructure in protected areas, and waste disposal (see also 13.5.3.3). While these may occasionally seem peripheral to the management of biodiversity, they have caused significant local losses of biodiversity in many parts of the world and – at least indirectly – have contributed to the global endangerment of species. One basic step towards protecting biodiversity from unintended adverse impacts associated with tourism is to use environmental impact assessment (EIA) procedures to identify serious problems before they occur. Siting is the most important consideration in the EIA process. For example, in fragile island environments, all tourism facilities should be placed well away from sensitive habitats (e.g. seabird and turtle nesting areas, mangrove forests, salt ponds, seal and sealion rookeries) and well above the high-water mark since natural erosion and accretion cycles are a feature of many beaches. Careful planning, design, and building guidelines for tourism

facilities are required to ensure that tourism enhances rather than detracts from the natural setting. Further, the capacity of facilities and the projected number of visitors need to be assessed relative to the management objectives of each area, particularly the need to avoid damaging the site (Ceballos-Lascurain 1993).

In addition to considering the impacts of major hotel and resort complexes, it is important to assess the impact of adjacent developments, such as golf courses or marinas, designed to serve visitors. Guidelines for golf course design and construction should include provisions to avoid clearing native forests for new golf-course development, and to replant with native trees, shrubs and grasses whenever possible. Marinas should not be built in sensitive habitats, where dredging or changes in water circulation could displace rare or migratory species. Once facilities have been built, it is important to monitor their impact, and that of the users, on indicators of wildlife, habitat or environmental quality identified during the EIA process. Using this information, damaging activities can be reduced before they become critical (McIntyre 1993).

In coastal areas, waste disposal can create serious problems for coral reefs and other marine habitats, not to mention human health (Salm and Clark 1984). Experience has now shown that there is no completely safe method of waste disposal. All forms of disposal can have negative impacts on the environment, public health and local economies. In particular, many water and waste-water treatment systems load aquatic habitats with excess nutrients that stimulate unnatural levels of algal growth, killing native species and reducing local biodiversity. Pollution prevention, through reducing the amount of waste produced, is the most effective way of avoiding many of these problems. In addition, an emphasis should be placed on using products that minimize waste and are non-toxic, on recycling materials, and on composting biodegradable wastes.

13.3.8 Managing impacts of urbanization and infrastructure on biodiversity

The land area occupied by cities, towns and infrastructure (e.g. highways, airports, canals, railroads, etc.) has grown dramatically in many parts of the world during the second half of the twentieth century. While the total area is small – built-up areas generally occupy less than 5% of the total land area in European countries (WRI 1994) – the infrastructure and urban areas of growing societies do have substantial impacts on biodiversity (see also Section 11). Land-use planning and environmental impact assessment practices and other actions, however, can minimize the impacts of urbanization on biodiversity.

13.3.8.1 Conserving biodiversity in urban areas

Urban environments and biodiversity are often seen to be mutually exclusive. Some authors deliberately exclude the

biodiversity associated with urban parks, street and roadside plantings, and household yards and gardens, on the grounds that it is artificial (Angermeier 1994). A growing number of researchers, however, are working to inventory, restore and protect biodiversity in city and suburban landscapes (e.g. Soulé 1991; Goode 1993; Beatley 1994). Urban conservation, which was a minor interest of conservationists in the 1960s and 1970s in Europe and the United States, is now becoming a major movement (Heywood 1995). Today, there is a substantial literature on urban landscapes and their wildlife (e.g. Beissinger and Osborne 1982; Kalpavriksh 1991; López-Moreno 1993; Jordan 1994).

In many parts of the world, especially in developed countries, a majority of the population lives in urban areas. This is the case in a growing number of developing countries as well. The urban population in 1995 reached 45.2% of world-wide population, and nearly 20% of all people lived in major cities with populations over 750 000 (WRI 1994). The range of urban population varies considerably, from 100% in Singapore and in the 60–80% range for most OECD countries, to less than 10% in a handful of countries in Africa (e.g. Rwanda, Burundi) and Asia (Bhutan). By 2025, the UN (1989) estimates that 80% of residents in developed countries will live in cities: world-wide, at least 60% of the population will live in urban areas.

Within these cities, a diverse range of artificial, semi-natural and natural habitats exist. These include urban parks, botanic gardens, nature reserves, university and business campuses, cemeteries and a wide range of other urban 'green spaces' (Heywood 1995) (Table 13.3-1). In the United States, parkland ranges from 42% in Honolulu to 0.3% in Baton Rouge (WRI 1994). In Europe, about 20% of cities and towns are devoted to open space.

13.3.8.1.1 Habitat types. Some cities have within their boundaries remnants of native vegetation, sometimes even extensive areas; for example, remnants of the celebrated Mata Atlantica forests are found in Rio de Janeiro, Brazil (Monteiro and Kaz 1992). In Portland, Oregon, just 3 kilometres from the urban centre is Forest Park, a 4000 hectare forest area with a virtually complete inventory of plants and wildlife found in larger natural forest areas outside the city. Within the city of Caracas, Venezuela, the National Park El Avila protects the majestic wall of mountains on the city's north side and provides a home to over 1700 species of flowering plants (Steyermark and Huber 1978). The Singapore Botanic Garden is a celebrated but small patch (4 ha) of original tropical evergreen forest in centre of the world's second busiest port city (Tinsley 1983). Many other cities have examples of surviving natural habitats, including the forests found on the campus of York University in Toronto, Canada, and the Ridge Forest in Delhi, a 7700 ha sliver of wild and manicured vegetation running through the heart of the city of 8 million people (Kalpavriksh 1991).

Table 13.3-1: Types of urban 'green spaces'.

National parks	Nature reserves
Municipal parks	Domestic gardens
Botanic gardens	Roadside verges
Zoological gardens	Greenways
Arboreta	Plant nurseries
Wildlife corridors	Industrial parks
Urban commons	Cemeteries
Business parks	Golf courses
Canals	Street trees
Streams and ponds	Urban forests
Nature centres	Garden centres
Vacant lots	University campuses

Abandoned industrial land, old quarries, untended roadways, railroad corridors and other unkempt areas exist in nearly all cities. In many cases, these areas have become new semi-natural habitats that support a diversity of plant and animal life. Mabey (1973) calls these areas the 'unofficial countryside'. Goode (1993) suggests that abandoned and derelict lands in urban areas provide opportunities for creating habitats and enhancing urban biodiversity. Habitat restoration and rehabilitation is taking place in urban and suburban areas to generate new value and benefits from abandoned lands and semi-natural areas (see 13.4.4 for ecosystem restoration and rehabilitation measures). Finally, human-made habitats are diverse in most urban landscapes. Within cities, vineyards (e.g. on the butte de Montmartre in Paris), agricultural fields and home gardens, urban landscaping, intensive horticulture (e.g. the Huerta in Valencia, Spain), recreated wetlands (e.g. Utrecht, Netherlands), historical sites and a wide range of other habitats contain hundreds or up to several thousand cultivated plant species and a more limited diversity of native plants, birds, and other fauna.

13.3.8.1.2 Species diversity in urban habitats. While urban habitats have been the subject of an increasing amount of biological inventory work, the data do not allow conclusions about the overall biodiversity of urban habitats in any particular city, let alone on a world-wide basis. Still, evidence of the enormous diversity of such habits is coming to light. In Italy, for example, advanced ornithological studies have been carried out in 27 towns and cities, and nearly 600 papers have been published on Italian urban avifauna. Dinetti (1994) records 103 breeding species of birds in Italy's urban areas. In Dehli, 400 bird species – one-third of India's total avifauna – have been recorded. These include representatives of almost every major bird family, and birds typical of almost every major

ecosystem: forest, wetland, grassland and desert (Kalpavriksh 1991).

While many of these species are introduced, the number of native or migratory species found in urban areas can be surprisingly high. In the case of higher plant species, more than 50% of recorded species in cities as different as Mexico City and Rome are native. In the Netherlands, about 50% of the country's native flora – including nearly 20% of the country's rare species – can be found growing along roadside margins and rights of way (Sykora *et al.* 1994).

In many cities, thousands of exotic species are cultivated in public and private parks and gardens. Botanic gardens, for example, are usually found in cities, and together they maintain at least 80 000 of the world's estimated 250 000 plant species. This represents the greatest plant diversity outside nature. Private gardens, especially those of specialist collectors, also maintain thousands of additional species. The scientific, educational and cultural value of this large sample of the world's flora found in cities should not be underestimated. Most of this cultivated and introduced plant diversity does not form breeding populations. As a result, its genetic diversity is usually not very good. The intensive breeding and selection that take place in public and private botanic gardens and horticultural centres, however, create large amounts of new genetic variation in the form of cultivars and varieties of ornamental plants (e.g. orchids, narcissus, tulips, roses, begonias, delphiniums, polyanthus, pansies, violas, etc.).

13.3.8.1.3 Actions to conserve urban biodiversity. The urban conservation movement is pushing governments and planners around the world to take steps to maintain – or create – habitats within urban ecosystems for wildlife and ecosystem services. In New Dehli, the Ridge Forest has faced a series of familiar threats: construction, road-widening, garbage dumping and quarrying. Pressured by concerned citizens, especially school groups, local residents and organized community groups, Delhi's Lieutenant Governor recently appointed a task force to develop a management plan for the Ridge Forest (Delhi Administration 1994). The Delhi administration has now declared the entire Ridge Reserved Forest under the Indian Forest Act, and has declared its intention not to allow any further diversion for non-forest purposes. In Calcutta, one of the most densely populated cities in the world (35 000 km²), environmentalists have organized to protect the city's limited green space (4% of total land area). This small area harbours at least 20 small- and medium-sized mammalian species, 150 bird species, over 10 amphibians and over 100 species of butterflies (Ghosh 1989).

A number of European cities including Edinburgh, Scotland and Moscow, Russia have developed Urban Nature Conservation Strategies. UNESCO has established a Man and the Biosphere Project (number 11) on urban systems, and journals such as *Urban Wildlife News* in the

United Kingdom and *Urban Forests* (published by American Forests) are reaching a rapidly growing number of conservationists working to maintain biodiversity in city landscapes. The bioregional approach to the protection and use of biodiversity advocated in the *Global Biodiversity Strategy* (WRI/IUCN/UNEP 1992) encompasses urban and suburban landscapes and recognizes the contribution urban ecosystems can make to biodiversity conservation. Conservation biology (e.g. use of corridors, selection of priority conservation areas, etc.) is increasingly being used to guide regional and urban planning in the United States (Soulé 1991; Beatley 1994) and elsewhere.

Perhaps the most important reasons to use and protect biodiversity in urban landscapes are the educational, aesthetic and moral values it can provide to the urban societies in which most of the world's people will soon live. As Box and Harrison (1994) have noted:

If the contribution of urban green spaces to future generations is to be justified solely in terms of their contribution to the stock of environmental assets, then urban environmental assets will always be deemed to be poor substitutes for their rural counterparts. On the other hand, if urban green space policies acknowledge the social and educational assets of accessible natural green spaces, then the inheritance value of these areas is unrivalled.

13.3.8.2 Managing the impacts of infrastructure on biodiversity

Infrastructure projects, whether roads, dams, port facilities, power projects or pipelines, can have a dramatic impact on biodiversity. Roads through forests or canals through wetlands can have an impact that goes far beyond the immediate project boundaries. For example, Lanly (1982) estimated that tropical forest areas with road networks were eight times more likely to be deforested (from agricultural conversion) than are roadless forest areas. The value of intact forest for carbon sequestration, sustainable forest management for timber and other products, ecotourism, water supplies, and other products and services, may far outweigh the costs of building a longer road through degraded or converted habitats.

Land-use planning and environmental impact assessments are the principal tools for avoiding or minimizing the adverse impacts of infrastructure development on biodiversity (see also 13.6). The widespread adoption of environmental impact assessment policies in countries around the world provides new opportunities for addressing biodiversity protection and management in many mainstream development projects. Although it is rare for such projects to be abandoned because of their impacts on biodiversity, it is increasingly common for protection and mitigation methods to be adopted as a consequence of these impacts.

Methods can range from the conservation of a natural habitat area as compensation for an equivalent area lost to a project, to the improved management of watersheds that both maximizes the life of a hydroelectric dam by reducing soil erosion and conserves forests and their biodiversity (World Bank 1995).

Two examples of 'mainstreaming' biodiversity conservation in infrastructure development projects are being supported by the World Bank (World Bank 1995). In Ghana, urbanization and related infrastructure development in greater Accra and other coastal towns threaten coastal lagoons that provide livelihood opportunities for local residents and a critical refuge for tens of thousands of migratory birds. Without making biodiversity conservation an explicit objective of infrastructure development, the pressure of sewage and industrial effluent would rapidly degrade wetland habitats. World Bank and Global Environment Facility (GEF) assistance is being provided to redesign sewage treatment and effluent disposal methods, reduce recreational pressure on lagoons, and support community initiatives to use the lagoons' biological resources sustainably.

In Grenada, a landfill site was proposed for an area containing one of only two populations of the endangered Grenada dove. World Bank and GEF assistance is now being used to redesign and relocate the landfill and help with local Grenada dove conservation efforts.

The World Bank now has provisions to address potential impacts on biodiversity in several environmental policies (e.g. Natural Habitats, Forestry, Environmental Assessment, Water Resources Management, Agricultural Pest Management, and the Environmental Policy for Dam and Reservoir Projects). These are applied to virtually all infrastructure projects financed by the Bank. Other development agencies have adopted similar policies, although it is not clear how effectively they are being implemented.

13.3.9 Conclusion

Our ability to maintain and make the most beneficial use of biodiversity depends on using and managing biodiversity sustainably in agriculture, forestry, fisheries, tourism and other activities where the production of goods and services for human consumption is the principal objective.

Many traditional agricultural management systems provide opportunities for the conservation and sustainable use of biodiversity. For example, small-scale farmers using traditional agricultural practices have long been effective creators of varietal diversity and stewards of genetic diversity: traditional forms of agriculture, particularly in developing countries, are the world's largest repositories of crop and livestock genetic diversity. Farmers cannot continue to provide this 'service' to others, however, in regions where conversion to high-input, low-diversity agroecosystems is economically more advantageous. As a

result, much of the genetic diversity associated with traditional systems will continue to decline rapidly without funds or market mechanisms to compensate local farmers for this service.

Modern agriculture has been a major beneficiary of biodiversity, particularly the varietal diversity generated in traditional agriculture. Modern agriculture has offered tremendous gains in productivity through technological innovation and the widespread adoption of uniform, high-yielding varieties. Future gains in productivity will depend on improved management of genetic resources in time (e.g. gene banks) and space (e.g. crop variety mosaics). While we have an incomplete understanding of the magnitude of potential future losses in crop productivity due to the narrowing of the genetic base for breeding, genetic vulnerability of many of the world's most important food crops and animals appears to be growing.

To meet the demands of a growing world population and simultaneously maintain biodiversity requires measures that (1) conserve genetic diversity in existing domesticated plant and animal varieties, (2) identify and conserve wild species that can improve agricultural productivity and adaptability in the face of environmental change, and (3) minimize the adverse impacts of agricultural practices on other ecosystems.

Traditional approaches to forest and fisheries management have also – intentionally or unintentionally – contributed to the maintenance of biodiversity but, as in agriculture, traditional practices are disappearing rapidly. The intensification of forestry and fisheries management has led to dramatic increases in yield. This, however, has caused significant interventions in natural disturbance regimes and species composition and consequent reductions in biodiversity in many forestry and fisheries production areas.

Resource management practices that allow or emulate natural disturbance patterns will tend to be more supportive of biodiversity. For example, forestry practices that mimic natural disturbance regimes such as fire, wind blow-downs, and pathogen outbreaks, appear to offer the best opportunities for maintaining the biodiversity associated with forest ecosystems. In fisheries, better monitoring of fish stocks, the use of dynamic models that incorporate interactions between fish stocks and environmental factors, and the use of more selective fish capture methods offer hope for increasing the sustainability of the harvest and the conservation of marine biodiversity.

Social and economic measures, however, may be much more important than technical measures for ensuring sustainable use (see Section 12 and 13.5).

References

- Acheson, J.M. 1975. Fisheries management and social context: The case of the Maine lobster fishery. *Transactions of the American Fisheries Society* **104**: 653–668.
- Acosta, B.O. and Pullin, R.S.V. 1991. Environmental impact of the golden snail (*Pomacea* spp.) on rice farming systems in the Philippines. *ICLARM Conference Proceedings 28*. International Centre for Living Aquatic Resources Management, Manila.
- Ahlen, I. 1965. Studies on the red deer (*Cervus elaphus* L.) in Scandinavia I. History of distribution. *Viltrevy* **3**: 1–88.
- Albon, S.D., Clutton-Brock, T.H. and Langvatn, R. 1992. Cohort variation in reproduction and survival: implications for population demography. In: Brown, R.D. (ed.), *The Biology of Deer*, 113–128. Springer-Verlag, New York.
- Alcala, A.C. 1988. Effects of marine reserves on coral fish abundance and yields of Philippine coral reefs. *Ambio* **17**: 194–199.
- Alcorn, J.B. 1981. Huastec noncrop resource management. *Human Ecology* **9**: 395–417.
- Alcorn, J.B. 1990. Indigenous agroforestry systems in the Latin American tropics. In: Altieri, M.A. and Hecht, S.B. (eds), *Agroecology and Small Farm Development*. CRC Press, Boca Raton, Fla.
- Altieri, M.A. 1987. *Agroecology: The scientific basis of alternative agriculture*. 203–213. Westview Press, Boulder, Colo.
- Altieri, M.A. and Hecht, S.B. 1990. *Agroecology and Small Farm Development*. CRC Press, Boca Raton, Fla.
- Altieri, M.A. and Merrick, L.C. 1987. *In-situ* conservation of crop genetic resources through maintenance of traditional farming systems. *Economic Botany* **41**: 86–96.
- Andersen, R. 1991. Habitat deterioration and the migratory behavior of moose (*Alces alces* L.) in Norway. *Journal of Applied Ecology* **28**: 102–108.
- Anderson, R. and Heim, M. 1993. Overvakning av hjortevilt – elg. NINA Oppdragsmelding nr. 271–277. Norwegian Institute for Nature Research, Trondheim.
- Angermeier, P.L. 1994. Does biodiversity include artificial diversity? *Conservation Biology* **8**: 600–602.
- Aplet, G.H., Johnson, N., Olson, J.T. and Sample, A.V. (eds) 1993. *Defining Sustainable Forestry*. Island Press, Washington, DC.
- Appanah, S. and Weinland, G. 1991. Will the management systems for hill dipterocarp forests stand up? *Journal of Tropical Forest Science* **3**: 140–158.
- Barber, C.V., Johnson, N.C. and Hafild, E. 1994. *Breaking the Logjam: Obstacles to forest policy reform in Indonesia and the United States*. World Resources Institute, Washington, DC.
- Bartlett, P.G. 1980. Adaptation strategies in peasant agricultural production. *Annual Review of Anthropology* **9**: 545–573.
- Beatley, T. 1994. *Habitat Conservation Planning: Endangered species and urban growth*. University of Texas Press, Austin.
- Beissinger, S.R. and Osborne, D.R. 1982. Effects of urbanization on avian community organization. *Condor* **84**: 75–83.
- Benz, B.F., Sánchez-Velásquez, L.R. and Santana-Michel, F.J. 1990. Ecology and ethnobotany of *Zea diploperennis*: preliminary investigations. *Maydica* **35**: 85–98.
- Berkes, F. 1977. Fishery resource use in a subarctic Indian community. *Human Ecology* **5**: 289–307.
- Berkes, F. 1986. Local-level management and the commons problem: a comparative study of Turkish coastal fisheries. *Marine Policy* **10**: 215–229.
- Berkes, F. (ed.) 1989. *Common Property Resources. Ecology and community-based sustainable development*. Belhaven Press, London.

- Berkes, F., Feeny, D., McCay, B.J. and Acheson, J.M.** 1989. The benefits of the commons. *Nature* **340**: 91–93.
- Beverton, R.J.H.** 1993. The Rio Convention and rational harvesting of natural resources: the Barents Sea experience in context. In: Sandlund, O.T. and Schei, P.J. (eds), *Norway/UNEP Expert Conference of Biodiversity*. 44–63. NINA, Trondheim.
- Beverton, R.J.H. and Holt, S.J.** 1957. *On the Dynamics of Exploited Fish Populations*. Fisheries Investigation Series II (19). HMSO, London.
- Bielawski, E.** 1992. Inuit indigenous knowledge and science in the Arctic. *Northern Perspectives* **20**: 8–12.
- Billingsley, L.W.** (ed.) 1981. Proceedings of the Stock Concept International Symposium. *Canadian Journal of Fisheries and Aquatic Sciences* **38**: 1457–1921.
- Billington, N. and Herbert, P.D.N.** (eds) 1991. International symposium on 'The ecological and genetic implications of fish introductions'. *Canadian Journal of Fisheries and Aquatic Science* **48** (Supplement 1):1–181.
- Blockhus, J., Dillenbeck, M., Sayer, J. and Wegge, P.** (eds) 1992. *Conserving Biological Diversity in Managed Tropical Forests*. World Conservation Union (IUCN) and the International Tropical Timber Organization (ITTO). IUCN, Gland, Switzerland.
- Bond, I.** *The Economics of Wildlife and Land-use in Zimbabwe: An examination of current knowledge and issues*. Multispecies Production Systems Project Issues Paper 35. World Wide Fund for Nature, Harare, Zimbabwe.
- Box, J. and Harrison, C.** 1994. Minimum targets for accessible natural greenspace in urban areas. *Urban Wildlife News* **11**: 10–11.
- Brodie, J.E., Arnold, C., Eldredge, L., Hammond, L., Holthiud, P., Mowbray, D. and Torte, P.** 1990. *State of the Marine Environment in the Eastern African Region*. UNEP Regional Seas Reports and Studies 113. UNEP, Nairobi.
- Bromley, D.W.** (ed.) 1992. *Making the Commons Work: Theory, practice and policy*. ICS Press, San Francisco.
- Brown, A.H.D., Frankel, O.H., Marshall, D.R. and Williams, J.T.** (eds) 1989. *The Use of Plant Resources*. Cambridge University Press, Cambridge.
- Brown, N.J.** 1982. *Biological Diversity: The global challenge*. US Department of State, Washington, DC.
- Bruenig, E.F.** 1989. Use and misuse of tropical rain forests. In: Lieth, H. and Werger, M.J.A. (eds), *Tropical Rain Forest Ecosystems: Biogeographical and ecological studies*. Elsevier Publishers, Amsterdam.
- Brush, S.B.** 1986. Genetic diversity and conservation in traditional farming systems. *Ethnobiology* **6**: 151–167.
- Brush, S.B.** 1991. A farmer-based approach to conserving crop germplasm. *Economic Botany* **45**: 153–165.
- Brush, S.B.** 1995. *In-situ* conservation of landraces in centers of crop diversity. *Crop Science* **35**: 346–354.
- Brush, S.B., Carney, H. and Huaman, Z.** 1981. Dynamics of Andean potato agriculture. *Economic Botany* **35**: 70–88.
- Budowski, G.** 1984. Biological diversity and deforestation in the tropics. In: Wiersum, K.F. (ed.), *Strategies and Designs for Tropical Forest Management*. 115–125. PUDOC, Wageningen, Netherlands.
- Buschbacher, R.** 1990. Ecological analysis of natural forest management in the humid tropics. In: Goodland, R. (ed.), *Race to Save the Tropics*. 59–80. Island Press, Washington, DC.
- Cabarle, B.** 1991. Community forestry and the social ecology of development. *Grassroots Development* **15**: 3–9.
- Caughley, G.** 1994. Directions in conservation biology. *Journal of Animal Ecology* **63**: 215–244.
- Ceballos-Lascurain, H.** 1993. *The IUCN Ecotourism Consultancy Program* (descriptive brochure). IUCN, Mexico City.
- Chacon, J.G. and Gliessman, S.R.** 1982. Use of 'non weed' concept in traditional agroecosystems of south-eastern Mexico. *Agro-Ecosystems* **8**: 1–11.
- Chang, J.G.** 1977. Tropical agriculture: Crop diversity and crop yields. *Economic Geography* **53**: 241–254.
- Child, B.** 1994. Using Zimbabwe's CAMPFIRE programme to assess the value of IUCN's proposed guidelines for the ecological sustainability of nonconsumptive and consumptive uses of wild species. In: *Proceedings of Sustainable Use of Renewable Natural Resources Workshop*. 19th Session of the IUCN General Assembly, January 1994, Buenos Aires, Argentina. IUCN, Gland.
- Clawson, D.L.** 1985. Harvest security and intraspecific diversity in traditional tropical agriculture. *Economic Botany* **39**: 56–67.
- Cohen, J., Williams, J.T., Plucknett, D.L. and Shands, H.** 1991. *Ex-situ* conservation of plant genetic resources: Global development and environmental concerns. *Science* **253**: 866–872.
- Colchester, M.** 1991. Forest peoples and sustainable forest management. Paper presented at World Resources Institute Colloquium on Sustainability in Natural Tropical Forest Management, 21–22 March 1991. World Resources Institute, Washington, DC.
- Collection Nordicana.** 1992. Contaminants in the marine environment of Nunavik. *Collection Nordicana* **56**. Centre d'Etudes Nordiques, Université Laval, Quebec.
- Collins, W. and Phillips, R.** 1991. Plant breeding training in public institutions in the United States: a survey conducted by the National Plant Genetic Resources Board. *Diversity* **7**: 28–32.
- Cooley, R.A.** 1963. *Politics and Conservation: The decline of the Alaska salmon*. Harper & Row, New York.
- Cumming, D.H.M.** 1991. Developments in game ranching and wildlife utilization in east and southern Africa. In: Renecker, L.A. and Hudson, R.J. (eds), *Wildlife Protection: Conservation and sustainable development*. 96–108. University of Alaska Press, Fairbanks.
- Davis, S.** 1983. By their garbage they shall be known. *New Scientist* **17**: 506–515.
- Delhi Administration.** 1994. Report of the Committee to Recommend a Pattern of Management of the Delhi Ridge. Delhi Administration, Delhi.
- de los Angeles, M.S. and Pelayo, R.** 1993. Central Visayas Regional Project – I: Nearshore Fisheries Component. Paper presented at the Fourth International Common Property Meeting, 16–19 June 1993, Manila.
- Dinetti, M.** 1994. The urban ornithology in Italy. *Memorabilia Zoologica* **49**: 269–281.
- d'Silva and Appanah, S.** 1993. Forestry management for sustainable development. EDI/WB.
- Duffy, D.C. and Meier, A.J.** 1992. Do Appalachian herbaceous understories ever recover from clearcutting? *Conservation Biology* **6**: 196–201.
- Duvick, D.N.** 1986. Plant breeding: past achievements and expectations for the future. *Economic Botany* **40**: 289–297.

- Edwards, S.R. 1995. Conserving biodiversity resources for our future. In: Bailey, R. (ed.), *The True State of the Planet*. 211–266. Free Press, New York.
- Edwards, S.R. and Allen, C.A. 1992. *Sport Hunting as a Sustainable Use of Wildlife*. World Conservation Union, Gland.
- Eknath, A.E. and Doyle, R.W. 1990. Effective population size and rate of inbreeding in aquaculture of indian major carps. *Aquaculture* **85**: 293–305.
- Eknath, A.E., Tayamen, M.M., Palada de-Vera, Danting, J.C., Reyes, R.A., Dionisio, E.E., Capili, J.B., Bolivar, A.V., Bentsen, H.B., Gjerde, B., Gjedrem, T. and Pullin, R.S.V. 1993. Genetic improvement of farmed tilapias: the growth performance of eight strains of *Oreochromis niloticus* tested in different farm environments. *Aquaculture* **111**: 171–188.
- Elliot, K.J. and Loftis, D.L. 1993. Vegetation diversity after logging in the Southern Appalachians. *Conservation Biology* **7**: 220–221.
- El-Swaify, S.A. (ed.) 1985. *Soil Erosion and Conservation*. Soil Conservation Society of America, Ankeny, Iowa.
- FAO. 1991a. *Food Balance Sheets*. United Nations Food and Agriculture Organization, Rome.
- FAO. 1991b. *Issues and Perspectives in Sustainable Agriculture and Rural Development*. United Nations Food and Agriculture Organization, Rome.
- Feeney, D., Berkes, F., McCay, B.J. and Acheson, J.M. 1990. The tragedy of the commons; twenty-two years later. *Human Ecology* **18**: 1–19.
- Filion, F.L., Foley, J.P. and Jaquemot, A.J. 1992. The economics of global ecotourism. Paper presented at the Fourth World Congress on National Parks and Protected Areas, January 1992, Caracas, Venezuela.
- Fitzgerald, S. 1989. *International Wildlife Trade: Whose business is it?* World Wildlife Fund, Washington, DC.
- Flores Guido, J.S. 1987. Yucatán, tierra de las leguminosas. *Revista Universidad Autónoma de Yucatán*.
- Franklin, J.F. 1993. The fundamentals of ecosystem management with application in the Pacific Northwest. In: Aplet, G.H., Johnson, N., Olson, J.T. and Sample, V.A. (eds), *Defining Sustainable Forestry*. 127–144. Island Press, Washington, DC.
- Franklin, J.F. and Forman, R.T. 1987. Creating landscape patterns by forest cutting: Ecological consequences and principles. *Landscape Ecology* **1**: 5–18.
- Froese, R. and Pauly, D. 1994. A strategy and a structure for a database on aquatic diversity. Paper presented at the 6th Meeting of the Committee on Data for Science and Technology in Asian-Oceanic Countries, 10–12 March 1994, Taipei, Taiwan.
- Frumhoff, P.C. 1995. Conserving wildlife in tropical forests managed for timber. *Conservation Biology* **9** (in press).
- FSC. 1994. What is the Forest Stewardship Council? (Brochure.) Forest Stewardship Council, Oaxaca, Mexico.
- Fulick, A. and Fulick, P. 1991. Biological pest control. *New Scientist* **130** (1761): 16–18
- Gade, D.W. 1969. Vanishing crops of traditional agriculture: The case of tarwi (*Lupinus mutabilis*) in the Andes. *Proceedings of the Association of American Geographers* **1**: 47–51.
- Gan Boon, G. 1993. Forest management in Matang. In: Sasekumar, A. (ed.), *Proceedings of a Workshop on Mangrove Fisheries and Connection. Living Coastal Resources*. 15–26. ASEAN Australia Marine Science Project.
- Garcia, M., Jr (ed.) 1992. *Policies and Issues on Philippine Fisheries and Aquatic Resources: Proceedings of the Roundtable Discussion on Philippine Fisheries Policies and the Workshop on Territorial Use Rights in Fisheries*. Philippine Council for Aquatic and Marine Resources and Development, Los Baños, Philippines.
- Ghosh, A.K. 1989. *Urban Ecology: A case study of Calcutta*. Institute of Local Government and Urban Studies, Calcutta.
- Gill, R. 1990. Monitoring the status of European and North American cervids. *GEMS Information Series No. 8*. Global Environment Monitoring System, UNEP, Nairobi.
- Gjessing, G. 1945. Norges steinhalder. Oslo.
- Gjøsaeter, H. 1995. Pelagic fish and the ecological impact of the modern fishing industry in the Barents Sea. *Journal of the Arctic Institute of North America* (in press).
- Gomez, E.D., Deocadiz, E., Hungspreugs, M., Jothy, A.A., Kuan, K.J., Sogeario, A. and Wu, R.S. 1990. *The State of the Marine Environment in the East Asian Seas Region*. UNEP Regional Seas Reports and Studies 126. UNEP, Nairobi.
- Gómez-Pompa, A. and Bainbridge, D.A. 1991. Tropical forestry as if people mattered. In: Lugo, A.E. and Lowe, C. (eds), *A Half Century of Tropical Forest Research*. 12–26. Springer-Verlag, New York.
- Gómez-Pompa, A., Kaus, A., Jiménez-Osornio, J., Bainbridge, D. and Rorive, D.M. 1993. Mexico case study. In: *Sustainable Agriculture in the Humid Tropics*. 183. National Research Council, National Academy Press, Washington, DC.
- Goode, D. 1993. Local authorities and urban conservation. In: Goldsmith, F.B. and Warren, A. (eds), *Conservation in Progress*. 335–345. John Wiley, Chichester.
- Gross, L.J., Rose, K.A., Rykiel, E.J., van Winkle, W. and Werner, E.E. 1992. Individual-based modelling: summary of a workshop. In: DeAngelis, D.L. and Gross, L.J. (eds), *Individual-based Models and Approaches in Ecology*. 68–79. Chapman and Hall, New York.
- Gulland, J.A. 1989. *Fish Stock Assessment: A manual of basic methods*. FAO. John Wiley, Chichester.
- Guzman, M.R. and Iltis, H. 1991. Biosphere reserve established in Mexico to protect rare maize relative. *Diversity* **7**: 82–84.
- Hamre, J. 1994. Biodiversity and exploitation of the main fish stocks in the Norwegian-Barents Sea ecosystem. *Biodiversity and Conservation* **3**: 272–291.
- Hansen, A., Spies, T.A., Swanson, F.J. and Ohmann, J.L. 1991. Conserving biodiversity in managed forests. *BioScience* **41**: 382–392.
- Hansen, L.P. and Jonsson, B. 1994. Development of sea ranching of Atlantic salmon, *Salmo salar* towards a sustainable aquaculture strategy. In: Danielsen, D. and Moksness, E. (eds), *Sea Ranching of Cod and Other Marine Fish Species*. Aquaculture and Fisheries Management **25** (Supplement 1): 199–214.
- Hardin, G. 1968. The tragedy of the commons. *Science* **162**: 1243–1248.
- Harlan, J.R. 1971. Agricultural origins: centers and non-centers. *Science* **174**: 468–474.
- Harlan, J.R. 1975a. Our vanishing genetic resources. *Science* **188**: 618–622.

- Harlan, J.R.** 1975b. *Crops and Man*. American Society of Agronomy, Madison, Wis.
- Harris, L.D.** 1984. *The Fragmented Forest: Island biogeography theory and the preservation of biotic diversity*. University of Chicago Press, Chicago.
- Hartshorn, G.** 1989. Application of gap theory to tropical forest management: natural regeneration on strip clearcuts in the Peruvian Amazon. *Ecology* **70**: 567–569.
- Hatcher, B.G., Johannes, R.E. and Roberstone, A.I.** 1990. Review of research relevant to the conservation of shallow tropical marine ecosystems. *Annual Review of Oceanography and Marine Biology* **27**: 337–414.
- Hawkes, J.G.** 1977. Plant gene pools: an essential resource for the future. *Journal of the Royal Society of the Arts and Sciences* **125**: 224–235.
- Herrera Castro, N.** 1990. Estudios ecológicos en los huertos familiares Mayas. Report to the Maya Sustainability Project, University of California/Riverside, Riverside, Calif.
- Heywood, V.H.** 1995. The importance of urban environments in maintaining biodiversity. In: *Biodiversity: Science and development towards a new partnership*. UNESCO/IUBS, Paris, 5–9 September 1994. IUBS, Paris (in press).
- Hilborn, R.** 1992. Hatcheries and the future of salmon in the Northwest. *Fisheries* **17** (1): 5–8.
- Hilborn, R. and Walters, C.J.** 1992. *Quantitative Fisheries Stock Assessment: Choice, dynamics and uncertainty*. Chapman and Hall, New York.
- Hindar, K.** 1992. Conservation and sustainable use of Atlantic salmon. In: Sandlund, O.T., Hindar, K. and Brown, A.D. (eds), *Conservation and Biodiversity for Sustainable Development*. 168–185. Scandinavian University Press, Oslo.
- Hindar, K., Ryman, N. and Utter, F.** 1991. Genetic effects of cultured fish on natural fish populations. *Canadian Journal of Fisheries and Aquatic Science* **48**: 945–957.
- Holden, J., Peacock, J. and Williams, J.T.** 1993. *Genes, Crops and the Environment*. Cambridge University Press, Cambridge.
- Holloway, J.D., Kirk-Spriggs, A.H. and Khen, C.V.** 1992. The response of some rain forest insect groups to logging and conversion to plantation. *Philosophical Transactions of the Royal Society of London, B* **335**: 425–436.
- Hopper, M. and Power, G.** 1991. The fisheries of an Ojibwa community in Northern Ontario. *Arctic* **44**: 267–274.
- Hoyt, E.** 1988. *Conserving the Wild Relatives of Crop Plants*. International Board for Plant Genetic Resources, Rome; IUCN, Gland, Switzerland, and World Wide Fund for Nature, Gland, Switzerland.
- Huntington, H.** 1992. The Alaska Eskimo Whaling Commission and other cooperative marine mammal management organizations in north Alaska. *Polar Record* **28**: 119–126.
- Isabirye-Basuta, G. and Kasenene, J.M.** 1987. Small rodent populations in selectively felled and mature tracts of Kibale Forest, Uganda. *Biotropica* **19**: 260–266.
- Jentoft, S.** 1985. Models of fishery development: The cooperative approach. *Marine Policy* **9**: 322–332.
- Johannes, R.E.** 1978. Traditional marine conservation methods in Oceania and their demise. *Annual Review of Ecology and Systematics* **9**: 349–364.
- Johannes, R.E., Ruddle, K. and Hviding, F.** 1991. The value today of traditional management and knowledge of coastal fishery management systems for Asia and the Pacific. Paper presented at the South Pacific Commissions's Twenty-third Regional Technical Meeting on Fisheries, 5–9 August 1991, Noumea, New Caledonia.
- Johns, A.D.** 1992. Species conservation in managed tropical forests. In: Whitmore, T.C. and Sayer, J.A. (eds), *Tropical Deforestation and Species Extinctions*. 15–54. Chapman and Hall, London.
- Johnson, N. and Cabarle, B.** 1993. *Surviving the Cut: Natural forest management in the humid tropics*. World Resources Institute, Washington, DC.
- Jonsson, T. and Lindgren, P.** 1990. *Logging Technology for Tropical Forests – For or against?* Forest Operations Institute, Kista, Sweden.
- Jordan, W.R.** 1994. 'Sunflower forest': ecological restoration as the basis for a new environmental paradigm. In: Baldwin, A.K. (ed.), *Beyond Preservation: Restoring and inventing landscapes*. 17–36. University of Minnesota Press, Minneapolis.
- Kalpavriksh.** 1991. *The Delhi Ridge Forest: Decline and conservation*. Kalpavriksh Publications, New Delhi.
- Kelleher, G. and Kenchington, R.** 1984. Australia's Great Barrier Reef Marine Park: making development compatible with conservation. In: McNeely, J.A. and Miller, K.R. (eds), *National Parks, Conservation and Development: The role of protected areas in sustaining society*. 267–273. Smithsonian Institution Press, Washington, DC.
- Kenmore, P., Litsinger, J.A., Bandong, J.P., Santiago, A.C. and Salac, M.M.** 1987. Philippine rice farmers and pesticides: thirty years of growing dependency on insecticides and new options for change. In: Tait, E.J. and Napompeth (eds), *Management of Pests and Pesticides: Farmers perceptions and practices*. 98–108. Westview Press, London.
- Klein, D.R.** 1968. The introduction, increase, and crash of reindeer on St. Matthew Island. *Journal of Wildlife Management* **32**: 350–376.
- Kock, K.H.** 1992. *Antarctic Fish and Fisheries*. Cambridge University Press, Cambridge.
- Lande, R., Engen, S. and Saether, B.E.** 1994. Optimal harvesting, economic discounting and extinction risk in fluctuating populations. *Nature* **372**: 88–90.
- Langvatn, R.** 1990. *Norges Dyr, Pattedyrene 2*. J.W. Cappelen Forlag, Oslo.
- Langvatn, R.** 1993. Overvakning av hjortevit-hjort. NINA Oppdragsmelding. Norwegian Institute for Nature Research, Trondheim.
- Langvatn, R. and Albon, S.D.** 1986. Geographic increases in body weight of Norwegian red deer: a novel explanation of Bergmann's rule? *Holarctic Ecology* **9**: 285–293.
- Langvatn, R., Albon, S.D., Burke, T. and Clutton-Brock, T.H.** 1995. Climate, plant phenology and variation in age of first reproduction in a temperate herbivore. *Journal of Animal Ecology* **54**: 328–346.
- Lanly, J.P.** 1982. *Tropical Forest Resources*. FAO Forestry Paper 30. UN Food and Agriculture Organization, Rome.
- Larkin, P.A.** 1977. An epitaph for the concept of maximum sustainable yield. *Transactions of the American Fisheries Society* **106**: 1–11.

- Larkin, P.A.** 1979. Maybe you can't get there from here: a foreshortened history of research in relation to management of Pacific salmon. *Journal of the Fisheries Research Board of Canada* **36**: 98–106.
- Larkin, P.A.** 1988. The future of fisheries management: managing the fisherman. *Fisheries* **13**: 3–9.
- Lash, J.** 1993. Foreword. In: Reid, W.V., Laird, S.A., Meyer, C.A., Sittenfeld, A., Janzen, D.H., Gollin, M.A. and Juma, C. (eds), *Biodiversity Prospecting: Using genetic resources for sustainable development*. v–vii. World Resources Institute, Washington, DC.
- Lean, G., Hinrichsen, D. and Markham, A.** 1990. *Atlas of the Environment*. Prentice Hall, New York.
- Ledig, F.T.** 1986. Conservation strategies for forest gene resources. *Forest Ecology and Management* **14**: 77–90.
- Ledig, F.T.** 1988. The conservation of diversity in forest trees. *BioScience* **38**: 471–479.
- Lleras, E.** 1992. Uso tradicional da biota, manejo e domesticação de recursos genéticos. *Anais Seminário Internacional sobre Meio Ambiente, Pobreza e Desenvolvimento da Amazônia, Belém, 16–19 fevereiro de 1992*. 126–132. PRODEPA, Belém, PA.
- Longley, C. and Richards, P.** 1993. Selection strategies of rice farmers in Sierra Leone. In: de Boef, W., Amanor, K., Wellard, K., and Bebbington, A. (eds), *Cultivating Knowledge*. 169–181. IT Publications, London.
- López-Moreno, I.** (ed.) 1993. *Ecología Urbana Aplicada a la Ciudad de Xalapa*. Instituto Ecológico, Xalapa.
- Lubchenco, J., Olson, A.M., Brubaker, L.B., Carpenter, S.R., Holland, M.M., Hubbell, S.P., Levin, S.A., MacMahon, P.A., Matson, J.M., Melillo, J.M., Mooney, H.A., Peterson, C.H., Pulliam, H.R., Real, L.A., Regal, P.P. and Risser, P.G.** 1991. The Sustainable Biosphere Initiative: an ecological research agenda. *Ecology* **72**: 371–412.
- Lynge, F.** 1991. *Arctic Wars: Animal rights, endangered peoples*. University Press of New England, Hanover, NH.
- Mabey, R.** 1973. *Unofficial Countryside*. Collins, London.
- Macaranas, J.M., Taniguchi, N., Pante, M.J.R., Capili, J.B. and Pullin, R.S.V.** 1986. Electrophoretic evidence for extensive hybrid gene introgression into commercial *Oreochromis niloticus* stocks in the Philippines. *Aquaculture and Fisheries Management* **17**: 249–288.
- McCay, B.J. and Acheson, J.M.** (eds) 1987. *The Question of the Commons: The culture and economy of communal resources*. University of Arizona Press, Tucson.
- MacCleery, D.W.** 1992. *American Forests: A history of resilience and recovery*. US Department of Agriculture Forest Service, Washington, DC.
- McIntyre, G.** 1993. *Sustainable Tourism Development: Guide for local planners*. World Tourism Organisation, Madrid, Spain.
- McManus, J.** 1988. Coral reefs of the ASEAN Region: status and management. *Ambio* **17**: 189–193.
- McNeely, J.A., Thorsell, J.W. and Ceballos-Lascurain, H.** 1992. *Guidelines for the Development of Tourism in National Parks and Protected Areas*. World Tourism Organization, Madrid.
- Mangahas, M.** 1994. Traditional marine tenure and management in ASEAN. *Paper presented at the International Workshop on 'Traditional Marine Tenure and the Sustainable Management of Marine Resources in Asia and the Pacific'*, 4–8 July 1994, Suva, Fiji.
- Martin, R.B.** 1994. Influence of government on conservation of wildlife utilisation. Plenary address at the Conservation through Sustainable Use of Wildlife Conference, 8–11 February 1994, University of Queensland, Australia.
- May, R.M.** 1976. Harvesting whale and fish populations. *Nature* **163**: 91–92.
- Michon, G., Mary, F. and Bompard, J.** 1986. Multistoried agroforestry garden system in West Sumatra. *Agroforestry Systems* **4**: 315–338.
- Mladenoff, D.J. and Pastor, J.** 1993. Sustainable forest ecosystems in the northern hardwood and conifer forest region: concepts and management. In: Aplet, G.H., Johnson, N., Olson, J.T. and Sample, V.A. (eds), *Defining Sustainable Forestry*. 145–180. Island Press, Washington, DC.
- Mladenoff, D.J., White, M.A., Crow, T.R. and Pastor, J.** 1994. Applying principles of landscape design and management to integrate old-growth forest enhancement and commodity use. *Conservation Biology* **8**: 752–762.
- Molmen, O.** 1988. *Jakt-og Fangstkulturen I Skjak og Finndalsfjellet*. Skjak kommune, Oslo.
- Monteiro, S. and Kaz, L.** 1992. *The Atlantic Rainforest*. Edicoes Alumbramento, Rio de Janeiro.
- Moyle, P.B. and Leidy, L.D.** 1992. Loss of biodiversity in aquatic systems: evidence from fish farmers. In: Fiedler, P.L. and Jain, S.K. (eds), *Conservation Biology: The theory and practice of nature conservation, preservation, and management*. 127–170. Chapman and Hall, New York.
- Mullan, J.W., Williams, K.R., Rhodus, G., Hillman, T.W. and McIntyre, J.D.** 1992. *Production and Habitat of Salmonids in Mid-Columbia River Tributary Streams*. US Fish and Wildlife Service Monograph 1. US Department of Interior Fish and Wildlife Service, Washington, DC.
- Myers, N.** 1983. *A Wealth of Wild Species: Storehouse for human welfare*. Westview Press, Boulder, Colo.
- Nabham, G.P.** 1989. *Enduring Seeds: Native American agriculture and wild plant conservation*. North Point Press, San Francisco.
- NAS.** 1972. *Genetic Vulnerability of Major Crops*. National Academy of Science, Washington, DC.
- NAS.** 1993. *Managing Global Genetic Resources: Agricultural crop issues and policies*. Board on Agriculture, National Research Council. National Academy Press, Washington, DC.
- Nasol, C.** 1994. Current status report on the community forestry program. Natural Resource Management Project, US Agency for International Development, Manila, Philippines.
- Nehlsen, W., Williams, J.E. and Lichatowich, J.A.** 1991. Pacific salmon at the crossroads: stocks at risk from California, Oregon, Idaho, and Washington. *Fisheries* **16** (2): 4–21.
- Niemela, J., Langor, D. and Spence, J.R.** 1993. Effects of clear-cut harvesting on boreal ground beetle assemblages (*Coleoptera: Carabidae*) in western Canada. *Conservation Biology* **7**: 551–561.
- Norton-Griffiths, M. and Southey, C.** 1995. The opportunity costs of biodiversity conservation in Kenya. *Ecological Economics* **12**: 125–139.
- Noss, R.F.** 1987. Protecting natural areas in fragmented landscapes. *Natural Areas Journal* **2**: 2–13.

- Noss, R.F. 1993. Sustainable forestry or sustainable forests? In: Aplet, G.H., Johnson, N., Olson, J.T. and Sample, A.V. (eds), *Defining Sustainable Forestry*. 17–43. Island Press, Washington, DC.
- Noss, R.F. and Cooperider, A.Y. 1994. *Saving Nature's Legacy: Protecting and restoring biodiversity*. Island Press, Washington, DC.
- NRC. 1991. *Managing Global Genetic Resources: Trees*. Board on Agriculture, National Research Council. National Academy Press, Washington, DC.
- Ocana, G., Rubinoff, I., Smythe, N. and Werner, D. 1988. Alternatives to destruction: research in Panama. In: Wilson, E.O. and Peter, F.M. (eds), *Biodiversity*. 370–376. National Academy Press, Washington, DC.
- Oldfield, M.L. 1984. *The value of Conserving Genetic Resources*. US Department of Interior, National Park Service, Washington, DC.
- Osherenko, G. and Young, O. 1993. *The Age of the Arctic: Hot conflicts and cold realities*. University Press of New England, Hanover, NH.
- Ostrom, E. 1990. *Governing the Commons: The evolution of institutions for collective action*. Cambridge University Press, Cambridge.
- Padoch, C. and Peters, C. 1993. Managed forest gardens in West Kalimantan, Indonesia. In: Potter, C.S., Cohen, J.I. and Janzowski, D. (eds), *Perspectives on Biodiversity: Case studies of genetic resource conservation and development*. 167–176. AAAS Press, Washington, DC.
- Pauly, D. and Chua, T.E. 1988. The overfishing of marine resources: socioeconomic background in Southeast Asia. *Ambio* 17: 200–206.
- Pauley, D., Silvestre, G. and Smith, I.R. 1989. On development, fisheries and dynamite: a brief review of tropical fisheries management. *Natural Resource Modeling* 3: 307–329.
- Pearse, P.H. 1988. *Rising to the Challenge*. Canadian Wildlife Federation, Ottawa.
- Perl, M., Kiernan, M., McCaffrey, D., Buschbacher, R. and Batmanian, G. 1991. *Views From the Forest: Natural forest management initiatives in Latin America*. World Wildlife Fund/US, Washington, DC.
- Pfister, R.D. 1993. The need and potential for ecosystem management in the forests of the Inland West. In: Aplet, G.H., Johnson, N., Olson, J.T. and Sample, A.V. (eds), *Defining Sustainable Forestry*. 217–239. Island Press, Washington, DC.
- Pimentel, D. (ed.) 1993. *World Soil Erosion and Conservation*. Cambridge University Press, Cambridge.
- Pimentel, D., Acquay, H., Biltonen, M., Rice, P., Silva, M., Nelson, J., Lipner, V., Giordano, S., Horowitz, A. and D'Amore, M. 1992b. Environmental and economic costs of pesticide use. *BioScience* 42: 750–760.
- Pimentel, D., Allen, J., Beers, A., Guinland, L., Hawkins, A., Linder, R., McLaughlin, P., Meer, B., Musonda, D., Perdue, D., Poisson, S., Salazar, R., Siebert, S. and Stoner, K. 1993. Soil erosion and agricultural productivity. In: Pimentel, D. (ed.), *World Soil Erosion and Conservation*. 277–292. Cambridge University Press, Cambridge.
- Pimentel, D. and Levitan, L. 1986. Pesticides: amounts applied and amounts reaching pests. *BioScience* 36: 86.
- Pimentel, D., McLaughlin, L., Zepp, A., Lakitan, B., Kraus, T., Kleinman, P., Vancini, F., Roach, J., Graap, E., Keeton, W.S. and Selig, G. 1991. Environmental and economic effects of reducing pesticide use. *BioScience* 41: 402–409.
- Pimentel, D., Stachow, U., Takacs, A., Brubaker, H.W., Dumas, M.R., Meaney, J.J., O'Neil, J.A.S., Onsi, D.E. and Cozilius, D.B. 1992a. Conserving biological diversity in agricultural/forestry systems. *BioScience* 42: 354–362.
- Pinkerton, E. (ed.) 1989. *Co-Operative Management of Local Fisheries: New directions for improved management and community development*. University of British Columbia Press, Vancouver.
- Pinton, F. 1985. The tropical garden as a sustainable food system: A comparison of Indians and settlers in northern Colombia. *Food Nutrition* 7 (3): 25–28.
- Plucknett, D.L., Smith, N.J.H., Williams J.H. and Anishetty, N.M. 1987. *Gene Banks and the World's Food Supply*. Princeton University Press, Princeton, NJ.
- Poffenberger, M. and McGean, B. 1994. *Policy Dialogue on Natural Forest Regeneration and Community Management: Proceedings of the East-West Center Workshop on Community Forest Management, 2–4 March 1994*. East West Center, Honolulu, Hawaii.
- Poltan-de la Cruz (ed.) 1993. *Our Sea, Our Life*. College of Social Work and Community Development, University of the Philippines, Quezon City, Philippines.
- Pomeroy, R.S. 1993. A research framework for coastal fisheries co-management institutions. *Naga* 16: 14–16.
- Poore, M.E.D., Burgess, P., Palmer, J., Rietbergen, S. and Synott, T. 1989. *No Timber Without Trees: Sustainability in the tropical forest*. Earthscan, London.
- Portman, J.E., Bimey, C., Ibe, A.C. and Zabi, S. 1989. *State of the Marine Environment in the West and Central African Region*. UNEP Regional Seas Reports and Studies 108. UNEP, Nairobi.
- Posey, D.A. 1984. A preliminary report on diversified management of tropical forest by the Kayapo Indians of the Brazilian Amazon. *Advances in Economic Botany* 1: 112–126.
- Posey, D. A. 1993. Indigenous knowledge in the conservation and use of world forests. In: Ramakrishna, K. and Woodwell, G. (eds), *World Forests for the Future: Their use and conservation*. 59–78. Yale University Press, New Haven, Conn.
- Pott, R. 1992. Environmental conservation practices in a commercial forestry enterprise. *South African Forestry Journal* 16 (3): 36–39.
- Prescott-Allen, R. and Prescott-Allen, C. 1983. *Genes from the Wild*. Earthscan, London.
- Prescott-Allen, R. and Prescott-Allen, C. 1990. How many plants feed the world? *Conservation Biology* 4: 365–374.
- Pullin, R.S.V. 1988. Tilapia genetic resources for aquaculture. *ICLARM Conference Proceedings* 16.
- Pullin, R.S.V. 1992. Aquaculture and biodiversity. Paper presented at the Centenary Symposium of the Port Erin Marine Biological Station, Isle of Man, 17–18 September 1992.
- Pullin, R.S.V. 1994. Biodiversity and aquaculture. Paper presented at the UNESCO International Forum on Biodiversity, Science and Development, Paris, 5–9 September 1994.
- Putz, F.E. 1987. Natural management of tropical moist forests: silvicultural and management prospects of sustained utilization. *Trends in Ecology and Evolution* 2: 217–218.

- Putz, F.E.** 1993. *The Ecological Foundations of Natural Forest Management in the American Tropics*. The Center for Tropical Conservation, Duke University, Durham, NC.
- Ramkrishnan, P.S.** 1992. *Shifting Agriculture and Sustainable Development: An interdisciplinary study from North-Eastern India*. Man and the Biosphere Series, Volume 10. UNESCO, Paris.
- Reid, W.V., Barber, C.V. and laVigne, A.** 1995. Translating genetic resource rights into sustainable development: gene co-operatives, the biotrade and lessons from the Philippines. *Plant Genetic Resources Newsletter* **102**: 1–17.
- Reid, W.V., McNeely, J.A., Tunstall, D.B., Bryant, D.A. and Winograd, M.** 1993. *Biodiversity Indicators for Policymakers*. World Resources Institute, Washington, DC.
- Renard, Y.** 1991. Institutional challenges for community-based management in the Caribbean. *UNESCO Nature and Resources* **27**: 4–9.
- Ricker, W.E.** 1954. Stock and recruitment. *Journal of the Fisheries Research Board of Canada* **11**: 559–623.
- Ricker, W.E.** 1981. Changes in the average size and average age of pacific salmon. *Canadian Journal of Fisheries and Aquatic Science* **38**: 1636–1656.
- RSU.** 1985. *Umweltprobleme der Landwirtschaft*. Rat von Sachverständigen für Umweltfragen. Kohlhammer, Stuttgart.
- Ruddle, K.** 1987. Administration and conflict management in Japanese resource management in the context of customary tenure. *Marine Resource Economics* **7**: 249–273.
- Ruddle, K., Hviding, E. and Johannes, R.E.** 1992. Marine resources management in the context of customary tenure. *Marine Resource Economics* **7**: 249–273.
- Ryman, N. (ed.)** 1981. *Fish Gene Pools*. Ecological Bulletins (Stockholm) **34**.
- Ryman, N. and Utter, F. (eds)** 1987. *Population Genetics and Fishery Management*. Washington Sea Grant Publications/University of Washington Press, Seattle.
- Ryman, N., Utter, F. and Laikre, L.** 1994. Protection of aquatic biodiversity. In: Voigtlander, C.W. (ed.), *The State of the World's Fisheries Resources*. Proceedings from the World Fisheries Congress, Plenary Session, Athens, Greece, 3–8 May 1992. 92–115. Oxford and IHB Publishing Co., New Delhi.
- Salm, R.** 1983. Coral reefs of the Western Indian Ocean: a threatened heritage. *Ambio* **12**: 349–353.
- Salm, R.V. and Clark, J.R.** 1984. *Marine and Coastal Protected Areas: A guide for planners and managers*. IUCN, Gland.
- Sayer, J.A. and Whitmore, T.C.** 1991. Tropical moist forests: Destruction and species extinction. *Biological Conservation* **55**: 199–214.
- Sen Gupta, R., Ali, M., Bhuiyan, A.L. Hossain, M.M., Sivalingam, P.M., Subasinghe, S. and Tirmisi, N.** 1990. *State of the Marine Environment in the South Asian Seas Region*. UNEP Regional Seas Report and Studies 123. UNEP, Nairobi.
- Showalter, T.D. and Means, J.E.** 1988. Pest response to simplification of forest landscapes. *Northwest Environmental Journal* **4**: 342–343.
- Sizer, N.** 1994. Opportunities to save and sustainably use the world's forests through international cooperation. *WRI Issues and Ideas*. World Resources Institute, Washington, DC.
- Skogland, T.** 1985. The effects of density-dependent resource limitations on the demography of wild reindeer. *Journal of Animal Ecology* **54**: 359–374.
- Skogland, T.** 1988. Bestandsdynamisk analyse av villreinstammen i Forellhogna. *Villreinen* **2**: 14–22.
- Skogland, T. and O. Molmen,** 1979. Prehistoric and present habitat distribution of wild mountain reindeer at Dovrefjell. *Proceedings of the 2nd International Reindeer/Caribou Symposium*. Roros, Norway.
- Smith, I.R.** 1979. A research framework for traditional fisheries. *ICLARM Studies and Reviews* **2**: 1–40.
- Smith, N.J.H., Williams, J.T., Plucknett, D.L. and Talbot, J.P.** 1992. *Tropical Forests and Their Crops*. Cornell University Press, Ithaca, NY.
- Snook, L.C.** 1989. The search for sustainable tropical silviculture: regeneration and growth of mahogany after disturbance in Mexico's Yucatan forests. *Tropical Resources Institute News Bulletin*, Fall 1989. Yale University School of Forestry and Environmental Studies, New Haven, Conn.
- SPWD.** 1992. *Joint Forest Management: Concept and opportunities*. Proceedings of a workshop at Surajkund, India, August 1992. Society for the Promotion of Wastelands Development, New Delhi.
- Soemarwoto, O. and Soemarwoto, I.** 1984. The Javanese rural ecosystem. In: Rambo, T. and Sajise, P.E. (eds), *An Introduction to Human Ecology Research on Agriculture in Southeast Asia*. 261–270. University of the Philippines, Los Banos.
- Soulé, M.E.** 1991. Land use planning and wildlife maintenance: guidelines for conserving wildlife in an urban landscape. *Journal of the American Planning Association* **57**: 313–323.
- Steinbeck, K.** 1993. Vegetation diversity after logging in the Southern Appalachians. Letter to the editor. *Conservation Biology* **7**: 221.
- Steyermark, J.A. and Huber, O.** 1978. *Flora de Avila*. Sociedad Venezolana de Ciencias Naturales y Ministerio del Ambiente y de los Recursos Naturales Renovables, Caracas.
- Sykora, K., de Nijs, L. and Pelsma, T.** 1994. Plant communities in road verges and their importance for the conservation of plant communities. Abstract TU/2A. *Symposium on Community Ecology and Conservation Biology*, 14–18 August 1994, Bern, Switzerland.
- Thiollay, J.M.** 1992. The influence of selective logging on bird species diversity in a Guianian rain forest. *Conservation Biology* **6**: 47–63.
- Tinsley, B.** 1983. *Singapore Green: A history and guide to the botanic gardens*. Times Books International, Singapore.
- Tolba, M.K., El-Kholy, O.A., El-Hinnawi, E., Holdgate, M.W., McMichael, D.F. and Munn, R.E.** 1992. *The World Environment 1972–1992: Two decades of challenge*. Chapman and Hall, London.
- Uhl, C., Buschbacher, R., Clark, K., Kauffman, B., Nepstad, D. and Subler, S.** 1990. Studies of ecosystem response to natural and anthropogenic disturbances provide guidelines for designing sustainable land-use systems in Amazonia. In: Anderson, A. (ed.), *Alternatives to Deforestation: Steps towards sustainable use of the Amazon rain forest*. 24–42. Columbia University Press, New York.

- Uhl, C.** and Viera, I. 1989. Ecological impacts of selective logging in the Brazilian Amazon: a case study from the Paragominas region of the State of Para. *Biotropica* **21**: 98–106.
- UN.** 1989. *World Population Prospects*. United Nations, New York.
- USFWS.** 1988. *1985 Survey of Fishing, Hunting, and Wildlife Associated Recreation*. US Department of Interior Fish and Wildlife Service, Washington, DC.
- Veltre, D.W.** and Veltre, M.J. 1987. The northern fur seals: a subsistence and commercial resource for Aleuts and the Aleutian and Pribilof Islands, Alaska. *Inuit Studies* **11**: 51–72.
- Waples, R.S.** 1991. Genetic interactions between hatchery and wild salmonids: Lessons from the Pacific Northwest. *Canadian Journal of Fisheries and Aquatic Science* **48** (Supplement 1): 124–133.
- White, T.A.** 1989. Two community-based marine reserves: lessons for coastal management. In: Chua, T.E. and Pauly, D. (eds), *Coastal Area Management in Southeast Asia: Policies, management strategies and case studies*. ICLARM Conference Proceedings 19, 36–47. International Centre for Living Aquatic Resources Management, Manila.
- Whitmore, T.C.** 1975. *Tropical Rain Forests of the Far East*. Clarendon Press, Oxford.
- Whitmore, T.C.** and Sayer, J.A. (eds). 1992. *Tropical Deforestation and Species Extinction*. Chapman and Hall, London.
- Wiersum, K. F.** 1984. Strategies and designs for afforestation, reforestation and tree planting. PUDOC, Wageningen.
- Wilkes, H.G.** 1977. Hybridization of maize and teosinte in Mexico and Guatemala and the improvement of maize. *Economic Botany* **31**: 254–293.
- Wilkes, H.G.** 1983. Current status of crop plant germplasm. *CRC Reviews in Plant Sciences* **1**: 133–181.
- Wilkes, H.G.** 1989. Germplasm preservation: objectives and needs. In: Knutson, L. and Stoner, A.K. (eds), *Biotic Diversity and Germplasm Preservation: Global imperatives*. 13–41. Kluwer, Dordrecht.
- Wilkes, H.G.** 1991. *In-situ* conservation of agricultural systems. In: Oldfield, M. and Alcorn, J. (eds), *Biodiversity: Culture, conservation and ecodevelopment*. 86–101. Westview Press, Boulder, Colo.
- Wilkes, H.G.** 1992. Strategies for sustaining crop germplasm preservation, enhancement, and use. *Issues in Agriculture, No. 5*. Consultative Group on International Agricultural Research, Washington, DC.
- Wilkes, H.G.** 1993a. El Teosinte en Mexico como modelo para la conservación *in-situ*: un reto. In: Benz, B. (ed.), *Biología, Ecología y Conservación del Género Zea*. 257–270. Universidad de Guadalajara.
- Wilkes, H.G.** 1993b. Germplasm collections: their use, potential, social responsibility, and genetic vulnerability. In: *International Crop Science 1993*. 126–134. Crop Science Society of America, Madison, Wis.
- Wilson, E.O.** 1993. Foreword. In: Aplet, G.H., Johnson, N., Olson, J.T. and Sample, V.A. (eds), *Defining Sustainable Forestry*. Island Press, Washington, DC.
- Wolfe, M.S.** 1986. The current status and prospects of multi-line cultivars and varieties mixtures for disease resistance. *Annual Review of Phytopathology* **23**: 251–273.
- Worede, M.** and Mekbib, H. 1993. Linking genetic resources conservation to farmers in Ethiopia. In: de Boef, W., Amanor, K., Wellard, K. and Bebbington, A. (eds), *Cultivating Knowledge*. 118–129. IT Publications, London.
- World Bank.** 1995. *Implementing the Convention on Biological Diversity: Toward a strategy for World Bank assistance*. World Bank Environment Department Papers, Biodiversity Series No. 14. World Bank, Washington, DC.
- WRI.** 1992. *World Resources 1992–93*. Oxford University Press, New York.
- WRI.** 1994. *World Resources 1994–95*. Oxford University Press, New York.
- WRI/IUCN/UNEP.** 1992. *Global Biodiversity Strategy*. World Resources Institute, World Conservation Union, and the United Nations Environment Programme, Washington, DC.
- WTO.** 1992. *1992 Yearbook of Tourism Statistics*. World Tourism Organization, Madrid.
- WTO.** 1991. *1991 Yearbook of Tourism Statistics*. World Tourism Organization, Madrid.
- Young, O.R., Freeman, M.M.R., Osherenko, G., Anderson, R.R., Caulfield, R.A., Friedheim, R.L., Langdon, S.J., Ris, M. and Usher, P.J.** 1995. Subsistence, sustainability and sea mammals: reconstructing the international whaling regime. *Oceans and Coastal Management* (in press).
- Zerner, C.** 1994. Transforming customary law and coastal management practices in the Maluku Islands, Indonesia. In: Western, D., Wright, R.M. and Shrum, S.C. (eds), *Natural Connections: Perspectives in community-based conservation*. 80–112. Island Press, Washington, DC.
- Zeven, A.C.** and Zhukovsky, P.H. 1975. *Dictionary of Cultivated Plants and Their Centres of Diversity*. PUDOC, Wageningen.

13.4 Protecting and restoring ecosystems, species, populations and genetic diversity

13.4.1 Introduction

The sustainable use methods discussed in 13.3 are essential steps toward conserving the world's biotic wealth. Some species are best conserved within sustainable use systems because these confer value and provide direct economic incentives. However, it is not possible to maintain all elements of biodiversity within forestry, fisheries, agriculture and other systems where humans extract or directly manipulate biological resources. For example, many species, including wild relatives of commercially important species, occur in habitats of limited direct utility for agriculture, forestry or even consumptive wildlife cropping. Managing the overall diversity of genes, species and ecosystems, therefore, also requires actions to set aside some areas as nature reserves and to place rare or endangered species and genetic resources in *ex situ* (off-site) facilities, ideally with a view to the restoration of wild habitats. This chapter assesses a wide range of methods associated with conservation systems (e.g. protected areas and natural habitat management, restoration ecology, zoos, botanical gardens, museums, seed banks and germplasm-

storage facilities) in which the preservation of biodiversity is a principal objective. These methods are, in a sense, insurance against the limitations of the sustainable use approaches presented in the previous chapter.

13.4.2 Protecting ecosystems

In most definitions of biodiversity (see Sections 1 and 2), ecosystems represent the highest level of biological interaction. Because biological communities, species, populations, genes and the biogeochemical processes that sustain life are all represented in the concept of the ecosystems, many conservation efforts emphasize methods of protecting ecosystems. These methods seek to regulate human activities in geographic areas where they may adversely impact populations of species or interfere with ecosystem processes (e.g. fire and other natural disturbance regimes) upon which a given ecosystem's biodiversity depends. One of the major goals in conservation biology is to protect a representative array of ecosystems and their constituent biodiversity. In addition to protected area measures, ecosystem protection methods also include efforts to maintain habitat fragments and corridors in human-dominated landscapes, and to protect or mimic specific ecological processes (e.g. hydrologic regimes) important to an area's biodiversity.

13.4.2.1 Protected areas

A protected area is defined by the Convention on Biological Diversity as 'a geographically defined area which is designated or regulated and managed to achieve specific conservation objectives'. At the Fourth World Congress on National Parks and Protected Areas, held in Caracas, Venezuela, in 1992 (IUCN 1994b), such protected areas were defined as areas 'of land and/or sea especially dedicated to the protection and maintenance of biological diversity, and of natural and associated cultural resources, and managed through legal or other effective means'. The *Global Biodiversity Strategy* (WRI/IUCN/UNEP 1992) defines a protected area as 'a legally established land or water area under either public or private ownership that is regulated and managed to achieve specific conservation goals'. Whatever the precise definition, protected areas have figured prominently in biodiversity conservation efforts around the world.

Nearly 10 000 protected areas are recognized by the IUCN Commission on Parks and Protected Areas. These areas are managed for objectives ranging from strict preservation to controlled resource harvesting. All contribute in some way to conserving biodiversity, but modifying the management and selection of protected areas will enhance their contribution. Explicit biodiversity conservation objectives need to be established for each protected area, and in most cases, they need to be better integrated into the fabric of social, environmental and economic welfare

(WRI/IUCN/UNEP 1992). If protected areas are to become more effective in maintaining biodiversity, serious obstacles must be overcome, including, among others:

- inadequate biogeographic distribution;
- conflicts with local peoples;
- ineffective management and funding, and
- a limited appreciation of potential roles in sustainable development.

13.4.2.1.1 Protected area classification, size, and distribution. An overview of the world's protected area systems is given in Table 13.4-1. This gives the extent of protected areas in square kilometres and the percentage coverage in each of the geopolitical regions recognized by the IUCN Commission on National Parks and Protected Areas (CNPPA). These data are drawn directly from the 1993 *United Nations List of National Parks and Protected Areas* (IUCN 1994a), which provides an internationally recognized definition of the global protected area system.

Three criteria govern whether or not a protected area is included in the UN List: size, management objectives, and the authority of the management agency:

Size. For practical reasons, only protected areas of more than 10 km² are included, with the exception of offshore or oceanic islands of at least 1 km² where the whole island is protected.

Management objectives. A series of protected area management categories, defined by management objective, was identified by IUCN/CNPPA in 1978; these have been revised since the 1993 UN List was published (IUCN 1994b). IUCN Management Categories are applied irrespective of national names for protected areas. Categorization is by primary management objective and assignment to a category is not a commentary on management effectiveness.

Authority of the management agency. In the past, only those sites managed by the 'highest competent authority' were included in the UN List, i.e. those within the highest appropriate level of government. In the current edition of the List, those sites managed by state or provincial authorities within federal systems have also been included.

The UN List therefore represents a subset of the 37 000 protected area sites recorded in the WCMC (World Conservation Monitoring Centre) protected areas database. As of 1994, 9832 protected areas qualify under the above criteria for inclusion in the UN List.

Table 13.4-1: Summary of the protected areas of the world, by IUCN Management Category.^a

Region	Area of region (km ²)	Area in IUCN Protected Area Categories (hectares)										Total	
		I	%	II	%	III	%	IV	%	V	%		
Antarctica	14 266 827	242 535	0.0 ^b	0	0.0	0	0.0	0	0.0	0	0.0	242 535	0.0
Australia	7 682 300	3 816 022	0.5	27 849 176	3.6	262 416	0.0	13 344 479	1.7	48 273 364	6.3	93 545 457	12.2 ^c
Caribbean	223 597	43 591	0.2	827 082	3.7	0	0.0	627 982	2.8	619 086	2.8	2 117 741	9.5
Central America	542 750	404 570	0.7	3 188 978	5.9	35 305	0.1	1 256 914	2.3	6671	0.0	4892 438	9.0
East Asia	11 789 415	556 535	0.0	7 040 084	0.6	30 000	0.0	56 203 052	4.8	4 341 243	0.4	68 170 914	5.8
Europe	4 997 983	4 238 069	0.8	6 839 020	1.4	359 385	0.1	8 932 772	1.8	33 879 241	6.8	54 241 097	0.9
North Africa/ Middle East	11 689 075	2 337 176	0.2	13 495 664	1.2	21 150	0.0	12 322 427	1.1	5 111 744	0.4	33 273 161	2.8
North America	23 453 544	17 213 590	0.7	153 751 419	6.6	8 150 758	0.3	89 841 265	3.8	25 805 208	1.1	294 762 240	12.6
North Eurasia	22 100 900	40 840 872	1.8	5 062 444	0.2	0	0.0	23 453 003	1.1	151 217	0.0	69 516 526	3.1
Pacific ^d	750 813	1 733 878	2.3	4 224 761	5.6	24 745	0.0	304 791	0.4	0	0.0	6 288 175	8.4
South America	17 910 095	6 109 143	0.3	56 622 936	3.2	4 751 117	0.3	25 432 993	1.4	19 886 467	1.1	112 801 056	6.3
South and South East Asia	8 448 801	7 591 672	0.9	19 734 001	2.3	19 715	0.0	22 273 206	2.6	717 744	0.1	50 336 338	6.0
Sub-Saharan Africa	23 934 911	1 345 672	0.1	78 148 622	0.3	31 600	0.0	54 321 127	2.3	2 299 947	0.1	136 161 968	5.7
Total	147 791 011	86 473 325	0.6	376 784 187	2.5	13 686 19	0.6	308 314 011	2.1	141 091 932	1.0	926 349 646	6.3

^a IUCN management categories are given in Box 13.4-1.

^b Percentage figure reduced to zero due to rounding.

^c Percentage figure inflated because land area is used in calculation whilst Great Barrier Reef Marine Park (343 800 km²) is marine.

^d Pacific includes New Zealand, in line with recent re-definition of CNPPA Regions.

Data source: 1993 United Nations List of National Parks and Protected Areas (IUCN 1994a)

The growth in the number of protected areas and their area has been dramatic during the past 30 years, although the rate of growth has slowed considerably since 1980 (see Figure 13.4-1). Information for the 1993 UN List was gathered by WCMC from management agencies during the course of 1993, in collaboration with IUCN. Three important types of protected areas – forestry reserves, private nature reserves and other protected areas, and indigenous reserves – have not been included in the UN List, either because the areas do not meet the criteria or because available information is incomplete. Nevertheless, the contribution of these three sectors to conservation and sustainable development is considerable.

The extent of protection varies widely from one region to another, from 2.8% of land area in North Africa and the Middle East (IUCN's classification recognizes a small area in Category I for Antarctica, although the entire continent was recently dedicated to 'science and peace') to 12.6% in North America. These aggregated figures disguise variation within a region. For example, in Europe, Austria has nearly 25% of its land area within protected areas, while Greece has less than 2%.

Figure 13.4-2 depicts the distribution of protected areas across a range of size classes. In general, there is a large number of relatively small protected areas and a limited number of very large sites. Only four sites cover more than 100 000 km² apiece, but between them they cover 1.7 million km², a large proportion of the global total (approximately 17%). The largest protected area in the world, Greenland National Park at 972 000 km² accounts for more than 10% of all the area protected. The large number of smaller sites should not be dismissed, however, because many are carefully located to protect specific habitats, species or other areas of conservation concern. Many nations, for example in the Pacific and Caribbean, do not have the territory to establish extensive terrestrial protected areas, and many of these sites are excluded from these data on the basis of the 10 km² minimum-size criterion.

Definitions of the IUCN Protected Area categories are shown in Box 13.4-1. Figure 13.4-3 illustrates the much higher prevalence of Category IV sites (Managed Nature Reserve), even though Category II (National Park) covers a

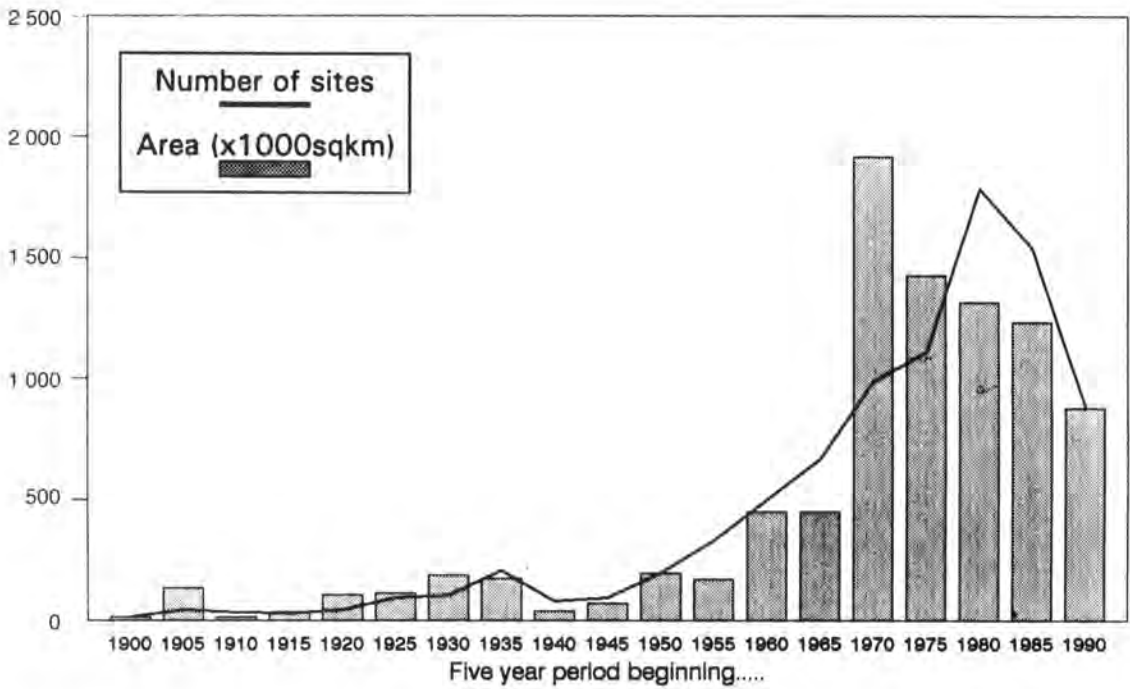

Figure 13.4-1: Growth of the global protected areas network (non-cumulative). (Source: McNeely *et al.* 1994.)

greater area. Again there is a strong degree of regional variation. Category V (Protected Landscape) is widely used in Europe where there is little opportunity to set aside extensive, strictly protected tracts of land. On the other hand, precisely those opportunities have existed in South America, where half of the protected area system is classified as more strictly protected Category II sites. Although Category I and II reserves cover almost 4% of Australia's landscape, many major ecosystems are poorly represented. Areas in the recently created Category VI (Managed Resource Protected Areas) are not included in this summary.

Two key aspects are not revealed in these summary statistics: management effectiveness and threats to protected areas. Although global, systematic data are not available, there is clear evidence that a large proportion of protected areas have yet to be implemented on the ground (IUCN 1992). Inadequate legal and institutional support, and insufficient manpower and financial resources, result in many areas receiving a less-than-satisfactory level of protection. Allied to this is the number and severity of threats faced by protected areas, including development pressures, unmanaged tourism, poaching, and so on. Thus the data in Table 13.4-1 indicate the quantity, but not the quality, of protected areas.

In addition to listing protected areas according to their geopolitical distribution, it is also possible to analyse their biogeographical distribution. Protected areas included in the UN List have been located within one of the biogeographical provinces defined by Udvardy (1975),

which divide the world into eight realms, subdivided into 193 provinces, with each province being characterized by one of 14 biome types. Of the 9832 protected areas qualifying for inclusion, 8564 are classified by the Udvardy province in which they are located. The remaining 1268 sites, including a large number of marine sites, cannot be classified within this system.

Table 13.4-2 provides a summary of protected area coverage (number of sites, area protected, percentage of realm protected) for each of the eight realms recognized by Udvardy (1975). In terms of the 10% protected-areas coverage target established by IUCN for each realm, only the Nearctic Realm (Mexico, the United States, Canada and

Table 13.4-2: Analysis of protected areas coverage of the world by biogeographical realm.

Bio-geographical realm	Area (km ²)	Number of protected areas	Area protected (ha)	Percentage of realm protected
Nearctic	23 315 775	1920	288335 396	12.37
Palearctic	51 915 285	3201	182837 457	3.52
Afrotropical	22 158 701	638	127518 926	5.75
Indomalaya	7 534 895	886	61268 745	8.13
Oceania	1 036 754	107	8 162 598	7.87
Australia	7 719 450	627	38 592 509	5.00
Antarctic	12 948 311	242	7 692 585	0.59
Neotropical	18 976 487	940	119 156 630	6.28
Unclassified		1280	92 847 628	

After Udvardy 1975; source: IUCN 1994a.

Box 13.4-1: 1994 IUCN Revised Protected Area Categories.

Category I: Strict Nature Reserve/Wilderness Area. To protect nature and maintain natural processes in an undisturbed state in order to have ecologically representative examples of the natural environment for scientific study, environmental monitoring, education and maintenance of genetic resources in a dynamic and evolutionary state. There are two sub-categories: Ia includes protected areas managed mainly for scientific research and monitoring; Ib includes protected areas managed mainly for wilderness protection, subsistence and recreation.

Category II: National Park. To protect outstanding natural and scenic areas of national or international significance for scientific, educational and recreational use. These are relatively large areas not materially altered by human activity and where extractive resource uses are not allowed.

Category III: National Monument/Natural Landmark. To protect and preserve nationally significant natural features because of their special interest or unique characteristics. These are relatively small areas focused on the protection of specific features.

Category IV: Habitat/Species Management Area. To assure the natural conditions necessary to protect nationally significant species, groups of species, biotic communities or physical features of the environment where these may require specific human manipulation for their perpetuation. Controlled harvesting of some resources may be permitted.

Category V: Protected Landscapes and Seascapes. To maintain nationally significant natural landscapes that are characteristic of the harmonious interaction of man and land while providing opportunities for public enjoyment through recreation and tourism. These are mixed cultural/natural landscapes of high scenic value where traditional land uses are maintained.

Category VI: Managed Resource Protected Area. This is a new category designed to include areas that ensure long-term protection and maintenance of biodiversity while providing a sustainable flow of natural products and services to meet community needs. They are intended to be relatively large and predominantly unmodified natural systems where traditional and sustainable resource uses are encouraged.

Source: IUCN (1994b).

Greenland) is adequately protected. Data at the level of the 193 individual Udvardy provinces (not given here; see IUCN 1994a) show that approximately 25% of biogeographical regions appear to have more than 10% of their area protected.

There are, however, limitations to using the Udvardy system to analyse the biogeographic representativeness of the world's protected areas. This is due both to its relative imprecision and, for example, differences in size between provinces. A 5000 hectare protected area in the relatively small Malagasy Thorn Forest province on Madagascar, for example, would protect a much larger section of that province than a reserve of equal size in the huge Somalian province of northeast Africa.

While the results are sufficient to illustrate patchy coverage, more detailed analysis is necessary to determine real needs and priorities. Efforts to identify such priorities have been conducted by the IUCN Commission on National Parks and Protected Areas (CNPPA) for Indo-Malaysia (MacKinnon and MacKinnon 1986a), sub-

Saharan Africa (MacKinnon and MacKinnon 1986b) and Oceania (Dahl 1986). More recently, the CNPPA completed regional reviews for the world's protected areas that were presented at the Fourth World Congress on National Parks and Protected Areas in Caracas, Venezuela, in February 1992. After the Congress, these reviews were revised and published (see McNeely *et al.* 1994).

Table 13.4-3 provides a summary of protected area coverage (number of sites and total area) by biome type. A biome is a major portion of the living environment of a particular region (such as coniferous forest or grassland), characterized by its distinctive vegetation and maintained by local climatic conditions. Protected area coverage of biomes ranges from as low as 0.69% in temperate grasslands, to a little under 10% in subtropical and temperate rainforests ('mixed island systems' have greater protection but this category – along with 'mixed mountain systems' – is frequently criticized for being too general), again providing broad guidelines for the location of additional protected areas.

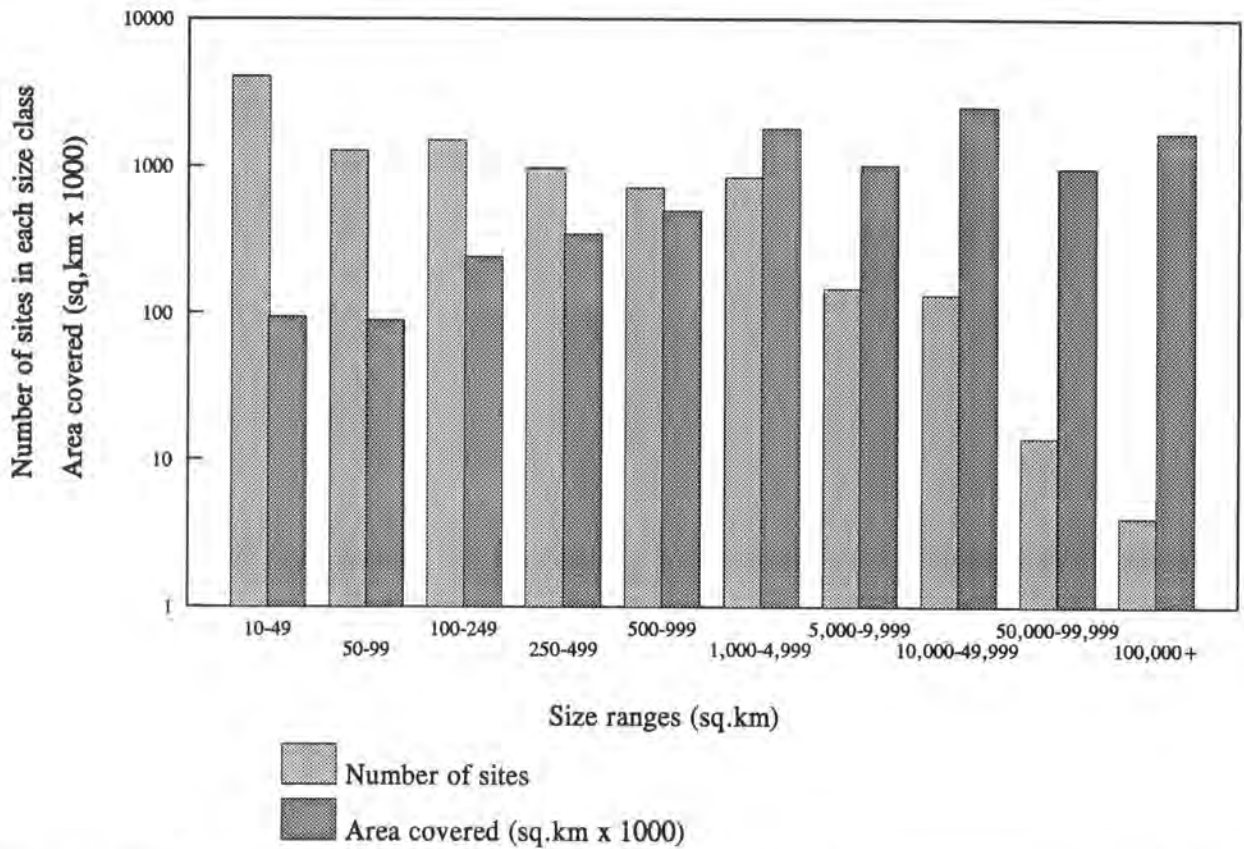

Figure 13.4-2: Size distribution of protected areas in the 1993 UN List of National Parks and Protected Areas. (Source: IUCN 1994a.)

Summarizing the coverage by biome gives a first approximation of how well the major ecological formations are legally protected. There is again considerable variation of protection within biomes and a wide range in the actual management effectiveness of individual protected areas. It is important to recognize that biome type does not mean the same as habitat type; a protected area within a tropical humid forest biome may not necessarily contain tropical humid forest, and an area containing tropical humid forest could occur in another biome altogether (such as mixed island systems). Note in this regard that Udvardy identifies all of Indonesia, insular Malaysia, and the Philippines as mixed island systems rather than tropical humid forest. Also, as was noted above for provinces, there are significant differences between the areas covered by different biome types. For example, in the Neotropics the tropical humid forest biome covers an extensive area (about a quarter of the continent), while the lake systems biome covers only a small area (e.g. Lake Titicaca on the Peru/Bolivia border). It should also be noted that these are aggregates of protected areas with different management objectives – not all areas are protected to the same degree, as discussed below.

13.4.2.1.2 Managing biodiversity in protected areas. Protected area designations, as explained above, are legal, policy or traditional mechanisms by which society can

establish regimes for land/sea management to maintain and protect plant, animal and cultural resources of particular value. They are packaging devices to help assemble and apply the necessary means to achieve defined ends. In nearly all protected areas, some uses (e.g. scientific research and non-consumptive ecotourism) are allowed, and in many protected areas, various sustainable uses of renewable resources are permitted.

All six types of protected areas, as categorized by IUCN (see Box 13.4-1), provide distinct land-management systems with the potential to conserve biodiversity while at the same time meeting other objectives. The utility of employing a systematic classification lies in its fostering a rigorous determination of the objectives of management, the geographic placement in the landscape/seascape, and the means or measures that are to be employed. By this relatively universal approach, the Strict Nature Reserve/Wilderness Area, for example, is employed where objectives focus upon the maintenance of relatively wild habitats and ecosystems for the purpose of retaining samples of a nation's various natural environments, e.g. forest types, grasslands, mountain ranges, coastal formations and coral reefs. Assigning a site to this category makes explicit the government's intention to maintain biodiversity in the area and to promote knowledge and understanding of the site's resources. It also makes explicit

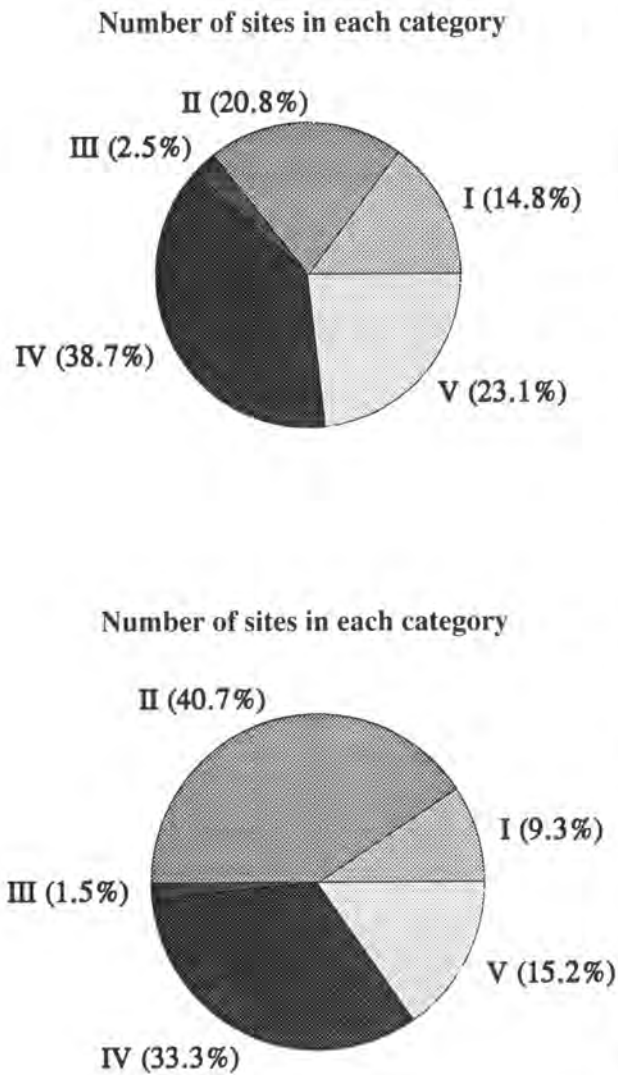

Figure 13.4-3: Number and extent of protected areas by IUCN Management Categories. (Source: IUCN 1994a.)

that other possible uses of the same area for agriculture or timber extraction, for example, will be forgone.

At the other end of the spectrum of protected area types, the Protected Landscape/Seascape category seeks to maintain an entire set of ecosystems that have been significantly shaped by people over time and have acquired cultural value. Generally, these areas feature older land-use practices and/or cultural structures or remains that societies want to retain. This management system seeks to encourage rural and town residents to remain in the area and fosters land-use practices that deliberately retain selected landscape features (e.g. hedgerows in the United Kingdom) or the restored ancient or traditional architecture and structures (e.g. Machu Picchu and Cuzco, Peru). These types of areas can also feature the retention and nurturing of biodiversity on farms and around villages (Altieri and Merrick 1987; Ghosh 1993; see 13.3.2).

A new category, Managed Resource Protected Areas, was created in 1994 to recognize that many areas are

protected in order to maintain the ability of traditional and local communities to sustainably use biological resources within relatively unmodified natural landscapes. For example, extractive reserves in Brazil have been established to protect natural forest areas used by rubber tappers, Brazil-nut harvesters and others from being converted to agricultural or plantation uses which would preclude the harvesting of natural forest products.

These management systems are administered predominantly by the highest level of government, hence the nomenclature of national park, national monument, national reserve, etc. Alternatively, other levels of government (state, province, county) and private interests (NGOs, communities, indigenous traditions) have established protected areas which they administer. Examples include the state parks of the United States, the provincial parks of Canada, the community forests and grazing lands of Africa, and the sacred forests of India, Indonesia and the Amerindians of the Western Hemisphere, the vast network of private reserves of The Nature Conservancy in the United States and rapidly expanding networks of private nature reserves in Brazil, Colombia and Paraguay.

13.4.2.1.3 Defining management objectives. The design of areas protected principally for biodiversity preservation, or those managed for biodiversity and other compatible objectives, begins with two fundamental steps: defining the management objectives for the area, and the actual selection of a site.

A desire to maintain a sample of a particular biome with disturbances limited to natural forces and the necessary scientific interventions may preclude resource extraction on that site. Elsewhere, human interaction with the site may be long, intensive and traditional. In these cases, the biodiversity to be conserved may require continuing intervention through farming, fire, extractive use of the forests or grazing. Here, management systems will be designed to fit the context. They may feature co-operative management and possibly co-operative finance programmes with local people, be they neighbours of the reserve or its residents (e.g. North Yorkshire Moors, UK, see Statham 1994; the Chico Mendez Extractive Reserve, Brazil, see Hecht and Cockburn 1989).

Two issues are fundamental to the selection of management categories:

1. Trade-offs are a necessary feature of establishing a management system in a defined area. Only by clarifying the objectives and relating those to an assessment of the status and trends of the site can decision-makers (agency directors, community leaders, scientists) determine the 'best mix' of means and ends. If biodiversity is the objective, then other possible commitments and uses will be shaped around this dominant purpose. Alternatively, if watershed

Table 13.4-3: Distribution of protected areas by biome type.

Biome type	Area (km ²)	Number	Area (ha)	%
Tropical humid forests	10 513 210	506	53 833 388	5.1
Subtropical/temperate rainforests/woodlands	3 930 979	899	36 629 731	9.3
Temperate needle-leaf forests/woodlands	15 682 817	429	48 722 746	3.1
Tropical dry forests/woodlands	17 312 538	799	81 755 123	4.7
Temperate broad-leaf forests	11 216 660	1507	35 823 999	3.2
Evergreen sclerophyllous forests	3 757 144	776	17 758 448	4.7
Warm deserts/semi-deserts	24 279 842	300	98 400 670	4.1
Cold-winter deserts	9 250 252	136	36 472 009	3.9
Tundra communities	22 017 390	78	164 504 267	7.5
Tropical grasslands/savannahs	4 264 833	59	23 512 784	5.5
Temperate grasslands	8 976 591	194	9 998 248	0.8
Mixed mountain systems	10 633 145	1277	85 249 420	8.0
Mixed island systems	3 252 270	530	32 276 920	9.9
Lake systems	517 694	17	663 486	1.3

Protected areas are excluded from the above analysis if location is unknown. Based on 1992 data. Source: IUCN (1994a).

restoration, tourism, or extraction for rural people are the dominant ends, then biodiversity management will be the goal that is limited and shaped.

2. Conserving biodiversity *in situ* as an objective may not always be consistent with purposes that include maintaining the 'wilderness' character of an area together with free-ranging recreation or tourism, and it will certainly be at odds with the use or introduction of exotic species, especially in cases of restoration and rehabilitation work.

The second key step is the actual selection of the site. With the general objective determined (e.g. protecting a representative sample of a coastal wetland type, maintaining several breeding populations of an endangered antelope, or preserving an area that features an important strain of wild rice), the appropriate geographic site can be selected. This determination should include factors such as: the species, populations and communities desired; land/or sea area (size) needed to include a range of habitat types, patch dynamics, and ecosystem processes; and places for the necessary installations and facilities. Methods to maximize biodiversity captured in the process of site selection have become increasingly sophisticated (e.g. Margules *et al.* 1988; see also 13.2).

Typically, countries will face a more practical challenge. How can existing protected areas be managed in order to maintain biodiversity adequately? Two types of problems arise:

1. Existing parks and reserves may already be committed to other dominant purposes such as tourism or some form of natural resource extraction. In these cases, a research programme (see below) can be used to readjust an area's objectives, zoning and installations, and even its management category.
2. The area may be adequate for its original objective, but subsequent improvements in scientific knowledge and shifts in social goals that favour biodiversity management may call for adjustments in the size and shape of the reserve to include habitats and sites critical for specific species, migration, pollination, stream flow and other ecological factors.

Ideally, revising a site's management plan by agency and community leaders and scientific personnel will identify opportunities for extension of the area where needed and the application of restoration techniques (see 13.4.4).

Ten generally supported guidelines can be listed to guide the establishment or replanning of protected areas that will have biodiversity conservation as their central or major purpose:

1. **Number of areas.** A larger number of sites will provide better coverage of the diversity of habitats and transition areas in the country. The larger number will also cover the need for redundancy as protection from disease and catastrophic natural or anthropomorphic disturbance or social upheaval. Having a single reserve in each

- biological region of the country is risky for these reasons.
2. **Size.** Ideally, each area should be as large as needed to embrace the biota of concern, together with the related habitats and ecosystem factors. Naturally, both number and size will be co-determined by social and economic factors in terms of habitation density, occupancy by local human residents, availability of agricultural soils, and internal demand for food and material production from these same areas.
 3. **Interconnectedness.** The intervening landscape or water areas should permit the flow of biota from site to site in response to daily and seasonal changes (e.g. migration), climate change, and other large and small spatial and temporal-scale factors. The establishment of corridors between protected areas and other natural habitats is discussed in 13.4.2.2.
 4. **Zoning.** Within the selected area, designation of various zones can segregate management objectives and uses that may be incompatible and identify management activities by area. Areas of key significance for their genetic materials may well be zoned out of human visitation. Scientific research sites may warrant special protection. Places of high value for education and recreation will require installations, trails and transportation. These zones for public access will perhaps have less potential for protecting certain features of biodiversity, but can maximize other legitimate goals of the reserve (Miller 1980).
 5. **Location of facilities and infrastructure.** The design of trails and roads, buildings and infrastructure (fuel, sewage, water, power) can affect biodiversity. Physical development, even those limited facilities required by most protected areas, should be designed and located as part of the overall ecological assessment, mapping and analysis (Miller 1980).
 6. **Research and monitoring programmes.** Management can be effective only to the extent that it is supported by information and knowledge. A research and monitoring programme is an essential component of management and administration. Trends in plant succession, migratory patterns of birds and ungulates, and stream flow are but a few indicators of change that may show positive or negative responses to human interventions (see, for example, Kraus and Brown 1992; Bourdages *et al.* 1992). In addition, countries may wish to link protected-area research programmes to the inventorying of the areas' biota, systematic screening, and chemical prospecting with an eye to potential biotechnological applications (Reid *et al.* 1993).
 7. **Biological-resource management programmes.** A biological-resource management plan can clarify possible needs for interventions (fire, restoration, eradication of exotics, captive breeding, etc.), and their geographic placement, seasonal timing, etc. The plan should also include prescriptions for the protection of key genetic resources, for fostering or maintaining patch dynamics, and for other detailed measures. As discussed in subsequent sections of 13.4, an array of methods is available for conserving biodiversity at the genetic, species and habitat/ ecosystem/landscape levels. In an ideal protected areas context, these methods are applied as called for in the management plan as a result of findings from the research and monitoring programme (see 6 above).
 8. **Education programmes.** Protected areas are excellent places for educating people about nature and the relationship between nature and people. Examples from all over the world demonstrate a variety of effective approaches to education through interpretative materials, exhibits, and opportunities for viewing wildlife and plants. Various countries (e.g. Costa Rica: Gámez 1993) consider the intellectual development of their people to be one of the primary goals of their protected area system.
 9. **Use management programmes.** All IUCN management categories feature one or more types of human use, ranging from direct uses (tourism, recreation, education, research, monitoring, genetic resources, extraction of non-timber products, timber, wild game, fish, etc.) to indirect uses (environmental services, such as water, air, climate regulation, soil conservation and geochemical cycles). The degree to which biodiversity can be conserved at the genetic, species and landscape/ecosystem levels will depend on how these use regimes are managed (see 13.3 and subsequent sections of 13.4).
 10. **Bioregional management programmes.** Protected areas are components of a larger landscape or seascape, as noted in 13.1. For biological, ecological, economic and socio-cultural reasons, protected areas cannot accomplish their objectives if they are treated as islands within regions of land- or water-use conflicts and impoverishment. Protected area management where biodiversity is a major objective will succeed only to the extent that co-operative arrangements are made among public agencies, local residents and industry. These agreements must ensure that the management of biological resources and ecosystems in adjacent areas are consistent with the management objectives of the protected areas.

Examples of advanced work on bioregional management include the tri-country Waddensee programme along coastal Denmark, Germany and the Netherlands (Wadden Sea Assessment Group and Trilateral Working Group 1991), the Serengeti Greater Ecosystem in Kenya and Tanzania (Ministry of Tourism, Natural Resources and Environment 1991), La Amistad in Costa Rica and Panama (Gobierno de Costa Rica 1990), the Great Barrier Reef in Australia (Murdoch 1992), and Yellowstone National Park in the United States (Rawlins 1994), as reported by Miller (1995).

13.4.2.1.4 Effectiveness of protected areas for maintaining biodiversity. Two issues are critical in assessing the effectiveness of protected area systems for biodiversity conservation. First, do the protected areas have clear biodiversity management objectives and the appropriate boundaries, legal status, funding and personnel to obtain those objectives? Second, do local people benefit economically from protected areas, and do they have incentives to use the resources in surrounding areas sustainably? Assessing the biological effectiveness of a protected area network requires information on the range of biodiversity elements contained within the area, and on the quantity and kind of management inputs going into protected areas management.

While reasonably accurate data on the number and area coverage of protected areas are available for most countries, more specific information on the effectiveness of protected areas in conserving elements of biodiversity is generally not available, even for countries with well-established protected areas. For example, Newmark (1987) documented the extirpation of large mammals during the twentieth century in every national park in the continental United States, indicating the lack of systematic monitoring and protection even of large mammals in the US National Park System. While some countries have attempted to conduct surveys of key species, information on the biodiversity contained within protected areas is inadequate for virtually all groups, except some vertebrates. Monitoring of genetic diversity has received far less attention than it deserves.

In India, which has a protected areas network of over 500 national parks and nature reserves covering nearly 5% of the country's land area, two nationwide surveys have been conducted to assess the effectiveness of the network. On the biological front, the Wildlife Institute of India evaluated the biogeographic coverage of the existing protected areas network and suggested options to plug the major gaps (Rodgers and Panwar 1988). The second survey (Kothari *et al.* 1989), conducted simultaneously by the Indian Institute of Public Administration (IIPA), looked at various management parameters of the protected area

network: legal status, research and monitoring, human use and management activities (see Box 13.4-2).

McNeely *et al.* (1994) review protected areas management effectiveness around the world. Priority actions to improve management and increase the ability of protected areas to conserve biodiversity are presented by region (14 regions including coastal marine areas).

Social and economic measures to enhance the compatibility of biodiversity management in protected areas with economic and social development are presented in 13.5. These measures are vital to the success of protected areas management strategies in developing countries, and frequently in developed countries as well.

13.4.2.2 Managing corridors and natural habitat fragments

Fragmentation of natural ecosystems is generally seen to be one of the most important threats to biodiversity worldwide (Saunders *et al.* 1991; Bierregaard *et al.* 1992; Kattan *et al.* 1994). Fragmentation occurs when human activities such as agricultural development, forestry or urbanization remove large proportions of the natural ecosystem and replace them with a greatly modified matrix, within which small remnants of the native ecosystem remain. This process results not only in vastly reduced areas of the natural ecosystems but also their subdivision into small and relatively isolated fragments. Roads, railroads, powerlines and pipelines are also important fragmentation factors in many places, although they may not directly convert large areas of habitat.

13.4.2.2.1 Response of ecosystems to fragmentation. The response of biota to ecosystem fragmentation has received much study and is well documented in the conservation literature. This research has largely centred on species and community responses to changes in ecosystem size and isolation, most of it within the theoretical framework of island biogeography (Diamond 1975; Wilson and Willis 1975; Simberloff 1988; Shafer 1990; Soulé 1991). Considerable debate has focused on such questions as whether a small number of large reserves will maintain native biota better than a larger number of smaller reserves, and whether reserves linked by corridors are better than those without linkages. Much of this debate has been carried on with a paucity of data from real systems. Saunders *et al.* (1991) pointed out that, until recently, relatively little emphasis has been placed on understanding the effects of fragmentation on the structural and functional aspects of natural and managed ecosystems.

Much attention has been focused on the effects of habitat size and isolation on the biota in remnant areas. It was suggested that remnant areas should be similar to islands and that the biota should follow the rules developed by island biogeography (Diamond 1975; Wilson and Willis 1975). While the biogeographic processes operating as a

Box 13.4-2: Biological and management effectiveness in India's protected areas system.

A review of India's protected areas system (Kothari *et al.* 1989) demonstrated that:

1. The process of selecting protected areas and determining which protection category to put them in was arbitrary, unsystematic and inconsistent. Protected areas were also not placed in any rational system of regional land-use planning. As a result, highly degraded or densely settled areas were designated as national parks (the highest form of protection under Indian law), and important biodiversity areas were not included in the network.
2. As many as 60% of the national parks and 92% of the sanctuaries had not completed the required legal procedures for their establishment as protected areas. Lack of co-ordination between the Forest Department wildlife authorities and the civil administration responsible for land acquisition was partially responsible.
3. Management planning was widely classified as seriously deficient – only 43% of the national parks and 28% of the sanctuaries reported the existence of management plans. No detailed guidelines for preparing plans exist, and available plans were often assessed as inadequate.
4. Research was reported in only 42% of national parks and 23% of sanctuaries, with even fewer reporting the existence of basic research facilities. Regular monitoring was absent virtually everywhere, with the exception of a periodic census of large mammals and birds in some areas.
5. Funds for staff and equipment were highly deficient, compromising efforts to protect and manage these areas (only 1.5% of Forest Department budgets went to protected areas management in 1984, and there are few indications that this has increased during the past decade).

These management deficiencies weaken the ability of India's protected areas network to conserve a representative range of the country's biodiversity. The IIPA report made a number of recommendations to improve the situation, some of which are under consideration by the central and state governments. IIPA is now following up with detailed assessments at the level of each state and union territory, with comprehensive directories of protected areas being one result (Singh *et al.* 1990; Pande *et al.* 1991; Lal *et al.* 1994).

result of habitat reduction and isolation undoubtedly have a profound impact on the biota of fragmented systems, the alteration in landscape processes resulting from fragmentation also has large impacts.

Most studies of fragmented systems concentrate on the fragments, and most conservation management is conducted within individual fragments. However, fragments of native vegetation sometimes make up only a small percentage of the landscape and are heavily influenced by the surrounding matrix of agricultural (or other production-based) land. The switch from continuous cover of native vegetation to small fragments in a predominantly altered matrix brings with it many important consequences for remnant vegetation, over and above the biogeographic effects of reduced area and increased isolation (Saunders *et al.* 1991; Hobbs 1993). These stem from changes in physical, chemical and biotic flows in the altered landscape. The consequences are particularly important at fragment edges, where significant changes in microclimate and vegetation can occur, with concomitant effects on the native fauna (Kapos 1989; Laurance *et al.*

1993; Matlack 1993a,b; Scougall *et al.* 1993; Sisk and Margules 1993; Laurance 1994). Also relevant are changes in the disturbance regime and the spread of disturbance through the fragmented landscape (Hobbs 1987; Baker 1992), with resulting changes in ecosystem dynamics (e.g. Yates *et al.* 1994).

An important alteration to regional hydrology can result from the extensive fragmentation of native vegetation. For instance, in the Western Australian wheat-belt, removal of native vegetation and its replacement with annual crops and pastures results in considerably less efficient use of rainfall, increased runoff and greater inputs to the water table (Nulsen *et al.* 1986; McFarlane *et al.* 1992, 1993). This has led to rising water tables – raised by as much as 50 centimetres per year in some areas (George *et al.* 1995).

Beneath much of the wheat-belt are considerable quantities of salt stored at depth. As water tables rise, the stored salt is mobilized, and wherever the water table reaches the surface, salinization occurs. Salinization and waterlogging have resulted in the loss of large areas of productive farmland (McFarlane *et al.* 1993) and also

threaten the fragments of native vegetation. Many low-lying areas are affected, and most of the lakes have now gone saline (Froend *et al.* 1987; Froend and McComb 1991; Hobbs *et al.* 1993). In some areas the water table is rising so quickly that remnant vegetation will be destroyed within the next 5–10 years (George *et al.* 1995). Such considerations are also relevant in many other areas. The importance of surrounding land uses in altering the hydrological balance, and hence compromising the conservation values of reserve areas, is being increasingly recognized (Rowell 1986; Green and Robins 1993; Harding 1993).

As well as physical and chemical flows in the landscape, the flow of biota from the surrounding matrix can threaten the integrity of fragmented ecosystems. This can include grazing by domestic stock (Scougall *et al.* 1993), the influx of feral herbivores, predators, and non-native plant species (Kinneer *et al.* 1988; Friend 1990; Brothers and Spingarn 1992; Hester and Hobbs 1992), and increased predation rates, especially at fragment edges (Brittingham and Temple 1983; Martin 1988; Small and Hunter 1988; Paton 1994). Insect communities are also strongly affected: for example, native pollinators are often displaced by wild or hive-based honey bees. These factors often pose the greatest threats to biodiversity in fragmented systems.

The above discussion illustrates that ecosystem fragmentation does not entail a simple reduction in area and increase in isolation. Accompanying these changes are many other impacts. It may be very difficult to understand these dynamics since we cannot differentiate between the effects of fragmentation *per se* and the effects of matrix-derived influences. The difficulty of interpreting *post hoc* what is happening in fragmented systems is also highlighted by recent studies in Mexico, where studies of recently fragmented forest areas have shown that regeneration dynamics and vegetation structure are markedly altered, not by fragmentation *per se* but by the loss of large herbivores (Dirzo and Miranda 1990; Dirzo 1992).

Without some knowledge of the dynamics of the unfragmented system, such insights would have been impossible. This therefore suggests that we should be cautious in our attempts to understand long-fragmented systems. What we observe may make little sense simply because the dynamics are now far removed from those prevailing in the original system. This also influences the way in which we should go about managing these systems.

13.4.2.2.2 Corridors in fragmented landscapes. Biotic movement in a fragmented landscape requires movements among individual fragments. Many fragments are likely to be too small to support populations of many native animal species, and hence these need to move around the landscape to fulfil their resource and habitat requirements. Corridors of native vegetation linking fragments are commonly seen as a solution.

Much debate has centred on the utility of corridors, following the initial enunciation of their value in terms of biogeographic design (Noss 1987; Simberloff and Cox 1987; Harris and Scheck 1991; Hobbs 1992; Simberloff *et al.* 1992). Faunal studies have indicated that considerable movement between remnants does occur, at least for some species (Saunders and de Rebeira 1991; Arnold *et al.* 1993). Corridors are likely to enhance the probability of movement and survival, even if they are not essential for this. Hobbs (1992) suggested that unequivocal data on the requirement of corridors for movement would be very difficult to obtain. Recent radiotelemetry studies by Lynch *et al.* (1995) have indicated that the biotic movement function that corridors provide may actually be secondary to an important habitat function. Corridors thus act as additional habitat and as representatives of the native ecosystems in their own right.

Corridors are, therefore, often an important component of the conservation network. They are, however, more prone than are remnant areas to the many external (i.e. matrix-derived) influences discussed above, since their long, narrow shape leads to a high edge-to-area ratio. They are also more susceptible than the equivalent remnant areas to nutrient enrichment, weed invasion and episodic insect attack (Cale and Hobbs 1991; Hobbs and Atkins 1991; van Schagen *et al.* 1992). Corridors thus require more costly and intensive management than do larger blocks. It has also been suggested that corridors may act as conduits for disease and pest species (Pysek and Prach 1993; Hess 1994; Inglis *et al.* 1994). Depending on corridor characteristics, they may be used only by cosmopolitan species. In a review of scientific evidence, Dawson (1994) found that corridors:

- sometimes allow individual animals to survive by giving them access to sufficient habitat to meet their needs;
- can maintain populations of some animal and plant species by replenishment; however, most probably either fail to use a corridor (perhaps because it is not wide enough) or can cross gaps between patches of habitat without corridors; and
- can serve the needs of some migratory animals in their seasonal movements.

For corridors to be effective for species restricted to the interior of fragments, they need to be wide enough to contain a significant area of interior (or 'non-edge') environment. The present limited knowledge suggests that corridors should be used where they can be cost-effective, since they do permit some species to thrive where they otherwise would not, and the habitat type chosen or created for corridors should match the requirements of the target species (Dawson 1994). Corridors will be most effective

when they protect the known movement routes of migratory or highly mobile species. The decision to include corridors in a conservation network has therefore to be taken with these factors in mind. Simply establishing corridors between existing fragments or parks, without demonstrable need or plan, may not be the best use of limited funding.

13.4.2.2.3 Protection and management of fragments.

The protection and management of natural habitat fragments requires a reduction in the deleterious effects of matrix-derived influences on remnants and an increase in the area and connectivity of habitat. Where fragmentation is ongoing, this can be achieved by ensuring that the remaining native vegetation is arranged optimally, as far as we can determine with current knowledge. This means that representative areas of all major ecosystems in a region need to be reserved, that blocks should be as large as possible, that buffer zones should be established around core areas, and that corridors should connect these areas. This basic design is central to the recently proposed Wildlands Project in the United States (Noss 1992), a controversial long-term strategy (100 or 200 years) to expand natural habitats and corridors to cover as much as 30% of the US land area. While the basic recipe appears simple and perhaps over-ambitious, the actual selection of core areas and of priority areas for reservation can be problematic, and must be linked to clear conservation objectives. A variety of reserve selection procedures is available (e.g. Usher 1986; Margules *et al.* 1991; Pressey *et al.* 1994; see also 13.2).

Frequently, however, conservation considerations do not play an adequate part in determining the patterns of fragmentation and many areas are already extensively fragmented. In these cases, retroactive action that involves the protection of existing fragments and the enhancement of the existing network is required. Protection must deal adequately with the threats from the external matrix, and thus includes fencing against stock, prevention of weed invasion, and prevention of degradation by human populations. Many of the external threats cannot be dealt with adequately by on-site management alone – management of the surrounding landscape will also be needed. This is a distinct departure from traditional conservation management that has focused almost entirely within individual remnant/reserve areas and has been conducted by conservation agencies largely in isolation from or in opposition to surrounding land managers (see 13.1 for discussion of bioregional management).

A broader perspective is needed that encompasses the entire landscape, including the conservation and production components (Hobbs and Saunders 1991; Hobbs *et al.* 1993). It also requires increased co-operation between neighbouring landowners and managers. Conservation

agencies that have often ignored the human community surrounding nature reserves are now becoming dependent on the co-operation and goodwill of that community to ensure that reserves and the non-reserved habitat remnants continue to form an integral part of the conservation network (see 13.5 for assessment of participatory planning and management; see 13.7 for building capacity to carry out integrated biodiversity management and sustainable use activities).

13.4.2.3 Maintaining ecosystem functions and processes

A variety of tools may be needed to maintain or mimic disturbance regimes, such as fires, grazing, treefalls or flooding, that are key elements in the persistence of certain species and habitat types. For example, when land is set aside as a protected area, the pattern of disturbance and human use may change so markedly that many species previously found on the site disappear (Gómez-Pompa and Kaus 1992). Alternatively, a newly constructed dam may substantially alter or eliminate flooding cycles that certain species or habitat types depend on for their survival (Holloway 1994). 'Keystone' resources, such as standing dead trees or mineral salt licks, that have been lost or are insufficient to sustain a viable population of a rare species in a small area, may need to be enhanced (Primack 1995). The protection, restoration and enhancement of ecosystem processes and functions are vital components in many conservation strategies.

The importance of fire in maintaining healthy ecosystems, wildlife populations and biodiversity has been widely recognized in recent decades. Fire, a common natural disturbance event in some ecosystems, has been suppressed in many areas. As a result, early successional habitats and their associated species, that were once common, have become rare or absent. For example, some of the unique flowers found on the island of Nantucket off the Massachusetts coast are found in coastal heathland areas previously maintained by sheep grazing, and infrequent fires have become rare as scrub oak forest has encroached and shaded out the flowers with the disappearance of both sheep and fire (Primack 1995).

In response, land managers have increasingly used 'prescribed fires' to improve wildlife habitat and recover endangered species. For example, The Nature Conservancy (TNC) conducted its first prescribed burn in a North Dakota mixed-grass prairie habitat in the early 1970s to stimulate the regeneration of several rare plants dependent on fire for regeneration (McLean 1995). Today, TNC conducts burns on nearly 20 000 hectares of grassland and forest habitat around the United States. The organization's fire specialists work with ecologists to carefully document the ecological effects of fire. Several hundred thousand hectares of forest and rangeland are burned on US National Forests each year, often for wildlife and biodiversity

conservation objectives. Prescribed fires, however, can be risky and generate public opposition when they go out of control (McLean 1995). The effects of fire on the composition, function and structure of a variety of ecosystems are documented in Pickett and White (1985). Falk (1992) describes other strategies for maintaining early and mid-successional plant communities that have been suppressed by changes in disturbance regimes.

The diversity of wetland ecosystems is particularly affected by changes in hydrological regimes (Moyle and Leidy 1992). Water levels and the periodicity of low and high water are vital to the survival of many species. Irrigation projects, dams, drainage canals and flood control levees frequently have dramatic impacts on the diversity and abundance of riparian and wetland species. In Florida's Everglades, decades of canal and levee construction have brought in too much water for many species when it is not needed and too little water when it is. Dozens of species found only in the Everglades are at risk of extinction due to these changes while many tropical plants intentionally or accidentally introduced from elsewhere thrive in the new environment (Holloway 1994). In Kashmir, Pandit (1991) documents a long list of plants, fish and birds that have declined during the past 40 years as drainage ditches, filling of wetlands, and increased flooding due to changes in land cover have become more common.

In response, wildlife managers are manipulating water levels to favour the growth of food plants, constructing sediment traps to maintain water quality, banning draining, filling, and burning in sensitive areas and planting vegetative cover on slopes bordering wetlands (see, for example, Pandit 1991; Holloway 1994). Geologists are seeking to reconstruct past flooding regimes on rivers in the western United States where they no longer exist because of impoundments. The absence of these flooding regimes has significantly altered riparian ecosystems. With information on natural flooding regimes along the Platte River in Nebraska, wildlife managers hope to change the timing of water releases on upstream dams to recreate the disappearing sandbar habitats that sandhill cranes depend on during their annual migrations.

Much of the work on protecting and managing ecosystem processes to conserve biodiversity has been carried out in the growing field of restoration ecology. The distinction between managing existing communities and establishing new ones is recognized by Falk (1992):

In the past, successional species generally had somewhere to migrate to; local extirpations were probably relatively common, but there were always new populations emerging. Now that the few parcels of undisturbed land are increasingly fragmented, it will become necessary to restore migratory pathways and to use site management to ensure that adequate successional diversity is maintained.

See 13.4.4 for discussion of ecosystem restoration and rehabilitation.

13.4.3 Protecting species, populations and genetic resources

The most effective and efficient way of conserving biodiversity, by almost any reckoning, is to prevent the conversion or degradation of habitat to begin with. There is no alternative for conserving the diversity of landscapes and ecosystems. But these measures must be complemented by a wide array of techniques to conserve individual species, populations and genes. The options range from species-management programmes in the wild (*in situ*) to off-site (*ex situ*) protection in botanical gardens, zoos, gene banks and aquaria. As discussed in 13.1, an integrated approach to conservation – one that makes use of this entire range of measures – is a cornerstone of biodiversity conservation.

During the past 500 years, extinction rates have increased rapidly (see Section 4) and human actions during this time have been comparable to past geological cataclysms in terms of habitat disruption and species extinction. Highly endangered high-profile vertebrate species, such as black rhinoceros (*Diceros bicornis*), receive most of the media coverage, but may be far less important to humans and the environment than the vastly more numerous but less noticeable invertebrate, plant, fungus, and single-celled species that are being wiped out in obscurity.

Beyond species loss, the erosion of genetic variation is even less obvious and probably much more severe. For example, Lleras *et al.* (1992) have shown that while human-induced species extinction in the Amazon Basin has not been extensive to date, humans have contributed to substantial loss of genetic variability in many species important to humans in the ecotone between the Amazon and the Cerrado.

It is increasingly obvious that conservation is, intrinsically, about the whole array of biodiversity elements, from the tropical forest and all other major ecosystems and 'charismatic megaverbrates' to the vast diversity of plant, invertebrate and microbial species, some of which are undoubtedly keystone species that maintain the diversity and productivity of natural and human-dominated ecosystems. The marginal interest of breeders in ecosystems, communities, species and even populations, and the conservation biologists' lack of interest in genetic resources have hobbled the effectiveness of past conservation efforts. This has been exacerbated by the overall shortage of conservation funding that pits funding for rain forest protection against agricultural diversity conservation (Esquinas-Alcazar 1993).

Today there is a growing awareness that all levels of biodiversity form part of a whole and are interdependent (FAO 1989). This has been well emphasized by the Convention on Biological Diversity signed during the 1992 UN Conference on Environment and Development (UNCED) held in Rio de Janeiro. Genetic resources have

finally, and deservedly, been recognized as priorities for conservation within diverse ecosystems (UNEP 1992).

13.4.3.1 Threatened and endangered species classifications and species management and recovery plans

13.4.3.1.1 Threatened and endangered species classifications. When the IUCN established the Species Survival Commission (SSC) nearly 30 years ago, it established several categories of threat by which to classify species by their potential risk of extinction. Species meeting the criteria for inclusion in one of the categories are then included in *Red Lists* and *Red Data Books* (e.g. IUCN 1990). A growing number of countries have also adopted the traditional *Red Data Book* approach (WCMC 1994). The purpose of these compilations is to develop a database of threatened species, provide the basis for setting species conservation priorities, and monitor the effectiveness of recovery efforts.

Until 1994 when a new categorization was approved, six categories were used, with some modification, to highlight threatened species (Mace and Stuart 1994). These categories were: Extinct, Endangered, Vulnerable, Rare, Indeterminate and Insufficiently Known. The general term 'threatened' has been used to refer to a species belonging to any one of these categories. Useful as the system was for drawing attention to species conservation, many scientists criticized it for being over-subjective. For example, 'Endangered' was defined as, 'Taxa in danger of extinction and whose survival is unlikely if the causal factors continue to operate. Included are taxa whose numbers have been reduced to a critical level or whose habitats have been so drastically reduced that they are deemed to be in immediate danger of extinction.' Categorizations made by different authorities varied and did not always accurately reflect real extinction risks (WCMC 1992).

In 1987, the SSC Steering Committee began an effort to revise the threatened species categories. The goal of the revision was to introduce more objective methodology and criteria, based on population viability analysis, to assign species to threatened categories. After seven years and at least four versions (Mace and Lande 1991; Mace *et al.* 1992; IUCN 1993a; Mace and Stuart 1994), the new threatened species categories were finally completed and approved at the 1994 CITES conference.

The new system (IUCN 1994; see Box 13.4-3) has ten categories: Extinct, Extinct in the Wild, Critically Endangered, Endangered, Vulnerable, Conservation Dependent, Near Threatened, Least Concern, Data Deficient and Not Evaluated. Detailed criteria were established for three of the categories: Critically Endangered, Endangered and Vulnerable. Each category uses the same five criteria: (i) population and habitat decline, (ii) habitat area, (iii) population fragmentation or isolation, (iv) population size, and (v) population viability analysis. Different quantitative

thresholds are used for each category. For example, the mature population size criterion for Critically Endangered is fewer than 50 mature individuals, while the threshold is 250 for Endangered and 1000 for Vulnerable. To be included in a category, a species needs to meet only one of the five criteria (Mace and Stuart 1994). The criteria and the quantitative threshold values for criteria in each category were determined through wide consultation.

Mace and Stuart (1994) applied the new system to eight species to illustrate how the system would work. Critiques directed at earlier versions questioned whether the proposed system would be practical to use for species not well known and for which relatively little quantitative information exists. They concluded that the criteria do not require large amounts of quantitative data before they can be applied. However, since most of the species tested are actively involved in international trade (and thus monitored by CITES), these examples are probably not representative of most species.

Ironically, the new system has received criticism for being too quantitative. For example, the US delegation to the 1994 CITES conference criticized the numerical rankings as being too specific for the vast majority of rare and potentially threatened species, leading to possibly serious errors. In addition, the costs of quantitatively determining species status could result in many countries, particularly developing countries, being unable to protect their wild flora and fauna from excessive international trade (Jones 1994). Its proponents (e.g. Mace and Stuart 1994) have stressed the ability to make a determination of Critically Endangered, Endangered or Vulnerable on the basis of meeting any one of the five criteria. Guidelines for the use of the system have been prepared and Mace and Stuart (1994) urge users to read all sections of the document carefully and to understand the guidelines before applying the new categories.

Regardless of whether a species was classified as threatened under the old or the new system, it must be stressed that Red Lists are compendia of species known to be threatened. Many more species will in fact be threatened but not listed because little information exists or because they have not yet been categorized. For example, while all known bird species have been reviewed, only 50% of the world's mammals, less than 20% of reptiles, 10% of amphibians, and 5% of its fish have been reviewed for potential threatened classification (WCMC 1992).

While it is too early to conclude how effective the new system is, the use of more objective, scientifically based criteria is an important step in threatened species classification. IUCN and others (see BSP *et al.* 1995) are working to develop similar methods of landscape classification for threatened habitat categories (Stuart and Sullivan 1994).

13.4.3.1.2 Management plans. Many species are subject to management plans at both national and international

Box 13.4-3: The revised IUCN Red List categories (from: IUCN 1994d).

Red List Category	Definition
Extinct	There is no reasonable doubt that the last individual of the taxon has died.
Extinct in the Wild	The taxon is known only to survive in cultivation, in captivity or as naturalized population (or populations) well outside the past range. A taxon is presumed extinct in the wild when exhaustive surveys in known and/or expected habitat, at appropriate times (diurnal, seasonal, annual) throughout its historic range have failed to record an individual. Surveys should be over a time frame appropriate to the taxon's life cycle and life form.
Critically Endangered	The taxon is facing extremely high risk of extinction in the wild in the immediate future.
Endangered	The taxon is not Critically Endangered but is facing a very high risk of extinction in the wild in the near future.
Vulnerable	The taxon is not Critically Endangered or Endangered but is facing a high risk of extinction in the wild in the medium-term future.
Conservation Dependent	The taxon is not Critically Endangered, Endangered or Vulnerable but is the focus of a continuing taxon-specific or habitat-specific conservation programme targeted towards the taxon in question, the cessation of which would result in the taxon qualifying for one of the threatened categories above within a period of five years.
Near Threatened	The taxon is not Critically Endangered, Endangered, Vulnerable or Conservation Dependant but is close to qualifying for Vulnerable.
Least Concern	The taxon is not Critically Endangered, Endangered or Vulnerable and does not qualify for Conservation Dependent or Near Threatened.
Data Deficient	There is inadequate information to make a direct, or indirect, assessment of the risk of extinction based on the distribution and/or population status of the taxon. A taxon in this category may be well studied, and its biology well known, but appropriate data on abundance and/or distribution are lacking. Listing in this category indicates that more information is required and acknowledges the possibility that future research will show that threatened classification is appropriate.
Not Evaluated	The taxon has not yet been assessed against the criteria.

levels. At the national level, legislation has been enacted in many countries to provide a legal basis for sustainably managing or protecting species (see also 13.6.3.1). Management plans are usually introduced either because the species in question is perceived to be under some sort of threat (e.g. 'endangered'), or because it is economically valuable. In many cases, such as the European Birds Directive or species recovery plans under the US Endangered Species Act, species management plans do not manage a species directly but work through habitat conservation activities to conserve a species.

Many management plans have failed, in large part because there is a confusion of objectives: namely, the contradiction between conserving the resource and maximizing the short-term economic benefits to user groups. Some management plans, for example many fisheries management plans, have been more concerned with maintaining access to the resource for particular user groups or industrial sectors than with protecting sustainability of the species or the resource (see 13.3.4).

Species management plans at the global level have most frequently been adopted for marine fisheries. In most cases,

vested economic interests have prevented such stocks from being managed sustainably, at least until such time as the stock is severely threatened with economic extinction (Ludwig *et al.* 1993). The collapse of the Western Atlantic cod stocks and conflicts between Canada and the European Union over fishing on the Georges Bank are examples. Occasionally the opposite occurs, when a well-protected species recovers enough to allow limited harvesting. For example, the Revised Management Procedure (RMP) for whales – a plan to selectively lift the international moratorium on whaling – adopts a precautionary approach to the harvesting of several species of whales. Strong public antipathy to whaling, however, has so far obstructed the adoption of the RMP, which is based on years of scientific research.

The possibility exists of developing species management plans within the context of the Convention on International Trade in Endangered Species of Wild Fauna and Flora (CITES). Management plans under CITES have generally involved either export quotas or ranching programmes, designed to ensure the sustainability of uses of the species concerned. These show promise if they are biologically robust as well as economically viable (see also 13.3.5).

13.4.3.1.3 Recovery plans. Recovery plans are a special kind of species management plan, usually developed under legislation designating special status for threatened and endangered species. For example, the US Fish and Wildlife Service is required to develop a recovery plan for any species formally listed as an endangered species. The basic format of species recovery plans is similar the world over. The introduction includes information on the species' ecology and the reasons for its decline. The goal of the plan is then stated, which is usually to achieve enough recovery to allow down-listing of the species to some non-threatened category. Most plans usually include a list of proposed measures – sometimes a long and exhaustive list – to bring about the recovery of the species in question. Such measures most often include establishing protected areas or other forms of habitat conservation, but may also include captive breeding, reintroduction to natural habitats, restriction of harvesting, and reduction of levels of toxic materials in the environment. The final part is usually an implementation schedule, often with a budget. Recovery plans often have the advantage of stimulating co-operation – or at least the prompt exchange of information – between those who have, or who should have, responsibilities for reversing a species' decline.

In reality, many species languish for years on threatened and endangered species lists without a recovery plan. Administrative requirements, gathering scientific information, consultation with NGOs and the public, and limited funding, all contribute to a long gestation period for the typical recovery plan. The plans also often fail to involve local people who are affected by measures to

protect species, a weakness that limits the effectiveness of implementation and may breed resentment against legislation and policies to protect endangered species. Education programmes, which often constitute the public component of a recovery plan, are no substitute for the involvement of local people in the development of the plan itself. Conservation agencies are now beginning to recognize the importance of involving local stakeholders in the development of such plans, an important step relevant to the development of endangered species recovery plans around the world (see 13.5 for participatory mechanisms).

From a technical point of view, effective recovery plans depend on several factors (Caughley 1994):

1. Recovery plans must accurately diagnose the factors causing a species' decline. In many plans, the factors driving declines are assumed, but are not unequivocally demonstrated. Invalid assumptions can, of course, lead to inappropriate recovery strategies that leave the species in an unimproved or even worse condition, perhaps at the loss of significant time and money.
2. Recovery plans should examine the feasibility of recovery options rather than simply list an undifferentiated universe of possible actions.
3. Recovery plans should be implemented using adaptive management techniques so that the successes and failures of the plan can be determined and used to revise both the implementation of the existing plan and the design of future recovery plans. This means that measurable criteria need to be defined in the plan and monitored during implementation in order to assess progress. To avoid the danger of species recovery plans becoming an end in themselves rather than a tool for improving the conservation status of endangered species, Caughley (1994) suggests planners ask seven basic questions:

- What do we want to achieve?
- Can we get there?
- Will we know when we get there?
- How do we get there?
- What are the costs associated with getting there?
- What benefits are to be gained by getting there?
- Will the benefits exceed the costs?

13.4.3.1.4 IUCN Species Survival Commission Action Plans. Some recovery plans operate at a scale different from that of national species recovery plans. In the mid-1960s, the International Union for the Conservation of Nature (IUCN) established the Species Survival Commission (SSC) to focus expert attention on the status and conservation needs of distinct groupings of wild species. The SSC, with over 5000 members in 167 countries, is the largest of the six voluntary commissions of

the IUCN. There are now 102 Specialist Groups covering mammals, birds, invertebrates, reptiles, fish and, to a lesser degree, plants. Each of these Specialist Groups is a volunteer network of scientists that seeks to generate and update information on the species covered by the group, and to devise and implement programmes to conserve the most threatened of those species in collaboration with IUCN members. The most important responsibility of the Specialist Groups is to develop an Action Plan that provides a comprehensive overview of all the species within their group, establishes or applies a system for setting research and conservation priorities, and proposes projects to address those priorities (Stuart 1987).

Since 1986, the SSC has published 24 plans on mammals, two on reptiles, and one on insects. Another 43 plans are currently being written by Specialist Groups: 21 on mammals, 7 on birds, 3 on reptiles and amphibians, 3 on fish, 3 on invertebrates, and 7 on plants. Not surprisingly, the Action Plans use various priority-ranking schemes reflecting differences in data quantity and quality, the number of species covered by the Specialist Group, and other factors perhaps best known to members of the particular group (see Johnson 1995). The Action Plans typically rank conservation priorities for several objectives such as research needs, habitat protection, captive breeding and reintroduction.

But the Action Plans also have limitations. Since the conservation priority-rating systems vary from one animal or plant group to the next, it is not possible to rank conservation needs across groups. It is also often impossible to determine whether high-priority rankings for protected areas management, for example, are more important than an equivalent ranking for surveys or captive breeding. In many regions, the geographical conservation priorities of one Action Plan have not been correlated with overlapping priority areas identified in other Action Plans. However, as more Actions Plans are completed, IUCN is working to prepare regional and country overviews of priorities identified by various Specialist Groups. The first of these overviews (Stuart *et al.* 1990) includes countries in sub-Saharan Africa. Finally, there is the danger of obscuring elements of subjectivity behind the impression of numerical precision. However, as Cumming *et al.* (1990) point out,

The purposes of calculating and using such indices is to produce rational, dispassionate thinking into the process of setting priorities and to reduce arbitrary, subjective elements as much as possible. A primary function of such exercises is to make the rationale for choices explicit and so aid in reaching consensus about priorities for conservation action.

It should be recognized that SSC Action Plans are different from national species-recovery plans. They do not

attempt to be the last word on prescribing the recovery of a particular species. Rather, they attempt to identify global priorities for species conservation, and to make an initial assessment of the actions that need to be carried out, usually at national level. SSC Action Plans are, in a sense, precursors to national species recovery plans. The audiences for the SSC Action Plans are the government agencies and non-governmental organizations that are in a position to bring about their implementation.

The SSC is introducing new concepts into its action planning programme. For some Action Plans, especially those that involve large numbers of species, a workshop format has been introduced to carry out a rapid assessment of the global status of as many species as possible. These Conservation Assessment and Management Planning (CAP) workshops have now been carried out for over 20 groups of species, and their use is likely to increase.

Another innovation likely to be used in the future is to develop species action plans at the national level based on the model of those already carried out for wider geographic ranges by the SSC. Such national species action plans would be important contributions to national biodiversity action plans and strategies developed by Parties to the Convention on Biological Diversity. To stimulate this national approach, the SSC, working in conjunction with IUCN's Commission on National Parks and Protected Areas (CNPPA) and the IUCN Biodiversity Programme, is starting to develop national biodiversity groups.

The Action Plans developed by the IUCN Species Survival Commission Specialist Groups can be an important reference for nearly anyone involved in setting conservation priorities or having species management responsibilities. The SSC Action Plans are largely focused on addressing a wide audience and catalysing conservation efforts along lines that are considered to be of high priority. At the downstream end, national species recovery plans are much more detailed in terms of specific actions and implementation schedules. In either case, it is clear that all plans must be extremely focused on achievable and well-defined objectives if they are to be successful.

13.4.3.2 In situ conservation of species, populations and genetic resources

In situ species conservation measures usually emphasize the protection and management of ecosystems and communities to avoid the loss of resident species. Kemp *et al.* (1993) point out that even when the objective is the conservation of a particular target species or population(s) thereof, this objective may require the protection or management of whole communities – at least until there is a better understanding of the complexities and interactions between ecosystems and target species or populations. For example, most species are part of complex food-web systems composed of many other species, some of which

(e.g. 'keystone species') may be essential to the survival of the target species. Since these relationships are so often poorly understood, habitat protection may be the only prudent course of action.

It is also important to manage species for genetic resources to ensure that they have the range of genetic variation needed to survive in a changing environment. This variation also has potential value to human economic activities, as described in earlier sections.

Although there is sometimes a convergence of basic methodology, ecosystem and genetic resource conservation often differ in objective and degree. A programme of ecosystem protection and management is mainly addressed at the level of biotic communities – species and their relationships – whereas a programme of genetic resource use and protection is geared toward managing genetic variation within and between populations (FAO 1989; Lleras 1991). While ecologists and genetic resource specialists are both interested in species conservation, their methods and strategies complement – but do not substitute for – each other.

For example, the maintenance of a species' genetic diversity can be accomplished only by the protection of large populations in several different areas, while the conservation of a species *per se* may be possible through the protection of a single sample of an ecosystem with a much smaller species-population size. When the objective is to maintain the genetic integrity of a species, a multiple population approach is necessary (Namkoong 1986), and population sizes may need to be in the order of ten times those needed simply to maintain the survival of the same species (Frankel and Soulé 1981; Frankel 1983). Frankel (1983) suggests that conservationists are faced with three options in deciding whether and how to conserve the genetic diversity of targeted species:

1. To provide the habitat area required for survival and continued adaptive evolution without active intervention. This alternative is probably impossible in most situations today and will be even more so in the future.
2. To accept extinction, or remove the species from the environment to collections, botanical and zoological gardens, or other reserves, when habitat area requirements cannot be satisfied.
3. To manage the population size and population structure of the threatened species, which is the principal objective of *in situ* conservation.

Although it was initially believed that *in situ* conservation of genetic resources could be a 'stand-alone' endeavour, carried out by agriculture- and forestry-orientated institutions, for example, it is now clear that *in situ* genetic resource conservation is most likely to be

successful when it is part of the overall framework of conservation efforts in a country or region.

Lleras (1991) recognizes four categories of *in situ* genetic resource conservation strategies:

1. **Little or no management.** This strategy relies on national parks and other protected areas – or unprotected areas with minimal human disturbance – to maintain the population sizes and structures necessary to protect genetic integrity in wild species or populations of wild relatives of crop plants. Recent evidence, however, indicates that humans exert great selection pressure even in 'pristine virgin forests' and other natural ecosystems where anthropogenic influences have been under-appreciated until recently (e.g. Sombroek 1966; Lathrap 1970; Denevan and Zucchi 1978; Taylor 1988; Balée 1989; Gómez-Pompa 1990; Lleras 1992). Therefore, this strategy may be nearly as 'artificial' as the more intensive strategies listed below. A major constraint to this strategy is the lack of information on most species (Frankel 1983; Kemp *et al.* 1993) and major uncertainties about how effective hands-off management can be for maintaining genetic diversity in systems that may already have been or are substantially influenced by human activities.
2. **Moderate management.** This strategy relies on protecting traditional forms of extractivism and animal harvesting to maintain habitat and human practices that have shaped species diversity and have – at least for some manipulated species – contributed to genetic diversity. Brazil's extractivist reserves, where rubber tappers are allowed to tap rubber trees, but most other economic activities (e.g. logging, agriculture, mining, etc.) are restricted, are an example of such management and are appealing to advocates of sustainable development (e.g. Fearnside 1989; Smith *et al.* 1992). Most examples that would fall within this category, however, were designed for economic and social benefits (see further discussion on these issues in 13.5), not the conservation of genetic diversity *per se*. The genetic conservation benefits of such strategies are poorly known, although some work is being conducted (Potter *et al.* 1993).
3. **Intermediate management.** Where biological resources have been extensively manipulated over long periods of time, continued human intervention may be required to maintain species and genetic diversity. In the 1950s, for example, scientists in Israel tried to protect natural populations of *Avena* from disappearing by preventing grazing. However, since a number of *Avena* species had coexisted with grazing pressures for several thousand years, their survival strategies and life-history traits had

come to reflect these pressures. The removal of grazing, as a result, almost led to their extinction. This case has become a textbook example of the dangers of over-protection when species that have coevolved with disturbances, including anthropogenic disturbance, suddenly lose those factors in their environment (Odum 1971).

4. **Intensive management.** This strategy is targeted at domesticated or semi-domesticated species. Since the diversity of domesticated or semi-domesticated species is largely the result of human breeding, the population structure needed to maintain animal varieties and landraces of crops can be maintained only through intensive human management (Manglesdorff 1966; Lleras and Coradin 1986; Hoyt 1988). Retaining this genetic diversity *in situ* requires several approaches (see also 13.3.2). One approach is to retain at least some traditional agricultural practices. A second strategy is to integrate more diverse cropping and breeding systems into modern agriculture. Finally, the conservation of natural and semi-natural habitats where wild relatives of crop species are known to exist is another strategy that should be pursued (see previous *in situ* categories above).

While the principles of *in situ* management for the protection of genetic resources are well known, relatively few areas are actually managed for these purposes (Heywood 1993). In the Garo Hills of India, gene sanctuaries for wild relatives of citrus crops have been established and similar reserves for fruit trees are managed in other parts of India, and in China and Russia. India has several orchid reserves, Ethiopia maintains conservation areas for wild coffee, and a reserve dedicated to the protection of wild chillies (*Capsicum annum*) is maintained on the Coronado National Forest in Arizona (USA). In Brazil, the National Centre for Research in Genetic Resources (CENARGEN) has established seven genetic reserves for a variety of economically important species. More reserves are planned, and CENARGEN is planning to establish seedling banks of perennials *in situ* (Lleras 1991).

It is unclear how many species should be managed in *in situ* programmes. While FAO has conducted a review of *in situ* conservation needs for wild relatives of crop species (FAO 1985), there is no comparable survey for other plant species of economic or scientific interest. No serious attempts have been made – even for wild relatives of crop species – to elevate *in situ* management of targeted species to a prominent place on the conservation or development agenda (Heywood 1993).

Even if they were more widely implemented, *in situ* programmes would not always be available or sufficient to maintain the diversity of species, populations and genetic resources. While *in situ* programmes are nearly always

preferable when there is a choice, *ex situ* technologies have become increasingly useful as an adjunct to on-site conservation and restoration efforts. They are also increasingly effective in their own right.

13.4.3.3 Ex situ strategies

For centuries, gardens, zoos and menageries have been repositories for valuable plants and animals. Although they were often created for the aesthetic pleasure of the rulers of kingdoms and countries that sponsored expeditions, frequently these gardens, zoos and menageries served a more practical purpose. They became centres for the propagation and acclimatization of collected plants and animals that could be valuable to humans in their new environment (Smith 1986). During the last 500 years, these collections have become increasingly important as botanical and zoological gardens in Europe and other parts of the world collected and propagated many species for a variety of uses.

As agricultural and other research institutions developed independent germplasm collections in the first half of the twentieth century, the role of botanical and zoological gardens in conservation was gradually restricted to species with little or no apparent economic value. However, botanical gardens, zoological parks and aquaria have filled an increasingly vital new role as many plant and animal species face an increasingly threatened and uncertain future in the wild.

13.4.3.3.1 Botanical gardens. World-wide, there are now over 1500 botanical gardens and arboreta (Heywood and Heywood 1991), and together they maintain the largest assemblage of plant species outside nature (see also 8.5). While no overall assessment of the diverse array has been conducted, a botanic gardens database developed for the Botanic Gardens Conservation Strategy (WWF/IUCN/BGCS 1989) provides some idea of the biodiversity assets they contain.

As many as 80 000 species (about one-quarter of the world's higher plants) are cultivated in botanical gardens, with individual gardens housing anything from a few hundred to many thousands of species (Heywood 1992a). For example, the Royal Botanic Gardens at Kew in the United Kingdom hold about 38 000 species (about 10% of which are threatened) – more than most countries have in the wild. Only Brazil and Colombia have more plant species on their territory than Kew has in its collection on about 125 hectares. Until recently, however, most collections were built up in response to the interests of individual staff members or patrons, and conservation objectives were rarely expressed in institutional policies.

In recent years, however, an increasing number of botanical gardens have included plant resource conservation as a fundamental part of their mission. Today, over 500 gardens report having conservation collections

and over 100 report having seed banks, tissue culture facilities, and other *ex situ* technologies (Heywood 1992a). Breeding programmes – similar to those used by captive breeding programmes at zoological gardens – are being developed. For example, botanical gardens in the past were content to rely on their own collections for breeding purposes. Today they often co-operate to form breeding pools composed of individuals or populations from various institutions. This is especially important for the many species that have been totally eradicated from the wild and are now found only in these collections (Smith 1986). In 1987, Botanic Gardens Conservation International was established to co-ordinate the conservation activities of botanical gardens around the world. A consortium of North American botanical gardens established the Center for Plant Conservation, now at the Missouri Botanical Garden to increase collaboration in order to protect endangered species of North American flora.

One of the most important roles botanical gardens can play is to participate in recovery programmes for endangered species and degraded ecosystems (see also 13.4.4). Re-stocking, reintroduction and restoration activities provide a critical link between *ex situ* and *in situ* efforts to sustainably use and protect biodiversity. This partnership, however, is not yet well developed. So far, only between 100 and 200 species have been involved in recovery and reintroduction programmes (Heywood 1992a). Botanic Gardens Conservation International has organized workshops to address this issue and has developed guidelines for the reintroduction of species that are rare, endangered or extinct in the wild (Wyse Jackson and Ackeroyd 1994). Some botanical gardens mount major collecting and research expeditions that expand knowledge of plant distributions and ecology, and discover new species. Finally, with as many as 150 million visitors annually (Primack 1995), botanical gardens play an important educational role as well.

13.4.3.3.2 Zoos and aquaria. The role of zoos and aquaria is equally important (see also 8.6). Currently there are approximately 700 000 individuals of 3000 species of mammals, birds, reptiles and amphibians in approximately 800 professionally managed zoos around the world (IUCN 1993b). As with botanical gardens, the conservation role of zoos has been growing. Many zoos now have captive breeding programmes for endangered species and some, such as the National Zoological Park in Washington, DC, actively participate in programmes to breed endangered species and reintroduce them into their natural habitats.

Populations of many rare and threatened species kept by zoos are too small to maintain their genetic diversity. For example, of the 274 species of threatened mammal species maintained world-wide in zoos, only 10% have self-sustaining populations large enough to maintain the genetic diversity needed before reintroduction programmes can

begin (WCMC 1992). In general, a breeding population of 250 individuals is needed to maintain 95% of a species' genetic diversity over 50 generations. Of the 62 species of mammals kept in zoos that are listed by IUCN as endangered or extinct in the wild, 52 are breeding but 14 of these exist only as very small populations in one or two zoos (Olney 1993).

Many major zoos, therefore, have made major investments in building facilities and developing technologies to establish breeding colonies of rare and endangered species. To support these efforts, the IUCN's Species Survival Commission Captive Breeding Specialist Group provides information to zoos on housing conditions, nutritional requirements, and captive breeding technologies and strategies. To help prevent further inbreeding and genetic depression, the International Species Inventory System maintains a central breeding database with information on 4200 kinds of animals at 395 zoological institutions in 39 countries (Primack 1995). There are now international stud books for 104 species of birds and mammals, 68 of which are threatened. To effectively enlarge the breeding population of a species that any single zoo has, there is close co-operation among many of the larger zoos around the world that share breeding stock, frozen sperm, captive breeding technologies, etc.

Aquaria are perhaps the least advanced in captive breeding efforts (see also 8.6). Currently, aquaria maintain approximately 5800 species of fish, most of them collected from the wild (Olney and Ellis 1991). Techniques first used by the tropical freshwater aquarium trade are now being used to propagate endangered freshwater fauna such as the desert pupfishes of the American Southwest and the African Rift Valley lakes. Breeding programmes for marine fishes and corals are at an early stage. Based on their extensive experience with the breeding of common captive species, such as the bottle-nosed dolphin, aquaria will also have a major role to play in the conservation of endangered cetaceans (Primack 1995).

Ex situ conservation of animals is expensive. For example, Leader-Williams (1990) estimates that the cost of maintaining African elephants and black rhinos is 50 times greater than maintaining the same number of individuals in East African national parks. Conway (1988) notes that under current conditions in zoos around the world, no more than 900 species can be maintained for any length of time, and far fewer in breeding programmes conserving long-term genetic viability. Zoos that do not simultaneously invest in habitat conservation, while raising large amounts of funding to develop new captive breeding technologies and facilities in habitat conservation, may do little to enhance the survival prospects of endangered species. For example, large investments have been made in captive breeding programmes (which have failed, thus far) for the critically endangered Sumatran rhinoceros. Rabinowitz

(1995) believes that this has diverted attention and resources from the *in situ* conservation of the Sumatran rhino in Sabah, where two important populations of this species might still survive. Similarly, MacKinnon and MacKinnon (1991) fear that captive breeding programmes are ignoring the fundamental causes of species endangerment and thereby limiting the potential effectiveness of reintroduction programmes. They suggest that zoos 'adopt' protected areas and help raise funds for the protection and management of these sites in addition to developing captive breeding programmes. Others (e.g. Olney *et al.* 1994) believe resources spent on captive breeding would not necessarily be available for *in situ* conservation. With zoos attracting hundreds of millions of visitors annually, captive breeding programmes may be the closest many people come to learning about the challenges of conserving biodiversity.

13.4.3.3.3 Gene banks. The last decade has also seen the re-evaluation of genetic resource-conservation priorities for agricultural research institutions. In the past, these institutions were typically concerned only with the genetic resources of a few commercial crop and livestock species (see also 13.3.2). A variety of factors, including genetic vulnerability, the high environmental costs associated with the use of high-yield varieties, and limited or depleted soil and water resources, are stimulating these institutions to search for new uses for species utilized in the past and potential uses for some of the thousands of plant and animal species that are barely known to science.

Speculation that all useful species have already been domesticated (e.g. Hawkes 1969) is unlikely to stand the test of time. For example, a large number of potentially useful wild palm species are candidates for domestication (Lleras and Coradin 1986). Lleras *et al.* (1992) estimate that fewer than 50% of the plant species in the Amazon basin are known to science. The same may be true for other tropical ecosystems. Wild relatives of cultivated species of major potential in breeding programmes continue to be discovered.

Table 13.4-4 presents a synthesis of the plant and animal gene bank accessions that are conserved *ex situ*. For the major crops, a large amount of germplasm is available *ex situ*, and it represents a fairly high percentage of the cultivars known to exist (see Sections 2.2 and 3.1). The same is true for breeds of the major groups of domestic animals. Assuming these gene banks are effective in maintaining viable germplasm, it would appear that the genetic resources of the most important crop and animal species for human food consumption are not seriously endangered.

These data require careful interpretation, however, since many *ex situ* collections, particularly in developing countries, are poorly maintained or lack adequate storage facilities. While over 4.6 million accessions of plant

Table 13.4-4: Estimated accessions of domesticated plants (a) and animals (b) in ex situ gene banks.

(a) Plants

Type of germplasm	Mean % landraces	Accessions
Cereals	79	2 082 621
Food legumes	68	743 756
Forage legumes and grasses	N/A	452 043
Vegetables	70	374 467
Fruits	N/A	243 823
Industrial crops	65	241 826
Roots and tubers	55	186 687
Oil crops	N/A	91 067
Sugar, beverage, spice crops	N/A	74 517
Others/unknown	N/A	117 253
Total plants		4 608 060

(b) Domestic animals

Species	Breeds on File	Breeds at Risk
Ass	69	6
Buffalo	70	1
Cattle	845	120
Goat	330	39
Horse	360	99
Pig	368	69
Sheep	880	108
Total	2,922	442

(Adapted from Plucknett *et al.* (1987) and IPGRI (1995) for plants; Loftus and Scherf (1993) for livestock.)

germplasm exist world-wide (IPGRI 1995; Table 13.4-4), some are replicates, poorly documented and poorly preserved. It is probable that a high percentage of these accessions have lost their viability. While gene banks and other *ex situ* strategies have often been recommended as part of integrated wild plant conservation programmes (e.g. Frankel and Soulé 1981; Given 1990; Falk 1992; Heywood 1992b), wild species now account for fewer than 2% of total germplasm accessions (Astley 1991). Ashton (1987), however, warns that *ex situ* strategies should be considered carefully if they are to complement, not compete with, *in situ* conservation efforts. Hamilton (1994), moreover,

demonstrates that releasing seed-bank genotypes in natural populations can depress population fitness if the seed-bank material does not contain genotypes of high relative fitness in the introduction habitat.

Nevertheless, one collection in one gene bank may hold the special characteristics needed to deal with a new disease or pest. If this gene were not available, an entire crop species might face catastrophic failure, as has occurred in certain geographic regions for crops such as rice, maize, potatoes and citrus.

During the 1970s and early 1980s, collecting germplasm and adding accessions were the highest priorities for many gene banks. The characterization and evaluation of the accessions lagged far behind the collecting, and still does. Therefore, a low percentage of the stored germplasm has actually been incorporated into breeding programmes, and complete characterization and evaluation of existing accessions is probably impossible.

To overcome the problems associated with the gap between collection size and capacity for characterization and evaluation, it has been suggested that representative samples – between 10 and 20% – of the large collections should be taken and characterized to form smaller 'core collections' (Frankel and Brown 1984; Lleras *et al.* 1994; Hodgkin *et al.* 1995). The core collections would then be characterized and evaluated in detail, and steps taken to incorporate them into breeding programmes. Core collections are now being established for rice, corn, cassava and several other species. During the next few years, core collections will probably be extended to all crop species, including wild relatives of crop species (Hodgkin *et al.* 1995).

At the International Workshop for Core Collections held in Brasilia in 1992, Lleras (1994) also proposed that *in situ* or field gene banks should be established for biodiversity conservation areas (e.g. protected areas, key areas where traditional agriculture is practised, etc.). These could serve as core collections for plant species associated with the individual conservation areas, giving rise to an *in situ* core collection strategy.

13.4.3.3.4 Ex situ technologies. A growing range of technologies and strategies are available to conserve species and genetic resources *ex situ* (see also Sections 2 and 8). Table 13.4-5 presents an overview of *ex situ* conservation strategies used for animal species, and Table 13.4-6 provides the same for plant species, with some species examples provided for each strategy. For plants, botanical gardens and seed banks are the traditional forms of off-site conservation, and they maintain the bulk of the collections. Gene bank standards for conserving orthodox seeds have been established (FAO and IPGRI 1994): however, for recalcitrant species (those having seeds that do not tolerate drying or storage at low temperatures), live collections in field gene banks are one alternative. For

animals, the maintenance of live collections of breeding stock (or breeding nuclei) has been the traditional strategy.

For animals, it is estimated that a breeding population of approximately 250 individuals is necessary to maintain 95% of the genetic diversity produced through 50 generations (Dresser 1988). Similar figures can be found for plants (Marshall and Brown 1975). The limitations of conserving such large populations *ex situ* have been emphasized repeatedly. These limitations include the costs of establishing and maintaining the *ex situ* facilities, and damage by pests, diseases and natural and human-made catastrophes (Plucknett *et al.* 1987).

More sophisticated techniques have been developed during the past 30 years. Biotechnology has provided many new conservation tools and *in vitro* culture for both plant and animal species is rapidly becoming one of the more attractive alternatives. As knowledge of the physiology and genetics of various organisms increases, it is likely to be possible to extend the application of biotechnology to the conservation of a wide range of plant and animal species. Currently, limitations include the difficulty of producing whole new individuals from tissues and cells, and the possible incidence of somaclonal variation (i.e. spontaneous mutations of cells growing in tissue culture without any sexual process involved). The start-up cost may be relatively high for *in vitro* conservation (Plucknett *et al.* 1987; Lleras 1991), but continuing costs can be competitive with alternative methods such as field gene banks. Technology transfer and adaptive research will be needed to make *in vitro* conservation more accessible and applicable. These problems are gradually being solved through intensive scientific efforts.

Cryopreservation in liquid nitrogen at -196°C is also a promising alternative for both plant and animal species, although it is now largely experimental. The major advantages of cryopreservation over conventional techniques are an absence of complicated temperature and humidity controls, freedom from pest and pathogen damage, and indefinite viability with no genetic damage (Dresser 1988; Wang *et al.* 1993). For animal species, embryos and semen are used in cryopreservation. Seeds, embryos, or tissues may be used in plant cryopreservation. Cryopreservation may prove to be cheaper than the maintenance of growing cultures, since it will make long-term, even indefinite, conservation possible.

Another emerging and very promising technique is the conservation of isolated DNA. Among its advantages are that only minute quantities of material are necessary for conservation and the possibility of reintroducing the material into related genotypes or species. It can be used for endangered or even extinct species by taking samples of material from hair, bones, herbarium specimens or other material of the target species (Wang *et al.* 1993). However, at present this approach is even more experimental than

Table 13.4-5: Ex situ conservation strategies: animals.

Strategy	Species
Wild animals	
Short-term propagation and reintroduction	Golden lion tamarin, cheetah, wolf, red wolf, bison, Arabian oryx, onager, Andean condor, bald eagle, peregrine falcon, black-footed ferret, Hawaiian goose, Galapagos giant turtle, Galapagos land iguana
Long-term propagation	Lion-tailed macaque, Siberian tiger, Père David's deer, European bison, Przewalski horse, Edward's pheasant, Grévy's zebra, addax, Chinese alligator, Aruba rattlesnake
Reintroduction, relocation	Koala, mongoose lemur, brown lemur, several spp. of primates, common marmoset, black rhinoceros, African elephant, several deer, moose, 400 spp. of birds, many reptiles and amphibians
Fostering, cross-fostering	Peregrine falcon, bald eagle, whooping crane, masked quail, polar bear (captive), many waterfowl, pigeons, cranes, passerine birds in captivity
Artificial incubation	Gharial, Siamese crocodile, Chinese alligator, green turtle, several cranes, many birds, reptiles and fishes
Artificial rearing	Hundreds of species of vertebrates
Artificial insemination	Alligator, ocellated turkey, brown-eared pheasant, whooping crane, squirrel monkey, yellow baboon, giant panda, guanaco, Speke's gazelle, gemsbok, bighorn sheep
Cryopreservation	Semen of over 200 species, mostly untested
Embryo manipulation	Guar, bongo, eland, common zebra, Przewaski horse, cottontop marmoset, yellow baboon
Domestic animals	
Cryopreservation:	
Semen	Cattle, sheep, goats, horses, asses, camelids, rabbits, pigs
Embryos	Cattle, sheep, goats, horses, asses, camelids, rabbits
Surrogate mothers	Cattle, sheep, goats, horses, asses, camelids, rabbits
Embryo manipulation	Cattle, horses, asses, rabbits
Artificial insemination	All livestock species
Breeding nuclei	Buffalo, cattle, sheep, goats, horses, asses, pigs, camelids, poultry

Adapted from Conway (1988).

cryopreservation and should be viewed only as a future option for the conservation of genetic diversity. Indeed, conservation of DNA at low or ultra-low temperatures is now a routine process, but regeneration of whole organisms or even expression of particular genes in related genotypes/species is very difficult.

Table 13.4.7 summarizes the advantages and disadvantages of *in situ* and *ex situ* conservation strategies and technologies. Both are vital to an integrated biodiversity management programme (Figure 13.4-4).

13.4.4 Restoration and rehabilitation of species, populations and ecosystems

Widespread degradation of natural ecosystems is occurring world-wide as a result of human-induced activities such as

fragmentation, livestock grazing, logging and invasions by feral animals and plants. These factors often result directly in declines in populations, extirpation or extinction of species, and can eventually cause the disappearance of entire ecosystems. There is an increasing recognition world-wide that reintroducing endangered species and restoring and rehabilitating degraded ecosystems will play an essential part in maintaining and enhancing biodiversity (Cairns 1988, 1993; Jordan *et al.* 1988; Buckley 1989; Saunders *et al.* 1993; Olney *et al.* 1994).

13.4.4.1 Restoration of species and populations

Reintroduction of captive-bred species is often the justification for and logical end point of many *ex situ* conservation

Table 13.4-6: Ex situ conservation strategies: plants.

Strategy	Species
Domesticated plants	
Seed banks	All 'orthodox'-seeded crops and many forestry species
Field gene banks	Many 'recalcitrant'-seeded species, many clonally propagated species, some forest tree species
<i>In vitro</i> conservation (cells or tissues outside organism)	Many 'recalcitrant'-seeded crops, including some forestry species, tuber crops and many clonally propagated species
Cryopreservation	Date and African oil palms, potato, chickpea, sugar cane, pollen of many species, seed of many orthodox species
Wild plants	
Propagation and reintroduction	Several hundred species of flowering plants
Gene banks	Several thousand species of flowering plants
Botanical gardens and arboreta	As many as 80 000 species of flowering plants and ferns

Adapted from Plucknett *et al.* (1987); Wang *et al.* (1993).

efforts. Three basic approaches are used to establish new populations of plants and animals (Primack 1995):

1. **Reintroduction programmes** release captive-bred or wild-collected species into an area of their historic range where the species no longer occurs. The objective of such programmes is to create a new population in the original environment.
2. **Augmentation programmes** seek to release individuals into an existing population to increase its size and genetic diversity. This is not normally recommended by IUCN (1994c) because of the possibilities of introducing disease and reducing the genetic fitness of the existing population. It may be necessary, however, where genetic diversity has been severely eroded.
3. **Introduction programmes** establish animal or plant populations outside their historic ranges. This may be appropriate where habitat conditions in historic ranges are severely degraded and the species can no longer survive there, or when the factor causing the loss of the species is still present, making a reintroduction programme impossible. The risks of such efforts, both to the introduced animals and to other species with which they would interact, need to be studied carefully.

The restoration of species is often expensive and extremely difficult. For example, programmes run by the

US Fish and Wildlife Service to capture, raise, monitor and release California condors, peregrine falcons, and black-footed ferrets have taken years and cost millions of dollars (Primack 1993). This can lead to criticism that such efforts are too costly, or unnecessary, or unethical. Well-run, well-designed reintroduction programmes, however, are the best hope for preserving species that are critically endangered or possibly already extinct in the wild. Two factors are particularly important to the success of species restoration programmes, especially animals. First, without public support, reintroduction programmes can easily fail due to the taking of a few animals or the objections of landowners to releases (Reading and Kellert 1993). Second, animals raised in captivity may lack the social skills to interact with other members of their species. These skills may include finding food co-operatively, sensing danger, finding mating partners and raising young, and could be essential to survival in their natural environment. Development of social skills with wild animals, therefore, is often crucial to the success of species restoration efforts (Primack 1993).

While reintroduction, augmentation and introduction programmes for common game species have been widely and often successfully implemented, success with threatened species is limited. Griffith *et al.* (1989) reported that the success of programmes in establishing new populations was:

- greater for game species (86%) than for threatened species (44%);

Table 13.4-7: Advantages and disadvantages of in situ and ex situ plant conservation methods.

Conservation strategy	Advantages	Disadvantages/difficulties
<i>In situ</i> : Protected areas and managed resource areas	<ul style="list-style-type: none"> – Conserves genetic resources in their natural habitat, maintains interactions with other species and organisms; – Conservation of intraspecific variation can be combined with various degrees of conservation of interspecific variation; – Applicable to species with orthodox and recalcitrant seeds, and to vegetatively propagated species. 	<ul style="list-style-type: none"> – Space required; – Resources prone to loss by accident, pests, diseases; – A network of spatially separated conservation areas is required to capture provenance (clinal, geographical) variation of target species; – Information required on management interventions needed to meet specified conservation objectives.
<i>Ex situ</i> : Seed banks	<ul style="list-style-type: none"> – Propagules readily available for use; – Minimum work; little space required (small seeds); – Provenance (clinal, geographical), variation can be conserved provided species range adequately sampled. 	<ul style="list-style-type: none"> – Not applicable to species with recalcitrant seeds, nor to vegetatively propagated species; – Space required (large seeds); – Does not conserve associated species in the ecosystem; – Regular regeneration of seedlots poses insurmountable problems at times.
<i>Ex situ</i> : Pollen banks	<ul style="list-style-type: none"> – Minimum space required; – Applicable to species with recalcitrant and orthodox seeds; – Provenance (clinal, geographical), inter- and intraspecific variation can be conserved provided species range adequately sampled. 	<ul style="list-style-type: none"> – Only half of the genome conserved; – Tri-cellular pollen storage extremely difficult; – Needs female flowers for conventional propagation; – Propagules not readily available; – Does not conserve associated species.
<i>Ex situ</i> : Tissue culture banks	<ul style="list-style-type: none"> – Minimum space required; – Genetic erosion reduced if methods such as cryopreservation are used; – Applicable to species with recalcitrant and orthodox seeds and to vegetatively propagated species; – Provenance (clinal, geographical), inter- and intraspecific variation can be conserved provided species range adequately sampled; – Aseptic conservation (minimizes disease risk); – Time required to produce propagules for use is short. 	<ul style="list-style-type: none"> – Sampling problems (within plant and sampling of adequate number of representative plants); – Protocols are species and at times genotype-specific; – Problems of somaclonal variation and early maturation; – Does not conserve associated species.
<i>Ex situ</i> : DNA banks	<ul style="list-style-type: none"> – Minimum space required, large numbers of samples can be handled; – Applicable to species on the verge of extinction (or extinct). – Applicable to all kinds of plants. 	<ul style="list-style-type: none"> – Impossible at this time to get whole genome into another living organism/plant; – Not a practical germplasm conservation method <i>per se</i>; – Last recourse.
<i>Ex situ</i> : Seedling banks, <i>Ex situ</i> : Conservation stands	<ul style="list-style-type: none"> – Applicable to species with recalcitrant and orthodox seeds; – Provenance (clinal, geographical), inter- and intra-specific variation can be conserved provided species range adequately sampled. 	<ul style="list-style-type: none"> – Space required; – Requires spatial isolation to conserve provenance identity; – Does not conserve associated species; – Generally not a preferred alternative for species with orthodox seeds, or those without actual socioeconomic value, due to economic considerations.
Botanical gardens and arboreta	<ul style="list-style-type: none"> – Applicable to species with recalcitrant and orthodox seeds and to vegetatively propagated species; – Provenance (clinal, geographical), inter- and intraspecific variation can be conserved provided species range adequately sampled; – Useful method for unique phenotypes/genotypes (e.g. mutants, variants, sterile trees). 	<ul style="list-style-type: none"> – Space required; – Resources prone to loss by accident, pests, diseases; – Does not conserve associated species; – Not apt for the conservation of provenance (clinal, geographical) variation; – Requires a minimum number of individuals larger than needed to conserve interspecies variation which is generally the purpose of botanical gardens and arboreta.

Adapted from Wang *et al.* (1993).

Ex Situ Conservation**Field Genebanks****In Situ Conservation**

Figure 13.4-4: Integrated approaches to biodiversity conservation. (Source: WRI/IUCN/UNEP 1992.)

- greater for release in excellent quality habitat (84%) than in poor quality habitat (38%);
- greater in the core of historic ranges (78%) than at the periphery of or outside historic ranges (48%);
- greater with wild-caught animals (75%) than with captive bred animals (38%); and
- greater for herbivores (77%) than for carnivores (48%).

Beck *et al.* (1994) conducted a survey looking only at captive-bred animals released within historic ranges. Success was defined as a self-maintaining population of 500 animals. On this basis, only 16 out of 145 reintroduction projects were judged successful. They concluded that releasing large numbers of animals over many years was a key to success: a finding somewhat at

odds with Griffith *et al.* (1989), who found that success increased with the number of released animals up to 100, but an additional 100 animals released did not further enhance the probability of success. More monitoring of release programmes is needed to determine whether or not such efforts are meeting their goals.

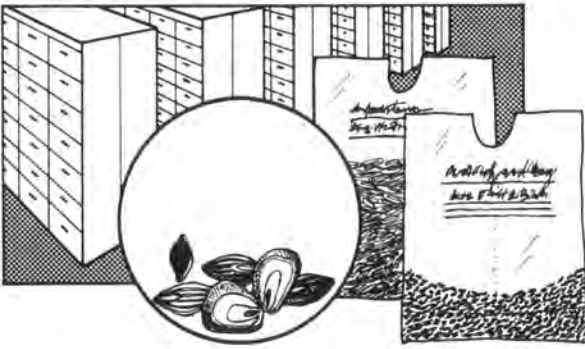
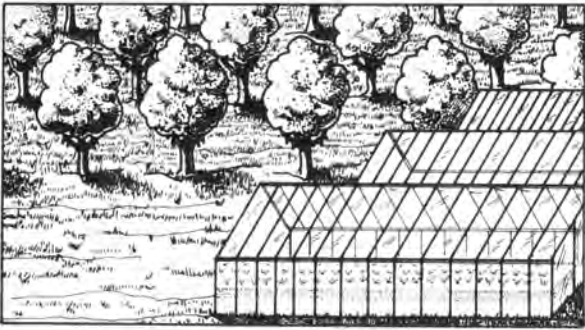
13.4.4.2 Ecosystem and landscape restoration

Restoration ecology is one of the newest and most challenging disciplines in ecology, although some ecological restoration efforts have been ongoing for decades. At the University of Wisconsin, six decades of work to restore an example of the North American tall-grass prairie – one of the most endangered major ecosystem types in the world – illustrate the complexity of this task (Jordan 1988). A variety of techniques, combined with hard work and experience, were crucial to the success of this effort.

The definitions of terms for restoration and rehabilitation vary considerably, and different terms are often used synonymously. *Rehabilitation* involves the repair – not the re-creation – of damaged ecosystems, while *restoration* usually involves the reconstruction of a natural or semi-natural ecosystem on degraded or modified land. Figure 13.4-5 illustrates the relationship between rehabilitation and restoration. Because these terms are sometimes used interchangeably, it is important to examine the context within which the words are used. Restoration and rehabilitation present unusual opportunities for cooperative and interdisciplinary efforts by a wide range of specialists from landscape ecologists and conservation biologists to environmental engineers and genetic resource specialists. This means that species reintroduction programmes and ecological restoration and rehabilitation efforts are often some of the strongest bridges between *ex situ* and *in situ* conservation programmes.

Rehabilitation of degraded ecosystems involves two major components. First, the factors leading to degradation must be treated. Second, components of the ecosystem that have disappeared have to be replaced. The first component is essential to the success of rehabilitation: any attempt to restore an ecosystem still subject to degrading influences is akin to treating symptoms rather than causes. Thus, for instance, the reintroduction of fauna to an area has to be preceded by the removal of feral predators, and the control of invasive plants has to include treatment of the factors allowing weed invasion to occur (Hobbs and Mooney 1993).

Replacement of components lost from the system may include the replacement of individual species (reintroducing species either from other nearby locations or from *ex situ* conservation facilities), or the replacement of entire communities. It may also involve the re-initiation of processes that have ceased, such as regeneration or recruitment of non-reproducing species. Common

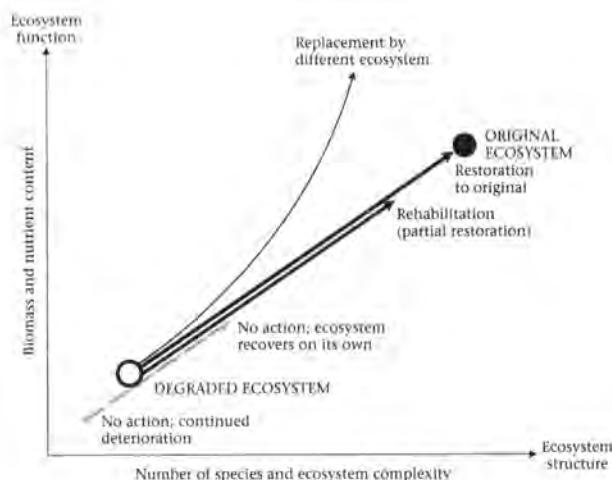

Figure 13.4-5: The goal of ecosystem restoration is to fully recover the species composition and ecological complexity of the original ecosystem. Rehabilitation seeks primarily to improve ecosystem function (e.g. biomass production and nutrient cycling), with only partial recovery of species diversity and ecological complexity. (Source: Bradshaw 1990.)

components of rehabilitation programmes include the improvement of soil structure, the control of invasive plants, and the provision of structural habitat components (e.g. Berger 1990).

Ecosystem restoration has mostly been practised on extremely degraded sites such as mine sites, spoil heaps and municipal dumps (e.g. Bradshaw and Chadwick 1980; Majer 1989; Ward *et al.* 1990). Here again, the process involves some degree of amelioration of factors preventing the re-establishment of native biota (e.g. soil chemistry or structure, microclimatic factors, etc.) and the reintroduction of a subset of the biota. Frequently, restoration involves primarily the replacement of the plant community, generally by plantings and taking care of perennial species, in the hope (or belief) that fauna will return thereafter. Increasing efforts are also being made to re-establish animal and soil communities as part of the reintroduction process.

Although the goal of restoration is usually to return an area to natural conditions, too often little thought is given to exactly what this means, or what criteria should be used to judge success. Given the dynamics and fluctuating species composition of natural ecosystems, it is probably impractical to restore all the species or ecosystem components that may have existed before the system was degraded. Nevertheless, there are a few guidelines that can be used to guide restoration practices such that resilient (self-sustaining) ecosystems of comparable biological diversity are restored. For example, where restoration simply seeks to return some sort of vegetation to a previously vegetated area, there is little evidence that the restoration of the original biological community will

succeed. Bradshaw and Chadwick (1980) demonstrate that restoring soil nutrient status is often the key to restoring the original diversity.

In extensively fragmented landscapes, ongoing losses of species and degradation of natural ecosystems indicate that the existing fragments are not sufficient to maintain biodiversity in the long term (e.g. Saunders 1989, 1990; Kattan *et al.* 1994). The only solution to this problem is the large-scale restoration of the landscape as a whole, rather than at the scale of individual fragments. This involves restoration or rehabilitation actions for most parts of the landscape, including lands used for agriculture, forestry and other purposes, and modification of production practices so that conservation issues are considered. Box 13.4-5 summarizes experience in Costa Rica restoring tropical dry forest – one of the most threatened forest ecosystems in the world.

Only basic guidelines are available to plan and implement revegetation programmes so that they benefit biodiversity (Harker *et al.* 1993; Recher 1993). To be of conservation value, revegetation needs to enhance the existing system of fragments. Revegetation could be used to provide buffer zones around remnant areas, corridors between remnants, or as additional habitat (Hobbs 1993). In other words, landscape restoration aims at improving the design of the existing system of fragments by increasing habitat area and connectivity, and by providing buffer zones around existing fragments to protect them from external influences (see 13.4.2.2).

The aim is to produce a landscape with elements of the remaining natural ecosystems interspersed with restored ecosystems that fulfil some conservation objectives, and production systems that are sustainable and do not compromise the long-term persistence of the conservation areas (Lefroy *et al.* 1993; Main 1993). Landscape restoration thus has to consider the many characteristics of natural landscapes that may have conservation significance, including patchiness, connectivity and heterogeneity (Lambeck and Saunders 1993; Wiens *et al.* 1993).

The field of restoration ecology is in its infancy, although it has grown rapidly, with professional journals and a growing number of edited books on the subject. In view of our modest present capacity to predict ecosystem development following remedial measures, Cairns (1988) suggests that arresting and repairing widespread environmental damage may be less arrogant than presuming restoration and rehabilitation can effectively increase diversity. Clearer enunciation of the goals, techniques and theoretical framework of restoration ecology (Harker *et al.* 1993; Recher 1993) will lead to its inclusion as a major tool in biodiversity conservation.

13.4.5 Conclusion

Hand-in-hand with measures to use biodiversity sustainably are measures to protect ecosystems, species and genetic

Box 13.4-5: Restoration of a tropical dry forest in Costa Rica.

Dry tropical forests once occupied more than half of the forested terrestrial tropics (Murphy and Lugo 1986; Janzen 1988a). Today, in Central America they have been reduced to a few tattered remnants. Grazing, cultivation, fires and logging have converted these forests into pastures, fields and various kinds of highly altered successional vegetation. Ecological restoration is one of the few strategies left by which to maintain the biodiversity associated with this highly threatened forest type (Uhl 1987; Janzen 1988b; Nepstad *et al.* 1991; Brown and Lugo 1994).

To reverse the process of degradation, a small group of ecologists, local people and personnel from Costa Rica's National Park Service have begun an ambitious long-term project to fully restore the biodiversity of the 75 000 hectare Guanacaste National Park in northwestern Costa Rica (Janzen 1987; Allen 1988). This ecosystem, together with its adjacent cloud forest and rain forest where many dry forest organisms pass the dry season (which comprises the 110 000 ha, Guanacaste Conservation Area), contains about 60% of Costa Rica's biodiversity in only 2% of its national territory.

Restoration work began in 1985. After four centuries of European-style ranching, logging and hunting, the dry forest ecosystem still had virtually all of its several thousand native species. Poor soils, little rainfall, an absence of year-round water, and remoteness from political and economic centres had protected the area from the heavy exploitation that eliminated most other areas of tropical dry forest in the region.

Led by Dan Janzen, an ecologist with 20 years of research experience in the area, a foundation was established to assemble the Guanacaste Conservation Area (GCA) from a mosaic of semi-abandoned ranches, failed colonization schemes, diverted waterways, access roads, extensively grazed pastures, patches of secondary forest, and a small national park (Santa Rosa National Park). With support from more than 4000 individuals and institutions, the foundation established an endowment to support the management of the GCA and its restoration activities (Janzen 1988a).

The most important restoration activity is removing factors that cause ecological degradation or severe species decline. Eliminating these factors, such as fire (natural fires were extremely rare), poaching of animals and trees, intensive grazing, stream diversions and crop cultivation, will take centuries.

Eliminating fire as a degradation factor is perhaps the most challenging task. Using firebreaks, lookout posts, and engaging neighbours in the management of small brush and litter fires are part of the fire management strategy. Hunting is being controlled to rebuild populations of seed-dispersing birds and animals. Native trees are being planted and cattle grazing reduced to levels needed to control exotic grasses. Within the next 100 to 300 years, the goal is to eliminate introduced species and re-establish a forest ecosystem.

One innovative and critical part of this restoration effort is the active involvement of local people in many aspects of park management and restoration activities. Many of the farmers and ranchers living within the GCA have been given opportunities to be trained as park employees and use their skills and knowledge to help develop the park. Some are now being trained as park managers and biologists (Primack 1993).

The restoration of the area is a social and cultural enterprise as much as it is a biological one. 'Biocultural restoration', or the use of the GCA to teach the 40 000 local residents about natural history, and the principles of ecology and conservation, is a key element of the programme. Educational and research programmes have been designed and implemented in grade schools, secondary schools and universities. Janzen (1986) believes the long-term success of the effort depends on having residents become local and national advocates for the conservation of natural resources.

Already, results of the restoration efforts at GCA are noticeable. For example, with the cessation of fire, the approximately 30 000 ha of abandoned pastures are filling rapidly with wind-dispersed native plant species (Janzen 1990). Large grass stands are sprinkled with young shrubs and saplings projecting above the 1–2 m tall grass after five years of fire protection. Ancient pasture soils have regained a thick litter and high organic content in less than 10 years from the beginning of the reforestation process. Ecotourism and research interest in the GCA have developed rapidly, providing new opportunities for local employment and funding to meet the US\$1.2 million annual operating budget. The GCA, which is managed by a parastatal organization governed by a local board, employs a staff of 95, all of whom are Costa Ricans. The GCA demonstrates that restoration, thanks in large part to the vision, energy and common sense of a small group, can be a very good investment in the sustainable use and conservation of biodiversity.

diversity – either in place (*in situ* measures can be used at all biological levels) or in specially designed facilities outside natural habitats (*ex situ* measures can be used for species and genetic diversity). These measures are, in essence, means by which we can protect biodiversity against the failure of the sustainable use measures described in 13.3.

The most effective mechanism for conserving biodiversity, by almost any reckoning, is to prevent the conversion or degradation of habitat. The world's 10 000 protected areas have figured prominently in biodiversity conservation efforts around the world. Reasonably accurate data on the number and area coverage of protected areas are available for most countries, and gaps in the representation of major ecosystem types by country and biome are generally well understood. More specific information, however, on the effectiveness of protected areas in conserving elements of biodiversity is generally not available. For example, information on the biodiversity resident within protected areas, especially at the genetic level but even for plants and vertebrates, is inadequate for the vast majority of protected areas.

Protected areas around the world face a number of serious obstacles. First, protected areas, particularly in developing countries, have often yielded few economic benefits and have imposed substantial costs on local people leading to severe conflicts between conservation and economic development goals. Second, a lack of trained personnel, investment and scientific research together with the overlooked potential of protected areas as genetic resource reserves, providers of irreplaceable ecosystem services, and earners of tourism dollars, have limited the value and role that such areas can play in society. Third, while a few of the world's terrestrial biogeographic regions have approximately 10% of their area covered – a broad target established by the World Conservation Union (IUCN) – most biogeographic regions, especially marine regions, are poorly represented in the world's network of protected areas.

Protected areas – due to constraints on size, representativeness and management effectiveness – must be augmented by protective measures elsewhere. Fragmentation of natural ecosystems is generally seen as one of the most important threats to biodiversity worldwide. Protecting individual habitat fragments and natural habitat corridors within a matrix of more intensive human uses of the landscape is likely to be an important factor in the persistence of native biodiversity in many areas.

A wide array of techniques to conserve individual species, populations and genes must complement conservation at the landscape and ecosystem levels. These include both *in situ* (or on-site) measures targeted at individual species or sites of important genetic diversity and a growing range of *ex situ* (or off-site) methods.

Effective *in situ* approaches for the conservation of

targeted species include legal protection of endangered species; the preparation and implementation of management or recovery plans; and the establishment of protected areas specifically to protect the species or to protect unique genetic resources such as particularly important forest genetic resources. *In situ* management, however, faces two major limitations: (1) a lack of information on the conservation status and habitat needs of individual species, and (2) the considerable economic or opportunity costs of conserving individual species or populations.

A growing range of *ex situ* technologies associated with gene banks, zoos, botanical gardens and aquaria have rapidly expanded our capacity to preserve species and genetic diversity. None of the *ex situ* technologies – arboreta, aquaria, botanical gardens, seed banks, captive breeding units, clonal collections, microbial culture collections, field gene banks, forest nurseries, propagation units, tissue and cell cultures, zoological gardens, and museums holding seed banks or genetic material – are fail-proof. Depending on the technology used, they are vulnerable to pests and disease, physical damage to facilities from natural causes (e.g. fires, floods, storms, etc.) and human events (e.g. war, economic decline, policy change, etc.).

One way to compensate for the limitations of *ex situ* conservation measures is to deploy measures to restore and rehabilitate natural populations and ecosystems. A growing knowledge and capacity exists, that should make possible the reintroduction of certain species lost from ecosystems, restoration of certain ecological functions, and sometimes even the transformation of altered communities back to assemblages similar to their native state. *Rehabilitation*, which aims to revive important ecosystem services on degraded lands, has become an increasingly important element of resource conservation throughout the world. More ambitiously, *restoration* attempts to bring lands modified by human use or natural catastrophe back to their natural state. Because determining the 'pre-disturbance' state of most ecosystems is difficult and because ecosystems continually change, complete restoration is rarely a realistic goal.

Since rehabilitation and restoration techniques are still relatively new, considerable research is needed for most ecosystems, and it is rare that an ecosystem can be fully restored. Nevertheless, restoration and rehabilitation of ecosystems will come to play an increasingly critical role in coming decades as techniques for solving the problems caused by the current mis-management of biodiversity.

References

- Allen, W.H. 1988. Biocultural restoration of a tropical forest. *BioScience* 38: 156–161.

- Altieri, M.A.** and Merrick, L. 1987. *In-situ* conservation of crop genetic resources through maintenance of traditional farming systems. *Economic Botany* **41**: 86–96.
- Arnold, G.W., Steven, D.E., Weeldenburg, J.R.** and Smith, E.A. 1993. Influences of remnant size, spacing pattern and connectivity on population boundaries and demography in euros *Macropus robustus* living in a fragmented landscape. *Biological Conservation* **64**: 219–230.
- Ashton, P.S.** 1987. Biological considerations in *in-situ* versus *ex-situ* plant conservation. In: Bramwell, D., Hamann, O., Heywood, V.H. and Syngé, H. (eds), *Botanic Gardens and the World Conservation Strategy*. 117–130. Academic Press, London.
- Astley, D.** 1991. Exploration: methods and problems of exploration and field collecting. In: Hawkes, J.G. (ed.), *Genetic Conservation of World Crop Plants*. 11–22. Academic Press, Harcourt, Brace and Javanovitch Publishers, London.
- Baker, W.L.** 1992. The landscape ecology of large disturbances in the design and management of nature reserves. *Landscape Ecology* **7**: 181–194.
- Balée, W.** 1989. *Cultura na Vegetação da Amazônia Brasileira*. Coleção Eduardo Galvão, Museu Paraense Emílio Goeldi, Belém.
- Beck, B.B., Rapaport, L.G., Stanley Price, M.R.** and Wilson, A.C. 1994. Reintroduction of captive-born animals. In: Olney, P., Mace, G.M. and Feistner, A.C.T. (eds), *Creative Conservation: Interactive management of wild and captive animals*. 265–286. Chapman and Hall, London.
- Berger, J.J.** (ed.) 1990. *Environmental Restoration. Science and strategies for restoring the Earth*. Island Press, Washington, DC.
- Bierregaard, R.O.J., Lovejoy, T.E., Kapos, V., dos Santos, A.A.** and Hutchings, R.W. 1992. The biological dynamics of tropical rainforest fragments. *BioScience* **42**: 859–866.
- Bourdages, J.-L., Domon, G., Drapeau, P.** and Bouchard, A. 1992. Land-use planning of protected areas: an approach based on ecological value. In: Willison, J.H.M., Bondrup-Nielsen, S., Drysdale, C., Herman, T.B., Munro, N.W.P. and Pollock, T.L. (eds), *Science and the Management of Protected Areas. Proceedings of an international conference held at Acadia University, Nova Scotia, Canada, 14–19 May, 1991*. 96–212. Elsevier Science Publishing, New York.
- Bradshaw, A.D.** 1990. The reclamation of derelict land and the ecology of ecosystems. In: Jordan, W.R. III, Gilpin, E. and Aber, J.D. (eds), *Restoration Ecology: A synthetic approach to ecological research*. 53–74. Cambridge University Press, Cambridge.
- Bradshaw, A.D.** and Chadwick, M.J. 1980. *The Restoration of Land: The ecology and reclamation of derelict and degraded land*. Blackwell Scientific Publications, Oxford.
- Brittingham, M.** and Temple, S. 1983. Have cowbirds caused forest songbirds to decline? *BioScience* **33**: 31–35.
- Brothers, T.S.** and Spingarn, A. 1992. Forest fragmentation and alien plant invasion of central Indiana old-growth forests. *Conservation Biology* **6**: 91–100.
- Brown, S.** and Lugo, A.E. 1994. Rehabilitation of tropical lands: a key to sustaining development. *Restoration Ecology* **2**: 97–111.
- BSP/CI/TNC/WCS/WRI/WWF.** 1995. *A Regional Analysis of Geographic Priorities for Biodiversity Conservation in Latin America and the Caribbean*. Biodiversity Support Program, Washington, DC.
- Buckley, G.P.** 1989. *Biological Habitat Reconstruction*. Bellhaven Press, London.
- Cairns, J.J.** 1988. Increasing diversity by restoring damaged ecosystems. In: Wilson, E.O. and Peter, F.M. (eds), *Biodiversity*. 333–343. National Academy Press, Washington, DC.
- Cairns, J.J.** 1993. Ecological restoration: replenishing our national and global ecological capital. In: Saunders, D.A., Hobbs, R.J. and Ehrlich, P.R. (eds), *Nature Conservation 3: Reconstruction of Fragmented Ecosystems, Global and Regional Perspectives*. 193–208. Surrey Beatty and Sons, Chipping Norton, NSW.
- Cale, P.** and Hobbs, R.J. 1991. Condition of roadside vegetation in relation to nutrient status. In: Saunders, D.A. and Hobbs, R.J. (eds), *Nature Conservation 2: The Role of Corridors*. 363–362. Surrey Beatty and Sons, Chipping Norton, NSW.
- Caughley, G.** 1994. Directions in conservation biology. *Journal of Animal Ecology* **63**: 215–244.
- Conway, W.** 1988. Can technology aid species preservation? In: Wilson, E.O. (ed.), *Biodiversity*. 263–268. National Academy Press, Washington, DC.
- Cumming, D.H., DuToit, R.F.** and Stuart, S.N. 1990. *African Elephants and Rhinos: Status survey and conservation action plan*. IUCN Species Survival Commission African Elephant and Rhino Specialist Group. IUCN, Gland.
- Dahl, A.L.** 1986. *Review of the Protected Areas System in Oceania*. IUCN/UNEP, Gland.
- Dawson, D.** 1994. *Are Habitat Corridors Conduits for Animals and Plants in a Fragmented Landscape? A review of the scientific evidence*. English Nature Research Report 94. English Nature, Peterborough, UK.
- Denevan, W.M.** and Zucchi, E.A. 1978. Ridged field excavations in the central Orinoco Llanos, Venezuela. In: Browman, D.L. (ed.), *Advances in Andean Archeology*. 69–81. Mouton, The Hague.
- Diamond, J.M.** 1975. The island dilemma: lessons of modern biogeographic studies for the design of nature reserves. *Biological Conservation* **7**: 129–146.
- Dirzo, R.** 1992. Rates of deforestation in Los Tuxtlas, a neotropical area in southeast Mexico. *Conservation Biology* **6**: 84–90.
- Dirzo, R.** and Miranda, A. 1990. Contemporary neotropical defaunation and forest structure, function and diversity – a sequel to John Terborgh. *Conservation Biology* **4**: 444–447.
- Dresser, B.L.** 1988. Cryobiology, embryo transfer, and artificial insemination in ex situ animal conservation programs. In: Wilson, E.O. (ed.), *Biodiversity*. 296–310. National Academy Press, Washington, DC.
- Esquinas-Alcazar, J.** 1993. Tenth anniversary of the FAO Commission on Plant Genetic Resources: a time for taking stock and looking to challenges of the 21st century. *Diversity* **9**: 14–16.
- Falk, D.A.** 1992. From conservation biology to conservation practice: strategies for protecting plant diversity. In: Fiedler, P.L. and Jain, S.K. (eds), *Conservation Biology: The theory and practice of nature conservation, preservation, and management*. 397–432. Chapman and Hall, New York.

- FAO. 1989. Review of forest management systems in tropical Asia. FAO Forestry Paper 89, UN Food and Agriculture Organization, Rome.
- FAO/IUCN. 1985. *Status of in-situ conservation of plant genetic resources*. Commission on Plant Genetic Resources. First Session. CPGR/85/5. FAO, Rome.
- FAO and IPGRI. 1994. *Genebank Standards*. FAO and International Plant Genetic Resources Institute, Rome.
- Fearnside, P.M. 1989. Extractive reserves in Brazilian Amazonia. An opportunity to maintain tropical rain forest under sustainable use. *BioScience* **39** (6): 387–394.
- Frankel, O.H. 1983. The place of management in conservation. In: Schonewald-Cox, C., Chambers, S.M., MacBryde, B. and Thomas, L. (eds), *Genetics and Conservation*. 1–14. Benjamin Cummings, Menlo Park, Calif.
- Frankel, O.H. and Soulé, M.E. 1981. *Conservation and Evolution*. Cambridge University Press, Cambridge.
- Frankel, O.H. and Brown, A.H.D. 1984. Current plant genetic resources – a critical appraisal. In: *Genetics: New frontiers*. IBH Publishing, Oxford.
- Friend, J.A. 1990. The numbat *Myrmecobius fasciatus* (Myrmecobiidae): history of decline and potential for recovery. *Proceedings of the Ecological Society of Australia* **16**: 369–377.
- Froend, R.H., Heddle, E.M., Bell, D.T. and McComb, A.J. 1987. Effects of salinity and waterlogging on the vegetation of Lake Toolibin, Western Australia. *Australian Journal of Ecology* **12**: 281–298.
- Froend, R.H. and McComb, A.J. 1991. An account of the decline of Lake Towerrinning, a wheatbelt wetland. *Journal of the Royal Society of Western Australia* **73**: 123–128.
- Gámez, R., Piva, A., Sittenfeld, A., León, E., Jiménez, J. and Mirabell, G. 1993. Costa Rica's conservation program and National Biodiversity Institute. In: Reid, W.V., Laird, S.A., Meyer, C.A., Gámez, R., Sittenfeld, A., Janzen, D., Gollin, M.A. and Juma, C. (eds), *Biodiversity Prospecting: Using genetic resources for sustainable development*. 53–68. World Resources Institute, Washington, DC.
- George, R.J., McFarlane, D.J. and Speed, R.J. 1995. The consequences of a changing hydrologic environment for native vegetation in south Western Australia. In: Saunders, D.A., Craig, J. and Mattiske, L. (eds), *Nature Conservation 4: The Role of Networks*. Surrey Beatty and Sons, Chipping Norton, NSW.
- Ghosh, A.K. 1993. Urban Sanctuaries. *Environment*. **1** (1): 1–2.
- Given, D. 1990. Conserving botanical diversity on a global scale. *Annals of the Missouri Botanical Garden* **77**: 48–62.
- Gobierno de Costa Rica. 1990. *Estrategia para el Desarrollo Institucional de la Reserva de la Biosfera 'La Amistad'*. Gobierno de Costa Rica.
- Gómez-Pompa, A. 1990. Maya sustainability. *Biotropica* (Tropinet supplement) **25**: 1–2.
- Gómez-Pompa, A. and Kaus, A. 1992. Taming the wilderness myth. *BioScience* **42**: 271–279.
- Green, R.E. and Robins, M. 1993. The decline of the ornithological importance of the Somerset levels and moors, England and changes in the management of water levels. *Biological Conservation* **66**: 95–106.
- Griffith, B., Scott, J.M., Carpenter, W. and Reed, C. 1989. Translocation as a species conservation tool: status and strategy. *Science* **245**: 477–480.
- Hamilton, M.B. 1994. *Ex-situ* conservation of wild plant species: time to reassess the genetic assumptions and implications of seed banks. *Conservation Biology* **8**: 39–49.
- Harding, M. 1993. Redgrave and Lopham Fens, East Anglia, England: A case study of change in flora and fauna due to groundwater abstraction. *Biological Conservation* **66**: 35–45.
- Harker, D., Evans, S., Evans, M. and Harker, K. 1993. *Landscape Restoration Handbook*. Lewis Publishers, Boca Raton, Fla.
- Harris, L.D. and Scheck, J. 1991. From implications to application: the dispersal corridor principle applied to conservation of biological diversity. In: Saunders, D.A. and Hobbs, R.J. (eds), *Nature Conservation 2: The role of corridors*. 189–220. Surrey Beatty and Sons, Chipping Norton, NSW.
- Hawkes, J.G. 1969. The ecological background of plant domestication. In: Ucko, P.J. and Dimbleby, G.W. (eds), *The Domestication and Exploitation of Plants and Animals*. 17–29. Duckworth & Co., London.
- Hecht, S. and Cockburn, A. 1989. *The Fate of the Forest*. Chapman and Hall, New York.
- Hess, G.R. 1994. Conservation corridors and contagious disease: a cautionary note. *Conservation Biology* **8**: 256–262.
- Hester, A.J. and Hobbs, R.J. 1992. Influence of fire and soil nutrients on native and non-native annuals at remnant vegetation edges in the Western Australian wheatbelt. *Journal of Vegetation Science* **3**: 101–108.
- Heywood, V.H. 1992a. Botanic gardens and the conservation of biodiversity. *Museologia Scientifica* **9**: 21–32.
- Heywood, V.H. 1992b. Efforts to conserve tropical plants – a global perspective. In: Adams, R.P. and Adams, J.E. (eds), *Conservation of Plant Genes*. 1–14. Academic Press, San Diego.
- Heywood, V.H. 1993. Broadening the basis of plant resource conservation. In: Gustafson, J.P., Appels, R. and Raven, P. (eds), *Gene Conservation and Exploitation*. 1–15. Plenum Press, New York.
- Heywood, C. and Heywood, V.H. 1991. *International Directory of Botanical Gardens*, V. Koeltz Scientific Books, Koenigstein, Germany.
- Hobbs, R.J. 1987. Disturbance regimes in remnants of natural vegetation. In: Saunders, D.A., Arnold, G.W., Burbridge, A.A. and Hopkins, A.J.M. (eds), *Nature Conservation: The role of remnants of native vegetation*. 233–240 Surrey Beatty and Sons, Chipping Norton, NSW.
- Hobbs, R.J. 1992. Corridors for conservation: solution or bandwagon? *Trends in Ecology and Evolution* **7**: 389–392.
- Hobbs, R.J. 1993. Can revegetation assist in the conservation of biodiversity in agricultural areas? *Pacific Conservation Biology* **1**: 29–38.
- Hobbs, R.J. and Atkins, L. 1991. Interactions between annuals and woody perennials in a Western Australian wheatbelt reserve. *Journal of Vegetation Science* **2**: 643–654.
- Hobbs, R.J. and Mooney, H.A. 1993. Restoration ecology and invasions. In: Saunders, D.A., Hobbs, R.J. and Ehrlich, P.R. (eds), *Nature Conservation 3: Reconstruction of Fragmented Ecosystems, Global and Regional Perspectives*. 127–133 Surrey Beatty and Sons, Chipping Norton, Australia.

- Hobbs, R.J.** and Saunders, D.A. 1991. Reintegrating fragmented landscapes: a proposed framework for the Western Australian wheatbelt. *Australian Journal of Soil Conservation Proceedings* **5**: 36–49.
- Hobbs, R.J.,** Saunders, D.A. and Arnold, G.W. 1993. Integrated landscape ecology: a Western Australian perspective. *Biological Conservation* **64**: 231–238.
- Hobbs, R.J.,** Saunders, D.A., Lobry de Bruyn, L.A. and Main, A.R. 1993. Changes in biota. In: Hobbs, R.J. and Saunders, D.A. (eds), *Reintegrating Fragmented Landscapes. Towards sustainable production and nature conservation*. 65–106. Springer-Verlag, New York.
- Hodgkin, T.,** Brown, A.O.D., van Hintum, J.L. and Morales, E.A.V. (eds) 1995. *Core Collections of Plant Genetic Resources*. John Wiley, Chichester, UK.
- Holloway, M.** 1994. Nurturing nature: trends in biological restoration. *Scientific American* **270**: 98–108.
- Hoyt, E.** 1988. *Conserving the Wild Relatives of Crop Plants*. IBPGR/IUCN/WWF, Rome.
- Inglis, I.R.,** Wright, E. and Lill, J. 1994. The impact of hedges and farm woodlands on woodpigeon (*Columba palumbus*) nest densities. *Agriculture, Ecosystems and Environment* **48**: 257–262.
- IPGRI.** 1995. *Plant Genetic Resource Collections Database*. International Plant Genetic Resources Institute, Rome.
- IUCN.** 1990. *IUCN Red List of Threatened Animals*. IUCN, Gland.
- IUCN.** 1992. *Protected Areas of the World: A review of national systems*, 4 Volumes. World Conservation Monitoring Centre, Cambridge and IUCN Commission on National Parks and Protected Areas. IUCN, Gland.
- IUCN.** 1993a. *Draft IUCN Red List Categories*. IUCN, Gland.
- IUCN.** 1993b. *Global Zoo Directory 1993*. IUCN Species Survival Commission Captive Breeding Specialist Group. IUCN, Gland.
- IUCN.** 1994a. *United Nations List of National Parks and Protected Areas*. World Conservation Monitoring Centre, Cambridge and IUCN Commission on National Parks and Protected Areas. IUCN, Gland.
- IUCN.** 1994b. *Guidelines for Protected Area Management Categories*. World Conservation Monitoring Centre, Cambridge and IUCN Commission on National Parks and Protected Areas. IUCN, Gland.
- IUCN.** 1994c. *Guidelines for Reintroductions*. IUCN Species Survival Commission Reintroduction Specialist Group. IUCN, Gland.
- IUCN.** 1994d. *IUCN Red List Categories*. IUCN, Gland.
- Janzen, D.H.** 1986. Mice, big mammals, and seeds: it matters who defecates what where. In: Estrada, A. and Fleming, T.H. (eds), *Frugivores and Seed Dispersal*. 251–271. W. Junk Publishers, Dordrecht.
- Janzen, D.H.** 1987. How to grow a tropical national park: basic philosophy for Guanacaste National Park, northwestern Costa Rica. *Experientia* **43**: 1037–1038.
- Janzen, D.H.** 1988a. Management of habitat fragments in a tropical dry forest: growth. *Annals of the Missouri Botanical Garden* **75**: 105–116.
- Janzen, D.H.** 1988b. Tropical dry forests: the most endangered major tropical ecosystem. In: Wilson, E.O. (ed.), *Biodiversity*. 130–137. National Academy Press, Washington, D.C.
- Janzen, D.H.** 1990. An abandoned field is not a tree fall gap. *Vida Silvestre Neotropical* **2**: 64–67.
- Johnson, N.C.** 1995. *Biodiversity in the Balance: Approaches to setting geographic conservation priorities*. Biodiversity Support Program, Washington, DC.
- Jones, M.** 1994. Letter from U.S. Department of Interior Fish and Wildlife Service, Office of Management Authority to all CITES Management Authorities (i.e. contracting parties). 14 October 1994. US Department of Interior Fish and Wildlife Service, Washington, DC.
- Jordan, W. R., III.** 1988. Ecological restoration: reflection on a half-century of experience at the University of Wisconsin, Madison Arboretum. In: Wilson, E.O. (ed.), *Biodiversity*. 311–316. National Academy Press, Washington, DC.
- Jordan, W.R.I.,** Peters, R.L.I. and Allen, E.B. 1988. Ecological restoration as a strategy for conserving biodiversity. *Environmental Management* **12**: 55–72.
- Kapos, V.** 1989. Effects of isolation on the water status of forest patches in the Brazilian Amazon. *Journal of Tropical Ecology* **5**: 173–185.
- Kattan, G.H.,** Alvarez-López, H. and Giraldo, M. 1994. Forest fragmentation and bird extinctions: San Antonio eighty years later. *Conservation Biology* **8**: 138–146.
- Kemp, R.H.,** Namkoong, G. and Wadsworth, F.H. 1993. *Conservation of Genetic Resources in Tropical Forest Management*. FAO Forestry Paper 107. UN Food and Agriculture Organization, Rome.
- Kinnear, J.E.,** Onus, M.L. and Bromilow, R.N. 1988. Fox control and rock wallaby population dynamics. *Australian Wildlife Research* **15**: 435–450.
- Kothari, A.,** Pande, P., Singh, S. and Variava, D. 1989. *Management of National Parks and Sanctuaries in India: A Status Report*. Indian Institute of Public Administration, New Delhi.
- Kraus, S.** and Brown, M. 1992. A right whale conservation plan for waters of Atlantic Canada. In: Willison, J.H.M., Bondrup-Nielsen, S., Drysdale, C., Herman, T.B., Munro, N.W.P. and Pollock, T.L. (eds), *Science and the Management of Protected Areas*, 98–116. Elsevier Science Publishing, Amsterdam.
- Lal, R.,** Kothari, A., Pande, P. and Singh, S. 1994. *Directory of National Parks and Sanctuaries in Karnataka: Management status and profiles*. Indian Institute of Public Administration, New Delhi.
- Lambeck, R.J.** and Saunders, D.A. 1993. The role of patchiness in reconstructed wheatbelt landscapes. In: Saunders, D.A., Hobbs, R.J. and Ehrlich, P.R. (eds), *Nature Conservation 3: Reconstruction of fragmented ecosystems, global and regional perspectives*. 153–161. Surrey Beatty and Sons, Chipping Norton, NSW.
- Lathrap, D.** 1970. *The Upper Amazon*. Thames and Hudson Limited, London.
- Laurance, W.F.** 1994. Rainforest fragmentation and the structure of small mammal communities in tropical Queensland. *Biological Conservation* **69**: 23–32.
- Laurance, W.F.,** Garesche, J. and Payne, C.W. 1993. Avian nest predation in modified and natural habitats in tropical Queensland: an experimental study. *Australian Wildlife Research* **20**: 711–723.
- Leader-Williams, N.** 1990. Black rhinos and African elephants: Lessons for conservation funding. *Oryx* **24**: 23–29.

- Lefroy, E.C., Hobbs, R.J. and Scheltema, M. 1993. Reconciling agriculture and nature conservation: toward a restoration strategy for the Western Australian wheatbelt. In: Saunders, D.A., Hobbs, R.J. and Ehrlich, P.R. (eds), *Nature Conservation 3: Reconstruction of fragmented ecosystems, global and regional perspectives*. 243–272. Surrey Beatty and Sons, Chipping Norton, NSW.
- Lleras, E. 1991. Conservación de recursos genéticos *in-situ*. *Diversity* 7: 78–81.
- Lleras, E. 1992. Uso tradicional da biota, manejo e domesticação de recursos genéticos. *Anais Seminário Internacional sobre Meio Ambiente, Pobreza e Desenvolvimento da Amazônia, Belém, 16–19 fevereiro de 1992*. 126–132. PRODEPA, Belém, Brazil.
- Lleras, E. 1994. Amazonia: mitos y realidades para un desarrollo sostenible. *Colombia Amazonica*.
- Lleras, E. and Coradin, L. 1986. Domesticación, agricultura y recursos genéticos: pasado, presente y futuro. *Anais 1º. Simpósio do Trópico Úmido, Belém, 12–17 de novembro de 1984*. EMBRAPA/CPATU Documentos 36. 165–176. EMBRAPA, Brasília.
- Lleras, E., Cunha, R., Imaculada, I.R. and Guedes, A.C. 1994. *Metodos y estratégias para conservação integrada de recursos genéticos*. EMBRAPA, Brasília.
- Lleras, E., Leite, A.M.C., Scariot, A.S. and de Sá Brandão, J.E. 1992. *Definição de áreas de alta diversidade vegetal e endemismos na Amazônia Brasileira*. Final Report to FAO, Brasília.
- Loftus, R. and Scherf, B. 1993. *World Watch List for Domestic Animal Diversity*. UN Food and Agriculture Organization, Rome.
- Ludwig, D., Hilborn, R. and Walters, C. 1993. Uncertainty, resource exploitation, and conservation: lessons from history. *Science* 260: 17–36.
- Lugo, A. E. 1988. Estimating reductions in the diversity of tropical forest species. In: Wilson, E.O. (ed.), *Biodiversity*. 58–70. National Academy Press, Washington, DC.
- Lynch, J.F., Carmen, W.F., Saunders, D.A. and Cale, P. 1995. Short-term use of vegetated road verges and habitat patches by four bird species in the central wheatbelt of Western Australia. In: Saunders, D.A., Craig, J. and Mattiske, L. (eds), *Nature Conservation 4: The role of networks*. 61–76. Surrey Beatty and Sons, Chipping Norton, NSW.
- Mace, G.M., Collar, N., Cooke, J., Galston, K., Ginsberg, J., Leader Williams, N., Maunder, M. and Milner-Gulland, E.J. 1992. The development of new criteria for listing species on the IUCN Red List. *Species* 19: 16–22.
- Mace, G.M. and Lande, R. 1991. Assessing extinction threats: toward a re-evaluation of IUCN threatened species categories. *Conservation Biology* 5: 148–157.
- Mace, G.M. and Stuart, S. 1994. Draft IUCN Red List categories, Version 2.2. *Species* 21/22: 13–24.
- McFarlane, D.J., George, R.J. and Farrington, P. 1993. Changes in the hydrologic cycle. In: Hobbs, R.J. and Saunders, D.A. (eds), *Reintegrating Fragmented Landscapes. Towards sustainable production and nature conservation*. 146–186. Springer-Verlag, New York.
- McFarlane, D.J., Howell, M.R., Ryder, A.T. and Orr, G.J. 1992. The effect of agricultural development on the physical and hydraulic properties of four Western Australian soils. *Australian Journal of Soil Research* 30: 517–532.
- MacKinnon, J. and MacKinnon, K. 1986a. *Review of the Protected Areas System in the Indo-Malayan Realm*. IUCN/UNEP, Gland.
- MacKinnon, J. and MacKinnon, K. 1986b. *Review of the Protected Areas System in the Afro-tropical Realm*. IUCN/UNEP, Gland.
- MacKinnon, K. and MacKinnon, J. 1991. Habitat protection and re-introduction programmes. *Zoological Society of London Symposium Proceedings* 62: 173–198.
- McLean, H.E. 1995. Fighting fire with fire. *American Forests* 101: 13–16.
- McNeely, J.A., Harrison, J. and Dingwall, P. (eds) 1994. *Protecting Nature: Regional reviews of protected areas*. IUCN, Gland.
- Main, A.R. 1993. Landscape reintegration: Problem definition. In: Hobbs, R.J. and Saunders, D.A. (eds), *Reintegrating Fragmented Landscapes: Towards sustainable production and nature conservation*. 189–208. Springer-Verlag, New York.
- Majer, J.D. 1989. *Animals in Primary Succession: The role of fauna in reclaimed lands*. Cambridge University Press, Cambridge.
- Manglesdorff, P.C. 1966. Genetic potentials for increasing yields of food crops and animals. *Proceedings of the National Academy of Sciences, USA* 56: 370–375.
- Margules, C.R., Nicholls, A.O. and Pressey, R.L. 1988. Selecting networks of reserves to maximize biological diversity. *Biological Conservation* 43: 63–76.
- Margules, C.R., Pressey, R.L. and Nicholls, A.O. 1991. Selecting nature reserves. In: Margules, C.R. and Austin, M.P. (eds), *Nature Conservation: Cost effective surveys and data analysis*. 90–97. CSIRO, Melbourne, Australia.
- Marshall, D.R. and Brown, A.H.D. 1975. Optimum sampling strategies in genetic conservation. In: Frankel, O.H. and Hawkes, J.G. (eds), *Plant Genetic Resources for Today and Tomorrow*. 53–80. Cambridge University Press, London.
- Martin, T.E. 1988. Habitat and area effects on forest bird species: is nest predation an influence? *Ecology* 69: 74–84.
- Matlack, G.R. 1993a. Microenvironment variation within and among forest edge sites in the eastern United States. *Biological Conservation* 66: 185–194.
- Matlack, G.R. 1993b. Sociological edge effects: spatial distribution of human impact in suburban forest fragments. *Environmental Management* 17: 829–835.
- Miller, K.R. 1980. *Planificación de parques nacionales para el Ecodesarrollo en Latino America*. Fundación para la ecología y la protección del medio ambiente, Spain.
- Miller, K.R. 1995. *Balancing the Scales: Guidelines for increasing biodiversity's chances through bioregional management*. World Resources Institute, Washington, DC.
- Ministry of Tourism, Natural Resources, and Environment. 1991. *Serengeti Regional Conservation Strategy. Phase II Final Report; Phase III Action Plan*. United Republic of Tanzania Ministry of Tourism, Natural Resources, and Environment, Dar es Salaam.
- Moyle, P.B. and R.A. Leidy. 1992. Biodiversity in aquatic ecosystems: evidence from fish faunas. In: Fiedler, P.L. and Jain, S.K. (eds), *Conservation Biology: The theory and practice of nature conservation, preservation, and management*. 127–170. Chapman and Hall, New York.

- Murdoch, L.** 1992. *Discover the Great Barrier Reef Marine Park*. Bay Brooks, Pymble, Australia.
- Murphy, P.G. and Lugo, A.E.** 1986. Ecology of tropical dry forest. *Annual Review of Ecology and Systematics* **17**: 67–88.
- Namkoong, G.** 1986. Genetics and forests of the future. *Unasylva* **152**: 2–18.
- Nepstad, D.C., Uhl, C. and Serrao, E.A.S.** 1991. Recuperation of a degraded Amazonian landscape: forest recovery and agricultural restoration. *Ambio* **20**: 248–255.
- Newmark, W.D.** 1987. A land bridge perspective on mammalian extinctions in western North American Parks. *Nature* **325**: 430–432.
- Noss, R.F.** 1987. Corridors in real landscapes: a reply to Simberloff and Cox. *Conservation Biology* **1**: 159–164.
- Noss, R.F.** 1992. The Wildlands Project land conservation strategy. *Wild Earth* (Special issue): 10–25.
- Nulsen, R.A., Bligh, K.J., Baxter, I.N., Solin, E.J. and Imrie, D.H.** 1986. The fate of rainfall in a mallee and heath vegetated catchment in southern Western Australia. *Australian Journal of Ecology* **11**: 361–371.
- Odum, E.P.** 1971. *Fundamentals of Ecology*. W.B. Saunders, Philadelphia.
- Olney, P.J.S. (ed.)** 1993. *1992 International Zoo Yearbook*. Volume 32. Zoological Society of London, London.
- Olney, P.J.S. and Ellis, P. (eds)**, 1991. *1990 International Zoo Yearbook*. Volume 30, Zoological Society of London, London.
- Olney, P., Mace, G.M. and Feistner, A.C.T. (eds)**, 1994. *Creative Conservation: Interactive management of wild and captive animals*. Chapman and Hall, London.
- Pande, P., Kothari, A. and Singh, S.** 1991. *Directory of National Parks and Sanctuaries in the Andaman and Nicobar Islands: Management status and profiles*. Indian Institute of Public Administration, New Delhi.
- Pandit, A.K.** 1991. Conservation of wildlife resources in wetland ecosystems of Kashmir, India. *Journal of Environmental Management* **33**: 143–154.
- Paton, P.W.** 1994. The effect of edge on avian nest success: how strong is the evidence? *Conservation Biology* **8**: 17–26.
- Pickett, S.T.A. and White, P.S. (eds)** 1985. *The Ecology of Natural Disturbance and Patch Dynamics*. Academic Press, Orlando, Fla.
- Plucknett, D.L., Smith, N.J.H., Williams, J.T. and Anishetty, N.M.** 1987. *Gene Banks and the World's Food*. Princeton University Press, Princeton, NJ.
- Potter, C.S., Cohen, J.I. and Janczewski, D. (eds)** 1993. *Perspectives on Biodiversity: Case studies of genetic resource conservation and development*. AAAS Press, Washington, DC.
- Pressey, R.L., Johnson, I.R. and Wilson, P.D.** 1994. Shades of irreplaceability: towards a measure of the contribution of sites to a preservation goal. *Biodiversity and Conservation* **3**: 242–262.
- Primack, R.B.** 1993. *Essentials of Conservation Biology*. Sinauer Associates, Sunderland, Mass.
- Primack, R.B.** 1995. *A Primer of Conservation Biology*. Sinauer Associates, Sunderland, Mass.
- Pysek, P. and Rach, K.** 1993. Plant invasions and the role of riparian habitats: a comparison of four species alien to central Europe. *Journal of Biogeography* **20**: 413–420.
- Rabinowitz, A.** 1995. Helping a species go extinct: the Sumatran rhino in Borneo. *Conservation Biology* **9**: 482–488.
- Rawlins, C.** 1994. *Sustaining the Greater Yellowstone: A blueprint for the future*. Greater Yellowstone Coalition, Bozeman, Montana.
- Reading, R.P. and Kellert, S.R.** 1993. Attitudes toward a proposed reintroduction of black-footed ferrets (*Mustela nigripes*). *Conservation Biology* **7**: 569–580.
- Recher, H.F.** 1993. The loss of biodiversity and landscape restoration: Conservation, management, survival – an Australian perspective. In: Saunders, D.A., Hobbs, R.J. and Ehrlich, P. (eds), *Nature Conservation 3: Reconstruction of fragmented ecosystems*. 141–151. Surrey Beatty and Sons, Chipping Norton, NSW.
- Reid, W.V., Laird, S.A., Meyer, C.A., Gamez, R., Sittenfeld, A., Janzen, D., Gollin, M.A. and Juma, C. (eds)** 1993. *Biodiversity Prospecting: Using genetic resources for sustainable development*. World Resources Institute, Washington, DC.
- Rodgers, W.A. and Panwar, H.S.** 1988. *Planning a Wildlife Protected Area Network in India*. Volumes I and II. Wildlife Institute of India, Dehradun, India.
- Rowell, T.A.** 1986. The history of drainage at Wicken Fen, Cambridgeshire, England, and its relevance to conservation. *Biological Conservation* **35**: 111–142.
- Saunders, D.A.** 1989. Changes in the avifauna of a region, district and remnant as a result of fragmentation of native vegetation: the wheatbelt of Western Australia. A case study. *Biological Conservation* **50**: 99–135.
- Saunders, D.A.** 1990. Problems of survival in an extensively cultivated landscape: the case of Carnaby's Cockatoo (*Calyptorhynchus funereus latirostris*). *Biological Conservation* **54**: 277–290.
- Saunders, D.A. and de Rebeira, C.P.** 1991. Values of corridors to avian populations in a fragmented landscape. In: Saunders, D.A. and Hobbs, R.J. (eds), *Nature Conservation 2: The role of corridors*. 221–240. Surrey Beatty, Chipping Norton, NSW.
- Saunders, D.A., Hobbs, R.J. and Ehrlich, P.R. (eds)** 1993. *Nature Conservation 3: Reconstruction of fragmented ecosystems, global and regional perspectives*. Surrey Beatty and Sons, Chipping Norton, NSW.
- Saunders, D.A., Hobbs, R.J. and Margules, C.R.** 1991. Biological consequences of ecosystem fragmentation: a review. *Conservation Biology* **5**: 18–32.
- Scougall, S.A., Majer, J.D. and Hobbs, R.J.** 1993. Edge effects in grazed and ungrazed Western Australian wheatbelt remnants in relation to ecosystem reconstruction. In: Saunders, D.A., Hobbs, R.J. and Ehrlich, P.R. (eds), *Nature Conservation 3: Reconstruction of fragmented ecosystems, global and regional perspectives*. 163–174. Surrey Beatty and Sons, Chipping Norton, NSW.
- Shafer, C.L.** 1990. *Nature Reserves: Island theory and conservation practice*. Smithsonian Institution Press, Washington, DC.
- Simberloff, D.** 1988. The contribution of population and community biology to conservation science. *Annual Review of Ecology and Systematics* **19**: 473–511.
- Simberloff, D. and Cox, J.** 1987. Consequences and costs of conservation corridors. *Conservation Biology* **1**: 63–71.
- Simberloff, D., Farr, J.A., Cox, J. and Mehlman, D.W.** 1992.

- Movement corridors: conservation bargains or poor investments? *Conservation Biology* **6**: 493–504.
- Singh, S., Kothari, A. and Pande, P.** 1990. *Directory of National Parks and Sanctuaries in Himachal Pradesh: Management status and profiles*. Indian Institute of Public Administration, New Delhi.
- Sisk, R.D. and Margules, C.R.** 1993. Habitat edges and restoration: methods for quantifying edge effects and predicting the results of restoration efforts. In: Saunders, D.A., Hobbs, R.J. and Ehrlich, P.R. (eds), *Nature Conservation 3: Reconstruction of fragmented ecosystems, global and regional perspectives*. Surrey Beatty and Sons, Chipping Norton, NSW.
- Small, M.F. and Hunter, M.L.** 1988. Forest fragmentation and avian nest predation in forested landscapes. *Oecologia* **76**: 62–62.
- Smith, N.J.H.** 1986. *Botanic Gardens and Germplasm Conservation*. Harold L. Lyon Arboretum Lecture No. 14. University of Hawaii Press, Honolulu.
- Smith, N.J.H., Williams, J.T., Plucknett, D.L. and Talbot, J.P.** 1992. *Tropical Forests and Their Crops*. Cornell University Press, Ithaca, NY.
- Sombroek, W.G.** 1966. *Amazon Soils: A reconnaissance of the soils of the Brazilian Amazon Region*. PUDOC, Wageningen.
- Soulé, M.E.** 1991. Land use planning and wildlife maintenance: guidelines for conserving wildlife in an urban landscape. *Journal of the American Planning Association* **57**: 313–323.
- Statham, D.C.** 1994. The farm scheme of North York Moors National Park, United Kingdom. In: Western, D., Wright, R.M. and Shrum, S.C. (eds), *Natural Connections: Perspectives in community-based conservation*. 282–299. Island Press, Washington, DC.
- Stuart, S.N.** 1987. Why we need Action Plans. *Species* **8**: 4–9.
- Stuart, S.N., Adams, R.J. and Jenkins, M.D.** 1990. *Biodiversity in Sub-Saharan Africa and its Islands*. IUCN Species Survival Commission. IUCN, Gland.
- Stuart, S.N. and Sullivan, T.A.** 1994. How biologists can assist the Convention on Biological Diversity: lists revisited. In: Krattinger, A.F., McNeely, J.A., Lesser, W.H., Miller, K.R., St Hill, Y. and Senanayake, R. (eds), *Widening Perspectives on Biodiversity*. 201–208. IUCN, Gland, and International Academy of the Environment, Geneva.
- Taylor, K.I.** 1988. Deforestation and Indians in Brazilian Amazonia. In: Wilson, E.O. (ed.), *Biodiversity*. 138–144. National Academy Press, Washington, DC.
- Udvardy, M.D.F.** 1975. *A Classification of the Biogeographical Provinces of the World*. IUCN Occasional Paper No.18. IUCN, Morges, Switzerland.
- Uhl, C.** 1987. Factors controlling succession following slash-and-burn agriculture in Amazonia. *Journal of Ecology* **75**: 377–407.
- UNEP.** 1992. *Convention on Biological Diversity*. June 1992. United Nations Environment Program, Nairobi.
- Usher, M.B. (ed.)** 1986. *Wildlife Conservation Evaluation*. Chapman and Hall, London.
- van Schagen, J.J., Hobbs, R.J. and Majer, J.D.** 1992. Defoliation of trees in roadside corridors and remnant vegetation in the Western Australian wheatbelt. *Journal of the Royal Society of Western Australia* **75**: 63–69.
- Wadden Sea Assessment Group (WAG) and Trilateral Working Group (TWG).** 1991. *The Wadden Sea Status and Developments in an International Perspective*. Report to the Sixth Trilateral Governmental Conference on the protection of the Wadden Sea, Esbjerg, 13 November, 1991. National Forest and Nature Agency, the Ministry of the Environment, Denmark and the Common Wadden Sea Secretariat.
- Wang, B.S.P., Charest, P.J. and Downie, B.** 1993. *Ex-situ Storage of Seeds, Pollen and In-vitro Cultures of Perennial Woody Plant Species*. FAO Forestry Paper 113. UN Food and Agriculture Organization, Rome.
- Ward, S.C., Koch, J.M. and Nichols, O.G.** 1990. Bauxite mine rehabilitation in the Darling Range, Western Australia. *Proceedings of the Ecological Society of Australia* **16**: 557–565.
- WCMC.** 1992. *Global Biodiversity: Status of the Earth's living resources*. World Conservation Monitoring Centre, Cambridge, UK.
- WCMC.** 1994. *Biodiversity Data Sourcebook*. World Conservation Monitoring Centre, Cambridge.
- Wiens, J.A., Stenseth, N.C., Van Horne, B. and Ims, R.A.** 1993. Ecological mechanisms and landscape ecology. *Oikos* **66**: 369–380.
- Wilson, E.O. and Willis, E.O.** 1975. Applied biogeography. In: Cody, M.L. and Diamond, J.M. (eds), *Ecology and Evolution of Communities*. 522–534. Belknap Press, Cambridge, Mass.
- WRI/IUCN/UNEP.** 1992. *Global Biodiversity Strategy: Guidelines for action to save, study, and use Earth's biotic wealth sustainably and equitably*. World Resources Institute, Washington, DC, World Conservation Union, Gland, and United Nations Environment Programme, Nairobi.
- WWF/IUCN/BGCS.** 1989. *The Botanic Gardens Conservation Strategy*. World Wildlife Fund International, the International Union for the Conservation of Nature, Gland, and the Botanic Gardens Conservation Secretariat (Botanic Gardens Conservation International), Richmond, UK.
- Wyse Jackson, P.S. and Ackeroyd, J.R.** 1994. *Guidelines to be Followed in the Design of Plant Conservation or Recovery Plans*. Convention on the Conservation of European Wildlife and Natural Habitats Publication No. 68. Council of Europe Press, Strasbourg, France.
- Yates, C.J., Hobbs, R.J. and Bell, R.W.** 1994. Landscape-scale disturbances and regeneration of semi-arid woodlands of south-western Australia. *Pacific Conservation Biology* **1**: 33–41.

13.5 Social-economic strategies to sustainably use, conserve and share the benefits of biodiversity

13.5.1 Introduction

Social and economic strategies have become increasingly prominent in biodiversity planning (see, for example, WRI/IUCN/UNEP 1992). But many of these approaches are new to conservationists, and there is little experience in applying them to the sustainable use and conservation of biodiversity. Much of the discussion related to their use has therefore consisted of describing

examples of comparatively new or recent efforts, which are largely untested, as well as exhortations to take actions for which the full implications are not yet well understood.

Conservationists need to enhance their appreciation of the impact of social and economic processes on the protection and sustainable use of biodiversity. They also need to explore thoroughly the potential for socioeconomic tools and methods to complement other conservation policies and programmes. This chapter gives an overview of some of these challenges and opportunities, with an emphasis on their use at local and community levels.

13.5.2 Social interventions at local and community levels

Economic conditions and policies have a profound effect on the ability of people to use biological resources sustainably, to conserve them, and to share their benefits. Most of the underlying causes of biodiversity loss are found in national and international policies that undervalue natural resources, create incentives to over-exploit biodiversity, and widen the gap between the richest and poorest both within societies and between countries (see Section 12). Economic policies and tools used to address these problems at national and international levels are discussed in Section 12.7.

Some of the most effective tools for enhancing the sustainable use and conservation of biodiversity, however, are strategies to strengthen social involvement and participation in biodiversity management. Without local participation and support, many conservation and sustainable use efforts fail. This has been recognized by many in the conservation and sustainable development communities, and social components are now commonly found in biodiversity management projects. Still, the effectiveness of these efforts is poorly documented. In part, this is due to the difficulty of assessing the impact of social interventions. It is also true that most social components of biodiversity management programmes are relatively recent.

Two important types of social tools – the use of indigenous knowledge and strategies for local participation – are reviewed here. Their role in biodiversity management is then assessed in the context of community forestry and protected areas management.

13.5.2.1 Indigenous knowledge

Indigenous peoples with a historical continuity of resource use practices often possess valuable knowledge about the behaviour of complex ecological systems in their own localities. This knowledge has accumulated through a series of observations that stretch over many generations. Where indigenous peoples have depended on local environments for the provision of resources over long

periods of time, they often develop a stake in conserving biodiversity. Their practices for biodiversity conservation were built through lengthy trial and error processes. This implies an intimate relationship between the application of ecological knowledge with belief systems.

Such knowledge is difficult for Western science to understand. It is vital, however, that the value of the knowledge–practice–belief complex of indigenous peoples as it relates to biodiversity management is fully recognized. Conserving this knowledge might best be accomplished through promoting the community-based resource management systems of indigenous peoples (Gadgil *et al.* 1993). Several examples of such systems are presented below. See also Section 11, and 13.3.2, 13.3.3, 13.3.4 and 13.3.5 for techniques used in traditional management systems associated with agriculture, forestry, fisheries and the use of wild flora and fauna.

Brazilian Kayapo Indians at the southern edge of the rain forest develop forest islands or *apete*. Beginning as small vegetation mounds, these *apete* are carefully managed and supplemented as they grow with a complex species mix of medicinal plants, palms and vines. New *apete* fields reach peak production levels in 2–3 years, although some species, such as sweet potatoes, yams, taro, banana and papaya are productive for longer periods. Even when the primary crops disappear, old *apete* fields keep producing a range of useful products. They become heterogenous forest patches, some managed for fruit and nut trees and for attracting wildlife (Posey 1985).

Runa Indian swiddens in the Ecuadorian Amazon resemble agroforestry systems rather than the slash-and-burn approach that merely results in a temporary clearing in the forest canopy. Compared to unmanaged fallows, such swiddens actually increase species diversity through the planting and protection of secondary species (Irvine 1989).

There is species diversity management in a number of traditional aquaculture systems. In some Chinese integrated agriculture–aquaculture systems, the fish are fed with agricultural wastes, and fish waste is used to fertilize crops. An example is the fish-farming system integrated with mulberry silkworm, vegetables and sugarcane production in the Zhujiang Delta (Ruddle and Zhong 1988). In Indonesia, traditional systems combined rice and fish culture. Wastes from such systems often flowed downstream into a brackish water aquaculture system or *tambak*. The *tambaks* themselves were polycultural ponds, often combining fish, vegetables and tree crops (Costa-Pierce 1988).

While the practices of habitat management by traditional agriculturalists are well known, knowledge about habitat management by hunter-gatherers is more controversial. But there is now evidence that Amerindians of Alberta, Canada, regularly used fire until the late 1940s to open up forest clearings and corridors to provide improved habitat for ungulates and wildfowl. Hunting success as well as

accessibility were improved by this method (Lewis and Ferguson 1988). Similar findings in Australia suggest that aboriginal hunters used fire to improve feeding habitat for game and to assist in the hunt itself (Lewis 1989).

Gadgil *et al.* (1993) argue that four kinds of indigenous conservation practices are of particular relevance to biodiversity conservation:

1. Total protection to individual biological communities, including ponds, meadows, pools along river courses, and forests. Throughout the Old World, forests were often protected as sacred groves. Protection provided in such refuges may have been an effective way of ensuring the persistence of certain species and biological communities.
2. All individuals of certain species of plants and animals may be afforded total protection. For example, *Ficus* trees are widely protected in many parts of the Old World. These trees are considered a keystone resource by ecologists. Local people are often aware of the importance of these trees as a refuge for a wide range of birds, bats and primates, and this understanding may have been converted into widespread protection of the *Ficus* tree at some point in the past.
3. Certain particularly vulnerable stages in the life cycle of an organism may be given special protection. The danger of over-harvesting and depletion is clearly greater if these species are hunted during their vulnerable stages, and the protection afforded them may be evidence of ecological prudence. For example, fruit bats may be hunted in south India when they are away foraging but not at daytime roosts, even when these are within villages.
4. Major events of resource harvesting are often carried out as a group effort. Many tribal groups engage once a year in a large-scale, communal hunt, which may help groups assess the status of prey populations and provide information needed to adjust harvesting levels.

Indigenous peoples have received much attention as potential resource managers of threatened tropical forest ecosystems, although they often lack control over their territory and resources (Davis and Wali 1993). But the question of what indigenous people and conservationists have in common is a highly controversial and emotional one (see Alcorn 1993; Redford and Stearman 1993). While there is general agreement that it is wise for conservationists to work with indigenous peoples, there is considerable difference of opinion over the extent to which the interests and agendas of the two groups are in harmony or in conflict. The process of change that many traditional groups are experiencing implies a restructuring of community institutions. Biodiversity in traditional lands

may ultimately depend on the existence and influence of these institutions (Brandon 1995b).

13.5.2.2 Local participation

The theory and practice of local participation in rural development have been well documented (e.g. Cohen and Uphoff 1977; Oakley 1991; Cernea 1991), and recently conservationists have begun to utilize the concept. But there is considerable debate about what participation actually means, as well as about its relationship with the protection and sustainable use of biodiversity. Careful reviews of participatory approaches to biodiversity management based on extensive case-study materials have been carried out by West and Brechin (1991), Wells *et al.* (1992), Wells and Brandon (1993), Brandon (1994), Brandon and Wells (1992) and Little (1994). Unless otherwise stated, the discussion in this section is drawn from Wells *et al.* (1992).

While many, if not most, biodiversity management projects now emphasize local participation, few projects have specified what they mean by participation, or how they expect local participation in project development activities to contribute to the sustainable use and protection of biodiversity. Thus, some uncertainty and ambiguity surrounds the issue of local participation and conservation, both in theory and in practice. It is important to ask *what* local people are participating in, *who* is participating, and *how* they get to participate.

Projects can be identified that deliver social and economic benefits to local people. Is this local participation? Most likely not. Local participation viewed as a process goes well beyond simply sharing in social and economic benefits. It has been described as 'empowering people to mobilize their own capacities, be social actors rather than passive subjects, manage the resources, make decisions, and control the activities that affect their lives' (Cernea 1991).

Projects may be classified on the basis of their approaches to and relationships with the intended beneficiaries. At one end are projects that perceive local peoples' involvement as passive – the 'beneficiary' approach. The goals of this approach to development are tangible economic benefits, although those who are to receive them have only a limited role in generating them. At the other end are projects that seek to involve people in the process of their own development, adopting a 'participatory' approach. In these projects, development is perceived as a way to empower people and improve their ability to control their lives and use and manage resources. The project is a catalyst to stimulate self-reliance among the poor and underprivileged. This approach emphasizes the role of local institutions – both formal and informal – in providing people with the means to control their lives.

Projects with a beneficiary orientation generally set their goals in terms of changes in readily measurable indices,

such as income levels, farm productivity, infant mortality rates and literacy rates. Project success is then gauged by improvements in these indices. The goals and measures of effectiveness in projects with a participatory orientation are more elusive. Eventually such projects seek to achieve goals similar to those of beneficiary projects; however, they are orientated more toward establishing a process leading to change that can be sustained after the project ends.

Paul (1987) summarized much of the literature on the participatory approach by suggesting that its objectives include increasing project effectiveness, increasing the capacity of beneficiaries to take responsibility for project activities, and facilitating cost-sharing through local contributions of land, money or labour. Others have pointed to the importance of involving stakeholders – intended beneficiaries – to give them a vested interest in, and presumably greater commitment to, achieving project goals. It is not easy to measure achievements against these kinds of objectives, particularly over short periods, while projects are still under way and before more tangible benefits have become apparent.

There are five main areas in which local people can participate in projects (Cohen and Uphoff 1977; Paul 1987; Salmen 1987):

1. **Information-gathering:** Project designers or managers both collect information from and share information with intended beneficiaries on the overall project concept and goals.
2. **Consultation:** Intended beneficiaries are consulted on key issues during the project. Beneficiaries have an opportunity to interact and provide feedback during project design, implementation, or both.
3. **Decision-making:** Beneficiaries participate in decision-making about project design or implementation, giving a greater degree of control and responsibility than the passive acceptance of possibly unwanted benefits.
4. **Initiating action:** When beneficiary groups identify a new need in a project and decide to respond to it, they are taking the initiative for their own development. This is different from acting or deciding on tasks or issues identified by the project.
5. **Evaluation:** Participatory evaluation by beneficiaries can provide valuable insights and lessons for project design and implementation – information that is otherwise likely to remain unknown.

A project may not have a consistent approach to participation that stretches across all of its components or activities. To use Paul's (1987) term, project components

may each have their own 'intensity' of participation. But local participation in conservation projects implies the consistent involvement of local people in strategic project issues rather than their occasional or limited involvement in day-to-day activities. Very few, if any, of the more than 50 projects studied by West and Brechin (1991), Wells *et al.* (1992), and Little (1994) can pass this test.

Two principal approaches to organizing and sustaining community participation in projects can be identified: employing agents of change and building local institutions.

1. **Agents of change.** Agents of change are also referred to as field workers, extension workers, community organizers or animators. Paul (1987) distinguishes two categories: field workers employed by the agency implementing the project, and workers or volunteers from among the beneficiaries who act as community mobilizers. Ideally, agents of change do not act as leaders and do not tell the community what to do (Midgley 1986; Tilakaratna 1987). Their task is to foster grass-roots participation and build local institutions. Examples of agents of change in biodiversity conservation are shown in Box 13.5-1.

2. **Institution building.** It has been argued that local participation through institutions or organizations is more likely to be effective and sustained than individual participation (see, for example, Uphoff 1991). Local institutions can act as a focus for mobilization among local people and as a link between local people and external organizations, whether governmental or non-governmental. Institution-building has been defined by Midgley (1986) as 'the creation of procedures for democratic decision making at the local level and the involvement of local people in these procedures to the extent that they come to regard them as the normal way of conducting community affairs'. Examples of project attempts to build local institutions are included in Box 13.5-2. Most of these institutions are of relatively recent origin and few, if any, have become independent of the projects.

For a conservation project to achieve its basic objective – the protection and sustainable use of biodiversity – people can only be empowered in aspects of development, including local resource management, that do not lead to over-exploitation or degradation of the protected wildlife and wildlands. In practice, this can be very difficult to achieve using economic incentives. Conflicts of interest are inherent between rural people's ability to earn a living and the management of nearby protected areas. It is unrealistic to assume that resource-poor people, living next to what may appear to them to be limitless resources of land, trees, plants and animals, will readily support park protection

ideals. Projects can, and should, try to mitigate such conflicts of interest by promoting alternative income sources and education programmes. But the conflicts cannot be expected to disappear (Wells *et al.* 1992).

Despite much rhetoric to the contrary, most biodiversity conservation projects have treated local people as passive beneficiaries of project activities and have failed to involve them in the process of change and their own development. As a result, the targets of the projects often have no stake in or commitment to the activities being promoted. This apparent lack of progress is at least partly attributable to a project's relatively short duration and illustrates how lengthy and difficult a process eliciting local participation in any development project can be.

The limited experience to date suggests that at least a decade is likely to be needed, instead of two or three years as once thought. Such lengthy periods will require patience and commitment from donors, project managers and the intended beneficiaries. These long periods are also likely to be accompanied by a continued escalation of threats against the protected area that the project is trying to conserve. The need for patience can conflict with feelings of urgency about the need to change or stop destructive patterns of protected area degradation (Wells *et al.* 1992).

While participatory approaches to biodiversity conservation have yet clearly to demonstrate their effectiveness, participation can facilitate a more co-operative relationship between protected areas and local people and thus make law enforcement more humane and acceptable. A balanced approach would seem essential. In the long term, local participation should be sought as much as possible. However, short-term benefits also are needed to establish projects' credibility locally and to overcome distrust among the target population. The continuing need for law enforcement will have to be balanced between these long- and short-term goals. The appropriate nature of this balance for individual projects will depend on a thorough assessment of local social, political, economic, cultural and biological factors (Wells *et al.* 1992).

13.5.2.3 Methods of participatory inquiry

Methodologies of social assessment and participatory inquiry have the potential to help conservationists and others to find better ways of making participation truly participatory. In recent years there has been a rapid expansion in alternative methods of such inquiry. These methods have drawn on many long-established traditions that have put participation, action research, and adult education at the forefront of efforts to empower disenfranchised local people (Chambers 1992; Pretty 1994).

These new systems of inquiry represent a significant departure from standard practice. Some of the changes under way are remarkable. In many government and non-governmental institutions, top-down project design

blueprints are being superseded by investigation and analysis by local people themselves (Pimbert and Pretty 1994). There are some important common principles in these new systems of inquiry (Pretty 1994):

- A defined methodology and systematic learning process, with a focus on cumulative learning by all the participants.
- Multiple perspectives, seeking the diverse evaluations of different individuals and groups rather than characterizing complexity in terms of average values.
- Group inquiry process, implying three possible mixes of investigators: from different disciplines, from different sectors, and from outsiders (professionals) and insiders (local people).
- Context-specific inquiry, with approaches flexible enough to suit each new set of conditions and actors.
- The facilitation of experts and stakeholders to try to bring about changes that people in the situation regard as improvements.
- Inquiry leading to sustained action and implementable changes that represent an accommodation between different views, with actions including institution strengthening to increase people's capacity to initiate action on their own.

The range of participatory methods in use has increased dramatically in recent years (e.g. Mascarenhas *et al.* 1991; Chambers 1992; Pretty 1994). The methods are structured into four classes: (1) for group and team dynamics, (2) for sampling, (3) for interviewing and dialogue, and (4) for visualization and diagramming. Data gathering and analysis techniques that are generally applicable to the social assessment or participatory inquiry linked to biodiversity conservation projects are illustrated in Box 13.5-3.

Local people using the methods of participatory inquiry have shown a greater capacity to observe, diagram and analyse than most professionals had expected (Pimbert and Pretty 1994). In some programmes, this has led to village analysts conducting investigations without outsiders being present (Shah 1992). In such cases, participatory methods become the locally owned means to collective action.

Participatory Rural Appraisal (PRA) is a term becoming increasingly familiar to conservationists. PRA is a collective term for a growing list of approaches based on interactive learning, shared knowledge, and a flexible yet structured analysis. The methods are applied in the field by a multidisciplinary team and are designed to quickly generate new information on, and hypotheses about, local conditions and livelihoods. According to PRA practitioners, appropriate behaviour and attitudes allow outsiders to establish rapport, convene, catalyse, facilitate,

Box 13.5-1: Agents of change in biodiversity conservation projects.

Air-Tenere National Nature Reserve, Niger: The project established a network of village representatives from among pastoral communities. The selected representatives are people recognized locally as having authority within their herding groups. Their tasks are to be well informed about the rules, goals and activities in the reserve; to encourage others to support these rules and goals and to inform enforcement authorities of any infractions of the rules observed within their districts. These representatives receive no remuneration from the project, although they attend an annual workshop sponsored by the project.

East Usambara Mountains, Tanzania: To promote interaction with local communities, the project selected a village co-ordinator from each of 15 target villages. The regional government pays the village co-ordinators' salaries and has guaranteed to maintain the positions permanently. The village co-ordinators are the primary link between the project and the villages, meeting monthly as a group to report progress and problems. They are either trained by the project or sent to attend short courses. The village co-ordinators have begun working closely with farmers in their own villages, and most have established agricultural demonstration plots.

Khao Yai National Park, Thailand: At Sup Tai village, the principal agent of change is the full-time project manager from the Population and Development Association, the implementing non-governmental organization. This manager has hired a small number of local staff but works directly with villagers on project activities. The Population and Development Association has been active in thousands of villages throughout Thailand, and its field personnel are well educated and trained, with extensive community development experience.

South Luangwa National Park, Zambia: The main local agents of change are the village scouts. These are young men selected by local chiefs who are employed by the National Park and Wildlife Service and trained in wildlife enforcement. Hiring game scouts from local villages has been an effective way of generating community support for reducing poaching. The next stage of the project calls for hiring some 50 community facilitators to monitor socioeconomic effects and to involve the more disadvantaged members of the community, especially women.

Talamanca Region, Costa Rica: The project began a community technicians' programme in 1989 with representatives from each of 40 communities where nurseries have been established. The programme is intended to develop local leaders who can provide information on agricultural and agroforestry development and can act as liaisons between their community and outside agencies. Each community selects a representative, plus a deputy, to receive advanced training in agriculture and agroforestry. Representatives tend to be younger, better-educated members of the community. When they return to their villages, they train others in what they have learned, often on an individual basis. Farmers work on the community technicians' land in exchange for the time they receive from the community technician.

Source: Wells *et al.* (1992).

adapt, watch, listen, learn and respect. Meanwhile local people's sense of empowerment grows as they map, mode, diagram, interview, quantify, rank and score, inform and explain, show, discuss and analyse, plan, present and share their knowledge and experience with others (Pimbert and Pretty 1994).

The application of PRA and other new methods of participatory inquiry to biodiversity conservation will be of great interest to conservationists. International donor agencies are now beginning to incorporate the use of social assessment and participation techniques into the design of biodiversity conservation projects. For example, the World Bank (1994) has developed a set of guidelines to assess

how social factors such as capacity for local participation, tenurial rights, customary controls that regulate access to resources, gender roles in conservation, and community organization can be addressed in designing, implementing and monitoring projects. These guidelines are being tested in the design and implementation of GEF projects in India, Ecuador and Ghana. Results from those experiences will be used to revise and finalize guidelines that apply to all biodiversity conservation projects supported by the World Bank. Guidelines for monitoring and evaluating GEF projects, including socioeconomic and participation considerations, have also been developed (GEF 1992). While these guidelines are generic, and

Box 13.5-2: Institution building in biodiversity conservation projects.

Annapurna Conservation Area Project, Nepal: The project promoted the establishment of forest management committees and tourist lodge management committees. The forest management committee has helped re-establish community control over local forests, as existed prior to nationalization in the 1950s. Both the lodge and forest management committees have made some key resource management decisions.

Central Selva Region, Peru: The Amuesha Indians formed a six-person committee to determine the best structure for organizing forestry activities. The committee consisted of one representative from each of five communities and the proposed forestry activities administrator. A co-operative structure, similar to Amuesha communal government systems, was selected and shortly thereafter, members from the five communities joined to establish a forestry co-operative. Members participate in working groups, and the heads of working groups make decisions collectively.

Khao Yai National Park, Thailand: Project development and conservation activities at each village are centred on the environmental protection society. These institutions were created to enable villagers to take control of resource management and to encourage them to take some responsibility for safeguarding the national park. Considerable emphasis has been placed on establishing the credibility of the environmental protection society as a viable organization separate from the project centres.

Boscosa Project, Costa Rica: The project has helped establish or strengthen numerous small, local organizations throughout the Osa Peninsula. These organizations include a locally organized co-operative whose ultimate objective is to process wood into low-priced furniture, and agricultural producers' associations in three different communities. The project has also tried to strengthen existing community groups. Project staff have trained local communities in programme development, proposal writing and fund-raising.

Talamanca Region, Costa Rica: The project helped create the Talamanca Association of Small Producers (APPTA), a regional procurement, processing and marketing association. The association was established in 1987 and is administered locally by farmers involved in the project. It is one of the few regional sources for procurement of agricultural inputs or marketing assistance. User groups have been established for community nurseries and women's organic-farming groups. About 600 households in 40 communities have decided to participate. Each group decides how to organize the work, what seedlings to establish, the labour contributions from members, and so on.

Source: Wells *et al.* (1992).

experience with them is limited, their existence confirms the importance of participation and other social factors in conservation programmes. International NGOs are also devoting considerably more resources to social assessment in the planning, implementation and monitoring of biodiversity conservation projects (see, for example, BSP 1995). Assuming such guidelines are implemented effectively, a much larger body of evidence will be available in a few years' time to assess how social mechanisms can best be used to benefit both biodiversity and development needs.

13.5.2.4 Community forest management

Throughout much of South and Southeast Asia, communities have relied historically on their own rules and regulations to control forest use and to ensure equitable distribution of forest lands and products for agriculture, hunting and gathering. Community-based resource

management is generally possible in situations where members are able to carry out basic functions themselves, including the establishment of use regulations, the resolution of disputes, and the equitable distribution of benefits. Unfortunately, in many parts of Asia, the role of indigenous communities' institutions and leaders has been displaced by formal, often politicized, governance institutions. Lessons now emerging indicate that local community institutions need to be acknowledged and given the authority to take on responsibilities for forest protection. In some areas, small informal groups – often tribal – are taking action unilaterally by protecting forests against all outside users. Other groups are receiving support and encouragement from government forest agencies (Poffenberger and McGean 1994).

Over the past five years, India's forestry sector has begun shifting its strategies to emphasize the empowerment of communities as protectors of natural forests in order to

Box 13.5-3: Data gathering and analysis techniques generally applicable to the social assessment or participatory inquiry linked to biodiversity conservation projects.

- Collection of secondary information.
- Key informant interviews.
- Direct observations of processes and behaviours.
- Participant observations of processes and behaviours.
- Diagramming.
- Community mapping.
- Production/livelihood diagramming.
- Gender analysis tools.
- Socioeconomic surveys.
- Community information and consensus-building techniques.
- Project design techniques for needs assessment and identification of risks.

Source: World Bank (1994).

facilitate their regeneration and recapture their productivity. Under the Indian Joint Forest Management (JFM) concept, local communities become partners in protecting and managing state-owned forest resources, thus legitimizing a role in the control of resources that they have often held for generations (see also 13.3.3.1). Successful experiments were undertaken by Forest Department officials in West Bengal, Gujarat, and Haryana states from as early as 1972. In these cases, village Forest Protection Committees (FPCs) – or hill resource management societies in Haryana – were given the responsibility of protecting degraded forest land from illegal cutting, fires, overgrazing and encroachment. In return they were granted access to a range of non-timber forest products and in one case were granted 25% of the net return of the timber harvest (Campbell 1992).

The legal basis for JFM lies in India's National Forest Policy of 1988. Reversing almost a century of official policy, this document stated that forests were no longer to be commercially exploited to meet industrial needs. Instead, they are to be maintained to conserve soil and the environment, and to meet the subsistence requirements of the local people. The Ministry of Environment and Forests issued policy instructions in 1990 to all of the state forestry departments that supported greater participation of village forest communities and NGOs in the regeneration and management of degraded forest lands. These guidelines emphasized the increasing importance of jointly managed forest systems centred on the needs of forest communities, and on granting communities certain rights on regenerating

forest lands (Poffenberger 1990; Campbell 1992; SPWD 1992).

By early 1994, 15 Indian states had ratified the national guidelines and government orders supporting community empowerment for the management of public lands. But only a very small proportion of India's forests have come under effective access controls, and current policy only allows for communities to protect degraded forests. Thus, a major gap continues to separate plans and policies from field realities. But while progress is being made, opportunities should still be sought to expand community-forestry department partnerships beyond degraded forests to include well-stocked forests, parks and other resources of high value, including biodiversity value (Poffenberger and McGeen 1994).

A recent national inventory in Thailand conducted by the Royal Forest Department found nearly 12 000 community forest management initiatives. These included both traditional community institutions created to manage forests for cultural, hydrological or production purposes, as well as more recently established organizations promoted by schools, temples and other local institutions. In Dong Yai, Thailand, 11 rural communities have worked together with regional foresters and researchers to protect and regenerate former *kenaf* fields. A remarkable transformation has taken place over 25 years, producing the largest dipterocarp forest in Northeast Thailand. Each community has organized a protection group that patrols a section of the 4000 hectare forest, monitoring for fires and timber exploitation by outsiders. Elaborate rules developed by the communities limit wood extraction to domestic needs only, while the collection of non-timber forest products such as mushrooms and gum remains open to outsiders from as far as 60 kilometres away. Strong community leadership and sympathetic foresters have played a key role in encouraging these villagers to take responsibility for and pride in the ecological health of their forests (Poffenberger and McGeen 1994).

A number of challenges face forest departments, NGOs and researchers working to facilitate the establishment of community forest systems. Developing an efficient and equitable process through which public forest land can be allocated to local communities for protection is essential. Where forest departments have succeeded in this effort, they have created a supportive environment in which communities can take the lead in reaching consensus on the assignment of responsibilities. Often, decisions over territorial forest boundaries are based on historic use practices, traditional rights and current needs. Communities usually have a better understanding of these criteria and the actors than do the staff of forest departments. Where villages take the first initiative in forest designation and mapping, decisions are more likely to be acceptable to local groups. In such cases, the role of forest departments is to

provide technical support in areas such as mapping, and to help legitimize the outcome (Poffenberger and McGean 1994).

Forest departments are confronted with major transitions as they move from traditional custodial and timber management roles to support roles in joint forest management activities. Protection duties are transferred to the community. Production activities shift from timber to multiple products, managed by villagers. Field staff need to develop a different mix of technical skills and technical expertise to serve as community organizers, forestry extension agents, and market analysts (Poffenberger and McGean 1994).

The Asia experience with community forest management reveals that elaborate policies and heavily funded projects are not necessarily sufficient to accelerate the empowerment of community groups as managers of public forests. Significantly, more critical is the emergence of a political environment supportive of facilitating the establishment and replication of decentralized management systems. Ultimately, simple transparent policies need to be developed as broad guidelines that provide flexibility and encouragement to local administrators and communities to fine-tune their own resource management agreements (Poffenberger and McGean 1994).

13.5.2.5 Local people and protected areas

People situated in or near biologically diverse ecosystems often gain little economic benefit from conservation or sustainable resource use. In contrast, the costs incurred as a result of conservation measures – especially the establishment of protected areas – tend to be felt most severely at local levels (Wells 1992). Measures designed to promote sustainable use or protection of biodiversity must therefore provide economic incentives to increase the net local benefits from sustainable resource use and protection (McNeely 1988; see also Section 12). Furthermore, it is increasingly recognized as neither politically feasible nor ethically justifiable to attempt to deny poor people the use of natural resources without providing them some alternative means of livelihood (Wells *et al.* 1992). Enlisting the co-operation and support of local people has thus emerged as a major priority for the management of protected areas.

An increasing number of projects have been launched in developing countries with the goal of linking biodiversity conservation with improvements in human welfare (see, for example, McNeely 1988; Kiss 1990; Stone 1991; West and Brechin 1991; Western *et al.* 1994). Led by the international conservation NGOs, these integrated conservation-development projects (ICDPs) have been based primarily on innovative land-use strategies, including biosphere reserves, multiple-use conservation areas, buffer zones on protected area boundaries, and a variety of other approaches (Wells *et al.* 1992).

Participatory approaches to linking biodiversity conservation with local social and economic development have proved enormously attractive to many of the NGOs, government departments, and international agencies involved in biodiversity conservation and sustainable development, including the Global Environment Facility (GEF) (Wells and Brandon 1993). A large proportion of the funds available for biodiversity conservation is now being committed to a variety of ICDPs throughout the developing world, and even more money is potentially available from GEF, from bilateral aid agencies, and possibly through other mechanisms associated with the Biodiversity Convention (Wells 1994).

But despite this dramatic increase in interest, some key questions remain unanswered (Wells 1995):

1. What has been learned about translating the *principles* of biodiversity conservation and sustainable development into effective on-the-ground *action*?
2. Can the lessons from promising local projects be used to increase the effectiveness of the larger-scale programmes that will be funded by the international development agencies?

Since the mid-1980s, NGOs have devoted increasing efforts and financial resources to Integrated Conservation and Development Projects (ICDPs). Most of these have been described as pilot or demonstration projects in recognition of their innovative approaches, limited funds and modest scale. But very few of these projects have so far been able to demonstrate significant improvements in biodiversity conservation that are attributable to, or even connected with, improved local economic opportunities (Wells *et al.* 1992). Unambiguously successful and convincing examples where local peoples' development needs have been effectively reconciled with biodiversity conservation remain difficult to find (Wells 1995). ICDPs therefore represent an extremely challenging approach that has so far generated few clear successes (Oldfield 1988; Sayer 1991; Brandon and Wells 1992; Wells *et al.* 1992; Western *et al.* 1994).

There are several reasons why progress in demonstrating the feasibility of ICDPs has so far been limited (Wells *et al.* 1992; Brandon 1994; Wells 1995). Most existing projects have been implemented on a very small scale, with little financial support, and with insufficient political backing. The projects have also been confronted, and often confounded, by policy and legal constraints originating far outside the individual projects' spheres of influence. Project objectives have often not been well defined, and because projects lack input from universities and professional researchers, few have been designed in such a way as to generate useful lessons.

Finally, the fundamental importance of involving local people, the intended beneficiaries, in all stages of projects has tended to receive more rhetorical than substantive attention. Apart from the problem of small scale, many of the constraints have proved equally difficult to overcome for the ICDPs supported by international development organizations, including the projects supported during the Pilot Phase of the GEF (Wells 1994; UNDP/UNEP/World Bank 1994).

Projects attempting to use social and economic incentives to strengthen biodiversity conservation often use a variety of activities aimed at eliciting local participation, intensifying land use, and increasing local employment, productivity and incomes – in other words, rural development. Rural development is a field with an immense amount of analytical literature and decades of field experience, much of it disappointing. But surprisingly few of the new generation of conservation and sustainable development projects appear to have learned much from the well-documented lessons of rural development or to have drawn sufficiently on organizations and individuals with experience in promoting long-term change in rural communities (Wells *et al.* 1992).

The very limited human and financial resources available to implement ICDPs have invariably been absorbed in addressing day-to-day, site-specific issues. As a result, there has been only limited use of the latest ecological and social science techniques, minimal attention to monitoring and evaluating progress, and little advancement toward the strategic objective of demonstrating the potential for systematic change on a meaningful scale (Wells 1995).

The practical reality of project experience has thus fallen short of the hopes and expectations for biodiversity conservation and sustainable economic development. This is in contrast to some optimistic plans and claims, and despite the efforts of many talented and dedicated people implementing field projects (Wells 1995). One reason may be that many of the underlying assumptions on which these projects have been based are so far unproven, and many are highly questionable (Brandon 1994; Wells 1995). Two of these optimistic assumptions will be considered briefly here.

First optimistic assumption: that biodiversity conservation is generally compatible with sustainable economic development. It is far from clear what trade-offs and choices need to be made in reconciling development with conservation or even whether the concept of sustainable development can be realized in practice (Ludwig *et al.* 1993; Robinson 1993). In conservation circles it has become fashionable to take it for granted that social justice and economic development are necessary preconditions for conservation (Soulé 1991), and that biodiversity conservation in the tropics is *de facto*

compatible with sustainable economic development. But simply to assume that people will be more inclined to conserve local biodiversity if their living standards improve, or that there are always methods to improve local incomes without depleting biodiversity is, at best, naive. In the haste to demonstrate some progress, many new programmes have been launched without adequate research or reflection on the circumstances in which biodiversity conservation and sustainable economic development are compatible, or even how these terms should be defined (Redford and Sanderson 1992).

This is more than an academic debate. Many biodiversity projects that have broadened to focus on local economic needs have lost sight of their original conservation goals and are unable to establish a coherent link between their conservation and development activities. In these circumstances it is often impossible to determine whether local development initiatives have a negative or positive impact on conservation. It is essential to clarify whether projects are attempting to improve local welfare through economic development as a principal objective or, more simply, as a means of enhancing biodiversity conservation (Brandon and Wells 1992). This distinction, which most existing projects have simply passed over, has profound implications for project design and implementation.

Second optimistic assumption: that a project-based approach can achieve conservation and sustainable economic development. A project-based approach has inherent limitations that are often overlooked. Factors leading to the loss of biodiversity include public ownership of extensive areas of land, unmatched by the capacity of government agencies to manage the land; powerful financial incentives that encourage resource over-exploitation; and laws, policies, social changes and economic forces over which poor communities in remote rural areas have no influence. The inability to change the parameters of the environment in which they are operating is a serious weakness of most projects. Even under the best of conditions, projects focusing on areas of high ecological value and targeting local populations can play only a modest role in mitigating the powerful forces causing environmental degradation (Barber *et al.* 1995). When these projects are also trying to develop new approaches with small budgets, inexperienced implementing organizations, and limited access to usable technology, and when the projects are constantly struggling for official recognition, their ambitions must realistically be limited (Wells *et al.* 1992). Individual projects must therefore be recognized as single components within broader-based conservation programmes that also include a variety of policy and institutional initiatives (Barber *et al.* 1995).

High priority should now be given to testing ways of translating the ICDP approach into more effective on-the-

ground action. This might be done through a long-term experimental learning process in biodiversity conservation and sustainable development (see Box 13.5-4). A small number of participatory conservation projects would be undertaken to systematically test and learn from field experiences, including the challenges of scaling up or linking together projects that seem promising at local levels. These experimental projects should reflect an in-depth understanding of the rural development experience, should be adequately funded, and should make strenuous efforts to decentralize strategic as well as day-to-day decision-making to local levels from the very inception of projects. Wherever possible they should be implemented by a mix of NGOs and government agencies, should encourage outside evaluation, and should collaborate with applied professional researchers to thoroughly document, analyse and communicate their results – both successful and unsuccessful (Wells 1995).

The current fascination of donors with ICDPs that combine biodiversity conservation with sustainable economic development is unlikely to continue indefinitely without some tangible demonstrations of progress. If serious long-term financial support to ICDPs is to be provided by conventional and mainstream institutions, it will be essential to find ways to come up with more concrete conclusions on project design and management, replicability, sustainability and cost-effectiveness during the next few years (Wells 1995). Otherwise, the call for biodiversity conservation with sustainable economic development is likely to remain no more than an attractive slogan.

13.5.3 Economic tools and incentives

This section provides examples of where local economic incentives have at least demonstrated their potential effectiveness in supporting biodiversity management objectives more efficiently than have traditional regulatory approaches. There are clearly important overlaps between the 'social' measures described earlier in this chapter and the 'economic' measures that follow, particularly at local levels. The examples and illustrations of economic incentives given here should therefore be read with frequent reference to the caveats and constraints already described in relation to social interventions.

Economic incentive approaches are those that rely on the price system and market forces to achieve their environmental objectives. Economic incentive approaches are highlighted in Article 11 of the Convention, which states that:

Each contracting Party shall, as far as possible and as appropriate, adopt economically and socially sound measures that act as incentives for the conservation and sustainable use of components of biological diversity.

The incentive-based approach to the protection and sustainable use of biodiversity attempts to improve decision-making that affects biological resources by improving markets for these resources. This approach recognizes that the conservation of biodiversity will be effective only if resource users are confronted with the true cost of their actions, and to the extent that the global and domestic values of biological diversity are appropriable by the individuals and societies who actually make the decisions concerning resource allocation (OECD 1994).

A wide array of economic incentive measures is potentially usable for the sustainable use and protection of biodiversity. In all cases, these economic incentive measures seek to improve markets for biological diversity, or create them where they did not previously exist. In some cases, this is achieved by giving value to biological diversity through compensation, penalties and improved resource pricing. In other cases, it is achieved by the removal of market distortions, improved market information, the introduction of systems of trading, and improved systems of property rights (OECD 1994; see Section 12).

To function effectively, incentives require some degree of regulation, enforcement and monitoring. They must be used with considerable sensitivity if they are to attain their objectives, and must be able to adapt to changing conditions. Each particular setting will have its own challenges, calling for a site-specific package of incentives and disincentives. The role of government in providing the policy framework is crucial (McNeely 1993).

After presenting examples of how local economic incentives can work, several strategies for generating economic benefits from the conservation and sustainable use of biodiversity are assessed. These include the development of non-timber forest products, ecotourism and private reserves.

13.5.3.1 Local economic incentives

McNeely (1988) describes several examples from Africa to illustrate how locally targeted economic incentives can work. In the Andohahela National Park, Madagascar, traditional plants are collected for food and medicinal purposes. To build stronger local support for the protected area, conservation efforts have repaired small irrigation canals, improved irrigation systems, and established tree nurseries. Nature protection agents have been recruited from local villages (Durbin and Ralambo 1992).

In Kasungu National Park, Malawi, local people have been given the right to harvest tree caterpillars and to establish beehives in exchange for curbing other uses that are incompatible with the objectives of the park. The per hectare profits from these enterprises are higher than those that subsistence farmers can obtain by growing maize, beans and groundnuts. Similar programmes have also been established in Nyeka National Park and Vwaza Game Reserve (Mkanda 1992).

Box 13.5-4: Elements of a new approach to integrated conservation-development projects.

- **Involve local people** in all aspects of project consultation, identification, design, implementation, and evaluation, including strategic as well as day-to-day management. Draw on indigenous knowledge and technologies. Foster local ownership of and commitment to projects, and stimulate the emergence of local leaders and organizations to sustain project activities.
- **Clearly define project objectives** in ecological as well as socioeconomic terms. Identify the various social, economic, political and scientific interests that need to be reconciled (i.e. the trade-offs) in order for these project objectives to be realized.
- **Develop social, economic and ecological criteria for project site selection.** Be prepared to carry out extensive pre-feasibility work prior to final site selection. Recognize that little can be achieved without *strong local political commitment* to project objectives and the existence of an *adequate policy and legal framework*.
- **Mobilize a wide array of human and organizational resources.** Engage and encourage collaboration among NGOs, universities, and government agencies. Be prepared to support the strengthening or reorientating of NGOs to improve their effectiveness. Invest heavily in training people.
- **Carry out projects in a spirit of applied research and adaptive learning,** moving often between the drawing board and field testing, making adequate provision for the analysis and communication of results. Involve professional researchers. Explicitly identify the hypotheses that projects are exploring. Acknowledge and learn from failures. Disseminate findings on a timely basis and share information among projects.
- **Conduct extensive ecological and socio-economic baseline studies** to (1) understand local systems, including their external linkages and dependencies, and (2) provide a basis for monitoring changes in key variables during project implementation.
- **Develop new quantitative and qualitative techniques and indices for monitoring and evaluation** (including participatory evaluations) to measure progress against project objectives, to guide project management, and to assess progress toward *sustainability* once external project support is withdrawn.
- **Assess the biodiversity impact of all investments and project interventions designed to generate local economic incentives for conservation.** Ensure an adequate balance between positive incentives (investments in social and economic development) and negative incentives (policing and enforcement) for conservation. Pay attention to *who* benefits, *how* they benefit, and *how much* they benefit from project development activities.

Source: Adapted from Wells (1995).

In Mount Kulal Biosphere Reserve, Kenya, incentives developed in consultation with local pastoralists include: legally registering tribal rangelands; water-resource development subsidies; banking facilities as a savings alternative to cattle; providing security against cattle raids by other tribes; conservation education; employment in protected areas; and income from tourism.

In the Cross River National Park, Nigeria, funds are being established to encourage local people to participate in park protection and management. A revolving credit fund will mitigate the effects of credit rationing on neighbouring farmers, providing they invest in activities that are supportive of the park. A crop-loss compensation fund will compensate farmers for damage done by species such as elephants that are protected by the park (Caldecott 1992).

Some of the most innovative uses of economic

incentives come from South Africa, where different agreements have been reached with people surrounding protected areas. These agreements include profit sharing, resource utilization, the preservation of traditional ceremonies, and the creation of local employment. Proceeds from the lease of a tourist lodge in the Mthethomusha Game Reserve are paid into a trust fund to be used for community projects selected by tribal authorities. In Richtersveld National Park, the land on which the park lies is owned and occupied by a Nama community that has leased it to the government but has retained rights to graze an agreed number of livestock and to the controlled harvesting of natural products. The lease funds are deposited into a fund, with trustees appointed by the community (Anderson 1992).

In Namibia, game populations have been conserved by giving ownership rights to ranchers, thus providing

landowners with a financial incentive to protect the animals. Prospective hunters negotiate fees directly with the landowners. As a result of this simple incentive, some protected species have now increased in numbers, and breeding stock are being sold to landowners at subsidized prices. This approach has proved successful with black rhinoceros, which ranchers perceive as a prestigious animal to have on their property (Joubert 1992).

Some African countries are considering ways of providing economic incentives to private enterprises to conserve biodiversity. In Zambia, for example, private enterprise has taken over the management of Kasanka National Park. About 100 local people have been hired and community projects have been launched to offset local peoples' lost access in the park to fish and meat (Farmer 1992). The South African National Heritage Programme encourages farmers to register their land as heritage sites. Sponsored by a French company, the programme provides management advice and financial support to help owners maintain or enhance the sites. Over 150 sites, some of outstanding conservation value, had been registered by 1992 (Cohen 1992).

13.5.3.2 Conserving and using non-timber forest products

Considerable debate has developed over the possibilities and limits of profitable and sustainable harvesting of non-timber forest products as an economic incentive for conservation (Coradin and Lleras 1988; Nepstad and Schwartzman 1992; Plotkin and Famolare 1992; Clay and Clement 1993; Corry 1993; Clay 1994). Critics argue principally that:

1. subsidies are virtually always necessary for non-timber forest products to compete in international markets; and
2. unrealistic expectations have been created in local communities regarding potential economic benefits from marketing non-timber forest products, leading to disappointment and mistrust (Coradin and Lleras 1988; Corry 1993).

Proponents respond by arguing that:

1. subsidies may not be needed when effective marketing strategies are used to emphasize the rarity, authenticity and social contributions that characterize such products; and
2. such programmes should be judged, at least initially, on broad grounds since they provide communities with income, access to technologies, training and management skills, and the value of a standing forest (Plotkin and Famolare 1992; Clay 1994).

However, the extent to which the marketing of non-timber forest products contributes to biodiversity conservation is far from clear.

Exploitation of marketable biological products includes edible fruits, oils, latex, fibres, medicines, bushmeat, hunting trophies, construction materials, and so on (see, for example, de Beer and McDermott 1989; Falconer 1990). But the economic value of a sustainable flow of non-timber forest products is very difficult to establish (Godoy and Bawa 1993). de Beer and McDermott (1989) estimated that exports of non-timber forest products from Thailand were valued at approximately US\$15 million in 1982 (see Figure 13.5-1). Reviews of studies world-wide have suggested mean yearly market values of about US\$50 million (Godoy *et al.* 1993) and US\$70 million (Lampietti and Dixon 1995).

In economic terms, the attractiveness of harvesting these products commercially depends on their opportunity costs, i.e. the economic benefits from the next-best alternative. In the case of tropical forests, this is often logging and/or conversion to agriculture. But sustainable exploitation limits for biological resources are difficult to determine in ecological terms and difficult to regulate without enforceable local access and ownership rights. Without soundly based and enforceable harvesting limits, local communities may not be able to derive increased economic benefits from – or perceive any incentive for – conservation or sustainable use of non-timber forest products (see Box 13.5-5).

Extractive reserves managed by local communities in Brazil are often promoted as an effective way of sustainably harvesting non-timber forest products. But the applicability of this approach depends on many different factors. These include the political power of the rubber-tappers' union, the interests of local cattle ranchers, the market demand for rubber products, the abilities of communities to get their products to market, and so on (Browder 1992). Until these and other influences are understood, it will be unclear whether the use of non-timber forest products will be economically sustainable. In isolation, a local community may be able to meet their economic needs and aspirations; but when national or international markets or politics intervene, they may no longer be able to do so (Robinson 1993).

13.5.3.3 Ecotourism

Ecotourism has a substantial and well-publicized potential to boost local and national economies, provide long-term local employment, and generate new funds for conservation – all without damaging biodiversity (Boo 1990; Lindberg and Hawkins 1993; Brandon 1995a). But excessive visitation continues to cause serious damage to biologically diverse and fragile areas, and ecotourism's financial and economic potential has remained largely unrealized – except by commercial travel operators. Particularly in developing countries, there is an acute need for careful analysis of ecotourism to identify appropriate policies that can:

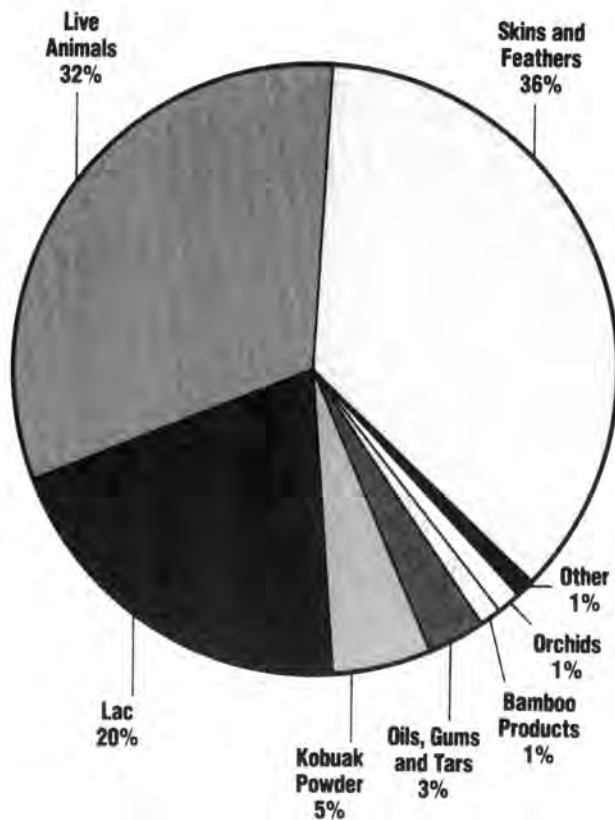

Figure 13.5-1: Exports of non-timber forest products from Thailand in 1982. (Source: DeBeer and McDermott 1989.)

1. capture a greater proportion of ecotourism's economic benefits locally and nationally;
2. regulate visitors' adverse environmental and cultural impacts; and
3. provide additional funds for biodiversity conservation.

Developing countries' governments have been reluctant to invest adequately in the management and protection of the natural and cultural assets (such as parks and reserves) that attract ecotourists. Often, so little of the economic value of ecotourism is captured by the host country that these assets are perceived as being of inconsequential value, and there is little political support for financing their management (Wells 1993).

But there are several countries that are extremely popular ecotourism destinations where this is clearly not the case. In Nepal, for example, simple calculations show that the total economic benefits attributable to parks-related ecotourism are significantly greater than the direct costs incurred by the government in maintaining the protected area network. Despite the greater overall benefits to parks from ecotourism, the direct cost of park protection and management – i.e. the conservation agency's budget – is more than ten times larger than the actual amounts collected as park entry fees. The government's neglect of Nepal's parks may therefore be based on the illogical view

Box 13.5-5 Rattan cultivation in Indonesia.

Rattans are one of the most important forest products in Southeast Asia. They have been used for centuries in binding, basketry and weaving, and are now a major source of cash income (de Beer and McDermott 1989). Managed rattan harvesting is an attractive candidate in forest conservation and local development efforts because these plants have a wide range of traditional uses, are an important source of cash income, and have little or no effect on other forest flora and fauna when harvested. However, wild supplies are likely to be exhausted without management.

The forests of Kerinci-Seblat National Park, Indonesia contain about US\$15.80 unprocessed *Calamus exilis* rattans per hectare, based on 1990 market prices. Collectors report that these plants can be harvested annually once they have reached three years of age. The potential value of sustained-yield harvesting is about US\$5 per hectare per year. This is very low in comparison with the earnings from cash crops such as cinnamon and coffee, which can earn farmers about US\$1000 per hectare per year on cleared forest land. But as a source of wages, rattan collection, at US\$1.50 per day, is more attractive than general agricultural work, at \$1 per day.

These data seem to confirm that rattan is currently being exploited at a rate many times greater than it can replenish itself. But sustainable rattan harvesting could be made more attractive to local communities by improving cane processing techniques (for example, the use of simple, inexpensive machinery to remove silica cane sheaths) and thereby improved product marketing. Rattan handicraft and basket-making already provide more than 70 families with their main cash income. Managed rattan gathering may be an important component in conserving Kerinci-Seblat National Park.

Source: Siebert *et al.* (1994).

that the country's parks are a money-losing enterprise (Wells 1993). Similar studies would almost certainly reach similar conclusions in Costa Rica, Ecuador, Kenya, Tanzania and several Caribbean islands.

Although developing-country governments often assert that the objective of tourism is to maximize foreign exchange earnings, surprisingly little consideration has been given to the question of whether government revenues from tourism could or should be substantially increased through higher fees and charges. At least part of any increase in revenues should logically be reinvested in the

conservation and management of the natural and cultural assets that attract tourists, and upon which the sustainability of the industry and its accompanying foreign exchange benefits presumably depend (Wells 1993). With a few notable exceptions, governments appear reluctant to increase visitor fees substantially, perhaps not wishing to risk deterring some visitors and thereby reducing the total number of tourists.

But maximizing tourist numbers may not be the best strategy. Depending on the demand for tourist attractions, total revenues may in fact be maximized by reducing tourist numbers and increasing their per-capita expenditures (Lindberg 1991). Simple, low-cost, survey-based research studies can be used to estimate demand curves for parks-based tourism and thereby either justify or help to eliminate fears of losing tourist revenues through higher charges (Lindberg 1991; Tobias and Mendelsohn 1991).

The unrealized potential of ecotourism to contribute to biodiversity conservation or economic development in many developing countries may be linked to some key policy issues:

1. The value of protected area tourism has been substantially underestimated by governments and a less-than-optimal investment made in park management.
2. Very little of the economic value of ecotourism is being appropriated by the host countries, either in terms of public sector revenues or in local employment opportunities (Wells 1993).

The examples that follow illustrate how ecotourism can act as an effective economic incentive for conservation in a variety of circumstances.

Ecotourism in the Caribbean. Tourism is the number-one industry for most Caribbean states. Spending by tourists contributes 80% of the gross domestic product of the British Virgin Islands and Antigua/Barbuda, and 50% or more in Anguilla, the Cayman Islands, the Bahamas, St Kitts and Nevis, and the US Virgin Islands (Blomenstein 1993). Most Caribbean states have established protected areas to conserve biodiversity. In 1988, there were 135 legally established protected areas in the Greater Caribbean Basin. But increasing tourism use is imposing considerable pressure on these parks and reserves, most of which have modest budgets. Are there ways to combine effective protected-area management with increased economic activity, in this case tourism? Dixon and van't Hof (1995) describe examples suggesting that there are.

The Virgin Islands National Park (VINP) is well funded by Caribbean standards, one of the benefits of being part of the US National Park System. The 25 000 acre VINP has underwater snorkelling trails, numerous beaches, bays and cays, mangrove areas, and the Virgin Island Biosphere

Reserve Center. The park is popular with hotel visitors, and yacht and cruise ship visitors. A pioneering study found that 450 000 VINP visitor-days in 1980 generated US\$23.4 million for the island economy, while annual management costs were only about US\$2 million (Posner 1981). More recent data confirm the growing importance of the park to the local economy, with the number of recreational visits almost doubling to 800 000 by 1988, and luxury hotels being constructed within reach of the park. Such levels of tourism have had some negative environmental impacts on VINP, with boat groundings and anchor damage becoming an increasing problem. But the park has been awarded monetary damages as a result of lawsuits over cruise ship damage of the park's reefs. Overall, effective, well-funded park management has permitted increased levels of tourism to provide dramatic local economic benefits (Dixon and van't Hof 1995).

The Bonaire Marine Park was established in 1979 but immediately ran into financial difficulties. The international diving media opposed the introduction of user fees, and government funds for management were soon exhausted. Local dive operators then worked as volunteers for several years to provide informal management. But in the early 1990s, growing realization of the need to protect coral reef ecosystems resulted in the Dutch Government's providing a grant and the Bonaire government approved an annual US\$10 admission fee to the park. These fees raised US\$170 000 in 1992, the first year, sufficient to meet the park's operating and maintenance costs. These fees are being used only to support education and research programmes, to improve mooring systems, and to enforce park regulations. Enthusiastic reporting by leading diving magazines in the United States has since led to rapid growth in the number of dive visitors. Use of the Bonaire Marine Park now appears to be approaching its carrying capacity. Additional monitoring is under way to explore whether this capacity can be increased through better management and diver education. Diver fees should be adequate to meet future park management costs (Scura and van't Hof 1993).

Other Caribbean marine parks have introduced user fees to help pay for improved management. The Saba Marine Park charges \$2 per dive, plus mooring/anchorage fees averaging US\$2 to US\$3 per person. The Hol Chan Marine Reserve in Belize has obtained the support of local communities and is charging snorkellers and divers a modest US\$1.50 user fee. Several other marine parks in the region are now considering similar fees to help protect their marine resources, thus helping to meet both economic and ecological goals (Dixon and van't Hof 1995).

Community-based ecotourism. Capirona in Ecuador is an indigenous Quechua community of 24 families that has developed its own small-scale tourism industry. Most of

the community raise their own food in garden clearings. They also hunt, fish and grow some cash crops. Many of the residents had experience working as guides and cooks in a nearby town that catered to tourists visiting Ecuadorian rain forests. In 1989, they decided to market their town and create a small tourist industry using their own resources. The community felt that tourism could be a viable economic and culturally sensitive activity, but only if they controlled the project themselves and if the whole community benefited. A small guest-house was built near the village centre, where visitors can stay for up to six days. The people of Capirona share their traditions through a cultural exchange programme. Local guides show tourists the native uses of forest plants and animals, and describe the realities and challenges of their everyday lives. In addition to the income generated for guides and cooks, tourism revenues have also financed projects at the community school and in health care (Brandon 1995a).

This enterprise benefited from effective marketing by regional and national Indian organizations and by travel agents in Quito. The Federation of Indian Organizations of the Napo (FOIN) helped train community members in taking care of visitors and managing a small business. FOIN also found an Indian botanist to help mark out trails and label trees with scientific, Spanish and Indian names. The number of visitors has expanded from 50 in 1989 to 300 by 1994. Residents of Capirona are now helping other communities launch similar projects (Brandon 1995a).

This entire enterprise was initiated and financed by the community. It is managed by local people for the community's benefit. Tourism diversifies the local economic base and supplements local incomes. Local people feel they have improved their own situation, and helped protect their own culture. But the community is not dependent on tourism, and remains free to choose whether, or how, to continue. The Capirona case shows the importance of national organizations in providing training and technical assistance, and shows how communities adopt practices that have been demonstrated to work well for their neighbours (Brandon 1995a).

Ecotourism in conservation areas. The 4600 km² Annapurna Conservation Area, Nepal may be the most geographically and culturally diverse protected area in the world. About 40 000 people of diverse ethnic backgrounds inhabit the area, where agriculture and trade have flourished for hundreds of years. Most of these people are poor rural farmers. Tourism has grown rapidly and more than 40 000 foreign trekkers now visit the area each year. A proliferation of small tea shops and lodges has developed in villages to cater to these visitors. During the last two decades, large areas of forested land have been cleared to provide fuelwood for use in cooking and heating for visitors. Expanding agriculture, water pollution, poor

sanitation, and littering on trekking routes have all accelerated (Bunting *et al.* 1991).

A six-month survey of local villagers revealed that establishment of a national park would meet resistance and hostility, a reaction amply justified by the history of many of Nepal's other protected areas. An alternative was clearly needed (Sherpa *et al.* 1986). Eventually, the multiple-use Annapurna Conservation Area was established in 1986 (see Figure 13.5-2). Its programme specifically allows hunting, collection of forest products, use of visitor fees for local development, and the delegation of management authority to the village level. Management of the Annapurna Conservation Area Project (ACAP) was delegated to the King Mahendra Trust for Nature Conservation, Nepal's pre-eminent non-governmental organization.

The project objective is to help the inhabitants maintain control over their environment. Activities have included community development, forest management, conservation education, research and training. High priority was given to reducing the environmental effects of visiting trekkers and to increasing the local economic benefits from tourism. Training courses for lodge owners helped upgrade the quality of service, standardize menus and prices, and improve standards of sanitation and waste disposal. Lodges and expeditions were required to use kerosene inside the Conservation Area, with fuelwood use permitted for subsistence only. In a revival of a traditional organization structure, forest management committees have been established to enforce regulations (e.g. by fining poachers and controlling timber cutting). The government does not provide any staff or funds to manage this protected area.

ACAP has made significant progress in integrating tourism, local economic development and protected area management where local people are involved in both tourism and management of the protected area, and where the visitor entry fees are reinvested locally. Visitor entry fees generate about 4 million rupees (US\$160 000) annually for ACAP, and the project is approaching financial self-sufficiency (Wells 1993).

13.5.3.4 Private reserves and private land leasing

In many countries, privately or communally owned lands have tremendous biodiversity value. While protected area strategies are typically assumed to be synonymous with public land ownership and management, privately and communally owned lands can also be managed simultaneously to conserve biodiversity and to generate local economic benefits. Privately owned reserves and leasing of private lands for publicly managed conservation areas are two examples.

Privately owned reserves show how the private sector can be incorporated into a strategy of sustainable development and conservation. The number of privately owned reserves in Latin America has increased

substantially in the last ten years. Africa, on the other hand, has a long history of private lands used for tourism and sports hunting. A survey of private reserves in Latin America and Africa by Alderman (1994) explored the role of these reserves as a tool for conservation, development and education. This survey revealed the following:

- Private reserves generate substantial local employment, particularly those reserves that cater to ecotourism. For each 1000 visitor nights, between 32 and 40 employee-months were generated. This provides some empirical response to criticisms that nature tourism creates few jobs, and often not from local communities.
- While the costs of establishing private reserves are relatively high and depend largely on foreign investments, 75% of the reserves are either owned by nationals or are owned by partnerships between foreigners and locals. This depends on local laws. Costa Rica and Ecuador, for example, are atypical in that they allow foreigners to own land. Both countries have a large number of private reserves.
- Lack of government co-operation was reported as a problem by 63% of the reserves. The establishment of private reserves in some countries is hindered by laws that require landowners to clear forest lands rather than protect natural ecosystems.

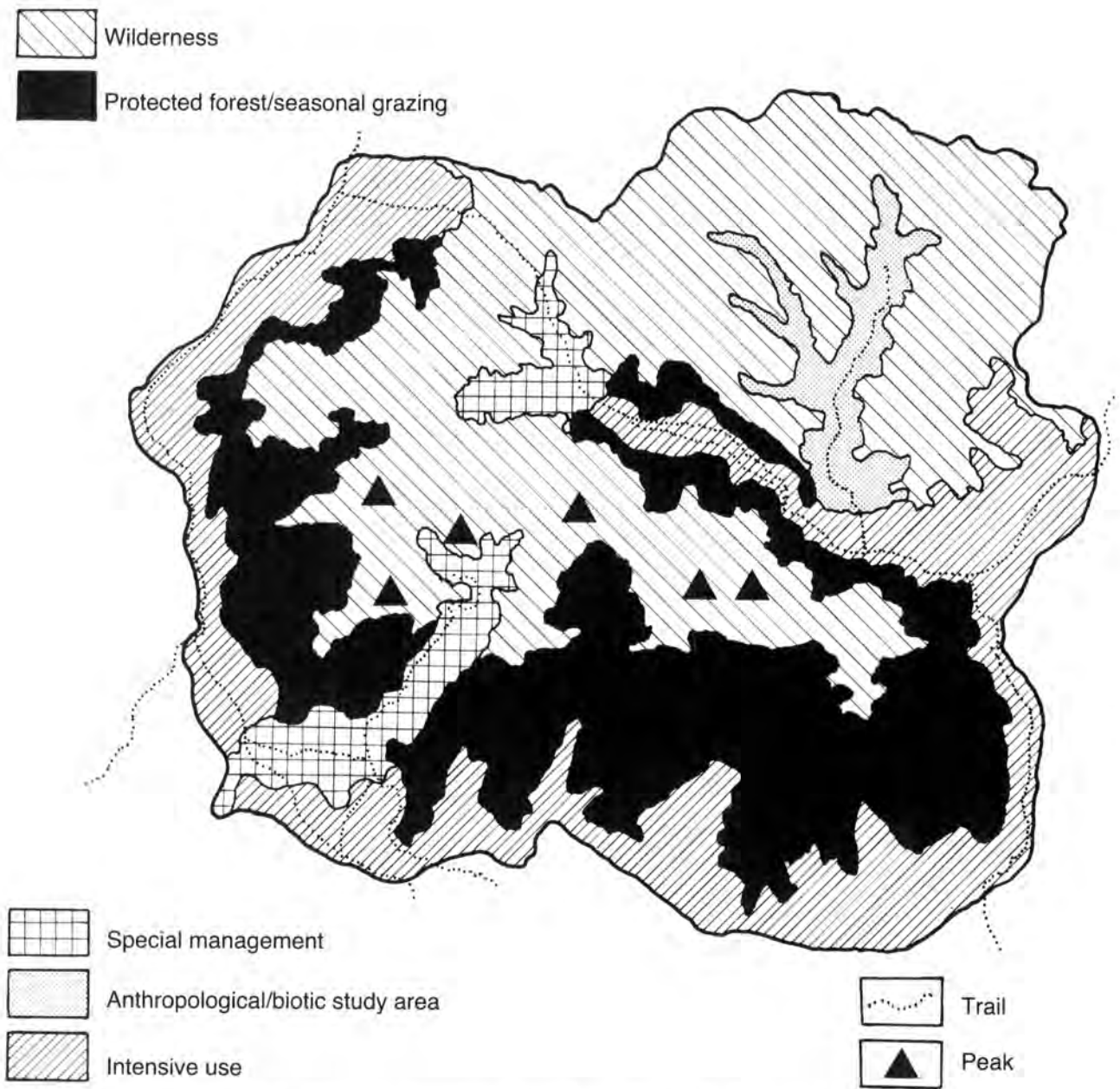

Figure 13.5-2: Land-use areas in the Annapurna Conservation Area, Nepal. (Source: McNeely *et al.* 1990.)

- About a third of the reserves have an agreement with government or private institutions to restrict future development of the land, in exchange for incentives such as lower taxes or commitments on the part of government not to appropriate the land. Such incentives can help make private reserves an attractive alternative to destructive uses of the land.
- Ecological importance is not the same as economic viability. Reserves with the highest ecological value are not necessarily the ones that do well financially. The economic success of private reserves is more dependent on factors such as accessibility, management, and the prevailing political situation.
- Economies of scale provide an incentive for private reserves to maximize their tourist visitation rates, yet this may stress the ecosystems contained within the reserves.
- Many private reserves indicated that they would like to implement habitat management plans, but did not have the resources or expertise to do so. This is clearly an area where conservation groups could become more involved in providing technical assistance. This need not be viewed as a subsidy to the private sector, but rather as an opportunity to develop mutually beneficial relationships.

Certain customary landowners in the Pacific island nation of Vanuatu have, in principle, recently agreed to lease their forested land to the government in order to establish the Erromango Kauri Protected Area. This agreement concluded a lengthy process of socioeconomic assessment and negotiation that explored different options for compensating the landowners. With financial support from the European Union, the Government of Vanuatu now plans to lease the land at the rate of US\$10 per hectare per year, initially for a five-year trial period. In return, landowners will not allow logging to take place in the protected area. If this arrangement is extended beyond the first five years, funding will be sought to establish a trust fund to meet the future lease payments (Tacconi and Bennett 1995).

The use of participatory rural appraisal techniques revealed that the area proposed for protection was only of very limited subsistence use to local villagers, being too far from their residences. But the lease agreement (drafted in the village of Happy Land together with the landowners, village chief, the representative of the youth, and the representative of the women) allows limited use of the protected area site for subsistence purposes. These activities would be regulated by a protected-area management committee essentially controlled by the customary landowners (Tacconi and Bennett 1995).

Attempts were made to simulate the landowners' economic choices. Discounting estimated logging royalties at 4%, it was found, would give returns comparable with the likely terms of the lease agreement, although the range and uncertainties inherent in the data were substantial. Other options were also discussed with the landowners. The government could, for example, with donor support, provide financial and technical support to develop income-generating activities in exchange for an undertaking by the landowners to protect the forest. The landowners pointed out that economic development would be constrained by the lack of a road and access to markets. Furthermore, the landowners preferred the steady income from a lease to the uncertainty of a comparatively risky income-generating project. No viable economic activity yielding short-term benefits could be identified for such a project. Therefore, the landowners opted for the lease agreement (Tacconi and Bennett 1995).

13.5.4 Conclusion

Locally-based conservation is, in some ways, a reaffirmation of traditional ways of thinking about resources and the natural world. As Western (1994) notes, the past is in many ways the future:

If conservation is to become embedded in our daily activities, nature and society must be intimately linked in our minds. This is a radical departure from the Western view of the separateness of Man and Nature – one that rekindles a holistic, ancestral way of thinking about our species in relation to the rest of the natural world. Research, knowledge and education will have a central role to play in the conceptual shift if we work on the premise that rural communities have as much to teach others as they have to learn about how to live in a more integrated world.

This doesn't deny the importance of viewing sustainability in global terms. But, virtually all approaches to biodiversity management cross important, locally defined socioeconomic terrain. Therefore, using social and economic incentives and tools that enable those people living closest to the resource to benefit equitably from the protection and sustainable use of biodiversity is indispensable. There is still much to learn about local socioeconomic factors in biodiversity management. This learning, and more importantly its incorporation into daily biodiversity management, is one of the most difficult and challenging aspects of conserving biodiversity and using it more sustainably.

References

- Alcorn, J.B. 1993. Indigenous peoples and conservation. *Conservation Biology* 7: 424–426.

- Alderman, C.L.** 1994. Economics and the role of privately-owned lands used for nature tourism, education and conservation. In: Munasinghe, M. and McNeely, J. (eds), *Protected Area Economics and Policy: Linking conservation and sustainable development*. 273–318. World Bank and World Conservation Union (IUCN), Washington, DC.
- Anderson, J.L.** 1992. Case studies of conservation agencies: Tribal neighbour agreements in South Africa. Paper presented at the IV World Congress on National Parks and Protected Areas, 10–21 February 1992, Caracas, Venezuela.
- Barber, C.V., Affif, S. and Purnomo, A.** 1995. *Integrating Biodiversity Conservation and Development: Lessons and strategies from Indonesia*. World Resources Institute, Washington, DC, and Indonesian Forum for the Environment (WALHI), Jakarta.
- Blomenstein, E.** 1993. Sustainable tourism in the Caribbean: Proposals for action. Report to the United Nations Economic Commission for Latin America and the Caribbean, Port of Spain, Trinidad and Tobago.
- Boo, E.** 1990. *Ecotourism: The potentials and pitfalls*. World Wildlife Fund, Washington, DC.
- Brandon, K.** 1994. Policy and practical considerations of land use strategies for biodiversity conservation.
- Brandon, K.** 1995a. Traditional peoples, nontraditional times: social change and the implications for biodiversity conservation. Paper prepared for the Nature Conservancy. Latin America program, the Nature Conservancy, Arlington, Va.
- Brandon, K.** 1995b. *Ecotourism Issues: A review*. Draft report for Global Environment Coordination Division, World Bank, Washington, DC.
- Brandon, K. and Wells, M.** 1992. Planning for people and parks: Design dilemmas. *World Development* 20: 557–570.
- Browder, J.D.** 1992. The limits of extractivism. *Bioscience* 42: 174–182.
- BSP.** 1995. Guidelines for monitoring and evaluation of Biodiversity Conservation Network-funded projects: Questions grantees need to address to assess the biological, social, political, and economic impacts of their projects. Biodiversity Support Program, Washington, DC.
- Bunting, B.W., Sherpa, M.N. and Wright, R.M.** 1991. Annapurna Conservation Area: Nepal's new approach to protected area management. In: West, P.C. and Brechin, S.R. (eds), *Resident Populations and National Parks: Social dilemmas and strategies in international conservation*. 160–172. University of Arizona Press, Tucson.
- Caldecott, J.** 1992. The Cross River National Parks Project, Nigeria: Implications for conservation in Borneo. Paper presented at the International Conference on Forest Biology and Conservation in Borneo, 30 July–3 August 1992, Kinabalu, Malaysia.
- Campbell, J.Y.** 1992. Joint forest management in India. *Social Change* 22 (1): 36–54.
- Cernea, M. (ed.)** 1991. *Putting People First: Sociological variables in rural development*, 2nd edn. Oxford University Press, New York.
- Chambers, R.** 1992. Rural appraisal: Rapid, relaxed and participatory. Discussion Paper 311, Institute of Development Studies. University of Sussex, UK.
- Clay, J.W.** 1994. *Generating income and conserving resources: Twenty lessons from the field*. World Wildlife Fund/US, Washington, DC.
- Clay, J.W. and Clement, C. (eds)** 1993. *Income-generating Forests and Conservation in Amazonia*. Forestry Paper. UN Food and Agriculture Organization, Rome.
- Cohen, M.** 1992. The South African Natural Heritage Program: a new partnership. Paper presented at the IV World Congress on National Parks and Protected Areas, 10–21 February 1992, Caracas, Venezuela.
- Cohen, J.M. and Uphoff, N.T.** 1977. Rural development participation: concepts and measures for project design, implementation and evaluation. *Rural Development Committee Monograph 2*, Center for International Studies. Cornell University, Ithaca, NY.
- Coradin, L. and Lleras, E.** 1988. Overview of palm domestication in Latin America. In: Balick, M.J. (ed.), *The Palm – Tree of Life: Biology, utilization and conservation*. Advances in Economic Botany 6: 175–189.
- Corry, S.** 1993. The rainforest harvest: Who reaps the benefit? *The Ecologist* 23: 148–153.
- Davis, S. and Wali, A.** 1993. Indigenous territories and tropical forest management in Latin America. Policy Research Working Paper Series No. 1100. World Bank, Washington, DC.
- de Beer, J.H. and McDermott, M.J.** 1989. *The Economic Value of Non-timber Forest Products in Southeast Asia, with emphasis on Indonesia, Malaysia and Thailand*. Netherlands Committee for IUCN, Amsterdam.
- Dixon, J. and van't Hoff, T.** 1995. Caribbean parks rate conservation. *Forum for Applied Research and Public Policy*.
- Durbin, J. and Ralambo, J.A.** 1992. The role of local people in the successful maintenance of protected areas in Madagascar. Paper presented at the IVth World Congress on National Parks and Protected Areas, 10–21 February 1992, Caracas, Venezuela.
- Falconer, J.** 1990. *The Major Significance of 'Minor' Forest Products: The Local Use and Value of Products in the West Africa Humid Forest Zone*. Community Forestry Note 6. FAO, Rome.
- Farmer, L.** 1992. The role of private enterprise in the sustainable management of the Kasanka National Park in Zambia. Paper presented at the IV World Congress on National Parks and Protected Areas, 10–21 February 1992, Caracas, Venezuela.
- Gadgil, M., Berkes, F. and Folke, C.** 1993. Indigenous knowledge for biodiversity conservation. *Ambio* 22: 151–156.
- GEF.** 1992. *Guidelines for Monitoring and Evaluation of GEF Biodiversity Projects*. Global Environment Facility Secretariat, Washington, DC.
- Godoy, R. and Bawa, K.** 1993. The economic value and sustainable harvest of plants and animals from the tropical forest: Assumptions, hypotheses and methods. *Economic Botany* 47: 215–219.
- Godoy, R.A., Lubowski, R. and Markandya, A.** 1993. A method for the economic valuation of non-timber forest products. *Economic Botany* 47: 220–233.
- Irvine, D.** 1989. Succession management and resource distribution in an Amazonian rain forest. *Advanced Economic Botany* 7: 223–237.
- Joubert, E.** 1992. Ownership of huntable game as an approach to conservation in Namibia. Paper presented at the IV World

- Congress on National Parks and Protected Areas, 10–21 February 1992, Caracas, Venezuela.
- Kiss, A.** (ed.) 1990. *Living with Wildlife: Wildlife resource management with local participation in Africa*. Technical Paper No. 130. World Bank, Washington, DC.
- Lampietti, J.A.** and Dixon, J.A. 1995. To see the forest for the trees: a guide to non-timber forest benefits. Environment Department Paper, Environmental Economics Series. World Bank, Washington, DC.
- Lindberg, K.** 1991. *Policies for Maximizing Ecotourism's Economic and Ecological Benefits*. World Resources Institute, Washington, DC.
- Lindberg, K.** and Hawkins, D.E. (eds) 1993. *Ecotourism: A guide for planners and managers*. Ecotourism Society, North Bennington, Vermont.
- Little, P. D.** 1994. The link between local participation and improved conservation: A review of issues and experiences. In: Western, D., Wright, M. and Strum, S. (eds), *Natural Connections: Perspectives in community-based conservation*. 347–372. Island Press, Washington, DC.
- Ludwig, D., Hilborn, R.** and Walters, C. 1993. Uncertainty, resource exploitation, and conservation: Lessons from history. *Science* **260**: 17–36.
- Mascarenhas, et al.** (eds) 1991. Participatory rural appraisal. RRA Notes 13. International Institute for Environment and Development, London.
- McNeely, J.A.** 1988. *Economics and Biological Diversity: Developing and using economic incentives to conserve biological resources*. IUCN, Gland, Switzerland.
- McNeely, J.A.** 1993. Economic incentives for conserving biodiversity – lessons from Africa. *Ambio* **22**: 144–150.
- Midgley, J.** 1986. *Community Participation, Social Development and the State*. Methuen, London.
- Mkanda, F.X.** 1992. The potential of Kasungu National Park in Malawi to increase income and food security in neighboring communities. Paper presented at the IV World Congress on National Parks and Protected Areas, 10–21 February 1992, Caracas, Venezuela.
- Nepstad, D.** and Schwartzman, S. 1992. Non-timber forest products from tropical forests: evaluation of a conservation and development strategy. *Advances in Economic Botany* **9**: 113–129.
- Oakley, P.** 1991. *Projects with People: The practice of participation in rural development*. International Labour Organization, Geneva.
- OECD.** 1994. Economic incentive measures for the conservation and sustainable use of biodiversity: conceptual framework and guidelines of case studies. *Environment Monographs No. 97*. Organization for Economic Cooperation and Development, Paris.
- Oldfield, S.** 1988. *Buffer Zone Management in Tropical Moist Forests: Case studies and guidelines*. IUCN, Gland.
- Paul, S.** 1987. *Community Participation in Development Projects: The World Bank experience*. World Bank Discussion Paper 6. World Bank, Washington, DC.
- Pimbert, M.P.** and Pretty, J.N. 1994. Participation, people and the management of national parks and protected areas: past failures and future promise. IIED and WWF Discussion Paper. International Institute for Environment and Development, London.
- Plotkin, M.** and Famolare, L. (eds) 1992. *Sustainable Harvest and Marketing of Rainforest Products*. Island Press, Washington, DC.
- Poffenberger, M.** (ed.) 1990. *Forest Management Partnerships: Regenerating India's forests*. Ford Foundation and the Indian Environmental Society, New Delhi.
- Poffenberger, M.** and McGean, B. (eds). 1994. *Proceedings of the Policy Dialogue on Natural Forest Regeneration and Community Management*. Asia Sustainable Forest Management Network Report No. 5. East-West Center, Honolulu, Hawaii.
- Posey, D.A.** 1985. Indigenous management of tropical forest ecosystems: the case of the Kayapo Indians of the Brazilian Amazon. *Agroforestry Systems* **3**: 139–158.
- Posner, B.** 1981. *Economic Impact Analysis for the Virgin Islands National Park*. Island Resources Foundation, St Thomas, US Virgin Islands.
- Pretty, J.N.** 1994. Alternative systems of inquiry for sustainable agriculture. *Institute of Development Studies Bulletin* **25** (2): 19–30.
- Redford, K.H.** and Sanderson, S.E. 1992. The brief, barren marriage of biodiversity and sustainability. *Bulletin of the Ecological Society of America* **73** (1): 36–39.
- Redford, K.H.** and Stearman, A.M. 1993. Forest-dwelling native Amazonians and the conservation of biodiversity. *Conservation Biology* **7** (2): 248–255.
- Robinson, J.G.** 1993. The limits to caring: sustainable living and the loss of biodiversity. *Conservation Biology* **7**: 20–28.
- Salmen, L.F.** 1987. *Listen to the People: Participant-observer evaluation of development projects*. Oxford University Press, New York.
- Sayer, J.** 1991. *Rainforest Buffer Zones: Guidelines for protected area managers*. IUCN, Gland.
- Scura, L.F.** and van't Hoff, T. 1993. *Economic Feasibility and Ecological Sustainability of the Bonaire Marine Park*. Environment Department Working Paper 44. World Bank, Washington, DC.
- Shah, P.** 1992. Participatory watershed management programmes in India: reversing our roles and revising our theories. Paper presented at the Beyond Farmer First: Rural People's Knowledge, Agricultural Research and Extension Practice conference, 27–29 October 1992. International Institute for Environment and Development, London.
- Sherpa, M.N., Coburn, B.** and Gurung, C.P. 1986. *Annapurna Conservation Area, Nepal: Operational plan*. King Mahendra Trust for Nature Conservation, Kathmandu.
- Siebert, S., Belsky, J.** and Rauf, K. 1994. Rattan management for sustainable livelihoods and forest conservation: the case of Kerinci-Seblat National Park, Indonesia. In: Munasinghe, M. and McNeely, J. (eds), *Protected Area Economics and Policy: Linking conservation and sustainable development*. 125–132. World Bank and World Conservation Union (IUCN), Washington, DC.
- Soulé, M.E.** 1991. Conservation: tactics for a constant crisis. *Science* **253**: 744–750.
- SPWD.** 1992. Joint forest management: concept and opportunities. Proceedings of a workshop at Surajkund, India, August 1992. Society for the Promotion of Wastelands Development, New Delhi.

- Stone, R.D.** 1991. *Wildlands and Human Needs: Reports from the field*. World Wildlife Fund, Washington, DC.
- Tacconi, L.** and Bennett, J. 1995. Biodiversity conservation: the process of economic assessment and establishment of a protected area in Vanuatu. *Development and Change* **26**: 89–110.
- Tilakaratna, S.** 1987. *The Animator in Participatory Rural Development: Concept and practice*. World Employment Programme Technical Cooperation Report. International Labor Office, Geneva.
- Tobias, D.** and Mendelsohn, R. 1991. Valuing ecotourism in a tropical rain-forest reserve. *Ambio* **20** (2): 91–93.
- UNDP/UNEP/World Bank.** 1994. *Global Environment Facility: Independent evaluation of the pilot phase*. World Bank, Washington, DC.
- Uphoff, N.** 1987. Approaches to community participation in agriculture and rural development. In: Economic Development Institute (ed.), *Readings in Community Participation, Vol. 2*. World Bank, Washington, DC.
- Uphoff, N.** 1991. Fitting projects to people. In: Cernea, M. (ed.), *Putting people first: Sociological variables in rural development*, 2nd edn. 176–511. World Bank, Washington, DC.
- Wells, M.** 1992. Biodiversity conservation, affluence and poverty: mismatched costs and benefits and efforts to remedy them. *Ambio* **21**: 237–243.
- Wells, M.** 1993. Neglect of biological riches: the economics of nature tourism in Nepal. *Biodiversity and Conservation* **2**: 445–464.
- Wells, M.** 1994. The Global Environment Facility and prospects for biodiversity conservation. *International Environmental Affairs* **6**: 69–97.
- Wells, M.** 1995. Biodiversity conservation and local development aspirations: New priorities for the 1990s. In: Perrings, C., Mäler, K.G., Folke, C., Holling, C.S. and Jansson, B.O. (eds), *Biodiversity Conservation: Problems and policies*. 319–333. Kluwer Academic Press, Dordrecht.
- Wells, M.** and Brandon, K. 1993. The principles and practice of buffer zones and local participation in biodiversity conservation. *Ambio* **22** (2–3): 157–162.
- Wells, M.,** Brandon, K. and Hannah, L. 1992. *People and Parks: Linking protected area management with local communities*. World Bank, US Agency for International Development and World Wildlife Fund, Washington, DC.
- West, P.C.** and Brechin, S.R. (eds) 1991. *Resident Peoples and National Parks: Social dilemmas and strategies in international conservation*. University of Arizona Press, Tucson.
- Western, D.** 1994. Visions of the future: the new focus of conservation. In: Western, D., Wright, R.M. and Shrum, S.C. (eds), *Natural Connections: Perspectives in community-based conservation*. 548–556. Island Press, Washington, DC.
- Western, D.,** Wright, M. and Strum, S. (eds) 1994. *Natural Connections: Perspectives in community-based conservation*. Island Press, Washington, DC.
- World Bank.** 1994. *Guidelines for Incorporating Social Assessment and Participation into Biodiversity Conservation Projects*. Environment Department, The World Bank, Washington, DC.
- WRI/IUCN/UNEP.** 1992. *Global Biodiversity Strategy: Guidelines for action to save, study, and use the Earth's biotic wealth sustainably and equitably*. World Resources Institute, Washington, DC.

13.6 Legal measures for sustainable use and protection of biodiversity

13.6.1 Introduction

Most nations are parties to one or more international treaties of relevance to biodiversity. All are required to take action at the national level to implement their obligations. In particular, the Convention on Biological Diversity – the only global biodiversity-related treaty to take a comprehensive approach – places its main emphasis on action at the national level. Legal measures are critical tools for countries seeking to maintain their diversity, regardless of their status as parties or non-parties to international agreements (de Klemm and Shine 1994).

Chapter 13.6 considers the legal measures that can be used to regulate activities that have adverse impacts on biodiversity; to create the legal basis for implementing technical, social and economic incentives or voluntary measures to sustainably manage and protect biodiversity; and to develop combinations of regulatory and voluntary approaches. Legal measures are considered in the context of traditional legal systems and modern legal systems used at national and international levels. The chapter concludes with a brief look at the most relevant global treaties concerned with biodiversity.

Conservation often requires that the activities of people be regulated or directed. This may be achieved by legal dictates or by incentives that rely more on voluntary measures. Law has an essential role to play in both cases.

Laws regulating the use of living resources have principally been concerned with protecting the interests of humans and societies, and not with the inherent 'rights' or interests of nature itself. Pollution control legislation has as a priority objective the protection of human health, not biodiversity. Protected areas created by national governments were initially established more for public enjoyment than because of their richness in species, although the motivation of traditional societies, which created some of the earliest forms of protected areas, was varied.

As a consensus evolved around the need to preserve wild species and areas for their intrinsic value and for future generations, so did the number of laws enacted to preserve elements of biodiversity. However, constraints resulting from those command and control regulatory measures are often still perceived as illegitimate; nature from time immemorial has been considered as a free gift, especially in Western societies (although some restrictions such as

hunting licences may be a well-accepted practice in many developed and developing countries). Its destruction was not considered to affect any recognized human interest. Restrictions established for its conservation, moreover, impinge on rights that are often enshrined in constitutional provisions, such as free enterprise, property ownership and economic development. As a result, regulatory conservation measures are often unpopular and ineffective, yet these are still almost universally relied upon to protect species and ecosystems. In some traditional cultures, however, regulatory measures have been mutually agreed upon and mutually enforced by members of the community.

There is consequently a need for more legal incentives that promote voluntary action to complement or replace coercive legal restrictions. This was recognized in Article 11 of the Convention on Biological Diversity (CBD), which calls upon each contracting party to adopt incentive measures for the conservation and sustainable use of biodiversity. The need to achieve an appropriate balance between regulatory and incentive-based legal approaches is therefore even more urgent. The primary means of establishing regulation and creating economic and other incentives is through the legislative process. Legislation is essential for:

- conferring jurisdiction and powers on public bodies and local communities for conservation;
- instructing public bodies to carry out conservation measures;
- establishing and enforcing procedures (such as EIAs);
- providing for public participation;
- permitting NGOs or other organizations to sue in cases of non-compliance;
- providing incentives for conservation and disincentives to destruction;
- providing a legal basis for conservation contracts such as easements and management agreements, and for the equitable sharing of benefits; and
- implementing obligations under international agreements.

13.6.2 Customary and traditional legal measures

Long before national governments began to pass legislation and regulations concerning the conservation of biodiversity and the use of biological resources, traditional communities around the world already possessed a varied and complex store of customary law dealing with the same issues. The survival of these communities depended upon effective systems of husbanding biological resources. Traditional knowledge of and techniques for using biological resources may therefore provide valuable information ranging from effective management techniques to the pharmaceutical or agricultural applications of particular species. While many

traditional cultures have disappeared or been assimilated into dominant societies and economies, others continue to exist, albeit in varying degrees. In some cases, traditional legal systems used to manage biological resources in agriculture, forestry, fisheries and hunting (see 13.3 for traditional management practices) are still effective. And traditional legal systems may have features from which modern legal systems might benefit.

The Convention on Biological Diversity recognizes the links between indigenous and local communities embodying traditional life-styles and the conservation and sustainable use of biodiversity. The Convention – Article 8(j) – calls upon each contracting party to respect, preserve and maintain the knowledge, innovations and practices of these communities relevant to the sustainable use and conservation of biodiversity. It also encourages their wider application and the equitable sharing of benefits from their use.

Many remaining traditional cultural groups occupy areas of unusually high biodiversity, including the Amazon and Congo Basins, the interior of New Guinea, Borneo and other Southeast Asian islands, parts of Australia, Mexico and Central America, and many mountain areas in the Andes, Himalayas and elsewhere. Traditional cultures are not only often contiguous with the planet's remaining areas of high wild biodiversity; they are also custodians of a great deal of the planet's agricultural genetic diversity, in the form of local crop and livestock varieties. Customary law governing biodiversity is thus as complex and varied as the resources it seeks to protect.

13.6.2.1 The nature of customary law

While customary laws and legal systems vary from culture to culture, they generally share a number of characteristics that set them apart from the 'modern' legal orders that govern – at least in theory – behaviour in national legal and political systems. Most customary societies are structured by a single, integrated hierarchy of law, behaviour and authority – the same web of rules, authority and authority figures governs all aspects of life, from tenure to marriage, from spiritual matters to hunting restrictions.

Customary laws concerning biotic resources – despite their many variations – can often be found where land, water and their resources support a broad array of seasonally staggered activities. Some combination of long-rotation polyculture cultivation (swidden), hunting, fishing, herding and the collection of forest and marine products will tend to dominate over sedentary, intensive agriculture or the intensive exploitation of a few species for the market.

Some common characteristics of customary laws are that:

- Land, water territories, and their biotic resources have socio-religious significance, are closely

connected to the identity of the group, and cannot easily be separated from matters of kinship, authority and leadership, modes of subsistence, ritual and the supernatural.

- Individual, heritable rights in land (or water territories) exist, but most individual rights are either rights of use subsidiary to a superior group right, or rights to particular resources, such as tree or animal species, or rights to harvest a particular cultivated plot. Thus, land tenure and resources tenure are not necessarily the same, and one parcel of land is often encumbered with a variety of rights held by different persons and groups.
- Unworked land or waters are, for the most part, as encumbered by rights as individual garden plots. Rarely is any part of the land- and seascape in which the community lives considered 'empty'.
- Rights in land, waters, and their resources are rarely recorded in maps or written records, with the exception of ownership marks placed on trees and other discrete, individually owned resources. Borders are determined on the basis of natural features, such as rivers, and by mutual unwritten understandings.
- Limits are frequently set on the exploitation of particular resources – often regulated on a seasonal basis, and some areas and resources are often put completely off limits, as in the case of India's 'sacred groves'. There is little conceptual or practical separation, however, between concepts of 'use' and 'conservation' of living resources.

All of these generalizations have exceptions, and few societies now live wholly within a customary system. Nevertheless, even as many people and institutions throughout the world grapple with the task of slowing biodiversity loss – and finding the legal tools to do so – there is still a great deal to learn from systems of customary law.

People in modern societies, by contrast, live in and are governed by a variety of hierarchies, each with its own set of norms and expectations. In one's home, car, workplace or place of worship, a different set of norms and laws – customary and otherwise – apply, and behaviour must be adjusted accordingly.

The hierarchies a person lives under are integrated and interrelated in varying degrees. Related to this is the distinction drawn by Dasmann between 'ecosystem people' and 'biosphere people' (Dasmann 1988). Ecosystem people are those, in Gadgil's (1993) formulation, who 'obtain most of the resources they use from a restricted catchment either

by gathering or through low-input agriculture and animal husbandry'. Biosphere people are those who 'participate in the global market economy which gives them access to resources from all over the earth'. To these two groups, Gadgil (1993) notes, must be added a third group of 'ecological refugees', most of whom are ecosystem people who have been deprived of their resource base. Indeed, Attali (1991) has argued that in the next century, biosphere people and ecological refugees will be the only remaining categories, which he terms 'rich nomads' and 'poor nomads'.

13.6.2.2 Examples of customary law and biodiversity

Existing interdependently with their immediate natural environment, traditional cultures have developed diverse and complex systems to regulate their members' uses of living resources. Following are just a few brief examples; thousands have been documented, and many thousands more are likely to exist, or have existed in the recent past.

In the mountains of Nepal, close to the tree line, the Sherpa people utilize a system called *shinga naua*, in which several men from a village are elected to protect the local forest. These traditional forest guards have the power to prevent cutting of protected forests, determine where trees may be cut, inspect firewood stocks in people's houses, and levy fines for transgressions (McNeely 1989).

In Thailand, traditional communities have evolved numerous methods of conserving local forests, including ancestral spirit and temple forests, and for forest patches conserved for watershed and soil protection. The customary laws that protect these forests are accepted by the community because they are part of the culture and because every village member has a role in enforcing them. Transgressions are dealt with through fines, penalties or in many cases through social pressures (Amornsanguansin, undated).

In Orissa and other tribal parts of India, a variety of customary restrictions in the past ensured that the forests were not over-exploited. They included restrictions confining exploitation to certain seasons, restrictions based on certain stages of a species' life-cycle, bans on cutting certain sacred species, limits on quantities to be exploited, and complete bans on harvesting from certain areas. Such traditions have, however, been substantially eroded (Fernandes 1988). Similarly, the Gorowa of Tanzania and the Gabra of Kenya protect ancient forest groves as sacred sites (Durning 1992).

In Papua New Guinea, customary land tenure systems specify who may use, inhabit, harvest, collect or hunt from the forests, as well as where, when and under what circumstances (Iamo 1992; Taylor 1994). State recognition of customary land and resource tenure systems is most developed in Papua New Guinea and a number of South Pacific island nations. Neighbouring Indonesia's Irian Jaya province, for example, possesses numerous traditional systems for regulating forest use, but traditional (*adat*) law is not recognized by national forestry law and policy (Barber

and Churchill 1987). In the dry zone areas of Sri Lanka, where paddy cultivation was carried out with the aid of rain water collected in tanks, a system regulated the distribution of irrigation water during periods of drought. During such periods, the area of land that could be harvested with the aid of the remaining water was determined for the entire village in proportion to their ownings of the entire paddy land.

No less common are customary law systems governing conservation and use of fisheries and other marine resources (Maragos 1992). In Indonesia's Molucca islands, the *sasi* system of customary restrictions on the harvest of various marine species ensures their survival (Zerner 1994). Throughout the Pacific islands, traditional systems of reef tenure and harvest management have long supported sustainable use and conservation (Simmonds 1992). And on Borneo's Kapuas River, traditional communities have developed a system for controlling the harvest of valuable red Asian arawana fish (Bailey 1990). In some parts of Sri Lanka, complex systems of rules governing the harvest of marine resources remain in place, for example the total ban on prawn harvesting during the breeding system in the Baticaloa lagoon.

13.6.2.3 Customary law in transition

Customary systems of resource management and resource law work best under low population densities, without significant external market involvements, with traditional technologies, and where traditional systems of authority – and authority figures – remain strong. Such conditions are becoming less common at the close of the twentieth century. Everywhere customary societies are breaking down as their natural resources are appropriated by governments, corporations and migrants; the seemingly inevitable assimilation into the global economy and culture is felt in virtually every corner of the planet.

Any number of well-established civilizations in human history have vanished because they could not adapt to the pressures of rapid change. Never has change been as rapid as it is at present, and it seems inevitable that many traditional cultures, their knowledge, and their systems of customary law, are bound to vanish before the close of the next century, some well before that. Yet, there are some traditional cultures that have been able to adapt and accommodate the pressures and opportunities of modernity, and in doing so maintain modified systems of customary law that continue to protect biodiversity. Some national legal systems, such as that of Papua New Guinea, have also expressly recognized the legitimacy of traditional legal systems involving resource management, even as those traditional systems strive to adapt to changing circumstances (Lynch 1992).

13.6.3 National legislation

All countries have formal legal systems and nearly all have legislation, policies and legal procedures that govern the

protection, use and management of natural resources, including living resources. These measures vary widely among countries and often within countries where jurisdiction or authority over natural resources is shared with state/provincial and local governments. There are, however, broad categories of regulatory and non-regulatory legal measures to support the sustainable use and protection of biodiversity.

While leaving the details to individual contracting parties, the Convention on Biological Diversity nevertheless calls upon parties to take many of the general types of actions noted here. For example, Article 8(k) stresses the need to develop legislation or other regulatory measures for the protection of threatened species and populations. Without pre-judging the choice of action, cross-references to the convention will show the range of tools currently in use addressing the particular provision's concern.

13.6.3.1 Regulatory measures

Subject to any limitations established by constitutions, states have 'police powers' to control human activities in the general interest. Under these powers, laws and regulations may be enacted to prohibit or restrict specified activities, authorize them subject to permit, or require prior notification of proposed activities or projects. To date, these powers have mostly been used in relation to conservation to protect particular species or areas and, more recently, certain habitat types or landscape features. The Convention on Biological Diversity recognizes the importance of management or regulation at this level. The convention calls upon each contracting party to identify and monitor processes or activities likely to have significant adverse impacts on biodiversity (Article 7(c)) and to regulate or manage them (Article 8 (l)).

13.6.3.1.1 Species-orientated legal measures. Traditional hunting and fishing laws establish open and closed seasons, bag limits, prohibited taking methods and trade prohibitions or restrictions. Endangered species are protected by permanent closed seasons. However, hunting legislation is not usually applicable to non-game species, especially invertebrates and plants.

Species conservation laws have consequently been adopted by many countries in recent decades, and Article 8(k) calls upon countries 'to develop or maintain necessary legislation and/or other regulatory provisions for the protection of threatened species and populations'. These laws often contain long lists of protected species, including plants. Where they apply to non-game species, they can be difficult to enforce, especially for lesser-known species that may be difficult to identify except by a small number of specialists. They are, moreover, usually limited to taking and trade prohibitions, although a few go further.

The Spanish Act on the Conservation of Natural Areas and Wild Flora and Fauna (1989) requires the development of recovery plans for endangered species and habitat conservation plans for species listed as vulnerable to the alteration of their habitat. Plans are adopted by ministerial orders and include regulatory provisions binding on public agencies and the public. In Australia, the Commonwealth Endangered Species Protection Act (December 1992) contains requirements for federal endangered species recovery plans and threat abatement plans, and provides incentives for state and territorial governments to adopt similar plans. In Sri Lanka, the Fauna and Flora Protection Ordinance (as amended in 1993) relies on the precautionary principle and anyone seeking to alter critical habitat or 'take' protected species must prove that such actions will not harm the species.

The US Endangered Species Act (1973) requires that critical habitats of listed species be designated and that federal agencies ensure that actions authorized, funded or carried out by them are not likely to jeopardize the continued existence of these species or result in the destruction or adverse modification of their critical habitats. Federal agencies must conduct species conservation programmes and prepare species recovery plans.

In some jurisdictions (e.g. the United States and New South Wales, Australia), prohibitions on the taking of endangered species have been interpreted to include certain forms of habitat disturbance. This has resulted in a blurred distinction between species-based laws and area-based laws and, in the United States, has led to the restriction of development on both public and private land (Bradsen 1992). This interpretation with respect to private land was recently upheld in the US Supreme Court.

While species-based laws have had clear successes, they also have shortcomings. Laws that depend on substantial scientific proof of endangered conservation status and a concentration of financial resources on the recovery of a small number of species may not be suitable in many countries where both information and financial resources are limited. Unilateral actions to protect migratory species can also be ineffective when other countries fail to protect those species when they are within their jurisdiction, a problem that led to the Convention on Migratory Species.

13.6.3.1.2 Regulating use of protected areas. Within these areas, most activities are prohibited or restricted to ensure the long-lasting conservation of the ecosystems concerned. The continued existence of protected areas cannot be fully guaranteed by law since subsequent legislation may abolish a park or reserve. The disestablishment of a protected area may, however, be made more difficult than its establishment by the imposition of particular procedural constraints. For example, in New South Wales, Australia, an Act of Parliament is required to revoke a national parks designation.

The integrity of a protected area may be achieved through public ownership or regulatory measures. Under the former, the state or land-holding agency may prohibit or restrict activities by third parties on its lands. Further legislation is necessary to dedicate public lands exclusively to conservation, to bind government agencies to respect the integrity of the areas concerned, and to penalize illegal activities by third parties.

Legislation should facilitate government land acquisition for conservation purposes by instituting a right of pre-emption over land coming on the market, a right of compulsory purchase, and tax incentives for vendors. However, exclusive reliance on the public purchase of land for protected areas, as happens in several countries, has the obvious disadvantage of being expensive.

Regulatory measures applicable to both public and private lands are used elsewhere to establish protected areas, particularly in Europe where publicly owned land is scarce. While governments may restrict certain development activities by landowners in such areas, they cannot be forced to take additional positive measures to protect biodiversity.

Beyond the boundaries of protected areas, damaging activities must also be regulated to conserve those areas effectively. Buffer zones, in which specified activities are prohibited or restricted, are frequently established for this purpose, but these are insufficient if harmful processes are carried out farther afield.

The management of protected areas and the determination of powers conferred on their managing bodies is also a matter for legislation. Centralized management is characteristic of countries where parks and reserves are established on public lands. Protected area directors are appointed by the national administration and local interests are usually not represented in park management, although this is changing in some countries such as Zimbabwe and Kenya (see also 13.3.5 and 13.5.2.5).

Decentralized management is more usual where protected areas are established on private or municipally owned land. Management boards aim to represent all interests concerned and are composed of government officials and representatives of local authorities, scientific institutions, conservation NGOs, landowners and local economic interests. In France and Italy, these boards are corporate bodies with legal powers.

Legislation must make it possible to establish different zones within protected areas and to lay down basic rules and activity limitations applicable to each zone. Alternatively, management bodies may be given the necessary powers to incorporate these restrictions into a binding management plan.

In a few countries, the development of management plans is mandatory. In Australia, such plans are adopted

after a formal procedure and public consultations, and are binding upon public agencies and the public. The participation of local communities in designing and implementing protected areas is an important component of most successfully managed areas, and more attention should be given to how this can be effectively stimulated through legal provisions.

13.6.3.1.3 Other area-based legal conservation actions. Other, more flexible conservation instruments of a regulatory nature have been developed in recent decades for use in particular circumstances. Wilderness areas are established on large tracts of public land where certain activities, such as road building and the use of motor vehicles are prohibited.

Conservation orders are administrative decisions regulating certain activities in specified areas, but do not amount to an official nature reserve designation. The prohibitions or restrictions may be adapted to the conservation requirements of each area. This system is particularly well developed in Denmark.

Under the British system of Sites of Special Scientific Interest (SSSIs), all sites designated as SSSIs by national conservation authorities have a unique legal status. Where an activity (e.g. construction) requires a permit, the relevant authority must take account of that designation when granting or refusing a permit. In respect to all other activities, including agriculture or forestry, owners are notified of 'potentially damaging operations' likely to damage the site's fauna, flora or other features. A landowner cannot carry out any such operation without first notifying the conservation authority. The latter will usually seek a management agreement whereby the owner agrees to refrain from the proposed activity in return for a sum of money.

13.6.3.1.4 Land-use planning legislation. Land-use planning legislation has been enacted in many countries to protect economic, aesthetic and environmental values in rural and especially urban and suburban areas, although agriculture and forestry are widely exempted from land-use regulation. Certain planning systems are timidly evolving toward the better protection of natural areas. In Portugal, areas of particular ecological value or vulnerability (e.g. beaches, dunes, cliffs, estuaries, river beds, wetlands and mountain slopes) form part of the National Ecological Reserve and must be preserved by municipal land-use plans. All works and any destruction of vegetation cover are prohibited in those areas and forest exploitation and afforestation are subject to permits.

In many countries, land-use planning is the responsibility of local governments. There are two broad categories: comprehensive planning and environmental site planning. Comprehensive planning includes *anticipatory* mechanisms such as zoning to define appropriate land-uses and anticipate or direct certain types of development (McEvoy and Dietz 1977). Comprehensive land-use plans are

implemented through four basic instruments: (1) public acquisition, (2) public investment, (3) incentives and (4) regulation (see Figure 13.6-1).

Environmental site planning is a *reactive* approach that seeks to restrict or avoid adverse environmental impacts on a site-by-site basis by, for example, specifying where a septic field drain should be placed to avoid contaminating an adjacent waterway (Bickford 1991). Site planning relies principally on regulation. Cort (1995) analysed the effectiveness of various land-use planning initiatives in conserving habitat in a Florida county (see Table 13.6-1). She concluded that public acquisition of sensitive habitats was more effective than regulation.

13.6.3.1.5 Nature parks and protected landscapes. The legislation of an increasing number of countries provides for the creation of nature parks. Human activities are allowed within a park's boundaries if they are compatible with its objectives. Nature parks are usually zoned, and regulated activities vary between zones. Conventional protected areas such as nature reserves may be included as specially protected zones within the park.

The legal regime of nature parks varies widely. Some countries have few regulatory constraints. Others, like Spain, have strict rules on agricultural practices. The cultivation of forage crops, artificial grasslands, and afforestation with exotic species may be prohibited, and other forms of intensive agriculture made subject to a permit. All changes to the water regime are prohibited.

The law should ensure that the administrative body responsible for the nature park is closely associated with the park's management and that local inhabitants and interests are adequately represented. The powers of such

Table 13.6-1: Hectares conserved under recent land-use initiatives in Hillsborough County, Florida.

County intervention	Instrument	Hectares designated	Hectares conserved
Significant Wildlife Habitat	Regulatory	48 986 ^a	9.7
Upland Forest Density Bonus	Incentive	not specified	2
Acquisition of Sensitive Habitats	Voluntary purchase	18 108 ^b	5 383
Livestock Density Control	Regulatory	not specified	repealed

^a Between 1992 and 1994.

^b Between 1987 and 1993.

Adapted from Cort (1995).

bodies should be clearly defined to avoid jurisdictional conflicts with government departments or local authorities. The nature park concept has now developed beyond Europe to certain developing countries such as Mexico. Nature parks are well suited to implementing the UNESCO biosphere reserve model, as they promote biodiversity conservation while maintaining traditional activities, and may combine the use of voluntary measures with regulatory constraints.

13.6.3.1.6 Legal protection of representative habitat types. Denmark's Protection of Nature Act (1992) prohibits alteration to heaths, marshes, moors, salt marshes, coastal meadows, humid permanent grasslands and dry grasslands. Similar prohibitions apply to lakes of more than 100 square metres and watercourses designated by the Minister for the Environment. These prohibitions apply to any change in land use, including those made for agricultural purposes.

Other countries establish a permit requirement for activities that damage specified natural habitat types, such as wetlands (several countries), mangroves (Brazil and Venezuela), sand dunes (Brazil), riparian vegetation (many countries), and caves (Austria, Hungary, northern Italy). Some laws also protect specific landscape features, such as hedgerows. Australia's Endangered Species Act provides for the listing and protection of endangered biological communities, although none to date has been added to the relevant schedule of the Act. The Australian State of South Australia requires a permit for the clearing of any native

vegetation in its Native Vegetation Act of 1991. Applications for approval to clear vegetation must be accompanied by a native vegetation management plan. However, Schedule 1 of the Act delineates situations in which vegetation should not be cleared (e.g. unusually high levels of species diversity, erodibility, or potential for salinization).

The RAMSAR Convention is an international agreement intended to lead to the conservation of an international network of representative wetland ecosystems. Other international programmes, such as the World Heritage Convention and UNESCO's Man and the Biosphere Reserve Programme, are also designed to stimulate countries to protect, within their borders, habitats that are representative of the world's ecosystems.

13.6.3.1.7 Regulating processes and activities detrimental to biodiversity. Many processes and practices, such as agricultural chemical use or the introduction of species, can have widespread adverse impacts on biodiversity. Few of these processes, however, are regulated. Most regulatory approaches to conservation instead emphasize the restriction of certain activities within limited areas. Processes that are regulated most commonly include the use of pesticides and the introduction of species. New legislation on genetically modified organisms is aimed at the protection of humans, livestock and crops as well as biodiversity. Article 8(h) of the Convention on Biological Diversity encourages countries to control the

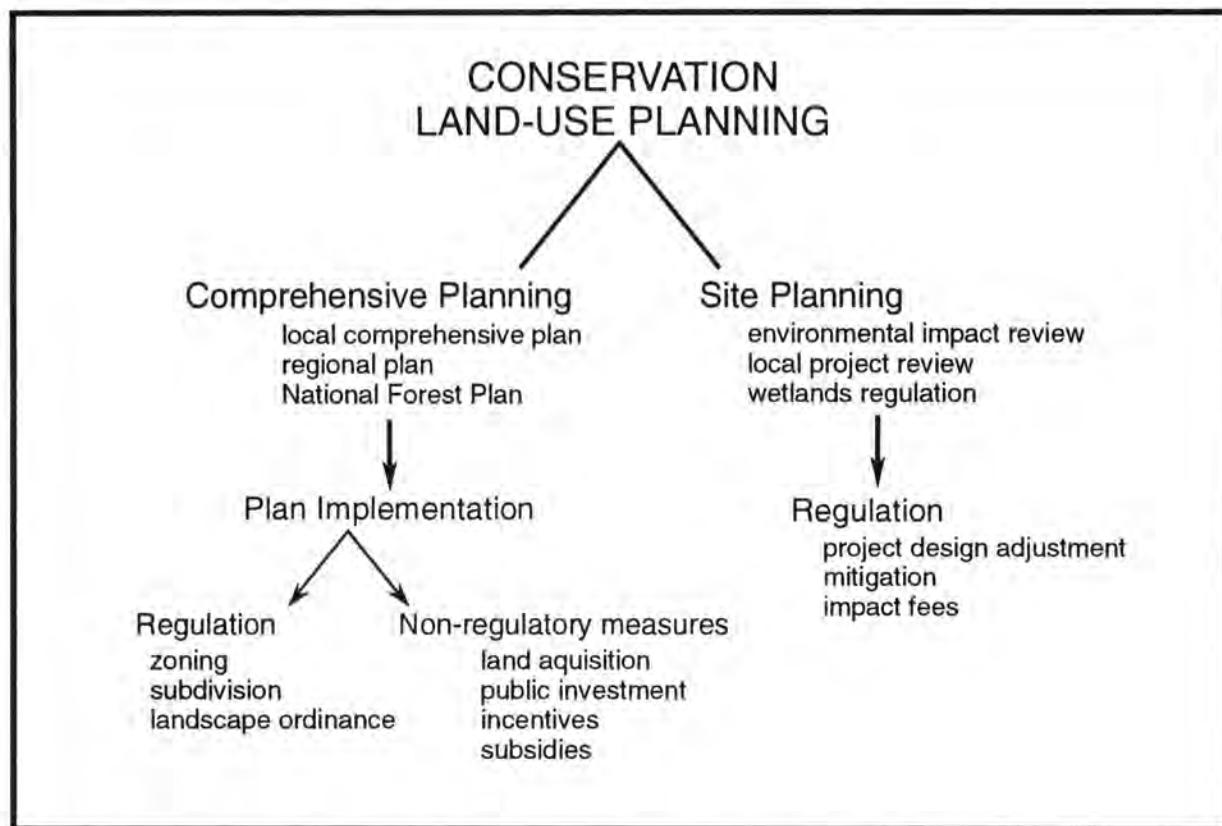

Figure 13.6-1: Comprehensive versus site planning for biodiversity conservation. (Adapted from Cort 1995.)

introduction of species that may threaten native ecosystems, habitats or species, while Article 8(g) calls upon countries to regulate the release of 'living modified organisms' likely to have adverse environmental or human health impacts.

Other activities now regulated are the use of trawls and drift-nets at sea, and open-air activities such as off-road driving, rock climbing and the construction of golf courses. Controls are usually introduced only after the damage caused by such activities has become unacceptable to public opinion, yet proposed restrictions almost invariably clash with vested interests.

Methods to identify and manage processes and activities that may cause serious damage to biodiversity must therefore be developed before they become too established. A legal concept underpinning the regulation of damaging processes appeared for the first time in the Australian State of Victoria's Flora and Fauna Guarantee Act (1985). That law lists a number of 'potentially threatening processes' for mandatory management. Listed processes include alteration to the natural flow regime of rivers, the use of lead shot in cartridges for the hunting of waterfowl, and the introduction of live fish into waters outside their natural range. The Australian Federal Endangered Species Protection Act (1992) requires the preparation of 'threat abatement plans' for 'key threatening processes'.

There are, of course, major practical problems in the enforcement of command and control regulation in large 'modern' societies with diverse structures of authority. This is vividly illustrated by the 'shoot, shovel and shut-up' philosophy that prevails amongst some landowners in the United States who find endangered species on their land (Mann and Plummer 1995). The problems of policing command and control regulation in such an environment are insuperable. This suggests that relying solely on command and control regulation, particularly where the ideology of private property is strong, is unlikely to work without incentives for landowners to undertake positive acts of management.

It should be noted that in some countries, constitutional restrictions can make regulatory approaches to biodiversity conservation difficult. One frequently occurring constitutional provision that may cause difficulty is a guarantee against deprivation, or acquisition, or taking of property without compensation. In the United States, for example, this has been interpreted to include not only physical appropriation of land, but also significant land-use restrictions imposed by legislation. In Australia, on the other hand, this broader interpretation appears to have been rejected (Farrier 1995). Under the constitution of Tuvalu, 'deprivation' of property is defined to include cases where property is made useless or valueless for the purposes for which it was originally used (Pulea and Farrier 1994a). In Kiribati, there are specific exceptions to the prohibition on

deprivations of property without compensation (Pulea and Farrier 1994b).

13.6.3.1.8 Regulating access to genetic resources. The Convention on Biological Diversity affirms the sovereign right of nations to regulate access to genetic resources, and many countries are now beginning to develop legislation and regulations to put that right into practice (Reid *et al.* 1995). The need to do so is becoming increasingly urgent, as advances in biotechnology increase the value of wild genetic resources and spur their collection by agents of the pharmaceutical and other industries (Reid *et al.* 1993).

There is little precedent, however, upon which to build legal regimes for genetic resources access. Contractual arrangements for 'biodiversity prospecting' in a number of countries are the most widespread legal arrangement governing access to genetic resources for commercial purposes, but are by their nature too narrow to effectively control those who are not parties to the contract (Laird 1993). And while all contracts must function within limits set by national laws, existing laws governing business practices, property rights and the like are not necessarily appropriate for the novel situations raised by commercial exploitation of genetic resources.

Genetic resource 'source' countries face a number of common issues in developing access regulation laws and policies. First, they must establish the rules by which those seeking to collect genetic resources may do so, including provisions governing where, when and how collection may be carried out, information that must be provided by the collector, steps that must be taken to obtain the informed consent of local communities in collection areas, and the like. Second, they must establish regulations on benefit sharing (e.g. royalties on future commercial applications) and technology co-operation (e.g. participation by local scientists) which at least specify minimum requirements in these areas. Regulations in these two areas might be very specific – spelling out mandatory royalty percentages, for example – or they might only set minimum standards, leaving parties to negotiate individual contracts within certain legislative limits. In either case, however, governments must establish or designate the institution that will serve as the regulatory authority, and develop its rules of procedure.

Few countries have as yet set genetic resources access legislation in place. Two early initiatives, however, illuminate the legislative issues that all 'source' countries are facing. First, the Philippines issued a Presidential Executive Order in May 1995 establishing a genetic resources access regulation regime. Second, a proposal for an Andean Regional regime on access to genetic resources has been developed under the mandate of the Andean Pact countries.

The Philippines Executive Order establishes a system with three basic elements:

1. a system of mandatory Research Agreements between collectors and the government containing minimum terms concerning the provision of information and samples, technology co-operation and benefit sharing;
2. an Inter-Agency Committee to consider, grant, monitor and enforce compliance with Research Agreements, as well as to co-ordinate further institutional, policy and technology development and
3. a requirement and minimum process standards for obtaining prior informed consent from local and indigenous communities where collection of materials is carried out.

Research Agreements are divided into two types, academic and commercial. Recognized Philippines academic and research institutions and government agencies, as well as intergovernmental institutions, are eligible for academic agreements, while all research and collection directly or indirectly intended for commercial purposes may take place only under a more stringent commercial agreement. All private persons and commercial firms, whether foreign or domestic, are legally presumed to have commercial motives (Government of the Philippines 1995).

The Andean Pact initiative, prepared with technical assistance from IUCN and the Peruvian Society for Environmental Law, would establish a Common Regime on Access to Genetic Resources for Pact countries (Bolivia, Colombia, Ecuador, Peru and Venezuela). The system put forward for discussion by IUCN and the Peruvian Society of Environmental Law (SPDA) in 1994 would establish common legislation for all Pact countries, to be carried out by their respective national governments. Two criteria are deemed central: prior informed consent, and the determination of mutually agreed terms between all entities concerned, one of which will always be the state.

Under the system, each country would appoint a Competent Authority charged with authorizing access in conformity with the norms of the Common Regime. Collectors of genetic resources would be required to obtain proof that such authorization had been obtained, in the form of a valid Certificate of Origin or Material Transfer Agreement. (The former is a document issued by the Competent Authority of a member state, certifying that access to the materials specified in the certificate has in fact been authorized. The latter refers to an agreement between a provider and recipient of genetic resources which establishes the mutually agreed terms between them.) While the system recognizes that each country's procedures for authorization will vary, it establishes that authorization is valid only when all procedural requirements have been met, sets out a common set of issues for which rules must be established system (e.g. third-party transfers of materials, obligations related to intellectual property rights, in-kind benefit-sharing, deposit of duplicates, etc.), and

mandates development of common administrative procedures for granting access in each member country. Within this framework, contractual access agreements are permitted, and each state is obliged to adopt measures to allow indigenous and local communities to enter into access agreements (IUCN/ELC and SPDA 1994).

While the current focus for developing access legislation is on genetic resource source countries, it is clear that recipient countries will also have to develop legislation to regulate the activities of researchers and commercial firms domiciled within their boundaries. Without this parallel development, source country legislation is likely to remain very difficult to enforce.

13.6.3.2 *Non-regulatory methods*

In the absence of regulatory measures, area-based conservation depends entirely on the will of the landowner, whether public or private. Even where appropriate incentives are provided, however, the means of protection available to private landowners are somewhat limited. Prohibitions on access to land may be difficult to enforce. Governments may expropriate land for public works. Protection disappears when the ownership of land changes, except when covenants or easements are in force.

13.6.3.2.1 Financial incentives. Disincentives to conservation, such as high land taxes on 'idle' land, should be ended as a first incentive measure, and fiscal or other incentives to develop natural habitats should be abolished. For example, federal legislation instituting the Coastal Barrier system in the United States prohibits all federal expenditure in listed undeveloped barrier islands.

As well, disincentives to destruction of natural resources should be introduced. Again in the United States, all federal subsidies have been abolished for landowners who drain wetlands for agricultural production, pursuant to the Farm Act (1985).

Some jurisdictions grant tax reductions or exemptions to landowners who maintain natural areas, provided that they comply with management guidelines. Land donated for conservation purposes may be exempted from land-transfer tax, and its value deducted from taxable income. The United Kingdom exempts land of outstanding natural value from death duties if the heirs manage the estate according to a management plan approved by the conservation authority. Direct grants to landowners may also be made for the acquisition and management of land for conservation.

13.6.3.2.2 Covenants. A covenant is a legal instrument irrevocably binding a landowner to certain land-use restrictions on a specific piece of land. The owner, who may continue to occupy the land, receives no payments other than possible land tax reductions. The obligation runs with the land and binds successors in title. The beneficiary of the covenant, usually a government department or a conservation trust, may enforce its terms in the courts.

This systems exists in only a few countries. In Australia, both the Commonwealth Endangered Species Act and state legislation in New South Wales provide opportunities for private landholders to enter voluntary 'conservation agreements' or 'heritage agreements' with the government, which are then binding on current and future landowners. In the United States, some states have a form of covenant called 'dedication' that additionally preserves the land from expropriation by government agencies. In Samoa, where customary ownership rights are recognized by the state, local communities have covenants with private and government institutions to conserve the rain forests. These reserves suggest that solutions to biodiversity conservation may be achieved under local control (Cox and Elmqvist 1991).

13.6.3.2.3 Easements. Easements are contracts that impose specific obligations on owners. They run with the land and bind successors in title. Developed under rural law, they secure a benefit (e.g. a right of way) for one piece of land at the expense of contiguous land. A small number of countries now permit the creation of easements for conservation purposes and waive the contiguity requirement. A conservation agency or NGO can contract with a landowner to prohibit certain forms of land use, and future owners must comply with these prohibitions. A conservation body may, in some cases, sell its own land with a conservation easement attached.

In the United States, voluntary arrangements that obligate not only those entering into them but also successors in title are called *conservation easements*. Under the common law as it has developed in the United Kingdom and Australia, they are referred to as *restrictive covenants*. Restrictions may be placed by the law on those who are allowed to take advantage of easements (Farrier 1995). Historically in common law jurisdictions, only negative obligations, relating to land use or land-use restrictions, bound successors in title. Legislation now frequently allows positive obligations (management obligations). For example, in the United States, conservation easements are often empowered by legislation to impose positive management obligations as well as negative restrictions (Farrier 1995). Cheaper than acquiring the land itself, easements are a very flexible instrument, although they may not generally include positive obligations.

13.6.3.2.4 Management agreements. These are contracts between public authorities or conservation organizations and landowners who undertake to manage their land in a specified way in return for periodic payments or a lump sum. If management agreements run with the land and contain positive obligations, such as those concluded for SSSIs in Great Britain or Heritage Agreements in South Australia, then they are particularly useful for the long-term conservation of areas rich in biodiversity.

Alternatively, management agreements may take the form of personal contracts with the landowner that are concluded for a relatively short period of time. These instruments are increasingly used to promote extensive agriculture and the conservation of landscape features and semi-natural habitats. The European Union initiated this type of contract in 1985. Farmers may enter into agreements whereby they are paid to manage their land according to ecological criteria. The system, originally limited to designated Environmentally Sensitive Areas, is now applicable in the whole of the territory of the member states. Similar systems have been developed in several countries outside the European Union, such as Sweden.

Another type of management agreement is Countryside Stewardship, developed in the United Kingdom, which aims to combine conservation and public enjoyment of land with commercial land management through a national system of incentives. The scheme is not area-specific, nor is it restricted to farmers. Proposals for the management, restoration or re-creation of specified categories of habitats or landscape features are screened, and only the best from an environmental point of view are retained. Agreements run for ten years and a sliding scale of premiums is paid per hectare, depending on the complexity of the conservation obligations involved.

Simple contracts for the protection of habitats or for other actions to manage biodiversity sustainably, that obligate only those entering into them and do not impose obligations to successors in title, are of limited utility for long-term biodiversity conservation since they are vulnerable to changes in ownership.

13.6.3.3 Combining regulatory and voluntary measures

Just as an exclusive reliance on regulation can limit the effectiveness of protection and sustainable use measures, the entirely voluntary approach to conservation on private lands can have serious limitations as well. Not only would this be extremely expensive, but it gives individual landowners the power to veto the use of conservation measures on their land, for example, under a broader strategy to create a buffer zone or a wildlife corridor. This suggests that the most effective legal strategies to sustainably use and protect biodiversity will include a combination of 'carrots' and 'sticks' (Farrier 1995). Regulatory measures can be made more acceptable by reducing taxes or granting fiscal benefits with respect to land subject to restrictions for conservation purposes, and/or by compensating the landowner for loss of profit.

The SSSI system in the United Kingdom is partly regulatory (prior notification to be made before certain operations are conducted) and partly voluntary (management agreements are freely negotiated). Where parties fail to reach an agreement, the conservation authority has the back-up regulatory powers to make

conservation orders in respect of sites of particular value or to purchase the land compulsorily.

Under South Australia's Native Vegetation Act (1991), when a permit to clear native vegetation is refused, the government may offer to buy the land and re-sell it with a Heritage Agreement attached or to conclude such an agreement directly with the landowner. Agreements run with the land and restrict its use, since owners may be required to carry out preservation and enhancement works or to permit the government to do so. The Heritage Agreement may provide compensation for loss in land value resulting from the agreement, but compensation is not paid for loss in land value resulting from restrictions on clearance of native vegetation. An Agreement may also commit the conservation authority to provide technical assistance to the owner to undertake ongoing management and planning.

Where an owner, such as a conservation NGO, wishes to preserve a site and needs assistance from the government, regulatory measures should aim to prevent encroachment by third parties and by government agencies. In Belgium and France, once voluntary reserves have been approved by the government, they are protected as statutory reserves, except that owners remain free to abolish them.

The United Kingdom's National Trust, a major owner of land and buildings for conservation, may declare its land inalienable. Such land cannot be sold or donated, nor may it be compulsorily purchased unless Parliament decides to the contrary. Like its sister bodies in several Commonwealth countries, the Trust may make and enforce restrictive covenants with other landowners over their property. National Trusts usually also have the right to make bylaws binding upon third parties.

Few voluntary instruments have yet been created to preserve species or manage potentially damaging processes. Regulatory measures continue to dominate those sectors, so imaginative thinking is clearly necessary. The various South Australian experiences over the past several years to persuade landowners not to clear native vegetation provide an interesting case study in the failure of command and control legislation on the one hand and pure voluntarism on the other. The original South Australia Native Vegetation Management Act of 1985 combined command and control with compensation for the imposition of land-use restrictions. The successor 1991 Native Vegetation Act is attempting to move away from compensation for restrictions toward providing incentives in the form of management payments for active conservation steps.

13.6.3.4 Environmental impact assessment and other legal institutions and procedures for conserving biodiversity

Environmental impact assessments are strategically important legal tools for protecting biodiversity because they seek to avoid problems before projects are

implemented. They should be required for sectoral and land-use policies, programmes and plans – particularly highway planning, river basin development, forestry and physical planning. It is often too late at the project stage to prevent major damage if that project is already part of an approved plan or programme.

The Preamble to the Convention on Biological Diversity states that the contracting parties 'note that it is vital to anticipate, prevent and attack the causes of significant reduction or loss of biological diversity at source'. Environmental impact assessments (EIAs) are the most important legal procedure for achieving this objective, and several provisions within the convention – most notably Article 14 (Impact Assessment and Minimizing Adverse Impacts), Article 7(c) and Article 8(l) – specifically address the types of knowledge and assessment needed to reach an ecologically appropriate decision. Where it appears from the EIA that an important and threatened element of biodiversity is likely to be significantly affected by the proposed project, a decision to let the project go ahead should be allowed by law only in exceptional cases.

The law should, as in Italy, specify the elements of biodiversity to be considered when preparing the EIA and require its content to be verified by the conservation agency or an independent body. As yet, very few countries have adopted special rules for projects liable to affect ecologically sensitive areas by requiring EIAs to be prepared for certain categories of projects that would normally be exempt.

The law should clearly establish conditions of participation in the decision-making process, and should cover consultation of scientific bodies and conservation NGOs, the right to comment on EIAs, and access to information on the environment and threatening activities. Mechanisms should be established to resolve conflicts between conservation and development, through mediation, an intervener or ombudsman, or the courts.

In law or pursuant to judicial practice, conservation NGOs in a few countries have standing to sue for breach of the law, a particularly valuable procedure where government has violated its own regulations. Standing is necessary to ensure that:

- governments do not issue regulations or permits against the law;
- proper assessment and consultation procedures have been followed, and
- proceedings may be brought against offenders where public authorities refuse to intervene.

Few laws deal adequately with the problem of compensating damage to biodiversity. There are three mainly unresolved problems: the definition of the damage to be compensated; the evaluation of the damage (certain countries, such as Spain, have a scale for protected species);

and the identity of the person or body to be compensated (Italian and Spanish laws nominate the government, but in most countries, no one can sue or collect for damages unless a direct interest has been injured).

Box 13.6-1 illustrates a framework used in India to analyse the coverage of legal measures with respect to biodiversity resources and activities impacting biodiversity. Table 13.6-2 shows the results of the analysis.

13.6.4 International law

Until relatively recently, international law evolved unaware of and seemingly unaffected by global environmental interdependence. In governing the relations among states, traditional international law focused on recognizing and preserving each state's sovereignty. Its underlying assumption was the freedom of control over activities within a state's national jurisdiction. Sovereignty historically included freedom of action with regard to the natural resources found within a state's national jurisdiction. The earliest limitations on activities within national boundaries consisted of narrow formulations based on the general international-law obligation that no state should permit its territories to be used to harm its neighbours.

The last 20 years have witnessed a growing understanding and acceptance of the global nature of environmental degradation. Countries at the Stockholm Conference on the Environment in 1972 accepted the declaratory principle that nations have the sovereign right to exploit their own resources *and* the responsibility to ensure that activities within their borders do not cause damage to other nations or international waters (Bragdon 1992). The Convention on Biological Diversity was the first agreement to take this principle and include it in the legally binding text of a treaty. The scope of activities taking place within national jurisdictions but affecting the environment of the international community is larger than previously imagined, and the earliest limitations on national sovereignty have grown accordingly.

13.6.4.1 Regional and sectoral treaties

Nations will voluntarily restrict their sovereignty rights by consenting to be bound by international treaties when it is in their interest to do so. The evidence of global environmental interdependence has created incentives for collective action, and the number of multilateral environmental treaties now exceeds 150 (Bragdon 1992). In addition to the Convention on Biological Diversity, which takes a comprehensive approach, there are four global treaties (concluded prior to the CBD) that address specific aspects of biodiversity. These are:

- The Ramsar Convention on the Conservation of Wetlands of International Importance Especially as Waterfowl Habitat (1971);

- The Convention Concerning the Protection of the World Cultural and Natural Heritage (1972), or the World Heritage Convention;
- The Convention on International Trade in Endangered Species of Wild Fauna and Flora (1979), or CITES;
- The Convention on the Conservation of Migratory Species of Wild Animals (1973).

Other treaties have been concluded to promote the sustainable exploitation of dwindling shared resources, such as the Whaling Convention of 1946. Codified rules on fisheries jurisdiction and harvesting of living marine resources are now embodied in the global Law of the Sea Convention (1982; UNCLOS), in force from 1994. Although the Convention does not expressly deal with biodiversity, it regulates the introduction of species and contains a general obligation to preserve rare and fragile ecosystems and habitats of endangered species.

The first wildlife conservation treaty, the Convention for the Protection of Birds Useful to Agriculture, was concluded in 1902. It was followed by the signing of several regional instruments: London Convention (1933, for Africa); Washington Convention (1940, for the Western Hemisphere); Algiers Convention (1968, replacing the London Convention); Agreed Measures for the Conservation of Antarctic Fauna and Flora (1964).

At the regional level, protocols have been concluded under certain Regional Seas conventions to implement the provisions of UNCLOS on the protection of ecosystems in the Mediterranean (Geneva 1982), East Africa (Nairobi 1985), the Southeast Pacific (Paipa, Colombia 1989), and the Caribbean (Kingston, Jamaica 1990).

In Europe, the Berne Convention (1979) requires the protection of listed species and endangered habitats. European Union directives binding upon member states are the Birds Directive (1979), which requires the establishment of Special Protection Areas for birds, and the Directive on the Conservation of Natural Habitats and of Wild Fauna and Flora (1992), which lists species whose habitats must be protected by member states. Particularly innovative is the obligation to preserve endangered habitat types as listed in an annex. The directive provides for the establishment of a network of Special Areas of Conservation, NATURA 2000.

Other regional instruments include the Apia Convention for the South Pacific (1976) and the ASEAN Agreement (1985), which is the most comprehensive regional treaty on environmental protection.

The Madrid Protocol of 1991 to the Antarctica Treaty (1959) designates the Antarctic as a 'natural reserve devoted to peace and science'. Activities in the Treaty Areas must be planned and conducted so as to 'avoid detrimental changes in the distribution, abundance, or

Box 13.6-1: Legal coverage of biodiversity conservation and use in India.

Each country needs to assess the legal coverage of biodiversity conservation and use within its boundaries. Such an assessment has been broadly carried out for India (Kothari and Singh 1992). This assessment first provides a conceptual framework within which to examine each law, and deals not only with conventional conservation laws but also other laws relating to development, use and distribution of resources.

For the sake of the analysis, Kothari and Singh (1992) categorized biodiversity components under five headings: wild fauna, wild flora, domesticated fauna (livestock), domesticated flora (crops and other cultivated plants), and genetic materials (seeds, eggs, germplasm, semen). They also distinguished 11 distinct aspects of biodiversity:

1. *Identification*: The process of locating, and thereafter establishing the identity, distribution, occurrence, status, and value of biodiversity components. Relevant to both wild and domesticated fauna and flora.
2. *Protection in situ*: Efforts to protect and conserve biodiversity, including the habitats within which biodiversity components survive and evolve. Applies especially to wild fauna and flora, but also to domesticated fauna and flora at the sites of their use, in so far as these may need to be protected from disease/infestation, displacement by new varieties, and destruction from human activities.
3. *Protection ex situ*: Attempts at preserving living species or genetic material in gene banks, zoological parks, botanical gardens and sites other than their natural habitats. Relevant to all biodiversity components.
4. *Access/extraction*: Controls on the kind and amount of access to fauna and flora in the wild, to *ex situ* collections, and to genetic material; also the modes of extraction of these components, relevant especially to *in situ* stock. Overlaps with intellectual property rights (see 11 below).
5. *Use*: Attempts at utilizing biodiversity for subsistence, commercial, scientific or other purposes. Relevant to all biological components.
6. *Breeding/Cultivation/Multiplication*: Artificial or induced measures for regenerating flora-fauna populations in captive or closed conditions. Relevant to both wild and domestic fauna and flora.
7. *Trade*: Activities relating to the barter, sale, import, export and other forms of exchange of biodiversity components.
8. *Introduction/Augmentation/Re-introduction*: Measures to deliberately stock an ecosystem or area with species that did not previously exist there (introduction) or where they have declined or need to be increased in number (augmentation) or where they have died out (reintroduction). Relevant to both wild and domesticated fauna and flora, as also to genetic material (e.g. seeds) used for the purpose.
9. *Release*: Disposal of biodiversity components, without the specific purpose of introducing, augmenting, or reintroducing them, into the environment. Relevant to all biodiversity components.
10. *Movement*: Measures to transport, by human means, biodiversity components from one location to another; especially relevant in cases of transportation across ecosystems or bioregions, involving the possibility of accidental release of components. Does not include natural or voluntary movement of animals, or movement of seeds or other floral parts by natural means. Relevant to all biodiversity components.
11. *Intellectual property rights*: Measures pertaining to the rights of the state, organizations, or individuals over biological and biotechnological knowledge, including patents, royalties, intellectual property rights, farmers' rights and breeders' rights.

Over 40 national Acts were then assessed with respect to their coverage (or lack of it) of each of the 11 aspects listed above for each of the five biodiversity categories (i.e. wild flora, wild fauna, domesticated flora, etc.). The results of this analysis are presented in Table 13.6-2.

productivity of species or populations of flora and fauna or further jeopardy to endangered species or populations'.

Lastly, a few treaties outside the Migratory Species Convention deal with migratory species such as polar bears, vicuna and migratory birds (e.g. several bilateral treaties, such as a 1916 bilateral agreement on migratory birds between the United States and Canada).

The above summary reveals that large parts of the world are covered by regional treaties, the content and rigour of which vary greatly, and that global treaties deal only with limited, if important, aspects of biodiversity conservation.

13.6.4.2 The Convention on Biological Diversity

The IUCN promoted the idea of a global convention on

Table 13.6-2: Legal coverage of various aspects of biodiversity in India.

Type of activity	Wild fauna	Wild flora	Domestic fauna	Domestic flora	Genetic materials
1. Identification	N	N	N	N	N
2. Protection <i>in situ</i>	W	W	N	N	N
3. Protection <i>ex situ</i>	W	P	N	N	N
4. Access/extraction	P	P	N	N	N
5. Use	W	P	W	N	N
6. Trade	W	W	P	W	P
7. Breeding/cultivation/multiplication	W	P	P	P	P
8. Introduction/augmentation/ re-introduction	P	P	P	P	P
9. Release	N	N	N	N	P
10. Movement	W	P	P	P	P
11. Intellectual property rights	N	N	N	N	N

N = Not covered; P = Partially covered; W = Well covered.

Source: Kothari and Singh (1992).

biodiversity as early as 1981. The idea was supported by the World Commission on Environment and Development in its report, *Our Common Future* (WCED 1987), and in 1987, the UNEP Governing Council established an *ad hoc* working group to investigate 'the desirability and possible form of an umbrella convention to rationalize current activities in this field', and to address other areas that might fall under the convention. By early 1990 the group had reached a consensus that a global treaty on biodiversity was needed. The UNEP secretariat prepared a first draft of the convention, and formal negotiations began in November 1990. The convention was adopted in Nairobi in May 1992 and opened for signature at the United Nations Conference on Environment and Development (the 'Rio Summit'). It entered into force on 29 December 1993 and as of 21 June 1995 had 118 Contracting Parties.

The convention affirms that the conservation of biodiversity is a common concern of humankind and sets forth objectives for conserving, sustainably using, and equitably sharing the benefits from such use. The negotiations made clear that the ability to reach and implement agreement on this subject depends on the ability to maintain this careful balance among objectives. The convention recognizes the sovereign rights that states have over their biological resources, but also the responsibilities they have for protecting their biodiversity and using it sustainably. Emphasis is placed on the importance of preventive measures and the precautionary principle.

Biodiversity is defined in the convention as 'diversity within species, between species and of ecosystems'. Parties must promote the conservation of ecosystems, natural habitats, and the maintenance of viable populations of

species in their natural surroundings. *Ex situ* conservation is complementary to this objective.

The convention requires the creation of a system of protected areas, or areas where special measures need to be taken to conserve biodiversity, together with the identification, regulation and management of processes and activities that have, or are likely to have, significant adverse impacts on biodiversity. Parties must also enact legislation for the protection of threatened species and populations.

Parties must adopt national strategies, plans or programmes for the conservation and sustainable use of biodiversity. They are also required to prepare environmental assessments of proposed projects likely to have significant adverse impacts on biodiversity, and to ensure that the environmental consequences of programmes and policies likely to have such impacts are taken into account.

The convention empowers host countries to enact laws requiring companies to pay access fees and negotiate royalty payments with the suppliers of genetic resources. For the first time in international law, conservation obligations are balanced in the convention by certain rights, as a matter of equity and as an incentive to conserve biodiversity:

- Access to genetic resources by foreign collectors is no longer unrestricted, but is now subject to the prior informed consent of the party providing the resource. Host countries are therefore empowered to enact laws requiring companies to pay access fees and negotiate royalty payments with the suppliers of genetic resources, and conditions of access must be mutually agreed. The convention does not, however, outline

the procedures that governments must follow, and some may choose to have certain types of resources or resources for certain purposes (e.g. non-commercial scientific research) freely available.

- The results of research and development, and the benefits arising from the commercial and other utilization of genetic resources, must be shared in a fair and equitable way with the party providing the resource, again on mutually agreed terms.
- All Parties are required to provide and/or facilitate access to and transfer of technologies that are relevant to the conservation and sustainable use of biological diversity and do not cause significant damage to the environment. The transfer of such technologies to developing countries is to be provided on fair and preferential terms, where mutually agreed.
- Although these provisions do not explicitly affect intellectual property rights such as patents (although Article 16(5) states that IPRs should be supportive of and not run counter to the objectives of the convention), parties must facilitate through proper incentives the transfer of technologies even where protected by such rights.

These provisions on access do not expressly guarantee benefits to local people whose traditional knowledge often provides the initial basis for identifying seeds and plants that might have medicinal and other benefits. However, it should be noted that the conservation provisions of the convention require countries, subject to national legislation, to respect and maintain the knowledge, innovations and practices of indigenous and local peoples, and to encourage the equitable sharing of the benefits arising from the utilization of such knowledge, innovations and practices. Given the close connections between genetic resources and local and indigenous knowledge and innovations, countries may consider implementing this requirement in conjunction with any access regime it adopts or creates in order to implement the convention.

The convention's success will be determined in part by the willingness of developed countries to provide financial resources and technological transfer to poorer countries that are rich in biodiversity. Indeed, the convention explicitly links effective implementation by developing countries to the fulfilment of these obligations by developed countries (Article 20(4)).

The convention establishes a mechanism for the provision of financial resources to developing-country parties on a grant or concessional basis. At its first meeting, the Conference of the Parties to the Convention selected the Global Environment Facility to operate the financial

mechanism on an interim basis until a final decision by the Conference of Parties at its second meeting in November 1995.

Developed countries are to provide new and additional financial resources to enable developing countries to meet the agreed full incremental costs to them (i.e. costs to a developing-country party that exceed domestic benefits from actions taken to implement terms of the convention) arising out of their obligations under the Convention. It should be noted that benefits to developing countries should also flow from other financial institutions and mechanisms, such as genetic access agreements.

13.6.4.3 Implementation and compliance

Just as incentives are needed to bring nations to the negotiating table in the first place, so are incentives also necessary to ensure countries remain parties and implement their treaty obligations. In addition, implementation requires an adequate number of institutions to support and develop the treaty. These include a Conference of Parties (COP), a Secretariat, and perhaps relevant subsidiary bodies. The COP is a treaty's most important institution and has the primary responsibility for reviewing and directing its implementation. In order to fulfil this responsibility, the COP must have the power to review implementation, make recommendations to the parties, and adopt the budget and scale of contributions. Conventions that have not established institutions with adequate authority have not been active (examples include the Algiers and Western Hemisphere conventions). In addition, the RAMSAR Convention had to be amended almost 20 years after its conclusion to establish these basic minimums.

Many treaties require parties to present the COP with progress reports on implementation of the convention. This provides a mechanism by which implementation can be monitored. The information is used as the COP considers what action may be required for the achievement of the purposes of the convention in light of the experience contained in the report.

Specific procedures have been developed under certain conventions to improve compliance. The RAMSAR Convention has instituted a monitoring procedure for listed Wetlands of International Importance. Sites with particular problems of compliance are listed in the 'Montreux Record'.

The World Heritage Convention has a *List of World Heritage in Danger*, and the World Heritage Committee can de-list a site that has lost the intrinsic qualities that determined its inclusion on the list where the necessary conservation measures have not been taken. The CITES Standing Committee makes recommendations to parties to refuse CITES specimens from parties in breach.

The Berne Convention has a system for opening files in cases of non-compliance. Its standing committee discusses

cases, in the presence of NGOs that may contribute to the discussion, and makes recommendations to parties. The procedure is often initiated after an NGO has submitted information to the secretariat.

Adequate finance is essential to pay for meetings and to provide secretariats with properly qualified staff: however there is usually stiff resistance to increasing the low level of essential expenditure in the budget approved by the parties.

A convention's effectiveness also depends on whether financial assistance is available to help parties to comply with its terms. This objective is integral to the Convention on Biological Diversity. The only other convention to address this matter directly is the World Heritage Convention, whose World Heritage Fund is intended to assist parties in conserving World Heritage Sites. A Wetland Conservation Fund has now been established under the RAMSAR Convention.

13.6.4.4 Interaction between national and international legislation

National and international law are complementary and interactive (this is not generally true, however, between national laws and customary laws). Treaties are often concluded at the initiative of countries with more advanced national conservation laws. To meet these international obligations, less advanced countries then have to raise their own standards of legislation. As an example, the 'potentially damaging process' concept initiated by Australia is now part of the Biodiversity Convention, whence it will gradually be incorporated into the legislation of other countries.

The existence of international obligations gives greater legitimacy to national laws, facilitates their implementation and enforcement, and may require the promulgation of new laws to implement obligations assumed by becoming a party to a treaty. International co-operation resulting from treaties facilitates access to scientific, technical and legal information, which is essential for effective conservation.

13.6.5 Conclusion

This brief review has highlighted the variety of legal instruments available for the conservation of biodiversity. Traditional tools for the protection of species and areas, based on regulatory measures, are increasingly complemented by voluntary systems based on contracts and incentives. There is a pressing need to make comparative studies of existing instruments and their successes and failures, and to make this knowledge available to conservationists the world over to stimulate innovative and effective legislation.

Law should form an integral part of conservation science, yet its role and potential are often still not fully appreciated by conservationists. Legislation cannot substitute for effective biodiversity management

programmes. Biodiversity management efforts, however, will work most effectively within a legal framework that provides regulatory and incentive tools that provide the authority needed to implement conservation and sustainable use activities.

References

- Amornsanguansin**, J. n.d. Traditional Community Forest Management: Enhancing Forest Conservation in Thailand.
- Attali**, J. 1991. *Millennium: Winners and losers in the coming World Order*. Random House, New York.
- Bailey**, C. 1990. The Kapuas River fishery: Problems and opportunities for local resource management. Paper presented at the Common Property Conference, 27–30 September 1990, Duke University, NC.
- Barber**, C.V. and Churchill, G. 1987. *Land Policy in Irian Jaya: Issues and strategies*. Government of Indonesia/World Bank, Jakarta.
- Bickford**, W.E. 1991. Massachusetts' landscape level land protection program. In: Decker, D.J., Krasny, M.E., Goff, G.R., Smith, C.R. and Gross, D.E. (eds), *Challenges in the Conservation of Biological Resources: A practitioner's guide*. 66–79. Westview Press, Boulder, Colo.
- Bradsen**, J. 1992. Biodiversity legislation: species, vegetation and habitat. *Environmental and Planning Law Journal* 9: 175–191.
- Bragdon**, S.H. 1992. National sovereignty and global environmental responsibility: can the tension be reconciled for the conservation of biological diversity? *Harvard International Law Journal* 33: 381–390.
- Cort**, C. 1995. Can local land-use planning save biodiversity?: the case of Hillsborough County, Florida. *Environmental Management* (in press).
- Cox**, P. and Elmquist, T. 1991. Indigenous control of tropical rainforest reserves: An alternative strategy for conservation. *Ambio* 20: 317–321.
- Dasmann**, R.F. 1988. Toward a biosphere consciousness. In: Worster, D. (ed.), *The Ends of the Earth*. 277–288. Cambridge University Press, Cambridge.
- de Klemm**, C. and Shine, C. 1994. *Biological Diversity Conservation and the Law*. IUCN Environmental Policy and Law Paper No. 29. IUCN, Gland, Switzerland.
- Durning**, T. A. 1992. *Guardians of the Land: Indigenous peoples and the health of the Earth*. Worldwatch Institute, Washington, DC.
- Farrier**, D. 1995. Conserving biodiversity on private land and carrots: incentives for management or compensation for lost expectations? *Harvard Environmental Law Review* 19: 381–396.
- Fernandes**, W. 1988. *Forests, Environment and Tribal Economy: Deforestation, impoverishment and marginalisation in Orissa*. Indian Social Institute, New Delhi.
- Gadgil**, M. 1993. Tropical Forestry and Conservation of Biodiversity. In: *Proceedings of the Norway/UNEP Expert Conference on Biodiversity*, 24–28 May 1993, Trondheim, Norway. Norwegian Institute for Nature Research, Trondheim.
- Government of the Philippines**. 1995. Executive Order No. 247 Prescribing Guidelines and Establishing a Regulatory Framework for the Prospecting of Biological and Genetic

- Resources, Their By-Products and Derivatives, for Scientific and Commercial Purposes; and for Other Purposes. 18 May 1995. Office of the President, Manila.
- Iamo, W.** 1992. Sustainable Development and Land Tenure in Papua New Guinea. In: International Indigenous Commission. 1991. *Indigenous Peoples' Knowledge and Management Practices*. Report prepared for the UN Conference on Environment and Development.
- IUCN/ELC and SPDA.** 1994. Toward a Legal Framework to Regulate Access to Genetic Resources in the Andean Pact. Technical legal report prepared for the Board of the Cartagena Accord. IUCN Environmental Law Centre, Bonn and Peruvian Society for Environmental Law, Lima.
- Kothari, A. and Singh, S.** 1992. *Legal Provisions Relating to Biodiversity in India*. Indian Institute of Public Administration, New Delhi.
- Laird, S.A.** 1993. Contracts for biodiversity prospecting. In: Reid, W.V., Laird, S.A., Meyer, C.A., Gamez, R., Sittenfeld, A., Janzen, D.H., Gollin, M.A. and Juma, C. (eds), *Biodiversity Prospecting*. 99–130, World Resources Institute, Washington, DC.
- Lynch, O.** 1992. Securing community-based tenurial rights in the tropical forests of Asia. *Issues in Development*. World Resources Institute, Washington, DC.
- McEvoy, J. and Dietz, T.** 1977. *Handbook for Planning*. John Wiley, New York.
- McNeely, J.A.** 1989. Common property resource management or government ownership: Improving the conservation of biological resources. Paper presented at the Conference on Incentives and Constraints: Macroeconomic Policy Impacts on Natural Resource Utilization, 11–12 May 1992, Smithsonian Institution, Washington, DC.
- Mann, C.C. and Plummer, M.L.** 1995. *Noah's Choice: The future of endangered species*. Alfred A. Knopf Inc., New York.
- Maragos, J.** 1992. Reef Tenure: key issues and ongoing programs. In: Malcolm, D.G. and Skog, J. (eds), *Land, Culture, and Development in the Aquatic Continent*. Proceedings of a workshop, 26–29 May 1992, Kapalua Pacific Center, Hawaii.
- Pulea, M. and Farrier, D.** 1994a. *Tuvalu: Review of Environmental Law*. South Pacific Regional Environment Programme, Suva, Fiji.
- Pulea, M. and Farrier, D.** 1994b. *Kiribati: Review of Environmental Law*. South Pacific Regional Environment Programme, Suva, Fiji.
- Reid, W.V., Laird, S.A., Meyer, C.A., Gámez, R., Sittenfeld, A., Janzen, D.H., Gollin, M.A. and Juma, C.** (eds) 1993. *Biodiversity Prospecting*. World Resources Institute, Washington, DC.
- Reid, W.V., Barber, C.V. and La Vina, A.** 1995. Translating genetic resource rights into sustainable development: gene cops, the biotrade, and lessons from the Philippines. *Plant Genetic Resources Newsletter* **102**: 1–17.
- Simmonds, K.** 1992. Back to the future: Rediscovering island values and fisheries management. In: Malcolm, D.G. and Skog, J. (eds), *Land, Culture, and Development in the Aquatic Continent*. Proceedings of a workshop, 26–29 May 1992, Kapalua Pacific Center, Hawaii.
- Taylor, M.** 1994. Indigenous Communities and Biodiversity Conservation in Papua New Guinea: Promoting Cultural and Biological Survival. Paper prepared for the Regional Conference on Biodiversity Conservation, Asia Development Bank, 6–8 June 1994, Manila.
- WCED.** 1987. *Our Common Future*. World Commission on Environment and Development. Oxford University Press, New York.
- Zerner, C.** 1994. Transforming customary law and coastal management practices in the Maluku Islands, Indonesia. In: Western, D., Wright, R.M. and Shrum, S.C. (eds), *Natural Connections: Perspectives in community-based conservation*. 80–112. Island Press, Washington, DC.

13.7 Building capacity for biodiversity management

13.7.1 Introduction

The development and implementation of successful biodiversity policies depends on the capacity of the people to carry out a number of related intellectual and practical tasks. To achieve an integrated and comprehensive biodiversity management programme, a country will need to provide opportunities for its citizens to develop the relevant scientific, technical and administrative knowledge. A set of institutions, physical facilities and financial resources will also be required to support their work. Experience shows that the potential for success can be realized when policies, activities, investments, and public and political actions promote these ends.

Four types of capacity can be considered:

- human capacity
- institutional capacity
- facility (infrastructure), and
- financial capacity.

Little, if any, comprehensive assessment has been conducted – at either national or international levels – to detail the existing and required capacities in these four areas. Thus, in each section below, only limited examples can be offered to document the concepts and principles involved.

13.7.2 Human capacity

People are ultimately the most important resource for designing and implementing a biodiversity management programme. This is recognized in the United Nations Development Programme's (UNDP) 'Capacity 21' programme. Designed in the wake of the UN Conference on Environment and Development, the programme is an effort to build the human capacity necessary to implement Agenda 21, and the international agreements signed in Rio de Janeiro (UN 1993).

Biodiversity management requires the use of many different human skills and capacities. Box 13.7-1 shows the

types of fields and training needed by typical biodiversity management programmes. These fields range from basic sciences through practical fieldwork, policy analysis and business management, to community organization and rural extension. Academic training and other forms of human resource development for biodiversity management may take place at universities, trade schools and specialized training programmes and at the community level. Distinct from traditional educational processes, biodiversity management calls for considerable integration and co-operation among professions and academic disciplines in order to bring the best science, traditional knowledge and field know-how into practice. It also requires integration among public and private interests including business, communities, public natural resource managers, and individual farmers, foresters and fisherfolk.

The design and management of methods to develop human capacity are culturally dependent. Existing skills and knowledge from across a wide spectrum, from local villages to government departments, need to be inventoried, evaluated and encouraged. Some of the most prominent methods of fostering human capacity include those listed in Box 13.7-2.

These methods are already being employed to expand biodiversity capacity. Important examples include joint activities among specific countries and bilateral and multilateral assistance agencies to formulate country studies, national strategies and action plans (Miller and Lanou 1995). Numerous opportunities to develop human capacity already exist in the form of technical training courses and workshops on such issues as inventory and data management, taxonomy and genetic resources conservation, biodiversity project planning, and strategic planning and legislation for biodiversity management.

Experience indicates that one way to develop people's skills is to involve them in the preparation of national strategies and action plans. Enabling 'biodiversity planners' also to be 'biodiversity implementors', encourages policy makers, scientists, resource managers and local leaders to gain an understanding of the problems and opportunities in the field, and take responsibility for the implementation and evaluation of their decisions.

Networking about experiences and information has been facilitated by new on-line computer technology and electronic mail systems. The FAO/UNEP Latin American Regional Network on Wildland Management, for example, was launched in 1983 to establish an efficient method of exchanging professional experience and fostering regional co-operation on protected areas and wildlife management in the Latin American and Caribbean region (Thelen 1992). Other networks exist among botanical gardens (Botanic Gardens Conservation International at Richmond in the UK), national parks and protected areas managers (IUCN

Commission on National Parks and Protected Areas, Gland, Switzerland), indigenous knowledge facilitators (International Development and Research Council, Ottawa, Canada), species specialist groups (IUCN Species Survival Commission, Gland, Switzerland), mycologists (Centre for Agriculture and Bioscience International, UK); agricultural germplasm (International Plant Genetic Resources Institute, Rome), forestry (International Union of Forestry Research Organizations, Vienna, Austria), community-level agro-ecology (Centro de Educación y Tecnología, Chile) and the IUCN Centre for Environmental Law, among others (CET 1991; Hawkes 1991; Hoyt 1992).

How much capacity exists for any of the many skills and occupations discussed above is difficult to assess, although it is clear that what capacity does exist is found mostly in developed countries. For example, Figure 13.7-1 shows that very few plant ecologists are found in regions where the greatest plant diversity is located. It is likely that similar relationships would be found for virtually any other discipline or skill.

Even less is known about what additional capacity is needed to manage biodiversity adequately. Some assessments for particular disciplines have been made. For example, China has estimated that at least 30 more botanists and 50 technical specialists are needed to complete the floristic inventory of its tropical region alone. The cost of this added level of personnel and their material support would be US\$2 million annually (Wang Huen-pu *et al.* 1989). To some extent, national biodiversity country studies, strategies and action plans are assessing what kinds of human resources are needed to carry out a comprehensive integrated biodiversity management programme. For example, the Biodiversity Action Plan for the United Kingdom emphasizes the need to develop the capacity to carry out an expanded environmental education programme (Government of the United Kingdom 1994). The Thailand Biodiversity Country Study estimates that \$113 million is needed for investment in education and training in fields relevant to biodiversity management. Most of this funding (75%) will require external financial assistance (Ministry of Science, Technology and Energy 1992). In Kenya, the national biodiversity plan estimates that 42 additional scientists and 84 technicians are needed over the next four years to achieve its genetic resource conservation goals (Government of Kenya 1992). While some of the training can be done at national institutions, additional postgraduate training will be needed abroad.

13.7.3 Institutional capacity

As noted in previous sections, institutional capacity varies from area to area because information, government policies, laws and administrative procedures and the cultural norms of each society are so different. Such

Box 13.7-1: Basic fields of human capacity for biodiversity management.

ecosystem science	natural resource planning/management
landscape ecology	community extension
conservation biology	environmental education
population biology/genetics	natural resource economics
plant and animal technology	marketing
biotechnology	business management
pharmacology	public administration
agro-ecology	project design and management
marine biology	policy analysis
systematics/taxonomy	anthropology and other social sciences
inventory	tourism management
monitoring	plant animal selection, breeding
captive breeding	garden and orchard management
urban/regional planning	natural products (chemical) research
restoration ecology	community organization
medical research and healthcare	environmental education
environmental and international law	bioregional/ecosystem management

aspects can either foster or impede the planning process.

While many institutional arrangements are formalized, with an organization to carry them out, others remain informal, and free of structure and bureaucracy. In the former instance, governments establish agencies to administer everything from water resources and national parks to agricultural research, seed banks, germplasm facilities and training centres. In some cases, communities, religious and interest groups, and industry establish formal organizations to create opportunities for training and citizen involvement in biodiversity management activities.

More informally, some traditional groups maintain systems of land distribution and use, crop management, water rights and other features of biodiversity management that remain outside the established formal institutions (see also 13.3, 13.5 and 13.6). For example, in Northern India, the management of livestock around water-holding ponds and the distribution of water for irrigation purposes provide a strong institutional structure for long-term continuous use and protection of upstream catchment lands, ponds, and agricultural soils (Poffenberger 1990).

Four major institutional issues confront many efforts to manage biodiversity. The first involves the loss of control by traditional or local institutions over natural resources, for example, where central government agencies have established control over forests previously managed by the community. In this case, informal institutional arrangements of traditional forest dwellers and/or users are superseded by central government regimes. These regimes often do not offer alternative access to resources or

compensation for these people, nor do they establish a new mechanism with adequate capacity to sustainably use and protect the resource (see, for example, Poffenberger 1990; Johnson and Cabarle 1993). Commonly, timber and other commercial commodities are exploited by non-local groups who gain a public subsidy for road building and low resource-extraction fees. This leaves the traditional communities without their own resource base and with little or no benefit from the new and different forms of resource use (see, for example, Sizer and Rice 1995).

Conflicts over the balance between central and local control over resources and management authority is found in many countries, developing and developed alike. One view suggests that the management responsibility and authority over natural resources including biodiversity is most effective when it is in the hands of local institutions. This perspective argues that under local control, the biota will be more efficiently protected and used, and the benefits more appropriately shared; this is because only at that scale can experience with local ecosystems and cultural attributes be properly mobilized. Furthermore, this argument proposes that direct local involvement can provide the incentive for commitment by local people to longer-term cycles of harvesting and use, as well as to stewardship, maintaining ecosystem health, and the production of a steady stream of benefits (Lynch 1992).

This view is countered by arguments that local control will foster over-harvesting for short-term local gain. Local power will ignore the greater national and societal interest. A compromise approach suggests that governments can choose to exert normative control over natural resources

Box 13.7-2: Measures for developing human capacity to manage biodiversity.

- Short courses on specific scientific, technical, managerial, or administrative topics.
- University and post graduate-level degree work in key fields, both in the country and abroad.
- Workshops and seminars on particular issues.
- Professional and academic exchange between countries or institutions to share experience and methods (North–South, South–North, and South–South).
- Programmes to train extension workers.
- Programmes to prepare, translate, and distribute training materials.
- Planning exercises that both prepare plans and provide the opportunity for intimate involvement of interdisciplinary and inter-sectoral collaboration.
- Networks of expertise and institutions to foster communication, exchange of experts, and sharing of information and experience.
- Consultant experts (local, traditional, and international).
- Rural worker group activities to share experience on methods and techniques.
- Events that permit exchange of information and methods between government and private sector scientists and technologists, and rural experts.
- Rural extension activities to promote exchange from rural to formal, and the reverse.
- Preparation of country studies, national strategies, and action plans involving government agencies, rural communities, business and industry, indigenous groups, and other stakeholders.

management as measured by agreed indicators and norms. Under this approach, day-to-day management would be left to local public and private institutions. One example is the Great Barrier Reef Marine Park Authority, where protection activities are managed by the National Park Service of the State of Queensland, through an agreement with the Commonwealth Authority (Great Barrier Reef Marine Park Authority 1993).

A second important issue is that of creating equal opportunities for all interested parties to be aware of the issues and options, and to gain access to knowledge and

information. If business, communities, and agencies are to define and achieve their goals equitably, all parties must have full access to information about the problems and opportunities, status and trends. *Agenda 21* documents the commitment of world governments to improving access to information from official to unofficial circles (UN 1993), a move that arguably is essential if farmers, forest workers, fisherfolk, industry, local government and community organizations are to become 'biodiversity implementors'.

Third is the issue of encouraging and developing local participation in nationally and internationally agreed measures to support biodiversity management projects. Anecdotal evidence suggests that local scientists, resource managers, community leaders and others managing biodiversity are poorly compensated for their work. They have little involvement in the national and international debate, and are granted little political and social status. National experts are often not consulted by their own governments with regard to the development of policy or international agreements. In too many places, foreign experts are still being hired in spite of local expertise being available. This wastes opportunities to engage and promote the learning and commitment of national and local experts, with the result that talented local experts often seek opportunities elsewhere.

The fourth issue is that of institutional flexibility. In other words, can institutional arrangements and organizations be sufficiently flexible and adaptive to respond to evolving knowledge, environmental conditions, policies, and opportunities? Recent work on adaptive management approaches (e.g. Holling 1993) suggests that management systems will be more effective over the long term if they deal explicitly with change (climate, evolving biotic structures and processes, human settlement patterns, population growth, technology, world markets, etc.). To respond to change, shifts in the mandates and structures of some agencies may be needed. For example, new responsibilities and authorities may have to be assigned to study, inventory, protect and develop biodiversity. New and changing private and community firms and organizations may develop with growing opportunities to develop and distribute bio-products and to foster the sharing of costs and benefits within local communities. The work of the South Pacific Regional Environment Programme demonstrates a specific effort among small island states to establish joint cooperative activities, beginning with a co-operative protected areas project (Reti 1995).

Institutional arrangements and organizations need to grow, change, and adapt for several reasons:

1. Biodiversity management is inter-sectoral. New and evolving mandates and responsibilities can be anticipated among such diverse sectors as forestry,

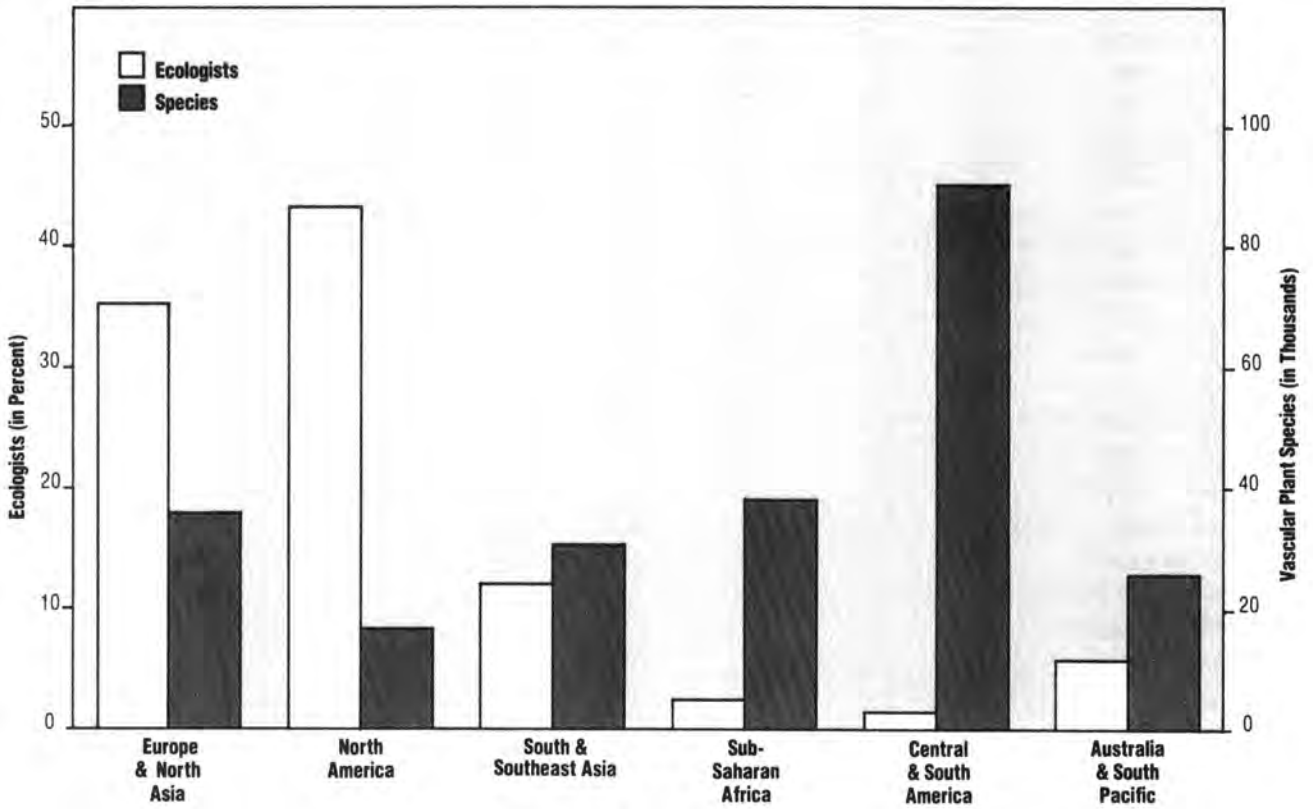

Figure 13.7-1: Distribution of professional plant ecologists in relation to the distribution of plant species richness. (Source: WRI/IUCN/UNEP 1992.)

social affairs, range management, fishing, agriculture, germplasm, museum collections, university departments of phytochemistry, business administration and economics, national park services, wildlife departments, and legal and patent offices.

- Implementation requires resource-using industries, local communities and indigenous groups to collaborate in their own self-interest, perhaps leading to the reconsideration of old and traditional arrangements and attitudes.
- The geographic scale of biodiversity work reaches to new configurations of land and water territory, embracing whole ecosystems or bioregions, thereby cutting across established agency jurisdictions.

Thus, conservation practice can no longer be seen as a responsibility covered only by protected areas, endangered species legislation, seed collections and trade regulations. In addition to these important components, biodiversity management requires new alliances and perspectives.

The critical issue is whether established public agencies, educational programmes, and the private sector can change their approaches to biodiversity protection and use. As Einstein once said, 'We cannot solve the problems that we have created with the same thinking that created them.'

Can existing institutions effectively change to meet the articles of the Convention on Biological Diversity? Can old mandates, structures and styles and cultures of work address what are substantively new requirements and opportunities?

For example, current rates of biodiversity loss are caused at least in part by inappropriate and even perverse policies and incentives (see Section 12). Public agencies have jurisdictions that overlap; landscapes and ecosystems are fragmented not only ecologically but also administratively. For example, salmon and other commercial fish species may pass through areas under the management of several public agencies and community-based management systems as they swim from the open sea to upper stream spawning areas. Marine turtles swim through international waters, through the nearshore coastal areas of different countries, and up on to beaches near local communities where they lay their eggs. Can public and community organizations establish co-operative regimes that cut across arbitrary (for biodiversity management purposes at least) administrative lines and focus on the real biodiversity issue? How can we protect and control the use of salmon and marine turtles throughout their range?

Creative approaches to institutional change are, however, being tried to manage biodiversity more effectively. Colombia's new constitution explicitly addresses the needs of biodiversity conservation and sustainable use, as well as

the security of indigenous peoples (Jacanamejoy 1994). Canada has developed a round-table process at the provincial level to draw local residents and into the preparation of its national biodiversity strategy (NRTEE 1993). Costa Rica's Ministry of Natural Resources has expanded the scale of its protected areas planning, building upon key traditional national parks to embrace whole bioregions, such as the La Amistad Biosphere Reserve, in co-operation with local governments and residents and the Government of Panama (Gobierno de Costa Rica 1990). Bilateral, multilateral and private funding sources have demonstrated a willingness to support work by governments and NGOs to establish and protect sites, collect plant and animal materials, develop new software programmes for computerized databases, and work with local communities as they seek sustainable resource-use patterns (Metcalf 1993). The US-based INTERGRAPH corporation is assisting the Costa Rican National Biodiversity Institute develop advanced software programmes for the management of complex biodiversity information. The UK Overseas Development Administration (ODA) is assisting Bangladesh to build a national herbarium with associated training programmes.

13.7.4 Infrastructure capacity

An array of building structures, transport services, communications devices and equipment is also needed to support a wide range of activities, such as those listed in Box 13.7-3. But investment in facilities, however necessary, poses a dilemma. While sources of funds for structures and equipment are relatively easy to find, it is often difficult to find the resources to maintain infrastructure. In addition, infrastructure investments are typically made in or near urban centres, especially near capital cities – far away from many of the areas most important for biodiversity management.

Furthermore, where investments in physical structures are made in place of investments in human resources, there may be an implicit bias in favour of government agency, university, and industry-based work instead of efforts supporting rural farmers, forest workers, fisherfolk, wildlife-based communities and local government. The aim should be to facilitate the work of all those elements called for in the national biodiversity plan. Typically, a national budget may well include funds for a mixture of investments and expenditures drawn from a number of the items contained in Box 13.7-3. The challenge to governments and other involved institutions is to find a balance between expenditures on physical plant and equipment, and expenditure on the other material needs of biodiversity management activities.

13.7.5 Funding capacity

Human capacity, institutions and facilities all require financial support to cover capital assets (e.g. buildings,

equipment, transport, land, etc.) and recurrent costs (e.g. salaries, personal benefits, travel, supplies, rent, energy and fuel, waste disposal, maintenance, insurance and overheads). Despite evidence of modest growth in conservation funding support in recent years, it is clear that biodiversity needs continue to vastly exceed the financial resources available. All countries and institutions involved in biodiversity management face questions about how existing financial resources should be allocated, and where and how to raise the additional funds needed to meet management objectives. And while funding overall falls short of requirements to adequately manage biodiversity, some countries have been overwhelmed by international assistance for biodiversity conservation. Donors, therefore, should deliver foreign assistance in ways that build, but do not swamp, a recipient country's 'absorptive capacity'.

Finance for biodiversity management is provided by three main sources: national and state/provincial government appropriations; private foundations and individual contributors to non-governmental organizations; and international bilateral and multilateral donors in the case of many countries in the tropics and eastern Europe. Decisions about funding biodiversity are complex for several reasons. First, most issues and options for action and investment involve multiple costs and benefits. Some potential investments will produce direct and tangible benefits in terms of food and nutrition, fibre and materials, water and soils, and tourism and recreation. Other investments will produce more indirect and often speculative benefits, such as potential medicines, new foods and improved crops. Some potential investments are in activities that produce benefits for overall regional and global geochemical, climatic and hydrological processes, but they may not be high priorities at national or local levels. In this latter case, it is presumed that global financial mechanisms, such as the Global Environment Fund, should cover the cost on behalf of the global community (see Section 12 for discussion of valuation and incremental costs).

A variety of new and innovative funding mechanisms, including debt-swaps, public/private co-financing, and trust funds dedicated to biodiversity management, have been developed in recent years (see Section 12). Among the most promising are 'national environment funds' established within individual countries under local boards of directors (e.g. Bolivia, Bhutan and Indonesia). Such funds are established under national legislation, and have a board of directors made up of local, national and international experts, and formal administrative procedures for the receipt, management and disbursement of funds. Funds can come from a variety of sources – international donors, private foundations, individual contributors and government appropriations. Typically, national environment funds do not themselves engage directly in project

management. Rather, they restrict their role to facilitating local management by other groups, including communities and NGOs (Dillenbeck 1994).

Such funds have several advantages over conventional annual government appropriations and donor-driven project financing. First, funds are allocated through a deliberative process involving knowledgeable and experienced board members who are, at least hypothetically, representative of those involved in the country's management of biodiversity. Second, since the resources in a national environment fund can be disbursed slowly or rapidly according to needs, they may avoid situations where a country's absorptive capacity is overwhelmed, or promising projects are ended arbitrarily, because of uncoordinated donor programmes. Third, in countries where biodiversity management relies on external support, national environment funds allow recipient countries to have more influence on where funds go to meet national biodiversity management goals. Fourth, if properly established and managed, national environment funds

provide a mechanism that is accountable to the public and to donors for the wise use of biodiversity management funds.

It is extremely difficult to estimate how much is now being spent, globally, on the management of biodiversity. Funding levels for some biodiversity management activities, protected areas in particular, are better documented than others. Based on data from IUCN (1994a) and WCMC (1992), protected areas budgets world-wide now total approximately US\$4.1 billion. This amounts to roughly \$450 per square kilometre per year for protected areas included in the IUCN World List of protected areas (IUCN 1994b). By comparison, the world spends \$1 trillion on defence and \$245 billion on agricultural subsidies (WRI/IUCN/UNEP 1992). To manage biodiversity effectively on a global basis, the Global Biodiversity Strategy (WRI/IUCN/UNEP 1992) estimated that approximately \$17 billion is needed annually. This estimate, however, is extremely rough; no systematic assessment with clearly defined objectives and assumptions has been made.

Box 13.7-3: Typical biodiversity activities requiring installations and implements.

Protected areas: housing for personnel, research laboratories, interpretative and educational structures, storage for collections, computers for data, monitoring devices.

Botanical gardens, zoological gardens, germplasm banks: housing for personnel, structures for storage and display of resources, educational and research facilities, grounds for out-planting, grounds for 'bulking up' plant and animal materials prior to reintroduction and restoration work, networks of village-based seed storage facilities.

Laboratories and research centres: taxonomy and storage, equipment for chemical extraction, analysis and research, experimental areas, educational and visitor equipment and access, and dormitories where needed to facilitate full participation of workers often from scattered rural sites.

Captive breeding centres: buildings, laboratories, corrals, grounds.

Local plant and animal propagation and breeding sites: rural grounds, greenhouses and planting beds, corrals and pens.

Rural extension and community centres: meeting sites with necessary buildings and communications equipment.

Transportation: various types of vehicles for transporting personnel, hauling plant and animal materials, surveying and inventorying of often vast terrestrial and marine areas.

Training centres: in conjunction with universities, rural community centres, public agencies, private enterprise and local government, a series of suitable buildings, meeting room furnishings, educational and communications equipment.

Customs stations and biosafety facilities: possibly in conjunction with established national customs installations, equipment needed to examine, store, test, quarantine and distribute or dispose of imported exotic species and genetically modified organisms.

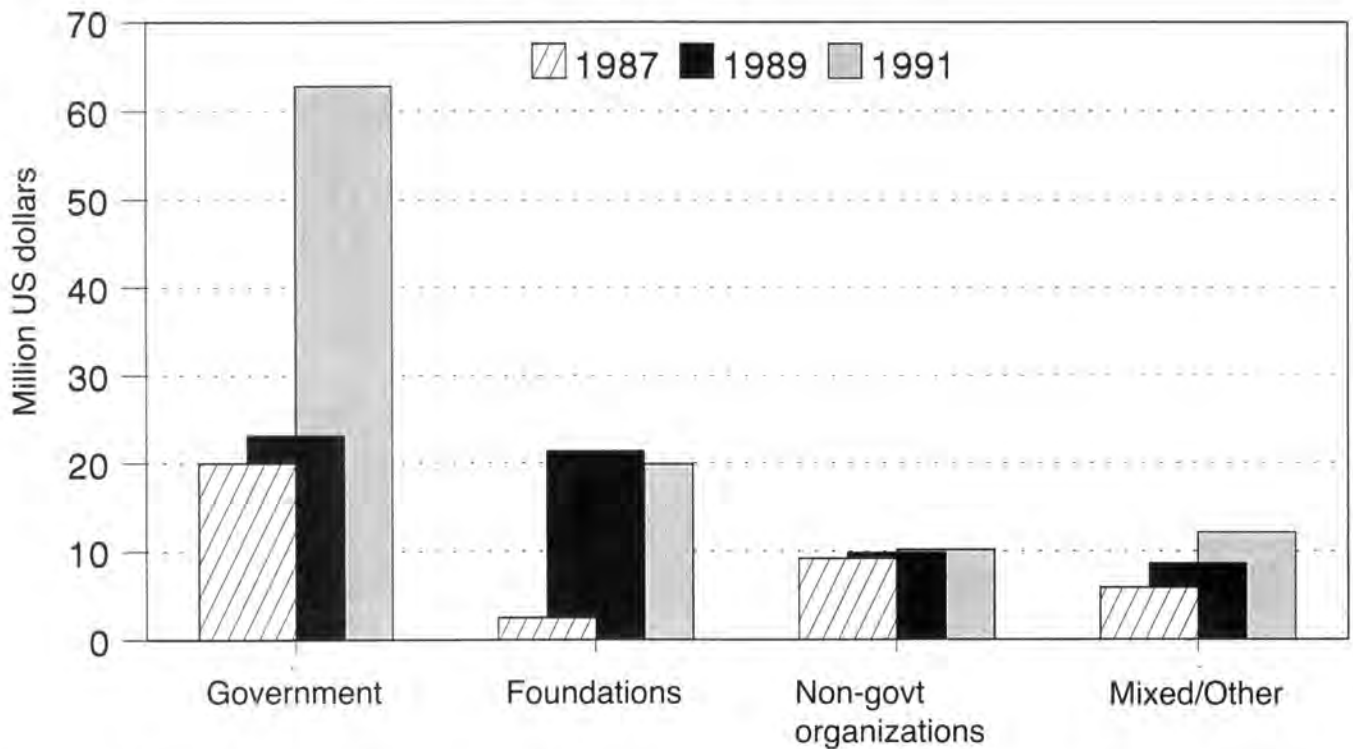

Figure 13.7-2: Financial support from US sources to biodiversity conservation activities in developing countries. (Source: Abramovitz 1994.)

Clearly, however, much more funding is needed, especially in developing countries where the greatest biotic wealth is found, alongside the least capacity to manage it. Abramovitz (1994) estimates that funding for biodiversity conservation in developing countries from all sources in the United States, including government, private foundations, and NGOs, totalled US\$105 million in 1991 (see Figure 13.7-2). The World Conservation Monitoring Centre is conducting additional surveys to better assess international funding levels around the world.

The GEF intends to allocate approximately US\$250 million annually for the three years 1995-1997 to biodiversity management projects. Recent evaluations of the GEF's pilot project phase concluded that the programme has had mixed success (Bowles and Prickett 1994; UNDP/UNEP/World Bank 1994). The most important problems have been a lack of participation by local communities and government leaders, and a mismatch between short-term, large-scale project funding and the long-term needs, and small or modest project capacity, of recipient countries.

In developed and developing countries alike, new and additional financial resources for biodiversity management are limited. Therefore, before seeking additional funding biodiversity planners should first ask if changes can be made within existing budgets to meet biodiversity goals more effectively. For example, can existing protected sites meet biodiversity conservation objectives with small budget changes? If new sites are needed, what is the least-

cost approach to meeting habitat and biodiversity representation goals? Can botanic garden and zoo programmes be shifted to focus more on local species? Should existing species collections focus first on national biota of scientific, educational and economic interest?

In most countries, biodiversity management has largely been the responsibility of public sector institutions, while private sector institutions in a wide range of activities from agriculture to ecotourism have benefited from these investments. What role can the private sector play in supporting biodiversity management? If the role of the public sector is to focus on establishing and managing protected areas, education, basic and conservation biology research, monitoring and strategic planning, should the private sector, including NGOs and business, play more of a role in other areas? For example, should the private sector take more of a role in supporting the inventory, characterization and assessment of species because of their link to potential new products and services? What incentives are needed to encourage the private sector to play a larger role in biodiversity management? Other roles and balances can be considered. Finding an appropriate balance between public and private sector involvement in biodiversity management is a process that has just begun.

Where existing budgets fail to cover financial requirements to meet objectives, to what extent should a country borrow or seek international financial co-operation for biodiversity management? The biotic wealth of a nation is considered by some to be perhaps the most sensitive and

sovereign of a nation's assets, aside from its people. What are the ethical and legal implications of using biotic wealth as collateral for loans or other market or trade arrangements? The Convention on Biological Diversity includes a commitment by the wealthier parties to share in the investment costs needed to help less wealthy nations protect their biodiversity and to shift to sustainable use practices.

13.7.6 Conclusion

Section 13 has illustrated an array of options for the protection and sustainable use of biodiversity and biological resources. There are tools and mechanisms available for the protection of species, genetic variation, habitats and ecosystems in the field at various scales, ranging from site-specific actions to the bioregional and landscape scale. Careful management of goods and environmental services, in forestry, agriculture, fishing, wildlife and tourism is a key factor in providing benefits to local residents and the national and global marketplace. Alternative approaches have been suggested to help maintain the values of biodiversity while addressing economic and social goals.

Closely allied with on-site measures are a whole range of off-site or *ex situ* mechanisms to maintain seed and tissue collections, propagate and breed endangered species, preserve reduced genetic strains, and offer methods of restoring communities and reintroducing species.

Governments, communities and industry (see, for example, Krattiger *et al.* 1994), poised to initiate and engage in biodiversity conservation and development efforts, may now draw upon methods and techniques based on the knowledge and experience from around the world. These experiences suggest that there now exists a full set of tools that will fit most situations. It is also clear that existing science, technology and information can help modify and adapt these tools to local conditions and values.

The limiting factor for developing and implementing successful biodiversity policies appears to be the capacity that each nation has available for managing its biotic wealth. More specifically, the success of biodiversity management programmes will depend greatly on how each nation encourages its human capacity to design and carry out intellectual and practical tasks ranging from inventorying to exploiting biotechnology. Various types of physical facilities and infrastructures are needed to house collections and training establishments, transport scientists and practitioners, foster research in sustainable technologies, and so on. Finally, there is the need for financial capacity. Various approaches have been shown to assist countries cover the financial costs of their biodiversity programmes, at least during initial phases, to establish such programmes.

Thus, existing knowledge, technology and information

suggest that countries can move forward with conservation and development plans, with the certainty that tools to help manage the associated activities are available. Countries are urged, however, to approach biodiversity management in an experimental mode, being prepared to adapt to changing conditions and information. Continuing research can be expected to provide policy-makers with a growing sense of certainty, even as new mysteries of nature are uncovered. Given the expectations of a growing population for food, fibre, water, air, medicines and a host of environmental services and spiritual values, there is little alternative to forging ahead, taking full advantage of existing knowledge, technology and information to help navigate in stormy seas with reasonable precision.

References

- Abramovitz, J.N.** 1994. *Trends in Biodiversity Investments*. World Resources Institute, Washington, DC.
- Bowles, L.A.** and Prickett, G.T. 1994. *Reframing the Green Window: An Analysis of the GEF pilot phase approach to biodiversity and global warming and recommendations for the operational phase*. Conservation International and Natural Resources Defence Council, Washington, DC.
- CET.** 1991. *Status and Trends in Grass-Roots Crop Genetic Conservation Efforts in Latin America*. Centro de Educación y Tecnología, Santiago.
- Dillenbeck, M.** 1994. *National Environmental Funds: A New Mechanism for Conservation Finance*. The World Conservation Union/US, Washington, DC.
- Gobierno de Costa Rica,** Ministerio de Recursos Naturales, Energía y Minas, Ministerio de Planificación Nacional y Política Económica. 1990. *Estrategia para el Desarrollo Institucional de La Reserva de la Biósfera 'La Amistad'*. Conservación Internacional y la Organización de los Estados Americanos. San José, Costa Rica.
- Government of Kenya.** 1992. *The Costs, Benefits and Unmet Needs of Biological Diversity Conservation in Kenya*. Government of Kenya, Nairobi.
- Government of the United Kingdom.** 1994. *Biodiversity: The UK Action Plan*. Department of Environment, London.
- Great Barrier Reef Marine Park Authority.** 1993. *1993-2000 Corporate Plan*. Great Barrier Reef Marine Park Authority, Townsville, Queensland.
- Hawkes, J.G.** (ed.) 1991. *Genetic Conservation of World Crop Plants*. Academic Press, London.
- Holling, C.S.** 1993. Investing in the search for sustainability. *Ecological Applications* 3: 552-555.
- Hoyt, E.** 1992. *Conserving the Wild Relatives of Crops*. International Board for Plant Genetic Resources (IBPGR), Rome, The World Conservation Union and World Wildlife Fund for Nature, Gland.
- IUCN.** 1994a. *A Guide to the Convention on Biological Diversity*. IUCN, Gland.
- IUCN.** 1994b. *United Nations List of National Parks and Protected Areas*. IUCN, Gland.

- Jacanamejoy, G. M.** 1994. Community participation in the conservation of biodiversity. In: Krattiger, A.F., McNeely, J.A., Lesser, W.H., Miller, K.R., St Hill, Y. and Senanayake, R. (eds), *Widening Perspectives on Biodiversity*. 229–232. IUCN, Gland, and The International Academy of the Environment, Geneva.
- Johnson, N.** and Cabarle, B. 1993. *Surviving the Cut: Natural forest management in the humid tropics*. World Resources Institute, Washington DC.
- Krattiger, A. F., McNeely, J. A., Lesser, W.H., Miller, K.R., St Hill, Y. and Senanayake, R.** (eds), 1994. *Widening Perspectives on Biodiversity*. IUCN, Gland, and The International Academy of the Environment, Geneva.
- Lynch, O.** 1992. Securing Community-Based Tenurial Rights in the Tropical Forests of Asia: An Overview of Current and Prospective Strategies. *Issues in Development Series*. World Resources Institute, Washington, DC.
- Metcalfe, S.** 1993. The Zimbabwe Communal Areas Management Programme for Indigenous Resources (CAMPFIRE). Paper prepared for the Liz Claiborne and Art Orenberg Foundation Community Based Conservation Workshop, 18–22 October 1993, Arlie, Va.
- Miller, K.R.** and Lanou, S.M. 1995. *National Biodiversity Planning: Guidelines for preparation based on early experiences around the world*. World Resources Institute, Washington, DC, United Nations Environment Programme, Nairobi, and IUCN, Gland.
- Ministry of Science, Technology and Energy.** 1992. *Thailand Country Study on Biodiversity*. Ministry of Science, Technology and Energy, Bangkok.
- NRTEE.** 1993. *National Round Table on the Environment and the Economy: Annual Review 1992–93*. Environment Canada, Ottawa.
- Poffenberger, M.** 1990. *Joint Management of Forest Lands: Experiences from South Asia*. Ford Foundation, New York.
- Reti, I.** 1995. The South Pacific Biodiversity Conservation Program. In: Miller, K.R. and Lanou, S.M. (eds), *National Biodiversity Planning: Guidelines for preparation based on early country experiences around the world*. World Resources Institute, Washington, DC. United Nations Environment Programme, Nairobi and IUCN, Gland, Switzerland.
- Sizer, N.** and Rice., R. 1995. *Backs to the Wall in Suriname: Forest policy in a country in crisis*. World Resources Institute, Washington, DC.
- Thelen, K.D.** 1992. Red de cooperación Técnica para áreas protegidas en Latinoamérica. *Parks* 3: 50–53.
- UN.** 1993. *Agenda 21, Rio Declaration, Forest Principles: The Final Text of Agreements*. United Nations, New York.
- UNDP/UNEP/World Bank.** 1994. *Global Environment Facility: Independent evaluation of Phase I*. United Nations Development Programme, New York, United Nations Environment Programme, Nairobi, and World Bank, Washington, DC.
- Wang, H., Chen, S., and Wang, S.** 1989. China. In: Campbell, D.G. and Hammond, D. (eds), *Floristic Inventory of Tropical Countries*. 35–43. New York Botanical Gardens, New York.
- WCMC.** 1992. *Global Biodiversity: Status of the Earth's living resources*. Chapman and Hall, London.
- WRI/IUCN/UNEP.** 1992. *Global Biodiversity Strategy: Guidelines to save, study, and use the Earth's biotic wealth equitably and sustainably*. World Resources Institute, Washington, DC, IUCN, Gland, Switzerland, and United Nations Environment Programme, Nairobi.

Acknowledgements

The co-ordinators of Section 13 wish, first of all, to thank each of the authors and contributors who have taken the time and effort to share their knowledge about the many dimensions of biodiversity management. They often did so without compensation and under very short deadlines. Participants at workshops in Nairobi and Bangalore to review Sections 11 and 13 also contributed in many ways to this Section. The co-ordinators are grateful to the nearly 100 reviewers around the world who contributed thoughtful and constructive suggestions to improve the content and accuracy of Section 13. Jane Scully is recognized for her editorial contributions to a lengthy and complex document. Not least, the research and administrative help of Donna Dwiggin, Lisa Sullivan, Joanna Napies, and Cathy Karr were indispensable to the production of Section 13.

Annex 1

Organization of the Global Biodiversity Assessment

The GBA is the result of a complex operation involving many organizations, institutions and individuals throughout the world. The overall structure is given in the accompanying box.

The organization of the GBA.

Chairman
Executive Editor
Task Manager (UNEP)

Honorary Advisers
Editorial Group
Management Group

Expert Teams

Focal Point Co-ordinators
Co-coordinators
Lead Authors
Authors

Peer Review

Institutional reviewers
Government-nominated reviewers
Individual reviewers
Peer Review Workshop

Chair:

Dr Robert T. Watson
Office on Science and Technology Policy, OSTP
Executive Office of the President
Washington DC 20506, USA

Executive Editor

Prof. Vernon H. Heywood
School of Plant Sciences
The University of Reading
Whiteknights, PO Box 221
Reading RG6 2AS, UK

Co-ordinators

Prof. Mary Helena Allegretti
Governo do Estado do Amapa
Secretaria de Planejamento, Av. FAB 83
68906-000 Macapa, Amapa, Brazil

Prof. Robert Barbault
Université Pierre et Marie Curie
Institut Fédératif d'Ecologie Fondamentale
et Appliquée
7 quai Saint Bernard, Bat. A, Case 237
F-75252 Paris Cédex 05, France

Dr Bryan A. Barlow
CSIRO Division of Plant Industry
Institute of Plant Production and Processing
GPO 1600, Canberra ACT 2601, Australia

Dr Frank A. Bisby
Biodiversity and Bioinformatics Research Group,
Department of Biology
University of Southampton
Southampton SO16 7PX, UK

Dr John R. Busby
World Conservation Monitoring Centre
219 Huntingdon Road
Cambridge CB3 0DL, UK

Mr N. Mark Collins
World Conservation Monitoring Centre
219 Huntingdon Road
Cambridge CB3 0DL, UK

Dr Rodolfo Dirzo
Centro de Ecología, UNAM
Apartado Postal 70-275
04510 México DF, Mexico

Prof. Madhav Gadgil
Ecology Division
Indian Institute of Science
Bangalore 560012, India

Mr Jeremy Harrison
World Conservation Monitoring Centre
219 Huntingdon Road
Cambridge CB3 0DL, UK

Prof. David L. Hawksworth
International Mycological Institute
Bakeham Lane, Egham
Surrey TW20 9TY, UK

Mr Nels Johnson
Biological Resources Programme
World Resources Institute
1709 New York Avenue NW
Washington DC 20006, USA

Dr Bror Jonsson
Norwegian Institute for Nature Research
Tungasletta 2
N-7005 Trondheim, Norway

Prof. Mary T. Kalin-Arroyo
Departamento de Biología
Facultad de Ciencias
Universidad de Chile
Casilla 653, Nuvoa, Santiago, Chile

Prof. Christian Levêque
Fresh Water Department, ORSTOM
213 Rue la Fayette
75480 Paris Cédex 10, France

Prof. Jane Lubchenco
Department of Zoology
Oregon State University
Cordley Hall 3029
Corvallis, OR 97331-2914, USA

Mr Jeffrey A. McNeely
IUCN - The World Conservation Union
Rue Mauverny 28
CH-1196 Gland, Switzerland

Dr Kenton Miller
Biological Resources and Institutions
World Resources Institute
1709 New York Avenue NW
Washington DC 20006, USA

Prof. Harold A. Mooney
Department of Biological Sciences
Stanford University
Herrin Labs, Room 459
Stanford, CA 94305, USA

Mr Silvio Olivieri
Conservation Planning
Conservation International, Suite 1000
1015 8th Street NW
Washington DC 20036, USA

Dr Christine Padoch
Institute of Economic Botany
The New York Botanical Garden
Southern Boulevard and 200th Street
Bronx, NY 10458-5126, USA

Prof. Charles Perrings
Department of Environmental Economics and
Environmental Management
University of York
Heslington, York YO1 5DD, UK

Prof. Osvaldo E. Sala
Departamento de Ecología
Universidad de Buenos Aires
Facultad de Agronomía
Av. San Martín 4453
Buenos Aires 1417, Argentina

Prof. Michael J. Samways
Invertebrate Conservation Branch Centre
Department of Zoology and Entomology
University of Natal
Private Bag X01, Scottsville 3209
Pietermaritzburg, South Africa

Dr. Setijati D. Sastrapradja
R&D Centre for Biotechnology
Indonesian Institute of Sciences
Jalan Raya Bogor Km. 46
Cibinong 16911, Bogor, Indonesia

Prof. Nigel E. Stork
Biodiversity Division
Department of Entomology
The Natural History Museum
Cromwell Road, London SW7 5BD, UK

Dr George T. Tzotzos
ICGEB Vienna Office, UNIDO
VIC, PO Box 300
A-1400 Vienna, Austria

Honorary Advisers

Dr. Peter Hamilton Raven
Missouri Botanical Garden
PO Box 299
St Louis, MO 63166-0299, USA

Prof. Emil Salim
Bona Indah CII/1
Lebak Bulus, Jakarta 12440, Indonesia

Dr M.S. Swaminathan
M.S. Swaminathan Research Foundation
3rd Cross Street, Taramani Institutional Area
Madras 600113, India

Prof. Edward O. Wilson
Museum of Comparative Zoology
Harvard University
26 Oxford Street
Cambridge, MA 02138-2902, USA

Steering Group

Dr Murthi N. Anishetty
Plant Production and Protection Div, FAO
Viale Delle Terme Di Caracalla
00100 Rome, Italy

Prof. Eduardo Fuentes
GEF-UNDP
1 United Nations Plaza, Room 1086
New York, NY 10016, USA

Dr Masa Iwanaga
International Plant Genetic Resources Institute
Via Delle Sette Chiese 142
00145 Rome, Italy

Prof. D. Janzen
c/o Instituto Nacional de Biodiversidad
Santo Domingo de Heredia, Costa Rica

Ms Natalie Johnson
The World Bank, Headquarters,
Washington DC 20433, USA

Dr C. Juma
Convention on Biological Diversity
Secretariat, 15, Chemin des Anémones,
CP 356, CH-1219, Châtelaine, Geneva, Switzerland

Dr R. Olembo
United Nations Environmental Programme
Nairobi, Kenya

Dr Christel Palmberg-Lerche
Forest Resources Division, FAO
Viale Dell Terme Di Caracalla
00100 Rome, Italy

Dr Robin Pellew
WWF UK
Panda House
Godalming, Surrey, UK

Dr Mario A. Ramos
GEF Administrator's Office
The World Bank, Headquarters
Washington DC 20433, USA

Dr Kent Redford
The Nature Conservancy
1815 N Lynn Street
Arlington, VA 22209, USA

Dr Jane Robertson-Vernhes
Division of Ecological Sciences
UNESCO
7 Place de Monteroy,
F-75015 Paris, France

Dr Peter Schei
Directorate for Nature Management
Tungasletta 2
N-7004 Trondheim, Norway

Dr Ranil Senanayake
Environment Liason Centre International
PO Box 72461,
Nairobi, Kenya

Dr Bella Raphael Striganova
Institute of Ecology and Evolution
Russian Academy of Sciences
33 Lenin Avenue
Moscow 117071, Russia

Prof. Wang Xongyi
Beijing, China

Editorial Group

Dr Bráulio F.S. Dias
Dept. de Formulação de Políticas
e Programas Ambientais
Min. do Meio Ambiente dos Recursos
Hídricos e Amazônia Legal, Bl. B-8 andar
Brasília DF, Brazil

Dr Rodrigo Gámez
Instituto Nacional de Biodiversidad
PO Box 22-3100
Santo Domingo de Heredia, Costa Rica

Dr Anthony C. Janetos
Ecology & Atmosphere Chemistry Branch
NASA Headquarters, CODE YSE
300 E Street SW,
Washington DC 20506, USA

Dr Walter V. Reid
World Resources Institute
1709 New York Avenue, NW
Washington DC 20006, USA

Dr Greg Ruark
Office of Sciences and Technology, OSTP
Executive Office of the President
Washington DC 20506, USA

Annex 2

List of Institutions and staff involved in the GBA project

- University of Southampton, Southampton, UK
Frank A. Bisby, Focal Point Co-ordinator Section 2
Simon J. Duffield
- Centre National de la Recherche Scientifique, Paris, France
Alain Chanudet, Le Délégué régional adjoint Ile-de-France
Robert Barbault, Focal Point Co-ordinator Section 4
- International Mycological Institute, Surrey, UK
David L. Hawksworth, Focal Point Co-ordinator Sections 3 and 8
Begoña Aguirre-Hudson
- The Natural History Museum, London, UK
Nigel E. Stork, Focal Point Co-ordinator Section 7
Harriet A.C. Eeley
- The Scientific Committee on Problems of the Environment, France
Véronique Plocq-Fichelet, Executive Director
H.A. Mooney, Vice-President, Focal Point Co-ordinator Sections 5 and 6
- University of York, UK
Charles Perrings, Focal Point Co-ordinator Section 12
Robin J. Dong, Research Assistant
Antxton Olabe, Research Assistant
- IUCN - The World Conservation Union, Switzerland
Jeffrey A. McNeely, Focal Point Co-ordinator Section 11
Caroline Martinet, Programme Officer
Sue Rallo, Secretary
- World Resources Institute, USA
Kenton Miller, Focal Point Co-ordinator Section 13
Nels Johnson, Co-ordinator Section 13
- CSIRO, Institute of Plant Production and Processing, Australia
Bryan A. Barlow, Focal Point Co-ordinator Section 10
- Conservation International, USA
Silvio Olivieri, Focal Point Co-ordinator Section 9
- The University of Reading, UK
Vernon Heywood, Executive Editor
Keith Gardner, Editorial Assistant
Anne Phillips, Secretary
Victoria Bonham, Assistant
- United Nations Environment Programme, Nairobi, Kenya
Ivar A. Baste, Task Manager
Marasee Buranathai, Senior Secretary
Feargal Duff, Fund Management Officer
Inès Verleye, Junior Professional Officer

Annex 3

Venues, dates and participants in GBA meetings and workkshops

Major Workshops and Review Meetings

Preparatory Group for the GBA, Montreal, 15–16 March 1993

Gerardo Ceballos, Mexico	Christian Levêque, France	Robin Pellew, UK
Madhav Gadgil, India	Jeffrey A. McNeely, Switzerland	Edward Rege, Kenya
Edgardo Gómez, Philippines	Kenton Miller, USA	Jukka Salo, Finland
Jorge Hernández Camacho, Mexico	Abdul Latiff Mohamed, Malaysia	Peter Schei, Norway
Vernon H. Heywood, UK	Harold A. Mooney, USA	Bella Striganova, Russia
John N.R. Jeffers, UK	R. Olembo, UNEP	Sediono Tjondronegoro, Indonesia
Paulo Y. Kageyama, Brazil	Gunilla Olsson, Sweden	Robert T. Watson, USA

Steering Committee on the GBA, Trondheim, 31 May–2 June 1993

Murthi N. Anishetty, FAO	Nathalie Johnson, USA	Mikko Pyhäla, UNEP
Robert Barbault, France	Calestous Juma, Kenya	Mario A. Ramos, The World Bank
Ivar A. Baste, Norway	Peter Jutro, USA	Jane Robertson-Vernhes, UNESCO
Eduardo Fuentes, Chile	Christian Levêque, France	Setijati D. Sastrapradja, Indonesia
Madhav Gadgil, India	Jeffrey A. McNeely, Switzerland	Peter Schei, Norway
Edgardo Gómez, Philippines	Kenton Miller, USA	Ranil Senanayake, Sri Lanka
Winnie Hallwachs, USA	Harold A. Mooney, USA	Bella Striganova, Russia
David L. Hawksworth, UK	R. Olembo, UNEP	Robert T. Watson, USA
Vernon H. Heywood, UK	Gunilla Olsson, Sweden	Wang Xongyi, China
Masa Iwanaga, Italy	Christel Palmberg-Lerche, FAO	Hamdallah Zedan, UNEP
Daniel Janzen, Costa Rica	Robin Pellew, UK	

Section Coordination Meeting, Buenos Aires, 27–28 January 1994

Robert Barbault, France	Vernon H. Heywood, UK	Mario A. Ramos, The World Bank
Bryan A. Barlow, Australia	Anthony Janetos, USA	Oswaldo E. Saia, Argentina
Ivar A. Baste, UNEP	Caroline Martinet, Switzerland	Peter Schei, Norway
Donna Dwiggins, USA	Jeffrey A. McNeely, Switzerland	Ranil Senanayake, Sri Lanka
Jerry Harrison, UK	R. Olembo, UNEP	Nigel E. Stork, UK
David L. Hawksworth, UK	Silvio Olivieri, Chile	Robert T. Watson, USA

Meeting for Development of the Summary for Policy Makers, Washington, 31 January–2 February 1995

Bryan A. Barlow, Australia	Anthony C. Janetos, USA	Greg Ruark, USA
Ivar A. Baste, UNEP	Nels Johnson, USA	Osvaldo E. Sala, Argentina
Frank A. Bisby, UK	Jeffrey A. McNeely, Switzerland	Ranil Senanayake, Sri Lanka
R.J. Ranjit Daniels, India	Kenton Miller, USA	Nigel E. Stork, UK
Bráulio F.S. Dias, Brazil	Silvio Olivieri, USA	Robert T. Watson, USA
David L. Hawksworth, UK	Charles Perrings, UK	
Vernon H. Heywood, UK	Walter V. Reid, USA	

Peer Review Workshop, Panama, 12–16 June 1995

Bryan A. Barlow, Australia	W. Stewart Grant, USA	Harold A. Mooney, USA
Ivar A. Baste, UNEP	H. Guzman, Panama	John L. Munro, Philippines
Zeineb Belkhir, Tunisia	P.M. Hammond, UK	Silvio Olivieri, Chile
Frank A. Bisby, UK	Jeremy Harrison, UK	Charles Perrings, UK
Susan Bragdon, UNEP	David L. Hawksworth, UK	Richard B. Primack, USA
Vanderlei Perez Canhos, Brazil	Vernon Heywood, UK	Walter V. Reid, USA
Mikhail Ilych Chatoumovski, Russia	Kjetil Hindar, Norway	Greg Ruark, USA
Jean Chazeau, New Caledonia	Masa Iwanaga, IPGRI	Ira Rubinoff, Panama
Joel J. Cracraft, USA	Anthony C. Janetos, USA	Michael J. Samways, South Africa
R.J. Ranjit Daniels, India	Nels Johnson, USA	Setijati D Sastrapradja, Indonesia
I.D. De Murtas, Italy	Bror Jonsson, Norway	Peter Schei, Norway
Dulce Eleonora de Oliveira, Brazil	Mary T. Kalin-Arroyo, Chile	Cyriaque Sendashonga, UNEP
Sharon Dhadialla, Canada	Kadzo Kangwana, Kenya	Jameson Henry Seyani, Malawi
Bráulio F.S. Dias, Brazil	Evans Lagudah, Australia	Kenneth Sherman, USA
Rodolfo Dirzo, Mexico	Christian Levêque, France	Nigel E. Stork, UK
James L. Edwards, USA	Michel Loreau, France	Bella Raphael Striganova, Russia
Peter J. Edwards, Switzerland	Thomas E. Lovejoy, USA	George T. Tzotzos, UNIDO
Fern L. Filion, Canada	Jane Lubchenco, USA	Inês Verleye, UNEP
Eduardo Fuentes, UNDP	H. Gyde Lund, USA	Robert T. Watson, USA
Rodrigo Gámez, Costa Rica	Kathy MacKinnon, The World Bank	Tony Whitten, The World Bank
Keith Gardner, UK	N. Manokaran, Malaysia	David Wood, UK
Francesco Gattesco, Italy	Jeffrey A. McNeely, Switzerland	S. Joseph Wright, Panama
Gudrun Gaudian, West Indies	Kenton Miller, USA	
David R. Given, New Zealand	Jerry Moles, USA	

Editorial Group Meetings

Ivar A. Baste, UNEP
Bráulio F.S. Dias, Brazil
Rodrigo Gámez, Costa Rica

Vernon Heywood, UK
Anthony C. Janetos, USA
Walter V. Reid, USA

Greg Ruark, USA
Inês Verleye, UNEP
Robert T. Watson, USA

- Washington, 20–21 March 1995
- Washington, 27–28 April 1995
- Washington, 28–29 June 1995
- Washington, 3–4 August 1995
- Reading, 1–2 September 1995

Presentations of GBA

- The Open Ended Intergovernmental Meeting of Scientific Experts on the Convention on Biological Diversity, Mexico City, 11–15 April 1994.
- The first meeting of the Conference of Parties to the Convention on Biological Diversity, Bahamas, 2–6 December 1994.
- The first meeting of the Subsidiary Body on Scientific Technical and Technological Advice of the Convention on Biological Diversity, Paris, 4–8 September 1995.

Section Workshops

Section 1 Workshop, Trondheim, 30 October–1 November 1994

Ivar A. Baste, UNEP
Vernon Heywood, UK

Kjetil Hindar, Norway
Bror Jonsson, Norway

Peter Schei, Norway

Section 2 Workshop, Paris, 11–16 July 1994

Attended by 25 experts from: France, Germany, India, Malawi, Netherlands, New Zealand, Russia, Spain, UK and USA.

Sections 3 and 8 Workshop, Surrey, 25–29 April 1994

Frank A. Bisby, UK
B. Boom, USA
R. Cowling, South Africa
T. Crowe, South Africa
T. Cullen, UK
J. Engels, IPGRI, Italy
B. Groombridge, UK
S.J.G. Hall, UK
P.M. Hammond, UK
Jean Hanson, Ethiopia

David L. Hawksworth, UK
Vernon Heywood, UK
G. Hinkle, USA
Mary T. Kalin-Arroyo, Chile
Steven Lanou, USA
Pierre Lasserre, UNESCO, France
T.M. Lewinsohn, Brazil
D. Jean Lodge, Puerto Rico
Norman I. Platnick, USA
Robert E. Ricklefs, USA

Michael J. Samways, South Africa
J. Simonetti, Chile
Hideaki Sugawara, Japan
D.B. Sumithraarachchi, Sri Lanka
D. Wright, USA

Research Assistants

B. Aguirre-Hudson, UK
H. Fox, UK

Section 4 Workshop, Station Biologique de Foljuif, France, 7–11 November 1993

Robert Barbault, France	Kjetil Hindar, Norway	Abou Sarr, France
Jean Clobert, France	Hiroya Kawanabe, Japan	Barbara A. Schaal, USA
Raul Garcia Barrios, Mexico	Yannis Michalakis, France	Montgomery Slatkin, USA
Pierre-Henri Gouyon, France	Guinilla Almered Olsson, Sweden	Gabor Vida, Hungary
Ilkka Hanski, Finland	Rai Singh Rana, India	Jean-Denis Vigne, France

Section 4 Workshop II, Paris, 28–29 June 1995

Robert Barbault, France	Hiroya Kawanabe, Japan	Yannis Michalakis, France
Jean Clobert, France	Michel Loreau, France	Francois Renaud, France

Sections 5 and 6 Workshops**Tropical Savannahs****Brasilia, Brazil****24–28 May, 1993.***Organizers:*

O.T. Solbrig, USA
E. Medina, Venezuela

Participants:

S. Archer, USA
Z. Baruch, Venezuela
J.A. Belsky, USA
B. Bilbao, Venezuela
R. Braithwaite, Australia
L. Bulla, Venezuela
M. Coughenour, USA
C. Dall'Aglio, Brazil
B. Dias, Brazil
G. W. Fernandez, Brazil
A.C. Franco, Brazil
I. Garay, Brazil
M. Haridasan, Brazil
J. Hay, Brazil
W. Hoffman, USA
C. Klink, Brazil
P. Lavelle, France
A. Moreira, Brazil
P. Oliveira, Brazil
J.F. Ribeiro, Brazil
G. Sarmiento, Venezuela
J. Silva, Venezuela
P. Stott, UK

Coastal Systems**Vancouver Island, Canada****21–25 September, 1992.***Organizers:*

J. Lubchenco, USA
J.C. Castilla, Chile

Participants:

G. Branch, South Africa
R. Bustamante, Ecuador
V. Gerard, USA
E. Jaramillo, Chile
B. Menge, USA
P. Sanchez, Chile
B. Santelices, Chile
W. Stolz, Chile

Arid Zones**Canberra, Australia****31 January – 4 February, 1994.***Organizer:*

I. Noble, Australia

Participants:

B. Fox, Australia
M. Fox, Australia
H. Gitay, Australia
L. Huenneke, USA
J. Landsberg, Australia
S. Lavorel, Australia
S. Morton, Australia
I. Noy-Meir, Israel
W.G. Whitford, USA

Estuaries, Lagoons, and Mangroves**Lafayette, Louisiana, USA****5–7 May, 1994.***Organizer:*

R. Twilley, USA

Participants:

R. Chen, USA
E. Medina, Venezuela
V. Rivera-Monroy, USA
S.C. Snedaker, USA
A. Yanez-Arancibia, Mexico

Islands**Nassau, Bahamas****7–11 October, 1993.***Organizers:*

P. Vitousek, USA
H. Adersen, Denmark
L. Loope, USA

Participants:

T. Bether, Bahamas
R.D. Bowden, USA
S. Buckner, Bahamas
E. Carey, Bahamas
J.H. Cushman, USA
C.M. D'Antonio, USA
T. Dudley, USA
U. Eliasson, Sweden
J.J. Ewel, USA
A.L. Flowers, Bahamas
D. Foote, USA
J.H. Fownes, USA
D. Given, New Zealand
R. Gnam, USA
P.J. Hearty, Bahamas
P. Hogberg, Sweden
D. Hooper, USA
M. Isaars, Bahamas
H.F. James, USA
K. Kaneshiro, USA
G. Larson, Bahamas
A.W. Macdonald, South Africa
P.A. Maillis, Bahamas
M. Maunder, UK
D. Mueller-Dombois, USA
N. Popou, Bahamas
J. Roughgarden, USA
J.T.S. Sahota, Switzerland
W. Strahm, Switzerland

S. Ward, Bahamas
 D. Wedin, Canada
 G.L. Woon, Bahamas

Tundra

Kongsvold, Norway
17–20 August, 1993.

Organizers:

F.S. Chapin, USA
 C. Korner, Switzerland

Participants:

B. Ammen, Switzerland
 L. Brubaker, USA
 J. Bryant, USA
 T. Callaghan, UK
 G. Grabherr, Austria
 A. Hershey, USA
 S. Hobbie, USA
 R. Jefferies, Canada
 S. Jonasson, Denmark
 G. Kling, USA
 J.B. McGraw, USA
 D. Murray, USA
 J. O'Brien, USA
 J. Pastor, USA
 J. Schimel, USA
 G. Shaver, USA
 M. Walker, USA
 O. Young, USA
 S. Zimov, Russia

Tropical Forests

Oaxtepec, Mexico
4–7 December, 1993.

Organizers:

G. Orians, USA
 R. Dirzo, Mexico

Participants:

P. Colinvaux, Panama
 J.H. Cushman, USA
 J. Denslow, USA
 J.J. Ewel, USA
 L. Gilbert, USA
 S. Gliessman, USA
 D.L. Hawksworth, UK
 M. Huston, USA
 V. Jaramillo, Mexico
 D.J. Lodge, USA
 A. Power, USA
 M. Rejmanek, USA
 W.L. Silver, USA
 S.J. Wright, Panama

Coral Reefs

Key West, Florida, USA
1–7 November, 1993.

Organizers:

J. Ogden, USA
 T. Done, Australia
 B. Salvat, France

Participants:

D. Bellwood, Australia
 J. Benzie, Australia
 C. Birkeland, Guam
 J. Cortes, Costa Rica
 C. D'Elia, USA
 R. Galzin, France
 P. Glynn, USA
 M. Harmelin-Vivien, France
 B. Hatcher, Canada
 J. Jackson, Panama
 C. Johnson, Australia
 E. Jordan, Mexico
 N. Knowlton, Panama
 J. McManus, Philippines
 J. Pandolfi, Australia
 S. Planes, France
 D. Potts, USA
 M. Reaka-Kudla, USA
 C. Roberts, US Virgin Islands
 B. Rosen, UK
 P. Sale, USA
 K. Sebens, USA
 B. Thomassin, France
 J. Veron, Australia
 W. Wiebe, USA
 H. Yap, Philippines

Lakes and Rivers

Madison, Wisconsin, USA
9–11 September, 1993.

Organizer:

S. Carpenter, USA

Participants:

T.M. Frost, USA
 L. Persson, USA
 M.E. Power, USA
 D. Soto, Chile

Boreal Forests

Duluth, Minnesota, USA
18–21 January, 1993.

Organizer:

J. Pastor, USA

Participants:

David J. Mladenoff, USA
 Yrjo Haila, Finland
 John P. Bryant, USA
 Serge Payette, Canada

Mediterranean Systems
Capetown, South Africa
9–11 September, 1992.

Organizer:

B. Huntley, South Africa

Participants:

A. Aronson, France
 M.T.K. Arroyo, Chile
 J. Blondel, France
 W.J. Bond, South Africa
 R.M. Cowling, South Africa
 G.W. Davis, South Africa
 E.R. Fuentes, Chile
 R. Ginocchio, Chile
 R.H. Groves, Australia
 R.J. Hobbs, Australia
 S.D. Hopper, Australia
 F.M. Jaksic, Chile
 J.E. Keeley, USA
 R.J. Lambeck, Australia
 B.B. Lamont, Australia
 S. Lavorel, Australia
 A.R. Main, Australia
 J.D. Majer, Australia
 G. Montenegro, Chile
 H.A. Mooney, USA
 D.M. Richardson, South Africa
 P.W. Rundel, USA
 M.C. Rutherford, South Africa
 D.A. Saunders, Australia
 W.D. Stock, South Africa
 C. Swift, USA

Regional sub-meetings on

Mediterranean systems were held in Los Angeles, California, USA, 22 February, 1992.

Organizer:

J. Keeley, USA

Participants, USA:

M. Cody, F. Davis, J. Powell, M. Price,
 J. Quinn, P. Rundel, C. Swift and
 P. Zedler

Also in Perth, Australia, December 1991.

Organizer:

R. Hobbs, Australia

Participants, Australia:

R. Groves, R. Lambeck, B. Lamont, S. Lavorel, T. Lefroy, B. Main, J. Majer, D. Saunders and E. Witkowski

**Temperate Grasslands
Stanford, California, USA
17–20 January, 1994.**

Organizer:

O. Sala, Argentina

Participants:

W.K. Lauenroth, USA
S.J. McNaughton, USA
G. Rusch, Sweden
X. Zhang, China

**Agroecosystems
Harpden, UK
17–21 January, 1994.**

Organizer:

M. Swift, Kenya

Participants:

J. Vandermeer, USA
P.S. Ramakrishnan, India
C.K. Ong, Kenya
J.M. Anderson, UK
B. Hawkins, UK

**Open Oceans
Boston, Massachusetts, USA
17–20 January, 1994.**

Organizer:

L. Kaufman, USA

Participants:

C.A. Butman, USA
J.T. Carlton, USA
M. Chandler, Canada

S. Mulsow, Chile
E. Okemwa, Kenya
C. Stuart, USA

**Keystone Species
Hilo, Hawaii, USA
8–11 December, 1994.**

Organizers:

H. Mooney, USA
J. Lubchenco, USA

Participants:

W.J. Bond, South Africa
J.C. Castilla, Chile
G. Daily, USA
J.A. Estes, USA
B.A. Menge, USA
L.S. Mills, USA
R.T. Paine, USA
M. Power, USA
D. Tilman, USA

**Synthesis Meeting
Asilomar, California, USA
27 February – 3 March, 1994.**

Organizers:

H. Mooney, USA
J.H. Cushman, USA

Participants:

J.M. Anderson, UK
A. Austin, USA
E.H. Bucher, Argentina,
I.C. Burke, USA
C.A. Butman, USA
J.T. Carlton, USA
S. Carpenter, USA
M. Chandler, USA
F.S. Chapin, III, USA

E. Cuevas, Venezuela
C. D'Antonio, USA
G.W. Davis, South Africa
S.S. Dhillon, France
R. Dirzo, Mexico
T. Done, Australia
C.B. Field, USA
D.L. Hawksworth, UK
M. Higashi, Japan
R.J. Hobbs, Australia
D.U. Hooper, USA
L.F. Huenneke, USA
B.J. Huntley, South Africa
A.C. Janetos, USA
V. Jaramillo, Mexico
P.R. Jutro, USA
J.E. Keeley, USA
C. Körner, Switzerland
J. Lubchenco, USA
A. Lugo, USA
E. Medina, Venezuela
S. Mulsow, Canada
S. Naeem, USA
I. Noble, Australia
J.C. Ogden, USA
G.H. Orians, USA
J. Pastor, USA
L.F. Pitelka, USA
P. S. Ramakrishnan, India
H. Rennenberg, Germany
P.G. Risser, USA
O.E. Sala, USA
E.-D. Schulze, Germany
O.T. Solbrig, USA
D. Soto, Chile
M.J. Swift, Kenya
A. Templeton, USA
D. Tilman, USA

Section 7 Workshop, London, 26–28 April 1994

Bruce M. Beehler, USA
Steve Blackmore, UK
Dirk Bryant, USA
Arie Budiman, Indonesia
John R. Busby, Australia
Joel J. Cracraft, USA
R.J. Ranjit Daniels, India
Sam Droege, USA
Brian Eversham, UK
John Fanshawe, UK
Mercedes Foster, USA

Ian Gauld, UK
Andy Gillison, Indonesia
Paul Harding, UK
Jeremy Harrison, UK
Vernon Heywood, UK
Craig Hilton-Taylor, South Africa
Jeremy Holloway, UK
John Lambshead, UK
Gren Lucas, UK
N. Manokaran, Malaysia
Nick Mawdsley, UK

Ebbe S. Nielsen, Australia
Jane Robertson-Vernhes, UNESCO
Kenneth Sherman, USA
K.D. Singh, FAO
Jorge Soberón Mainero, Mexico
Nigel E. Stork, UK
Beatriz Torres, UK
Paul Williams, UK
N. Winser, UK
Shidong Zhao, China

Section 9 Workshop

One workshop held in Washington late 1994.

Section 10 Workshop, Canberra, 5–6 December 1994

Rudi Appels, Australia	Mark Van Montague, Belgium	Inès Verleye, UNEP
Bryan Barlow, Australia	George Tzotzos, UNIDO	

Sections 11 and 13 Preparatory Meeting, Gland, 28–29 April 1994

Mary Helena Allegretti, Brazil	Bror Jonsson, Norway	Kenton Miller, USA
María Concepción J. Cruz, The World Bank	John Kurien, India	Steven Njuguna, Kenya
Madhav Gadgil, India	Christian Levêque, France	Christine Padoch, USA
Sandra Hails, Switzerland	Caroline Martinet, Switzerland	Hugh Raffles, USA
Nels Johnson, USA	Jeffrey A. McNeely, Switzerland	Kent Redford, USA

Sections 11 and 13 Preparatory Meeting II, Washington, 21–22 March 1994

Mary Helena Allegretti, Brazil	Vernon Heywood, UK	Jeffrey A. McNeely, Switzerland
Ivar A. Baste, UNEP	Nels Johnson, USA	Kenton Miller, USA
Madhav Gadgil, India	Bror Jonsson, Norway	Christine Padoch, USA

Sections 11 and 13 Preparatory Meeting III, Nairobi, 23–24 June 1994

Ivar A. Baste, UNEP	Ashish Kothari, India	Jeffrey A. McNeely, Switzerland
Nels Johnson, USA	Caroline Martinet, Switzerland	Kenton Miller, USA
Bror Jonsson, Norway	John L. Munro, Philippines	Martha Rojas, Switzerland

Sections 11 and 13 Workshop, Bangalore, 26–28 July 1994

Sujatha Aroro, India	Dhrub Jyoti Ghosh, India	Jeffrey A. McNeely, Switzerland
Mauricio Bellon, Mexico	M.G. Gogate, India	Kenton Miller, USA
Renee Borges, India	Vernon Heywood, UK	Sunita Narain, India
V.R. Chitrapu, India	Nels Johnson, USA	Maria Onestini, Argentina
Manab Chakraborty, UNEP	Bror Jonsson, Norway	Jyoti Parikh, India
Jordan Danchev, Bulgaria	Ashish Kothari, India	Kalpana Sharma, India
R.J. Ranjit Daniels, India	Christian Levêque, France	Usha Sharma, India
A.K. Dey, India	K.C. Malhotra, India	B.P. Singh, India
Madhav Gadgil, India	Caroline Martinet, Switzerland	Samar Singh, India
A.K. Ghosh, India	John L. Munro, Philippines	Lalitha Vijayan, India

Annex 4

Contributors to the Global Biodiversity Assessment

B. Aguirre-Hudson
International Mycological Institute
Surrey, UK
Sections 3 and 8

A.L. Allcock
University of Liverpool
Liverpool, UK
Section 2

Gary W. Allison
Oregon State University
Corvallis OR, USA
Section 6

Miguel A. Altieri
University of California
Albany CA, USA
Section 13

Elena Alvarez-Buylla
Centro de Ecología, UNAM
México DF, Mexico
Section 4

B. Ammen
University of Bern
Bern, Switzerland
Section 6

Jonathan M. Anderson
Rothamsted Experimental Station
Herts, UK
Section 6

Rudi Appels
CSIRO
Canberra, Australia
Section 10

Charles Arden-Clarke
WWF-International
Gland, Switzerland
Section 11

Amy Austin
Stanford University
Stanford CA, USA
Section 6

Charles Barber
World Resources Institute
Washington DC, USA
Section 13

Edward B. Barbier
University of York
York, UK
Section 12

Bruce M. Beehler
Conservation International
Washington DC, USA
Section 7

Mauricio Bellón
U. Nacional Autónoma de México
Mexico DF, México
Section 11

D. Bellwood
James Cook University
Townsville
Queensland, Australia
Section 6

John Benzie
Australian Institute of
Marine Sciences
Queensland, Australia
Section 6

Fikret Berkes
University of Manitoba
Manitoba, Canada
Section 13

Raymond J.H. Beverton
University of Wales
Cardiff, UK
Section 13

Charles Birkeland
University of Guam
Mangilao, Guam
Section 6

Asmund Bjordal
Section 13

Peter Bloch
University of Wisconsin
Madison WI, USA
Section 11

- Jacques Blondel
CEFE-CNRS
Montpellier, France
Section 6
- P. Dee Boersma
University of Washington
Seattle WA, USA
Section 6
- William J. Bond
University of Cape Town
Cape Town, South Africa
Section 5
- B. Boom
New York Botanical Garden
Bronx NY, USA
Section 8
- J.L. Bores
France
Section 6
- Meriem Bouamrane
UNESCO
Paris, France
Section 11
- Timothy Boyle
Center for International Forestry
Research
Jakarta, Indonesia
Section 13
- Susan Bragdon
Secretariat for the Convention on
Biological Diversity
Geneva, Switzerland
Section 13
- George Branch
University of Cape Town
Rondebosch, South Africa
Section 6
- Gardner Brown
University of Washington
Washington DC, USA
Section 12
- L. Brubaker
University of Washington
Seattle WA, USA
Section 6
- Dirk Bryant
World Resources Institute
Washington DC, USA
Section 7
- John P. Bryant
University of Alaska
Fairbanks AK, USA
Section 6
- Enrique H. Bucher
Centro de Zoología Aplicada
Cordoba, Argentina
Section 5
- James Bullock
Institute for Technical Ecology
Dorset, UK
Section 2
- Robert G.H. Bunce
Institute for Terrestrial Ecology
Cumbria, UK
Section 2
- Francoise Burhenne-Guilmin
IUCN – The World Conservation
Union
Bonn, Germany
Section 13
- Ingrid C. Burke
Colorado State University
Fort Collins CO, USA
Sections 5 and 6
- Thomas M. Burton
Michigan State University
Michigan, USA
Section 11
- Rodrigo Bustamante
Charles Darwin Research Station
Santa Cruz
Galapágos, Ecuador
Section 6
- Cheryl Ann Butman
Woods Hole Oceanographic
Institution
Woods Hole MA, USA
Section 6
- Julian Caldecott
Cambridge, UK
Section 13
- T. Callaghan
University of Manchester
Manchester, UK
Section 6
- Maxwell Cameron
Carleton University
Ottawa, Ontario, Canada
Section 11
- Dora Lange Canhos
Biodiversity Information Network
Brazil
Section 9
- James T. Carlton
Williams College
Mystic CT, USA
Section 6
- Stephen R. Carpenter
University of Wisconsin
Madison WI, USA
Sections 5 and 6
- A. Machado Carrillo
Centro de Ecología de ICONA
Islas Canarias, Spain
Section 3
- Juan Carlos Castilla
Universidad de Pontificia
Santiago, Chile
Sections 5 and 6
- Richard A. Caufield
Section 13
- Roberto B. Cavalcanti
Universidade de Brasilia
Brasilia DF, Brazil
Section 9
- H. Ceballos-Lascurain
IUCN – The World Conservation
Union
México DF, Mexico
Section 13

- Mark Chandler
New England Aquarium
Boston MA, USA
Section 6
- Chen Changdu
University of Peking
Beijing, China
Section 5
- F. Stuart Chapin III
University of California
Berkeley CA, USA
Sections 5 and 6
- Mikhail Ilych Chatoumovski
Institute of Ecology and Evolution
Moscow, Russia
Section 7
- Michel Chauvet
Bureau des Ressources Génétiques
Paris, France
Section 2
- Y. Chernov
Institute of Animal Evolutionary
Morphology and Ecology
Moscow, Russia
Section 6
- Jason Clay
Rights and Resources
Arlington VA, USA
Section 11
- Jean Clobert
Université Pierre et Marie Curie
Paris, France
Section 4
- Jonathan Coddington
National Museum of Natural History
Washington DC, USA
Section 2
- George Coggins
University of Kansas Law School
Lawrence KS, USA
Section 11
- Paul A. Colinvaux
Smithsonian Tropical Research
Institute
Balboa, Panama
Section 6
- Bruce B. Collette
National Museum of Natural History
Washington DC, USA
Sections 4 and 7
- Rita R. Colwell
University of Maryland
College Park MD, USA
Section 6
- Peter Condon
Economic Research Service, USDA
Washington DC, USA
Section 11
- Miel Corbett
IUCN – The World Conservation
Union
Gland, Switzerland
Section 11
- J. Cortes
University of Costa Rica
San Pedro, Costa Rica
Section 6
- K. Cottingham
University of Wisconsin
Madison WI, USA
Section 6
- R. Cowling
University of Cape Town
Rondebosch, South Africa
Section 3
- Joel J. Cracraft
American Museum of Natural
History
New York NY, USA
Section 7
- Ian Craine
WCMC
Cambridge, UK
Section 9
- Keith A. Crandall
University of Texas
Austin TX, USA
Section 2
- T. Crowe
University of Cape Town
Rondebosch, South Africa
Section 3
- Elvira Cuevas
IVIC, Centro de Ecología
Caracas, Venezuela
Section 6
- T. Cullen
Natural Resources Institute
Kent, UK
Section 8
- J.H. Cushman
Sonoma State University
CA, USA
Sections 5 and 6
- Chris F. D'Elia
University of Maryland
MD, USA
Section 6
- M.N. Dadd
BIOSIS
York, UK
Sections 3 and 8
- G. Daily
Stanford University
Stanford CA, USA
Section 5
- Philip J. Dale
John Innes Centre
Norwich, UK
Section 10
- Francisco Dallmeier
International Center
Washington DC, USA
Section 9
- Silvana Dalmazzone
University of York
York, UK
Section 12

- R.J. Ranjit Daniels
M.S. Swaminathan Research
Foundation
Madras, India
Section 7
- Bishop Dansby
GIS Law and Policy Institute
Harrisonburg VA, USA
Section 9
- George Davis
National Botanical Institute
Claremont, South Africa
Section 6
- Paul K. Dayton
Scripps Institute of Oceanography
La Jolla CA, USA
Section 6
- Cyrille de Klemme
International Environment for Law
Paris, France
Section 13
- Alfred L. Decicco
Section 13
- Omar Defeo
Rambla O'Higgins
Montevideo, Uruguay
Section 6
- Julie S. Denslow
Tulane University
New Orleans LA, USA
Section 6
- Megan Dethier
Friday Harbor Laboratory
San Juan Island WA, USA
Section 6
- Shivcharn S. Dhillon
CNRS, CEFE
Montpellier, France
Section 6
- Terry Done
Australian Institute of Marine
Science
Queensland, Australia
Section 6
- Sam Droege
National Biological Survey
Washington DC, USA
Section 7
- Simon J. Duffield
University of Southampton
Southampton, UK
Section 2
- K. Dunkin
University of California
Berkeley CA, USA
Section 6
- Mark Eakin
NOAA Office of Global Programs
Silver Spring MD, USA
- James L. Edwards
National Science Foundation
Arlington VA, USA
Section 7
- Peter J. Edwards
Geobotanisches Institut ETH
Zürich, Switzerland
Section 2
- Steven Edwards
IUCN – The World Conservation
Union
Washington DC, USA
Section 13
- Harriet A.C. Eeley
The Natural History Museum
London, UK
Section 7
- Paul R. Ehrlich
Stanford University
Stanford CA, USA
Section 5
- J. Engels
IPGRI
Rome, Italy
Section 8
- Jim Estes
University of Oklahoma
Norman OK, USA
Sections 5 and 6
- D. Evans
USDA Forest Service
Starkville MS, USA
Section 7
- John J. Ewel
Institute of Pacific Islands Forestry
Honolulu HI, USA
Section 6
- David Farrier
University of Wollongong
Wollongong NSW, Australia
Section 13
- Philip Martin Fearnside
National Institute for Research in
the Amazon-INPA
Manaus-Amazonas, Brazil
Section 5
- Christopher B. Field
Carnegie Institution of Washington
Stanford CA, USA
Section 6
- Nathan R. Flesness
International Species Information
System
Apple Valley MN, USA
Section 8
- Carl Folke
Royal Swedish Academy of Sciences
Stockholm, Sweden
Sections 6 and 12
- Eduardo Forno
Centro de Dalos Para la
conservación
Bolivia
Section 9
- Louise Fortmann
University of California
Berkeley CA, USA
Section 11
- Mercedes Foster
National Museum of Natural History
Washington DC, USA
Section 7

Barry Fox
University of New South Wales
Kensington NSW, Australia
Section 6

Marilyn Fox
Royal Botanical Gardens
Sydney NSW, Australia
Section 6

Mark Freudenberger
University of Wisconsin
Madison WI, USA
Section 11

George Frisvold
Economic Research Service, USDA
Washington DC, USA
Section 11

T.M. Frost
Center for Limnology
WI, USA
Section 6

Rodney M. Fujita
Environmental Defense Fund
Oakland CA, USA
Section 6

R. Galzin
Université de Perpignan
Perpignan, France
Section 6

Raul Garcia Barrios
Centro de Investigación
México DF, Mexico
Section 4

Keith Gardner
University of Reading
Reading, UK
Section 1

Val Gerard
Marine Sciences Research Centre
SUNY
Stony Brook NY, USA
Section 6

A.K. Ghosh
Zoological Survey of India
Calcutta, India
Section 13

Arin H. Ghosh
Project Tiger
New Delhi, India
Section 13

Dhrub Jyoti Ghosh
WWF – India
Calcutta, India
Section 11

Lawrence E. Gilbert
University of Texas
Austin TX, USA
Section 6

Andy Gillison
Centre for International Forestry
Research
Jakarta, Indonesia
Sections 7 and 13

Habiba Gitay
Australian National University
Canberra, Australia
Section 6

David R. Given
David Given & Associates
Christchurch, New Zealand
Sections 2 and 3

Stephen R. Gliessman
University of California
Santa Cruz CA, USA
Section 6

Peter Glynn
RSMAS, University of Miami
Miami FL, USA
Section 6

Edgardo Gómez
University of the Philippines
Quezón City, Philippines
Section 13

D. Gordon
World Conservation Monitoring
Centre
Cambridge, UK
Section 8

Pierre-Henri Gouyon
Université de Paris-Sud XI
Orsay, France
Section 4

G. Grabherr
University of Vienna
Vienna, Austria
Section 6

W. Stewart Grant
National Marine Fisheries Service
Seattle WA, USA
Sections 3 and 7

John Frederick Grassle
Rutgers University
New Brunswick NJ, USA
Section 6

B. Groombridge
World Conservation Monitoring
Centre
Cambridge, UK
Section 3

Yrjo Haila
University of Turku
Pori, Finland
Section 6

Sandra Hails
Signy, Switzerland
Section 11

Stephen J.G. Hall
Animal Welfare and Human–Animal
Interactions Group
Cambridge, UK
Sections 2 and 8

P.M. Hammond
Natural History Museum
London, UK
Section 3

Nick Hanley
University of Stirling
Stirling, UK
Section 12

Lars P. Hansen
Norwegian Institute for Nature
Research
Trondheim, Norway
Section 13

Ilkka Hanski
University of Helsinki
Helsinki, Finland
Section 4

Jean Hanson
International Livestock Centre for
Africa
Addis Ababa, Ethiopia
Section 8

M. Harmelin-Vivien
Station Marine d'Endoume
Marseilles, France
Section 6

Jeremy Harrison
World Conservation Monitoring
Centre
Cambridge, UK
Sections 7 and 9

S. Harrison
University of California
Davies CA, USA
Section 5

B. Hatcher
Dalhousie University
Halifax, Nova Scotia, Canada
Section 6

B. Hawkins
Imperial College at Silwood Park
Ascot, Berks, UK
Section 6

Lee-Ann Hayek
Smithsonian Institution
Washington DC, USA
Section 7

Robert G. Healy
Duke University
Durham NC, USA
Section 11

Susanna Hecht
University of California
Los Angeles CA, USA
Section 11

Rob Hengeveld
IBN-DLO
Wageningen, Netherlands
Section 2

R.P. Herman
New Mexico State University
Las Cruces NM, USA
Section 6

Mario Hernández
UNEP
Nairobi, Kenya
Section 9

A. Hershey
University of Minnesota
Duluth MN, USA
Section 6

Masahiko Higashi
Kyoto University
Kyoto, Japan
Sections 4 and 6

Craig Hilton-Taylor
National Botanical Institute
Claremont, South Africa
Section 7

Kjetil Hindar
Norwegian Institute for Nature
Research
Trondheim, Norway
Sections 1, 4 and 13

G. Hinkle
Marine Biological Laboratory
MA, USA
Section 8

Bob Hitchcock
University of Nebraska
Lincoln NE, USA
Section 11

S. Hobbie
University of California
Berkeley CA, USA
Section 6

Richard J. Hobbs
CSIRO
Western Australia
Sections 6 and 13

John Hodges
Mittersill, Australia
Section 3

C.S. Holling
University of Florida
Florida, USA
Section 12

P.K. Holmgren
New York Botanic Garden
Bronx NY, USA
Section 8

David U. Hooper
Stanford University
Stanford CA, USA
Section 6

Laura F. Huenneke
New Mexico State University
Las Cruces NM, USA
Section 6

Brian R. Huntley
National Botanical Institute
Claremont, South Africa
Section 6

Michael A. Huston
Oak Ridge National Laboratory
Oak Ridge TN, USA
Section 6

Jose M. Iriondo
Escuela Técnica Superior de
Ingenieros Agrónomos
Madrid, Spain
Section 2

- Jeremy B.C. Jackson
Smithsonian Tropical Research
Institute
Balboa, Panama
Section 6
- Robert B. Jackson
University of Texas
Austin TX, USA
Section 6
- Philippe Janvier
Museum National d'Histoire
Naturelle
Paris, France
Section 4
- Daniel H. Janzen
Instituto Nacional de Biodiversidad
Santo Domingo de Heredia
Costa Rica
Sections 7 and 13
- E. Jaramillo
Universidad Austral de Chile
Valdivia, Chile
Section 6
- Victor J. Jaramillo
Centro de Ecología UNAM
México DF, Mexico
Section 6
- Mondher Jaziri
Free University of Brussels
Brussels, Belgium
Section 10
- R. Jefferies
University of Toronto
Toronto, Ontario, Canada
Section 6
- M. Jenkins
World Conservation Monitoring
Centre
Cambridge, UK
Section 3
- C. Johnson
University of Queensland
St Lucia QLD, Australia
Section 6
- S. Jonasson
University of Copenhagen
Copenhagen, Denmark
Section 6
- E. Jordan
Cancun QR, Mexico
Section 6
- Peter R. Jutro
US Environmental Protection Agency
Washington DC, USA
Section 6
- Kadzo Kangwana
African Wildlife Foundation
Nairobi, Kenya
Section 13
- L.S. Kaufman
New England Aquarium
Boston MA, USA
Section 6
- Hiroya Kawanabe
Centre for Ecological Research
Otsu, Japan
Section 4
- Jon Keeley
Occidental College
Los Angeles CA, USA
Section 6
- G. Kling
University of Michigan
Ann Arbor MI, USA
Section 6
- Nancy Knowlton
Smithsonian Tropical Research
Institute
Balboa, Panama
Section 6
- Christian Korner
University of Basel
Basel, Switzerland
Section 6
- Ashish Kothari
Indian Institute of Public
Administration
New Delhi, India
Section 13
- T. Kratz
University of Wisconsin
Junction WI, USA
Section 6
- Oleg Kussakin
Russian Academy of Sciences
Vladivostok, Russia
Section 6
- Jill Landsberg
CSIRO-DWE
Lyneham ACT, Australia
Section 6
- Rolf Langvatn
Norwegian Institute for Nature
Research
Trondheim, Norway
Section 13
- Chuck Lankester
UNDP
New York NY, USA
Section 9
- Steven Lanou
World Resources Institute
Washington DC, USA
Section 13
- J. Larson
Section 7
- Pierre Lasserre
UNESCO
Paris, France
Section 8
- R. Latham
University of Pennsylvania
Philadelphia PA, USA
Section 3
- William K. Lauenroth
Colorado State University
Fort Collins CO, USA
Sections 5 and 6

Sandra Lavorel
Australian National University
Canberra, Australia
Section 6

William H. Lesser
Cornell University
Ithaca NY, USA
Sections 10 and 12

William J. Leverich
Washington University
St Louis MO, USA
Section 4

Simon A. Levin
Princeton University
Princeton NJ, USA
Section 6

T.M. Lewinsohn
Museu de Historia Natural
Campinas SP, Brazil
Sections 2 and 3

D. Linden
USDA Forest Service
Fort Collins CO, USA
Section 7

Diana Lipscomb
George Washington University
Washington DC, USA
Section 2

Eduardo Lleras
Ministry of Agriculture and Agrarian
Reform
Brasilia, Brazil
Section 13

D. Jean Lodge
USDA Forest Service, FPL
Palmer, Puerto Rico, USA
Sections 3 and 6

Michel Loreau
Université Pierre et Marie Curie
Paris, France
Section 4

Wouter Los
ETI
Netherlands
Section 9

Ariel E. Lugo
International Institute of Tropical
Forestry
Puerto Rico, USA
Section 6

H. Gyde Lund
USDA Forest Service
Washington DC, USA
Section 7

S.M. Lynch
Port Erin Marine Laboratory
Isle of Man, UK
Section 2

Roy W. McDiarmid
National Museum of Natural History
Washington DC, USA
Section 7

Georgina M. Mace
Society of London
London, UK
Section 2

A. Machado
Centro de Ecología de Icona
Islas Canarias, Spain
Section 3

J. McManus
ICLARM
Makati, Philippines
Section 6

S.J. McNaughton
Syracuse University
Syracuse NY, USA
Section 6

Anne Magurran
University of St. Andrews
Fife, UK
Section 2

Peter Maitland
Section 13

Luis Malaret
New England Science Centre
Worcester MA, USA
Section 11

Karl-Goran Maler
Royal Swedish Academy of Sciences
Stockholm, Sweden
Section 12

N. Manokaran
Forest Reserach Institute Malaysia
Kuala Lumpur, Malaysia
Section 7

Artura Da Silva Mariante
Ministry of Agriculture and Agrarian
Reform
Brasilia, Brazil
Section 13

Caroline Martinet
IUCN – The World Conservation
Union
Gland, Switzerland
Section 11

Pamela Mason
University of Stirling
Stirling, UK
Section 12

Nick Mawdsley
University of Leeds
Leeds, UK
Section 7

Ernesto Medina
Instituto Venezolano de
Investigaciones Científicas
Caracas, Venezuela
Section 6

Jai Mehta
New Haven CT, USA
Section 11

Bruce A. Menge
Oregon State University
Corvallis OR, USA
Sections 5 and 6

M.H. Mengesha
ICRISAT
Patancheru, India
Section 3

Yannis Michalakis
Université Pierre et Marie Curie
Paris, France
Section 4

L.S. Mills
University of Idaho
Moscow ID, USA
Section 5

David J. Mladenoff
University of Wisconsin
Madison WI, USA
Section 6

Jose M. Moreno
Universidad Complutense
Madrid, Spain
Section 6

Nancy R. Morin
Missouri Botanical Garden
St Louis MO, USA
Section 2

Steve Morton
CSIRO
Canberra, Australia
Section 6

Sandor Mulsow
Bedford Institute of Oceanography
Nova Scotia, Canada
Section 6

Paul Munyenembe
University of Malawi
Zomba, Malawi
Section 2

D. Murray
University of Alaska
Fairbanks AK, USA
Section 6

Shahid Naeem
University of Minnesota
St Paul MN, USA
Section 6

K. Natarajan
University of Madras
Madras, India
Section 2

Sergio A. Navarrete
Oregon State University
Corvallis OR, USA
Section 6

Gayl Ness
IUCN – The World Conservation
Union
Gland, Switzerland
Section 11

Ian R. Noble
Australian National University
Canberra, Australia
Section 6

Elliot Norse
Centre for Marine Conservation
Redmond WA, USA
Section 2

Trevor Norton
Port Erin Marine Laboratory
Isle of Man, UK
Section 6

Immanuel Noy-Meir
Hebrew University
Jerusalem, Israel
Section 6

J. O'Brien
University of Kansas
Lawrence KS, USA
Section 6

John C. Ogden
Florida Institute of Oceanography
St Petersburg FL, USA
Section 6

Ezekiel Okemwa
Kenya Marine and Fisheries
Research Institute,
Mombasa, Kenya
Section 6

Gary J. Olsen
University of Illinois
Urbana IL, USA
Section 2

Guinilla Almered Olsson
University of Trondheim
Dragvoll, Norway
Sections 4 and 11

Chin K. Ong
International Council for Research
in Agroforestry
Nairobi, Kenya
Section 6

Gordon H. Orians
University of Washington
Seattle WA, USA
Section 6

P. Ozenda
Université Joseph Fourier
Grenoble, France
Section 6

J. Paine
Section 13

R.T. Paine
University of Washington
Seattle WA, USA
Sections 5 and 6

Theodore Panayotou
Harvard Institute for International
Development
MA, USA
Section 12

J. Pandolfi
Australian Institute for Marine
Science
Townsville QLD, Australia
Section 6

John Pastor
University of Minnesota
Duluth MN, USA
Section 6

- G. Pattison
National Council for the
Conservation of Plants and Gardens
Surrey, UK
Section 8
- Serge Payette
Université Laval
Québec, Canada
Section 6
- L. Persson
University of Umea
Umea, Sweden
Section 6
- C.H. Peterson
Section 6
- O. Phillips
Missouri Botanical Garden
St Louis MO, USA
Section 7
- Steward T.A. Pickett
Institute of Ecosystem Studies
Millbrook NY, USA
Section 5
- Stuart L. Pimm
University of Tennessee
TN, USA
Section 2
- Louis F. Pitelka
Electric Power Research Institute
Palo Alto CA, USA
Section 6
- S. Planes
Université de Perpignan
Perpignan, France
Section 6
- Norman I. Platnick
American Museum of Natural
History – Entomology
New York NY, USA
Section 3
- D. Potts
University of California
Santa Cruz CA, USA
Section 6
- Don Powell
Institute of Animal Physiology and
Genetics Research
Cambridge, UK
Section 10
- Alison G. Power
Cornell University
Ithaca NY, USA
Section 6
- Geoffrey Power
Section 13
- Mary E. Power
University of California
Berkeley CA, USA
Sections 5 and 6
- G.T. Prance
Royal Botanic Gardens Kew,
Richmond, Surrey, UK
Section 3
- Richard B. Primack
Boston University
Boston MA, USA
Section 13
- Francis E. Putz
Section 13
- Donald Quicke
Imperial College at Silwood Park
Ascot, Berks, UK
Section 2
- Jean C. Rakotoary
Office Nationale de l'Environnement
Madagascar
Section 9
- P.S. Ramakrishnan
Jawaharlal Nehru University
New Delhi, India
Section 6
- Rai Singh Rana
National Bureau of Plant Genetic
Resources
New Delhi, India
Section 4
- Marjorie L. Reaka-Kudla
University of Maryland
MD, USA
Section 6
- Marcel Rejmanek
University of California
Davis CA, USA
Section 6
- Francois Renaud
Université de Montpellier 2
Montpellier, France
Section 4
- Heinz Rennenberg
Albert-Ludwigs Universität
Freiburg, Germany
Section 6
- S. Renner
Institute of Systematic Botany
Mainz, Germany
Section 3
- Heather L. Reynolds
University of California
Berkeley CA, USA
Section 5
- Robert E. Ricklefs
University of Pennsylvania
Philadelphia PA, USA
Sections 2 and 3
- Paul G. Risser
Miami University
Oxford OH, USA
Section 6
- C. Roberts
University of the Virgin Islands
St Thomas, Virgin Islands, USA
Section 6
- E. Rodenburg
World Resources Institute
Washington CD, USA
Section 7
- B. Rosen
The Natural History Museum
London, UK
Section 6

- Yuri R. Roskov
V.L. Komarov Botanical Institute
St Petersburg, Russia
Section 2
- G. Rusch
Uppsala University
Uppsala, Sweden
Section 6
- Nils Ryman
University of Stockholm
Stockholm, Sweden
Section 13
- Carl Safina
National Audubon Society
New York NY, USA
Section 6
- Peter Sale
University of Windsor
Ontario, Canada
Section 6
- B. Salvat
Université de Perpignan
Perpignan, France
Section 6
- Patricio Sánchez
Pontificia Universidad Católica de Chile
Santiago, Chile
Section 6
- Bernabe Santelices
Pontificia Universidad Católica de Chile
Santiago, Chile
Section 6
- Abou Sarr
Université Paris II
Orsay, France
Section 4
- Barbara A. Schaal
Washington University
MO, USA
Section 4
- J. Schimel
University of Alaska
Fairbanks AK, USA
Section 6
- William H. Schlesinger
Duke University
Durham NC, USA
Section 6
- Ernst-Detlef Schulze
Universität Bayreuth
Bayreuth, Germany
Section 6
- Kenneth Sebens
University of Maryland
MD, USA
Section 6
- Wolfgang Seiler
Germany
Section 6
- J. John Sepkoski, Jr.
University of Chicago
Chicago IL, USA
Section 4
- G. Shaver
Marine Biological Laboratory
Woods Hole MA, USA
Section 6
- Kenneth Sherman
NOAA, National Marine Fisheries
Service
Narragansett RI, USA
Section 7
- Barry Sherr
Oregon State University
Corvallis OR, USA
Section 6
- Clare Shine
International Law
Paris, France
Section 13
- Whendee L. Silver
Yale School of Forestry
New Haven CT, USA
Section 6
- Chris Simoens
Laboratorium voor Genetica
Gent, Belgium
Section 10
- J. Simonetti
Universidad de Chile
Santiago, Chile
Section 3
- K.D. Singh
FAO,
Rome, Italy
Section 7
- Samar Singh
WWF-India
New Delhi, India
Section 13
- Montgomery Slatkin
University of California
Berkeley CA, USA
Section 4
- Joseph Smartt
University of Southampton
Southampton, UK
Section 2
- D. Smith
International Mycological Institute
Surrey, UK
Section 8
- Neal G. Smith
Smithsonian Tropical Research
Institute
Balboa, Panama
Section 6
- S.C. Snedaker
University of Miami
Miami FL, USA
Section 6
- Jorge Soberón Mainero
Comision Nacional para el
Conocimiento y Uso de la
Biodiversidad
México DF, Mexico
Section 7

M.L. Sogin
Center for Molecular Evolution
MA, USA
Section 8

Otto T. Solbrig
Harvard University
Cambridge MA, USA
Section 6

Antonio M. Sole-Cava
Universidade Federal do Rio de Janeiro
Rio de Janeiro, Brazil
Section 2

Doris Soto
Universidad Austral de Chile
Puerto Montt, Chile
Section 6

C. Stace
University of Leicester
Leicester, UK
Section 3

Erko Stackebrandt
Deutsche Sammlung von
Mikroorganismen und Zellkulturen
GmbH
Braunschweig, Germany
Section 2

Bruce A. Stein
The Nature Conservancy
Arlington VA, USA
Section 9

Wolfgang Stolz
Universidad Católica del Norte
Coquimbo, Chile
Section 6

Bella Raphael Striganova
Institute of Animal Evolutionary
Morphology and Ecology
Moscow, Russia
Section 7

Carol Stuart
USA
Section 6

Simon Stuart
IUCN – The World Conservation
Union
Gland, Switzerland
Section 13

Hideaki Sugawara
World Data Center on
Microorganisms
Saitama, Japan
Section 8

D.B. Sumitharatchi
Royal Botanical Gardens
Peradeniya, Sri Lanka
Section 8

Michael J. Swift
Tropical Soil Biology and Fertility
Program
Nairobi, Kenya
Section 6

Laura Tangle
Conservation International
Washington DC, USA
Section 9

Alan R. Templeton
Washington University
St Louis MO, USA
Sections 2 and 5

B. Thomassin
Station Marine d'Endoume
Marseilles, France
Section 6

John P. Thorpe
Port Erin Marine Laboratory
Isle of Man, UK
Section 2

James M. Tiedje
Michigan State University
MI, USA
Section 10

David Tilman
University of Minnesota
St Paul MN, USA
Sections 5 and 6

Cynthia Trowbridge
Oregon State University
Corvallis OR, USA
Section 6

Kerry Turner
University of East Anglia
Norwich, UK
Section 12

Monica G. Turner
University of Wisconsin
Madison WI, USA
Section 5

Robert R. Twilley
University of Southern Louisiana
Lafayette LA, USA
Section 6

Paul F. Uhler
National Research Council
Washington DC, USA
Section 9

P.J. Van der Meer
Ministry of Housing, Physical
Planning and Environment
The Hague, Netherlands
Section 6

Ann Van Gysel
Laboratorium voor Genetica
Gent, Belgium
Section 10

Marc Van Montagu
Laboratorium voor Genetica
Gent, Belgium
Section 10

Marc H.V. Van Regenmortel
Institut de Biologie Moléculaire et
Cellulaire du CNRS
Strasbourg, France
Section 2

J. Veron
Australian Institute for Marine
Science
Townsville QLD, Australia
Section 6

Gabor Vida
Eotvos University
Budapest, Hungary
Section 4

Jean-Denis Vigne
Museum National d'Histoire
Naturelle
Paris, France
Section 4

Peter Vitousek
Stanford University
Stanford CA, USA
Section 6

M. Walker
University of Colorado
Boulder CO, USA
Section 6

Richard H. Waring
Oregon State University
Corvallis OR, USA
Section 6

P.C. Watts
Port Erin Marine Laboratory
Isle of Man, UK
Section 2

Michael Wells
Lier, Norway
Sections 12 and 13

W.G. Whitford
New Mexico State University
Las Cruces NM, USA
Section 6

Tony Whitten
The World Bank Group
Washington DC, USA
Section 13

William J. Wiebe
University of Georgia
Athens GA, USA
Section 6

H. Garrison Wilkes
University of Massachusetts
Boston MA, USA
Section 13

A. Michelle Wood
University of Oregon
Eugene OR, USA
Section 6

D. Wright
Seattle WA, USA
Section 3

S. Joseph Wright
Smithsonian Tropical Research
Institute
Balboa, Panama
Sections 4 and 6

P.S. Wyse-Jackson
Botanical Gardens Conservation
International
Surrey, UK
Section 8

Alejandro Yaez-Arancibia
Universitas de Autonoma Campeche
Campeche, Mexico
Section 6

Helen Yap
University of the Philippines
Manila, Philippines
Section 6

Andrew G. Young
CSIRO
Canberra, Australia
Section 10

O. Young
Dartmouth College
Hanover NH, USA
Section 6

Xinshi Zhang
Institute of Botany
Beijing, China
Section 6

S. Zimov
Russian Academy of Sciences
Yakutia, Russia
Section 6

Annex 5

List of peer reviewers of the Global Biodiversity Assessment

Section 2 Characterization of biodiversity

Itziar Aguinagalde ETSIA, Ciudad Universitaria Madrid, Spain	M.F. Claridge University of Wales, Cardiff, UK	Jean Hanson International Livestock Centre for Africa Addis Ababa, Ethiopia
Dawood Al-Eisawi University of Jordan Amman, Jordan	Bruce B. Collette National Marine Fisheries Service Washington, DC, USA	K. Elaine Hoagland Association of Systematics Collections Washington DC, USA
Trygve Berg Agricultural University of Norway Norway	F. Cotterill Biodiversity Foundation for Africa Bulawayo, Zimbabwe	Nobuo Ishii Japan Wildlife Research Center Tokyo, Japan
H.J.B. Birks University of Bergen Bergen, Norway	R.J. Ranjit Daniels M.S. Swaminathan Research Foundation, Madras, India	D. Janzen c/o Instituto Nacional de Biodiversidad Santo Domingo de Heredia, Costa Rica
Nicolae Botnariuc Faculty of Biology Bucharest, Romania	Joseph P. Dudley Hwange National Park Dete, Zimbabwe	Susan Kephart Willamette University Oregon, USA
Donald G. Broadley National Museums and Monuments Bulawayo, Zimbabwe	Mohamed Abd El Fattah El Kassas University of Cairo Giza, Egypt	Sigizmund S. Kharkevich Institute of Biology & Soils Vladivostok, Russia
Venus J. Calilung University of the Philippines Laguna, Philippines	Mohamed Fennane University Mohammed V Rabat, Morocco	A. Kryukov Institute of Biology & Soils Vladivostok, Rusia
Hilconida Calumpong Silliman University Dumaguete City, Philippines	Clive Hambler University of Oxford Oxford, UK	Pierre Lasserre UNESCO Paris, France
Roberto B. Cavalcanti Universidade de Brasilia Brasilia DF, Brazil		

Susan H. Lawler
La Trobe University
Victoria, USA

In Kyu Lee
Seoul National University
Seoul, Korea

Leonid Malyshev
Siberian Central Botanical Garden
Novosibirsk, Russia

Valin Marshall
Canadian Forest Service
Victoria, BC, Canada

Brian A. Maurer
Brigham Young University
Provo, UT, USA

Robert M. May
University of Oxford
Oxford, UK

Jane Metcalfe
Natural Environment Research
Council
Swindon, UK

Masuo Miyata
National Forest Tree Breeding
Center
Ibaraki, Japan

Mohamed Mouna
Mohammed V University
Rabat, Morocco

A.A. Oteng-Yeboah
University of Ghana
Legon, Ghana

R.S. Paroda
Ministry of Agriculture
New Delhi, India

Richard Powell
University College Galway
Galway, Ireland

Odd Terje Sandlund
Norwegian Institute for Nature
Research
Trondheim, Norway

Angel Spotorno
Universidad de Chile
Santiago, Chile

Jean-Marc Thiollay
Laboratoire d'Ecologie
Paris, France

Section 3 Magnitude and distribution of biodiversity

Kaare Aagaard
NINA
Trondheim, Norway

Scott Barrett
London Business School
London, UK

Bopaiah A. Biddanda
University of Texas at Austin
Texas, USA

Philippe Bouchet
Laboratoire de Biologie des
Invertébrés
Paris, France

Donald G. Broadley
National Museums and Monuments
Bulawayo, Zimbabwe

Neil Burgess
University of Copenhagen
Copenhagen, Denmark

Kenneth Campbell
University of Zimbabwe
Harare, Zimbabwe

Jean Chazeau
Laboratoire de Zoologie Appliquée
Noumea Cédex, New Caledonia

Marion E. Cheatle
United Nations Environment
Programme
Nairobi, Kenya

F. Cotterill
Biodiversity Foundation for Africa
Bulawayo, Zimbabwe

Jorge V. Crisci
Museo de La Plata
Buenos Aires, Argentina

David Currie
University of Ottawa
Ottawa, Canada

R.J. Ranjit Daniels
M.S. Swaminathan Research
Foundation
Madras, India

Henri Dumont
University of Gent
Gent, Belgium

Torbjorn Ebhenhard
Swedish Museum of Natural History
and Swedish National Scientific
Committee on Biological Diversity
Stockholm, Sweden

Aly A. El Moursy
University of Cairo
Cairo, Egypt

Tom Fenchel
University of Copenhagen
Helsingor, Denmark

Jon Fjeldsa
University of Copenhagen
Copenhagen, Denmark

Rodrigo Gámez
Instituto Nacional de Biodiversidad
Santo Domingo de Heredia
Costa Rica

Kevin J. Gaston
Imperial College
Berkshire, UK

David R. Given
David Given & Associates
Christchurch, New Zealand

- | | | |
|--|---|---|
| Zbigniew Glowaciński
Institute of Nature Conservation
Krakow, Poland | Pierre Lasserre
UNESCO,
Paris, France | Michael A. Rex
University of Massachusetts
Boston, MA, USA |
| Gaston Guzman
Instituto de Ecología
Veracruz, Mexico | Michael A. Mares
University of Oklahoma
Oaklahoma, USA | Barry Richardson
University of Western Sydney
NSW, Australia |
| S.J.G. Hall
University of Capetown
Rondebosch, South Africa | Robert M. May
University of Oxford
Oxford, UK | W.A. Rogers
FAO
Dar es Salaam, Tanzania |
| Stephen Halloy
Fundación Amigos de la Naturaleza
Santa Cruz, Bolivia | Jeffrey A. McNeely
IUCN – The World Conservation
Union
Gland, Switzerland | Bernabe Santelices
Pontificia Universidad Católica de
Chile,
Santiago, Chile |
| Ole Hamann
University of Copenhagen
Copenhagen, Denmark | Gray Merriam
Carleton University, Ontario, Canada | Owen J. Sexton
Washington University
St Louis, MO, USA |
| Clive Hambler
University of Oxford
Oxford, UK | Scott E. Miller
Natural Science
Honolulu, Hawaii, USA | Joon Hwan Shin
Forestry Research Institute
Seoul, Korea |
| J.G. Hawkes
University of Birmingham
Birmingham, UK | Alexander Mosseler
Petawawa National Forestry Institute
Ontario, Canada | S.S. Sidhu
Canadian Forest Service
Alberta, Canada |
| Miguel Holle
International Potato Center
Lima, Peru | A. Peeraly
University of Mauritius
Reduit, Mauritius | Monica Swartz
University of Texas at Austin
Austin, USA |
| Malcolm L. Hunter, Jr.
University of Maine
Orono Maine, USA | Derek Pomeroy
Makerere University Institute of
Environment and Natural Resources
Kampala, Uganda | Jean-Marc Thiollay
Laboratoire d'Ecologie
Paris, France |
| Susan Kephart
Willamette University
Oregon, USA | G. Carleton Ray
University of Virginia
Virginia, USA | Rauno Vdidsnen
Forest and Park Service
Helsinki, Finland |
| M.A. Azia Khan
Dhaka, Bangladesh | Scott Redhead
Centre for Land and Biological
Resources Research
Ottawa, Ontario, Canada | Don E. Wilson
National Museum of Natural History
Washington DC, USA |
| Alberto Larrain
Universidad de Concepción
Concepción, Chile | | |

Section 4 Generation, maintenance and loss of biodiversity

- Norma O. Aguilar
Institute of Biological Sciences
Laguna, Philippines
- Dominique Anxolabehere
Institut Jacques Monod
Paris, France
- Michael Archer
University of New South Wales
Sydney, Australia
- Peter Arctander
University of Copenhagen
Copenhagen, Denmark
- Guido Barbujani
Universita Degli Studi di Padova
Padova, Italy
- N.H. Barton
University of Edinburgh
Edinburgh, UK
- James Brewbaker
University of Hawaii
Honolulu, Hawaii, USA
- Neil Burgess
University of Copenhagen
Copenhagen, Denmark
- Martin A. Buzas
National Museum of Natural History
Washington DC, USA
- Hampton L. Carson
c/o University of Hawaii at Monoa
Honolulu, Hawaii, USA
- Bruce B. Collette
National Marine Fisheries Service
Washington, DC, USA
- F. Cotterill
Biodiversity Foundation for Africa
Bulawayo, Zimbabwe
- Walter R. Courtenay, Jr
Florida Atlantic University
Florida, USA
- Donald W. Duvick
Iowa, USA
- Torbjorn Ebhenhard
Swedish Museum of Natural History
and Swedish National Scientific
Committee on Biological Diversity
Stockholm, Sweden
- Jon Fjeldsa
University of Copenhagen
Copenhagen, Denmark
- Paul S. Giller
University College Cork
Cork, Ireland
- David R. Given
David Given & Associates
Christchurch, New Zealand
- Pierre-Henri Gouyon
Université de Paris-Sud XI
Orsay, France
- Susan M. Haig
Oregon State University
Corvallis OR, USA
- Clive Hambler
University of Oxford
Oxford, UK
- John L. Hammerton
Department of Agriculture
Nassau, Bahamas
- L. Edward Harvey
University of Auckland
Auckland, New Zealand
- Julia Horrocks
University of the West Indies
St Michael, Barbados
- Maurice Iwari
Direction Générale de la Pêche
Brazzaville, Congo
- Jurgen Jacobs
Universität München
München, Germany
- Jean-Jacque Jaeger
Université Montpellier II
Montpellier, France
- Michael Kennedy
NSW, Australia
- Susan Kephart
Willamette University
Oregon, USA
- Christopher King
University of Auckland
Auckland, New Zealand
- Robert C. Lacy
Chicago Zoological Society
Brookfield, IL, USA
- Pierre Lasserre
UNESCO
Paris, France
- Peter Lesica
University of Montana
Montana, USA
- Michel Loreau
Université Pierre et Marie Curie
Paris, France
- Erik Matthysen
University of Antwerp
Antwerp, Belgium
- Robert M. May
University of Oxford,
Oxford, UK
- Jorge Meave
Universidad Nacional Autónoma de
México
México DF, Mexico
- Gray Merriam
Carleton University
Ontario, Canada
- Mohamed Mouna
Mohammed V University
Rabat, Morocco

Jean-Claude Mounolou
Université Paris Sud
Gif-Sur-Yvette, France

Tomas Pavlicek
Haifa University
Mt Carmel, Israel

Edwin P. Pister
Bishop
California, USA

G.T. Prance
Royal Botanical Gardens
Kew, Surrey, UK

Outi Savolainen
University of Oulu
Oulu, Finland

Owen J. Sexton
Washington University
St Louis, MO, USA

S.S. Sidhu
Canadian Forest Service
Alberta, Canada

Otto Thomas Solbrig
Harvard University
Cambridge, MA, USA

P.H.G. Stockdale
Massey University
Palmerston North, New Zealand

Nigel E. Stork
The Natural History Museum
London, UK

Pascal Tassy
Université Pierre-et-Marie-Curie
Paris, France

Bruce H. Tiffney
University of California
Santa Barbara, CA, USA

Andreas Y. Troumbis
University of Aegean
Lesbos Island, Greece

Angheluta Vadineanu
Ecology & Environmental
Management,
Bucharest, Romania

Bruce A. Wilcox
Institute for Sustainable Development
Menlo Park, CA, USA

Section 5 Biodiversity and ecosystem functioning: basic principles

N.O. Adedipe
University of Agriculture
Ogun State, Nigeria

Peter S. Ashton
Harvard University
Cambridge, MA, USA

Robert Barbault
Université Pierre et Marie Curie
Paris, France

Geneviere Barnaud
Muséum National d'Histoire
Naturelle
Paris, France

Devin M. Bartley
FAO,
Rome, Italy

Kamaljit Singh Bawa
University of Massachusetts
Boston, MA, USA

John Benzie
Australian Institute of Marine
Sciences,
Queensland, Australia

Jean Boucher
Laboratoire de Ressources
Halleutiques, Plouzane, France

Ingrid C. Burke
Colorado State University
Fort Collins, CO, USA

Bruce Campbell
Grasslands Research Centre
Palmerston North, New Zealand

Stephen R. Carpenter
University of Wisconsin
Madison, WI, USA

Chen Changdu
University of Peking
Beijing, China

A. Aleem Chaudhry
Punjab Wildlife Research Centre
Faisalabad, Pakistan

F. Cotterill
Biodiversity Foundation for Africa
Bulawayo, Zimbabwe

R.J. Ranjit Daniels
M.S. Swaminathan Research
Foundation,
Madras, India

Henri Decamps
Centre d'Ecologie des Systèmes
Fluviaux,
Toulouse, France

Terry Done
Australian Institute of Marine
Science
Queensland, Australia

Exequiel Ezcurra
Centro de Ecología - UNAM
México DF, México

Philip Martin Fearnside
National Institute for Research in the
Amazon-INPA
Manaus-Amazonas, Brazil

Eduardo Fuentes
GEF-UNDP
New York, NY, USA

V.A. Gallardo
Universidad de Concepción
Concepción, Chile

Lawrence E. Gilbert
University of Texas
Austin, TX, USA

David R. Given
David Given & Associates
Christchurch, New Zealand

Philip Grime
University of Sheffield
Sheffield, UK

Clive Hambler
University of Oxford
Oxford, UK

L. Edward Harvey
University of Auckland
Auckland, New Zealand

Ole Hendrickson
Canadian Forestry Service, Hqs
Quebec, Canada

Vernon H. Heywood
University of Reading
Reading, UK

Richard J. Hobbs
Woodbridge Cottage
Scotland, UK

Kent E. Holsinger
University of Connecticut
Connecticut, USA

Fabian M. Jaksic
P. Universidad Católica de Chile
Santiago, Chile

Nancy Knowlton
Smithsonian Tropical Research
Institute,
Balboa, Panama

Christian Korner
University of Basel
Basel, Switzerland

Pierre Lasserre
UNESCO, Paris, France

Valin Marshall
Canadian Forest Service
Victoria, BC, Canada

Michel Loreau
Université Pierre et Marie Curie
Paris, France

Robert M. May
University of Oxford
Oxford, UK

Jose A. Merino
Universidad de Sevilla
Sevilla, Spain

Bedrich Moldan
Charles University
Prague, Czech Republic

Alexander Mosseler
Petawawa National Forestry Institute
Ontario, Canada

R.E. Munn
University of Toronto
Ontario, Canada

Shahid Naeem
University of Minnesota
St Paul, Minneapolis, USA

Zev Naveh
Israel Institute of Technology
Haifa, Israel

Martin Oesterheld
Universidad de Buenos Aires
Buenos Aires, Argentina

Ezekiel Okemwa
Kenya Marine and Fisheries
Research Institute
Mombasa, Kenya

Margery L. Oldfield
Sealuck Foundation
Islip, NY, USA

Chin K. Ong
International Council for Research in
Agroforestry
Nairobi, Kenya

Gordon H. Orians
University of Washington
Seattle, WA, USA

Osca O. Parra
Universidad de Concepción
Concepción, Chile

Robert B. Payne
University of Michigan
Michigan, USA

David Pimentel
Cornell University
Ithaca, NY, USA

Louis F. Pitelka
Electric Power Research Institute
Palo Alto, CA, USA

P.S. Ramakrishnan
Jawaharlal Nehru University
New Delhi, India

Martin G. Raphael
Forestry Sciences Laboratory
Washington DC, USA

Heinz Rennenberg
Albert-Ludwigs Universität
Freiburg, Germany

John G. Robinson
Wildlife Conservation Society
Bronx, NY, USA

Taisitiroo Satoo
Japan Wildlife Research Center
Tokyo, Japan

Jean-Pierre Savard
Canadian Wildlife Service
Quebec, Canada

Davie Scott
New Zealand Pastoral Agriculture,
Research Institute Ltd
Canterbury, New Zealand

S.S. Sidhu
Canadian Forest Service
Alberta, Canada

Otto Thomas Solbrig
Harvard University
Cambridge, MA, USA

Z.N. Tahmida
University of Dhaka
Dhaka, Bangladesh

Monica G. Turner
University of Wisconsin
Madison, WI, USA

Michael B. Usher
Scottish Natural Heritage
Edinburgh, UK

Angheluta Vadineanu
Ecology and Environmental
Management
Bucharest, Romania

Michael Vardon
Wildlife Management International
Pty. Limited
Winnelie, Australia

David Wedin
University of Toronto
Ontario, Canada

Rauno Vaisanen
Forest and Park Service
Helsinki, Finland

John A. Wiens
Colorado State University
Fort Collins, CO, USA

Bruce A. Wilcox
Institute for Sustainable Development
Menlo Park, CA, USA

Mai Dinh Yen
Hanoi University, Hanoi, Vietnam

Georgy A. Zavarzin
Russian Academy of Sciences
Moscow, Russia

Tomasz Zyllicz
Warsaw University
Warsaw, Poland

Section 6 Biodiversity and ecosystem functioning: ecosystem analyses

Pedro M. Alcolado
Instituto de Oceanología
Ciudad de La Habana, Cuba

Miguel A. Altieri
University of California
Albany, CA, USA

Peter S. Ashton
Harvard University
Cambridge, MA, USA

Ratan Lal Banik
Bangladesh Forest Research Institute
Chittagong, Bangladesh

Geneviere Barnaud
Muséum National d'Histoire
Naturelle
Paris, France

Devin M. Bartley
FAO
Rome, Italy

John Benzie
Australian Institute of Marine
Sciences
Queensland, Australia

M. Borobia
United Nations Environment
Programme
Nairobi, Kenya

Jean Boucher
Centre de Brest, Laboratoire de
Ressources halieutiques
Plouzane, France

Bruce Campbell
Grasslands Research Centre
Palmerston North, New Zealand

Stephen R. Carpenter
University of Wisconsin
Madison, WI, USA

Chen Changdu
University of Peking
Beijing, China

A. Aleem Chaudhry
Punjab Wildlife Research Centre
Faisalabad, Pakistan

F. Cotterill
Biodiversity Foundation for Africa
Bulawayo, Zimbabwe

R.J. Ranjit Daniels
M.S. Swaminathan Research
Foundation
Madras, India

Henri Decamps
Centre d'Ecologie des Systèmes
Fluviaux
Toulouse, France

Terry Done
Australian Institute of Marine
Science
Queensland, Australia

Peter N. Duinker
Lakehead University
Ontario, Canada

Exequiel Ezcurra
Centro de Ecología – UNAM
México DF, México

Philip Martin Fearnside
National Institute for Research
in the Amazon-INPA
Manaus-Amazonas, Brazil

Eduardo Fuentes
GEF-UNDP
New York, NY, USA

Lawrence E. Gilbert
University of Texas
Austin, TX, USA

Philip Grime
University of Sheffield
Sheffield, UK

L. Edward Harvey
University of Auckland
Auckland, New Zealand

Vernon H. Heywood The University of Reading Reading, UK	Alexander Mosseler Petawawa National Forestry Institute Ontario, Canada	Ian D. Thompson Petawawa National Forestry Institute Ontario, Canada
Richard J. Hobbs Woodbridge Cottage Scotland, UK	Shahid Naeem University of Minnesota St Paul, Minneapolis, USA	Masanori J. Toda Hokkaido University Sapporo-shi, Japan
Nancy Knowlton Smithsonian Tropical Research Institute Balboa, Panama	Chin K. Ong International Council for Research in Agroforestry Nairobi, Kenya	Monica G. Turner University of Wisconsin Madison, WI, USA
Christian Körner University of Basel Basel, Switzerland	Gordon H. Orians University of Washington Seattle, WA, USA	Angheluta Vadineanu Ecology and Environmental Management Bucharest, Romania
Pierre Lasserre UNESCO Paris, France	A.A. Oteng-Yeboah University of Ghana Legon, Ghana	Rauno Vdisdnen Forest and Park Service Helsinki, Finland
D. Jean Lodge Center for Forest Mycology Research Palmer, Puerto Rico	David Pimentel Cornell University Ithaca, New York, USA	David Wedin University of Toronto Ontario, Canada
Michel Loreau Université Pierre et Marie Curie Paris, France	P.S. Ramakrishnan Jawaharlal Nehru University New Delhi, India	John A. Wiens Colorado State University Fort Collins, CO, USA
Eleuterio Martínez Encargado Dpto de Planificación Ambiental Santo Domingo RD, Rep. Dominicana	Martin G. Raphael Forestry Sciences Laboratory Washington DC, USA	S. Joseph Wright Smithsonian Tropical Research Institute Balboa, Panama
Jeffrey A. McNeely IUCN – The World Conservation Union, Gland, Switzerland	Davie Scott New Zealand Pastoral Agriculture, Research Institute Ltd Canterbury, New Zealand	Mai Dinh Yen Hanoi University, Hanoi, Vietnam
Jose M. Moreno Universidad Complutense Madrid, Spain	S.S. Sidhu Canadian Forest Service Alberta, Canada	Georgy A. Zavarzin Russian Academy of Sciences Moscow, Russia

Section 7 Inventorying and monitoring of biodiversity

N.O. Adedipe University of Agriculture Ogun State, Nigeria	Muhammad Farooq Ahmad Pakistan Secretariat Karachi, Pakistan	Pedro M. Alcolado Instituto de Oceanología Ciudad de La Habana, Cuba
--	--	--

Guard Monday Barya Uganda Institute of Ecology Kampala, Uganda	L. Edward Harvey University of Auckland Auckland, New Zealand	Mircea Oltean Institute of Biology Bucharest, Romania
Bradford E. Brown Southeast Fisheries Science Center Miami, FL, USA	Linda Hedlund Swedish Museum of Natural History Stockholm, Sweden	Matti Palo Finish Forest Research Institute Helsinki, Finland
Sean Carrington University of the West Indies Cave Hill, Barbados	Jeremy Holloway International Institute of Entomology London, UK	A. de Ricqules Université Paris 7 Paris, France
Lin-zhi Chen Institute of Botany Beijing, China	Nobuo Ishii Japan Wildlife Research Center Tokyo, Japan	Jean-Pierre Savard Canadian Wildlife Service Quebec, Canada
John Collie Ministry of Foreign Affairs, Planning & Environment Mahe, Seychelles	D. Janzen c/o Instituto Nacional de Biodiversidad Santo Domingo de Heredia, Costa Rica	Outi Savolainen University of Oulu Oulu, Finland
F. Cotterill Biodiversity Foundation for Africa Bulawayo, Zimbabwe	Tecwyn Jones International Mycological Institute Surrey, UK	Jorge Soberón Mainero Comisión Nacional para el Conocimiento y Uso de la Biodiversidad Mexico City, México
R.J. Ranjit Daniels M.S. Swaminathan Research Foundation, Madras, India	Pierre Lasserre UNESCO Paris, France	Bella Raphael Striganova Institute of Animal Evolutionary Morphology and Ecology Moscow, Russia
Italo D. De Murtas ENEA – National Committee for New Technologies, Energy and Environment Rome, Italy	Joris Latour Laboratory for Soil and Groundwater Research Bilthoven, Netherlands	Ben ten Brink National Institute of Public Health and Environmental Protection Bilthoven, Netherlands
Henri Dumont University of Gent Gent, Belgium	Tomasz Linkowski Sea Fisheries Institute Gdynia, Poland	Ian D. Thompson Petawawa National Forestry Institute Ontario, Canada
Mohamed Fennane University Mohammed V Rabat, Morocco	N.L. McKenzie Western Australian Wildlife WA, Australia	Bjorn Age Tommeraas NINA, Trondheim, Norway
David R. Given David Given & Associates Christchurch, New Zealand	Mohamed Mouna Mohammed V University Rabat, Morocco	Michael B. Usher Scottish Natural Heritage Edinburgh, UK
Zbigniew Glowacinski Institute of Nature Conservation Krakow, Poland	Toni Nikolic University of Zagreb Zagreb, Croatia	Cephas Ward College of the Bahamas Nassau, Bahamas
John L. Hammerton Department of Agriculture Nassau, Bahamas	Nils-Erik Nilsson Krylbo, Sweden	

Paul Williams
Natural History Museum
London, UK

José Yanez
Museo Nacional de Historia Natural
Santiago, Chile

Section 8 The resource base for biodiversity assessments

Kaare Aagaard
NINA
Trondheim, Norway

Torbjorn Ebhenhard
Swedish Museum of Natural History
and Swedish National Scientific
Committee on Biological Diversity
Stockholm, Sweden

Alberto Larrain
Universidad de Concepción
Concepción, Chile

N.O. Adedipe
University of Agriculture
Ogun State, Nigeria

Aly A. El Moursy
University of Cairo
Cairo, Egypt

Jeffrey A. McNeely
IUCN – The World Conservation
Union
Gland, Switzerland

Ross E. Beever
Landcare Research
Auckland, New Zealand

Jon Fjeldsa
University of Copenhagen
Copenhagen, Denmark

Mohamed Menioui
Centre National de Coordination et
de Planification de la Recherche
Scientifique
Rabat, Morocco

Philippe Bouchet
Laboratoire de Biologie des
Invertébrés
Paris, France

Rodrigo Gámez
Instituto Nacional de Biodiversidad
Santo Domingo de Heredia,
Costa Rica

Gray Merriam
Carleton University
Ontario, Canada

Donald G. Broadley
National Museums and Monuments
Bulawayo, Zimbabwe

David R. Given
David Given and Associates
Christchurch, New Zealand

Scott E. Miller
Natural Science
Honolulu, HI, USA

Neil Burgess
University of Copenhagen
Copenhagen, Denmark

S.J.G. Hall
University of Capetown
Rondebosch, South Africa

Brian D. Morley
State Herbarium of South Australia
Adelaide, Australia

F. Cotterill
Biodiversity Foundation for Africa
Bulawayo, Zimbabwe

Stephen Halloy
Fundación Amigos de la Naturaleza
Santa Cruz, Bolivia

A. Peerally
University of Mauritius
Reduit, Mauritius

Ana Crespo
Universidad Complutense
Madrid, Spain

Ole Hamann
University of Copenhagen
Copenhagen, Denmark

Derek Pomeroy
Makerere University
Kampala, Uganda

David Currie
University of Ottawa
Ottawa, Canada

Clive Hambler
University of Oxford
Oxford, UK

G. Carleton Ray
University of Virginia
Virginia, USA

R.J. Ranjit Daniels
M.S. Swaminathan Research
Foundation
Madras, India

Malcolm L. Hunter, Jr
University of Maine
Orono, ME, USA

Scott Redhead
Centre for Land and Biological
Resources Research
Ottawa, Ontario, Canada

Henri Dumont
University of Gent
Gent, Belgium

Daniel H. Janzen
University of Pennsylvania
Philadelphia, PA, USA

Owen J. Sexton
Washington University
St Louis, MO, USA

He Shan-An
Jiangsu Institute of Botany
Jiangsu, China

Joon Hwan Shin
Forestry Research Institute
Seoul, Korea
S.S. Sidhu
Canadian Forest Service
Alberta, Canada

Erko Stackebrandt
Deutsche Sammlung von
Mikroorganismen und Zellkulturen
GmbH
Braunschweig, Germany

Monica Swartz
University of Texas at Austin
Austin, TX, USA

Jean-March Thiollay
Laboratoire d'Ecologie
Paris, France

Rauno Vdisdnen
Forest and Park Service
Helsinki, Finland

Section 9 Data and information management and communication

Ana Cueto Asín
Proyectos de Gestión
Documental S.L.
Madrid, Spain

Luigi Boitani
University of Rome La Sapienza
Rome, Italy

F. Cotterill
Biodiversity Foundation for Africa
Bulawayo, Zimbabwe

Martin Fisher
Sultan Qaboos University
Muscat, Oman

Chris A. Freyberg
Massey University
Palmerston North, New Zealand

L. Edward Harvey
University of Auckland
Auckland, New Zealand

Vernon H. Heywood
The University of Reading
Reading, UK

K. Elaine Hoagland
Association of Systematics
Collections
Washington DC, USA

Pierre Lasserre
UNESCO
Paris, France

Jim Mowder
USDA Agricultural Research
Service, Beltsville, MD, USA

Accel Armand Ndinga-Makanda
Secretariat d'Etat a la Science et
Technologie
Brazzaville, Congo

Toni Nikolic
University of Zagreb
Zagreb, Croatia

Henry Shands
USDA Agricultural Research Service
Beltsville, MD, USA

Nancy Steger
The New York Botanical Garden
Bronx, NY, USA

Johan Thissen
National Reference Centre for Nature
Management
Wageningen, Netherlands

John Whiting
Canadian Biodiversity Information
Consortium
Ontario, Canada

Section 10 Biotechnology

Peter Arctander
University of Copenhagen
Copenhagen, Denmark

Charles J. Arntzen
Texas A&M University
Houston, TX, USA

Jacques Balandreau
Université Lyon 1
Villeurbanne, France

John Beringer
University of Bristol
Bristol, UK

Mark F. Cantley
Science & Technology Policy
Division, OECD
Paris, France

Pierre Charest
Patawawa National Forestry Institute
Ontario, Canada

Antoine Danchin
Institut Pasteur
Paris, France

Tom Edge
Biotechnology Section, Environment
Canada
Quebec, Canada

Clifford J. Gabriel
American Institute of Biological
Sciences
Washington DC, USA

Moon Hi Han
Genetic Engineering Research
Institute
Taejon, Korea

Pierre Lasserre
UNESCO
Paris Cedex, France

Ian S. Maddox
Massey University
Palmerston North, New Zealand

Adel M. Mahasneh
University of Jordan
Amman, Jordan

Jean-Claude Mounolou
Université Paris Sud
Gif-Sur-Yvette, France

Inger G. Naess
Ministry of Environment
Oslo, Norway

Richard Powell
University College Galway
Galway, Ireland

Outi Savolainen
University of Oulu
Oulu, Finland

Cyriaque Sendashonga
United Nations Environment
Programme
Nairobi, Kenya

Mario Silva
Universidad de Concepción
Concepción, Chile

Sutat Sriwatanapongse
Ministry of Science, Technology and
Environment
Bangkok, Thailand

P.J. Van der Meer
Ministry of Housing, Physical
Planning & Environment
The Hague, Netherlands

Gheorghe Zarnea
Institute of Biology of Romanian
Academy
Bucharest, Romania

Section 11 Human influences on biodiversity

Peder Agger
Dept of Environment, Technology &
Social Studies
Roskilde, Denmark

Janis E. Alcorn
World Wide Fund for Nature
Washington DC, USA

Margarita Astralaga
Convention on International Trade in
Endangered Species of Wild Fauna
and Flora
Geneva, Switzerland

Mohamed A. Ayyad
Alexandria University
Alexandria, Egypt

Maadjou Bah
Direction Nationale de
l'Environnement
Conakry, Guinea

Trygve Berg
Agricultural University of Norway
Norway

Fikret Berkes
University of Manitoba
Manitoba, Canada

Darcie L Booth
Policy, Economics & International
Affairs Directorate
Quebec, Canada

M. Borobia
United Nations Environment
Programme
Nairobi, Kenya

B. Campbell
Natural Resources Institute
Kent, UK

Christopher Cocklin
University of Auckland
Auckland, New Zealand

Maria Concepción J. Cruz
World Bank
Washington DC, USA

Jose Rodrigues Duenas
Ministerio de Ciencia, Tecnología y
Medio Ambiente
Habana, Cuba

David R. Given
David Given and Associates
Christchurch, New Zealand

L. Edward Harvey
University of Auckland
Auckland, New Zealand

Vernon H. Heywood
The University of Reading
Reading, UK

John Hodges
Mittersill, Australia

A.J.T. Johnsingh
Wildlife Institute of India
Dehra Dun, India

Amin U. Khan
Government College
Lahore, Pakistan

- Tokimasa Kobayashi
National Research Institute of
Fisheries Science
Kanagawa, Japan
- Danna J. Leaman
International Development Research
Centre
Ottawa, Canada
- E.J. Milner-Gulland
University of Warwick
Coventry, UK
- John L. Munro
ICLARM
Manila, Philippines
- Julius A. Okojie
University of Agriculture
Ogun State, Nigeria
- Guinilla Almered Olsson
University of Trondheim
Trondheim, Norway
- A.K. Omideyi
Obafemi Awolowo University
Ogun State, Nigeria
- George L. Peterson
USDA-Forest Service
Fort Collins, CO, USA
- Ramon Pichs Madruga
Centro de Investigaciones de la
Economía Mundial
Habana, Cuba
- D.F. Pollard
Canadian Forest Service
Victoria, BC, Canada
- Richard Potts
National Museum of Natural History
Washington DC, USA
- Vo Quy
Hanoi National University
Hanoi, Vietnam
- Martin G. Raphael
Forestry Sciences Laboratory
Washington DC, USA
- Haro Nijavalli Ravindranath
Indian Institute of Science
Bangalore, India
- Peter Read
Massey University
Palmerston North, New Zealand
- John G. Robinson
Wildlife Conservation Society
Bronx, NY, USA
- S.S. Sidhu
Canadian Forest Service
Alberta, Canada
- K. Ravi Srinivas
Pushpak, Madurai, India
- Claus W. Stortenbeker
Arnhem, Netherlands
- Michael B. Usher
Scottish Natural Heritage
Edinburgh, UK
- Michael Vardon
Wildlife Management International
Pty. Limited
Winnelie, Australia
- Rauno Vdisdnen
Forest and Park Service
Helsinki, Finland
- Grahame Webb
Wildlife Management International
Pty. Limited
Winnelie, Australia
- Don E. Wilson
National Museum of Natural History
Washington DC, USA
- Wang Xianpu
Chinese Academy of Sciences
Beijing, China
- Yang Zhouhuai
Chinese Academy of Sciences
Beijing, China

Section 12 Economic values of biodiversity

- Scott Barrett
London Business School
London, UK
- Michael Common
Australian National University
Canberra ACT, Australia
- Rudolf S. De Groot
Agricultural University
Wageningen, Netherlands
- Moon Hi Han
Genetic Engineering Research
Institute
Taejon, Korea
- D.S. Ingram
Royal Botanic Garden Edinburgh
Edinburgh, UK
- Finn Kateraas
Directorate for Nature Management
Trondheim, Norway
- Ke Chung Kim
Pennsylvania State University
Pennsylvania, PA, USA
- Bryan G. Norton
Georgia Institute of Technology
Atlanta, GA, USA
- Margery L. Oldfield
Sealuck Foundation
Islip, NY, USA

Hans Opschoor
Council on Environmental and
Nature Research
Rijswijk, Netherlands

Diane Osgood
ICRAF
Nairobi, Kenya

Adeniyi Osuntogun
Foundation for Environmental
Development and Education in
Nigeria
Lagos, Nigeria

Matti Palo
Finish Forest Research Institute
Helsinki, Finland

D.W. Pearce
University of College London
London, UK

George L. Peterson
USDA-Forest Service
Fort Collins, CO, USA

David Pimentel
Cornell University
Ithaca, NY, USA

A. Rahman
United Nations Environment
Programme
Nairobi, Kenya

Alan Randall
Ohio State University
Columbus, OH, USA

Kalimullah Shirazi
Environment & Urban Affairs
Division
Islamabad, Pakistan

James A. Tobey
Environmental Directorate
Paris, France

Ekko Van Ierland
Agricultural University Wageningen
Wageningen, Netherlands

Richard Walsh
Colorado State University
Fort Collins, CO, USA

Michael Wells
Lier, Norway

Section 13 Measures for conservation of biodiversity and sustainable use of its components

Ana Aber
Dirección Nacional de Medio
Ambiente
Montevideo, Uruguay

Janis E. Alcorn
World Wide Fund for Nature
Washington DC, USA

Mohamed A. Ayyad
Alexandria University
Alexandria, Egypt

Aiko Bode
United Nations Environment
Programme
Nairobi, Kenya

Darcie L. Booth
Policy, Economics & International
Affairs Directorate,
Quebec, Canada

M. Borobia
United Nations Environment
Programme,
Nairobi, Kenya

Susan Bragdon
Secretariat for Convention on
Biological Diversity
Geneva, Switzerland

Stephen B. Brush
IPGRI
Rome, Italy

John Cairns
Virginia Polytechnic Institute &
State University
Blacksburg, VA, USA

Julian Caldecott
Cambridge, UK

B. Campbell
Natural Resources Institute
Kent, UK

Victor Canton
Dirección Nacional de Medio
Ambiente
Montevideo, Uruguay

Manab Chakraborty
Secretariat to Convention on
Biological Diversity
Geneva, Switzerland

Rodolfo Claro Madruga
Instituto de Oceanología
Habana, Cuba

Christopher Cocklin
University of Auckland
Auckland, New Zealand

R.J. Ranjit Daniels
M.S. Swaminathan Research
Foundation
Madras, India

Robert DeFilipps
National Museum of Natural History
Washington DC, USA

Jose Rodrigues Duenas
Ministerio de Ciencia, Tecnología y
Medio Ambiente
Habana, Cuba

David Farrier
University of Wollongong
Wollongong, NSW, Australia

Enrique Forero
Institute of Systematic Botany
Bronx, NY, USA

- Diana W. Freckman
Colorado State University
Fort Collins, CO, USA
- José Furtado
World Bank
Washington DC, USA
- Rodrigo Gámez
Instituto Nacional de Biodiversidad
Santo Domingo de Heredia,
Costa Rica
- Adrian Gwynne-James
London, UK
- Anthony V. Hall
Animal Welfare and Human-Animal
Interactions Group
Cambridge, UK
- G.P. Hekstra
Ministry of Housing, Spatial
Planning and Environment
The Hague, Netherlands
- Ole Hendrickson
Canadian Forestry Service
Headquarters
Quebec, Canada
- Mario-Angele Hermitte
Paris, France
- John Hodges
Mittersill, Australia
- Martin W. Holdgate
Cambridge, UK
- Thandi Hurworth
International Technology Transfer
Consultants
Worcs, UK
- Larry L. Irwin
National Council of the Paper
Industry for Air and Stream
Improvement, Inc.
Darby, MT, USA
- D. Janzen
c/o Instituto Nacional de
Biodiversidad
Santo Domingo de Heredia,
Costa Rica
- Sam Johnston
University of Cambridge
Cambridge, UK
- Daouda Kante
National Environment Directorate
Conakry, Guinea
- Richard Kenchington
Great Barrier Reef Marine Park
Authority
Canberra, Australia
- Christopher King
University of Auckland
Auckland, New Zealand
- Tatsu Kishida
National Research Institute of
Fisheries Science
Kanagawa, Japan
- Tokimasa Kobayashi
National Research Institute of
Fisheries Science
Kanagawa, Japan
- Judy Lambert
Community Solutions
NSW, Australia
- Pierre Lasserre
UNESCO
Paris, France
- Peter Lesica
University of Montana
Montana, USA
- Kreg Lindberg
Ecotourism Society
Alexandria, VA, USA
- Owen Lynch
World Resources Institute
Washington DC, USA
- John D. MacArthur
University of Bradford
Bradford, UK
- E.J. Milner-Gulland
University of Warwick
Coventry, UK
- Alexander Mosseler
Petawawa National Forestry Institute
Ontario, Canada
- Richard B. Norgaard
University of California
Berkeley, CA, USA
- Hideo Obara
Kagawa Nutrition College (Joshi
Eiyo University)
Saitama, Japan
- F.M. Dania Ogbe
University of Benin
Benin, Nigeria
- Julius A. Okojie
University of Agriculture
Ogun State, Nigeria
- Synthya Penn
Beneficial Insectory
Oak Run, CA, USA
- David Pimentel
Cornell University
Ithaca, NY, USA
- D.F. Pollard
Canadian Forest Service
Victoria, BC, Canada
- Roger S.V. Pullin
International Center for Living
Aquatic Resources Management
Manila, Philippines
- Peter Read
Massey University
Palmerston North, New Zealand
- Taisitiroo Satoo
Japan Wildlife Research Center
Tokyo, Japan

Jean-Pierre Savard
Canadian Wildlife Service
Quebec, Canada

Arne Schiotz
Danmarks Akvarium
Charlottenlund, Denmark

Cyriaque Sendashonga
United Nations Environment
Programme
Nairobi, Kenya

S.S. Sidhu
Canadian Forest Service
Alberta, Canada

K. Ravi Srinivas
Pushpak, Madurai, India

P.H.G. Stockdale
Massey University
Palmerston North, New Zealand

Kunio Suzuki
Yokohama National University
Kanagawa, Japan

Timothy M. Swanson
University of Cambridge
Cambridge, UK

Jean-March Thiollay
Laboratoire d'Ecologie
Paris, France

Shaju Thomas
University of Kerala
Thiruvananthapuram, India

Angheluta Vadineanu
Ecology & Environmental
Management
Bucharest, Romania

T.C. Whitemore
University of Cambridge
Cambridge, UK

Wang Xianpu
Chinese Academy of Sciences
Beijing, China

Jianchu Xu
Kunming Institute of Botany
Kunming, China

Yang Zhouhuai
Chinese Academy of Sciences
Beijing, China

Annex 6

Glossary

accession	a sample of a crop variety collected at a specific location and time; may be of any size.
actual evaporation	estimate of how much of the existing precipitation could be evaporated or transpired from a standard 'sward' of grass on a standard soil.
adaptation	a genetically determined characteristic that enhances the ability of an organism to cope with its environment.
adaptive landscape	a graph of the average fitness of a population in relation to the frequencies of genotypes in it: peaks on the landscape correspond to genotypic frequencies at which the average fitness is low.
adaptive radiation	evolutionary diversification of species derived from a common ancestor into a variety of ecological roles.
adaptive zone	a particular type of environment requiring unique adaptations then allowing adaptive radiation to occur.
agroecology	the use of ecological concepts and principles to study, design, and manage agricultural systems. Agroecology seeks to evaluate the full effect of system inputs and outputs by integrating cultural and environmental factors into the analysis of food production systems and to use this knowledge to improve these systems, taking into account the needs of both the ecosystem as a whole and the people within it.
agroforestry	a collective name for land-use systems and technologies where woody perennials (trees, shrubs, palms, bamboos, etc.) are deliberately used on the same land management unit as agricultural crops and /or animals, either in some form of spatial arrangement or temporal sequence.
alien species	<i>see</i> introduced species.
Allee effect	phenomenon in which survival of individuals is increased by aggregation.
allele	one of several alternatives of a gene.

allopatric	occupying different geographical ranges.
allopatric speciation	speciation via geographically separated populations.
apoendemic	polyploid endemics that are derived from widespread species of a lower ploidy level.
aquaculture	breeding and rearing fish, shellfish, etc., or growing plants for food in special ponds.
artificial insemination	a breeding technique, most commonly used in domestic animals and sometimes in captive breeding of wild animals, in which semen is introduced into the female reproductive tract by artificial means.
artificial selection	selective breeding, carried out by humans, to produce a desired evolutionary response.
assets	goods that provide a flow of services over time.
baseline data	fundamental units of basic inventory information that are crucial for biodiversity conservation planning and management. These are both biotic and abiotic and usually include: (1) the presence and/or abundance of species and other units; (2) other dependent biotic data (e.g. plant cover for macroarthropods); (3) the appropriate influential abiotic variables, and (4) human variables.
benthos	living at the bottom of the sea or a lake.
bequest value	value, defined by willingness to pay, to ensure that peoples' offspring or future generations inherit a particular environmental asset.
biocoenosis	varied community of organisms living in the same small area, e.g. in the bark of a tree.
biogeography	the scientific study of the geographic distribution of organisms.
biological control	control of pests by using predators to eat them.
biological resources	those components of biodiversity of direct, indirect, or potential use to humanity.
biome	a major portion of the living environment of a particular region (such as a coniferous forest or grassland), characterized by its distinctive vegetation and maintained by local climatic conditions.
biopesticide	pesticide made from biological sources, that is from toxins which occur naturally.
bioregion	a territory defined by a combination of biological, social, and geographic criteria, rather than geopolitical considerations; generally, a system of related, interconnected ecosystems.
biosphere reserve	established under UNESCO's Man and the Biosphere (MAB) Programme, biosphere reserves are a series of protected areas linked through a global network, intended to demonstrate the relationship between conservation and development.
biotope	small area with uniform biological conditions (climate, soil, altitude, etc.).

biotype	group of genetically identical individuals.
buffer zone	the region near the border of a protected area; a transition zone between areas managed for different objectives.
breed	a group of animals or plants related by descent from common ancestors and visibly similar in most characteristics. Taxonomically, a species can have numerous breeds.
Cambrian	the earliest period of the Palaeozoic era, extending from 500 to 550 million years ago.
captive breeding	the propagation or preservation of animals outside their natural habitat (see <i>ex situ</i> conservation), involving control by humans of the animals chosen to constitute a population and of mating choices within that population.
centre of diversity	an area with a high number of species, which might be recognized on a global, regional or local scale.
character	any recognizable trait, feature, or property of an organism.
chemicalization	accumulation of unnatural concentrations of certain chemical compounds.
clade	set of species from a common ancestral species.
clear-cutting	the removal of the entire standing crop of trees. In practice, may refer to exploitation that leaves much unsaleable material standing (e.g. a commercial clear-cutting).
clone	a set of genetically identical organisms asexually reproduced from one ancestral organism.
co-adaptation	evolution of characteristics of two or more species to their mutual advantage.
co-evolution	evolution in two or more interacting species in which the evolutionary changes of each species influence the evolution of the other species.
co-management	the sharing of authority, responsibility, and benefits between government and local communities in the management of natural resources.
common property resource management	the management of a specific resource (such as a forest or pasture) by a well-defined group of resource users with the authority to regulate its use by members and outsiders.
community	all the organisms that live in a given habitat and affect one another as part of the food web or through their various influences on the physical environment.
compensating variation	the change in income necessary to restore the consumer to its original level of utility after a price change.
competition	use or defence of a resource by one individual that reduces the availability of the resource to other individuals.

competitive exclusion	the extinction of one species by another species in the same area through competition.
conservation	judicious use and management of nature and natural resources for the benefit of human society and for ethical reasons.
conservation values	the value to society of conserving environmental resources.
cost–benefit analysis (CBA)	the appraisal of an investment project which includes all social and financial costs and benefits accruing to the project.
counterurbanization	selling your apartment and buying a tent.
crossing over	the process in which the chromosomes of a diploid pair exchange genetic material. It produces genetic recombination.
cryogenic storage	the preservation of seeds, semen, embryos, or microorganisms at extremely low temperatures, below -130°C . At these temperatures, water is absent, molecular kinetic energy is low, diffusion is virtually nil, and storage potential is expected to be extremely long.
cultivar	a cultivated variety (genetic strain) of a domesticated crop plant.
debt-for-nature swaps	a conservation agency buys up some of a developing country's international debt ('secondary' debt) on the world's money market. The agency then promises to dispose of the debt in return for a promise from the indebted country that it will look after a conservation area.
demography	the study of birth rates, death rates, age distributions, and size of populations. It is a fundamental discipline within the larger field of population biology and ecology.
development values	the value to society of converting environmental resources to development uses.
derived demand approach	<i>see</i> Revealed Preference Approach.
diploid	having two sets of genes and two sets of chromosomes – one from the female parent, one from the male parent.
direct use value	economic values derived from direct use or interaction with a biological resource or resource system.
direct valuation approach	<i>see</i> Stated Preference Methods.
directional selection	selection leading to a consistent directional change in any character of a population through time, for example selection for larger eggs.
discounting	lowering the importance that is attached to gains and losses in the future.
dispersal	movement of organisms away from place of birth.
disruptive selection	selection favouring individuals that deviate in either direction from the population average. Selection favours individuals that are larger or smaller than average.
domestication	the process by which plants, animals or microbes selected from the wild adapt to a special habitat created for them by humans.

domesticates	organisms that have undergone domestication.
domestic biodiversity	the genetic variation existing among the species, breeds, cultivars and individuals of animal, plant and microbial species that have been domesticated, often including their immediate wild relatives.
DNA	deoxyribonucleic acid, the molecule that controls inheritance.
drift	<i>see</i> genetic drift.
ecosystem	a dynamic complex of plant, animal, fungal, and micro-organism communities and their associated non-living environment interacting as an ecological unit; the organisms living in a given environment, such as a tropical forest or a lake, and the physical part of the environment that impinges on them.
ecosystem rehabilitation	the recovery of specific ecosystem services in a degraded ecosystem or habitat.
ecosystem/ecological resilience	ecological resilience can be defined in two ways. The first is as a measure of the magnitude of disturbance that can be absorbed before the (eco)system changes its structure by changing the variables and processes that control behaviour. The second, a more traditional meaning, is as a measure of resistance to disturbance and the speed of return to the equilibrium state of an ecosystem.
ecosystem restoration	the return of an ecosystem or habitat to its original community structure, natural complement of species, and natural functions.
ecosystem services/ ecological services	ecological processes or functions which have value to individuals or society.
ecotourism	travel undertaken to witness sites or regions of unique natural or ecological quality, or the provision of services to facilitate such travel.
edge effect	processes that characterize habitat fragmentation and the concomitant creation of edges.
endemic	restricted to a specified region or locality.
equilibrium theory	theory that suggests that under natural circumstances, species addition and loss are balanced, and furthermore, that displacement from the equilibrium value results in changes in speciation or extinction rate that tend to restore the system to its equilibrium state.
equity	the opposite of inequity.
equivalent variation	an income change that is equivalent which has the same effect on utility or welfare as a price.
ethical values	statements of ethical principle that inform the private and social valuation of biological resources.
ethnobiology	study of the way plants, animals and micro-organisms are used by humans.
eukaryote	an organism whose DNA is enclosed in nuclear membranes. The vast majority of species are eukaryotic.

eutrophication	process by which a lake becomes full of phosphates and other nutrients which encourage the growth of algae and kill other organisms.
existence value	the value of knowing that a particular species, habitat or ecosystem does and will continue to exist. It is independent of any use that the valuer may make of the resource.
ex situ conservation	keeping components of biodiversity alive away from their original habitat or natural environment.
external costs/externalities	external costs/benefits exist when an activity by one person causes a gain/loss of welfare to another person that is uncompensated within the market
extinction	the death of any lineages of organisms. Extinction can be local, (when it is known as extirpation) in which one population of a given species vanishes while others survive elsewhere, or total, in which all its populations vanish.
extractive reserve	forest area for which use rights are granted by governments to residents whose livelihoods customarily depend on extracting forest products from the specified area.
fallow	the period during which land is left to recover its productivity (reduced by cropping) mainly through accumulation of water, nutrients, attrition of pathogens, or a combination of all three. During this period, the land may be bare or covered by natural or planted vegetation. The term may be applied to the land itself or to the crop growing on it.
fauna	all of the animals found in a given area.
fecundity	rate at which females produce offspring.
fitness	the expected contribution of an allele, genotype, or phenotype to future generations. the fitness of genes and organisms is always relative to the other genes and organisms that are present in the same population. Usually it is measured as the average number of offspring produced by individuals with a certain genotype, relative to the number produced by other genotypes.
flagship species	popular, charismatic species that serve as symbols and rallying points to stimulate conservation awareness and action.
flora	all of the plants found in a given area.
Flora	a book listing, with descriptions, all plants that grow in a particular area.
food web	an abstract representation of the various paths of energy flow through populations in the community.
founder effect	the loss of genetic diversity when a new colony is formed by a very small number of individuals from a larger population.
fragmentation	the breaking up of extensive landscape features into disjunct, isolated, or semi-isolated patches as a result of land-use changes.
free-rider problem of public goods	because the use of public goods by one person does not exclude others, each user has an incentive to allow others to pay the cost of the public good.

functional diversity	this can refer to two rather different concepts: the diversity of the ecological functions performed by different species, and the diversity of species performing a given ecological function.
gene	the functional unit of heredity. It is part of the DNA molecule that encodes a particular protein.
gene bank	a storage facility where germplasm is stored in the form of seeds, pollen, embryos, semen, pollen, or <i>in vitro</i> culture, or in cryogenic storage, or, in the case of a field gene bank, as plants growing in the field.
gene flow	exchange of genetic traits between populations by movement of individuals, gametes or spores.
genetic diversity	variation in the genetic composition of individuals within or among species; the heritable genetic variation within and among populations.
genetic drift	random gene frequency changes in a small population due to chance alone.
genetic erosion	loss of genetic diversity between and within populations of the same species over time; or reduction of the genetic basis of a species due to human intervention, environmental changes, etc.
genetic resources	genetic material of plants, animals or micro-organisms, including modern cultivars and breeds, primitive varieties and breeds, landraces and wild/weedy relatives of crop plants or domesticated animals, of value as a resource for future generations of humanity.
genome	all the genes of a particular organism or species.
genotype	the entire genetic constitution of an organism, or the genetic composition at a specific gene locus or set of loci.
germplasm	a set of different genotypes that may be conserved and used; the genetic material, especially its specific molecular and chemical constitution, that comprises the physical basis of the inherited qualities of an organism.
guild	a group of species found in the same place that share the same food resource. Example: the lizard species of a sand dune that feed on insects.
habitat	the space used by an organism, together with the other organisms with which it coexists, and the landscape and climate elements that affect it; the place where an animal or a plant normally lives and reproduces.
haploid	cell or organism that contains one set of chromosomes.
heterosis	situation in which the heterozygote has a higher fitness than either homozygote.
heterozygosity	genetic variability among individuals within populations and variability among populations.
homozygote	individual having two copies of the same allele at a genetic locus.
hybridization	crossing of individuals from genetically different strains, populations or species.

hybrid zone	region of reproduction among individuals of different species.
inbreeding	mating among related individuals.
inbreeding depression	a reduction in fitness and vigour of individuals as a result of increased homozygosity through inbreeding in a normally outbreeding population.
<i>in situ</i> conservation	the conservation of biodiversity within the evolutionary dynamic ecosystems of the original habitat or natural environment.
<i>in situ</i> gene banks	protected areas designated specifically to protect genetic variability of particular species.
income	a flow of money, goods or services deriving from the productive use of assets.
indicator species	a species whose status provides information on the overall condition of the ecosystem and of other species in that ecosystem. Species which flag changes in biotic or abiotic conditions. They reflect the quality and changes in environmental conditions as well as aspects of community composition.
indigenous peoples	people whose ancestors inhabited a place or country when persons from another culture or ethnic background arrived on the scene and dominated them through conquest, settlement, or other means and who today live more in conformity with their own social, economic, and cultural customs and traditions than with those of the country of which they now form a part. (Also: 'native peoples' or 'tribal peoples'.)
indirect use or derived value	economic value derived from the role of resources and systems in supporting or protecting activities whose outputs have direct value in production or consumption.
indirect valuation methods	<i>see</i> Revealed Preference Approach.
inefficiency	an allocation of resources is said to be inefficient if there is another allocation such that one person can be made better off without making anyone worse off.
infochemical	information in the form of chemical substances.
instrumental values	<i>see</i> Use Values.
insurance value	the value of biodiversity in maintaining ecosystem functions over a range of environmental conditions.
integrated pest management	an ecologically based strategy that relies on natural mortality factors, such as natural enemies, weather, and crop management, and seeks to control tactics that disrupt these factors as little as possible while enhancing their effectiveness.
intellectual property right	a right enabling an inventor to exclude imitators from the market for a limited time.
intergenerational equity	a core proposition is that future generations have a right to an inheritance (capital bequest) sufficient to allow them to generate a level of well-being no less than that of the current generation. Fairness in the treatment of different members of the same generation.

introduced species	a species occurring in an area outside its historically known natural range as a result of intentional or accidental dispersal by human activities. (Also known as an exotic or alien species.)
introgression	incorporation of genes of one species into a gene pool of another species.
invasive species	an introduced species which invades natural habitats.
inventorying	the surveying, sorting, cataloguing, quantifying and mapping of entities such as genes, individuals, populations, species, habitats, ecosystems and landscapes or their components, and the synthesis of the resulting information for the analysis of process.
iron law of the discount rate	species with a growth rate less than the rate of discount will be optimally driven to extinction unless extraction is regulated or the growth in the value of the species compensates for the difference.
joint products	commodities which are produced in such a way that a change in the output of one of them necessarily involves a change in the output of the other.
karyotype	characteristic chromosomes of a species.
keystone species	a species whose loss from an ecosystem would cause a greater than average change in other species populations or ecosystems processes; species that have a disproportionately large effect on other species in a community.
landrace	a crop cultivar or animal breed that evolved with and has been genetically improved by traditional agriculturalists, but has not been influenced by modern breeding practices.
land tenure	the right to exclusively occupy and use a specified area of land. Tenure may also be limited to certain resources ('resource tenure') such as timber but not to all resources in a given area. Tenure may be held by individuals, communities, government, or corporations.
large marine ecosystems	regions of ocean space encompassing coastal areas from river basins to estuaries to the seaward boundary of continental shelves and seaward margins of coastal current systems. They are relatively large regions, characterized by distinct bathymetry, hydrography, productivity and trophically linked populations.
locus	the site on a chromosome occupied by a specific gene.
macroevolution	large-scale evolution, entailing major changes in biological traits.
managed forest	productive forest where harvesting regulations are enforced, silvicultural treatments are carried out, and trees are protected from fires and diseases.
marginal values	the change in the value of a resource that is due to an incremental change in its quantity.
market failure	this occurs when market prices are not equal to the social opportunity cost of resources. External effects or externalities are evidence of market failure.

market prices	prices generated through a market mechanism. When all costs and benefits (societal) have not been taken into account, this may be less than the social cost.
maximum sustainable yield	the largest yield that can be obtained which does not deplete or damage natural resources irreparably and which leaves the environment in good order for future generations.
Mesozoic	era extending from 245 to 66 million years ago.
metapopulation	a set of partially isolated populations belonging to the same species. The different populations are able to exchange individuals and recolonize sites in which the species has recently become extinct.
microevolution	evolutionary changes on the small scale, such as changes in gene frequencies within a population.
minimum viable population	the smallest isolated population having a good chance of surviving for a given number of years despite the foreseeable effects of demographic, environmental, and genetic events and natural catastrophes. (The probability of persistence and the time of persistence are often taken to be 99% and 1000 years, respectively.)
monitoring	the intermittent (regular or irregular) surveillance to ascertain the extent of compliance with a predetermined standard or degree of deviation from an expected norm (Hellawell 1991).
monophyletic group	set of species containing a common ancestor and all its descendants.
mutation	any change in the genotype of an organism occurring at the gene, chromosome or genome level.
mutualism	interspecific relationship in which both organisms benefit. Example: flower pollination by insects.
native species	plants, animals, fungi, and micro-organisms that occur naturally in a given area or region.
natural forest management system	controlled and regulated harvesting of forest trees, combined with silvicultural and protective measures, to sustain and increase the commercial value of subsequent stands; relies on natural regeneration of native species.
natural selection	process by which the genotypes in a population that are best adapted to the environment increase in frequency relative to less well-adapted genotypes over a number of generations.
neoendemics	clusters of closely related species and subspecies that have evolved relatively recently.
net present value	the discounted value of the net benefits of use of a resource.
niche	the place occupied by a species in its ecosystem and its role: where it lives, what it feeds on and when it performs all its activities.
nitrogen fixation	biological assimilation of atmospheric nitrogen to form organic nitrogen-containing compounds.

non-consumptive value non-use or passive use value	the value of resources which are not diminished by their use. Values that do not require access to or active use of a biological resource by the valuer. Passive use value may imply that the resource is used by other humans whose welfare matters to the valuer. It therefore includes vicarious use value, bequest value and existence value.
non-equilibrium theory	suggests that the number of species increases or decreases depending on how the environment influences species production, exchange and extinction at any particular time.
non-exclusive goods	public goods to which it is impossible, or excessively costly, to operate any exclusion mechanism.
non-rival goods (in consumption)	public goods whose consumption by one individual does not preclude consumption by others.
normalizing selection	selection favouring individuals in the middle of the distribution of phenotypes in a population and disfavouring the extremes (also called: stabilizing selection).
nucleotide	unit building block of DNA. It consists of a sugar and phosphate backbone with a base attached.
null model	the model of no effect.
opportunity cost	the value of the best alternative use of a resource. This consists of the maximum value of other outputs we could and would have produced had we not used the resource to produce the item in question.
option value	the potential value of the resource for future (direct or indirect) use.
parapatric speciation	speciation in which the new species forms from a population contiguous with the ancestral species' geographic range.
parasite	an organism that consumes part of the tissues of its host, usually without killing the host.
parasitoid	kind of insect whose larvae develop within and kill their host.
parataxonomists	explicitly trained lay professionals who collect specimens and other information for Costa Rica's national Biodiversity Institute (INBio) from their biodiversity offices in or near the Conservation Areas.
patroendemics	restricted diploid species that have spawned younger, widespread polyploid species.
palaeoendemics	phylogenetically high-ranking taxa that might be regarded as evolutionary relicts; also ancient isolated taxa with high ploidy levels, whose diploid ancestors are extinct or unknown.
perfect complements	resources which are always used in fixed proportions to each other. Left shoes and right shoes are said to be perfect complements.
perfect substitutes	resources which are always used as replacements for each other.

Permian	last period of the Palaeozoic era, extending from 290 to 245 million years ago.
Phanerozoic	the major division of geological time during which most biodiversity has evolved and existed, 550 million years ago to the present.
phenotype	the observed traits of an organism, resulting from an interaction of its genotype and its environment.
phyletic evolution	genetic changes that occur within an evolutionary line.
phylogenetic	pertaining to the evolutionary history of a particular group of organisms.
phylum	the highest level of classification below the kingdom. For instance, Mollusca (slugs, snails, clams, etc.) constitute a phylum.
plant functional attributes	readily observable features of vegetation that are considered significant for growth, physiology and survival (for example pollination mechanisms, seed dispersal mechanisms, rooting systems).
plasmid	a genetic element that exists independently of the main DNA in the cell. In bacteria, plasmids appear as small loops of DNA, able to pass between cells independently.
Pleistocene	the span of geological time preceding the Recent epochs, during which the human species evolved. It began 2.5 million years ago and ceased with the end of the last Ice Age 10 000 years ago.
ploidy	number of chromosome sets contained by a cell: 1 = haploid, 2 = diploid and so on.
policy failure	occurs when government policies do not correct for market failures.
polyploid	organism containing two or more sets of genes or chromosomes.
population	a group of individuals with common ancestry that are much more likely to mate with one another than with individuals from another such group.
population viability analysis (PVA)	a comprehensive analysis of the many environmental and demographic factors that affect survival of a population, usually small.
potential evapotranspiration	measure of total heat flux.
precautionary principle (PP)	if the costs of current activities are uncertain, but are potentially both high and irreversible, the precautionary principle holds that society should take action before the uncertainty is resolved.
predator	an animal that kills and eats animals.
preferences	these are the orderings of different bundles of goods according to the wants of the consumer in question. Preferences may be influenced by ethical values, culture, age, gender and other political, social and demographic variables.
primary forest	relatively intact forest that has been essentially unmodified by human activity.
primary value	the value of the system characteristics upon which all ecosystem functions depend.

private opportunity cost	the opportunity cost faced by an individual agent of using a resource (not including any externalities).
private value	the value to the private agent of using or refraining from using a resource.
production function	this describes the outputs that may be obtained from combining different quantities of inputs.
prokaryote	cell without a distinct nucleus. Bacteria are prokaryotic.
proportional sampling	the alternative to saturation; when the local richness increases proportionately with the size of the regional species pool when the sample area is held constant.
protected area	a legally established land or water area under either public or private ownership that is regulated and managed to achieve specific conservation objectives.
public good	a good which, once provided to one user, must be provided in the same amount to all users due to its non-rival and non-excludable nature.
quasi-option value	the value of the future information made available through the preservation of a resource.
Quaternary period	the second and last period of the Cenozoic era extending from 2.5 million years ago to the present.
rational expectations	the hypothesis that decision-makers base their decisions on predictions which contain no systematic errors.
recalcitrant seed	seed that does not survive drying and freezing.
reciprocal externality	these are externalities where all parties using some resource impose external costs on all others.
resource	a substance or place required by an organism for its growth, maintenance and reproduction.
revealed preference approach	these approaches, which include derived demand approaches and indirect valuation methods, infer values from data on behavioural changes in actual markets related in some way to the missing market(s).
rights	entitlements assured by custom, law or property.
risk	the outcome of an action is said to involve risk where: the set of all possible outcomes of that action is known, and where the probability distribution of all possible outcomes is also known.
safe minimum standard	a restriction (taboo, prohibition, harvesting season) which limits the use of resources to levels that are thought to be safe, e.g. conservation of a sufficient area of habitat to ensure the continued provision of ecological functions and services, at the ecosystem level.
schizoendemism	vicariant species of equal ploidy level, resulting from either gradual or rapid divergence.

scramble competition	exploitation of a resource by one individual that reduces the availability of that resource to others. Usually also called 'indirect competition', because there is no direct interaction between competing individuals (see direct competition).
secondary forest	natural forest growth after some major disturbance (eg. logging, serious fire, or insect attack).
secondary value	the value of ecosystem functions.
seed bank	a facility designed for the <i>ex situ</i> conservation of individual plant samples through seed preservation and storage.
sibling species	species so similar to each other as to be difficult to distinguish by human observers.
silviculture	the science of cultivating forest crops (usually timber), based on a knowledge of forest tree characteristics.
social value	<i>see</i> Social Opportunity Cost.
social opportunity cost	the opportunities forgone by society, including externalities, in using a resource in some way. For biological resources this may be different than the market price of that resource.
speciation	separation of one population into two or more reproductively isolated, independent evolutionary units.
species diversity	the number and variety of species found in a given area in a region.
species richness	the number of species within a region. (A term commonly used as a measure of species diversity, but technically only one aspect of diversity.)
species selection	the differential multiplication and extinction of species as a result of differences in certain traits possessed by the organisms belonging to the various species, and causing a spread of the favouring traits through the fauna or flora as a whole.
stabilizing selection	selection favouring individuals in the middle of the distribution of phenotypes in a population and disfavouring the extremes. Also called normalizing selection.
stated preference methods	a survey instrument is designed in which a market-like situation is constructed. These include direct valuation approaches, like contingent valuation method.
stochastic	referring to patterns or processes resulting from random factors.
strong sustainable development principle	the opportunity set for future generations can only be assured if the level of biodiversity they inherit is no less than that available to present generations.
subsidies	government grants to suppliers of goods or services.
subspecies	groupings or populations within a species that are distinguishable by morphological characteristics or, sometimes, by physiological or behavioural traits.
surrogate markets	markets used in place of the missing markets for environmental resources. Surrogate markets are at least existing markets for resources with some of the properties of the non-marketed resource being valued.

sustainable development	development that meets the needs and aspirations of the current generation without compromising the ability to meet those of future generations.
sympatric	occurring in the same place.
sympatric speciation	speciation via populations with overlapping geographic ranges.
taxon (pl. taxa)	the named classification unit (e.g. <i>Mus musculus</i> , Muridae, or Mammalia) to which individuals, or set of species, are assigned. Higher taxa are those above the species level.
Tertiary period	the first period of the Cenozoic era, beginning 66 million years ago and closing with the start of the Pleistocene, 2.5 million years ago.
tetraploid	referring to a cell or organism containing four sets of chromosomes (<i>see</i> ploidy).
theory of local existence	suggests that the number of species increases or decreases depending on how the environment influences species production, exchange and extinction at any particular time.
threatened species	species that are, often genetically impoverished, of low fecundity, dependent on patchy or unpredictable resources, extremely variable in population density, persecuted or otherwise prone to extinction in human-dominated landscapes.
tissue culture	a technique in which portions of a plant or animal are grown on an artificial culture medium (also ' <i>in vitro</i> culture').
total economic value	the sum of use and non-use values with due consideration of any trade-offs or mutually exclusive uses or functions of the resource/habitat in question.
total environmental value	it is a function of primary value and total economic value.
tracheophyte	a plant with tracheae or vessels such as flowering plants and ferns.
translocation	switching of a segment of a chromosome to another chromosome.
triploid	referring to a cell or organism containing three sets of chromosomes (<i>see</i> ploidy).
trophic	pertaining to food or nutrition.
umbrella species	species whose occupancy area (plants) or home range (animals) are large enough and whose habitat requirements are wide enough that, if they are given a sufficiently large area for their protection, will bring other species under that protection.
uncertainty	the outcome of an action is said to involve uncertainty where the set of all possible outcomes of that action is unknown, and where the probability distribution of all possible outcomes is also unknown.
unidirectional externality	these are externalities in which the external costs or benefits of the resource use are 'one way.'
use value	values obtained through the use of a resource. This includes direct and indirect use values and instrumental values. Preservation in this sense is as much a use as development

utility function	a description of the way in which the well-being of individuals depends on different combinations of goods and services consumed.
valuation	this is a method for determining the importance of environmental consequences of economic activity that are not taken into account in market transactions.
variance	a statistical measure of the dispersion of a set of values about its mean.
variety	<i>see</i> cultivar.
vicariant patterns	when several taxa are subdivided by the same tectonically and climatically produced barriers to dispersal.
vicarious use value	altruistic value of benefits received by friends, relatives or others who are users of a resource. This is a passive use value.
voucher specimens	collections of organisms that are maintained to provide permanent, physical documentation of species identifications and associated data resulting from inventories.
weak complementarity	this describes a relation between a marketed/produced good and a non-marketed environmental good. If consumption expenditure is zero on the marketed/produced good, then the marginal utility of the public good is also zero.
welfare	an index of well-being.
wild relative	plant or animal species that are taxonomically related to crop or livestock species and serve as potential sources for genes in breeding of new varieties of those crops or livestock.
willingness to pay (WTP)	WTP is the amount an individual is willing to pay to acquire some good or service. This may be elicited from stated or revealed preference approaches.
willingness to accept (WTA)	WTA is the amount of compensation an individual is willing to take in exchange for giving up some good or service. This may be elicited from stated or revealed preference approaches.

Annex 7

List of acronyms

AABGA	American Association of Botanical Gardens and Arboreta, USA
ABTI	All Biota Taxonomic Inventory
AIDGAP	Aids to Identification in Difficult Groups of Animals and Plants
ANPC	Australian National Plant Conservation
ANWAR	Alaskan Natural and Wildlife Arctic
APC	Association for Progressive Communication
ASEAN	Association of Southeast Asia Nations
ATBI	All Taxon Biodiversity Inventory
AVHRR	Advanced High Resolution Radiometer
BCD	Biological and Conservation Data
BDB	Biodiversity Data Bank
BDT	Base de Dados Tropical
BENE	Biodiversity and Ecosystems Network
BGCI	Botanic Gardens Conservation International, UK
BGCS	Botanic Gardens Conservation Secretariat, UK (now BGCI)
BIMS	Biodiversity Information Management System
BIN	Biodiversity Information Network
BRAHMS	Botanical Research and Herbarium Management System
BRIM	Biosphere Reserve Integrated Monitoring network
BSBI	Botanical Society of the British Isles, UK
BSP	Biodiversity Support Programme
BTO	British Trust for Ornithology, UK
CARICOMP	the Caribbean Coastal Marine Productivity Programme
CBD	Convention on Biological Diversity
CCAMLR	Commission for the Conservation of Antarctic Marine Living Resources
CCVS	Conservation de Collections Végétales Spécialisés, France
CEC	Commission of the European Communities
CENARGEN	Centro Nacional de Pesquisa de Recursos Genéticos e Biotecnologia, Brazil (National Centre for Research in Genetic Resources)
CENPLANK	Centre for Plankton Collection, Sorting and Identification
CGIAR	Consultative Group on the International Agricultural Research
CIAT	Centro Internacional de Agricultura Tropical (International Centre for Tropical Agriculture)
CIFOR	Centre for International Forestry Research – CGIAR
CIMMYT	Centro Internacional de Mejoramiento de Maíz y Trigo (International

	Maize and Wheat Improvement Centre)
CIP	Centro Internacional de la Papa (International Potato Centre)
CITES	Convention on Trade in Endangered Species of Wild Fauna and Flora
CNPPA	Commission on National Parks and Protected Areas (IUCN)
COMAR	UNESCO's Coastal-Marine programme
CONABIO	Comisión Nacional para el Conocimiento y de la Bioversidad (the Mexican National Commission for the Knowledge and Use of Biodiversity)
CORINE	European Communities' Co-ordination of Information on the Environment programme
CPC	Centre for Plant Conservation, USA
CPGR	Commission on Plant Genetic Resources (FAO)
CYTED	Programma Ibero-americano de Ciencia y Tecnología para el Desarrollo
DBMS	Database management system
DDBJ	DNA Data Bank of Japan
DoE	Department of the Environment, UK
ECCO	European Culture Collection Organization
EEA	European Environment Agency
FACE	Forests Absorbing Carbon Dioxide Emissions
FAO	Food and Agriculture Organization of the United Nations, Italy
FFI	Forest Future Initiative
FGDC	Federal Geographic Data Committee
FIA	Forest Survey Inventory
FORIS	FAO Forest Resource Assessment database
FRA	Forest Resource Assessment, FAO, Italy
FROGGIE	Forest Reserves of Ghana: Geographic Information Exhibitor
FRRS	Forest Resources Reconnaissance Survey of the Forest Department of Peninsular Malaysia
FSC	Forest Stewardship Council
FWE	Freshwater Ecosystems
GATT	General Agreement on Trade and Tariffs
GBRMPA	Great Barrier Reef Marine Park Authority
GCOS	Global Climate Observing System
GEF	Global Environmental Facility
GEM	Global Environmental Markets
GEMS	Global Environment Monitoring System
GENIE	Global Environment Network for Information Exchange
GESAMP	UN Group of Experts on Scientific Aspects of Marine Pollution
GIMP	Global Inventorying and Monitoring Programme
GLIS	Global Land Information System
GLOBEC	Global Ocean Ecosystems Dynamics programme, USA
GOOS	Global Ocean Observing System
GOP	Geographical Observation Programme, Royal Geographical Society, UK
GPS	Global Positioning Systems
GRID	Global Resource Information Database
GTOS	Global Terrestrial Observing System
HEM	Harmonization of Environmental Measurement
HRV	High Resolution Visible
IABG	International Association of Botanical Gardens

IARC	International Agricultural Research Centre
IBP	International Biological Programme
ICARDA	International Centre for Agricultural Research in Dry Areas – CGIAR
ICBN	International Code of Botanical Nomenclature
ICBP	International Council for Bird Preservation (now Birdlife International)
ICDP	Integrated Conservation and Development Project
ICIPE	Insect Physiology and Ecology
ICLARM	International Centre for Living Aquatic Resources Management – CGIAR
ICNB	International Code of Nomenclature of Bacteria
ICNCP	International Code of Nomenclature of Cultivated Plants
ICRAF	International Centre for Agricultural Research in Agroforestry – CGIAR
ICRISAT	International Crops Research Institute for Semi-Arid Tropics – CGIAR
ICSU	International Council of Scientific Unions
ICTV	International Committee on the Taxonomy of Viruses
ICZN	International Code of Zoological Nomenclature
IGBP	International Geosphere Biosphere Programme
IGC	Institute for Global Communications
IGCMC	Indira Ghandi Conservation Monitoring Centre, Madras
IIASA	International Institute for Applied Systems Analysis
IITA	International Institute of Tropical Agriculture, Nigeria
ILCA	International Livestock Centre for Africa
ILDIS	International Legume Database and Information Service
INBio	Instituto Nacional de Biodiversidad, Costa Rica
INIBAP	International Network for the Improvement of Banana and Plantain – CGIAR
IOC	Intergovernmental Oceanographic Committee
IPCC	Intergovernmental Panel on Climate Change
IPM	Integrated Pest Management
IPGRI	International Plant Genetic Resources Institute – CGIAR
IPRs	Intellectual Property Regimes
IRRI	International Rice Research Institute – CGIAR
IRS	International Referral System
ISKO	International Society for Knowledge Organisation
ISIS	International Species Information Systems
ITE	Institute of Terrestrial Ecology, UK
IUBS	International Union of Biological Sciences
IUFRO	International Union of Forestry Research Organisations
IUMS	International Union of Microbiological Societies
IZY	International Zoo Yearbook
JICST	Japan Information Centre for Science and Technology
JNCC	Joint Nature Conservation Committee, UK
LANs	Local Area Networks
LCC	Land Capability Classification of Peninsular Malaysia
LME	Large Marine Ecosystems
LOOPS	Locally Organized and Operated partnerships
LTER	Long-term Ecological Research
MAB	UNESCO's Man and the Biosphere Programme
MARBID	Marine Biodiversity Database
MARS	Marine Research Stations network
MBALS	Minimum Biological Acceptable Levels
MIRCENs	Microbial Resource Centres
MIRENEM	Ministry of Natural Resources, Energy and Mines, Costa Rica

MOU	Memorandum of Understanding
MSDN	Microbial Strain Data Network
MSS	MultiSpectral Scanner
MVP	Minimum Viable Population
NAFTA	North American Free Trade Agreement
NASA	National Aeronautics and Space Administration, USA
NCCPG	National Council for the Conservation of Plants and Gardens, UK
NCSs	National Conservation Strategies
NEAPs	National Environment Action Plans
NEMPS	National Environment Management Plans
NFCs	National Focal Centres
NIR	Network Information Retrieval
NMFS	National Marine Fisheries Service, USA
NOAA	National Oceanic and Atmospheric Administration, USA
NPV	Net Present Values
NRC	National Research Council, USA
NRI	National Research Inventory
NSDI	National Spatial Data Infrastructure
NSF	National Science Foundation, USA
NVC	National Vegetation Classification, UK
OCR	Optical Character Recognition
OO-DBMS	Object-Oriented Database Management System
OPCA	Ornamental Plant Collection Association
PEET	US National Science Foundation's Partnerships for Enhancing Expertise in Taxonomy
PFA	Plant Functional Attributes
PGRC	Plant Genetic Resources Centre
PP	Precautionary Principle
PRA	Participatory Rural Appraisal
PROSEA	Plant Resources of South-East Asia project
PSDN	Packet Switched Data Network
PVA	Population Viability Analysis
RAP	Conservation International's Rapid Assessment Programme
RBA	Rapid Biodiversity Assessment
RDB	Red Data Book
RDBMS	Relational Database Management Systems
RDP	Ribosomal Database Project
RTU	Recognisable Taxonomic Units
SA2000	Systematics Agenda 2000
SADC	Southern African Development Community
SAR	Synthetic Aperture Radar
SBSTTA	Subsidiary Body on Science, Technology and Technological Advice
SCOPE	Scientific Committee on Problems of the Environment
SGML	Standard Generalised Marking Language
SIN	Special Interest Network
SMS	Safe Minimum Standards
SPDA	Peruvian Society of Environmental Law
SPOT	Système Probatoire d'Observation de la Terre
SQL	Structured Query Language

SSSI	Site of Special Scientific Interest
SSC	Species Survival Commission, IUCN
TCM	Travel Cost Model
TCP/IP	Transmission Control/ Internet Protocol
TDR	Transferable Development Right
TDWG	Taxonomic Databases Working Group
TEDs	Turtle Exclusion Devices
TFAP	Tropical Forest Action Plan
TM	Thematic Mapper
TNC	The Nature Conservancy
UN	United Nations
UNCED	United Nations Conference on Environment and Development
UNEP	United Nations Environmental Programme
UNESCO	United Nations Educational, Scientific and Cultural Organization
UNSTAT	United Nations Statistical Division
VES	Visual Encounter Surveys
VIDE	Virus Identification Data Exchange
VNTR	Variable number tandem repeat
WAIS	Wide Area Information Server
WARDA	West African Rice Development Association – CGIAR
WCMC	World Conservation Monitoring Centre, UK
WDMC	World Data Center on Microorganisms
WFCC	World Federation for Culture Collections
WIPO	World Intellectual Property Organization
WRI	World Resources Institute
WTA	Willingness to Accept
WTP	Willingness to Pay
WWF	World Wide Fund for Nature
WWW	World Wide Web

Index

for data in this volume refer to world; and also names of continents and major regions

Acacia senegal, case study, 867–868

accounting, GNP and GDP measures, 781

accounting systems, 780
see also valuation of biodiversity

accumulators, 488

acidification, 761, 762

acritarchs, 205

adh locus, *Drosophila*, and beta-haemoglobin locus, 213–214

aerial photography, 485

Africa

botanic gardens, 569–571

direct use values, tropical forests, 885

drylands, degradation, 755

ecotourism, some direct use values, 866

freshwater fish, 95

habitat loss, 751

human population, 1990–2100 forecast, 794

introduced species, threats to other species, 759

microbial genetic resource collections, 589

national parks, local economic incentives, 1028

phytochoria, 95
protected areas, 471
IUCN, 983

reference collections, 557, 561–563
zoological collections, 573–576
see also ecotourism

Agave arizonica, recurring hybrid, conservation, 59–60

aggregate species, 60

agriculture

atmosphere effects, 444–445

classification of systems, by diversity and complexity, 740

conservation measures for sustainable use of biodiversity, 943–952

Consultative Group on International Agricultural Research (CGIAR), 532, 566, 582, 651

genetic resources, list of holdings, 579
libraries, 565

decline of farmland birds, 740

dumping, and subsidies, 776

as ecosystems, 443–446

productive capacity, biomass, decomposition and nutrient cycling, 444

expansion, 739–746

genetic resources, 870
3 ways of preserving, 949
genetic diversity losses, 744–745

history, farming phase, 721–726

impact on biodiversity components, 443

impacts on natural resources, management, 950–952

information, CD-ROMs eg AGRISEARCH, 657

intensification, 728–829

International Agricultural Research centres (IARCs), 532

landrace diversity, 723–724

landscape structure, 445

microbial activities, 445

modern, management of biodiversity, 948–950

modern farming, 744–746

nurture of new varieties, 724

pesticides, categories, 741

productive capacity, 402–403
biotechnological generation, 707–708

and soil system, 406–408, 444

traditional practice, 740–744, 945–948

see also domesticated diversity

agrochemicals, 951–952

AIDGAP, identification resources, 568

air pollution, 761

Alaska

ANWAR, 67

kelp forests, sea otters, 373

algae

catalogues and indexes of names, 660

living species, 552

see also microorganisms

ALICE Biodiversity Database System, 636

All Taxa Biodiversity Inventory (ATBI), 493, 494

allopatric speciation, 221

allozyme electrophoresis, 65–67

alpha, beta and gamma diversity, 89

alpine and arctic systems,

335–339

altruism, 836

Alvarez, Cretaceous mass

extinction, 209–210

amateurs, 593–594

America *see* North America;

South America

amphibians

endangered and vulnerable,

numbers, 234

protected areas, 471

anagenesis, 226

Andean Pact initiative, South

America, 1045

angiosperms, appearance,

205–206

Animalia

species, 117, 118, 119, 120

low/high estimates, 118,

119, 120

animals

catalogues and indexes of

names, 660

living species, 552

direct use values

developed countries, 869

undeveloped countries, 866

domestication syndrome, 73

see also domesticated

diversity

endangered and vulnerable, numbers, 234

gene banks

ex situ accessions, 1003,

1005

ex situ technologies, list,

1004

genetic resource collections,

583–586

international trade, 777–778,

787–788

as kin, 838

latitudinal gradients of

richness, 258

livestock types, genetic

resource collections,

582–588, 590

migration, corridors, 306

populations, inventorying and

monitoring, 485–486

protected areas, 471

sustainable use, conservation

measures, 966–970

trade, 777–778, 787–788

zoological collections,

573–576

see also genetic resources;

reference collections

Annapurna Conservation Area,

Nepal, 1032–1033

Anolis, within-species and

between-species

diversity, genetic

techniques, 81–82

Antarctica, protected areas

(IUCN), 983

Antarctica Treaty, Madrid

Protocol (1991), 1050

apete, Brazil, 1018

aquaculture

China, 1018

escapes, 966

- aquaculture *continued*
 expansion, 748–749
 International Centre for Living Aquatic Resources Management (ICLARM), 651, 965
 management of biodiversity, 965–966
- aquaria *see* zoological collections
- Arabidopsis thaliana*, genome size and sequence knowledge, 683
- Aral Sea, effects of agricultural intensification, 745
- Arctic Ocean, biotic invasions, 212
- arctic tundra, plant functional groups, 294, 295–296
- arctic–alpine systems, 335–339
- arid and semi-arid lands, 349–354
 atmospheric properties, 351
 biotic linkages and species interactions, 351–352
 desert encroachment
 causal factors, 735
 extent, world, 754
 landscape structure, 423
 microbial activities, 352
 productive capacity, biomass, decomposition and nutrient cycling, 350
 soil structure, 350–351
 water distribution, 351
- Aristotle, 27
- arthropods
 Phanerozoic, 206–207
 species
 current numbers, 122
 low/high estimates, 118, 119, 120
- artificial selection
 outcrossing, 221
 transport causing gene flow, 221
- Ashgillian mass extinction, 208–210
- Asia
 botanic gardens, 569–571
 direct use values, tropical forests, 885
 drylands, degradation, 755
 habitat loss, 751
 human population, 1990–2100 forecast, 794
 introduced species, threats to other species, 759
 microbial genetic resource collections, 589
 protected areas, 471
 IUCN, 983
 reference collections, 555–556, 558–559
 tropical forests, hypothetical value, all mutually compatible use values, 886
 zoological collections, 573–576
- assemblages, defined, 92
- Atlantic Ocean, biotic invasions, 212
- atmosphere
 biodiversity influence on, 451
 biogenic emissions, 417–419
 changes in composition, 319
 and coastal systems, 375
 feedbacks, 417–422
 fluxes of atmospheric constituents, 419
 and lakes and rivers, 400
 and oceans, 396
see also specific ecosystems
- augmentation programmes, 1005–1006
- Australia
 botanic gardens, 569–571
 drylands, degradation, 755
 endangered habitats, existence valuations, 875
 Environmental Resources Information Network, 647
 extinctions, 232
 Great Barrier Reef
 management and protection, 1056
 use and socioeconomic benefits, 471
 habitat loss, 751
 introduced species, threats to other species, 759
 microbial genetic resource collections, 589
 property legislation, 1044
 protected areas (IUCN), 983
 reference collections, 557, 561
 South Australia, Native Vegetation Act (1991), 1043, 1046
 Victoria, Flora and Fauna Guarantee Act (1985), 1043–1044
 Wallace's Line, 95
 zoological collections, 573–576
- bacteria *see* micro-organisms;
 microbial activities *and*
 diversity
- Bangladesh, frogs, valuation study, 863
- barley, productivity contributions of wild sources, 871
- Batesian mimicry, 62
- bear, exploitation, 778
- beavers, 423
- beetles, critical tiger beetle faunas, 179
- Belize, marine parks, 1031
- benefits transfer, valuation of biodiversity, 857
- bequest motives, 837
- bequest value, stated preference methods, 845–848
- Bering Strait, migrations, 212
- Berne Convention, 1051
- BG–base, 636–637
- binomial system, 30–31
 stability, 33
- bioassay organisms, 490
- Bioclimate Prediction System (BIOCLIM), 631
- biodiversity
see also biodiversity
 management
 activities requiring installations and implements, 1058
 alpha, beta and gamma diversity, defined, 89
 analysis of dynamics, 259
 assessments
 international, 647–649
 resource base, 549–605
 and causality, 422
 centres of biodiversity, 142–145
 changes, drivers and dynamics, 311–316
 characterization, 8–10, 27
 and recognition, 25–105
 conclusions, 102–103
 summary, 25–26
 communities
 convergence, 158
 patterns and processes, 289–298
 components, effect of human activity, 431
 composition and levels, 10
 critical components, 291–292
 summary, 297–298
 defined, 5, 27
 distribution, 138–174
 summary, 111–112
 ecological perspective, 88–106
 ecological theories, 155–157
 and ecosystem functioning, 327–453, 833–834
 biome essays, 335–402
 cross–biome comparisons, 381–446
 summary, and conclusions, 333, 446–452
 and endemism, 112, 174–191
 environmental factors, 153–155
 functioning of ecosystems, 279–325
 generation
 coevolution role, 255
 parasitism, 256
 hierarchy, 431
 hotspots, 938, 939
 indicator species, 487–490
 influence
 on atmosphere, 451
 on landscape structure, 422–427
 on production, 448
 magnitude, 111–138
 monitoring, 784–786
 patterns, 153–164
 prospecting, 969–970
 for pharmaceuticals, 520–521, 866, 871
 'public good' nature of, 845
 recent initiatives
 international, 8
 national and regional, 9
 software, list, 637–638
 structural dynamics, latitudinal gradients of richness, 258
 sustainable use of biodiversity, social–economic strategies, 1017–1037
 and urbanization, 773–776
 history, 726–728
 use *see* valuation of biodiversity, use value
 value *see* valuation of biodiversity
 and yield, 446
see also ecological diversity;
 genetic diversity; human activity
- Biodiversity Action Plans, 927
- Biodiversity Data Bank (BDB), 637
- biodiversity information *see* information
- Biodiversity Information Management System (BIMS), 627
- biodiversity loss
 fundamental causes, 924
 value, 834
- biodiversity management
 adaptive management, 931
 approaches, 927
 building capacity for biodiversity management, 1053–1062
 defined, 5, 27
 human capacity, basic fields, 1054
 institutional capacity, 1055–1058
 integrated programme, 926–927
 methods and tools, 925–927
 regional ecosystems, 929–931
 restoration and rehabilitation approaches, 926
 strategic planning, 927–929
 steps, 928
 for sustainable biodiversity, 320
 funding capacity, 1058–1061
 human capacity, 1053–1055
 infrastructure capacity, 1058
 institutional capacity, 1055–1058
 minimal, moderate, intermediate, intensive, 999–1000
- biogeographic regions, 97–102
 floristic, 95
 zoogeographic, 95
- bioindicators *see* indicator species
- biological collections *see* reference collections
- Biological and Conservation Data System, 637
- biological interactions, 155
- biological resources *see* resource base
- biological species concept, 41–43
- biomass accumulation and disturbance, 405
 harvesting, effects, 738
 and productive capacity, 402–406

- proportional abundance, 290
- biomes
- cross-biome comparisons, 430–431
 - defined, 101
 - essays, 335–402
 - world, distribution, 98
- BioNET International, 520
- bioremediation, biotechnology applications, 694–698
- biosphere, fluxes of atmospheric constituents, 419
- Biosphere Reserve Integrated Monitoring Network (BRIM), 533, 534
- biosystematics, defined, 28
- biotechnology, 675–710
- applications, 679
 - biodiversity assessments and management, 680–681
 - conservation, example, 682
 - disease screening, 690
 - environmental remediation, 694–698
 - examples, 686, 687
 - manufacturing and processing industries, 688
 - rural industries, 688
 - utilization of biodiversity, 685–698
 - wide crosses, 689–690
- defined, 677
- ethics, 707
- future prospects, 800
- constraints, 800–801
- gene banks, *ex situ* technologies, 1003–1005
- genetic resources, value, 870–872
- impacts on biodiversity, 700–710
- genetically modified organisms (GMOs), 700
 - increase in value of genetic resources, 706–707
 - indirect impacts, 706
 - minimizing direct impacts, 705–706
- increased option values, 681–684
- molecular DNA data, 678–684
- positive/negative impacts, 678
- summary, 675
- biotic invasions, 211–212
- biotic linkages
- addition of species, 429–430
 - and ecosystem functioning, 427–433
 - effect of removal of species, 429
- biotopes, and endemism, 181
- BirdLife International, 651
- birds
- endangered and vulnerable numbers, 234
 - impact of urbanization, 757
 - populations, estimates, 757
 - protected areas, 471
 - territory mapping, 485
- Bonaire Marine Park, 1031
- boreal forests, 358–361
- biotic linkages and species interactions, 359–360
 - microbial activities, 360
 - productive capacity, biomass, decomposition and nutrient cycling, 358–359
 - soil structure, 359
 - see also* forestry; forests
- botanic gardens and arboretum collections, 568–573, 972, 1001, 1006
- Botanical Research and Herbarium Management System (BRAHMS), 627
- botanical world reference collections (tabulated), 555–557
- Brazil
- Atlantic forests, extinctions, 235
 - CENARGEN, 1000
 - habitat loss and fragmentation, 752–753
 - indirect value of bioresources, 880
 - Workshop 90, 649–651
 - see also* forestry; forests; South America; tropical forests
- breeds *see* domesticated diversity
- Brundtland Report, ethics and value, 836–837
- bryophytes, catalogues and indexes of names of living species, 552, 660
- BTEX compounds, environmental remediation, 696
- buffalo ranching, 866
- business accounting, 779–781
- butterflies
- critical swallowtail faunas, 179
 - extinction rates, 237–238, 239
 - genetic variability and adaptation, 62
 - longterm monitoring, 504–505
 - metapopulation persistence, 239
 - monitoring scheme, 486
 - protected areas, 471
- CAB International, 651
- CD-ROMs, 658, 659
- Caenorhabditis elegans*, genome size and sequence knowledge, 683
- Cambrian marine fauna, 203–204
- Cameroon
- ecotourism value, 866
 - indirect value of bioresources, 880
 - Korup Project, cost-benefit analysis, 881–882
- Campfire Programme, Zimbabwe, 969
- Canada, *see also* North America
- capture-recapture, 485
 - carbon, and global warming, 898
 - carbon credits, 898
 - carbon offsets, 897
- carbon sequestration, Malaysia, 900
- Caribbean
- marine parks, 1031
 - see also* Central America
- catalogues, 567–568
- and indexes of names, 552, 660–662
- causality, and biodiversity, 422
- CD-ROMs, and diskettes, 632, 654–659
- list, 656–659
- Cenozoic, late, biodiversity, 210–212
- CENPLANK, 523
- Central America
- botanic gardens, 569–571
 - direct use values, tropical forests, 885
 - ecotourism, some direct use values, 866
 - human population, 1990–2100 forecast, 794
 - microbial genetic resource collections, 589
 - Panamanian isthmus, biotic invasions, 211–212
 - protected areas (IUCN), 983
 - reference collections, 556, 560
 - zoological collections, 573–576
- centres of biodiversity, 142–145
- analysis criteria, 143
 - crops, 944
 - endemism, 144–145
 - taxa, 144
- cervids, Norway, 967
- Charting the Biosphere, Systematics Agenda 2000, 521–523, 541
- cheetah, loss of heterozygosity, 217
- chemical screening, 679
- chemotype, defined, 58
- Chile, Mediterranean-type ecosystems, 160
- China
- aquaculture, 1018
 - Loess Plateau, intensive management, 309
- chloroplast
- DNA elements, levels of genetic diversity, 65
 - gene *rbcL*, 681
 - RFLPs, 682
- chlororespiration, 697
- chordates, species, low/high estimates, 118, 119, 120
- Christianity, conversion and valuation of biodiversity, 839
- chromosome banding, 63
- cichlids, diversification, 231
- CITES
- Appendix I, 778, 968
 - Appendix II, 968
 - Conference, 233, 530–531
 - international wildlife trade, 778
 - see also* trade in wild animals and plants
- cities *see* urbanization
- cladogenesis, 226
- classification
- based on species composition, 96–100
 - communities, 94
- classification systems, 27–33, 95–101
- examples, 45
 - factual responses, 47
 - folk, origins of taxonomy, 29–30
 - global ecosystems, 100–102
 - species distribution, 97–100
 - layouts, 45
- climate
- Bioclimate Prediction System (BIOCLIM), 631
 - and ecosystems, 100–101
 - future trends, 795–798
 - and productivity, 153–154
- climate change, 319–321, 763
- and atmosphere changes, 319–320
 - biosphere/atmosphere interactions, 420
- CLIMEX, 486
- cline, defined, 58
- CNPPA (Commission on National Parks and Protected Areas), 939
- coastal systems, 370–381
- and atmosphere, 375
 - biotic linkages and species interactions, 376
 - defined, 370
 - human-induced impacts, 371–372
 - microbial activities, 376–377
 - productive capacity, biomass, decomposition and nutrient cycling, 372–373
 - protected areas, 553
 - sediment structure, 373–374
 - water quality, 374
 - eutrophication, 374–375
 - see also* coral reefs; mangrove systems
- CODA programme, WORLDMAP, 936
- CODATA, International Council of Scientific Unions (CODATA), 568, 651
- coevolution, role in biodiversity, 255
- coexistence
- theories, 157–159
 - regional enrichment vs community saturation, 158–159
- cohesion species concept, 42–43
- Colombia, Tukano people, 54
- communities
- change, species traits, 293–297
 - community processes, 291
 - convergence, 159
 - organization and competition, 245–248
 - integration of factors, 257–258

- communities *continued*
interdependence of species, 251–252
spatial and temporal variability of environment, 252–255
patterns and processes, 289–298
saturation, 158
vs regional enrichment, 158–159
synecological diversity, 92–93
community gene banks, 947
competition
apparent, 248
and community organization, 245–248
spatial and temporal variability of environment, 252–255
computers, 632–635
CONABIO, Mexico, 519
conservation
see also conservation measures
approaches, 16–18
improving the knowledge base, 17
comprehensive vs site planning, 1042
conservation areas *see* protected areas
defined, 15, 924
and endemism, 184–186
goals, 890–891
habitats vs ecosystems, 841–843
history of practices, 730–732
motives, 730–731
national and regional strategy, 901–902
of species vs of habitats, 839–841
valuation, 890–904
incentives
and appropriation of value
global problem, 898–904
local problems, 893–898
direct/indirect, 893
integrated conservation development projects (ICDPs), 892–893, 1025
lowering local opportunity costs, 895
raising local benefits, 895
structural adjustment programmes and policies, 894–895
see also conservation measures; genetic resources; protected areas
Conservation International, rapid assessment programmes (RAPs), 495
conservation measures
building capacity for biodiversity management, 1053–1062
defining priorities, 932–942
criteria, 933
ecosystem-based methods, 936–937
genetically-based methods, 933–934
geographically-based, 938–940
integrative approaches, 937–938
principles, 940
species-based methods, 934–935
and economic development, 1025–1026
integrated conservation development projects (ICDPs), 892–893, 1025, 1027
management framework, 923–932
policy decision-making, indicator species, 487–490
protection and restoration of ecosystems, 982–994
protection of species, populations and genetic resources, 994–1005
restoration and rehabilitation of species, populations, and ecosystems, 1005–1016
sustainable use, 943–981
agriculture, 943–952
fisheries, 960–966
forestry, 952–960
impact of tourism, 970–971
legislation, 1037–1053
social-economic strategies, 1017–1037
urbanization and infrastructure, 971–973
wild animals and plants, 966–970
see also all these subjects under their separate headings
summary, 919–922
conservation-focus species, 490
Consultative Group on International Agricultural Research (CGIAR), 533, 566, 582, 651
consumers
and green products, 900
see also human population; resource base
contractarian philosophy, 837
Convention on Biological Diversity, 7
characterization of biodiversity, 8–10
clearing house mechanisms, 653
conservation obligations and rights, 1050–1051
germplasm rights, 872
implementation and compliance, 1051–1052
number of contracting parties, 1050
objectives, 7, 1050
origins, 6, 7, 1050
preamble, 7
on sovereignty, 1049
sustainable use defined, 15
copyright, 665
coral reefs, 381–387
bioconstructional groups, 383
biotic linkages and species interactions, 384–385
crown-of-thorns starfish, 424
Great Barrier Reef, use and socioeconomic benefits, 471, 1056
habitat loss, 755–756
management implications, 385–386
microbial activities, 385
mutualism in corals, 436
productive capacity, biomass, decomposition and nutrient cycling, 382
sediment structure, 382
threats, 382
summary, 385
CORINE system, 525, 533
correlation analysis
factors influencing species diversity, West Indies, 161
number of species of mammals on islands, 161
corridors, fragmentation factors in animal migration, 306, 990, 992–993
cost-benefit analysis
Korup Project, Cameroon, 881–882
Philippines, logging vs fishing and tourism, 882–883
valuation of biodiversity, 862
Costa Rica
ecotourism, 876–877
InBio, 518, 520
and Merck, prospecting for pharmaceuticals, 520–521, 866, 871, 969
institutional management, 1057
national park, indigenous population as agents of change, 1021
regional ecosystems, management, 930
tropical dry forest, restoration programme, 1009
cotton, effects of agricultural intensification
Aral Sea, 745
Country Studies, UNEP programme, 648–650
Countryside Information System, 637
covenants, 1045
crabs, mangrove systems, 390
Cretaceous mass extinction, 209–210
crocodiles, ranching, 968
crops *see* domesticated diversity
crops, genetic sources of food
crops, 870, 871
cross-biome comparisons, 430–431
crows, parapatric speciation, 230
cryopreservation, 1004–1005
cultivars
defined, 74
genetic basis, 75–76
cultural diversity, 13
cultural values, nature and ethics, 764–767
cytotype, defined, 58
dams and reservoirs, 754–755
Darwin
on multiplication of species, 231
natural selection, 27, 217–221
data
(*this volume*) *see* world; *also* names of continents and major regions
see also information
data collection, *see also* information
data exchange standards, 639, 640
data sources *see* directories; libraries; reference collections
databases
database projects, 627
freedom of information, 665
management systems, selection, 635–636
metadatabases, 653, 655
sequence databanks, 591–593
decomposition, 303
deer, management in Norway, 967
deforestation *see* forestry;
forests; tropical forests
degraded ecosystems,
rehabilitation,
monitoring, 785
DELTA, 640
demographic stochasticity, single population extinctions, 236–237
Denmark, habitat, legal protection, 1043
descriptions, circumscriptions and maps, 48
desert encroachment *see* arid lands
detectors, 488
Diderot, 27
digital cameras, remote sensing, 499
directories, 567
data sources, 662
list, 659
directory exchange standards, 639
disease control, genetic engineering, 692–693
disease screening, applications of biotechnology, 690
dispersal, passive/active, 161–162
distribution of biodiversity, 138–174

- disturbance
 characterization, 311–316
 disturbance regime, 296–297
 defined, 312
 intermediate disturbance
 hypothesis, 313
 levels, 312
 and management, 315–316
 mapping units, 750–751
 and other ecological processes,
 312–313
 principles, 313–315
 spatial and temporal variability
 of environment, 252–255
 thresholds in ecosystems, 314
- diversification of species *see*
 speciation
- DIVERSITAS programme, 201,
 519, 535
- DIVERSITY programme,
 WORLDMAP, 936
- DNA, *see also* mitochondrial
 DNA
- DNA conservation, for genetic
 resource collections,
 1005, 1006–1007
- DNA data in biotechnology,
 678–684
 chemical screening, 679
 gene transfer, genetically
 modified organisms
 (GMOs), 703–704
 genome mapping, 679–680
- DNA databases, 592
- DNA elements
 levels of genetic diversity, 65
 nucleotide sequences, 69
- DNA fingerprinting, multi-locus,
 minisatellite loci, 68
- DNA libraries
 role in conservation, 684
 and sequence knowledge,
 683–684
- DNA markers, bulk segregant
 analysis, 687
- DNA probes
 PCR, random primers, 69
 restriction fragment length
 polymorphisms, 67–68
- DNA/DNA hybridization,
 nucleotide divergence,
 256
- domain, categories recognized,
 29
- domesticated diversity, 70–77,
 126–135, 145
 aquatic organisms, 129–131
 birds, 129, 134
 breed
 breeds at risk, 746
 defined, 75
 characterization and
 recognition of
 biodiversity, 73–75
 cultivars, defined, 74
 differentiation patterns, 70–77
 direct use value, 840
 domestication syndrome
 animals, 73
 plants, 71
 F1 hybrids, 76
- gene banks, *ex situ* accessions
 and technologies, 1003
- genetic basis of cultivars and
 breeds, 75–76
- genetic diversity, world
 centres for major crops,
 944
- genetic engineering, 693–694
- genetic inventoring and
 monitoring, 465
- genetic resources
 International Undertaking
 on Plant Genetic
 Resources, 945
 profiles, 77
- history, 721–723
- invertebrates, 131–133
- mammals, 129, 134
 breeds, numbers, 134
 exploited captives, 72–73
- microbes, 131
- origins of domesticated plants
 and animals, 725
- plant crops, 127, 128–129
 at risk, 132
 domestication syndrome, 71
 F1 hybrids, 76
 genetic resource profiles, 77
 germplasm collections,
 24–25, 130–131
 improving production with
 biotechnology, 686–694
 productivity contributions of
 wild sources, 870, 871
 staple, number, 948
 Vavilov's world centres of
 origin, 72
 world centres of genetic
 diversity, 944
 yield and biodiversity, 347
- risk of loss of diversity,
 133–135
- sources, areas, 126–128
- species complex and gene
 flow, 76–77
see also agriculture
- Drosophila*
adh locus, and
 beta-haemoglobin locus,
 213–214
 chromosomal inversions, 226
 genetic factors in extinctions,
 237–238
 genome size and sequence
 knowledge, 683
- dynamics of biodiversity,
 245–258
 analysis of dynamics, 259
 competition and community
 organization, 245–248
 predation and mutualism
 maintaining, 248–251
 summary, 198–199
- Dzhulfian mass extinction,
 208–210
- easements, 1046
- ecological diversity
 alpha, beta, and gamma
 diversity, defined, 89
 autecological diversity, 91–92
- between areas, 94–106
 classification based on
 species composition,
 96–100
 classification of
 communities, 94
 defined, 6
 functional diversity, 92–93
 synecological diversity, 93
 taxic diversity, 90
 within areas, 88–93
 areas of different sizes,
 89–90
 species richness and species
 diversity, 88–89
see also biodiversity
- ecological goods and services,
 446–447, 450–451
- ecological perspective of
 biodiversity, 88–126
- ecological resilience, 841–842
- ecological species concept, 43
- ecological system
 defined, 281
 services concept, 282–285
- ecologists
 plant
 amateurs, 594
 professionals, distribution,
 1056
- ecology of extinctions, summary,
 198
- ECONET, 633
- economic development, and
 conservation measures,
 1025–1026
- economic growth, conventional
 measurement, 894
- economic policies
 failure to value environmental
 resource base, 778–781
 financing, 667
 future prospects, 801–802
 tools and incentives,
 1026–1034
see also social-economic
 strategies; sustainable
 policies
- economic valuation of
 biodiversity *see* valuation
 of biodiversity
- ecoregions, world, 99
- ecosystem-based methods in
 setting priorities for
 conservation measures,
 936–937
- ecosystems
 classification and comparison,
 101–102
 global classification,
 95–101
 defined, 92, 281
 diversity, 114
 global and local levels,
 114–115
 ecosystem processes, 291
 alteration of species
 numbers, 292
 effects of diversity, 293–297
 functioning, 87–88, 279–325,
 833–834
- addition of species, 429–430
 and biotic linkages,
 427–433
 and genetic diversity,
 285–287
 conclusions, 323–325
 human influences, 324–325
 and landscape, 324
 maintenance, 993–994
 removal of species, 429
 spatial structure, 301–303
 summary and conclusions,
 279, 446–452
- future trends, 794–795
- health, 842
- integrity, 842
- inventoring and monitoring,
 468–469
- longterm monitoring, US
 LTERs, 503–505
- management, 789
- patterns and processes,
 289–298
- process rate and biodiversity,
 315
- protection and restoration of
 ecosystems, 982–994
- restoration and rehabilitation
 of degraded ecosystems,
 926, 1005–1016
 monitoring, 785
- services concept, 282–285
- structural resilience, 842
- thresholds, 314
- ecotourism
 analysis of policies,
 1029–1034
 community-based, 1031–1032
 economics, 1030–1031
 growth, 970
 internalising benefits, 896
 numbers, 876
 recreation values, 868–869
 values, 866
 payment vehicle, 872–874
 World Bank valuation, 876
- ecotype, defined, 58
- Ecuador
 biodiversity management,
 1018
 community-based ecotourism,
 1031–1032
- Ediacarian animals, extinctions,
 205
- El Niño 1982–3 event,
 Galapagos, 797
- electro-optical systems, 497
- electronic media, 566
- electronic publishing *see*
 networks
- elephants
 ecotourism values, 866
 contingent valuation
 surveys, 876
 payment vehicle, 872–874
 travel cost technique, 874
 ivory trade, 866
- endangered habitats, existence
 valuations, 875
- endangered species, 465, 875
 animals, 234

- endangered species *continued*
 classifications, 995–997
 existence valuations, 875
 forests, 955
 genetic bottlenecks, 465
 IUCN *Red Lists* and *Red Data Books*, 234–236, 491–492, 531–532
 IUCN Species Survival Commission and Action Plans, 531, 998–999
 management plans, 997
 recovery plans, 997–998
 endemism, 112, 174–191
 and area, 180
 biases, 175
 centres of biodiversity, 144–145
 centres of endemism, 177
 classification, 174–175
 concepts and perspectives, 174–176
 congruence, 178–179
 conservation
 applications, 184–186
 special considerations, 183–185
 correlates and causes, 179–183
 modelling, 183
 reproduction, 182
 taxonomy, 183
 environmental factors, 180–181
 evaluation, 175–177
 genetic variation, 183
 measurement, units of
 measurement, 176–178
 nomogram, 176
 patterns, 177–179
 phylogenetics, 175
 and reserve selection, 183
 and species richness, 180
 taxonomic correlates, 183
 energy, high-energy phase of
 history, 728–730
 environmental accounting, 778–781
 see also valuation of biodiversity
 Environmental Assessment and Reporting Support System (EARSS), 638
 Environmental Commodities Spectrum and Valuation Problem, 845
 environmental contaminants, 760–763
 BTEX compounds, 696
 list, 696
 remediation, 694–698
 environmental degradation
 remediation, biotechnology applications, 694–698
 see also human activity
 environmental factors *see* biological interactions;
 climate; stress
 environmental impact
 assessments
 equation, 783
 legal tools, 1047
 in tourism development, 971
 Environmental Information System (ENVIS), 627
 environmental measures, future prospects, 801–802
 environmental policies *see* conservation measures
 environmental reports, list, world, 650
 Environmental Resources Information Network, Australia, 647
 environmental stochasticity, 237
 environmental thesauri, 629–630
 Environmental Valuation Reference Inventory, 857
 equilibrium
 non-equilibrium coexistence, 313
 punctuated equilibrium, vs phyletic gradualism, 228
 spatial and temporal variability of environment, 252–255
 theories, vs non-equilibrium explanations, 156–157
 equilibrium resilience, 842
 ERMS programme, WORLDMAP, 936
 erosion, mechanisms, 724
Escherichia coli
 Genetic Stock Centre, 590
 genome size and sequence knowledge, 683
 ethics
 bequest motives, 837
 biotechnology, 707
 and care of nature, 839
 cultural values and biodiversity, 763–764
 and equity, 836–837
 Lockean standard, 837
 valuation of biodiversity, 829–830
 Ethiopia
 community gene banks, 947
 in situ conservation, 1000
 Eukarya
 major taxa, 30
 species, 117, 118, 119, 120
 low/high estimates, 118, 119, 120
 Eurasia, Tertiary, 162
 Europe
 biotopes, 99
 botanic gardens, 569–571
 drylands, degradation, 755
 habitat loss, 751
 human population, 1990–2100
 forecast, 794
 microbial genetic resource collections, 589
 protected areas (IUCN), 983
 reference collections, 556, 559
 zoological collections, 573–576
 European Environment Agency, 655
 European Environmental Agency (EEA), 651
 eutrophication, 761, 762
 water quality in coastal systems, 374–375
 evapotranspiration, 153, 413–414
 Eve hypothesis, 50–51
 evolution, *see also* natural selection
 evolutionary biology, 11
 analysis of systematic data, 36–38
 coevolution, role in biodiversity, 255
 Darwin's observations, 36–38
 genetic evolution process, 215–221, 227
 species concepts, 40–48
 evolutionary species concept, 44
 existence valuations, 875–876, 888
 defined, 888
 evidence, Mexico, 887
 negative, 876
 exotic invasives, 486, 700–708, 757–760
 see also invasions
 Expert Center for Taxonomic Identification, 637
 exploiters, 488
 extinctions
 acritarchs, 205
 Atlantic forests, Brazil, 235
 background extinction, 155, 208
 catastrophic events, 155
 causes, 240–242
 criteria, 996
 differential, 163
 ecology of extinctions
 current rate, 232, 234–236
 lifespan of species, 232
 status of vulnerable species, 234–236
 summary, 198
 genetic factors in, 237–238
 human-induced, 242
 and invasions, ecosystem level
 feedbacks to biodiversity, 297
 mass extinction, 208–210
 recoveries, 210
 mechanisms, 236–240
 metapopulations, 238–240
 past extinctions, 232–233
 Dzhulfian mass extinction, 208–210
 Famennian mass extinction, 208–210
 recorded since 1600, 233
 population viability analysis, 244
 populations, 238–240
 prediction, 242–245
 metapopulations, 243–244
 single populations, 242–243
 prediction of rates, 242–245
 rain-forests, 235
 recent extinctions, 233–234
 single populations, 236–238
 demographic stochasticity, 236–237
 low density and allele effects, 236
 species-area estimates, 235
 threatened, vulnerable and rare species, 234
 summary, 244
 family, role of women in
 biodiversity-related issues, 770, 831–832
 farming *see* agriculture;
 domesticated diversity
 fertilizers, 761
 indicators of growth in global consumption 1950–1991, 772
 financial capacity, 667, 1058–1061
 fire, 754, 994
 used by indigenous people, 1018
 FishBase database project, 627
 fisheries
 common property concept, 791
 exploitation, 738–739, 746–749, 960
 ghost, catching of birds and mammals, 748
 management, 790
 management of biodiversity
 large-scale fisheries, 963–964
 newly evolving practices, 964–965
 small-scale fisheries, 962–963
 maximum sustainable yield concept (MSY), 963–964
 sustainable use, conservation measures, 960–966
 fishes
 endangered and vulnerable, numbers, 234
 exploitation, 738–739
 indicators of growth in global consumption 1950–1991, 772
 in protected areas, 471
 flagship areas/countries, 178, 179
 flagship species, 491
 floras
 characterization and preparation of Floras and keys, 33–34
 examples of keys to identification, 45, 48
 numbers of species, 35
 rates of production, by regions, 35
 folk classification, 5, 29–30
 food chains and webs, 92, 252
 elimination of species, 253
 forest(s)
 conversion, 893–894
 deforestation
 causes, immediate and underlying, 735
 extent 1980–90, 749
 tropical forests, 309, 749, 753
 endangered species, 955
 environmental performance bonds, 896–897
 inventorying and monitoring, 526, 958–960

- inventories, 496
- lowering protection costs, 895
- management
 - effect of harvesting, 737–738
 - genetic conservation, 954–956
 - by indigenous communities, 1023–1024
- non-timber products, 1028–1029, 1030
- old growth forest, proportions remaining, 750
- reforestation incentives, 896
- use value, 880–885
- valuation, productivity change method, 856
- water fees as conservation incentives, 896
- see also* boreal forests; deforestation; temperate forests; tropical forests
- Forest Resources Assessment, UNFAO, 523–524
- Forest Stewardship Council, principles for sustainable management, 959
- forestry
 - agroforestry, 952
 - biodiversity inventorying, 958–960
 - expansion, 749–750
 - extent, 749
 - logging, 749–750
 - tree mortality, 748
 - management
 - biodiversity management, 952–960
 - and genetic conservation, 954–956
 - minimization of impact on biodiversity, 956–958
 - principles for sustainable management, 959
 - traditional/natural, 952–954
 - and non-forestry policies, 893–894
 - property rights, 767
 - recreational value vs economic use, 868–869
 - forests, inventorying and monitoring, 526, 958–960
 - fossil record *see* history of biodiversity
 - fragmentation
 - factors in animal migration, 306, 990, 992–993, 994
 - management and protection, 992–993
 - Frasnian mass extinction, 208–210
 - free-rider problem, 858
 - freshwater systems
 - Aquatic Science and Fisheries Abstracts AGRISEARCH (CD-ROM), 657
 - future, 795
 - International Centre for Living Aquatic Resources Management (ICLARM), 651
 - monitoring, 501–503
 - sewage pollution, 774
 - stream organisms, canonical distribution, 503
 - weeds, 759
 - frogs, Bangladesh case study, 863
 - fruit fly, sympatric speciation, 230
 - functional compensation hypothesis, 289
 - functional groups, 291
 - funding capacity, management for sustainable biodiversity, 1058–1061
 - fungi
 - catalogues and indexes of names, 660
 - catalogues and indexes of names of living species, 552
 - genetic resource collections, 588–589, 591–592
 - species, 122
 - low/high estimates, 118, 119, 120
 - future trends in human population, 792–794
 - Galapagos, El Niño 1982–3 event, 797
 - gas (fuel), indicators of growth in global consumption 1950–1991, 772
 - GBA *see* Assessment
 - gene banks *see* genetic resource collections
 - generation of biodiversity, summary, 197–199
 - genetic diversity
 - allozyme electrophoresis, 65–67
 - allozyme variability, 125
 - case studies, within- and between-species, 79–81
 - as component of biodiversity, 57–87
 - definitions, 57
 - hybridization, 58–59
 - karyotypic variability, 63–64
 - levels of genetic distinction, 64
 - molecular assessment, 64–70
 - conservation *see* conservation measures
 - defined, 6
 - DNA elements, 65
 - domestication, 126–135
 - and ecosystem functioning, 285–287
 - conclusions, 323–325
 - gene functional diversity, 226
 - genetic bottlenecks, 465
 - genetic evolution process, 215–221
 - genomic variation, 215
 - heterozygosity, 125, 213–214, 286
 - investigation, 77–81
 - levels, 124
 - losses via modern agriculture, 34–36
 - maintenance of genetic diversity, 221–225
 - inbreeding depression and heterosis, 223–224
 - mutation and selection, 222–223
 - measurement, 213
 - single loci, 213–214
 - molecular methods for assessing, 65–70
 - multiple loci, 215
 - multiple populations, 214
 - Wright's F_{ST} , 214
 - plants, and animals, 125–126
 - polymorphism, 213–214
 - quantitative characters, 215
 - within-species and between-species diversity, *Partula* and *Anolis* case studies, 79–82
 - summary, 197
 - see also* taxonomy
 - genetic drift
 - founder events, 227
 - loss of heterozygosity, 216–217
 - mechanism, 61
 - genetic engineering, 690–694
 - disease control, 692–693
 - gene cloning, polymerase chain reaction, 68–69
 - gene transfer, genetically modified organisms (GMOs), 703–704
 - key technologies, list, 691
 - novel products, 693
 - genetic evolution, 215–221
 - genetic drift, 216–217, 227
 - mutation, 216
 - selection, 217–221
 - genetic markers, 465
 - chloroplast RFLPs, 682
 - DNA markers bulk segregant analysis, 687
 - RAPDs, 682
 - for rapid selection, 689
 - genetic resource collections, 578–592, 949, 1000–1005
 - examples of specimens, 554
 - gene banks, 921, 947
 - community gene banks, 947
 - ex situ* accessions, 1003, 1005
 - advantages/disadvantage, 1006
 - ex situ* technologies, 1003–1005
 - and new resources for domestication, 1002–1003
 - pollen banks, 1006
 - management, 578
 - molecular sequence databases, 592
 - option values, 681–684
 - other types, 578
 - botanic gardens and arboretum collections, 568–573, 972, 1001
 - fungi, 588–589, 591–592
 - livestock, 588, 591
 - microbes, 589–590, 591–592
 - plant resources, 578–582, 590, 999–1005
 - zoological collections, 548–563, 576–577, 1001–1002
 - genetic resources
 - access, regulation, 1044–1045
 - agriculture, preservation, 949
 - defined, 16
 - erosion of, 745, 949–950
 - gene pools, genetic resource profiles of crop species, 77
 - germplasm collections, plant crops, 130–131
 - germplasm rights, Convention on Biological Diversity, 872
 - increase in value, biotechnology, 706–707
 - inventorying and monitoring, 463–466, 482
 - endangered species, 465
 - in situ* and *ex situ* conservation, 999–1005
 - value, 869–872
 - see also* genetic resource collections
 - genetic surveys, 464
 - genetic techniques
 - between-species diversity, 80–81
 - genome mapping, 679–680
 - genome size, and sequence knowledge, examples, 683
 - sequence databanks, 592–593
 - within-species diversity
 - Anolis*, 80–81
 - Partula*, 79–80
 - genetically modified organisms (GMOs), 700–708
 - gene transfer, to non-target populations, 703–704
 - micro-organisms (GMMs), 700–708
 - minimizing direct impacts, 705–706
 - risk assessment, 704
 - genetics, *see also* biotechnology, applications
 - genotype, defined, 60
 - Gentianella*, hybridization, 59
 - genus, defined, 28
 - geographic information systems (GIS), 626–627, 637
 - geographical barriers, peripheral isolates, 229
 - geographical patterns of biodiversity, 139–154
 - congruence and independence of histories, 163
 - germplasm *see* genetic resource collections; genetic resources

- Ghana
 biodiversity conservation, 973
 Forest Reserves of Ghana:
 Geographic Information
 Exhibitor (FROGGIE), 638
- Global Biodiversity Assessment
(this document)
 coverage, 10–18
 biological aspects, 10–12
 human society, 12–14
 strategies for conservation
 and use, 15–18
 linkages with Convention on
 Biological Diversity, 7
 objectives, 7
- Global Biodiversity Strategy, 8,
 924, 982
see also protected areas
- Global Climate Observing
 System (GCOS),
 530–531
- Global Environment Monitoring
 System (GEMS), 652
- Global Environmental Network
 Information System
 (GENIE), 655
- Global Inventorying and
 Monitoring Programme
 (GIMP), 533–534
- Global Land Information System
 (GLIS), 655
- Global Ocean Ecosystem
 dynamics (GLOBEC),
 528
- Global Ocean Observing System
 (GOOS), 529
- Global Positioning Systems
 (GPS), 629
- Global Resource Information
 database (GRID), 653
- Global Terrestrial Observing
 System (GTOS), 528–529
- global, *see also* world
- GOPHER, and Veronica, 27
- gradients in biodiversity,
 139–142
- grain, indicators of growth in
 global consumption
 1950–1991, 772
- grapes, productivity
 contributions of wild
 sources, 871
- grasslands
 conversions, 753–754
 grazing, 432, 834
 value of loss of biodiversity,
 834
see also Mediterranean-type
 ecosystems; temperate
 grasslands; tropical
 savannah
- Great Britain *see* United
 Kingdom
- 'green' products, 900
- Green Revolution, and
 biodiversity losses, 745
- greenhouse effect, 796–798
- Grenada dove, 973
- Guadaloupien mass extinction,
 208–210
- Gulf of Guinea LME, 529
- gum arabic, case study, 867–868
- gymnosperms
 origins, 205–206
 taxonomy, 49–50
- habitat loss and fragmentation,
 241, 750–757
 by continents, 751
 conversions, 753
 by countries, tropics, 751, 752
 disturbance, legislation, 1041
 extinctions, 240–241
 and human population,
 771–772
 recovery, 235
see also disturbance
- habitat quality
 changes in, 241–242
 diversity, 114–115
 legal protection, 1043
 variation in space and time,
 403–404
- habitats, valuation of
 biodiversity, 865–878
- β -haemoglobin locus, *adh* locus,
Drosophila, 213–214
- Hardy–Weinberg formula, 214
- hedonic travel cost model (HTC),
 valuation of biodiversity,
 850
- herbivory, 302
- heritability, breeder's equation,
 220
- history of biodiversity, 162–164
 extinctions, 208–210
 recoveries, 210
 fossil record, 202–212
 mammalian taxa, Eurasia
 and Africa, 164
 tree flora, Eurasia, 163
 use of taxa for estimates,
 202–203
 land plants, 205–207
 oceans, 203–205
 pre-animal, 205
 tetrapod vertebrates, 207–208
 summary, 197
- history of human impact on
 biodiversity *see* human
 activity
- Holdridge's life zone
 classification, 98, 101
- hops, productivity contributions
 of wild sources, 871
- human activity
 adaptation, holistic approach,
 937–938
 driving forces, equation, 783
 future prospects, 792–802
 adaptations, 799–800
 harmful (to humans) practices,
 765
 impacts on biodiversity,
 715–783
 before 1500 to since 1800,
 719
 biodiversity components,
 431
 conservation traditions,
 730–733
 disruption, and health, 450
- farming phase, 721–726
 forces driving, 763–783
 history, 718–733
 mechanisms, 736–740
 modern high-energy phase,
 728–730
 phase, 718–721
 urban phase, 726–728
 summary, 715–716
- indigenous communities, 595
 agents of change
 examples, 1020
 list, 1021
 agriculture, traditional,
 740–744, 945–948
 forest management,
 1023–1024
 knowledge and innovations,
 786, 1018–1019
 participation in rural
 management, 1019–1026
 approaches, 1020
 institution building, 1020
 projects, 595, 1019–1020
 participatory inquiry,
 1020–1023
 protected areas, 595,
 1024–1026
see also social-economic
 strategies
- migrations, 727
- perturbations of biodiversity,
 319–321
 atmosphere, changes in
 composition, 319
 extinctions, 242
 summary and conclusions,
 323–325
- sustainable policies,
 information requirements,
 783–792
- urbanization, 726–728,
 773–776, 774, 971–973
- human population
 consumption of resources,
 771–772
 fertility rates, 771
 forecast, 12 world regions, 794
 future trends, 792–794
 growth, 771–773
 and habitat loss, 771–772
- human resources in conservation
 basic fields, 1054
 deployment, 51
 developing capacity, 1055
 financing, 667
 inventorying and monitoring,
 local people and
 volunteers, 540–541
 management for sustainable
 biodiversity, 1053–1055
 organization, 593–598
 productivity and working
 practices, 596–598
 services to humans concept of
 ecosystems, 282–285,
 446–447, 450–451, 492
 training, 667
- human society
 differences in perception of
 biodiversity value,
 837–839
 fossil record, 719–720
 humans, *see also* man
 hunter-gatherers
 in history, 718–721
 present-day, 737
 hybridization, 58–60
 negative implications, 59
 recurring hybrids, 59–60
 hydroelectricity, watershed
 protection charge, 896
- ibex, outbreeding depression,
 224
- identification aids, 46–47
- identification keys, 49
- identification resources, 568
- iguana, *Sphenodon*, 465
- iguanaid lizards
 ranching, 968
 within-species and
 between-species
 diversity, 80–81
- InBIO *see* Costa Rica
- inbreeding depression, and
 heterosis, 223
- Index Kewensis
 CD-ROMs, 659
 Kew Index, 552, 659, 660
- India
 community forest
 management, 1023–1024
 conservation, legislation,
 1048, 1049
 customary and traditional legal
 measures, 1039
 joint forest management, 954
 New Delhi, Ridge Forest,
 972–973
in situ conservation, 1000
 indicator species, 487–490
- Indira Gandhi Conservation
 Monitoring Centre, 646
- Indonesia
 aquaculture, 1018
 customary and traditional legal
 measures, 1039
 fisheries management,
 960–961, 962
 indirect value of bioresources,
 880
 rattan, case study, 1030
- information
 catalogues and indexes of
 names, 660–662
 CD-ROM and diskettes,
 632–633, 634–635,
 656–663
 data collection, 617–624
 computerization, 628–629,
 633–634
 custodianship, 622–624
 data exchange standards,
 639, 640
 data formats, 620–621
 data management tools,
 625–630
 database management
 systems, 624–625, 636
 database projects, 627
 distributed database

- management systems (DDBMS), 625
- environmental thesauri, 629–630
- identification of data requirements, 619–620
- management and integration of text, 627–628
- management strategies, 621–622
- relational database management systems (RDBMS), 624–625
- reporting, analysis and modelling tools, 630–631
- standards and guidelines, 624
- types of data, 617–619
- directories
- directory exchange standards, 639
 - list, 660
- dissemination, 641–643
- distribution channels, 643
 - electronic media, 642
 - microfilm, 642–643
 - networks, 642
 - printed media, 641–642
- ecosystem functions, valuation of biodiversity, 879
- flow, 615, 616
- freedom of information, 665
- geographic information systems (GIS), 626–627, 636–637
- institutional capacity
- development, 665–668
- intellectual property rights, 664–665
- international information centres, list, 651
- management
- criteria for success, 615–617
 - legal aspects, 661–666
- networks, 631–633
- presentation, 639–642
- process, 625
- public/private interests, 614–615
- requirements for sustainable policies, 783–792
- resources, 565–568
- financing, 668–669
 - human resources and training, 668
 - institutional capacity development, 666–669
- software list, 636–639
- sources, 644–662
- libraries, and bibliographies, 644–647
- tools and technologies, 624–638
- dissemination tools, 634
 - harmonization tools, 628–629
 - software and hardware tools, 635–639
- user interface standards, 639
- users, 613–617
- summary, 5–6
- INFOTERRA, UNEP International Environment Information System, 652
- infrastructure capacity, management for sustainable biodiversity, 1058
- insecticides, 741, 760–763, 951
- insects
- and frog control in Bangladesh, 863
 - Phanerozoic, 206
- institutional capacity
- development, 665–668
 - inventorying and monitoring, 539–540
 - management for sustainable biodiversity, 1055–1058
- integrated approaches to inventorying and monitoring, 520–523
- integrated conservation development projects (ICDPs), 892–893, 1025, 1027
- new approach, elements of, 1027
 - protected areas, 892–893, 1026–1027
- intellectual property rights, 664–665
- intellectual resource rights, 769–770
- International Centre for Living Aquatic Resources Management (ICLARM), 651, 965
- International Council of Scientific Unions (CODATA), 651
- International Institute for Applied Systems Analysis (IIASA), 651
- international law, 1047–1052
- International Plant Genetics Resources Institute (IPGRI), 651
- International Species Inventory System (ISIS), 532
- international trade in wild animals and plants, 777–778, 787–788, 866, 966–968
- International Undertaking on Plant Genetic Resources, 945
- International Union for the Conservation of Nature Commission on National Parks and Protected Areas, 939, 982
- Caracas, 985
 - guidelines to planning protected areas, 989–990
 - protected areas categories I–VI, 985, 987
 - management categories, 552
 - Red Lists and Red Data Books*, 234–236, 491–492, 531–532
- Species Survival Commission, 531
- Action Plans, 998–999
- World Conservation Union, 652
- see also protected areas
- Internet, 632–633
- introduced species
- programmes, 1007–1008
 - and their distribution, 758–759
- invasions
- attributes of invasive organisms, 701
 - by countries, known numbers, 758
 - ecosystem susceptibility, 758–760
 - exotic invasives, 486, 700–708, 757–760
 - and extinctions, ecosystem level feedbacks to biodiversity, 297
 - from aquaculture, 966
 - Global Inventorying and Monitoring Programme (GIMP), 535
 - GMOs and GMMs, 700–708, 785
 - hazard potential, factors, 702
 - indirect negative effects, 757–758
 - introduced species and their distribution, 758
 - threats to other species, 448–449, 759
 - recovery, 760
- inventorying and monitoring, 457–543
- capacity building, 538–543
 - development of institutional capacity, 539–540
 - human resources and training, 540–542
 - local people and volunteers, 540–541
 - context and scale, 460–461
 - defined, 459
 - forests, 526, 958–960
 - human-related data, 481–482
 - inside/outside protected areas, 469–472
 - integrated approaches, 460–461, 517–539
 - for conservation, 531–535
 - coordination of inventorying, 518–523
 - coordination of monitoring, 523–529
 - global coordination, 535
 - integration with programmes monitoring physical variables, 529–531
 - international efforts, 520–523
 - national efforts, 518–520
 - summary, 535–539
- inventories
- Environmental Valuation Reference Inventory, 857
 - forests, 496
 - monitoring biodiversity, 784–786
 - multi-taxa inventories, 493
 - professionals, 540–541
 - protected areas, 471
 - scales, planning and approaches, 475–508
 - baseline data, 480–482
 - ecosystems and landscapes, 495–503
 - faunal populations, 485–486
 - genetic diversity, 482
 - longterm monitoring of ecosystemss, 503–505
 - measurement scales, 476–477
 - multiple species, 493–495
 - populations, 482–485
 - project planning, 477–480
 - single species, 486–493
 - summary, 505–508
- soils, 527
- terrestrial monitoring, extent in UK, 524
- use of data, 461–462
- biological levels, 463–469
 - examples, 463
 - pressure–state–response model, 463
 - spatial and temporal scales, 462–463
 - summary and conclusions, 457–458, 541–542
- invertebrates, endangered and vulnerable, numbers, 234
- irrigation, 744
- indicators of growth in global consumption 1950–1991, 772
- islands
- dispersal, interaction with breeding system, 162
 - endemism, 181
 - environmental degradation, 782
 - and extinctions, 234
 - human-induced extinctions, 242
 - mammals, number of species, correlation analysis, 161
 - pollination, 162
 - species diversity, analysis, 161
 - species invasions, 449
 - species numbers, rank correlations, 161
 - species–area relations, data, 147–153
 - within–species and between–species diversity
 - Anolis* case study, 81–82
 - Parula* case study, 79–81
- IUCN see International Union for the Conservation of Nature
- K/T boundary see Cretaceous mass extinction
- karyotypic variability, 63–64

- Kenya
 ecotourism values, 876
 national parks, local economic incentives, 1028
- Kew Index, Index Kewensis, 552, 659, 660
- keys to identification, 49
 examples, 45, 48
- keystone ecosystems, 307
- keystone species, 248, 250, 289, 290, 486
 defined, 290
 predators, 373
- kingfishers, New Guinea, 229
- Kirtland's warbler, 934
- lakes and rivers, 399–402
 and atmosphere, 400
 biotic linkages and species interactions, 401
 human impacts on
 biodiversity, 399–400
 microbial activities, 401
 productive capacity, biomass, decomposition and nutrient cycling, 400
 riparian systems, 307
- Landsat, remote sensing, 498
- landscapes
 biodiversity to regional scales, 304–310
 classification, 102
 and ecosystem functioning, 102, 324
 inventorying and monitoring landscapes, 495–503
 land use, human-induced perturbations of biodiversity, 318–321
 land-use diversity, 307–310
 restoration, 1008–1010
 structure
 and biodiversity, 422–427
 generalizations, 425–426
- large marine systems (LMEs) *see* oceans
- lasers, remote sensing, 499–500
- Latimeria*, 52–53
- latitudinal gradients in biodiversity, 139–142
- legislation
 combining regulatory and voluntary measures, 1046–1047
 covenants, 1045
 customary and traditional legal measures, 1038–1040
 easements, 1046
 environmental impact assessments, 971, 1047
 function of legislation, 1037–1038
 information management, 661–666
 intellectual property rights, 664–666
 intellectual resource rights, 769–770
 major issues, 663–665
 management agreements, 1046
 measures for sustainable use of biodiversity, 1037–1053
 national legislation, 1040–1052
 negative aspects and problems in enforcement, 1044
 private law, 663
 property rights, 767–769
 protected areas, 1041
 species-oriented measures, 1040–1041
 use of biodiversity, 786–787
- liability, legal aspects of information management, 666
- libraries, 565–566
 and bibliographies, 644–647
 databases, and bibliographies, 645–647
 DNA libraries, and sequence knowledge, 683–684
 virtual, 654
- lichens, indicator species, 487–490, 774
- life zones, Holdridge's, 98, 101
- life-support functions, 879
- Linnaeus, binomial system, 30–31, 33–34
- littoral region *see* coastal systems
- livestock *see* domesticated diversity
- living plant collections, 568–573
 conservation programmes, 573
 national collections, 573
 networks and linkages, 572
 Lockean standard, 837
- longterm monitoring of ecosystems, 503–505
 US LTERs, 504
- loss of biodiversity
 proximate and underlying causes, 834–835
 value, 834
 summary, 197–199
- Maastrichtian mass extinction, 208–210
- MacKinnon All-Software System, 627
- macrogenesis, speciation, 230
- Madagascar, national parks
 ecotourism, 883–884
 local economic incentives, 1028
 Mantadia National Park, 877–878
- maintenance of biodiversity
 summary, 197–199
see also conservation measures
- maize, 778
 and teosinte, 945
 viral resistance, 468
- malaria, and sickle-cell anaemia, 219
- Malawi, national parks, local economic incentives, 1028
- Malaysia, carbon sequestration, 900
- mammals
 endangered and vulnerable, numbers, 234
 harvesting, 738
 islands, number of species, correlation analysis, 161
 protected areas, 471
 responses to human interference, 734
 species, low/high estimates, 118, 119, 120
see also animals
- man
 genome size and sequence knowledge, 683
see also humans
- Man and the Biosphere Programme (MAB), 533, 534, 553, 973
- Man and the Biosphere Reserve network, DIVERSITAS, 520–521
- management *see* biodiversity management
- mangrove systems, 387–393
 biotic linkages and species interactions, 389
 landscape structure, 424
 loss, 425
 microbial activities, 389–390
 productive capacity, biomass, decomposition and nutrient cycling, 388
 speciation, 163
- Mantadia National Park, Madagascar, 877–878, 883–884, 1028
- manufacturing and processing industries, applications of biotechnology, 688
- MARBID, 521
- marine stations, 577
 as biodiversity observatories, 577
 and ecotourism, 1031
 networks
 CARICOMP, 527–528
 MARS, 527
- marine systems, 393–399
 and atmosphere, 396
 biotic linkages and species interactions, 397
 CD-ROMs, 658
 fisheries, management, 469
 fossil record, 202–212
 future, 795
 Global Ocean Ecosystem dynamics (GLOBEC), 528
 gradients in diversity, 141–142
 human impacts on
 biodiversity, 395–396, 396–397
 human-induced perturbations, 318
- Large Marine Ecosystems, 527–528
- Marine Biodiversity Database (MARBID), 523
- microbial activities, 397
- monitoring biodiversity, 500–501
 global projection of large marine ecosystems, 502
- oceanic realms, 100, 101–102
- pollutants, entering, sources, 763
- productive capacity, biomass, decomposition and nutrient cycling, 395–396
- sediment structure, 396
- structure, heuristic view, 394
- threats, 394–395
- mark-recapture, 485
- markets, 844
- market failure and policy failure, value of biodiversity, 830–831
 simulated and surrogate, 858
- Mayenus buchanni*, pharmaceuticals prospecting, 970
- Mediterranean-type ecosystems, 366–370
 biotic linkages and species interactions, 367–368
- Chile, local-regional diversity, 160
- floras, and extinctions, 234–235
- microbial activities, 368
- productive capacity, biomass, decomposition and nutrient cycling, 367
- Melitaea cinxia*, extinction rates, 237, 239
- Mesozoic–Cenozoic phase, marine fauna, 203–204
- metadatabases, 653, 655
- metals, pollution, plant tolerance, 226
- metapopulations
 defined, 227
 models, 243–244
 prediction of extinctions, 243–244
- methane, flux, 306–307
- Mexico
 CONABIO, 518, 519
 existence valuations, biodiversity conservation, 887
 folk taxonomy, 30
 maize trade, 778
- micro-organisms
 activities
 agriculture, 445
 biotic interactions, 436
 carbon and nutrient cycling, 437
 trace gas production, 437
 tropical forests, 342
- catalogues and indexes of names, 552, 660
- diversity, 433–443
 genetic resource collections, 589–590, 591–592
 history, 722
 niches, 433
 sensitivity to loss of biotic linkages and species interactions, 438–439
 size-based groups, 434–435
 species, low/high estimates, 118, 119, 120

- species-specific interactions, 435
 substrate groups, 434
 tracking, biotechnology applications, 697–698
 genetically modified (GMMs), 700–708
see also algae; fungi; viruses
- migrations
 Migratory Species Convention, 1050
 rates, assessment, 78
- milpas*, 953
- mimicry, Batesian and M \ddot{o} llerian, 62
- mitochondrial DNA
 16S region, sequence divergence, example, 61
 Eve hypothesis, 50
 levels of genetic diversity, 65
 RFLPs, 682
- molecular methods
 assessing genetic diversity, 65–70
 levels of genetic diversity, 64–70
- molecular sequence databases, 592
- molluscs, species, low/high estimates, 118, 119, 120
- monitoring *see* inventorying and monitoring
- Monte Carlo analysis, risk in valuation of biodiversity, 863
- moose, 967
- mosses, catalogues and indexes of names, 552, 660
- moths, *Uranea/Omphalea* coevolution, 428
- mouse, genome size and sequence knowledge, 683
- M \ddot{u} llerian mimicry, 62
- mutation
 accumulation, 77–78
 and selection, 222–223
- mutualism
 in corals, 436
 facultative, 251
 indirect, 251–252
 mutualists, 123
 nitrogen-based, 436
 and predation, maintaining dynamics of biodiversity, 248–251
- names *see* binomial system
- Namibia, national parks, local economic incentives, 1028
- NASA
 CIESIN, 655
 Global Change Master Directory, 655
- national biodiversity assessments, 647–649
- national biodiversity information centres, 646–648
- National Biodiversity Strategies, 927
- national environmental information system, added value, 628
- national parks
 agents of change, 1021
see also protected areas; *specific countries*
- Natural Heritage System, defining priorities, 935
- natural science collections *see* catalogues; genetic resource collections; reference collections
- natural selection
 codominance, and overdominance, 219
 detection, 78
 directional selection, 218
 dispersal and gene flow, 221
 fitness defined, 219
 on individual loci, 218–219
 on multiple characters, 220
 and mutation, 222–223
 opposed by gene flow, 223–224
 outbreeding depression, 224
 on phenotypic characters, 218
 recombination, 221
 response to selection, 220–221
 spatial and temporal variation in selection, 219–220
- nature
 cultural values and ethics, 763–764
 human world-view, 766
- Nature Conservancy, defining priorities, 935
- nature parks, 1042
- nematodes, species, low/high estimates, 118, 119, 120
- Nepal
 customary and traditional legal measures, 1039
 tourism, 1030, 1032–1033
- Netherlands, Forests Absorbing Carbon Emissions (FACES), 900
- networks, 626–627, 631–633, 642, 1054
 connectivity, world map, 634
 ECONET, 633
 electronic publishing, current issues, 643
 examples, 652–654
 File Transfer Protocol, 633
 Internet, 632–633
 list, 633
 Local Area Networks (LANs), 631–632
 NIR tools, 633
 special interest, 654
 World Wide Web, 626, 633
- von Neumann–Morgenstern utility function, 860
- New Zealand kapako, 465
- Niger, national park, agents of change, 1021
- Nigeria
 Cross River national park, local economic incentives, 1028
 floodplain use, 868
- nomenclature, 46
- non-equilibrium coexistence of species, 156, 313
- North America
 biotic invasions, 211–212
 botanic gardens, 569–571
 drylands, degradation, 755
 grasslands, 305–309
 habitat loss, 751
 human population, 1990–2100
 forecast, 794
 introduced species, threats to other species, 759
 land-use diversity, 307–310
 microbial genetic resource collections, 589
 northern spotted owl, conservation case study, 873–874
 Pleistocene extinctions, 211
 prairies, 305–306
 precipitation gradient, 305–306
 protected areas (IUCN), 983
 reference collections, 556, 560
 trees, Holocene disequilibrium, 212
 zoological collections, 573–576
see also Canada; Mexico; USA
- North Sea, Third Ministerial Conference, 863–864
- Norway
 cervids, management, 967
 endangered habitats and species, existence valuations, 875
 forests, recreational value, 869
 Lofoten Act (1890), 963
- nuclear genes
 multiple copy, 65
 single locus, 65
- nucleic acids, databases, 592
- nutrient pools, and soil structure, 346
- object-oriented database management systems (OO-DBMS), 626
- oceans *see* coastal systems; marine systems
- oil, indicators of growth in global consumption 1950–1991, 772
- option values, genetic resource collections, 681–684
- organisms *see* species
- Orient, Wallace's Line, 95
- outbreeding depression, 224
- owls, northern spotted owl, conservation case study, 873–874
- Pacific, protected areas, 471
- PacifiCorp, carbon sequestration, 900
- Palaeozoic, marine fauna, 203–204
- Panamanian isthmus, biotic invasions, 211–212
- pantanal, 143
- Papua New Guinea, customary and traditional legal measures, 1039
- parasitism, 123, 124
 generation of biodiversity, 256
 host switching, 257
 spatial and temporal variability of environment, 252–255
 synchronous evolution, 257
- parks *see* national parks; protected areas
- Partula*, within-species diversity, genetic techniques, 79–81
- Pascal's Wager, 865
- pastoralism, 725–726, 743
- patents, 665
- PATHFINDER project, 525
- pathotype, defined, 58
- PCBs, 761
 environmental remediation, 696–697
- periodicals, 646
- perturbations of biodiversity, human-induced, 318–321
- Peru
 case study, economic value of rainforests, 868
 valuation, tropical forests, cost-benefit analysis, 883
- pesticides
 categories, 741, 760–763
 deleterious effects, 951
- pests
 and frog control in Bangladesh, 863
 integrated pest management, 951–952
- Phanerozoic
 land plants, 205–206
 marine fauna, 203–204, 207
 mass extinctions, 208–210
 recoveries, 210
 vertebrates, 207
- pharmaceuticals
 prospecting, 969–970
 Costa Rica, 520–521, 866, 871, 969
 value, USA, 869
- phenotype, defined, 60
- Philippines
 fisheries, protection, 961, 962, 963
 indirect value of bioresources, 880
 Presidential Executive Order, 1044–1045
- photosynthesis
 C3 and C4 species, 319
 gene *rbcL*, 681
 phytoplankton, 437–440
- phyletic gradualism, vs punctuated equilibrium, 228
- phylogenetic reconstruction, within-species, 78
- phylogenetic species concept, 40, 43
- phylogenetic trees, 50–51
- phylogeny, defined, 28
- physiognomy, 101

- phytoplankton
 blooms, 'nuisance', 374
 carbon and nutrient cycling, 437–440
- phytosociology, 96–97
- plankton, CENPLANK, 523
- plants
 catalogs and indexes of names, 660
 CD-ROMs, Index Kewensis, 659
 characterization and preparation of floras and keys, 33–34
 living species, 552
 collections
 botanic gardens and arboretum collections, 568–573, 972, 1001, 1006
 botanical world reference collections (tabulated), 555–557
 living plant collections, 568–573
 cultivated *see* domesticated diversity, plant crops
 endangered and vulnerable, numbers, 234
 gene banks *see* genetic resource collections
 genetic resources
 Commission on Plant Genetic Resources, 532
 International Organization for Plant Information (IOPI), 523
 International Plant Genetics Resources Institute (IPGRI), 651
 International Undertaking on Plant Genetic Resources, 945
 latitudinal gradients of richness, 258
 mutualism and response to attack, 251–252
 Phanerozoic, 205–206
 plant functional attributes (PFAs), 480
 species numbers, 117, 118, 119, 120
 diversity and scale, 153–154
 low/high estimates, 118
 vs size of sampled area, 147, 147–153
 sustainable use, conservation measures, 966–970
see also reference collections
- plastics
 future prospects, 800
 products, 729–730
- Pleistocene, extinctions, 211
- policies *see* conservation measures
- pollen banks, 1006
- pollination, 430
- pollutants, 694–698, 760–763
 metals, plant tolerance, 226
- polymerase chain reaction
 gene cloning, 68–69
 random primers, RAPDs, 69
- polymorphism, defined, 60
- polyploidy
 ploidy level, domestication syndrome, 71
 polyploid complexes, 60
 and speciation, 225
- populations
 analysis, 484
 viability analysis, 244
 differentiation, phyletic gradualism, vs punctuated equilibrium, 228
ex situ conservation, 1000–1005
 extinctions
 metapopulations, 238–240
 single populations, 236–238
 and size, 238
 genetic diversification, 214
 human *see* human populations
in situ conservation, 999–1000
 inventorying and monitoring, 466, 482–485
 minimum viable (MVPs), 484
 persecution and exploitation, 241–242
 population biology, 11
 prediction of extinctions
 metapopulations, 243–244
 single populations, 242–243
 structure, measurement, 78
 transformation and fragmentation, 449–450
- potato, genetic diversity, 944
- poverty, discounting and value, 830–831
- prairies, North America, 305–306
- precautionary principle, 15–16
 and safe minimum standards, 863–864
- predation
 diffuse, 248
 ecosystem services, 302–303
 keystone species, 250
 and mutualism, maintaining dynamics of biodiversity, 248–251
 spatial aggregation, 250
 spatial and temporal variability of environment, 252–255
- preservation methods, 564
- pressure–state–response model, inventory, 463
- primates, protection, 839
- private reserves and land-leasing, 1033–1034
- productive capacity
 and biodiversity, 448
 biomass accumulation, 402–406
 and disturbance, 405
 habitat variation in space and time, 403–404
 and resource augmentation, 404–405
- property legislation, Australia, 1044
- property rights
 appropriation, five components, 791
 clearers vs forest dwellers, 779
 common property concept, 790–791
 historical trends, 732–733
 incentives, and distribution of assets, 902–903
 inequity of ownership, 781–783
 intellectual property rights, 664–665
 and the State, 769
 use of biological resources, 767–769
- prospect theory, 858–859
- protected areas, 552–554, 982–994
 by biogeographical realm, 986
 by biome type, 988
 classification, 982–986
 coastal systems, 553
 defined, 982
 goals of conservation, 891–893
 and indigenous communities, 595, 1024–1026
 integrated conservation development projects (ICDPs), 892–893, 1026–1027
 International Union for the Conservation of Nature, categories I–VI, 985, 987
 inventorying and monitoring, 469–472
 legislation, 1041
 management of biodiversity, 986–987
 categories, IUCN, 552
 by objectives, 987–990
- national parks
 contingent valuation method survey, 877
 creation, 877–878
 number, 983
 planning, guidelines, 989–990
 size distribution, 986
 tropical regions, 471
 use and socioeconomic benefits, 471
 valuation, 876–878
 world, growth, 984
 summary, world, 983
- protein databases, 592
- Protoctista, species, 117, 118
- 'public good' nature of biodiversity, 845, 903
- pulses, productivity contributions of wild sources, 871
- punctuated equilibrium, vs phyletic gradualism, population differentiation, 228
- quality of life, GNP and GDP measures, 781
- rabbit, as introduced species, threats to other species, 759
- radar, remote sensing, 499
- radio tracking, 485
- rainforests *see* tropical forests
- RAMSAR Convention, 530, 1043, 1049, 1051
- random primers, RAPDs, defined, 69
- rapid assessment programmes (RAPs), 495
- rapid bioinventory assessments (RBAs), 493
- rarity, 145–146
- rattans, 468
 Indonesia, 1030
- Raunkaier's lifeforms, 91
- recognition species concept, 42
- recognizable taxonomic units (RTUs), 480
- recombination, 221
- RECORDER, 638
- recycling, 971
- Red Lists and Red Data Books*
 IUCN, 234–236, 491–492, 531–532
 IUCN categories, 995–996
- redundant species hypothesis, 283, 289
- reference collections, 554–565
 adequacy and costs, 564–565
 examples of specimens, 554
 living
 animals, 573–576
 plants, 568–573
 preservation methods, 564
 world
 botanical (tabulated), 555–557
 zoological (tabulated), 548–563
see also genetic resource collections
- regional diversity
 enrichment, vs community saturation, 157–158
 landscape scales of diversity, 304–310
 and local diversity, 159–160
- relational database management systems (RDBMS), 625–626
- religion
 Christianity and devaluation of biodiversity, 839
 Pascal's Wager, 865
- remote sensing, 485, 496–500
 data formats, 620–621
 digital cameras, 499
 electro-optical systems, 497
 lasers, 499–500
 passive systems, 497–498
 radar, 499
 recommended uses for data sources, 500
 satellite-based systems, 498
 videography, 498–499
- reptiles
 endangered and vulnerable, numbers, 234
 protected areas, 471
- resource base, 549–605
 appropriation, five components, 791
 bequest motives, 837

- consequences of increasing demand, 776–778
- Convention on Biological Diversity, sustainable use defined, 15
- economic policies, 778–781
- failure to value, 778–781
- historical considerations, 552–553
- human population growth, 771–773
- indicators of growth in global consumption 1950–1991, 772
- indirect value of bioresources, 878–880
- inequity of ownership, 781–783
- inter-generational equity, 837
- land use
- human-induced perturbations of biodiversity, 318–321
 - monitoring, 523–527
 - management, 789–790
 - private value, 834–835
 - use of biological resources, 763–767
 - property rights, 767–769
 - summary, 549–550
 - see also* catalogues; genetic resource collections; genetic resources; reference collections
 - see also* value of biodiversity
- restoration of ecosystems, 1005–1016
- restriction fragment length polymorphisms (RFLPs)
- chloroplast, 682
 - data analysis, 67–68
- restrictions and taboos, 838–839
- Rhagoletis* (fruit fly), sympatric speciation, 230
- rhinoceros
- exploitation, 778
 - Sumatran, *in situ* conservation, 1002
- Ribosomal RNA Database Project, 593
- rice, productivity contributions of wild sources, 870, 871
- Rio summit *see* Convention on Biological Diversity; UNCED
- risk aversion *see* valuation of biodiversity, risk
- rivers *see* lakes and rivers
- river hypothesis, 284, 291
- roads, 971–973
- associated wildlife, 776
 - habitat fragmentation, 775
 - and tropical rainforests, 973
- Runa Indians, forest cultivation, 723
- rural industries, applications of biotechnology, 688
- sacred groves, 839
- salinization, 744, 992
- salmon
- elimination of species, Norway, 759
 - genetic markers, individual tracing, 465
- Salmonella*, International Centre, 590
- satellite-based systems, remote sensing, 498
- scientific names *see* binomial system
- sea coast *see* coastal systems
- sea otter
- Alaskan kelp forests, 373, 424
 - keystone species, 290
- seals, losses via nets, 748
- seas *see* marine systems
- seed dispersal, 430–432
- self-fertilization, and recombination, 221
- sentinels, 488
- sequencing *see* genetic techniques
- services to humans concept of ecosystems, 282–285, 446–447, 450–451
- management implications, 325
- sewage, 774
- shadow project method, valuation of biodiversity, 857
- Shannon index, 91
- shoreline *see* coastal systems
- sickle-cell anaemia, 219
- Singapore, vegetation types, 775
- slave trade, 727
- snail, land, within-species diversity, 79–80
- social change, 785–789
- consequences, prediction, 791
- social costs of biodiversity, 903
- social-economic strategies
- interventions at
 - local/community levels, 1017–1026
 - local economic incentives, 1028
 - participatory rural appraisal, 1022–1023
 - sustainable use of biodiversity, 1017–1037
 - use of indigenous knowledge, 595, 1018–1020
- willingness to pay/accept compensation for gain/loss of biodiversity, 835
- see also* economic policies; sustainable policies
- software and hardware, 635–639
- biodiversity applications, list, 637–638
- CD-ROMs, and diskettes, 656–663
- soil, 406–412
- and agriculture, 406–408, 444
 - and biodiversity, 452
 - nutrient resources, turnover, 293–295
 - organic matter, 408
 - spatial complexity, 408–409
 - structure, and nutrient pools, temperate forests, 346
- South Africa
- monitoring protected areas, 470
 - national parks, local economic incentives, 1028
 - see also* Africa
- South America
- Andean Pact initiative, 1045
 - biotic invasions, 211–212
 - botanic gardens, 569–571
 - community-based ecotourism, 1031–1032
 - direct use values, tropical forests, 885
 - drylands, 755
 - habitat loss, 751
 - human population, 1990–2100
 - forecast, 794
 - introduced species, threats to other species, 759
 - microbial genetic resource collections, 589
 - protected areas, 471
 - protected areas (IUCN), 983
 - reference collections, 557, 561
 - tropical forests, hypothetical value, all mutually compatible use values, 886
 - zoological collections, 573–576
 - see also* Central America
- Spain, species-oriented measures, 1040
- spatial structure, ecosystem functioning, 301–303
- speciation
- allopatric speciation, 221
 - asexual taxa, 230–231
 - diversification of, 225–232
 - macrogenesis, 230
 - models, 229
 - allopatric, 221, 229–230
 - parapatric, 230
 - stasipatric, 230
 - sympatric, 230
 - phyletic gradualism vs punctuated equilibrium, 228
 - and polyploidy, 225
 - population differentiation, 226–228
 - summary, 197, 232
- SPECIES 2000 Global Master Species Database programme, 71
- species
- see also* species numbers
 - aggregate, 60
 - biological species concept, 41–43
 - catalogues and indexes of names, 660–662
 - characterization and recognition, 40–48
 - classification of living organisms (Whittaker's), 117
 - cohesion species concept, 42–43
 - conservation-focus species, 490
 - defined, 9
 - distribution, global classification, 94–95
 - ecological species concept, 43
 - effect of removal on biotic linkages, 429
 - evolutionary species concept, 44
 - gene pool concept, 43
 - genetic variability, partitioning, 61–63
 - indicator species, 487–490
 - in situ* and *ex situ* conservation, 999–1005
 - introductions, 145, 785
 - GMOs and GMMs, 700–708, 785
 - invasions, introductions and loss, 449
 - inventorying and monitoring, 466–467, 486–495
 - key strategies, 478
 - statistical analysis, 479–480
 - value of new species, 468
 - voucher specimens, 477–478
 - lifespan, 232
 - marine
 - average duration, 202
 - modern, 202
 - morphological species concept, 40, 41, 43
 - multiple species monitoring, 493–495
 - new
 - 1979–88, 119
 - 1992, 594
 - phylogenetic species concept, 40, 43
 - polytypic/monotypic, 58
 - rarity, 145–146
 - recognition species concept, 42
 - redundant species hypothesis, 283
 - removal, effect on biotic linkages, 429
 - restoration, 1005–1007
 - single species monitoring, 493–495
 - speciation, 155–156
 - species richness
 - and α -diversity, 88–89
 - and distribution of professional plant ecologists, 1056
 - subspecies, defined, 58
 - taxonomic measurement of diversity, 51–53
 - threatened species *see* endangered species
 - threatened, vulnerable and rare species, 234, 491–492
 - traits
 - change in communities, 293–297
 - discrete, continuous and skewed, 294
 - resource supply, 294–295

- species *continued*
 turnover in ecosystems, 467, 486–495
 typical or representative species, 492–493
 valuation *see* valuation of biodiversity
 variety, defined, 58
see also endangered species; extinctions; invasive species; keystone species
- species index, preparation, 568
- species numbers
 alteration, effect on ecosystem processes, 292, 293
 described and estimated, 120
 described to date, 116–120
 extrapolation from ratios, 121
 inventory, 115–116, 124
 marine, numbers of invertebrates, 202
 multiplication, 231
 new
 and numbers of authors, 594
 rate of description, 118, 119
 plants, vs size of sampled area, 147, 147–153
 problems and prospects, 123
 sources of undisclosed richness, 121–122
 totals that ever lived, estimate, 202
 tropical rainforests, 249
 uncertainty, scale, 123–124
 species richness, and endemism, 180
- Species Survival Commission, IUCN, Action Plans, 998–999
- species–area relations, data, 147–153
- Sphenodon*, 52–53
 genetic bottlenecks, 465
- Sri Lanka, customary and traditional legal measures, 1039
- SSSIs, 1041–1042, 1046
- statistical techniques, 103
- stochasticity
 colonisation–extinction, 240
 demographic, 236–237
 environmental, 237
 regional, 240
- stress, and biodiversity, 154
- Structured Query Language, 625
- structured query language (SQL), 625–626
- stud books, 532
- subsidies, 776
- Sudan, cropping systems, *Acacia senegal* case study, 867–868
- sugarcane, mosaic virus, 870
- surveys
 genetic surveys, 464
 visual encounter surveys (VESs), 41
- sustainable policies
 biodiversity management, 320
 development of relevant technologies, 791–792
- environmental accounting, 778–781
- information requirements, 783–792
- social–economic strategies, 1017–1037
- sustainable use
 defined, 15
 management, 943–981
- Sweden
 endangered habitats, existence valuations, 875
 endangered species, existence valuations, 875
 indirect value of bioresources, 880
- systematics, defined, 28
- Systematics Agenda 2000, 521–523, 542
- Charting the Biosphere, 521–523, 541
- Tanzania, national park, agents of change, 1021
- taxa
 All Taxa Biodiversity Inventory (ATBI), 493, 494
 polytypic/monotypic taxa, 58, 90
 taxic diversity, 91–92
 taxon–specific patterns of diversity, 160–161
 use in estimates of biodiversity, 202–203
- taxonomy
 allozyme electrophoresis, 65–67
 basis for prediction, 49
 binomial system, 30–31, 33
 characterization and recognition of species, 40–48
 classifications, changes, 38–40
 Codes and Committees, 31
 data matrices, 37
 databases, 35–36
 defined, 28
 Expert Center for Taxonomic Identification, 638
 Floras and keys, 33–34
 rates of production, 35
 hierarchies, 29
 human resources, 594–595
 major taxa, 29
 measurement of species diversity, 51–53
 Partnerships for Enhancing Expertise in Taxonomy (PEET), 542
 phylogenetic trees, 50–51
 pluralistic approaches, 44–48
 power of, 46–51
 in practice, 31–33
 data, examples, 32
 species concepts, 40–48
 Systematics Agenda 2000, 521–523, 541
 systematists, 593
 taxonomic products, 48–49
 classification, 48
- description/circumscription, 49
 keys, 45, 48, 49
 nomenclature, 48–49
 uses for, 50–51
see also genetic diversity
- TCE, co–metabolism, 697
- technology
 and adaptation to global change, 799–800
 selection, 666–668
see also biotechnology
- temperate forests, 345–349
 atmospheric properties and feedback, 346–347
 biotic linkages and species interactions, 347–348
 landscape and waterscape structure, 347, 423
 microbial activities, 348
 productive capacity, biomass, decomposition and nutrient cycling, 345–346
 soil structure and nutrient pools, 346
 species numbers, 249
- temperate grasslands, 361–366
 biotic linkages and species interactions, 364
 landscape structure, 423
 microbial activities, 364–365
 productive capacity, biomass, decomposition and nutrient cycling, 362–363
 soil structure and nutrient pools, 363
- teosinte, and maize, 945
- territory mapping, 485
- tetrapods, Phanerozoic, 203–204, 207
- Thailand
 Biodiversity Country Study, 1055
 community forest management, 1024
 customary and traditional legal measures, 1039
 ecotourism value, 866
 Khao Yai Park, 877–878, 887
 national parks, agents of change, 1021
- thesauri, environmental, 23–24
- threatened species *see* endangered species
- thresholds in ecosystems, 314
- tiger, exploitation, 778, 779
- tilapia, escapes from aquaculture, 966
- tissue culture banks, 1006
- TNT, degradation, biotechnology applications, 697
- tomato cultivars, 468
- Total Environmental Value and Total Economic Value, 830
- tourism
 sustainable use, conservation measures, 970–971
 value, World Bank valuation, 876
- see also* ecotourism
- toxic waste, trade, 777
- trade, and sustainability, 789
- trade in wild animals and plants, 777–778, 787–788, 866, 966–968
see also CITES
- traditional management
 agriculture, indigenous communities, 740–744, 945–948
 forestry, 952–954
- traditional values
 ethics, impact on biodiversity, 763–767
 harmful practices, 765
- training, human resources in conservation, 667
- tramp species, 487
- transferable development rights (TDRs), 897–898
- transpiration, 413–414
- travel cost model (TCM), valuation of biodiversity, 848–850
- trees
 Holocene disequilibrium, 212
 individual plantings, 953
 monoculture, 283
see also forestry; forests;
 temperate forests; tropical forests
- trophic cascades, and water, 414
- trophic level, 92
 defined, 286
- tropical forests, 339–345
 atmospheric properties and feedback, 341
 biotic linkages and species interactions, 341–342
 carbon offsets, 897
 cattle ranches, tax shelters for investors, 894
 conservation, species vs habitats, 839–841
 cultivation systems, 723
 deforestation, 309
 consequences for biodiversity, 753
 effects, 749, 753
 extent 1980–90, 749
 immediate and underlying causes, 735
 distribution, and climate, 96
 dry forest, restoration programme, Costa Rica, 1010
 economic value, Peru case study, 868
 environmental performance bonds, 896–897
 exports, valuation, 866
 and extinctions, 235
 habitat loss and fragmentation, 241, 750–757
 human impacts on biodiversity, 339–340
 landscape structure, 424
 management, 790
 microbial activities, 342
 non–forestry policies, 893–894

- pharmaceuticals, prospecting, 866
 productive capacity, 340–341
 property rights, clearers vs forest dwellers, 778
 recreational value vs economic use, 868–869
 reforestation incentives, 896
 species numbers, 249
 transferable development rights, 897–898
 turnover, increase, threat to biodiversity, 506–507
 using biodiversity, 468
 valuation of biodiversity, 890–904
 direct use, list, 885
 hypothetical value, all mutually compatible use values, 886
 valuation, cost–benefit analysis
 Cameroon, 881–882
 Peru, 883
 Philippines, 882–883
 values, defined, 889
 tropical savannahs, 354–358
 biotic linkages and species interactions, 355–356
 landscape and waterscape structure, 355, 423–424
 microbial activities, 356
 productive capacity, biomass, decomposition and nutrient cycling, 354–355
 soil structure and nutrient pools, 355
 turtles
 exclusion devices, 965
 genetic markers, 465
 habitat threat example, 777
 mitochondrial DNA, RFLPs, 682
 TWINSpan, 97
 umbrella species, 490–491
 UN
 Development programme, 'Capacity 21', 1053
 National Parks, list, 982, 983
 Statistical Division (UNSTAT), 652
 see also International Union for the Conservation of Nature
 UNCED (Rio summit), 7
 Agenda 21, 7
 see also Convention on Biological Diversity
 UNEP, 7
 Biodiversity Country Studies Project, 8
 country studies programme, 648
 Global Resources Information Database (GRID), 653
 HEMDisk, 658
 International Environment Information System, INFOTERRA, 652
 UNCED (Rio summit), 7
 see also Convention on Biological Diversity
 UNESCO, 652
 Biosphere Reserve Network, 533, 534
 Man and Biosphere Programme (MAB), 533, 534, 973
 Man and the Biosphere Reserve network, DIVERSITAS, 520–521
 UNFAO, 651
 Commission on Plant Genetic Resources, 532
 Forest Resources Assessment, 523–524
 United Kingdom
 Countryside Survey of Great Britain, 103
 data agencies, 654
 endangered habitats, existence valuations, 875
 Forestry Commission, recreational value vs economic use, 868
 North York Moors, co-management, 930
 SSSIs
 conservation orders, 1041–1042
 legislation, 1046
 terrestrial monitoring, extent, 524
 wetlands, recreational value, 869
 United Nations *see* UN and other acronyms
 United States of America
 endangered habitats, existence valuations, 875
 endangered species, existence valuations, 875
 financial support to biodiversity conservation, developing countries, 1060
 Florida case study in land use, 1043
 forests, recreational value, 869
 hunting, recreational value, 869
 indirect value of bioresources, 880
 Long-Term Ecological Research sites, 504
 prairies, 305–306
 species-oriented measures, 1040
 see also North America
Uranaja/Omphalea coevolution, 428
 urbanization
 and biodiversity, 773–776, 971
 cities, growth, 774
 green spaces, 972, 973
 history, 726–728
 and infrastructure, and conservation measures, 971–973
 use of biodiversity *see* valuation of biodiversity, use value
 valuation of biodiversity, 788–789, 827–914, 865–878
 and conservation, 890–904
 cost–benefit analysis, 862, 881–882
 defined, 857–858
 economics of biodiversity, 787–789
 ecosystem functions, 878–889
 indirect value of bioresources, 878–880
 estimates, 880
 production, carrier and information functions, 879
 Environmental Commodities Spectrum and Valuation Problem, 845
 ethics, and equity, 836–837
 extended scenario analysis, 863
 financial aspects, 667
 forests, productivity change method, 856
 incentives
 and appropriation of value, 893–902
 and distribution of assets, 902–903
 integrated conservation development projects (ICDPs), 892–893
 intrinsic value of diversity, 832–833
 market failure and policy failure, 830–831
 net present values (NPV), 863
 perception of value, social and cultural differences, perception of value, 837–839
 pharmaceuticals, 869, 871
 and policies, 888–889
 poverty, discounting and value, 831–832
 production function approaches, 851–856
 religion and world-view, 839
 restrictions on use, 838–839
 revealed preference methods
 hedonic travel cost model (HTC), 850
 random utility model, 850–851
 travel cost model (TCM), 848–850
 revealed preference and opportunity cost, 856–857
 benefits transfer, 857
 change in earnings method, 856
 change in productivity method, 856
 compensation cost method, 857
 defensive or preventive expenditures method, 856
 replacement cost method, 856–857
 shadow project method, 857
 substitution of proxy method, 857
 risk and uncertainty, 858–865
 environmental decision-making, 862–863
 expected utility hypothesis, 860
 models of fundamental uncertainty, 861
 Monte Carlo analysis, 863
 precautionary principle, 863–864
 principle of indifference, 859, 860
 risk defined, 858
 uncertainty defined, 858
 utility approach, 859
 worst-case scenario, 863
 summary, 864–865
 species and habitats, 865–878
 biotechnology, 869–872
 case studies, 865–869
 genetic resources, 869–872
 value of parks and protected areas, 876–878
 value of species, 872–876
 summary, 878
 stated preference methods, 845–848
 contingent ranking, 846–848
 northern spotted owl case study, 873–874
 contingent valuation, 845–846, 884
 survey, 877
 structural adjustment programmes and policies, 894–895
 Total Environmental Value and Total Economic Value, 830, 843
 use value, 839–844
 habitats vs ecosystems, 841–843
 non-use value, non-use value example, 844–845
 species vs habitats, 839–841
 typology of values, 835–836
 summary, 843–844
 wild resources, estimates of direct use value, list, 866
 willingness to pay (WTP) and willingness to accept (WTA), 858–859, 872–874
 summaries, 827–828, 857–858, 904
 Vanuatu, private reserves and land-leasing, 1033–1034
 vectors, 161
 vegetation cover
 future prospects, 797
 and land use monitoring, 523–527
 videography, remote sensing, 498–499
 Virgin Islands National Park, 1031

- viruses
 catalogues and indexes of names, 660
 catalogues and indexes of names of living species, 552
 species, low/high estimates, 118, 119, 120
 visual encounter surveys (VESs), 41
 von Neumann–Morgenstern utility function, 860
Vorsorgeprinzip, defined, 863–864
 voucher specimens, 477–478
- Wallace's Line, 97, 100
- water
 distribution and quality in ecosystems, 412–417
 'free' services, 447
 groundwater fluxes, 413
 summary, 415
 and trophic cascades, 414
 water fees as conservation incentives in forests, 896
- West Indian islands, species diversity, analysis, 160, 161
- West Indies, factors influencing species diversity, correlation analysis, 161
- wetlands
 changes in hydrological regime, 994
 degradation and loss, 755, 756
 direct vs indirect exploitation, 868
 RAMSAR Convention, 531, 1043, 1049, 1051
 recreational value, 869
see also coastal systems; freshwater systems
- whales, exploitation, 738
- wheat
 productivity contributions of wild sources, 871
 productivity value, 871
- wilderness concept, 764
- wildlife
 'private ownership' of wildlife, 968
 sustainable use, conservation measures, 966–970
see also animals; biodiversity; plants; *and specific topics*
- within–species and between–species diversity, 78
 genetic techniques, 80–81
- within–species phylogenetic reconstruction, 78
- women
 and poverty, 831–832
 role in biodiversity–related issues, 770
- world
 1990–2100 population forecast, 794
 biogeographic realms, 99
 biological resources *see* resource base
 biomes, distribution, 98
 botanic gardens and arboretum collections, 569–571
 botanical and zoological world reference collections (tabulated), 555–557, 583–586
 classification of ecosystems, 100–102
 crops
 centres of genetic diversity, 944
 Vavilov's centres of origin of crops, 72
 desert encroachment, extent, 754
 drylands, degradation, 755
 ecoregions, 99
 environmental reports, list, 650
 floristic regions, 95
 funding levels for biodiversity management, 1059
 global changes affecting biodiversity, 737
 future prospects, 792–802
 global classification systems, 97
 global environmental markets, 899–902
 global inventories, 495
 global and regional assessments, 649–652
 list, 649–652
 international efforts in inventorying and monitoring, 520–523
 introduced species, (threats to other species, 759
 map
 networks, connectivity, 634
 WORLDMAP, 638, 936
 oceanic realms, 100
 origins of domesticated plants and animals, 725
 pesticide use, 951
 protected areas, 471, 983–984
 tropical forests, distribution and climate, 96
 wetlands, degradation and loss, 756
 zoogeographic regions, 95
 zoological collections, 573–576
see also Global – World Conservation Monitoring Centre (WCMC), 233, 531, 652
 tropics, inventories, 553
 World Conservation Strategy, terminology, 924
 World Conservation Union, IUCN, 652
 World Data Centres, 655
 World Federation for Culture Collections, 588, 655
 World Heritage Convention, 1049, 2291
 world population *see* human population
 World Wide Web, 633, 644, 654
 Wright, F.
 genetic drift, 224–225
 Wright's F_{ST} , 214
- Y-linked genes, 65
- yeast, genome size and sequence knowledge, 683
- yield, and biodiversity, 446
- Zambia
 Kasanka national park, local economic incentives, 1028
 national park, agents of change, 1021
- Zimbabwe
 buffalo ranching, 866, 969
 Campfire Programme, 969
 'private ownership' of wildlife, 968–969
 woodland, contingent valuation, 884
 zoological collections, 576–577
 role, 1001–1002
 world reference collections (tabulated), 548–563
 Zurich–Montpellier school, phytosociology, 96–97