

8 On the Transmission of Electricity Without Wires

Nikola Tesla

Reprinted from *Electrical World and Engineer*, March 5, 1904



It is impossible to resist your courteous request extended on an occasion of such moment in the life of your journal. Your letter has vivified the memory of our beginning friendship, of the first imperfect attempts and undeserved successes, of kindnesses and misunderstandings. It has brought painfully to my mind the greatness of early expectations,

the quick flight of time, and alas! the smallness of realizations. The following lines which, but for your initiative, might not have been given to the world for a long time yet, are an offering in the friendly spirit of old, and my best wishes for your future success accompany them.

Towards the close of 1898 a systematic research, carried on for a number of years with the object of perfecting a method of transmission of electrical energy through the natural medium, led me to recognize three important necessities: First, to develop a transmitter of great power; second, to perfect means for individualizing and isolating the energy transmitted; and, third, to ascertain the laws of propagation of currents through the earth and the atmosphere. Various reasons, not the least of which was the help proffered by my friend Leonard E. Curtis and the Colorado Springs Electric Company, determined me to select for my experimental investigations the large plateau, two thousand meters above sea-level, in the vicinity of that delightful resort, which I reached late in May, 1899. I had not been there but a few days when I congratulated myself on the happy choice and I began the task, for which I had long trained myself, with a grateful sense and full of inspiring hope. The perfect purity of the air, the unequaled beauty of the sky, the imposing sight of a high mountain range, the quiet and restfulness of the place—all around contributed to make the conditions for scientific observations ideal. To this was added the exhilarating influence of a glorious climate and a singular sharpening of the senses. In those regions the organs undergo perceptible physical changes. The eyes assume an extraordinary limpidity, improving vision; the ears dry out and become more susceptible to sound. Objects can be clearly distinguished there at distances such that I prefer to have them told by someone else, and I have heard—this I can venture to vouch for—the claps of thunder seven and eight hundred kilometers away. I might have done better still, had it not been tedious to wait for the sounds to arrive, in definite intervals, as heralded precisely by an electrical indicating apparatus—nearly an hour before.

In the middle of June, while preparations for other work were going on, I arranged one of my receiving transformers with the view of determining in a novel manner, experimentally, the electric potential of the globe and studying its periodic and casual fluctuations. This formed part of a plan carefully mapped out in advance. A highly sensitive, self-restorative device, controlling a recording instrument, was included in the secondary circuit, while the primary was connected to the ground and an elevated terminal of adjustable capacity. The variations of potential gave rise to electric surgings in the primary; these generated secondary currents, which in turn affected the sensitive device and recorder in proportion to their intensity. The earth was found to be, literally, alive with electrical vibrations, and soon I was deeply absorbed in the interesting investigation. No better opportunities for such observations as I intended to make could be found anywhere. Colorado is a country famous for the natural displays of electric force. In that dry and rarefied atmosphere the sun's rays beat the objects

with fierce intensity. I raised steam, to a dangerous pressure, in barrels filled with concentrated salt solution, and the tin-foil coatings of some of my elevated terminals shriveled

up in the fiery blaze. An experimental high-tension transformer, carelessly exposed to the rays of the setting sun, had most of its insulating compound melted out and was rendered useless. Aided by the dryness and rarefaction of the air, the water evaporates as in a boiler, and static electricity is developed in abundance. Lightning discharges are, accordingly, very frequent and sometimes of inconceivable violence. On one occasion approximately twelve thousand discharges occurred in two hours, and all in a radius of certainly less than fifty kilometers from the laboratory. Many of them resembled gigantic trees of fire with the trunks up of down. I never saw fire balls, but as compensation for my disappointment I succeeded later in determining the mode of their formation and producing them artificially.

In the latter part of the same month I noticed several times that my instruments were affected stronger by discharges taking place at great distances than by those near by. This puzzled me very much. What was the cause? A number of observations proved that it could not be due to the differences in the intensity of the individual discharges, and I readily ascertained that the phenomenon was not the result of a varying relation between the periods of my receiving circuits and those of the terrestrial disturbances. One night, as I was walking home with an assistant, meditating over these experiences, I was suddenly staggered by a thought. Years ago, when I wrote a chapter of my lecture before the Franklin Institute and the National Electric Light Association, it had presented itself to me, but I dismissed it as absurd and impossible. I banished it again. Nevertheless, my instinct was aroused and somehow I felt that I was nearing a great revelation.

It was on the third of July—the date I shall never forget—when I obtained the first decisive experimental evidence of a truth of overwhelming importance for the advancement of humanity. A dense mass of strongly charged clouds gathered in the west and towards the evening a violent storm broke loose which, after spending much of its fury in the mountains, was driven away with great velocity over the plains. Heavy and long persisting arcs formed almost in regular time intervals. My observations were now greatly facilitated and rendered more accurate by the experiences already gained. I was able to handle my instruments quickly and I was prepared. The recording apparatus being properly adjusted, its indications became fainter and fainter with the increasing distance of the storm, until they ceased altogether. I was watching in eager expectation. Surely enough, in a little while the indications again began, grew stronger and stronger and, after passing through a maximum, gradually decreased and ceased once more. Many times, in regularly recurring intervals, the same actions were repeated until the storm which, as evident from simple computations, was moving with nearly constant speed, had retreated to a distance of about three hundred kilometers. Nor did these strange actions stop then, but continued to manifest themselves with undiminished force. Subsequently, similar observations were also made by my assistant, Mr. Fritz Lowenstein, and shortly afterward several admirable opportunities presented themselves which brought out, still more forcibly, and unmistakably, the true nature of the wonderful phenomenon. No doubt, whatever remained: I was observing stationary waves.

As the source of disturbances moved away the receiving circuit came successively upon their nodes and loops. Impossible as it seemed, this planet, despite its vast extent, behaved like a conductor of limited dimensions. The tremendous significance of this fact in the transmission of energy by my system had already become quite clear to me. Not only was it practicable to send telegraphic messages to any distance without wires, as I recognized long ago, but also to impress upon the entire globe the faint modulations of the human voice, far more still, to transmit power, in unlimited amounts, to any terrestrial distance and almost without loss.

With these stupendous possibilities in sight, and the experimental evidence before me that their realization was henceforth merely a question of expert knowledge, patience and skill, I attacked vigorously the development of my magnifying transmitter, now, however, not so much with the original intention of producing one of great power, as with the object of learning how to construct the best one. This is, essentially, a circuit of very high self-induction and small resistance which in its arrangement, mode of excitation and action, may be said to be the diametrical opposite of a transmitting circuit typical of telegraphy by Hertzian or electromagnetic radiations. It is difficult to form an adequate idea of the marvelous power of this unique appliance, by the aid of which the globe will be transformed. The electromagnetic radiations being reduced to an insignificant quantity, and proper conditions of resonance maintained, the circuit acts like an immense pendulum, storing indefinitely the energy of the primary exciting impulses and impressions upon the earth of the primary exciting impulses and impressions upon the earth and its conducting atmosphere uniform harmonic oscillations of intensities which, as actual tests have shown, may be pushed so far as to surpass those attained in the natural displays of static electricity.

Simultaneously with these endeavors, the means of individualization and isolation were gradually improved. Great importance was attached to this, for it was found that simple tuning was not sufficient to meet the vigorous practical requirements. The fundamental idea of employing a number of distinctive elements, co-operatively associated, for the purpose of isolating energy transmitted, I trace directly to my perusal of Spencer's clear and suggestive exposition of the human nerve mechanism. The influence of this principle on the transmission of intelligence, and electrical energy in general, cannot as yet be estimated, for the art is still

in the embryonic stage; but many thousands of simultaneous telegraphic and telephonic messages, through one single conducting channel, natural or artificial, and without serious mutual interference, are certainly practicable, while millions are possible. On the other hand, any lesired degree of individualization may be secured by the use of a great number of co-operative elements and arbitrary variation of their distinctive features and order of succession. For obvious reasons, the principle will also be valuable in the extension of the distance of transmission.

Progress though of necessity slow was steady and sure, for the objects aimed at were in a direction of my constant study and exercise. It is, therefore, not astonishing that before the end

of 1899 I completed the task undertaken and reached the results which I have announced in my article in the Century Magazine of June, 1900, every word of which was carefully weighed.

Much has already been done towards making my system commercially available, in the transmission of energy in small amounts for specific purposes, as well as on an industrial scale. The results attained by me have made my scheme of intelligence transmission, for which the name of "World Telegraphy" has been suggested, easily realizable. It constitutes, I believe, in its principle of operation, means employed and capacities of application, a radical and fruitful departure from what has been done heretofore. I have no doubt that it will prove very is efficient in enlightening the masses, particularly in still uncivilized countries and less accessible regions, and that it will add materially to general safety, comfort and convenience, and maintenance of peaceful relations. It involves the employment of a number of plants, all of which are capable of transmitting individualized signals to the uttermost confines of the earth. Each of them will be preferably located near some important center of civilization and the news it receives through any channel will be flashed to all points of the globe. A cheap and simple device, which might be carried in one's pocket, may then be set up somewhere on sea or land, and it will record the world's news or such special messages as may be intended for it. Thus the entire earth will be converted into a huge brain, as it were, capable of response

in every one of its parts. Since a single plant of but one hundred horse-power can operate hundreds of millions of instruments, the system will have a virtually infinite working capacity, and it must needs immensely facilitate and cheapen the transmission of intelligence.

The first of these central plants would have been already completed had it not been for unforeseen delays which, fortunately, have nothing to do with its purely technical features. But this loss of time, while vexatious, may, after all, prove to be a blessing in disguise. The best design of which I know has been adopted, and the transmitter will emit a wave complex of total maximum activity of ten million horse-power, one per cent, of which is amply sufficient to "girdle the globe." This enormous rate of energy delivery, approximately twice that of the combined falls of Niagara, is obtainable only by the use of certain artifices, which I shall make known in due course.

For a large part of the work which I have done so far I am indebted to the noble generosity of Mr. J. Pierpont Morgan, which was all the more welcome and stimulating, as it was extended at a time when those, who have since promised most, were the greatest of doubters. I have also to thank my friend, Stanford White, for much unselfish and valuable assistance. This work is now far advanced, and though the results may be tardy, they are sure to come.

Meanwhile, the transmission of energy on an industrial scale is not being neglected. The Canadian Niagara Power Company have offered me a splendid inducement, and next to achieving success for the sake of the art, it will give me the greatest satisfaction to make their concession financially profitable to them. In this first power plant, which I have been designing for a long time, I propose to distribute ten thousand horse-power under a tension of one hundred million volts, which I am now able to produce and handle with safety.

This energy will be collected all over the globe preferably in small amounts, ranging from a fraction of one to a few horse-power. One its chief uses will be the illumination of isolated homes. I take very little power to light a dwelling with vacuum tubes operated by high-frequency currents and in each instance a terminal a little above the roof will be sufficient. Another valuable application will be the driving of clocks and other such apparatus. These clocks will be exceedingly simple, will require absolutely no attention and will indicate rigorously correct time. The idea of impressing upon the earth American time is fascinating and very likely to become popular. There are innumerable devices of all kinds which are either now employed or can be supplied, and by operating them in this manner I may be able to offer a great convenience to whole world with a plant of no more than ten thousand horse-power. The introduction of this system will give opportunities for invention and manufacture such as have never presented themselves before.

Knowing the far-reaching importance of this first attempt and its effect upon future development, I shall proceed slowly and carefully. Experience has taught me not to assign a term to enterprises the consummation of which is not wholly dependent on my own abilities and exertions. But I am hopeful that these great realizations are not far off, and I know that when this first work is completed they will follow with mathematical certitude.

When the great truth accidentally revealed and experimentally confirmed is fully recognized, that this planet, with all its appalling immensity, is to electric currents virtually no more than a small metal ball and that by this fact many possibilities, each baffling imagination and of incalculable consequence, are rendered absolutely sure of accomplishment; when the first plant is inaugurated and it is shown that a telegraphic message, almost as secret and non-interferable as a thought, can be transmitted to any terrestrial distance, the sound of the human voice, with all its intonations and inflections, faithfully and instantly reproduced at any other point of the globe, the energy of a waterfall made available for supplying light, heat or motive power, anywhere-on sea, or land, or high in the air-humanity will be like an ant heap stirred up with a stick: See the excitement coming!

9 The True Meaning of Wireless Transmission of Power

Toby Grotz

Reprinted from Tesla: A Journal of Modern Science, 1997

Abstract

Many researchers have speculated on the meaning of the phrase "non-Hertzian waves" as used by Dr. Nikola Tesla.¹ Dr. Tesla first began to use this term in the mid 1890's in order to explain his proposed system for the wireless transmission of electrical power. In fact, it was not until the distinction between the method that Heinrich Hertz was using and the system Dr. Tesla had designed, that Dr. Tesla was able to receive the endorsement of the renowned physicist, Lord Kelvin.[1] To this day, however, there exists a confusion amongst researchers, experimentalists, popular authors and laymen as to the meaning of non-Hertzian waves and the method Dr. Tesla was promoting for the wireless transmission of power. In this paper, the terms pertinent to wireless transmission of power will be explained and the methods being used by present researchers in a recreation of the Tesla's 1899 Colorado Springs experiments will be defined.

Early Theories of Electromagnetic Propagation

In pre-World War I physics, scientists postulated a number of theories to explain the propagation of electromagnetic energy through the ether. There were three popular theories present in the literature of the late 1800's and early 1900's. They were:

1. Transmission through or along the Earth,
2. Propagation as a result of terrestrial resonances,
3. Coupling to the ionosphere using propagation through electrified gases.

We shall concern our examination at this time to the latter two theories as they were both used by Dr. Tesla at various times to explain his system of wireless transmission of power. It should be noted, however, that the first theory was supported by Fritz Lowenstein, the first vice-president of the Institute of Radio Engineers, a man who had the enviable experience of assisting Dr. Tesla during the Colorado Springs experiments of 1899. Lowenstein presented what came to be known as the "gliding wave" theory of electromagnetic radiation and propagation during a lecture before the IRE in 1915. (Fig. 1)

Dr. Tesla delivered lectures to the Franklin Institute at Philadelphia, in February, 1983, and to the National Electric Light Association in St. Louis, in March, 1983, concerning electromagnetic wave propagation. The theory presented in those lectures proposed that the Earth could be considered as a conducting sphere and that it could support a large electrical

¹ An honorary doctorate degree, was awarded Nikola Tesla in June, 1894 from Columbia College in the City of New York (Source: Columbia University Archives) - Ed. note.

charge. Dr. Tesla proposed to disturb the charge distribution on the surface of the Earth and record the period of the resulting oscillations as the charge returned to its state of equilibrium. The problem of a single charged sphere had been analyzed at that time by J. J. Thompson and A.G. Webster in a treatise entitled "The Spherical Oscillator." This was the beginning of an examination of what we may call the science of terrestrial resonances, culminating in the 1950's and 60's with the engineering of VLF radio systems and the research and discoveries of W.O. Schumann and J.R. Waite.

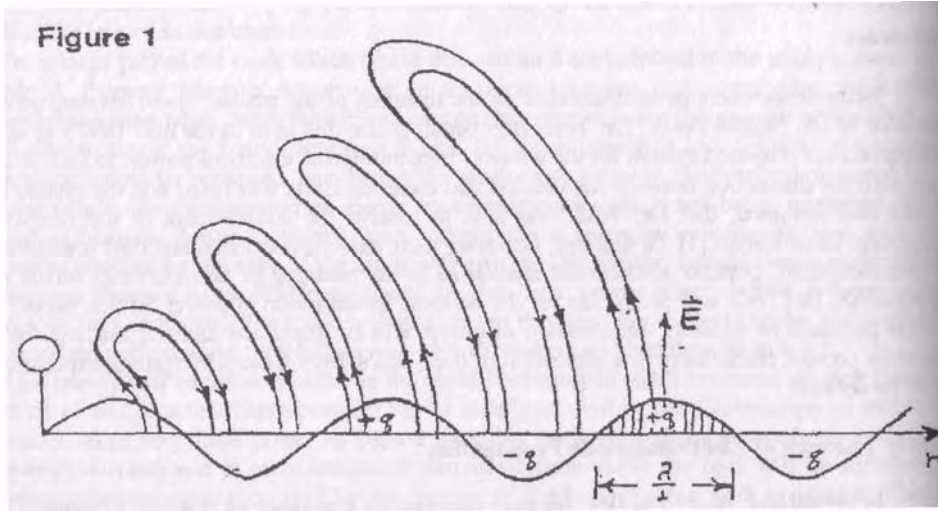

Sketch used by Fritz Lowenstein in his 1915 IRE lecture to explain the mechanism of radiation and propagation for radio waves. "...Q [is] the charge in the antenna and... q the electric charge of each half wave length gliding along the earth..." Even Zenneck was prepared to accept Lowenstein's explanation. Lowenstein believed that charge q was detached from the antenna and floated off along the ground as a "gliding wave."⁵

— Tesla Primer and Handbook, Chapter 2.

The second method of energy propagation proposed by Dr. Tesla was that of the propagation of electrical energy through electrified gases. Dr. Tesla experimented with the use of high frequency RF currents to examine the properties of gases over a wide range of pressures. It was determined by Dr. Tesla that air under a partial vacuum could conduct high frequency electrical currents as well or better than copper wires. If a transmitter could be elevated to a level where the air pressure was on the order of 75 to 130 millimeters in pressure and an excitation of megavolts was applied, it was theorized that; "...the air will serve as a conductor for the current produced, and the latter will be transmitted through the air with, it may be, even less resistance than through an ordinary copper wire". (Fig. 2)

Figure 2

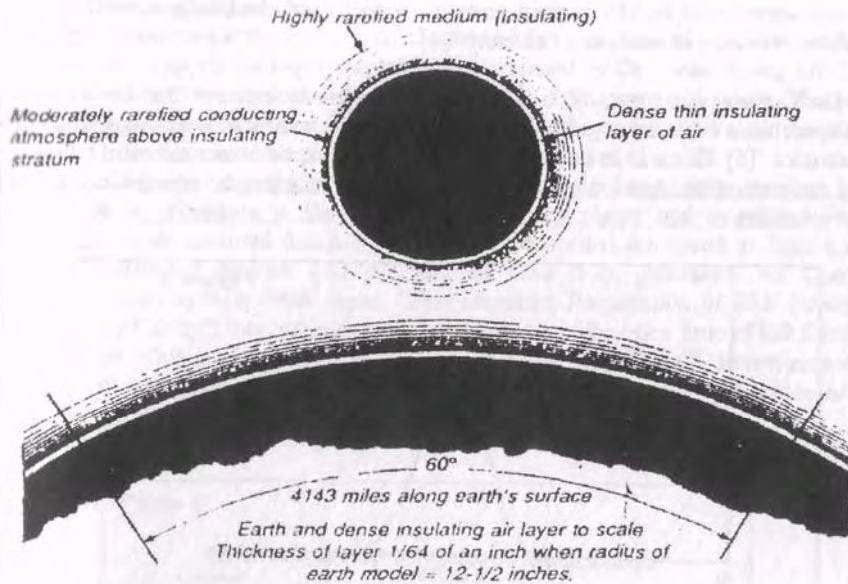

A section of the Earth and its atmospheric envelope drawn to scale. "It is obvious that the Hertzian rays cannot traverse so thin a crack between two conducting surfaces for any considerable distance without being absorbed," says Dr. Tesla, in discussing the Ether Space Wave Theory.

— *Electrical Experimenter*, Feb. 1919.

Resonating Planet Earth

Dr. James T. Corum and Kenneth L. Corum, in Chapter 2 of their book, *A Tesla Primer*, point out a number of statements made by Dr. Tesla which indicate that he was losing resonator fields and transmission line modes.

1. When he speaks of tuning his apparatus until Hertzian radiations have been eliminated, he is referring to using ELF vibrations: "...the Hertzian effect has gradually been reduced through the lowering of frequency." [3]

2. "...the energy received does not diminish with the square of the distance, as it should, since the Hertzian radiation propagates in a hemisphere." [3]

3. He apparently detected resonator or standing wave modes: "...my discovery of the wonderful law governing the movement of electricity through the globe...the projection of the

wavelengths (measured along the surface) on the earth's diameter or axis of symmetry...are all equal." [3]

4. "We are living on a conducting globe surrounded by a thin layer of insulating air, above which is a rarefied and conducting atmosphere...The Hertz waves represent energy which is radiated and unrecoverable. The current energy, on the other hand, is preserved and can be recovered, theoretically at least, in its entirety." [4]

As Dr. Corum points out, "The last sentence seems to indicate that Tesla's Colorado Springs experiments could be properly interpreted as characteristic of a wave-guide probe in a cavity resonator." [5] This was in fact what led Dr. Tesla to report a measurement which to this day is not understood and has led many to erroneously assume that he was dealing with faster than light velocities.

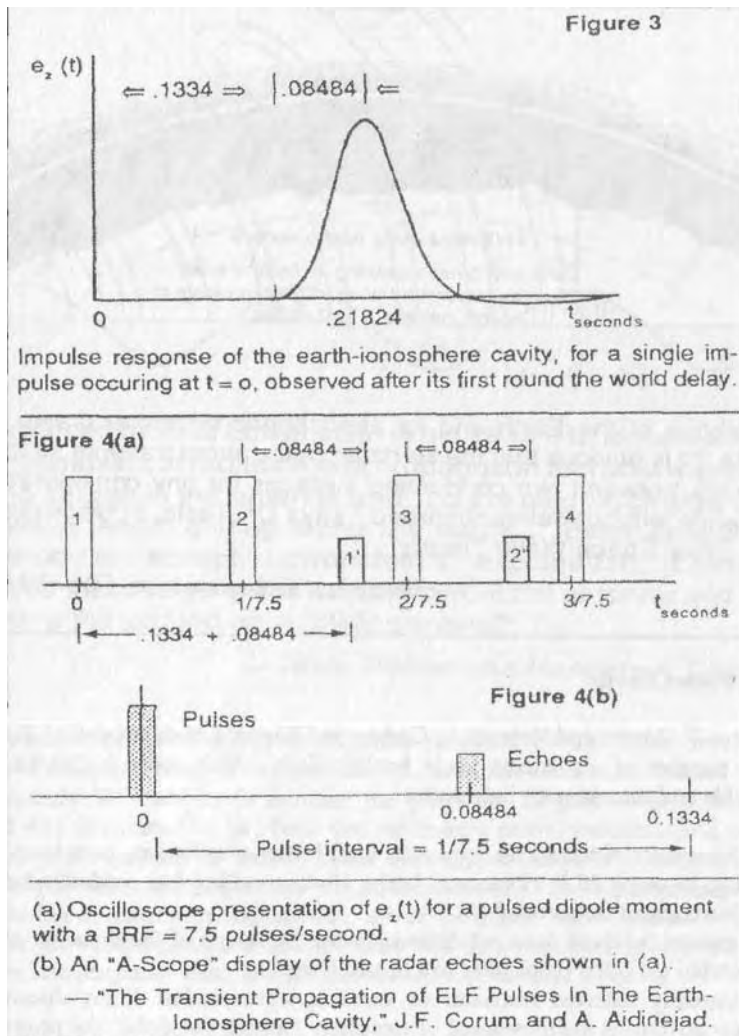

The controversial Measurement

The mathematical models and experimental data used by Schumann and Waite to describe ELF transmission and propagation are complex and beyond the scope of this paper. Dr. James F. Corum, Kenneth L. Corum and Dr. A-Hamid Aidinejad have, however, in a series of papers presented at the 1984 Tesla Centennial Symposium and the 1986 International Tesla Symposium, applied the experimental values obtained by Dr. Tesla during his Colorado Springs experiments to the models and equations used by Schumann and Waite. The results of this exercise have proved that the Earth and the surrounding atmosphere can be used as a cavity resonator for the wireless transmission of electrical power. (Fig. 3)

Dr. Tesla reported that 0.08484 seconds was the time that a pulse emitted from his laboratory took to propagate to the opposite side of the planet and to return. From this statement many have assumed that his transmissions exceeded the speed of light and many esoteric and fallacious theories and publications have been generated. As Corum and Aidinejad point out, in their 1986 paper, "The Transient Propagation of ELF Pulses in the Earth Ionosphere Cavity", this measurement represents the coherence time of the Earth cavity resonator system. This is also known to students of radar systems as a determination of the range dependent parameter. The accompanying diagrams from Corum's and Aidinejad's paper graphically illustrate the point. (Fig. 4 & Fig. 5)

Figure 4

COMPARISON OF PHYSICAL PARAMETERS

Physical Parameter	Accepted Experimental Values	Predicted from Tesla's Disclosures
1. Attenuation Constant (dB/Mm)	$.20 \leq \alpha \leq .30$.26
2. Resonant Frequency (Hz)	$6.8 \leq f_0 < 7.8$	6
3. Cavity Q	$3.8 \leq Q \leq 7.8$	$3.2 \leq Q \leq 6.4$
4. Coherence Time (sec.)	no data available	0.08484
5. Phase Velocity	$.71 \leq V_1 \leq .83$	0.8
6. Cavity Mode Structure	$P_n (\cos \theta)$	"Projections of all the stationary nodes onto the earth's diameter are equal."
7. Cavity Thickness (Km)	$35 \leq h \leq 80$	{ "greater than 8 Km" "about 20 Km"

— "A Physical Interpretation of the Colorado Springs Data,"
Proceedings of the Tesla Centennial Symposium, 1984.

Figure 5

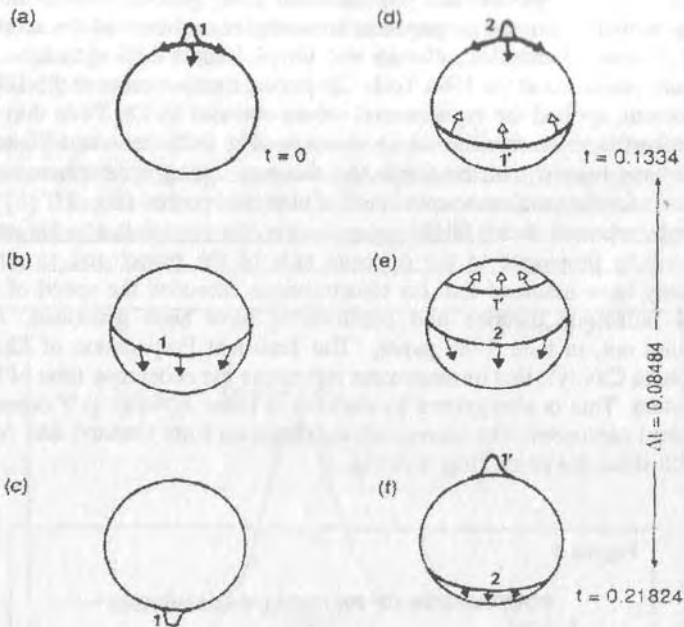

The sequence of events following the emission of pulses at the North Pole.

- (a) The first pulse emitted at $t = 0$.
- (b) The propagating disturbance 0.0444 seconds later.
- (c) The propagating pulse refocuses at the antipode at $t = 0.08737$ seconds.
- (d) The pulse energy propagates northward and is at the position shown, now called 1', at $t = 1/7.5$ seconds. At this same instant pulse #2 is emitted at the source.
- (e) An intermediate time after pulse #2 going southward has passed pulse #1' going northward.
- (f) At $t = 0.21824$ seconds, pulse #1' is refocused at the North Pole, having completed a terrestrial circuit. This is exactly 0.08484 seconds after pulse #2 was transmitted. Pulse #2 is shown on its southward journey.

One would, of course, employ a PRF equal to the resonant frequency of the cavity for a maximum response. It is tacitly assumed that the resonator system is linear.

—"The Transient Propagation of ELF Pulses In The Earth-Ionosphere Cavity," J. F. Corum and A. Aidinejad. Paper delivered to the 1986 International Tesla Symposium

We now turn to a description of the methods to be used to build, as Dr. Tesla did in 1899, a cavity resonator for the wireless transmission of electrical power.

PROJECT TESLA

The Wireless Transmission of Electrical Energy Using Schumann Resonance

It has been proven that electrical energy can be propagated around the world between the surface the Earth and the ionosphere at extreme low frequencies in what is known as the Schumann Cavity. The Schumann cavity surrounds the Earth between ground level and extends upward to a maximum 80 kilometers. Experiments to date have shown that electromagnetic waves of extreme low frequencies in the range of 8 Hz, the fundamental Schumann Resonance frequency, propagate with little attenuation around the planet within the Schumann Cavity. Knowing that a resonant cavity can be excited and that power can be delivered to that cavity similar to the methods used in microwave ovens for home use, it should be possible to resonate and deliver power via the Schumann Cavity to any point on Earth. This will result in practical wireless transmission of electrical power.

Background

Although it was not until 1954-1959 when experimental measurements were made of the frequency that is propagated in the resonant cavity surrounding the Earth, recent analysis shows that it was Nikola Tesla who, in 1899, first noticed the existence of stationary waves in the Schumann cavity. Tesla's experimental measurements of the wave length and frequency involved closely match Schumann's theoretical calculations. Some of these observations were made in 1899 while Tesla was monitoring the electromagnetic radiations due to lightning discharges in a thunderstorm which passed over his Colorado Springs laboratory and then moved more than 200 miles eastward across the plains. In his Colorado Springs Notes, Tesla noted that these stationary waves "... can be produced with an oscillator," and added in parenthesis, "This is of immense importance. "[6] The importance of his observations is due to the support they lend to the prime objective of the Colorado Springs laboratory. The intent of the experiments and the laboratory Tesla had constructed was to prove that wireless transmission of electrical power was possible.

Schumann Resonance is analogous to pushing a pendulum. The intent of Project Tesla is to create pulses or electrical disturbances that would travel in all directions around the Earth in

the thin membrane of non- conductive air between the ground and the ionosphere. The pulses or waves would follow the surface of the Earth in all directions expanding outward to the maximum circumference of the Earth and contracting inward until meeting at a point opposite to that of the transmitter. This point is called the anti-pode. The traveling waves would be reflected back from the anti-pode to the transmitter to be reinforced and sent out again.

At the time of his measurements Tesla was experimenting with and researching methods for "...power transmission and transmission of intelligible messages to any point on the globe." Although Tesla was not able to commercially market a system to transmit power around the globe, modern scientific theory and mathematical calculations support his contention that the wireless propagation of electrical power is possible and a feasible alternative to the extensive and costly grid of electrical transmission lines used today for electrical power distribution.

The Need for a Wireless System of Energy Transmission

A great concern has been voiced in recent years over the extensive use of energy, the limited supply of resources, and the pollution of the environment from the use of present energy conversion systems. Electrical power accounts for much of the energy consumed. Much of this power is wasted during transmission from power plant generators to the consumer. The resistance of the wire used in the electrical grid distribution system causes a

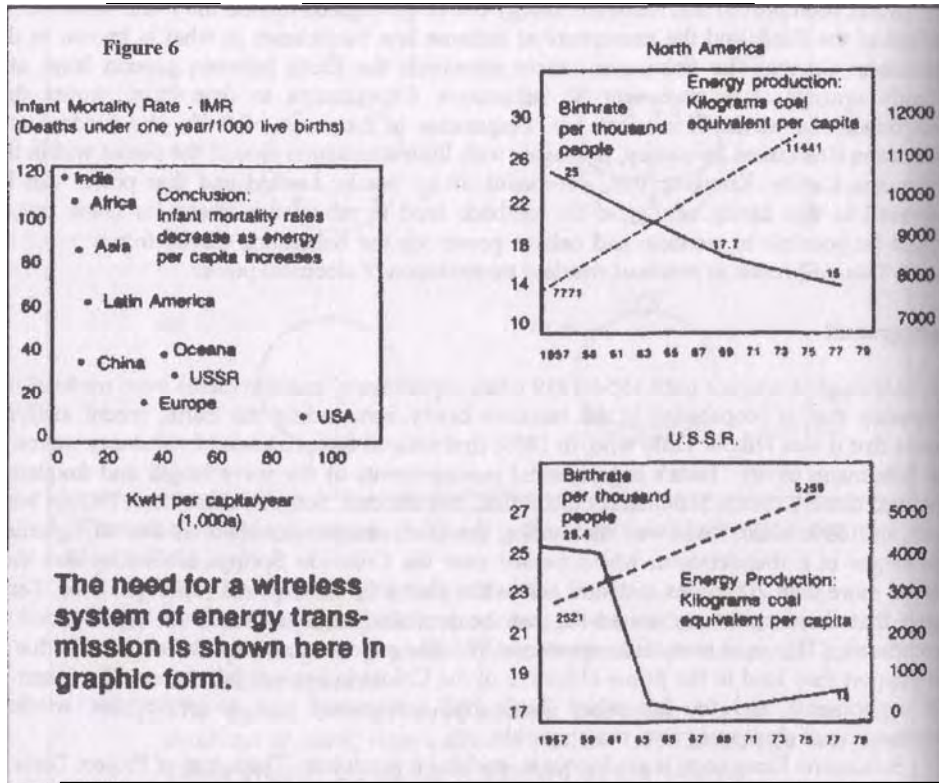

loss of 26-30% of the energy generated. This loss implies that our present system of electrical distribution is only 70-74% efficient (true only in the 1980's; today it is much worse. - Ed. note). A system of power distribution with little or no loss would conserve energy. It would reduce pollution and expenses resulting from the need to generate power to overcome and compensate for losses in the present grid system.

The proposed project would demonstrate a method of energy distribution calculated to be 90-94% efficient. An electrical distribution system, based on this method would eliminate the need for an inefficient, costly, and capital intensive grid of cables, towers, and substations. The system would reduce the cost of electrical energy used by the consumer and rid the landscape of wires, cables, and transmission towers.

There are areas of the world where the need for electrical power exists, yet there is no method for delivering power. Africa is in need of power to run pumps to tap into the vast resources of water under the Sahara Desert. Rural areas, such as those in China, require the

electrical power necessary to bring them into the 20th century and to equal standing with western nations. As first proposed by Buckminster Fuller, wireless transmission of power would enable world wide distribution of off peak demand capacity. This concept is based on the fact that some nations, especially the United States, have the capacity to generate much more power than is needed. This situation is accentuated at night. The greatest amount of power used, the peak demand, is during the day. The extra power available during the night could be sold to the side of the planet where it is day time. Considering the huge capacity of power plants in the United States, this system would provide a saleable product which could do much to aid our balance of payments.

MARKET ANALYSIS

Of the 56 billion dollars spent for research by the the U.S government in 1987, 64% was for military purposes, only 8% was spent on energy related research. More efficient energy distribution systems and sources are needed by both developed and under developed nations. In regards to Project Tesla, the market for wireless power transmission systems is enormous. It has the potential to become a multi-billion dollar per year market.

Market Size

The increasing demand for electrical energy in industrial nations is well documented. If we include the demand of third world nations, pushed by their increasing rate of growth, we could expect an even faster rise in the demand for electrical power in the near future. In 1971, nine industrialized nations, (with 25 percent of the world's population), used 690 million kilowatts, 76 percent of all power generated. The rest of the world used only 218 million kilowatts. By comparison, China generated only 17 million kilowatts and India generated only 15 million kilowatts (less than two percent each) [7]

If a conservative assumption was made that the three-quarters of the world which is only using one-quarter of the current power production were to eventually consume as much as the first quarter, then an additional 908 million kilowatts will be needed. The demand for electrical power will continue to increase with the industrialization of the world.

Market Projections

The Energy Information Agency (EIA), based in Washington, D.C., reported the 1985 net generation of electric power to be 2,489 billion kilowatt hours. At a conservative sale price of \$.04 per kilowatt hour that result in a yearly income of 100 billion dollars. The EIA also reported that the 1985 capacity according to generator name plates to be 656,118 million watts. This would result in a yearly output of 5,740 billion kilowatt hours at 100% utilization. What this means is that we use only about 40% of the power we can generate (an excess capability of 3,251 billion kilowatt hours). Allowing for down time and maintenance and the fact that the night time off peak load is available, it is possible that half of the excess power generation capability could be utilized. If 1,625 billion kilowatt hours were sold yearly at \$.06/kilowatt, income would total 9.7 billion dollars.

Project Tesla: Objectives

The objectives of Project Tesla are divided into three areas of investigation:
1. Demonstration that the Schumann Cavity can be resonated with an

- open air, vertical dipole antenna;
- 2. Measurement of power insertion losses.
- 3. Measurement of power retrieval losses, locally and at a distance.

Methods

A full size, 51 foot diameter, air core, radio frequency resonating coil and a unique 130 foot tower, insulated 30 feet above ground, have been constructed and are operational at an elevation of approximately 11,000 feet. This system was originally built by Robert Golka in 1973-1974 and used until 1982 by the United States Air Force at Wendover AFB in Wendover, Utah. The USAF used the coil for simulating natural lightning for testing and hardening fighter aircraft. The system has a capacity of over 600 kilowatts. The coil, which is the largest part of the system, has already been built, tested, and is operational. A location at a high altitude is initially advantageous for reducing atmospheric losses which work against an efficient coupling to the Schumann Cavity. The high frequency, high voltage output of the coil will be half wave rectified using a uniquely designed single electrode X-ray tube. The X-ray tube will be used to charge a 130 ft. tall, vertical tower which will function to provide a vertical current moment. The mast is topped by a metal sphere 30 inches in diameter. X-rays emitted from the tube will ionize the atmosphere between the Tesla coil and the tower. This will result in a low resistance path causing all discharges to flow from the coil to the tower. A circulating current of 1,000 amperes in the system will create an ionization and corona causing a large virtual electrical capacitance in the medium surrounding the sphere. The total charge around the tower will be in the range of between 200-600 coulombs. Discharging the tower 7-8 times per second through a fixed or rotary spark gap will create electrical disturbances, which will resonantly excite the Schumann Cavity, and propagate around the entire Earth.

The propagated wave front will be reflected from the antipode back to the transmitter site. The reflected wave will be reinforced and again radiated when it returns to the transmitter. As a result, an oscillation will be established and maintained in the Schumann Cavity. The loss of power in the cavity has been estimated to be about 6% per round trip. If the same amount of power is delivered to the cavity on each cycle of oscillation of the transmitter, there will be a net energy gain which will result in a net voltage, or amplitude increase. This will result in reactive energy storage in the cavity. As long as energy is delivered to the cavity, the process will continue until the energy is removed by heating, lightning discharges, or as is proposed by this project, loading by tuned circuits at distant locations for power distribution.

The resonating cavity field will be detected by stations both in the United States and overseas. These will be staffed by engineers and scientists who have agreed to participate in the experiment. Measurement of power insertion and retrieval losses will be made at the transmitter site and at distant receiving locations. Equipment constructed especially for measurement of low frequency electromagnetic waves will be employed to measure the effectiveness of using the Schumann Cavity as a means of electrical power distribution.

The detection equipment used by project personnel will consist of a pick up coil and industry standard low noise, high gain operational amplifiers and active band pass filters. In addition to project detection there will be a record of the experiment recorded by a network of monitoring stations that have been set up specifically to monitor electromagnetic activity in the Schumann Cavity.

Evaluation Procedure

The project will be evaluated by an analysis of the data provided by local and distant measurement stations. The output of the transmitter will produce a 7-8 Hz sine wave as a result of the discharges from the antenna. The recordings made by distant stations will be time

synchronized to ensure that the data received is a result of the operation of the transmitter.

Power insertion and retrieval losses will be analyzed after the measurements taken during the transmission are recorded. Attenuation, field strength, and cavity Q will be calculated using the equations presented in Dr. Corum's papers. These papers are noted in the references. If recorded results indicate power can be efficiently coupled into or transmitted in the Schumann Cavity, a second phase of research involving power reception will be initiated.

Environmental Considerations

The extreme low frequencies (ELF), present in the environment have several origins.

The time varying magnetic fields produced as a result of solar and lunar influences on ionospheric currents are on the order of 30 nanoteslas (nT).² The largest time varying fields are those generated by solar activity and thunderstorms. These magnetic fields reach a maximum of 0.5 microteslas (uT) The magnetic fields produced as a result of lightning discharges in the Schumann Cavity peak at 7, 14, 20 and 26 Hz.

The magnetic flux densities associated with these resonant frequencies vary from 0.25 to 3.6 picoteslas per root hertz (pT/Hz^{1/2}). Exposure to man made sources of ELF can be up to 1 billion (1000 million or 1×10^9) times stronger than that of naturally occurring fields.

Household appliances operated at 60 Hz can produce fields as high as 2.5 milliTesla (mT).

The field under a 765 kV, 60 Hz power line carrying 1 amp per phase is 15 uT. ELF antennae systems that are used for submarine communication produce fields of 20 uT. Video display Terminals produce fields of 2 uT, 1,000,000 times the strength of the Schumann Resonance frequencies [9].

Project Tesla will use a 150 kW generator to excite the Schumann cavity. Calculations predict that the field strength due to this excitation at 7.8 Hz will be on the order of 46 picoteslas.

Future Objectives

The successful resonating of the Schumann Cavity and wireless transmission of power on a small scale resulting in proof of principle will require a second phase of engineering, the design of receiving stations. On completion of the second phase, the third and fourth phases of the project involving further tests and improvements and a large scale demonstration project will be pursued to prove commercial feasibility. Total cost from proof of principle to commercial prototype is expected to total \$3 million.

The unit of magnetic induction, formerly "Webers per meter squared" is now a "Tesla." It equals 10,000 gauss, which is a commonly used, smaller unit for magnets and "gaussmeters." - Ed. note

Project Tesla

It has been proven that electrical energy can be propagated around the world between the surface of the

Earth and the ionosphere at extreme low frequencies in what is known as the Schumann Cavity.

Experiments to date have shown that electromagnetic waves of extreme low frequencies in the range of 8 Hz, the fundamental Schumann Resonance frequency, propagate with little attenuation around the planet within the Schumann Resonance Cavity.

The purpose of Project Tesla is to create pulses, or electrical disturbances, that would travel in all directions around the Earth and resonate in the thin membrane of nonconductive air between the ground and the ionosphere in the Schumann Cavity. The pulses, or waves, would follow the surface of the Earth expanding outward to the maximum circumference of the Earth, until meeting at a point opposite to that of the transmitter. This point is called the antipode. The traveling waves would be reflected from the antipode to the transmitter, be reinforced, and sent out again. This process, analogous to pushing a pendulum, would be repeated at 8.0 Hz, the resonant frequency of the Schumann Cavity. This is the basis for the wireless transmission of power. Tesla, Inc. has determined the exact method Nikola Tesla used to prove the feasibility of the wireless transmission of power during his experiments in Colorado Springs and the difference between that and the method he intended to use in the Wardencliff Laboratory. This information will facilitate the successful wireless



transmission of electrical power.

The need for a wireless system of energy transmission

There are areas of the world where the need for electrical power exists, yet there is no method for delivering power. Africa is in need of power to run pumps to tap into the vast resources of water under the Sahara Desert. Rural areas, such as those in China, require the electrical power necessary to bring them into the 20th Century and to equal standing with western nations. More than three billion people on this planet do not enjoy the access to electrical power that we in developed nations take for granted.

As first proposed by Buckminster Fuller, wireless transmission of power would enable world-wide distribution of off-peak demand capacity. This concept is based on the fact that some nations, especially the

United States, have the capacity to generate much more power than is needed.

This situation is accentuated at night. The greatest amount of power use, the peak demand, is during the day. The extra power available during the night could be sold to the side of the planet where it is daytime. Considering the huge capacity of power plants in the United States, this system would provide a saleable product which could do much to aid balance of payments while raising the standard of living in Third World countries.

Environmental considerations

The extreme low frequencies (ELF), present in the environment have several origins. The time-varying magnetic fields produced as a result of solar and lunar influences on ionospheric currents are on the order of 30 nanoteslas. The largest time varying fields are those generated by solar activity and thunderstorms.

“So astounding are the facts in this connection, that it would seem as though the Creator, himself, had electrically designed this planet...”

— Nikola Tesla describing what is now known as Schumann Resonance (7.8Hz) in “The Transmission of Electrical Energy Without Wires As A Means Of Furthering World Peace,” *Electrical World and Engineer*, Jan. 7, 1905, pp. 21-24.

REFERENCES

1. Tesla Said, Compiled by John T. Ratzlaff, Tesla Book Company, Millbrae, CA, 1984.
2. Dr. Nikola Tesla: Selected Patent Wrappers, compiled by John T. Ratzlaff, Tesla Book Company, 1980, Vol. I, Pg. 128.
3. "The Disturbing Influence of Solar Radiation on the Wireless Transmission of Energy", by Nikola Tesla, Electrical Review, July 6, 1912, PP. 34, 35.
4. "The Effect of Static on Wireless Transmission", by Nikola Tesla, Electrical Experimenter, January 1919, PP. 627,658.
5. Tesla Primer and Handbook, Dr. James T. Corum and Kenneth L. Corum, unpublished. Corum Associates, 8551 ST Rt 534, Windsor, Ohio 44099
6. Colorado Springs Notes, 1899 - 1900, Nikola Tesla, Nikola Tesla Museum, Beograd, Yugoslavia, 1978, Pg. 62.
7. Van Nostrands Scientific Encyclopedia, Fifth Edition, Pg. 899.
8. "PC Monitors Lightning Worldwide", Davis D. Sentman, Computers in Science, Premiere Issue, 1987.
9. "Artificially Stimulated Resonance of the Earth's Schumann Cavity Waveguide", Toby Grotz, Proceedings of the Third International New Energy Technology Symposium/Exhibition, June 25th-28th, 1988, Hull, Quebec, Planetary Association for Clean Energy, 191 Promenade du Portage/600, Hull, Quebec J8X 2K6 Canada

ABOUT THE AUTHOR

Mr. Grotz, is an electrical engineer and has 15 years experience in the field of geophysics, aerospace and industrial research and design. While working for the Geophysical Services Division of Texas Instruments and at the University of Texas at Dallas, Mr. Grotz was introduced to and worked with the geophysical concepts which are of importance to the proposed project. As a Senior Engineer at Martin Marietta, Mr. Grotz designed and supervised the construction of industrial process control systems and designed and built devices and equipment for use in research and development and for testing space flight hardware. Mr. Grotz, organized and chaired the 1984 Tesla Centennial Symposium and the 1986 International Tesla Symposium and was President of the International Tesla Society, a not for profit coporation formed as a result the first symposium. As Project Manager for Project Tesla, Mr. Grotz aided in the design and construction of a recreation of the equipment Nikola Tesla used for wireless transmission of power experiments in 1899 in Colorado Springs. Mr. Grotz received his B.S.E.E. from the University of Connecticut in 1973. He can be reached at 760 Prairie Ave., Craig, CO 81625, wireless @ rmi.net

10 Tesla's Self-Sustaining Electrical Generator

Oliver Nichelson

Adapted from Proceedings of the Tesla Centennial Symposium, 1984

Abstract

Before the discovery of the electron, the principle theory used to describe the electrical activity was that of the ether. At the turn of this century, the ether theory in use by science was a remnant of the concept common in western thought for several centuries. This situation favored the rise of atomic theory. This change in scientific paradigm requires a translation from 19th century terminology into 20th century language in order to understand Tesla's later research. Of particular interest is his magnifying transformer which claimed to produce resistanceless current.

The Historical Ether

Though science aims at giving accurate descriptions of the workings of nature, these descriptions change from historical period to historical period. In the same way that an object in one European country is called by a different name in an adjoining European country, so do the descriptions of nature change during different periods of man's history. In the 19th century western science the broadest view of the physical world was that all objects were somehow each connected to one another through pre-material ether. Solid bodies were believed to be made from condensation of this ether. In this worldview, atoms and electrons did not exist as scientific realities.

Toward the end of the last century the atomic picture of the world emerged in steps. Solid bodies were explained by minute vortices in the ether - small whirlpools - forming lumps of matter. Lord Kelvin, the virtual spokesman of Victorian science, developed an ether vortex model of the electron in an effort to explain some of the properties of electricity. The electron as a discrete particle did not become a fact of science until Thompson discovered it in 1897.

The view of nature as a single entity formed out of the ether changed to the modern one of matter being made of collections of individual particles in 1905 [1]. In that year, Einstein presented his paper on Brownian motion explaining the movement of pollen particles on the surface of water in terms of discrete units of matter. From then until today, the atomic view has prevailed.

This difference between the 19th century description of nature and our presented description makes it difficult to have a complete picture of the work of the early electrical researchers. Today, Faraday, Maxwell and Tesla are recognized as valued contributors of the understanding of electricity, but their work was carried out before the electron- the fundamental carrier of electrical charge - was discovered. All of these scientist held a belief in an physical ether. Though Faraday's laws of induction are still accepted, and Maxwell's equations from electromagnetism are still used routinely, and Tesla's generators are still powering our lights, the 19th century physics that they learned and out of which their physics came, has been judged scientifically wrong.

The curious situation in which Faraday, Maxwell and Tesla can be seen be both right in their results but wrong in their beliefs about physics comes from an inability to translate the concepts of their historical periods into the language of our period. This lack of chronological translation, in contract to the spatial translation between European languages, is also an obstacle to understanding the physics of self-sustaining electrical ("free energy") generators based on the 19th century views.

In the last half of the 19th century, when researchers had to deal with the ether in practical engineering terms in order to guild their electrical devices, the concept of the ether then, several centuries old, was a watered down theory. At that time, the ether was considered something like a thin gas that could be found everywhere. However, that was not a historically correct view of the ether.

The ether had been pictured traditionally as a non-material substance capable of condensing into ponderable matter. Gas, no matter how thin, is still ponderable matter; and because of that, could not qualify as the ether.

To find out what was meant historically by the concept of ether, an early writer on the subject can be cited. Robert Fludd, in 1659 described the "Ethereicall...influences" as "far subtler condition than is the vehicle of visible light... so thin, so mobile, so penetrating, so lively, that they are able, and also do continually penetrate, and that without manifest obstacles or resistance, even unto the center or inward bosom of the earth where they generate metals of sundry kinds." [2]

Fludd quotes an even older source on the nature of ether, the writings of Plotinus (3rd Century AD) where the ether is described as being so fine "that it doth penetrate all bodies and... it maketh them not a jot bigger for all that because this inward spirit doth nourish and preserve all bodies." [3]

From these older descriptions of the ether, the following attributes can be seen missing from the late 19th century concept. First, the ether was held to be truly non-material - it does not make bodies "a jot bigger". If the ether were a gas, its addition to anything would be measurable. Second, the ether is a substance less material than "the vehicle of visible light", that is, something less than what today is known as a photon. Third, the ether was credited with generating metals and nourishing all bodies, clearly a distinct property not belonging to gases.

Whether or not the reality of the ether as put forth by these authors is accepted, it is historical fact that the tether Michelson and Moraly did not find in their experiments and that the modern atomists ridiculed so strongly when they came to scientific power in the early 20th century was never claimed to exist by people who first used the term. Taking a longer view of science, modem theorists fought a battle against an issue that never existed.

If, on the other hand, the ether is looked at in the earlier description of its properties, something can be learned about the operation of a least one type of self sustaining electrical generator. To do this, the ether concept has to be translated into an artifact of contemporary science.

The Modern Ether

The properties of having less mass than a massless photon, being able to interpenetrate a body but not add to it, and generating material bodies are encompassed in the modern view of the quantum wave nature of matter. In quantum theory, an object can be viewed as either made of particles or waves. It is not an idea everyone is comfortable with even now but one that is widely accepted and known to be verifiable by experiment. Transistors, tunnel diodes

and even digital watches are a few of the real world objects operating on physical principles that are explained best by the quantum wave nature of matter.

If an object can be both a quantum wave and a particle, then in its wave state, it can be said to interpenetrate an object without making it "a jot bigger". Also, being a wave equivalent to a particle, the wave would not have the mass of a particle. It has amplitude instead. The quantum wave is also responsible for the generation of solid bodies. Present theory has it that a particle exists in its quantum wave state until a measurement is made, when the wave is then said, to collapse to form an object. The collapse of the quantum wave defines the state of the object, that is, it generates the particle.

The quantum wave state of nature very much resembles the 17th century picture of the ether.

With this conceptual parallel in mind, it is possible to understand better the work of Nikola Tesla, who held the ether theory as a scientific concept, who, also on the basis of this theory, built working electrical machines, and who is associated with the idea of an electrical generator which could maintain a current without an external prime mover.

Schooled during the 1860's, Nikola Tesla's understanding of physics was pre-atomic. In his biographical articles Tesla does not comment on the theoretical aspects of his education, but in his technical writings, he uses the term "the ether" in a positive sense and only in his later writings are found grudging references to atomic particles and electrons.

Tesla's Magnifying Transformer

Tesla's most famous device was what he called a Magnifying Transformer, the principal tests of which were carried out in Colorado Springs during 1899. The device is described in his U.S. Patent as an "Apparatus for Transmitting Electrical Energy" [4] and claims some unusual characteristics among which were the propagation of waves faster than the speed of light, the transmission of signals, not around the earth, but through the earth, and doing this by eliminating as much as possible electromagnetic waves - the only electrically related waves known today capable of transmitting signals.

Tesla did this using a coil with 10,000 - 11,000 feet of cable [5], with what he claimed so be little or no resistance. This last fact, giving rise to the belief that in addition to its other unusual characteristics, the device had the property of maintaining its current for a measurable period of time after disconnection from an outside power source.

Taking these ideas together — that the ether is equivalent to quantum wave energy, that Tesla held a belief in a physical ether, and that Tesla built a device capable of maintaining an electrical current without an external prime mover, a conclusion that can be reached, is that the quantum wave theory can be used to understand the dynamics of Tesla's magnifying transformer. This follows from the work of Dr. Andrija Puharich who, in a 1976 paper, put forth the idea that the magnifying transformer could not be explained by the laws of classical electrodynamics, but, rather in terms of high energy particle transformations [6].

The wave theory of matter gained its present popularity in 1923 through the efforts of de Broglie. When experiments showed that light could be considered both a particle and a wave he reasoned that an electron, clearly a particle, could behave like a wave. He deduced the wavelength of the electron from the equation $E=hf$ which equates the energy of a particle to the product of Planck's constant times the frequency. (λ works out to be 2.4×10^{-12} meters, which is the classical wavelength for the electron.)

In analyzing the Tesla magnifying transformer, this mathematical relationship can be used to determine the quantum energy of a wave in the transformer's operating frequency (here we use the pulse repetition rate of 7.5 Hz, following Corum [10] instead of the author's originally

suggested kilohertz. oscillation frequency - Ed. note) and putting that value into the equation gives:

$$E = hf = (6.63 \times 10^{-34} \text{ Js}) (7.5 \text{ Hz}) \quad (1)$$

$$E = 4.97 \times 10^{-33} \text{ J/e}$$

which would be the radiated energy per accelerated charge carrier (electron) in the conductor.

If the magnifying transmitter were operating at a current $I = 100$ amperes, the total charge can be found. Current is charge per time ($I = q / t$) and by definition, 1 Ampere = 1 Coulomb / second. This relationship can be used in turn to determine the number of charge carriers per second in the conductor for a 100 A current:

$$I = \frac{100 \text{ C/s}}{1.6 \times 10^{-19} \text{ C/e}} \quad (2)$$

$$I = 6.25 \times 10^{20} \text{ electrons per second} \quad (3)$$

The total number of charge carriers times the emitted energy per charge carrier would equal the quantum energy of the wave at a given frequency (7.5 Hz in this case):

$$E_Q = EI = (6.25 \times 10^{20} \text{ e/s}) (4.97 \times 10^{-33} \text{ J/e}) \quad (4)$$

$$= 3.1 \times 10^{-12} \text{ J/s} = 3.1 \text{ picowatts}$$

If the highest reported current that Tesla used, 1000 amperes, is put into the calculation, the energy range would be $3.1 \times 10^{-12} \text{ J/s}$ to $31 \times 10^{-12} \text{ J/s}$.

Converting to a more commonly used system of measures, the energy of a quantum wave at 7.5 Hz would be:

$$e = (6.2 \times 10^{12} \text{ Mev / J})(3.1 \times 10^{-12} \text{ J/s}) \quad (5)$$

$$= 19 \text{ Mev}$$

If the highest current of 1000 amperes is put into the calculation, the energy of a quantum wave would be 190 Mev.¹

In order to generate a wave of this energy, an electron would have to undergo a potential difference in the range of 19 to 190 million volts.

Tesla's magnifying transformer was reported to operate in the range of tens of millions of volts. At 20 million volts there would be more than sufficient electrical force to create a

¹ Compare to Corum [10] who calculate about 225 coulombs in a volume of 10,000 cubic meters of glow discharge. Using 2.5 eV per molecule of air, the amount of power Tesla used for a pulse repetition rate of 7.5 Hz is found to be only 6.5 hp, consistent with what Tesla reported. For reasons explained in the article, the Corums find that Tesla generated 10 MeV electrons at 1000 amperes.

vacuum wave for the amount of charge in motion at 7.5Hz. At 200 million volts there would be enough force to produce such a wave for a current of 1000 amperes at that frequency. The generation of a quantum wave by the magnifying transformer goes a long way in explaining some of the properties Tesla claimed for the device. For one, he said that electromagnetic waves were reduced to a minimum and, indeed, it would seem hard to propagate any e.m. radiation with the blunt topped tower used in his transmission experiments. If, however, the waves that were being emitted were quantum waves, or waves of the ether, his claims for radiating energy from one point to another without the use of electromagnetism becomes clear.

Also, Tesla's statement that electromagnetic radiations were similar to the waves transmitted by an ordinary whistle through the air [7] makes sense. According to his view, e.m. waves would be nothing but undulations in the atmospheric gases, while his transmissions were taking place in a wholly different medium, that of the ether.

Tesla's claim for instantaneous transmission of energy has a basis in modern theory too, for a quantum wave is non-local in nature. That is, its effect is not limited to one particular point, but, through a physical process still not completely agreed upon, the effect can be measured at great distances from the point of origin at the moment of origin.

The Superconducting State

As to maintaining a current in the transformer without an external power source, the only condition known today for achieving this, is the state of superconduction, which seemed to be ruled out in the case of Tesla's device which operated far above the almost zero temperatures needed for superconduction. However, what is understood as the superconducting state in today's science is in fact a description of the conductor. If a material has a certain type of atomic configuration and is cooled to a certain temperature, a superconducting condition exists in which a perpetual current can be maintained. The superconducting state, though, can exist without there being a current in the conductor. The state is a characteristic of the conductor.

Tesla may have discovered that superconductivity can be a property not of the conductor but of the current itself.

To examine how this might be the case, a specific model of electrical activity will be used. Instead of picturing an electric current composed of billiard ball particles or of little satellites of nuclear suns, or as an electron gas, or as electron plasma, it can be imagined as an electron liquid. At this point the make up of the liquid is not as important as is its fluid nature and that the fluid is electrical.

The model of a liquid is useful because it provides an easy example of how a substance can remain the same and yet become radically different under certain conditions. With water, when heat is removed from it, a phase change takes place which transforms it into solid ice. When thermal energy is added to water, it undergoes a different phase change and becomes a gas. The substance remains the same, but it exists in three different states.

One of the extreme states that a fluid can achieve is superfluidity during which a liquid will move up the walls of its container. This, of course, is a property of the liquid, not of the container.

Perhaps the same phase change phenomenon takes place in the electron liquid. Under certain conditions, high voltage and or high current, the electron liquid will remain the same substance but will take on radically different properties, similar to the state of superfluidity. This condition would be a state change in the current, not in whatever material is serving as the conductor.

A state of superfluidity in an electron liquid would explain how Tesla was able to send a current through the earth. When in its commonly known state a current does not travel far through the earth's resistance, but if the current has undergone the proper phase change, it could easily travel with no resistance.

Likewise, a phase changed current would travel through a generator coil with no resistance. Having undergone the change it would become a super-current in a non-superconducting conductor. Such a condition would allow a generator to maintain a current without an external power source.

This particular solution, which of course has to be tested, of Tesla's self-sustaining generators, is not an explanation of all the other similar devices such as the Figuera, Hubbard and Hendershot devices [8]. There are probably as many engineering solutions to such generators as there are inventors of them.

One characteristic all the other devices have in common in contrast to Tesla's magnifying transformer, is that they did not require the high voltage and currents Tesla used. They do not, though, represent an engineering advancement over Tesla's engineering methods.

Tesla put his main efforts into high energy devices as a matter of mere practicality in marketing a product. A year after his Colorado Springs experiments, he wrote in his Century magazine article, 1900, that he had spent a great deal of time on a smaller generator but realized that negative market pressures would not allow such a machine to see the commercial light of day [9]. And he was right; it is not possible yet to by a Hubbard or a Hendershot generator to light our homes.

Tesla believed he had a greater chance for introducing a new electrical technology if it made use of the generators then being sold, but which used their output in novel ways — which is why he concentrated on the wireless power transmission project, though even that idea proved too much for his time.

A careful study of his later writings shows that many of his more advanced concepts were based on earlier work with lower voltage versions of generators capable of maintaining a super-current. These designs appear to be based on intricate configurations of coil geometries. The peak of this line of research might have been just before the fire of his New York City laboratory in which, many of his prototypes and papers were lost. The task of uncovering the precise nature of these designs becomes very complex, because after the fire, Tesla spoke of his more advanced work only obliquely and never in detail.

Recovering these earlier designs would bring about the second stage of electrical technology - one that Nikola Tesla started, here, a century ago.

References

1. There have been several such paradigm changes in western ideas about nature. Theories alternate between a one substance universe out of which everything is made and a many substance universe in which the constituent particles are separated by a vacuum.
2. Robert Fludd, *Mosaical Philosophy*. London, Humphrey Moseley, 1659, p. 221.
3. Fludd, p. 221
4. U.S. Patent #1,119,732 of December 1, 1914; application filed January 18, 1902.

5. Nikola Tesla, Colorado Springs Notes, 1899-1900. Beograd: Nolit. 1978, p.43.
6. Andrija Puharich, "The Physics of the Tesla Magnifying Transmitter and the Transmission of Electrical Power without Wires". Planetary Association of Clean Energy, Ottawa, Ontario, 1976).
7. Nikola Tesla, quoted in the NY Herald Tribune, Sept 22, 1929, pg. 21.
8. C. Bird and O. Nichelson, "Nikola Tesla, Great Scientist, Forgotten Genius", New Age, Feb. 1977. p. 41.
9. Nikola Tesla, "On the Problems of Increasing Human Energy", in Nikola Tesla, Lectures, Patents, Articles, Biograd, Nikola Tesla Museum, 1956, p. A-143. (Also in Century, June, 1900-Ed. note)
10. Coram, James & Kenneth, "Critical Speculations Concerning Tesla's Invention and Applications of Single Electrode X-Ray Directed Discharges for Power Processing, Terrestrial Resonances and Particle Beam Weapons," Proc. Inter. Tesla Symposium, 1986, p.7-21

Oliver Nichelson can be reached at 670 W 980 N, Provo, UT 84604

11 Self-Sustained Longitudinal Waves

Robert W. Bass, Ph.D.

Reprinted from *Proceedings of the Tesla Centennial Symposium*, 1984

SELF SUSTAINED NON-HERTZIAN LONGITUDINAL WAVE OSCILLATIONS AS RIGOROUS SOLUTIONS OF MAXWELL'S EQUATIONS FOR ELECTROMAGNETIC RADIATION

In contradiction to common belief, Maxwell's classical theory of electromagnetic radiation does predict the existence of longitudinal electromagnetic waves *in vacuo*. (Longitudinal non-Hertzian compression waves are very likely to be the type that Tesla produced with the TMT. – Ed. note) This preliminary note contains what appears to be the first rigorous proof of the theoretical existence of such non-Hertzian self-sustained longitudinal wave oscillations. The E-fields and B-fields in such waves are everywhere parallel (so that the Poynting vector vanishes identically and no energy is transported along the waves, though it does appear possible in theory to transport force at a distance without attenuation via such waves *in vacuo*). The waves have the following geometry. Choose a static vector potential (A) parallel to the static magnetic field configuration of an arbitrary force-free magnetic field (B) of the type discovered in 1952 by Schluter and Lust.¹ Then pick an arbitrary frequency $\omega = \lambda c > 0$ corresponding to an arbitrary wave number $\lambda > 0$ where c is light speed, and multiply the vector potential A by $\lambda \cos \omega t$ to obtain the longitudinal wave B-field whose oscillations at frequency ω generate an E-field obtainable by multiplying the vector potential by $\omega \sin \omega t$. The vector potential and both fields are parallel and typically in infinite cylindrical or toroidal configurations as depicted in Figures 1 & 2.²

To derive, let R denote an unbounded or bounded open connected region of real Euclidian 3-space E^3 . Let the boundary ∂R of R consist of the union of piece-wise smooth 2-surfaces. Let $\lambda > 0$ denote an arbitrary

¹ R. Lust and A. Schluter, Axial symmetrische magnetohydrodynamische Gleichgewichtskonfigurationen, *Z. Naturforsch.* 12a (1957), 850-854.

² Ed. note: Compare with 'Curl-Free Vector Potentials,' R. Gelinis, *Proc. ITS 1986*, p.4-43, & Gelinis patents #4,447,779, #4,429,288, #4,429,280 on modulating/demodulating scalar waves, as well as J. Corum patents #4,622,558, #4,751,515 using toroidal fields.

positive constant wave number. Then according to potential theory, there exists on R , corresponding to every set of arbitrarily assigned Dirichlet or Neumann boundary condition on ∂R , a unique real analytic solution $\varphi = \varphi(r)$ of Helmholtz's scalar wave equation.

$$(1) \nabla^2 + \lambda^2 = 0, \quad (r \text{ in } R), \text{ on } R$$

Next, let u be an arbitrary constant unity vector in E^3 , and define frequency $\omega = \lambda c$ where c denotes light-speed.

Now define a static vector field $A = A(r)$ on R by

$$(2) A = \nabla \times (\varphi u) + (1/\lambda) \nabla \times (\nabla \times (\varphi u)).$$

Finally define

$$(3a) B = \lambda A \cos \omega t,$$

$$(3b) E = \omega A \sin \omega t.$$

Figure 1. Illustrating a force-free magnetic field having axial symmetry. The axis is itself a line of force of the field. The other lines of force shown here are helices around this line as axis (with pitch angles decreasing away from the axis)

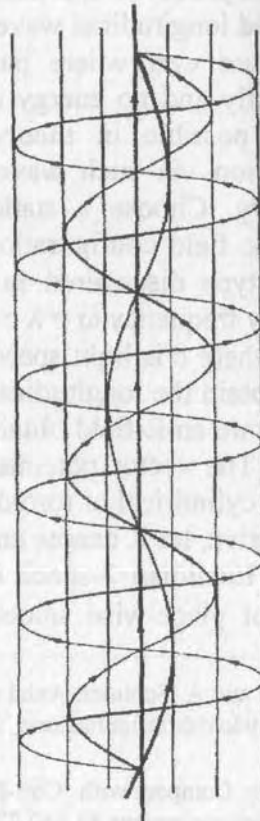

Then, using elementary vector calculus, it is easy to verify the following relationships :

$$(4) \nabla \times \mathbf{A} = \lambda \mathbf{A}$$

$$(5) \nabla \cdot \mathbf{A} = 0$$

$$(6) \nabla \times \mathbf{E} = -\partial \mathbf{B} / \partial t$$

$$(7) \nabla \times \mathbf{B} = (1/c^2) \partial \mathbf{E} / \partial t$$

$$(8) \nabla \cdot \mathbf{E} = 0$$

$$(9) \nabla \cdot \mathbf{B} = 0$$

The thus-constructed (E, B) fields on R are genuinely Maxwellian self-sustained, non-Hertzian, longitudinal electromagnetic oscillation *in vacuo*.

At each point \mathbf{r}_b on the boundary ∂R of the radiation region R, the vector potential A has a multipole expansion (analogous to a Laurent series) of the form,

$$(10) \quad \mathbf{A} = \mathbf{A}(\mathbf{r}) = \mathbf{C}(\mathbf{r} - \mathbf{r}_b), \quad (\mathbf{r} \text{ in } R \text{ near } \mathbf{r}_b),$$

defining a singular field $\mathbf{A} = \mathbf{A}(\mathbf{r})$ near \mathbf{r}_b .

This field defines a new field,

$$(11) \quad \mathbf{J} = \mathbf{J}(\mathbf{r}) = \nabla^2 \mathbf{A} + \lambda^2 \mathbf{A}, \quad (\mathbf{r} \text{ in } R \text{ near } \mathbf{r}_b),$$

such that

$$(12) \quad \mathbf{J} = \mathbf{J}(\mathbf{r}) = 0 \quad (\mathbf{r} \text{ on } R)$$

but such that a calculable limiting boundary distribution

$$(13) \quad \mathbf{J} = \mathbf{J}(\mathbf{r}_b) \neq 0$$

exists. Now on the boundary, define the current field

$$(14) \quad I = I(r_b, t) = J(r_b) \cos \omega t.$$

This current, I on ∂R will generate the previously defined longitudinal radiation waves on R .

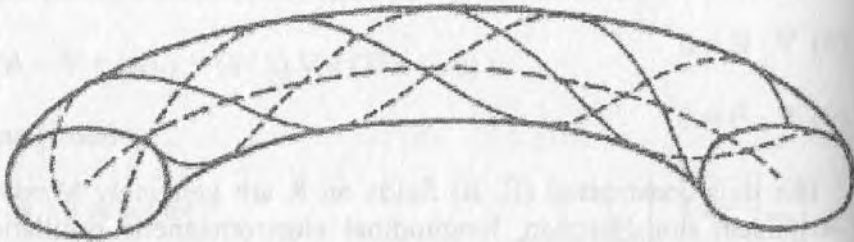

Fig 2. The lines of force of a force-free field must therefore lie on nests of torus-like surfaces, one inside the other, with a limiting curve which is itself a line of force.

Ed. note: The Bass-cited paper by *Schluter and Lust* is required reading in magnetohydrodynamic courses, such as the one at the University of Montana (PHYS 515: Plasma Physics & MHD). Sample homework assignment is below:

(<http://solar.physics.montana.edu/martens/plasma/calendar.html>)

1. Working with the MHD equations. Consider an inviscid plasma of uniform resistivity with azimuthal symmetry, that is in a state of steady (but possibly non-uniform) rotation about the z -axis and permeated with a magnetic field that has no azimuthal component.

a) Show that

$$\text{curl}(j) = [\text{curl}(v \times B)]/(\eta \cdot c)$$

where j , v , and B are vectors with the usual meaning, η is the resistivity, and c as usual the velocity of light.

b) Prove that the current is wholly azimuthal.

c) Use $\text{div} B = 0$ to show that the plasma has constant angular velocity.

$$(\omega = v_{\phi}/r)$$

2. Force-free fields. Consider the Lust and Schluter expression for force-free fields with cylindrical symmetry (i.e. axial plus azimuthal symmetry).

a) For the constant twist field, that we covered in class, derive an expression for alpha, the ratio between current and magnetic field vector.

b) The magnetic field vector is tangent to the magnetic field line at any point. Hence the tangent vector satisfies

$$\frac{r d\phi}{B_\phi} = \frac{dz}{B_z} = \frac{dr}{B_r},$$

which is the field line equation. From the solution for a constant twist field derive the number of turns in the fieldlines on an axial segment of length L.

c) Now assume alpha is constant and use that to simplify the Lust and Schluter differential equation to derive Bessel's equation. Find and sketch the solutions for B_z and B_phi.

Robert W. Bass is a physicist working for an aerospace firm and can be reached at 45960 Indian Way #612, Lexington Park, MD 20653, donquixote@radix.net

TESLA & THE MAGNIFYING TRANSMITTER

A Popular Study for Engineers

K.L. Corum

and

Dr. James Corum

Give me a long enough lever and a place to stand and I will move the Earth.

Archimedes, 287-212 BC

The 'Magnifying Transmitter' is a peculiar transformer specially adapted to excite the Earth.

Nikola Tesla, 1917

The power networks of the future may have little resemblance to those of today.

Richard P. Feynman, 1964

Introduction - Machines That Magnify

Archimedes was one of civilization's most gifted and creative intellects. His striking contributions spanned mathematics, science, invention, and optical and mechanical engineering. He is commonly recognized to have been on a level with Isaac Newton; and even Galileo claimed him as a mentor. Over a century after his death, the Roman statesman Cicero sought out Archimedes' grave stone and was touched and saddened to find that it had been overgrown with thorns and brambles.¹

Mechanics is commonly understood to be that branch of physical science which treats the effect of forces on ponderable bodies. As a science, it appears to have begun with Archimedes, who is the first one known to have worked out the theoretical principle of the lever. Other civilizations had used levers, of course, but Archimedes of Syracuse (on the Island of Sicily) was the first to state the principle.

Archimedes, the son of the astronomer Pheidias, had studied in Alexandria, but returned to his home at Syracuse for a lifetime of creative technical achievement. He solved many difficult problems in geometry, established the conceptual foundations of calculus, calculated the perimeter of the earth (yes, the world was known to be round at that time), determined that π is approximately 22/7, authored a number of books on mathematics and theoretical mechanics, and spent his life in vigorous intellectual activity. He created and developed great

instruments for agriculture and for military applications. Plutarch, Polybus, and also Livy provide colorful accounts of Archimedes, his directed energy weapons, his thundering mechanical engines of war, and the utter astonishment of both his own king (who was delighted) and the attacking Romans (who were soundly frustrated), during the siege of Syracuse.^{2,3} Apparently, Archimedes was slain while in the midst of solving an analytical problem of great significance: he didn't respond fast enough to satisfy the whims of a Roman soldier, but begged not to be interrupted for a few more minutes in order to complete a formal solution.

Machines are devices which are used to transmit and modify force and motion and to do work. Machines don't create energy, they receive energy from a source (the prime mover) and bring about an advantage for the source in doing work on the load. There are six fundamental "machines" in classical mechanics. Do you remember them from grade school science?⁴

In their venerable introductory text on Physics, Sears and Zemansky have expressed that "a machine is a force-multiplying device."⁵ They state the "force multiplication" factor of a machine as the ratio of the weight lifted, W , to the applied force, F , and call it the *actual mechanical advantage*, R :

$$(1) R = \frac{W}{F} = \frac{\text{Force exerted by machine on load}}{\text{Force used to operate machine}} = \frac{\text{Output Force}}{\text{Input Force}}$$

This simple *magnifying ratio* reflects the incredible relief which machines have brought to the brows of multitudes of toiling laborers in the progress of civilization. Many orders of magnitude may be gotten, even in practical situations, so wonderful are

these remarkable devices. No energy is created, but tremendous advantage is devised for that which is available. In this paper we will show the obvious reason why Tesla called his finest invention a "Magnifying Transmitter".

The Lever

As recounted above, Archimedes was the first to state the principle of the lever. Although his treatise on "The Lever" has been lost to antiquity, the principle is discussed in his works which are extant.⁶

The rigid⁷ bar and the lever are common mechanical coupling devices for connecting mechanical systems together. The bar provides a way of transmitting forces and realizing *mutual* mass in coupled mechanical systems.

The lever is a pivoted rigid bar used to multiply force or motion. Consider Figure 1a. If force F_1 pushes down on one end and it moves with velocity v_1 , then the force and upward velocity at the other end, F_2 and v_2 , can be found either from conservation of energy ($\Delta W = F_1 r_1 \Delta \theta = F_2 r_2 \Delta \theta$) or by summing the moments about the immovable fulcrum (or pivot):

$$(2) \quad F_1 r_1 - F_2 r_2 = 0.$$

Rearranging algebraically gives the remarkably simple expression

$$(3) \quad F_2 = (r_1/r_2) F_1.$$

The rigid bar lever is a simple force multiplying mechanism.⁸ The force multiplication, or magnification, is given by the mechanical advantage

$$(4) \quad R \triangleq F_2/F_1 = r_1/r_2$$

As an astonishing result, which still delights us today, it is seen that a very great weight can be moved

with a very small force. Concerning the simplicity of Archimedes' proofs, Plutarch observed, "No amount of investigation of yours would succeed in attaining the proof, and yet, once seen, you immediately believe you would have discovered it yourself."⁹

In Archimedes' time, many asserted that it was as though he was reaching over into a mist enshrouded realm and drawing out Nature's hidden secrets so that anyone of slower intellect could comprehend them. Plutarch indicates that some of his contemporaries believed that incredible effort, toil, and intense contemplation on the part of the inventor had produced these wonderful results. Such conflicts to discover the hidden possibilities of Nature bring to mind the tragic struggles of Dr. Faust.¹⁰ [The tragedy of Dr. Faust is that, in spite of his great natural talent and his years of academic study, he gave up a sacred and holy quest, and "sold out for guns, girls and a good time" (in the words of C.S. Lewis). Archimedes didn't. Nor did Tesla.]

The mechanical input power ($F_1 v_1$) and output power ($F_2 v_2$) must be equal if there is no frictional loss. Consequently, the velocities are related as

$$(5) \quad v_2 = (1/R) v_1.$$

How remarkable the contributions of Archimedes are for mankind. His geometrical proofs, mechanical devices, and famous hydrostatic principle, so simple and obvious to us today, were, apparently, obtained at great price.

The Transformer - A Lever For 20th Century Civilization

The modern power transformer was invented and developed by William Stanley (1858-1916), and used at the first AC power plant in North America, at Great Barrington, Massachusetts, in 1886.¹¹ The physical principles of the electrical transformer go back to Michael Faraday and Joseph Henry. Stanley's plant demonstrated that electrical power

could be generated at a low voltage, transformed to a higher voltage for efficient transmission, and retransformed back to a lower voltage for end-user applications. Tesla, of course, did not "invent" AC. But he did create and patent the entire system which has made AC commercially viable as a means for powering the 20th century.¹² He contributed the

AC motor, and also the polyphase power generation and distribution system. His first AC patents were issued in January of 1886. It was his invention of an AC motor, along with AC's more efficient generation and simpler distribution, which made alternating current of such great commercial value, brought about its triumph over Edison's DC system in the 1890's, and has powered the wealth and progress of the 20th century.

In assessing the importance of electric power generation and distribution, and the great accomplishment of the Niagara Falls power plant, Dr. Charles F. Scott, Professor Emeritus of Electrical Engineering at Yale University, and past President of the AIEE (now the IEEE) has said, "The evolution of electric power from the discovery of Faraday in 1831 to the initial great installation of the Tesla polyphase system in 1896 is undoubtedly the most tremendous event in all engineering history."¹³ Certainly, not since the days of Archimedes had civilization experienced such a giant step forward in (to use the ECPD¹⁴ definition for the profession of Engineering) "utilizing the resources of the earth for the benefit of mankind".

The ideal transformer is the electrical analog to the frictionless mechanical lever and also to the ideal gear train.^{15,16,17,18,19} (See Figure 1b.) The operation of the ideal transformer follows from the definition of magnetic flux, Φ ,

$$(6) \quad \Phi = \iint B \cdot n \, da$$

where the integration is carried out over the transformer leg cross-sectional area, and from Faraday's law of induction,

$$(7) \quad \xi = -N \frac{d\Phi}{dt}$$

where ξ is the emf induced in an N turn coil through which the flux passes. Since the flux is the same in both legs, we have

$$(8) \quad \xi_1 = -N_1 \frac{d\Phi}{dt}$$

$$(9) \quad \xi_2 = -N_2 \frac{d\Phi}{dt} = \frac{N_2}{N_1} \xi_1 = N \xi_1$$

where one commonly defines the turns ratio as:

$$(10) \quad N = N_2/N_1.$$

The similarity between equations (3) and (9) completes the analogy if force and AC voltage are taken as analogs and if

$$(11) \quad N_2 \sim r_1 \quad \text{and} \quad N_1 \sim r_2.$$

Depending upon the mechanical advantage, R, the lever magnifies the applied force: $F_2 = R F_1$. Depending upon the turns ratio, N, a transformer steps the primary AC voltage up to a higher (or down to a lower) secondary voltage: $\xi_2 = N \xi_1$.

No power is dissipated in an ideal transformer, so that

$$(12) \quad P = \xi_1 I_1 = \xi_2 I_2.$$

Consequently, the current must be transformed in a manner analogous to equation (5)

$$(13) \quad I_2 = \frac{N_1}{N_2} I_1 = (1/N) I_1.$$

The analogy illustrated above is called the f-v (force-voltage) analog. An alternative analogy²⁰ has been advanced by Firestone.²¹

As with the lever, the AC voltage has been multiplied by the turns ratio, and the current has been multiplied by the reciprocal of the turns ratio. **What magnificent leverage has been afforded 20th century civilization by this wonderful appliance.**

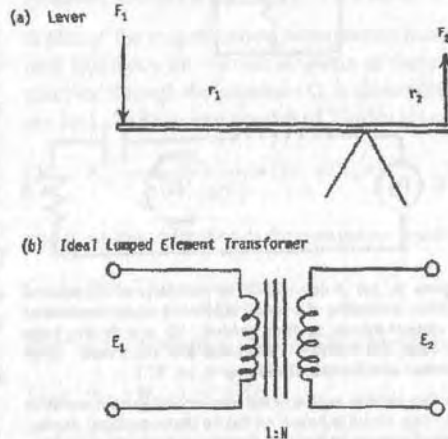

Figure 1. Classical devices which provide advantage.

Conventional power transformers have been splendid electrical devices in the application of electrotechnology. Cascaded transformers, working at power line frequencies have even been used to produce voltages in excess of 1 megavolt.^{22,23} Such transformers behave as lumped elements and depend entirely upon the turns ratio to achieve voltage rise. They are, however, incapable of attaining

the voltage rises produced through the phenomenon of resonance. The ultimate limitation on lumped-element high voltage transformers is due to the conflicting requirements that many tightly wound turns are necessary to produce flux leakage and obtain large step-up, yet great turn-to-turn spacing becomes necessary in order to avoid high voltage breakdown in the appliance.

The Mechanical Oscillator

Mechanical oscillators come in a variety of configurations: mass on a stretched spring, the simple pendulum, torsional oscillators (twisted bars, watch flywheels), floating objects, U-shaped liquid columns, compressed air columns (pistons, shock absorbers, organ pipes, wind instruments). Consider the simple linear mechanical oscillator. The dynamical behavior is to be determined when it is driven by a variable frequency forcing function.

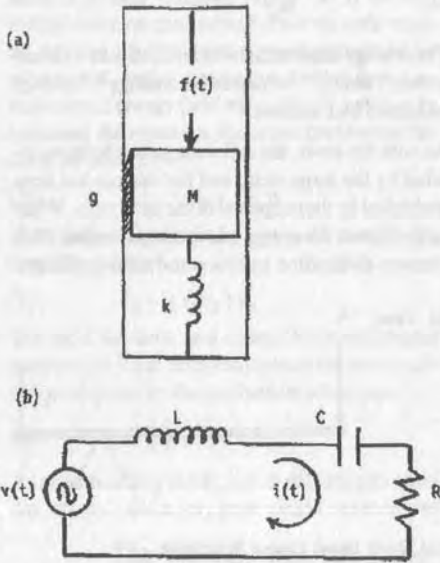

Figure 2. (a) A one-coordinate translational mechanical system, consisting of a spring supported mass constrained to vertical motion by fixed guides. $f(t)$ is a driving force between the frame of reference and the mass. (See Gardner and Barnes, Reference 8, pg. 57.)

(b) The electric analog of the mechanical system shown in (a). This circuit is based on the $f-v$ (force-voltage) analog. (See Gardner and Barnes, Reference 8, pg. 62.)

Let the system be assumed to have a linear restoring force (Hooke's law) and only viscous damping, i.e., the damping force is proportional to the velocity of the body.²⁴ McLean and Nelson point out two other types of mechanical damping:

- "1. Coulomb damping is independent of the velocity and arises because of sliding of the body on dry surfaces (its force is thus proportional to the normal force between the body and the surface on which it slides.
2. Solid damping occurs as internal friction within the material of the body itself (its force is independent of the frequency and proportional to the maximum stress induced in the body itself)."²⁵

In view of the fact that every basic physics course discusses dry friction, it is remarkable how little space is devoted to Coulomb damping in advanced texts on classical mechanics. Feynman has observed that the Coulomb friction law "... is another of those semi-empirical laws that are not thoroughly understood."²⁶ We have discussed these issues in greater detail in a previous paper,²⁷ and so we will not consider them further at this time.

Consider the simple mechanical system shown in Figure 2. Suppose that viscous damping is the only loss mechanism present, and the above two types of mechanical damping are negligible. Further, suppose the system is driven by a sinusoidal forcing function of amplitude F_0 . Equating the sum of the forces to ma leads to the well-known second order linear differential equation for the displacement²⁸

$$(14) \quad \frac{d^2x}{dt^2} + 2\alpha \frac{dx}{dt} + \omega_0^2 x = \frac{F_0}{m} \cos \omega t$$

where $2\alpha = g/m$ and $\omega_0^2 = k/m$

and g = the viscous damping constant
 m = the mass of the oscillating body
 k = system spring constant.

The steady state solution of Equation (14) is

$$(15) \quad \begin{aligned} x(t) &= \text{Re}\{X(\omega) e^{j\omega t}\} \\ &= \text{Re}\{X(\omega) e^{-j\phi(\omega)} e^{j\omega t}\} \\ &= X(\omega) \cos[\omega t - \phi(\omega)] \end{aligned}$$

where the response function $X(\omega)$ is a complex frequency dependent quantity whose magnitude is given by

$$(16) \quad X(\omega) = \frac{F_0/m}{\sqrt{(\omega_0^2 - \omega^2)^2 + 2\alpha\omega}} = \frac{F_0}{k} \left[\frac{\omega_0/\omega}{\sqrt{(\omega_0/\omega - \omega/\omega_0)^2 + 1/Q^2}} \right]$$

and whose phase is given by

$$(17) \quad \phi(\omega) = \tan^{-1} \left[\frac{2\alpha\omega}{\omega_0^2 - \omega^2} \right] = \tan^{-1} \left[\frac{1/Q}{(\omega_0/\omega - \omega/\omega_0)} \right]$$

where it is customary to introduce the selectivity Q , defined at ω_0 as

$$(18) \quad Q = \frac{\omega_0}{2\alpha} = 2\pi \frac{\text{Energy stored}}{\text{Energy dissipated per cycle}}$$

Q is a measure of the spectral spread of, Δf , of the system response about the resonant frequency. The phase is the angle by which the displacement lags behind the driving force. Referring to his classic text on mechanical vibrations, Den Hartog has called Equations (16) and (17) "the most important equations in the book".²⁹

It is of interest to plot these quantities as functions of frequency. (See Figure 3a and 3b.) Note that the effect of viscous damping is to spectrally broaden the response, and to shift the frequency of its maximum from the undamped resonance frequency ω_0 , where the phase passes through $\pi/2$, down to ω_m where the displacement is maximum. (ω_m is analogous to the frequency of maximum voltage across the capacitor in series RLC circuit.)

Quite often older authors in mechanical engineering³⁰ would introduce the term "Magnification Factor", which was defined as the ratio of the amplitude of the steady state solution $X(\omega)$ to the static deflection $X(0) = X_0$:

$$(19) \quad M(\omega) = \frac{X(\omega)}{X_0} = \frac{(\omega_0/\omega)}{\sqrt{(\omega_0/\omega - \omega/\omega_0)^2 + 1/Q^2}} = \frac{kX(\omega)}{F_0}$$

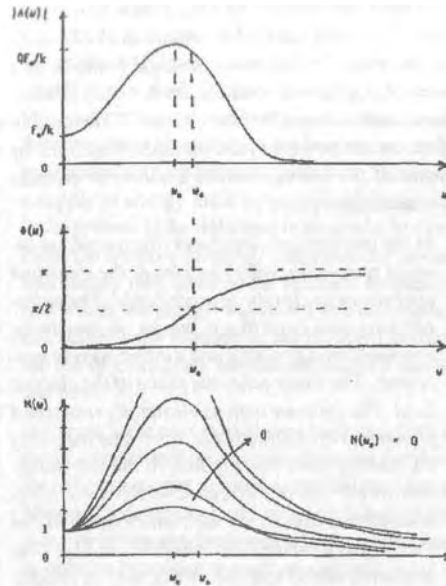

Figure 3. A plot of the magnitude and phase response of a linear mechanical oscillator driven by a time-harmonic forcing function. The magnification factor vs normalized frequency is also shown.

This is also the ratio of the magnitude of the force developed across the spring to the amplitude of the applied vibrating force, as shown in the last term. Once again, we have a force multiplication, or magnification, in the form of Equation (4) above. However, as with the transformer, the force is "AC".

A plot of the magnification factor versus normalized frequency for various amounts of damping, specified through the parameter Q , is shown in Figure 3(c). The maximum value of $X(\omega)$ is given by

$$(20) \quad X_m = \frac{QX_0}{\sqrt{1 - 1/(4Q^2)}} \approx QX_0 = QF_0/k$$

and force magnification at the maximum is simply

$$(21) \quad M(\omega_m) = \frac{Q}{\sqrt{1 - 1/(4Q^2)}} \approx Q.$$

Further, the frequency for which this occurs is

$$(22) \quad \omega_m = \omega_0 \sqrt{1 - 1/(2Q^2)}$$

and the maximum stored potential energy occurs at this frequency.

How can such a system be built and the AC force magnification be used to mechanical advantage? Tesla described just such a system. in 1919, which can be driven by either a centrifugal pump or by a reciprocating pump. See Figure 4, which is taken from Tesla's series "My Inventions". The mechanism, an air powered jack-hammer, functions by means of the introduction of a nonlinear element — the "escape ports".

In the mechanical apparatus illustrated, an attempt is made to convey an idea of the electrical operations as closely as practicable. The reciprocating and centrifugal pumps, respectively, represent an alternating and a direct current generator. The water takes the place of the electric fluid. The cylinder with its elastically restrained piston represents the condenser. The inertia of the moving parts corresponds to the self-induction of the electric circuit and the wide ports around the cylinder, through which the fluid can escape, perform the function of the air-gap. The operation of this apparatus will now be readily understood. Suppose first that the water is admitted to the cylinder from the centrifugal pump, this corresponding to the action of a continuous current generator. As the fluid is forced into the cylinder, the piston moves upward until the ports are uncovered, when a great quantity of the fluid rushes out, suddenly reducing the pressure so that the force of the compressed spring asserts itself and sends the piston down, closing the ports, whereupon these operations are repeated in as rapid succession as it may be desired. Each time the system, comprising the piston, rod, weights and adjustable spring, receives a blow,

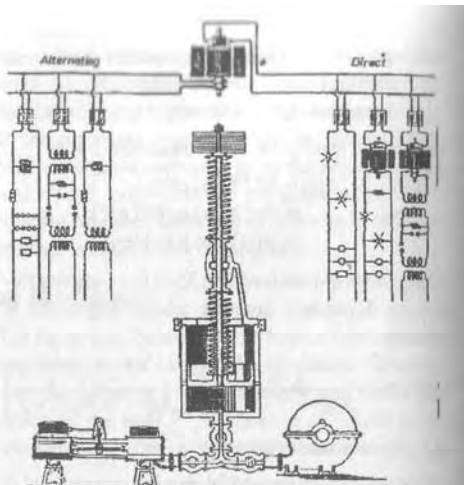

Figure 4. Mechanical analog for a lumped circuit Tesla coil.

*it quivers at its own rate which is determined by the inertia of the moving parts and the pliability of the spring exactly as in the electrical system the period of the circuit is determined by the self-induction and capacity. If, instead of the centrifugal, the reciprocating pump is employed, the operation is the same in principle except that the periodic impulses of the pump impose certain limitations. The greatest energy of movement will be obtained when synchronism is maintained between the pump impulses and the natural oscillations of the system.*³¹

It is not difficult to see the path in Tesla's thoughts leading to a mechanical conception of human energy: "Wherever there is life, there is a mass moved by a force."³²

The Voltage Magnifier and Electrical Oscillator

Turning to the electrical case, we consider the analog of the mechanical oscillator. A series resonant RLC circuit driven by a sinewave generator has the same analysis as above, with $X \rightarrow q(\omega)$ and $F \rightarrow V(\omega)$. At resonance, the magnification, given by Equation (21), again ascends to $M = Q$ and the voltage across the capacitance increases to

$$(23) \quad V_c(\omega_m) = -jQV_o = QV_o \angle -\pi / 2.$$

The $-j$ indicates that the capacitor voltage is in lagging phase quadrature with the source voltage. The

voltage across the inductance rises to

$$(24) \quad V_l(\omega_m) = jQV_o = QV_o \angle +\pi / 2$$

and is in leading phase quadrature with the source voltage. The current is limited only by the circuit resistance. At resonance, the current through the circuit rises until the voltage across the resistive loss is equal to the source voltage.

This simple circuit was a source of deep frustration to Edison because voltmeter readings taken

around the loop did not obey Kirchoff's law! As a result, he issued the famous warning,

*Take Warning! Alternating currents are dangerous! They are fit only for powering the electric chair. The only similarity between an AC and a DC lighting system is that they both started from the same coal pile.*³³

Ronald Scott, Dean of Engineering at Northeastern University has observed,

*One of the reasons that Edison mistrusted alternating currents was that he didn't really understand them. ... it wasn't until the work of Steinmetz at the General Electric Company that a good method for solving AC circuits became available. In 1897, complex algebra and phasors were applied to electric circuits in a classical paper by Steinmetz, and since that time no one has had any excuse for not understanding AC circuits.*³⁴

The series resonant RLC circuit has been called "a voltage amplifier" or "a voltage magnifier" by many of the old electrical engineering texts. (See Ryder,³⁵ for example.) The dual network (the parallel or "anti-resonant" circuit) has been called a "current magnifier". In both cases, the magnification, $M = Q$.

The electrical analog of Tesla's jack hammer oscillator is found by introducing an electrical nonlinear element in place of the escape ports - the spark gap. When a spark gap is set across the circuit, the capacitor charges up to the gap breakdown and RF oscillations occur as long as the plasma arc across the gap conducts. (Contrary to many erroneous discussions of spark gap transmitters, the spark does not create the RF oscillations!)

Consider the push button "oscillator" shown in Figure 5. If the button is held down, current will flow and magnetic energy will be stored in the magnetic field of the coil. When the button is released, none of this energy can return to the battery, instead, as the magnetic field collapses, the current induced in the circuit will charge up the electrical potential energy stored in the capacitor. Energy, of course, will be dissipated in the resistive losses.

This interplay of kinetic energy and potential en-

ergy will occur at a fixed rate known as the natural resonant frequency of the system. The situation is not unlike a child on a swing, the pendulum in a grandfather's clock, or the torsional oscillator (or flywheel) in an old-fashioned pocket watch. In these mechanical oscillators the frequency may be maintained with considerable precision. However, a supply of energy must be periodically imparted to the system, at the right time in the cycle, to overcome the resistive damping. Otherwise the motion will simply ring down at the resonant frequency. In a watch, the energy was stored in a mainspring and periodically released to the flywheel through the use of a nonlinear mechanism called a ratchet and pawl.

In Figure 5, the energy exchange back and forth in the LC tank circuit provides an electrical flywheel for oscillations, but we need a creature the likes of Maxwell's demon to stand at the push button and press the button synchronously with the oscillations, in order to introduce enough energy each cycle to overcome the resistive losses.

Ryder notes that what is needed is a nonlinear device such as a vacuum tube:

The tube will operate as a synchronous switch, supplying dc power in pulses (of length $2\theta_1$) to the resonant LC circuit, in synchronism with the voltage across the load. After supplying a pulse

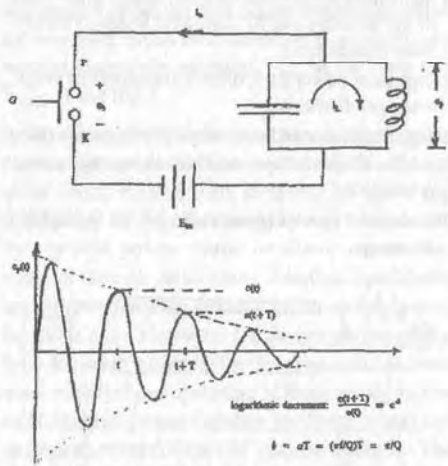

Figure 5. A "push-button" electrical oscillator.

of energy, the switch disconnects the energy source from the load, and the energy in the load continues to oscillate at the resonant frequency. The action is comparable to that of a pendu-

lum, driven by short energy pulses, and swinging freely at its own rate for most of the cycle.³⁶

This type of operation occurs for class C amplifiers.

The Early Tesla Transformer - Coupled Lumped Oscillations

Coupled mechanical oscillators have been treated in considerable detail in many books. They are the counterpart to the tuned **lumped** coupled coils which describe Tesla coils during the duration of the primary spark. Since we have written many articles and an entire book on this (complete with software), we will refer the reader to the literature. A well written and lucid treatment of **lossless** lumped coupled tuned coils is presented by Finkelstein. Smythe includes losses. But, neither author recognizes the importance of spark duration, and both miss the slow-wave distributed resonator mode of the helical secondary.

TCTUTOR has a useful discussion of the whole topic. The bottom line on all this is that lossless tuned **lumped** coupled coils, assuming infinite spark duration, have a magnification given by

$$(25) \quad M = \sqrt{C_1 / C_2}$$

This can be greatly improved upon by following the disclosures patented by Tesla in 1897 - operate the secondary as a quarter wave helical resonator, not a lumped coupled coil. The voltage rise will then be by VSWR, not lumped circuit Q. A true Tesla Coil is a distributed resonator.

Transmission Line RF Resonance Transformer

Transmission line resonance transformers utilize wave interference phenomena for the build up of extremely high voltage standing wave modes. It has long been recognized that RF resonance transformers possess the following capabilities:

- 1) high voltage generation (tens of megavolts, limited only by the electrical breakdown of the electrode geometry and surrounding dielectric medium)
- 2) high efficiency (limited only by the ac copper losses of the structure and RF dielectric losses of the primary capacitance)
- 3) high peak power performance (hundreds of megawatts per discharge)
- 4) high repetition rate, heavy duty cycle operation (hundreds of kilowatts of continuous average power processed)
- 5) broadband spectra (generated via high voltage RF discharge).

It is noteworthy that, in the days of Breit, Tuve, Cockcroft, Walton and Van De Graaff, a complaint against spark gap transmitters and high voltage RF generation by distributed resonance transformers was that their output was too broadband! (These early pioneers of nuclear science merely required high energy — not high power.)

The relevant physical processes by which high voltage is produced on microwave resonators is common knowledge.³⁷ Consider the generic transmission line shown in Figure 6. The coordinate origin is taken at the load and a time harmonic generator drives the input end at $x = -\ell$. The voltage at any point along the line is then given by the expression

$$(26) \quad V(x) = V_+ e^{-\gamma x} + V_- e^{\gamma x}$$

where $x=0$ at the load and $x = -\ell$ at the generator end. Physically, Equation (26) expresses the fact that the voltage at any point along the transmission line is the superposition of a forward travelling wave and a backward travelling wave.

The resultant analytical expression describes a spatially distributed interference pattern called a standing wave. As usual, γ is the complex propagation constant $\gamma = \alpha + j\beta$. The complex constants V_+ and V_- follow from the second order partial dif-

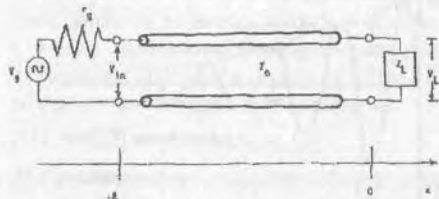

Figure 6. A transmission line resonator (as described by Tesla in US Patent # 593,138 - November 2, 1897).

ferential equation of which equation (26) is a solution (the "transmission line equation"), and depend upon the boundary conditions (the generator and the load).

Also, at the load end one may define the complex load reflection coefficient Γ :

$$(27) \quad \Gamma = V_r/V_- = |\Gamma| e^{j\theta}$$

For an open circuited line $\Gamma=1|0$.

From equation (26) we have, at the input end of the line,

$$(28) \quad V_{input} = V(-\ell) = [e^{\alpha\ell} + \Gamma e^{-\alpha\ell}]$$

where, again, Γ is a complex quantity. Also from equation (26), we may write the voltage at the load end as:

$$(29) \quad V_{Load} = V(0) = V_+ + V_- = V_+ [1 + \Gamma].$$

Equations (28) and (29) may be combined in the following extremely useful expression which relates the load voltage to the input (generator end) voltage:

$$(30) \quad V_{load} = \frac{V_{in}[1 + \Gamma]}{[e^{\alpha\ell} + \Gamma e^{-\alpha\ell}]}$$

Now consider what happens on an open-circuited low-loss line one quarter wavelength long. Simple complex algebra gives the following well-known result:

$$(31) \quad V_{Load} = V_{in} / (j\alpha\ell) \quad (\text{for } \ell = n\lambda/4 \text{ with } n \text{ odd})$$

where, again, α is the attenuation per unit length of the transmission line, and the j implies that the voltages at the two ends are in phase quadrature. The structure is a lossy, tuned reactive resonator. Since the numerator of equation (31) is finite and the denominator is vanishingly small, the voltage standing wave will build up to very large values!

The transient build-up to the steady state expressions given above is easy to understand. Initially a forward wave of voltage is launched from the input end of the line. It propagates toward the open circuit (high impedance) end of the line where it is reflected with zero phase shift. This reflected wave travels back down the line to the low impedance input end, where, not only is it reflected with a 180° phase shift but, because it took a half cycle to travel

up and back along the quarter wave long line, this twice reflected wave is now in phase with the source of original energy being launched into the line.

The voltage wave now being launched into the line will add directly to the twice reflected wave as it travels back toward the open circuit load end. These coherent additions will continue to proceed, sloshing the load voltage higher and higher as a standing wave forms along the line with a voltage minimum at the input end and a voltage maximum at the open circuited load end. This growth process will continue until either a discharge occurs at the load end (i.e., a nonlinearity of the system), or the line's I²R losses are equal to the power being supplied by the source (i.e., the generator can't push the system any higher).

What limits the maximum attainable voltage? The power driving the line, the line losses $\alpha\ell$, and the breakdown potential of the load geometry (which usually arises from the onset of cold field emission from the electrode).

In common parlance, this is called a Tesla coil. (The secondary of a Tesla coil is a helically distributed quarter-wave resonator, not a lumped tuned circuit. The voltage rise is by standing wave: $V_{max} = S V_{min}$, where S is the VSWR on the transmission line resonator. The actual measured voltage distribution on a Tesla coil or a transmission line resonator follows the first ninety degrees of a spatial sinusoid, much as it would on a quarter-wave vertical monopole antenna: V_{min} at the base and V_{max} at the top.)

It should be obvious that resonance transformers (or tuned transmission line resonators) do not have to be shock excited (link coupled) by spark gap oscillators. They perform equally well when driven by any high power master oscillator - spark gap, vacuum tube or solid state. Junction breakdown and device efficiency become major concerns with the latter two. However, the design philosophy is the same and, historically, the approach has been used with devices operating at frequencies as low as 60 Hz (HV power supplies for X-ray tubes) and as high as several GHz (RF plasma torches). The authors have published fairly extensive engineer-

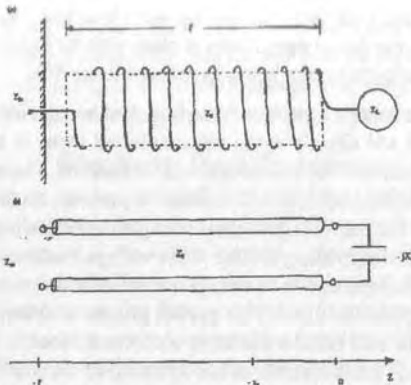

Figure 7. A slow-wave helical transmission line resonator (a Tesla coil).

ing analyses of such circuits in the past.^{38,39,40,41}

There have been many practical applications of the above technique wherever high voltage impulse sources are needed. In particular, the Soviets have advanced the technology to a mature state for use with high current nanosecond pulsed beams.^{42,43}

[It should parenthetically be remarked that, first, what some authors have called *Tesla Coils* in the

Cavity Resonators - Potential Magnification

As with both lumped and distributed circuits, it is possible to show that cavity resonators also are *magnifiers*. Both Smythe⁴⁵ and Condon⁴⁶ derive expressions for voltage magnification in cavity resonators excited by inductive loops and capacitive probes. The former is the ratio of the voltage across the cavity to the emf in the loop,

$$(32) \quad M = |V / \xi|$$

and the latter is the ratio of the maximum potential across the cavity to that across the probe. Smythe's

past are simply lumped tuned coupled coils. Tesla was using these prior to 1892. When comparing the voltage rise produced by lumped coupled coils with that obtainable from distributed resonators, Tesla would write, "No such pressures - even in the remotest degree, can be obtained with resonating circuits otherwise constituted with two terminals forming a closed path."⁴⁴ The best engineering analysis which we have seen of the coupled coils configuration is given in Smythe.

Secondly, the "Tesla Coil" so commonly seen today is in fact a link-coupled distributed tuned resonance transformer. It is easily documented that Tesla was using the latter prior to 1898. As Sloan observes, the lumped analysis of this configuration totally fails.

Thirdly, Tesla's most famous high voltage RF experiments, the photographs of which the public at large is so familiar with, employed what he called his "Extra Coil." From his recently published Colorado Springs diary of 1899, it is clear that this structure is actually the slow wave helical transmission line resonator of Figure 7. The structure was excited at its base by a relatively narrow band RF signal generator.]

examples give voltage magnifications on the order of a hundred. The procedure could be formally executed for the Schumann cavity, of course. In all of the above, we have tacitly assumed that the elements are linear and passive. No external pumping is being done as with some possible ionospheric-TWT amplifier effect. There is yet one more surprise that distributed linear systems have in store - they can "multiply" power (without violating conservation of energy, of course).

Traveling Wave Ring Power Multiplier

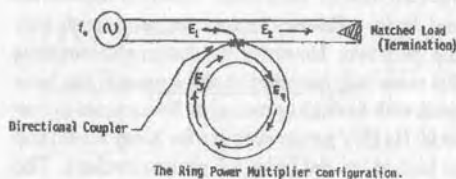

Figure 8. A ring power multiplier.

In addition to quarter wave transmission line resonators and cavity resonators which step up voltage, as just described, there is also a novel technique for stepping up real RF power (within practical limits). This unusual circuit geometry, invented by F.J. Tischer in 1952,^{47,48} actually makes it possible to obtain practical power level *multiplication* of 10 to 500 times the transmitter output. (The

Poynting's vector power flow, $\frac{1}{2}\text{Re}(\mathbf{E} \times \mathbf{H}^*)$, is actually pumped up within this linear, passive distributed storage network. No physical laws are violated, and energy conservation is preserved in the process, of course.)

The closed ring structure shown in Figure 8 is connected by means of a directional coupler to a second transmission line which is excited by a source and terminated in a matched load. The distributed network is characterized by a real Poynting vector circulating within the ring, where unidirectional progressive traveling waves build up in time. The physical explanation advanced by MIT-Lincoln Lab's Stanley Miller is as follows:

A wave proceeding from the source is partially coupled into the ring (by the directional coupler), and propagates around the ring in one direction as shown. When this wave passes the coupling region, a small fraction is coupled back into the main transmission line with the remainder proceeding around the ring again. At the same time, more energy is being coupled from the main line into the ring. If the wave proceeding around the ring and the wave coupled into the ring are in phase, then it is evident that the wave in the ring can be reinforced and can become quite large in magnitude.⁴⁹

The build up of the power in the ring will continue with each cycle until the losses around the loop plus the loss in the termination is equal to the power supplied by the source. Hayes and Surette report actual ring power levels of 200 kW with a 10 kW

generator at VHF, with a 6-inch coaxial line resonant ring.⁵⁰ Miller reported 100 MW levels from a 200 kW source driving a WR 2100 waveguide at 425 MHz. (He also reported spectacular pyrotechnical and acoustical results when a slight mismatch was inserted into the guide.) The primary use of the traveling wave ring power multiplier has been to test high power RF components which fail due to power dissipation as opposed to voltage breakdown. (The latter could be tested with the transmission line resonance transformers described above.)

It is evident that a great variety of multiply connected geometrical enclosures⁵¹ with the appropriate electrical constitutive parameters can serve as "ring" power multipliers. The necessary condition is that the successively added field components, from the ensuing circulations of field energy, possess the correct phases for constructive interference (coherent buildup). Such multiply connected structures can be operated either in the sinusoidal steady state (cw) or in a pulsed mode. Coherence and synchronization are particularly critical for the operation of the latter. We will now present a technique by which the fundamental ring resonator modes of an electrically large resonator may be determined by probing with a DSB (double sideband) modulated carrier of frequency much greater than the self resonant frequency of the resonator. [The theory may be applied to the probing of terrestrial (Schumann type) resonances with a VLF transmitter in place of an ELF source.]

Multiple Beam Interference

Optical multiple-beam interference is perhaps best known in the classical case of the monochromatically illuminated parallel plane geometry, such as dielectric plates and the parallel mirror geometry of Fabry and Perot. As a result of the multiple reflections, the wave is split into many partial waves reflecting back and forth from the parallel boundaries, which interfere with one another as they linearly superpose together. Knowing the optical path difference between successive partial waves and the phase of the reflections, the plane wave summation is formed and the intensity (the squared

modulus of the field strength) is determined. The result is the famous expression obtained by G.B. Airy in 1831.

Let us repeat the analysis for the case of around the circuit propagation for TEM waves. We will consider two cases: the pure carrier wave and the DSB modulated wave. For the sake of simplicity we will employ an unpretentious ray optic model. The model is appropriate for optical and TEM transmission line ring resonators. It is clear and lends itself to simple prediction and experimentation.

Case I: Monochromatic Carrier

Consider the geometry shown in Figure 9 with $f_m = 0$. The transmitter at wavelength $\lambda = c/f$ is located at the top of the ring and multiple peripheral propagation paths are shown. In the region near the source, the n^{th} time around propagating wave can be expressed as

$$(33) E_n(\lambda) = E_0 A(L)^n e^{-j2\alpha n L / \lambda} = E_0 e^{-n\alpha L} e^{j2\alpha n L / \lambda}$$

where $A(L)$ is the propagation attenuation, α is the attenuation constant at the wavelength λ , and L is the circumference of the ring $L = C_c = 2\pi R_c$. For plane wave propagation, $A(nL) = e^{-n\alpha L}$. The total field observed is

$$(34) E_T(\lambda) = E_0 + E_1 + E_2 + \dots$$

That is, near the source

$$(35) E_T(\lambda) = E_0 [1 + Ae^{-j2\alpha L / \lambda} + Ae^{-j4\alpha L / \lambda} + \dots]$$

The terms on the right bear resemblance to the geometric series

$$(36) 1/(1-x) = 1 + x + x^2 + x^3 + \dots$$

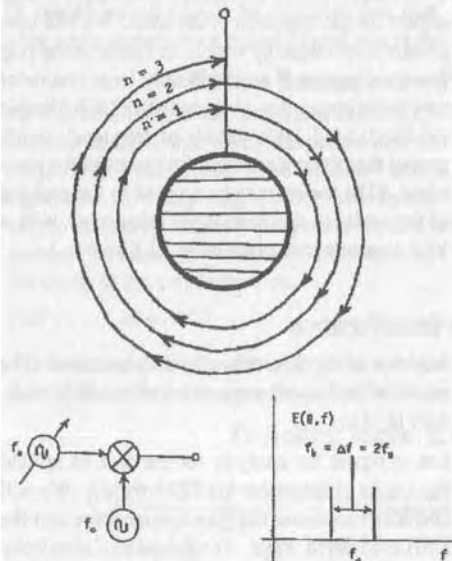

Figure 9. Ray optic model of VLF transglobal propagating TEM waves and a DSB transmitter. The procedure is choose an f_c appropriate for propagation around the ring, and then to tune the modulating frequency to produce beats between the USB and the LSB such that envelope resonances are observed.

Consequently, Equation (35) may be expressed as

$$(37) E_T(\lambda) = E_0 [1 + Ae^{-j2\alpha L / \lambda}]^{-1} = |E_T| e^{j\Phi}$$

where

$$|E_T| = E_0 [1 + A^2 - 2A \cos \Phi]^{-1/2}$$

$$\Phi = \tan^{-1} [(-A \sin \Phi) / (1 - A \cos \Phi)]$$

This is a complex phasor associated with the time-harmonic field. The time domain expression for the field is found from the expression:

$$E_T(t) = \text{Re}\{E_T(\lambda)e^{j\omega t}\} = \text{Re}\{|E_T(\lambda)| e^{j\Phi(\lambda)} e^{j\omega t}\}$$

The ring is resonant when $\Phi = 2n\pi$. The wave power density is proportional to the squared modulus, so that

$$(38) P = EE^* = |E(\lambda)|^2 = E_0^2 \frac{1}{[1 - A(e^{-j2\pi L/\lambda} - e^{j2\pi L/\lambda}) + A^2]}$$

Remembering that $\cos \theta = 1/2[e^{j\theta} + e^{-j\theta}]$, we can write

$$(39) |E(\lambda)|^2 = E_0^2 \frac{1}{[1 + A^2 - 2A \cos(2\pi L / \lambda)]}$$

It is customary to employ the trigonometric identity $\cos \theta = 1 - 2 \sin^2(\theta/2)$ and write

$$(40) |E(\lambda)|^2 = E_0^2 \frac{1}{[(1-A)^2 + 4A \sin^2(\pi L / \lambda)]}$$

which can be manipulated into the form

$$(40^*) |E(\lambda)|^2 = E_0^2 \frac{1/(1-A)^2}{[1 + (4A/(1-A)^2) \sin^2(\pi L / \lambda)]}$$

which is analogous to Airy's formula for multiple beam interference in a parallel plate geometry. Fabry called the Airy denominator factor $F = 4A/(1-A)^2$ the *finesse*. Born and Wolf⁵² define the finesse as $\mathfrak{F} = 1/2\pi\sqrt{F}$. When a polychromatic beam is present, as in a spectrum analyzer, the latter expression has the advantage of being equal to the ratio of the line separation (Δf) to the half power width of the line (δf).⁵³ Finesse is a measure of the resolution of an interferometer. The term $[1 + F \sin^2(\xi)]^{-1} \Delta f(\xi)$ is called the Airy function and it represents the transmitted power density. Figure 10 is a plot of $|E|^2/E_0^2$ versus ξ , the phase shift arising from the path-length difference between successive rays ($\xi = 2\pi\Delta \ell / \lambda$).

in the case where we have plane wave propagation, Equation (40) becomes

$$(41) |E(\lambda)|^2 = E_0^2 \frac{1}{\left[(1 - e^{-\alpha L})^2 + 4e^{-\alpha L} \sin^2(\pi L / \lambda) \right]}$$

A plot of the square root of Equation (41) against frequency shows the magnitude of the electric field strength as we tune the carrier. Resonances occur at the frequencies where $\pi L / \lambda$ is an integral multiple of π , i.e. at frequencies equal to $f = nc/L$. The ratio of the separation between peaks to the half power width of a resonance line is called the resonator's "finesse."

A direct application of Equation (41) to the terrestrial resonator gives resonances whenever $f = 7.5n$ for $n = 0, 1, 2, 3, \dots$. Presumably this formula would be acceptable for carriers at VLF, however down at ELF (near 7.5 Hz and up to 1 kHz) the waves don't possess planar phase fronts and a full solution requires the Schumann analysis. At ELF the world behaves as a reactive resonator (E and H are in phase quadrature) instead of a ring power multiplier (for which E and H are in-phase). The ray optics and plane wave assumption is a fairly crude physical model for the VLF waveguide. (From a practical standpoint, propagation losses and phase inhomogeneities might hide terrestrial ring resonances). Basically, the form of ray optic assumption used above is that the earth-ionosphere waveguide can be approximated as a great circle TEM transmission line. A more formal treatment could be given,^{54,55,56} of course, and microwave engineers

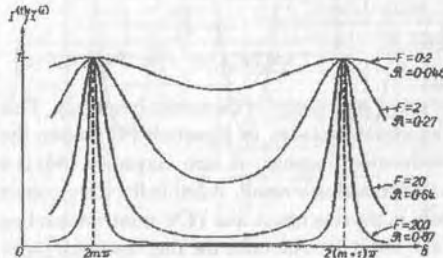
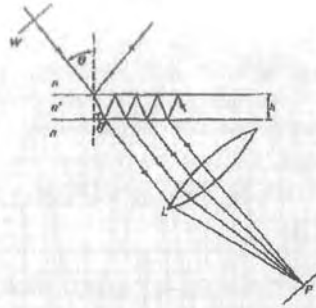

Figure 10. (a) Formation of multiple beam fringes in a parallel plate of index of refraction n' , focused to give the transmitted intensity (power density) I . (b) The Airy function - a plot of the ratio of the transmitted and incident intensities as a function of the propagation path-produced phase difference $\delta = 4\pi n' n \cos \theta / \lambda_0$. [Ref. Born and Wolf, pp. 326-7. Script R is the power reflection coefficient r^2 and $F = 4R/(1-R)^2$.]

will recognize that the same results could easily be gotten from an S-matrix calculation instead of the Airy formalism, but we will explore this as a working hypothetical model.

Case II: DSB Modulation (Beats)

When the carrier is DSB/SC modulated one can employ carrier frequencies high enough for practical directional couplers, and lower the modulation frequency to the point where the wavelength associated with the modulation envelope is exactly the circumference of the ring. As shown in Appendix I, the interference pattern fringe spacing (the distance between the intensity maxima) is exactly equal to the circumference of the ring (L) when the beat frequency between the USB and the LSB is an integral multiple of c/L . We desire to obtain the variation of the wave intensity near the transmitter as the modulation frequency is varied. Consider

the DSB waveform

$$(42) E(t) = B \cos(\omega_m t) \cos(\omega_0 t) \\ = \frac{1}{2} B \cos(\omega_0 + \omega_m)t + \frac{1}{2} B \cos(\omega_0 - \omega_m)t$$

where ω_0 is the carrier frequency and ω_m is the modulation frequency. The spectral separation between the USB and the LSB is the "beat" frequency, which is equal to twice the modulation frequency: $\omega_b = 2\omega_m$.

Analogous to Equation (33) above, the n^{th} global traversing DSB wave, measured at a site near the transmitter, can be represented as

$$(43) E_n(f_0, f_m) = E_0 A(L)^n [e^{j2\pi(f_0 - f_m)L/c} + e^{j2\pi(f_0 + f_m)L/c}]$$

where c is the speed of light. Again, $A(L)$ is the amplitude attenuation per global traverse. Algebraic manipulation leads to the expression

$$(44) |E|^2 = \frac{E_0^2}{[1 - A \cos(2\pi f_m L/c)]^2 + 4A \sin(\pi f_0 L/c)}$$

$$(45) |E|^2 = \frac{E_0^2}{[1 + e^{-2\alpha L} \cos(2\pi f_m L/c) - 2e^{-\alpha L} \cos(2\pi f_m L/c) \cos(2\pi f_0 L/c)]^2}$$

or, equivalently, as

$$(46) |E|^2 = \frac{E_0^2}{[1 - e^{-\alpha L} \cos(2\pi f_m L/c)]^2 + [4e^{-\alpha L} \sin^2(\pi f_0 L/c)]}$$

where α is measured at the carrier frequency. This expression reduces to Equation (41) when the modulation frequency is zero. Equation (46) is a rather remarkable result. Admittedly, it is rigorous only in the ring optics and TEM transmission line case, but it does describe the ring resonator physics. It implies that ring resonances (and power multiplication) can occur in a "more-or-less" carrier independent manner. That is, holding the carrier

frequency constant and varying the modulation frequency will lead to field strength maxima whenever $f_m = \frac{1}{2}nc/L$. The greatest finesse of the resonator will occur when the carrier frequency is tuned such that $\pi f_0 L/c = n\pi$. That is the case whenever $f_0 = nc/L$.

[Terrestrial resonances might be observed (depending on propagation losses) whenever the beat frequency is $f_b = 2 f_m = 7.5n$ for $n = 0, 1, 2, 3, \dots$ Equation (12) of Appendix I gives the spatial distance between intensity maxima, Λ , for $f_b = 7.5$ Hz as $\Lambda = 40,000$ km = the circumference of the earth. If the beat frequency is tuned to 7.5 Hz, the travelling modulation envelope peak of the DSB wave will propagate all the way around the globe and return to the position of the source exactly in synchronism with the next peak of the modulation envelope. Although the result is "more-or-less" independent of the carrier frequency, critical to detecting the phenomenon is the use of a carrier frequency low enough so that great circle global propagation can occur (VLF), and it is necessary to tune the beat frequency for ring resonance.]

Example

Suppose $f_0 = 5$ kHz (i.e., $\lambda = 60$ km). Further, suppose that we tune the modulation oscillator to $f_m = 3.75$ Hz. This will produce two signals:

$$f_1 = 5.00375 \text{ kHz (i.e., } \lambda_1 = 59.955 \text{ km)}$$

$$f_2 = 4.99625 \text{ kHz (i.e., } \lambda_2 = 60.045 \text{ km)}$$

And the beat frequency is $\Delta f = f_1 - f_2 = 7.5$ Hz.

The result is that the observed fringe spacing, given by Equation (1.12) is exactly the circumference of

the earth: $\Lambda = 40,000 \text{ km} = C_e = 2\pi R_e = 2\pi(6.37 \times 10^6)$ meters. If the beat frequency is tuned to 7.5 Hz, the travelling modulation envelope peak of the 5.0 kHz DSB wave in Figure 9 propagates all the way around the globe and returns to the position of the source exactly in synchronism with the next peak of the modulation envelope.

Calculation of Field Strength at VLF

While there exists extensive theoretical literature on the computation of electric field strengths at VLF, we shall employ an empirically determined engineering VLF formula. The most famous VLF empirical formula was obtained by Dr. Louis W. Austin and Cohen for the U.S. Bureau of Standards.^{57,58} Although now considered more-or-less as a "museum piece", the empirical formula gives daylight VLF signal strength for ranges of 2,000 to 10,000 km with fair accuracy. According to Austin, when the transmitted power is known, the daytime field strength may be calculated as⁵⁹

$$(47) E_{RMS} = \frac{300\sqrt{P_{1m}G}}{d} \sqrt{\frac{\theta}{\sin\theta}} \exp(-0.0014d_{km}/\lambda^{0.10}) \text{ mV/m}$$

where d is the range in km, λ is the wavelength in km, and θ is the angular separation between the transmitter and the receiver. The formula can be used for wavelengths from 100 down to 10 km, corresponding to frequencies from 3 to 30 kHz. At ranges beyond 10,000 km, the Austin-Cohen formula gives values well below what is actually observed. It is particularly poor in the region of the antipode, and consequently it cannot be used to examine transglobal propagation.

During World War II, from 1939 to 1945, the German Navy collected extensive experimental data for global VLF transmission. Zinke deduced an empirical formula which represents correctly the daytime and nighttime observations of the German Navy.^{60,61} The result was an "Austin-Cohen like" formula which is far more accurate for propagation in the antipodal region (20,000 km).

$$(48) E_{\text{RMS}} = \frac{15\sqrt{P_{\text{kw}}G}}{\sqrt{d_{\text{km}}}} \sqrt{\frac{\theta}{\sin\theta + 0.008}} \exp(-\alpha d_{\text{km}}/\lambda^x) \text{ mV/m}$$

where

$$\alpha = \begin{cases} 0.003 & (\text{day}) \\ 0.0005 & (\text{night}) \end{cases}$$

$$x = \begin{cases} 1.0 & (\text{day}) \\ 0.5 & (\text{night}) \end{cases}$$

and both d and λ are in kilometers. The geocentric angle between transmitter and receiver, $\theta = d/R_{\oplus}$ is in radians. The parameters α and x are multivalued because the propagation reflections are affected by the lower D region on the daylight side of the globe and by the E region on the night side. Physically, the exponential factors in Equations (47) and (48) are traceable to energy leakage out of the earth-ionosphere waveguide (attenuation is primarily due to the upper boundary).

Examples at VLF

The empirically based VLF model which we will employ assumes that the $A(L)$ in Equation (43) above can be expressed by Zinke's exponential damping factor

$$(49) A(L) = \exp(-\alpha d_{\text{km}}/\lambda_{\text{km}}^x)$$

where, for nighttime propagation $\alpha = 0.0005$ and $x = 1/2$. For the sake of argument, we will assume

Historical Observations

In a previous publication we showed that if Tesla transmitted a series of impulses at 7.5 Hz (i.e. launched baseband ELF - a truly heroic accomplishment!) then due to the range ambiguity inherent in pulse range measuring devices, a pulse train of echoes would be received 0.08484 seconds after each transmitted pulse.^{62,63} It should now be clear that it would **not** be necessary for Tesla's 250 kW Colorado Springs transmitter of 1899 to "radiate" at ELF to obtain the same result. All that is neces-

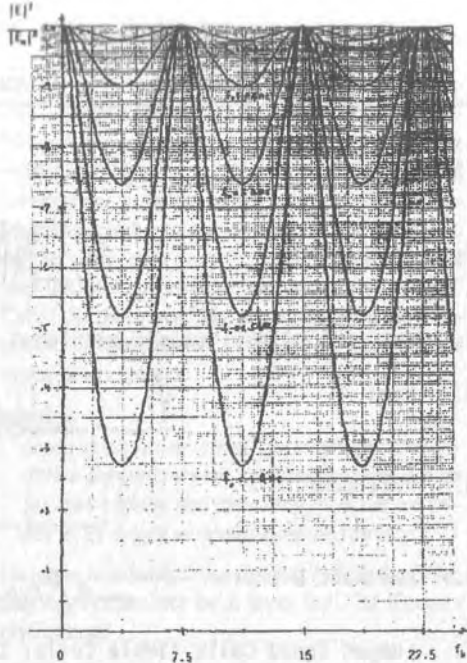

Figure 11. Plot of the normalized ring resonator power density (for various VLF carrier frequencies) as a function of the DSB beat frequency. As the modulation is tuned, the detected fields go through peaks and valleys.



that the carrier frequency (wherever it may be set) is tuned such that $f_0 = nc/L$ for maximum finesse. A plot of $|E|^2/|E_0|^2$, using Zinke's formula for nighttime experiments, versus DSB beat frequency is given in Figure 11 for several different carrier frequencies across the VLF band. **The result clearly demonstrates the ability of a VLF station to detect the terrestrial ring resonances.**

sary is that his transmitter power and carrier frequency be capable of round-the-world propagation. In a subsequent newspaper interview, Tesla said,

*With my transmitter I actually sent electrical vibrations around the world and received them again, and I then went on to develop my machinery.*⁶⁴

A high power pulsed transmitter operating in the 1 to 20 kHz VLF band would readily lead an ob-

TABLE I. SUMMARY OF CLASSICAL LINEAR PASSIVE SYSTEMS THAT MAGNIFY

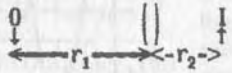
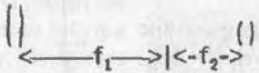
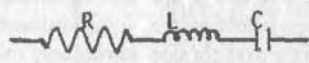
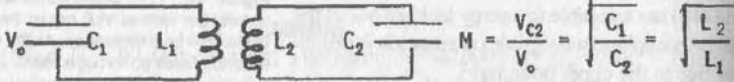
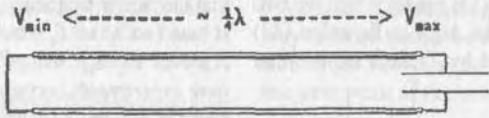
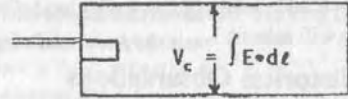
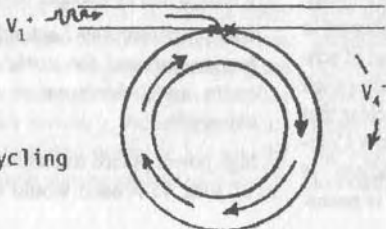
SYSTEM	SCHEMATIC	MAGNIFICATION
1. Lever		$M = r_1/r_2$
2. Transformer		$M = E_2/E_1 = N$
3. The rest of the "simple machines"		$R = F_2/F_1$
4. Lens		$M = -r_1/r_2$
5. Telescope		$M = -f_1/f_2$
6. Resonant Circuit		$M = \frac{ E_L }{ E_g } = \frac{ E_C }{ E_g } \gg 1$
7. Lumped Tuned Coils (Tesla Coils: $t \sim 1891$)		$M = \frac{V_{C2}}{V_o} = \sqrt{\frac{C_1}{C_2}} = \sqrt{\frac{L_2}{L_1}}$
8. Transmission Line Resonators (Tesla Coils: $t > 1894$) "Resonance Xfmrs"		$V_{max} = S V_{min}$ $S \approx 1/\alpha \ell$
9. Cavity Resonators		$M = \frac{V_{cavity}}{V_{probe/loop}}$
10. Ring Power Multipliers		$M = \frac{ V_4^- ^2}{ V_1^+ ^2} \sim 1/q^2$ $M = \frac{P_{ring}}{P_{gen}}$
11. Light Recycling		

ever to the following conclusions:

- The terrestrial globe resonates at multiples of 7.5 Hz. (See Figure 11 above.)
- The received pulse train has echoes which occur 0.08484 seconds after the transmitted pulses. (See References 62 and 63.)
- These conclusions are more-or-less independent of carrier frequency for $f_0 \leq 25$ kHz. **Above 25 kHz the global response "washes out"**. (See Figure 11 above.)

Tesla's exact words from May of 1900 were,
I would say that the frequency should be smaller than twenty thousand per second, though

Tesla Speaks

Tesla has spoken of his global wireless communication system on many occasions. When reviewing his "World system of Wireless Transmission of Energy" Tesla once wrote,

The chief discovery which satisfied me thoroughly as to the practicability of my plan, was made in 1899 at Colorado Springs, where I carried on tests with a generator of 1500 KW

Conclusion

In one of the most eloquent sections of his enchanting "Lectures on Physics," Richard Feynman describes the wonderful art of electrical technology and how electrical power generation and transmission rests solidly on Faraday's remarkable discovery that an emf is produced by a time varying magnetic field. Listen as he describes the generators at Boulder Dam and the cities to which it is connected:

What is Boulder Dam? ... an exquisitely intricate mess of copper and iron all twisted and interwoven ... A revolving monster thing. A generator ... And everything must be enormously efficient ... The power for a metropolis is going through ... All done with specially arranged pieces of copper and iron ... [In the cities] thousands of little wheels, turning in response to the turning of the big wheel at Boulder Dam. Stop the big wheel and all the little wheels stop; the lights go out.⁶⁶

Recognizing that today's electro-technology is not the ultimate, Feynman was moved to prophesy,

shorter waves might be practicable. The lowest frequency would appear to be six per second...⁶⁵

On July 14, 1905, Tesla wrote that the appropriate wavelengths to transmit were in the range of 25 - 70 km. These correspond to frequencies of 12 kHz - 4.29 kHz. On July 6, 1912, Tesla indicated that his experiments indicated that the transmitted wavelength should be no shorter than 12 km (25 kHz), and he went on to state, "... on this fortunate fact rests the future of wireless transmission of energy." Certainly, these would be consistent with the excitation of the whole world as a ring power multiplier-resonator.

capacity and ascertained that under certain conditions the current was capable of passing across the entire globe and returning from the antipodes to its origin with undiminished strength.

Have we overlooked the obvious? Will the Magnifying Transmitter be a lever for 21st Century civilization?

Power networks of the future may have little resemblance to those of today.

If there be any truth in Tesla's disclosures, then we all must certainly agree. In September of 1915, Tesla wrote,

The present limitations in the transmission of power to distance will be overcome . . . through the introduction of the wireless art . . . we have now the means for the economic transmission of energy in any desired amount to the distances only limited by the dimensions of the planet. In view of the assertions of some misinformed experts to the effect that in the wireless system I have perfected the power of the transmitter is dissipated in all directions, I wish to be emphatic in my statement that such is not the case. The energy goes only to the place where it is needed and no other. ... With the full development [of water and solar power] and a perfect system of wireless transmission of the energy to any distance, man will solve all the problems of material existence.⁶⁷

Finally, in 1927, Tesla said,

... the experts must come to the same conclusions I have reached long ago. Sooner or later my power system will have to be adopted in its entirety and so far as I am concerned it is as good as done.⁶⁸

As we approach the end of the century, we can't help but wonder if something has been overlooked in electrical science. We seem to hear the words of Faust again,

*What to your spirit she's unwilling to reveal,
You cannot wrestle from her with levers, screws
and wheel.*

In Aeschylus'⁶⁹ famous tragedy,⁷⁰ Prometheus,⁷¹ the Titan, is fettered with unbreakable adamantine chains to a lofty ragged rock "at the end of the world" amid roaring thunder, flashing lightning, blasting storms, fiery whirlwinds, and an earthquake. His sin:

I gave to mortals the gift of fire ... and they will

learn from it all kinds of arts ... I set mortals on the path of a science hard to judge.

Greek translator Rex Warner has identified Prometheus as the patron of the mathematical sciences and engineering:

In recognizing that intelligence, not brute force, was the governing power of the universe, he initiated men into all the arts and sciences which make civilization possible.⁷²

Artist Robert Kendall has captured kindred thoughts on the famous Battelle Mural in Columbus, Ohio.

The scientist is truly a Prometheus; he still continues to steal fire from heaven in seeking to comprehend the secrets of nature ... he is mankind's greatest benefactor ... he holds out the greatest single hope that they ultimately may also live together in peace.⁷³

Somehow, in spite of the promise of electrical fire, our engineering science still seems to be chained.

THE TELESCOPE

"The 'Magnifying Transmitter'... is in the transmission of electrical energy what the telescope is in astronomical observation." Nikola Tesla, June 1919

A refracting telescope consists of an objective converging lens of long focal length, f_1 , and an ocular (or eye-piece) of short focal length, f_2 .

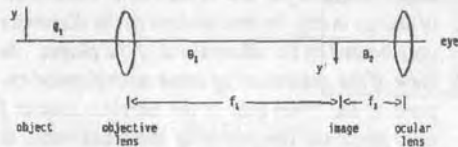

The simple refracting telescope.

The purpose of the objective lens is to increase the amount of light collected from the object in order to make a bright image at the focal point. The objective lens can collect a great deal more light than the eye's pupil. Let θ_1 be the angle subtended by

the object at the objective lens, and let θ_2 be the angle subtended by the image at the ocular.

The eye-piece is essentially a microscope to magnify the angular dimension of the image. The *magnification* of the telescope is defined as the ratio of these angles:

$$M = \frac{\theta_2}{\theta_1} \approx -\frac{f_1}{f_2}$$

The latter follows from the small angle approximation. (The sign is a consequence of the inverted image.) Thus, for great *magnification* it is desirable to have a large f_1 and a small f_2 . The similarity to equation (4) had not escaped Tesla.

APPENDIX I: BEATS

Beats are fluctuations in amplitude produced by two oscillations of slightly different frequency. Consider a single, omnidirectional source emitting two frequencies f_1 and f_2 . (The case of spatially separated sources is treated in the references.) The wave equation gives the resultant field at some distance, r , from the source as the **superposition** of two monochromatic travelling waves:

$$(1) E(r,t) = A(r)\cos(\beta_1 r - \omega_1 t + \theta_1) + B(r)\cos(\beta_2 r - \omega_2 t + \theta_2)$$

where $\beta = 2\pi/\lambda$ and $\omega = 2\pi f$. (In a dispersive medium $\beta(\omega)$, and the propagation will be different for f_1 than for f_2 .) We will let the amplitudes be equal and constant, and assume zero epoch angles. In order to manipulate the expression for the field into a simple formula, we note the trigonometric identity

$$(2) \cos a + \cos b = 2 \cos \frac{1}{2}(a+b) \cos \frac{1}{2}(a-b)$$

Equation (1) can then be written as

$$(3) E(r,t) = 2A \cos \frac{1}{2}[(\beta_1 + \beta_2)r - (\omega_1 + \omega_2)t] \cos \frac{1}{2}[(\beta_1 - \beta_2)r - (\omega_1 - \omega_2)t]$$

Let us define the following quantities

$$(4a) \beta_0 = \frac{1}{2}(\beta_1 + \beta_2) = \text{average carrier wave number}$$

$$(4b) \beta_m = \frac{1}{2}(\beta_1 - \beta_2) = \frac{1}{2}\Delta\beta = \text{modulation propagation wave number.}$$

$$(4c) \omega_0 = \frac{1}{2}(\omega_1 + \omega_2) = \text{average carrier frequency}$$

$$(4d) \omega_b = (\omega_1 - \omega_2) = \Delta\omega = \text{"beat frequency"}$$

$$(4e) \omega_m = \frac{1}{2}(\omega_1 - \omega_2) = \frac{1}{2}\Delta\omega = \text{modulation frequency}$$

Then, equation (3) may be written as the simple expression

$$(5) E(r,t) = 2A \cos(\beta_m r - \omega_m t) \cos(\beta_0 r - \omega_0 t)$$

We recognize this as a propagating modulated wave,⁷⁴ and identify the modulation envelope as

$$(6) m(r,t) = 2A \cos[\beta_m r - \frac{1}{2}(\omega_b t)]$$

The intensity, or power in the wave, is proportional to the square of the modulation envelope:

$$(7) m^2(r,t) = 2A^2 [1 + \cos(2\beta_m r - \omega_b t)]$$

which will oscillate about $2A^2$ with a frequency of ω_b (the beat frequency), i.e. - at twice the modulation frequency. There are two "beats" per cycle of the modulation wave.^{75,76} (See Figure 12.)

Each of the separate waves in Equation (1) has a phase velocity found by writing

(a) For Equation (1)

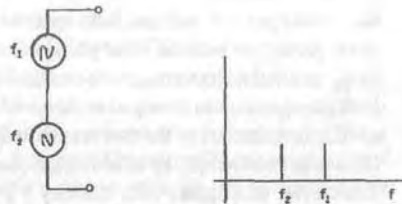

(b) For equation (5')

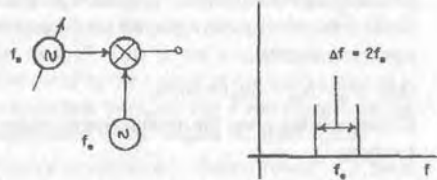

Figure 1.1. The combination of two wave trains of slightly different frequencies, as shown in (a), is equivalent to a wave of the average frequency DSB modulated by the difference frequency, as shown in (b). In reality, each spectral component has a finite line-width δf .

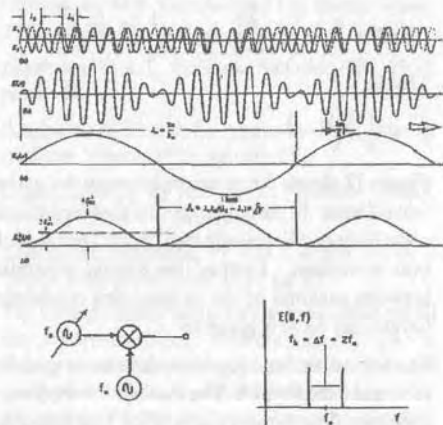

Figure 1.2. Propagating DSB wave.

- Two separate wave components versus spatial position, x .
- Spatial distribution of the propagating DSB wave.
- Spatial distribution of the propagating modulation waveform.
- Distribution of the square of the modulation.
- The DSB transmitter.
- The transmitter's DSB spectrum.

$$(8) \Psi = \beta r - \omega t = \text{const}$$

and differentiating with respect to time

$$(9) v_\phi = dr/dt = \omega/\beta = f\lambda.$$

In a nondispersive medium, both spectral components propagate with the same phase velocity, $v_{\phi 1} = v_{\phi 2}$, and in the electromagnetic case in free space both phase velocities are equal to the speed of light, c . The interference of the two waves in Equation (1) is seen most simply by examining Equation (5). The carrier propagates with velocity $v_\phi = \omega_0/\beta_0 = f_0\lambda_0$.

The modulation envelope, $m(r,t)$ also propagates. To find its velocity, we again set the argument equal to a constant:

$$(10) \Psi_m = \beta_m r - \frac{1}{2}\omega_m t = \text{const}.$$

Differentiating gives the modulation envelope velocity as

$$(11) v_s = \frac{\omega_m}{\beta_m} = \frac{\Delta f}{1/\lambda_1 - 1/\lambda_2} = \Delta f \Lambda$$

The interference pattern fringe spacing is simply the spatial distance between intensity maxima, (see Figure I3)

$$(12) \Lambda = \frac{c}{\Delta f} = \frac{\Delta f}{1/\lambda_1 - 1/\lambda_2} = \frac{\lambda_1 \lambda_2}{\lambda_2 - \lambda_1} \approx \frac{\lambda_0^2}{\Delta \lambda}$$

That is

$$(13) \frac{1}{\Lambda} = \frac{1}{\lambda_1} - \frac{1}{\lambda_2}$$

Figure I2 shows the relations between the various wave forms. In particular, notice that the intensity waveform oscillates with two "beats" per modulation waveform. Further, the spatial separation between maxima of the propagating modulation (envelope) wave is given by Λ .

The human ear is a square law detector responding to sound intensity, E^2 . The modulation frequency, corresponding to $m(r,t)$, is $1/2$ of the beat frequency $\omega_m = 1/2 \omega_b$. There are two beats per cycle of the modulation wave.

For the case of acoustic waves, Crawford points out that if f_1 and f_2 differ by more than about 6% from f_0 , then one "hears" the sound as two separate tones, or oscillators, with significantly different notes [Equation (1)]. In music, this is called a

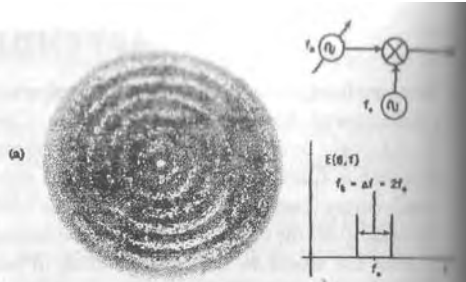

Figure 13. Free space DSB transmitter radiating the outward propagating beat pattern of Equation 1.5. (a) corresponds to Figure I1(b). The white bands are the propagating envelope maxima and the white rings in each band correspond to the peaks of the oscillating carrier. The spacing between the outward propagating beats is $\Lambda = c/\Delta f$.

"chord". However, if f_1 and f_2 are closer, then one "hears" the sound as a single oscillator of frequency f_0 , modulated with a slowly varying amplitude $m(t)$ [Equation (5)].⁷⁷

Finally, we mention that in a dispersive medium, e.g. a waveguide near cutoff, or a cavity resonator near its resonant frequency, $v_g \neq v_\phi$ and the beats don't propagate at the speed of the carrier wave. The modulation appears as a disturbance propagating along the carrier wave with velocity v_g through space.

Beats as Moving Interference Patterns

Several discussions of "beats", produced by two sources of slightly differing frequencies, have been published.^{78,79,80,81,82} Such phenomena may be described in terms of a *traveling pattern of interference fringes*. In the discussion above, we have examined only the case where the two point sources coincide. The above referenced articles treat the more general case, which reduces to our discussion when the spectrally different sources are at the same point, and reduces to Young's two slit diffraction when the two sources are at the same frequency but different locations (as with a **phased array antenna**). When both spatially separated sources and different spectra are employed, the resulting interference pattern can result in slowly propagating envelopes and in stationary (standing) waves, i.e. waves for which the envelope velocity is zero, just as Tesla said.

REFERENCES

- Tusculan Disputations, V, xiii, 64-66.
- Plutarch records that the Roman general in charge of the invasion even issued a statement wanting to know why his scientists and craftsmen weren't equal to those of Syracuse.
- Plutarch's *Lives*, translated by John Dryden (1686), The Modern Library, Random House. See the chapter entitled "Marcellus".
- The six simple machines are: the lever, the inclined plane, the wedge (a double inclined plane), the screw (a helically wound inclined plane), the wheel and axle (a wheel rigidly attached to an axle, i.e.— a crank and axle), and the pulley (a wheel that turns on an axle).
- University Physics*, by F.W. Sears and M. W. Zemansky, Addison-Wesley Press, 2nd edition, 1957, pg. 134.
- Treatise on Plane Equilibria or Centers of Gravity of Planes*: "Proposition 6 - Two magnitudes balance at distances reciprocally proportional to the magnitudes."
- A *rigid bar* is one which will propagate disturbances instantaneously throughout its length. It is the mechanical equivalent of a lumped-constant electrical system. By considering lumped-constant mechanical systems, the wave propagation phenomenon associated with distributed-constant systems is excluded.
- Transients in Linear Systems- Volume I: Lumped Circuits*, by M.F. Gardner and J.L. Barns, Wiley, 1942, pg. 80. (Apparently, Volume II, on distributed circuits, was never published.)
- Plutarch loc cit.
- In his burning frustration and desire to pierce the secrets of the physical universe and discover what holds the worlds together Goethe's Faust, surrounded in his laboratory by the classical simple machines, utters:
- Mysterious, even in the light of day,
Nature's enshrouded secrets, denied, stay;
What to your spirit she's unwilling to reveal,
You cannot wrestle from her with levers,
screws and wheel.*
- These lines were quoted by Pauli in the early days of quantum mechanics.
- "Some Contributions To The Electrical Industry", by C.C. Chesney, *Electrical Engineering*, Vol. 53, May, 1934, pp. 726-729. (Reprinted in *Turning Points in American Electrical History*, J.E. Brittain, editor, IEEE Press, 1977, pp. 102-106.)
- If the reader visits the "electrical exhibit" at the Smithsonian Institute he will find photographs of the Niagara Falls power plant and a large brass "boiler plate", from one of its original huge generators, listing Tesla's patents covering the electrical power system. In the midst of the Niagara Falls section stands a lifesize replica of Edison with the comment, "While the Niagara AC plant was being built by Westinghouse, Edison was busy with other important things." One is not told what these things, considered by the curator of the Smithsonian to be so important, were, nor why it was thought that this was relevant to the Niagara AC power plant.
- "Tesla's Contribution to Electric Power", C.F. Scott, *Electrical Engineering*, August, 1943, pp. 351-355.
- Engineering Council for Professional Development: the organization which accredits the engineering curricula at colleges and universities in the USA.
- Transients in Linear Systems- Volume I: Lumped Circuits*, by M.F. Gardner and J.L. Barns, Wiley, 1942, pp. 76-81.
- Acoustics*, by L.L. Beranek, McGraw-Hill, 1954, pp. 56-58.
- Analysis Of Linear Systems*, by D.K. Cheng, Addison-Wesley, 1959, pp. 109-112.
- Linear Circuits*, by R.E. Scott, Addison-Wesley, 1960, pp. 555-556, 565-566.
- Electrical Engineering*, by A.B. Carlson and D.G. Gisser, Addison-Wesley, 1981, pg. 87.
- The analogy advanced by Firestone is called the f-i (force-current) analog. With the latter, $F \sim I$, $v \sim x$, $mass \sim capacitance$, $spring \sim inductance$. In the f-i analog, not only are the equations formally similar, but mechanical elements in series are represented by electrical elements in series (electrical nodes are analogous to mechanical junctions). In the f-i case $N_1 \sim r_1$ and $N_2 \sim r_2$. It is recognized that the f-i and f-v analogies are duals to one another.
- "The Mobility Method of Computing the Vibration of Linear Mechanical and Acoustical Systems: Mechanical-Electrical Analogies", by F.A. Firestone, *Journal of Applied Physics*, Vol. 9, June, 1938, pp. 373-387.

- 22 R.W. Sorenson, Jour. A.I.E.E., Vol 44, 1925, pp. 373.
- 23 "A New High Potential X-Ray Tube", by C.C. Lauritsen and R.D. Bennett, Physical Review, Vol. 32, December, 1928, pp. 850-857.
- 24 Vibrations and Waves, by A.P. French, W.W. Norton & Co., N.Y., 1971, pp. 83-101.
- 25 Engineering Mechanics, by W.G. McLean and E.W. Nelson, Schaum Publishing Co., 2nd edition, 1962, pg. 313.
- 26 The Feynman Lectures on Physics, by R.P. Feynman, R.B. Leighton, and M. Sands, Addison-Wesley Publishing Co., 1963, Vol. I, section 12-2.
- 27 "Mechanical Oscillations", by K.L. Corum and J.F. Corum, Appendix X (1986) to our Tesla Handbook. The appendix is 59 pages in length.
- 28 The astute reader will recognize that the electrical analog corresponds to a zero impedance source.
- 29 Mechanical Vibrations, by J.P. Den Hartog, Dover, 1985, pg. 53.
- 30 Analytic Mechanics, by V. Fairs and S. Chambers, MacMillan Co., 3rd edition, 1958, pg. 493.
- 31 Tesla, Nikola, "My Inventions. Part IV - The Discovery of the Tesla Coil and Transformer", Electrical Experimenter, May, 1919, pp. 16, 17, 64, 65, 89.
- 32 "The Problem of Increasing Human Energy", by Nikola Tesla, Century Illustrated Magazine, June, 1900, pp. 175-211. (Unabridged republication by J.A. Hayes and S.R. Elswick, High Energy Enterprises, Inc., 1990, ISBN 1-882137-00-0).
- 33 Thomas Edison, Pamphlet, of 1887.
- 34 Linear Circuits, by R.E. Scott, Addison-Wesley Press, 1960, pg. 637.
- 35 Networks, Lines and Fields, by J.D. Ryder, Prentice-Hall, Inc., 2nd edition, 1955, pg. 60.
- 36 Electronic Fundamentals and Applications, by J.D. Ryder, Prentice-Hall, 4th edition, 1970, pp. 388-393.
- 37 "Microwave Designer's Quiz: How Much Do You Know About Connectors?", by J.F. Corum, K.L. Corum, V.G. Puglielli and J.F.X. Daum, Microwave Systems News, June, 1990.
- 38 "The Application of Transmission Line Resonators to High Voltage RF Power Processing: History, Analysis, and Experiment", Proceedings of the 19th Southeastern Symposium on System Theory, Clemson University, Clemson, South Carolina, 1987, pp. 45-49.
- 39 Vacuum Tube Tesla Coils, by J.F. Corum and K.L. Corum, Published by Corum & Associates, Inc., 1988, [100 page text], ISBN 0-924758-00-7.
- 40 TCTUTOR - A Personal Computer Analysis of Spark Gap Tesla Coils, by J. F. Corum, D.J. Edwards and K.L. Corum, Published by Corum & Associates, Inc., 1988, [110 page text + Disk], ISBN 0-924758-01-5.
- 41 "High Voltage RF Ball Lightning Experiments and Electro-Chemical Fractal Clusters," by K.L. Corum and J.F. Corum, Soviet Physics - Uspekhi, Vol. 160, No.4, April, 1990, pp. 47-58, (in Russian).
- 42 "Analysis of Transient Processes and Spectral Characteristics of Electron Beams in High-Current nanosecond Electron Accelerators with Forming Lines", by G.A. Mesyats and B.Z. Movshevich, Soviet Physics - Technical Physics, Vol. 34, No. 5, May, 1989, pp. 523-528.
- 43 Industrial Electron Accelerators and Applications, by E.A. Abramyan, Hemisphere Publishing Corp., 1988.
- 44 Colorado Springs Notes, 1899-1900, by Nikola Tesla, Nolit, Beograd, Yugoslavia, 1978, PP. 79, 103, 180, 345.
- 45 Smythe, W.R., Static and Dynamic Electricity, McGraw-Hill, 2nd edition, 1950, pp. 545-547.
- 46 Condon, E.U., "Forced Oscillations in Cavity Resonators", Jour. Appl. Phys., Vol. 12, Feb., 1941, pp. 129-132. (See pg. 131 for voltage "multiplication".)
- 47 "Resonance Properties of Ring Circuits", by F.J. Tischer, I.E.E.E. Trans MTT, Jan., 1957, pp.51-56.
- 48 Microwave filters, Impedance Matching Networks, and Coupling Structures, by G. Matthai, L. Young, and E.M.T. Jones, Artech House, pp. 846-847.
- 49 "The Traveling Wave Resonator and High Power Microwave Testing", by Stanley Miller, Microwave Journal, September, 1960, pp. 50-58.
- 50 "Methods of Producing High Levels of RF Power for Test Purposes", by P. Hayes and R. Surette, National Association of Broadcasters Engineering Conference Proceedings, 1988, pp. 380-386.
- 51 The term "multiply connected" implies that there exists a *closed path* in the resonator which cannot be shrunk to a point without part of the path passing through regions outside the resonator. A toroidal shaped ring resonator and the earth-ionosphere cavity are examples. The latter has the added feature that it focuses converging energy at the antipode.

- ³³ R.W. Sorenson, Jour. A.I.E.E., Vol 44, 1925, pp. 373.
- ³⁴ "A New High Potential X-Ray Tube", by C.C. Lauritsen and R.D. Bennett, Physical Review, Vol. 32, December, 1928, pp. 850-857.
- ³⁵ Vibrations and Waves, by A.P. French, W.W. Norton & Co., N.Y., 1971, pp. 83-101.
- ³⁶ Engineering Mechanics, by W.G. McLean and E.W. Nelson, Schaum Publishing Co., 2nd edition, 1962, pp. 313.
- ³⁷ The Feynman Lectures on Physics, by R.P. Feynman, R.B. Leighton, and M. Sands, Addison-Wesley Publishing Co., 1963, Vol. I, section 12-2.
- ³⁸ "Mechanical Oscillations", by K.L. Corum and J.F. Corum, Appendix X (1986) to our Tesla Handbook. The appendix is 59 pages in length.
- ³⁹ The astute reader will recognize that the electrical analog corresponds to a zero impedance source.
- ⁴⁰ Mechanical Vibrations, by J.P. Den Hartog, Dover, 1985, pg. 53.
- ⁴¹ Analytic Mechanics, by V. Fairs and S. Chambers, MacMillan Co., 3rd edition, 1958, pg. 493.
- ⁴² Tesla, Nikola, "My Inventions, Part IV - The Discovery of the Tesla Coil and Transformer", Electrical Experimenter, May, 1919, pp. 16, 17, 64, 65, 89.
- ⁴³ "The Problem of Increasing Human Energy", by Nikola Tesla, Century Illustrated Magazine, June, 1900, pp. 175-211. (Unabridged republication by J.A. Hayes and S.R. Elswick, High Energy Enterprises, Inc., 1990, ISBN 1-882137-00-0).
- ⁴⁴ Thomas Edison, Pamphlet, of 1887.
- ⁴⁵ Linear Circuits, by R.E. Scott, Addison-Wesley Press, 1960, pg. 637.
- ⁴⁶ Networks, Lines and Fields, by J.D. Ryder, Prentice-Hall, Inc., 2nd edition, 1955, pg. 60.
- ⁴⁷ Electronic Fundamentals and Applications, by J.D. Ryder, Prentice-Hall, 4th edition, 1970, pp. 388-393.
- ⁴⁸ "Microwave Designer's Quiz: How Much Do You Know About Connectors?", by J.F. Corum, K.L. Corum, V.G. Puglielli and J.F.X. Daum, Microwave Systems News, June, 1990.
- ⁴⁹ "The Application of Transmission Line Resonators to High Voltage RF Power Processing: History, Analysis, and Experiment", Proceedings of the 19th Southeastern Symposium on System Theory, Clemson University, Clemson, South Carolina, 1987, pp. 45-49.
- ⁵⁰ Vacuum Tube Tesla Coils, by J.F. Corum and K.L. Corum, Published by Corum & Associates, Inc., 1988, [100 page text], ISBN 0-924758-00-7.
- ⁵¹ TCTUTOR - A Personal Computer Analysis of Spark Gap Tesla Coils, by J. F. Corum, D.J. Edwards and K.L. Corum, Published by Corum & Associates, Inc., 1988, [110 page text + Disk], ISBN 0-924758-01-5.
- ⁵² "High Voltage RF Ball Lightning Experiments and Electro-Chemical Fractal Clusters," by K.L. Corum and J.F. Corum, Soviet Physics - Uspekhi, Vol. 160, No.4, April, 1990, pp. 47-58, (in Russian).
- ⁵³ "Analysis of Transient Processes and Spectral Characteristics of Electron Beams in High-Current nanosecond Electron Accelerators with Forming Lines", by G.A. Mesyats and B.Z. Movshevich, Soviet Physics - Technical Physics, Vol. 34, No. 5, May, 1989, pp. 523-528.
- ⁵⁴ Industrial Electron Accelerators and Applications, by E.A. Abramyan, Hemisphere Publishing Corp., 1988.
- ⁵⁵ Colorado Springs Notes, 1899-1900, by Nikola Tesla, Nolit, Beograd, Yugoslavia, 1978, PP. 79, 103, 180, 345.
- ⁵⁶ Smythe, W.R., Static and Dynamic Electricity, McGraw-Hill, 2nd edition, 1950, pp. 545-547.
- ⁵⁷ Condon, E.U., "Forced Oscillations in Cavity Resonators", Jour. Appl. Phys., Vol. 12, Feb., 1941, pp. 129-132. (See pg. 131 for voltage "multiplication".)
- ⁵⁸ "Resonance Properties of Ring Circuits", by F.J. Tischer, I.E.E.E. Trans MTT, Jan., 1957, pp.51-56.
- ⁵⁹ Microwave filters, Impedance Matching Networks, and Coupling Structures, by G. Matthai, L. Young, and E.M.T. Jones, Artech House, pp. 846-847.
- ⁶⁰ "The Traveling Wave Resonator and High Power Microwave Testing", by Stanley Miller, Microwave Journal, September, 1960, pp. 50-58.
- ⁶¹ "Methods of Producing High Levels of RF Power for Test Purposes", by P. Hayes and R. Surette, National Association of Broadcasters Engineering Conference Proceedings, 1988, pp. 380-386.
- ⁶² The term "multiply connected" implies that there exists a closed path in the resonator which cannot be shrunk to a point without part of the path passing through regions outside the resonator. A toroida shaped ring resonator and the earth-ionosphere cavity are examples. The latter has the added feature that it focuses converging energy at the antipode.

- 52 Principles of Optics, by M. Born and E. Wolf, Pergamon Press, 5th edition, 1975, pp. 327-328.
- 53 Introduction to Optical Electronics, by A. Yariv, Holt, Rinehart and Winston, 2nd edition, 1976, pp. 60-66.
- 54 Those familiar with Van der Pol and Bremmer's "rainbow expansion" will recognize that Equation (41) can be gotten from the inclusion of higher terms of the asymptotic expansion in the residue series representation for the fields on a conducting sphere.
- 55 "The Diffraction of Electromagnetic Waves from an Electrical Point Source round a Finitely Conducting Sphere, with Applications to Radiotelegraphy and the Theory of the Rainbow - Part II", by B. Van der Pol and H. Bremmer, Philosophical Magazine, S. 7, Vol. 24, No. 164, Suppl. Nov., 1937, pp. 825-864.
- 56 "Propagation of Electromagnetic Waves", by H. Bremmer, in Handbuch der Physik, S. Flugge, editor, 1958, Vol. 16, pp. 423-639. (See pg. 604.)
- 57 "Some Quantitative Experiments In Long Distance Radio Telegraphy", by L.W. Austin, Bureau of Standards Bulletin (J. Res. NBS), Vol. 7, 1911, No. 3, October, pp. 315-366.
- 58 "Preliminary Note on Proposed Changes in the Constants of the Austin-Cohen Transmission Formula", L.W. Austin, Proceedings of the IRE, Vol. 14, June, 1926, p. 327.
- 59 Propagation of Radio Waves, by M. Dolukhanov, Mir Publishers, Moscow, 1971, pp. 275-284.
- 60 "Ausbreitung langer Wellen um die Erdkugel", by O. Zinke, Frequenz, October, 1947, pp. 16-23.
- 61 Propagation of Waves, by P. David and J. Voge, Pergamon Press, 1969, pp. 229-235.
- 62 "The Transient Propagation of ELF Pulses in the Earth-Ionosphere Cavity", by J.F. Corum and A. Hamid Aidinejad, Proceedings of the 2nd International Tesla Symposium, Colorado Springs, Colorado, 1986, pp. .
- 63 "The Global Response of the Earth to Schumann Pulse Repetition Frequencies", by J.F. Corum, K.L. Corum and A.H. Aidinejad, Proceedings of the International Scientific Conference on Energy and Development, Zagreb, Yugoslavia, 1986, pp. 1-18.
- 64 "A Noted Inventor: Nikola Tesla". interview by Frank G. Carpenter, The Illustrated Weekly Magazine, (a section of The Los Angeles Times), December, 1904, pp. 3-4.
- 65 "Art of Transmitting Electrical Energy Through the Natural Mediums", Nikola Tesla, U.S. Patent #787,412. Applied for May 16, 1900; Issued April 18, 1905.
- 66 The Feynman Lectures on Physics, F.P. Feynman, R.B. Leighton and M. Sands, Addison-Wesley, 1964, Section 16-4.
- 67 "The Wonder World To Be Created By Electricity", by Nikola Tesla, Manufacturer's Record, September 9, 1915, pp. 37-39.
- 68 World System of Wireless Transmission of Energy" by Nikola Tesla, Telegraph and Telephone Age, October 16, 1927, pp. 457-460.
- 69 525-456 B.C.
- 70 Prometheus Bound (460 B.C.).
- 71 The name means "forethought".
- 72 Ten Greek Plays, edited by, L.R. Lind, Houghton Mifflin Company, 1957, pg. 3.
- 73 "The Battelle Mural", a brochure, Battelle Memorial Institute, Columbus, Ohio.
- 74 At $r = 0$, the disturbance is expressed as
- $$(5') E(0, t) = 2A \cos(\omega_m t) \cos(\omega_c t)$$
- $$= A \cos(\omega_c + \omega_m)t + A \cos(\omega_c - \omega_m)t$$
- $$\begin{array}{ccc} \Downarrow & & \Downarrow \\ \text{USB} & & \text{LSB} \end{array}$$
- which we identify as a double sideband suppressed carrier wave (DSB/SC), with modulation frequency $\omega_m = \frac{1}{2}(\omega_1 - \omega_2) = \frac{1}{2}\omega_p$. The DSB spectrum is simply $E(0, f) = \frac{1}{2} M(f-f_0) + \frac{1}{2} M(f+f_0) = \frac{1}{2}\delta[f-(f_0-f_m)] + \frac{1}{2}\delta[f-(f_0+f_m)]$, where $M(f)$ is the spectrum of the baseband message, $m(t)$.
- 75 Optics, by E. Hecht and A. Zajac, Addison-Wesley, 1974, pp. 202-205.
- 76 Vibrations and Waves, by A.P. French, Norton & Co., 1971, pp. 22-27, 213-215.
- 77 Waves, (Vol. 3 of the Berkeley Physics Course), by F.S. Crawford, McGraw-Hill, 1968, pg.30.
- 78 Physical Optics, R.W. Wood, Dover, 1967 (1934 edition), pp. 180-181.
- 79 "Interference Pattern of Beats", L.G. Hoxton, American Journal of Physics, Vol. 31, No. 10, October, 1963, pp. 794-801.
- 80 "Demonstration of Beats as Moving Interference Patterns", by T.S. Stein and L.G. Dishman, American Journal of Physics, Vol. 50, No. 2, February, 1982, pp. 136-145.

⁸¹ "A Ripple tank Demonstration of the Conditions for Interference of Waves", by Y. Hao, X. Qi-cheng, and L. Zhen-di, American Journal of Physics, Vol. 56, No. 8, August, 1988, pp. 745-747.

⁸² "Beats as Moving Interference Patterns", by T. Stein and L. Dishman, American Journal of Physics, Vol. 57, No. 7, July, 1989, pg. 584.

About the Authors

The guiding principle behind the work of the Corum brothers has been to reduce the publications and RF experiments of Dr. Tesla to conventional modern engineering terms. Together, they have published 3 books and several dozen technical articles about Tesla's work, and contributed to several other books on Tesla, ball lightning, and the history of electrosience. Their engineering analyses and replications of Tesla's slow-wave resonator and fire ball research has gained an international interest in the scientific community.

Kenneth L. Corum holds a B.A. in Physics from Gordon College (1977) and has done graduate work at the University of Massachusetts. He has taught computer electronics and digital techniques in England, France, Germany, Netherlands, and the United States. He is listed in **American Men and Women of Science** and **Outstanding Young Men of America**. Mr. Corum was Director of the Commercial TV Satellite Division of Pinzone

Communications, and he is now a consultant with Hewlett-Packard. He has spoken at Zagreb and at The Tesla Museum at Belgrade as a guest of the Serbian Academy of Sciences and Arts.



Ken Corum can be reached at 104 River Rd., Plymouth, NH 03264

Dr. James R. Corum has a BSEE (University of Lowell), MSEE and PhD in Electrical Engineering from Ohio State (1974). Dr. Corum was active in academia for 18 years, serving as an Associate Professor in the Department of Electrical Engineering at West Virginia University, and as a Professor in the Department of Electronic Engineering Technology at the Ohio Institute of Technology. While a faculty member in West Virginia, he received 11 outstanding faculty recognition awards, prizes and citations from the University, the Faculty, the Students and the Alumni.

He was a Senior Research Scientist with the Electromagnetics Department and a Research Leader in the Applied Physics Group at the Battelle Memorial Institute in Columbus, Ohio. Dr. Corum is a Senior Member of the IEEE, and a member of

the American Geophysical Union, the American Association of Physics Teachers, the American Society for Engineering Education, the Research Society of North America, and the Society of Motion Picture and Television Engineers.

He is listed in **Who's Who In Engineering**, **American Men And Women of Science**, **Leading Consultants In High Technology**, and 14 other biographical dictionaries. He currently holds five patents and has in excess of 90 technical publications.

86 Weirton Mine Rd., Morgantown, WV 26508



Ed note: For those interested in the specific equations in this article that may not be legible, visit www.IntegrityResearchInstitute.org or email: iri@erols.com

13 Tesla's ELF Oscillator for Wireless Transmission

James Corum, Ph. D.
Kenneth L. Corum
Reprinted from *Tesla: A Journal of Modern Science*, 1997

Introduction

For a scientist, Tesla was a prolific but abstruse and poetic writer. He left behind a considerable volume of technical and enigmatic descriptive writings, lectures, patents, articles and newspaper interviews. Additionally, his Colorado Springs diary and his Long Island notes provide a showcase through with the wealth of his creative mind may be viewed from our present technological perspective. Such remarkable situations rarely present themselves with such prolific documentation to future generations. In reading the Colorado Springs and Long Island notes, one feels as though he has just blown away the dust of the years and opened diaries of Columbus or Da Vinci. Before him sit the thoughts and experimentations of the powerful intellect which invented for modern civilization the electrical equivalent of the wheel—the rotating magnetic field.

It would be an understatement to say that an electrical engineer can certainly empathize with the excitement described by Carter as he peered through the chink in the wall of an Egyptian tomb and saw before him the treasures of Tutankamen. What we must ascertain, however, is whether Tesla's words, unlike Tutankamen's trinkets, are of any practical value to the scientific community today. Certainly they do reflect how he thought and interpreted his experiments and how his physical concepts led him to make the remarkable statements published subsequent to his Colorado Springs experiments. The fact that in addition to his Colorado Springs Diary, we also have the associated patent wrappers, special articles and later recollections, is of great importance. Any interpretation or speculation made today about his experiments must not only be internally consistent with these documents, but must also cement them together. This we take as a first requirement of speculation. Additionally, as a second requirement, such conjecture must be made within the bounds of accepted and verifiable physical principles. Tesla was, apparently, experimenting with potentials in excess of 12 MV. Not unlike Columbus, he was sailing in uncharted seas. The possibility of "peculiar physics" notwithstanding, our efforts have been to attempt to discuss Tesla within the framework of modern electrical theory. Whether the experimental results of Tesla were, in fact near-field induction coupling, or perhaps Schumann resonance excitation (as we believe) or some sort of magnetospheric stimulation, or even some peculiar presently yet unknown physical phenomenon—the fact remains, a significant portion of his apparatus was constructed of wire, capacitors, spark gaps, and tuned circuits. It ought to be comprehensible in its intent and physical operation. That he got high voltage RF from his circuits is clearly understandable. It follows from a straightforward network analysis. How he obtained the incredible ELF results which he subsequently claimed, however, is the chasm to be bridged.¹

¹J. Corum also holds patents #4,622,558, #4,751,515 (ELF toroidal antennae) - Ed. note.

Issues to be Resolved

Because of his repeated insistence on terrestrial extra low frequency resonances, it does not seem unreasonable to hypothesize that Tesla's experiments were actually carried out at this end of the electromagnetic spectrum. However, his indoor Colorado Springs apparatus clearly operated in the range of 30 KHz to 100 KHz, and the tower described in his diary was only 145 feet high. [1] With such an electrically short tower there could be no radiation at ELF. But, on the other hand, if it was merely a waveguide or cavity resonator probe, one would expect its radiation resistance to be zero. The radiation resistance of a cavity resonator probe is zero because the resonator fields are purely relative.

It has been observed that the photographs of the Colorado Springs Laboratory offer not clue as to how one might generate ELF energy. There is an even more fundamental issue to be resolved, however. The excitation of Schumann resonances by means of a vertical probe requires a considerable current moment. The question is, "Even if Tesla successfully generated ELF voltages how did he ever get significant ELF currents to flow on the vertical structure?" [2] One could not just connect an ELF source onto the base of a 45 meter tower - the feedpoint capacitive reactance would be so large that not current would flow. Yet, Tesla maintained on several occasions that his "antenna" current was well in excess of 1000 amperes! [By the way, there is a similar issue to be resolved for the reception of power. The Thevenin equivalent of a vertical receiving antenna may have a substantial ELF. However, the series capacitive reactance of vertical tower at ELF will preclude substantive power transfer in the sinusoidal steady state].

Lastly, we mention the curious inscription in Tesla's own handwriting along the side of a now famous photograph of the Colorado Springs Laboratory:

"Experimental Station fully developed. Activity [power delivery] one hundred thousand horsepower" [3]

How could he possibly deliver 74.6 megawatts? The 60 Hz power mains to the laboratory were operated at 1 kV, but his Westinghouse transformer was only rated at around 40 kVA.

In the remainder of this article, we wish to speculate on how these issues could be resolved within the bounds of consistency with the historical documents mentioned above. The reader will have to judge whether we have successfully met the second requirement - that of conjecture based on acceptable physics.

Tesla's Descriptions of His Oscillator

Tesla described his electrical oscillator on many occasions and in many different places. It is clear that, as early as 1893, he was considering terrestrial responses:

"If ever we can ascertain at what period the earth's change, when disturbed, oscillates... we shall know a fact possibly of the greatest importance to the welfare of the human race..I propose to search for the period by means of an electrical oscillator." [4]

In the years between 1893 and 1900, he developed the coupled tuned transformer [or Tesla Coil], published the results of his extensive experiments with x-rays, contributed to the conceptual development of cosmic ray, patented a variety of circuit controllers [rotary spark gaps] and was sought out by members of the scientific and social communities, both of which he continued to dazzle with his latest electrical discoveries. These were the golden years of his

professional career, and they found a focal point in experiments at Colorado Springs. It is here, where he finally was able to assemble the apparatus which, he maintained to his dying day, permitted him to ascertain terrestrial natural resonant frequencies.

In 1900, he disclosed that his apparatus could be operated in a variety of configurations to perform many different types of desired functions:

"Thus a transformer or induction coil on new principles was evolved, which I have called 'the electric oscillator'... the essential parts of which are shown in Fig. 6. For certain purposes a strong inductive effect is required; for others the greatest possible suddenness; for others again, an exceptionally high rate of vibration or extreme pressure; while for certain other objects immense electrical movements are necessary... I have produced electrical movements occurring at the rate of one hundred thousand horsepower..." [5]

By the way, the "essential parts" shown in the photograph referred to appear to be his Westinghouse transformer, a rotary break, a capacitor bank and a circular fence upon which the secondary was wound.

Perhaps the most curious of all his descriptions of the terrestrial resonance oscillator was published in 1919:

"It is a resonant transformer with a secondary in which the parts, charged to a high potential, are of considerable area and arranged in space along ideal enveloping surfaces of very large radii of curvature, and at proper distances from one another thereby insuring a small electric surface density everywhere so that no leak can occur even if the conductor is a bar. It is suitable for any frequency from a few to many thousand of cycles per second, and can be used in the production of currents of tremendous volume and moderate pressure or of a smaller amperage and immense electromotive force. The maximum electric tension is merely dependent upon the curvature of the surfaces on which the charge elements are situated and the area of the latter.

"Judging from my past experience, as much as 100,000,000 volts are perfectly practicable. On the other hand, currents of many thousand of amperes may be obtained in the antenna...the Hertz-wave radiation is an entirely negligible quantity as compared with the whole energy... an enormous charge is stored in the elevated capacity. Such a circuit may then be excited with impulses of any kind, even of low frequency and it will yield sinusoidal and continuous oscillations like those of an alternator...it is a resonant transformer...accurately proportioned to fit the globe and its electrical constants and properties, by virtue of which design it becomes highly efficient and effective in wireless transmission of energy". [6]

What we are to make of this? Based upon the available electrical output of his extra coil and the reports of spark lengths measured 100 meters away from the Colorado Springs Laboratory, we estimate that the charge stored in the elevated capacity was probably on the order of 20 millicoulombs. But how was this to be used to excite terrestrial resonances? The apparatus so furtively described in 1919 is probably a near relative of that for which he sought protection by a patent application in 1902, and which subsequently issued at the close of 1914.

[7]

Directed Energy Devices

We believe that the evolution of these ideas continued to be a central activity of Tesla's later years. It is merely our opinion, but we find it difficult to accept the senility hypothesis

concerning his motivation to reach for the goals of these final years. It seems probable that the apparatus which so concerned his thoughts at this time, not only was a successive conceptual development of his prior oscillators, but any credible knowledge ginned about these later structures would probably throw light on the operation of the earlier experiment - no matter how improbable his final research might have been. We believe that Tesla's surprisingly detailed 1934 analysis of the Van Der Graaft's [then] new machine, published in Scientific American, lends support to the hypothesis that he was still technically alert and deeply engaged in high voltage research. [8]. Perhaps we are not being specific enough for the ready The apparatus which Tesla's final disclosures concerned has come to be known as the "Death Ray". Whether there be any actual merit to such contraptions, we leave for others to speculate upon. Our interest in Tesla's thoughts on "directed energy devices" rest upon the proposition that they might shed light upon his terrestrial resonance oscillator. In 1927, Tesla said:

"More than twenty five years ago my efforts to transmit large amounts of power through the atmosphere resulted in the invention of a great promise, which has since been called 'Death Ray'... The underlying idea was to render the air conducting by suitable ionizing radiations and to convey high tension currents along the path of the rays. Experiments conducted on a large scale showed that with pressures of many millions of volts virtually unlimited quantities of energy can be projected to a small distance, as a few hundred feet..." [9]

From a variety of published references, spanning the years from 1934-1940, we gather that Tesla envisioned a machine, which required the cooperative action of four separate entities. Again, our interest is not in the feasibility of such an apparatus, but rather in how he thought such a device was to work and what, if any, light it might shed on his terrestrial resonance oscillator experiments. The four elements specified by Tesla are as follows:

1. "A Method and an Apparatus for producing rays and manifestations of energy in free air (eliminating the necessity of the usually required vacuum tubes)."
2. "A Process and an Apparatus for producing very great electrical force (50 MV). This is necessary to power the first mechanism."
3. "A method of intensifying and amplifying the force developed the by second mechanism"
4. "A new method for producing a tremendous repelling force."

It is perhaps not unremarkable that these components are quite similar to the description provided by John G. Trump, when he examined Tesla's estate. He described the "Death Ray" as:

"An electrostatic method of producing high voltage, capable of very great power... As a component of this apparatus there is an open end vacuum tube... A beam of high energy electrons is the... means by which energy is transmitted through natural media" [10]

It should be parenthetically remarked that Tesla explicitly denied that his apparatus was a "Ray" as indicated below:

"This invention of mine does not contemplate the use of any so called 'Death Ray.' Rays are not applicable because they cannot produce in requisite quantities and diminish rapidly in intensity with distance... My apparatus projects particles.. "[11]

We started out discussing electrical oscillators and now find ourselves confronted with "direct energy devices". Perhaps this is not surprising when we observe that Tesla's early x-ray researches involved the use of his "single electrode X-ray tube" attached to the top of a resonant Tesla coil.

The Single Electrode X-Ray Tube

Between March 11, 1896 and August 11, 1897, Tesla wrote at least 10 articles about his x-ray experiments. There is an explanation for the development of a single electrode tube in the March 11, 1896 issue of *Electrical Review*. Tesla saw that in order to attain the most intensive effects, one should use the greatest voltages available.

"Clearly, if we put two electrodes in a bulb, or use one inside and another outside electrode, we limit the potential... Thus, to secure the result aimed at, one is driven to the acceptance of a single electrode bulb, the other terminal being as far remote as possible". [12]

Tesla later hinted at the manner in which the tube was excited: "...in 1896, I brought out a new form of vacuum tube capable of being charged to any desired potential and operated it with effective pressures of 4,000,000 volts [13]

And in a 1913 newspaper interview, Tesla said:

"As far back as 1897, I disclosed before the New York Academy of Sciences the discovery that Roentgen, or x-rays projected from certain bulbs have the property of strongly charging an electrical condenser at a distance. The energy so accumulated readily can be discharged." [14]

We know today, of course, that x-rays are high energy photons and have neither rest mass nor charge. The question before us, however, is "How might these single electrode tubes produce x-rays?"

In a standard x-ray tube of the Coolidge type, a heated filament provides electrons which are then accelerated and strike an anode target. If an AC supply is employed, x-ray emission occurs only during the positive half cycle. However, Tesla's tube had only one electrode. We hypothesize that the tube's operation probably depended upon the quantum mechanical phenomenon of High Field Emission. One might suppose that during half of the RF high voltage cycle field emission could possibly occur into the region of high vacuum elongated bulb, and on the positive half cycle the cloud of electrons might be swept back into the "plain polished surface on the front side of a hemispherical aluminum electrode" with an ensuing emission of hard x-rays. This is only a hypothesis and certainly its acceptability needs to be closely examined.

There is evidence that, during the course of his New York city experiments, Tesla took to surrounding these tubes with an insulated shield in order to reduce corona losses. He called this "static screening". The configuration is quite similar to that discussed in the Colorado Springs notes on June 6, 1899:

"Arrangements with single terminal tube for production of powerful rays. There being practically no limit to the power of an oscillator, it is now the problem to work out a tube so that it can stand any desired pressure... The best results will probably be obtained in the end by static screening of the vulnerable parts of the tube. This idea was experimented on in a number of ways... In each case there would be an insulated body of capacity so arranged that

streamers cannot manifest themselves. The capacity would be such as to bring about maximum rise of e.m.f. on the free terminal" [15]

The associated figure shown in the diary entrance indicates a [square!] container with the comments:

"Metallic Enclosure but insulated so that observers can step inside" [15] Little more can be inferred from the diary about x-ray experiments until November 23, 1899. Finally, on January 2, 1900, Tesla states,

"...my conviction is growing stronger every day that, with apparatus such as the present, wonderful results must be secured provided only that a tube is constructed capable of taking up any amount of energy... Many tubes have been worked here from the secondary." [16] In a later interview, Tesla said concerning the Colorado Springs experiments: " At the time of those test, I succeeded in producing the most powerful x-rays ever seen. I could stand at a distance of 100 feet from the x-ray apparatus and see the bones of the hand clearly with the aid of a fluoroscope screen... I now have apparatus designed whereby this tremendous energy of hundred of kilowatts can be successfully transformed into x-rays." [17]

What he was doing with these x-rays? In light of the comments by Tesla regarding charge transfer by x-rays, it does not seem unreasonable to hypothesize that a small aperture in the conducting enclosure would permit the emission of x-rays to the exterior region, causing x-ray photoionization of the atmosphere near the enclosure, these ions providing a short conducting discharge path for the charged "insulated body of capacity". It is clear from Reference 13, that Tesla was observing "coronal discharges" exterior to his single electrode tubes. This process could clearly be employed to instantaneously lower the disruptive potential of an isolated spherical capacitor, and to initiate a discharge into the air of to a nearby isolated electrode at a lower potential than the given sphere. Perhaps it is not surprising that this process has been of recent interest in x-ray and IJV laser triggered switching of high voltages. The latter being particularly interesting because capacitances charged into the megovolt range can be triggered with nano second switching delays and with subnanosecond jitter.

On January 4, 1900, Tesla experimented with a ball on the top of the extra coil, "... very brilliant and thick sparks passing from the ball to the hood above". Tesla continued that the discharge was "highly sensitive" to, among other things, "Roentgen rays" [another name for x-rays]. Is it possible that Tesla was employing x-rays as a switching mechanism to statically charge his tower? The tower appears to be an "elevated insulated body of capacity". This, we hypothesize, is the x-ray charging mechanism which Tesla sought to protect in his two U.S. patents disclosures No. 685,957 and No. 685,958.

The X-Ray Patents

In March of 1901, Tesla filed two patent applications concerning x-ray devices. One was for a "Method" and one was for an "Apparatus" for the "Utilization of Radiant Energy". They describe in considerable detail a remarkable technique for switching high voltages and for charging and discharging and "elevated insulated body of capacitance".

Consider, for example, an isolated sphere. Such a body may be charged to a certain electrical potential with respect to a zero potential reference, taken as infinitely distant. In such a system the spherical conductor may be charged to a certain potential before the electric field intensity gives rise to a force great enough for the surrounding air to break down and "disruptively" discharge the sphere. Tesla found by experiment that the disruptive potential, in volts, for a sphere at sea level could be approximately calculated as $7,540,000 R$, where R is

radius of the sphere in meters. Tesla, in fact, reported that he kept a variety of spheres around to use both as capacitors and in order to estimate the voltages used in his experiments.

A practical form of high voltage capacitor may be constructed by elevating an insulated spherical conductor above the surface of the earth. It is an elementary problem in electromagnetics to calculate the field and capacitance of such a charged system. In this configuration the "capacitor" effectively has "true ground" as one terminal and the conducting spherical ball itself forms the second "armature" or terminal of the distributed capacitor. This form of capacitor may be charged up by bodily conveying charge of one sign to the elevated sphere. Alternatively, it may be discharged simply by bringing the grounded conductor close enough to the sphere for arcing to occur.

Bearing this in mind, Tesla's x-ray patents take on a meaningful interpretation:

"It is well known that certain radiations such as...Roentgen rays... possess the property of... discharging conductors... They ionize or render conducting the atmosphere through which they are propagated... they may at any rate discharge an electrified conductor... by carrying off bodily its charge... When rays of the above kind are permitted to fall upon an insulated conducted body connected to one of the terminals of a condenser... a current flows into the condenser... an indefinite accumulation of electrical energy in the condenser takes place. This energy after a suitable time interval, during which the rays are allowed to act, may manifest itself in a powerful discharge ...taking every possible precaution in insulating the armatures, so that the instrument may withstand great electrical pressure without leaking and may leave no perceptible electrification when discharging instantaneously... the above precautions should be more rigorously observed the slower the rate of charging and the smaller the time interval during which the energy is allowed to accumulate in the condenser... A simple way of supplying...electricity is to connect...to an insulated conductor supported at some height in the atmosphere...I usually connect the second terminal of the condenser to ground... in order to utilize... the energy accumulated in the condenser, I furthermore connect on the terminals of the same... another instrument or device for alternately closing and opening the circuit... if the device ... be of such character that it will operate to close the circuit... when the potential in the condenser has reached a certain magnitude, the accumulated charge will pass through the circuit... The controller may consist of two fixed electrodes separated by a minute air gap...which breaks down more or less suddenly when a definite difference of potential is reached at the terminals of the condenser and returns to its original state upon the passage of discharge". [18]

Tesla then describes the manner of excitation of his single electrode x-ray tube:

"... the source of radiant energy is a special form of Roentgen tube devised by me, having but one terminal K, generally of aluminum, in the form of a half sphere, with a plain polished surface on the front side from which the streams are thrown off. It may be excited by attaching it to one of the terminals of any generator of sufficiently high electromotive force." [18]

Tesla continues, describing the operation of the apparatus:

"The... discharge circuit connected to the terminals...of the condenser includes in this case... a circuit controller comprising a fixed terminal or break... and a movable terminal _____ in the shape of a wheel, with a conducting and insulating segments, which may be rotated at an arbitrary speed by any suitable means.... When the tube ...is excited...streams of matter ... convey a positive charge to... the condenser terminal...This results as before explained in

an accumulation of electrical energy in the condenser, which goes on as long as the circuit is opened. Whenever the circuit is closed owing to the rotation of the wheel the stored energy is discharged... The source may be any form of Roentgen or Lenard lube but it is obvious from the theory of action that in order to be very effective the electrical impulses exciting it should be wholly or at least preponderantly of one sign. If ordinary symmetrical alternating currents are employed, provision should be made for allowing the easy to fall upon the condensed plate only during those periods when they are productive of the desired result." [18]

What we make of this is that Tesla is describing a technique to take the high voltage RF output of the secondary and use it to charge up an "elevated insulated body of capacitance" - essence, an open air switch or diode rectifier. After charging the capacitor, at RF rates, he subsequently discharges the capacitor, at relatively low pulse repetition frequencies (PRF's) for example at perhaps 6 or 8 discharges per second — or any other that he might desire. The companion patent is also interesting. [19]

It is also somewhat revealing that Tesla said in his Van de Graaf article in 1934 that:

"My wireless tower on Long Island erected in 1902, carried a sphere which had a diameter of 67.5 feet... It was to be charged to 30,000,000 volts by a simple device supplying static electricity and power" [8]

After analyzing the Van de Graaf machine he concedes that it produces large static voltages but concludes that its power performance is trifling - the rate of charge delivery to spherical electrode being on the order of a few tens of milliamperes.

"As far back as 1899, I made experiments with 18,000,000 volts and in some tests I was able to pass a current of 1100 amperes through the air. With my transformers a potential difference of 30,000,00 volts or more, could easily be obtained and in the present state of the technical arts a tube or other device capable of taking up very great energy might be manufactured". [8]

By the way, diary schematic diagrams notwithstanding, it is evident that neither the elevated tower at Colorado Springs nor the 67.5 foot diameter sphere on the tower at Wardenclyffe were electrically connected to the extra coil when in operation. This is also borne out by the Long Island notes of May 29, 1901 where Tesla shows an elevated insulated body of capacitance being charged through space from a ball on the top of an extra coil. The spacing between these elements is shown to be a controllable distance- perhaps this was the purpose for the stream elevated shaft at the center of the Wardenclyffe tower. The geometry is not unlike that shown in Figure 5 of Reference 20. It is well known that drawn out electrical discharges will affect rectification much as point to plane discharge. However, the process is usually considered too inefficient.

An ELF Generator

Whatever the rectification mechanism might have been one might hypothesize an ELF generator which employs the charging mechanism just discussed. Such a charging technique could have been used to electrostatically charge the tower with "small" pulses of charge occurring on the positive half cycles of the RF coil oscillations. This would build up the static charge of the tower at some large Q at a very high DC voltage. When discussing the upper hood configuration on Nov. 28, 1899, Tesla said:

"This arrangement permitted the charging of the pole easily up to a million volts." [21]

If Tesla were to discharge the condenser at a much slower frequency, the discharge current could be extremely large, being limited only by his ground bed resistance. This hypothesis is consistent with a public statement made by Tesla in 1934 in Scientific American:

"... Under proper conditions, it is possible to discharge spheres in a time interval incomparably shorter than consumed in charging them, and so amplify enormously the intensity of action." [8]

This is to say, the rate of flow of energy during the charging cycle might be at 75 kilojoules per second over 1 sec... but the rate of flow of energy during the discharge cycle could be at a rate of 75 Megajoules per second over a time interval of 1 millisecond. In both cases, the average power is 75 kW but the peak power during the discharge activity would be about 100,000 HP.

As early as 1893, in the Franklin Institute lecture, Tesla described an electrostatic pulse generator which was repetitively charged with a small amount of energy per charge, at a high pulse repetition rate, and then rapidly discharged but at a low pulse repetition rate.

This would make possible extremely large peak powers on the discharge cycle. In his speech, Tesla is describing the situation where a large condenser has been charged up to its disruptive potential by a small machine supplying static charge:

"When the condensers are charged to a certain potential, air gives way and a disruptive discharge occurs. There is then a sudden rush of current and generally a large portion of accumulated electrical energy spends itself. The condensers are thereupon quickly charged and the same process is repeated in rapid succession...It is evident that if the rate at which the energy is dissipated by the discharge, is very much greater than the rate of supply to the condensers, the sudden rushes will be comparatively few, with long time intervals between, This always occurs when a condenser of considerable capacity is charged by means of a comparatively small machine." [22]

Several paragraphs later, Tesla continues the description with a hydromechanical oscillator analogy:

"...Imagine a tank with a wide opening at the bottom, which is kept closed by spring pressure, but so that it snaps off suddenly when the liquid in the tank has reached a certain height. Let the fluid be supplied to the tank by means of a pipe feeding at a certain rate. When the critical height of the liquid is reached, the spring gives way and the bottoms of the tank drops out. Instantly the liquid falls through the wide opening and the spring, reasserting itself, closes the bottom again. The tank is now filled and after a certain time interval, the same process is repeated." [23]

Thus it appears that Tesla had conceived of a technique for obtaining large discharge currents with controlled pulse repetition frequencies. The vertical discharge current would produce a vertical current of moment $I \cdot dl$. This signal, we hypothesize could be controlled at an appropriate pulse repetition frequency for Schumann Cavity excitation. The controller, as described in Tesla's patents quoted above could either be "operated by a given rise of potential in the condenser." (Effectively an ELF relaxation oscillator) or "by rotation of the wheel" (break device).

In spite of the fact that our hypothetical ELF generator has some merit for satisfying the internal consistency hypothesis which we stated earlier as a ground rule, its acceptability must be measured against the second requirement of sound physics. Tesla said that he got over 1000 amperes in his "antenna." Schumann's solution is in the sinusoidal steady state and even 1000 amperes in a 45-meter tower would seem to make possible relatively weak global field strengths. We have taken up this issue in another research document.

(Interestingly, however, if one looks at this hypothetical ELF generator as a fundamental form of the "switched capacitor" devices now of such great interest, the switched charged $dQ = C dV$. Over a period which is much larger than the switching period T_s , the charge may be assumed to be quasi-continuous so that an equivalent current flow is equal to dQ divided by T_s . The equivalent resistor is T_s divided by C . [24] The application of the theory, however, requires careful attention in Tesla's case if damped waves are assumed at the RF output of the extra coil.)

We observe that if our hypothesis is correct, then it is not remarkable that Tesla would have said:

"such a circuit may then be excited with impulses of any kind, even low frequency and it (the magnifying transmitter) will yield sinusoidal and continuous oscillations like those of any alternator." [6]

If our conjecture has any substance in fact, then the tuned circuit of his magnifying transmitter was the whole earth-ionosphere cavity resonator] (This should help the reader appreciate why source dissipation will be experienced only when a load is engaged in a tuned receiver somewhere within the earth-ionosphere cavity. - Ed. note)

Corona Effects

There is one other observation to make about his "Magnifying Transmitter" and that is that its upper regions were engulfed in a coronal glow. In Colorado Springs and at Wardenclyffe he employed hoods to reduce corona. At Wardenclyffe, he had apparently planned to employ inverted hemispherical bowls to cover the spherical ball. In 1921, he said that "the underlying principle" and the "practical significance" of his 1914 patent #1,119,732 [7] was a technique "for confining the highest tensile flow to the conductors." He stated that the idea was to construct a conductor:

"... so that its outer surface has itself a large radius of curvature, or is composed of separate parts, which, irrespective of their own curvature, are arranged in proximity to one another and on an ideal enveloping symmetrical surface of large radius. These parts may be in the shape of shells, hoods, discs, cylinders or strands... [25]

We take it that the role of all the hemispherical shells in the 1914 patent was perhaps to physically bring about a more uniform distribution of charge over the sphere than could have been gotten with a lower portion missing because of the supports. If this be so, then they apparently would function in a distributed manner much like resistive dividers in a power supply capacitor chain, more or less causing a uniform charge distribution over the effective area of the sphere, and raising its disruptive potential to a maximum possible value. This would mean that a given size ball on a support could be charged to a greater maximum voltage.

Speaking of corona, we should also point out another curious feature of the Colorado Springs experiments.

From the patent wrappers associated with U.S. patent # 645,576, it is apparent that Tesla included a remarkable description of a rather extensive corona sphere surrounding his "elevated and insulated" antenna terminal, sometime before November 25, 1899. [26]

"... a conductor or terminal, to which impulses such as those here considered are supplied, but which is otherwise insulated in space and is remote from any conducting bodies, is surrounded by a luminous, flamelike brush or discharge, often covering many hundreds of even as much as several thousands of square feet of surface... This influence is not confined to that portion of the atmosphere which is discernable by the eye as luminous and which, as has been the case in some instances actually observed, may fill the space within a spherical or cylindrical envelope of a diameter of sixty feet or more but reaches out to far remote regions, the insulated qualities of the air being, as I have ascertained, still sensibly impaired at a distance of many hundred times that through which the luminous discharge projects from the terminal and in all probability, much further... I have noticed that his region of decidedly noticeable influence continuously enlarges as times goes on... in some instances the area covered by the flame-discharge mentioned, was enlarged more than six-fold by an augmentation of the electrical pressure amounting scarcely to more than 50%" [27]

Tesla apparently observed a corona sphere in excess of sixty feet in diameter. The space charge distribution apparently was due to the extremely high static or DC voltage on the elevated electrode. We conjecture that both its mode of production and its use were as outlined above.

The Tesla Tower

During the mid 1930's Tesla's work on a defense weapon apparently went so far as to be actually considered for construction. From file at the Tesla museum, it is apparent that Tesla had several "artist conceptions" made of a building with a tower in the form of a cylinder 16.5 feet in diameter, 115 feet tall. The structure was capped at the top by a 10-meter diameter sphere (covered with hemispherical shells as in the 1914 patent). The sketches were prepared by on Titus de Bobula of New York City. There is also correspondence with Alcoa Aluminum Company between July 29 to September 24, 1935, concerning fabrication, the last letter in essence saying that Alcoa was ready to start as soon as Tesla advanced the funds.

Whether the project would have been another disaster or not, we have no ideas. Since we have already gone this far out on a limb of speculation, permit us to conjecture what Tesla might have had in mind. We listed four components that Tesla maintained were essential. With the first, one might associate the Method (Patent #685,958) and Apparatus (Patent #685,957) for producing x-rays and providing rectification. With the second, one might associate the Process (#649,621) for producing high voltage RF - i.e. the Tesla Coil patents. Certainly Tesla powered his x-ray tubes from the top of Tesla Coils.

These four components are mentioned in at least four references during 1934 - at time when he was thinking and writing about the Van de Graaf machine. Perhaps it is not surprising to find the same language as appears above in component three also appearing in reference 8:

"...under proper conditions, it is possible to discharge spheres in a time interval incomparably shorter than consumed in charging them and so amplify enormously the intensity of the action. [8]

Certainly as pointed out above, this would be consistent with the second item.

To guess what the fourth component is would be shooting in the dark. However, let us go even further out on the limb and suggest that Tesla was perhaps employing a technique to rapidly lower the disruptive potential of a statically charged electrode. As is evidenced by the diary entrance of June 6, 1899, Tesla had already experimented along these lines. For example, suppose that one had a charged, insulated spherical shell in static equilibrium, and then rapidly punctured the shell with a very slender highly conductive track or path. (Or equivalently introduced, a charge of like sign immediately external to the sphere). The question to be answered is "Would a 32-foot diameter sphere charged to 50 MV produce sufficient repelling force for the contemplated weapon?." This question can probably be answered but, we have not yet performed the calculation. The answer might be no.

Final Comments

We have gone well beyond the bounds of propriety in our speculations. However, we believe that considerable light may have been thrown upon the intent and operation of Tesla's terrestrial resonance oscillator. If we have been able to provoke the reader to probe more deeply into Tesla's research, then we feel that we have attained some degree of success.

Lastly, no matter what the results or scientific merit of our research, whether every speculation be false or perfectly true, we all must never lose touch with the central fact that Tesla was a man whose creative intellect was set free to soar.

Truly, he touched the Holy Fire - and the world community is better off because of this good and decent and noble gentleman, whom we honor at this Tesla Centennial Symposium.

References

1. Colorado Springs Notes, by Nikola Tesla, Nolit, Beograd, 1978pp. 192;226-227
2. I am indebted to Professor Vojin Popovic of Belgrade University for asking this insightful question.
3. Reference 1, p. 364.
4. "On Light and other High Frequency Phenomena" by Nikola Tesla, delivered before the Franklin Institute, Philadelphia, PA February 1893, and the National Electric Light Association, St Louis March 1893. Republished in *Inventions, Researches and Writings of Nikola Tesla*. By T.C. Martin, Omni Publications, (1977) p. 347
5. "The problem of increasing Human Energy" by Nikola Tesla, *The Century Illustrated Monthly Magazine*, June 1900, p. 208.
6. "My Inventions, Part V -" *The Magnifying Transmitter*" by Nikola Tesla , *The Wireless Experimenter*. June 1919, pp 112, 113, 148,173, 176, 177, 178.
7. "Apparatus for Transmitting Electrical Energy", Nikola Tesla, U. S. Patent # 1119,732. Application filed January 18, 1902; Patented December 1, 1914.
8. "Possibilities of Electrostatic Generators" by Nikola Tesla, *Scientific American*, March 1934, pp.132-134; 163-165; and April 1934 p. 205.
9. "World System of Wireless Transmission and Energy" by Nikola Tesla, *Telegraph and Telephone Age*, October 16, 1927, pp.457-460. See page 459.

10. Abstract of notes by John G Trump, quoted in Tesla, Man out of Time by Margaret Chaney, Prentice Hall, 1981 p. 275.
11. " A Machine to End War" by Nikola Tesla, Liberty Magazine, February 1935, pp. 5-7
12. "On Roentgen Rays" by Nikola Tesla, Electrical Review, March 11, 1896 pp 131, 134, 135.
13. "Nikola Tesla tells of New Radio Theories" NY Herald Tribune, Sunday, September 22, 1929. pp. 1,21.
14. "Nikola Tesla Plan to keep Wireless Thumb on Ships at Sea" New York Press, November 9, 1913.
15. Reference 1, Page 29 (June 6, 1899).
16. Reference 1, Page 365 (January 2, 1900).
17. "Tesla's Views on Electricity and the War" by H.W. Secor Electrical Experimenter, August 1917, pg 270.
18. "Apparatus for the Utilization of Radiant Energy" Nikola Tesla, US Patent # 685,957. Applied for March 21, 1901 granted November 5, 1901.
19. "A Method of utilizing Radiant Energy" Nikola Tesla, US Patent # 685958. Applied for March 21, 1901, granted November 5, 1901.
20. "Lightning Protector" Nikola Tesla , US Patent # 1266,175 Applied for May 6, 1916, granted May 14, 1918.
21. Reference 1 p. 322 (November 26, 1899).
22. Reference 4 p. 304
23. Reference 4 p. 309
24. "Switched -Capacitor circuit design" by R Gregorian, K.W. Martin and G.C. Temer, Proceedings of the IEEE vol 71, No.8 August 1983 pp. 941-966
25. "Nikola Tesla on Electrical Transmission" Letter to the Editor, New York Evening Post, September 26, 1921. Republished in Tesla Said, edited by John T Ratzlaff, Tesla book Company, 1984, p. 224.
26. Dr. Nikola Tesla- Selected Patent Wrappers compiled by John T Ratzlaff, Tesla Book Company, 1980, Vol 1 pp. 166, 168-187
27. "System of Transmission of Electrical Energy" Nikola Tesla , U.S. Patent # 645,576. Applied for September 2, 1897, granted on March 20, 1900.

James Corum can be reached at 86 Weirton Mine Rd., Morgantown, WV 26508
 Kenneth Corum can be reached at 104 River Rd., Plymouth, NH 03264

14 Harnessing Earth-Ionosphere Cavity Energy for Wireless Transmission

Elizabeth Rauscher and William Van Bise

Reprinted from *Tesla: A Journal of Modern Science*, 1997

Fundamental Excitatory Modes of the Earth and Earth-Ionosphere Resonant Cavity

Some of the principles of geologic precursor and meteorologic frequencies in the extremely low frequency (ELF) range of the electromagnetic spectrum and the possible relationship to the occurrence of earthquakes and volcanoes are explored. Monitoring of electromagnetic waves and magnetic fields has indicated the presence of characteristic natural and unique ELF frequencies which precede seismic events.

We have gathered extensive ELF magnetic field data from 1979 to the present time in many locations on the North American continent before the eruptions of Mt. St. Helens. The pre-eruptive and eruptive phases of Mt. St. Helens in the state of Washington were observed and analyzed in detail. Our system was on-line in the Portland, Oregon area, 40 miles south west of Mt. St. Helens, from 1979 through 1983 and on line in the San Francisco Bay Area from 1984 to the present.

Field measurements have augmented the permanent station data. The detection system utilizes a 150,000 foot antenna wound on a coil form adjacent to a very high permeability mu metal and the signal is passed into unique electronic processing elements which amplify and smooth the signal for flat response and permit readout and analysis in the time and frequency domains. The coil is electrically shielded so that pure magnetic field intensities are observed. The long-axis coil-core system allows directivity as well as high sensitivity. These are the main elements in the T-1050 detection system.

We have observed that characteristic ELF magnetic field oscillations with Earth rotational periods from 1.2 to 1.8 Hz, determined theoretically and subsequently measured at around 1.56 Hz with first harmonics of 2.9 to 3.8 Hz appearing in the Americas which grow greater in amplitude and then disappear from 24 to 72 hours preceding a geologic event. The amplitude of these oscillations is roughly proportional to the distance from measurement to event site and event magnitude. Multi-station detection could forecast locations, time and magnitude of impending events.

We also present some of our theoretical calculations related to the description of coherent collective modes of oscillation in the earth and earth-ionosphere resonance media. We will also examine some of our work in relation to Tesla's wireless energy transmission concepts of harnessing earth-ionospheric cavity energy.

Introduction

Extensive monitoring in areas of the Pacific Northwest during the period of time from early 1979 through late 1983 was conducted by Van Bise. The measured signals showed significant correlation between the volcanic activity of Mt. St. Helens and a range of frequencies between 0.1 and 30 Hz, with the frequency of approximately 3 Hz corresponding to, presumably, magmatic pulsations which

preceded eruptive events. Researchers at Portland State University examined the volcanic ash after the May 18, 1980 eruption and found the ash contained 30% of a material similar to magnetite. In the state of Washington on Sunday morning, 8:32 AM, Pacific Daylight time, May 18, 1980, Mt. St. Helens erupted in a cloud of fire, ash, steam and particulate matter that launched a half a cubic mile of this matter laterally and one quarter of a cubic mile of the volcano's mass was ejected vertically, to a height of 10 miles. When this event was complete, 1,000 feet of the mountain had disappeared and 60 people were dead. Future deployment of detection equipment such as is described here could prevent such a loss of life. [1,2,3]

Since then Rauscher and Van Bise have monitored ambient field impulses in California and many other areas of the United States and Canada. The data show a significant correlation with specific signatures which preceded earthquakes and volcanic eruptions. The pattern of signatures always ceased some 24 to 72 hours before such an event occurred.

Equipment used consisted of a calibrated T-1050-L-H magnetic field detector with a lower frequency range from 0.01 Hz to 300 Hz and a sensitivity factor of 10^{-10} gauss (Low pass system) and a higher frequency range from 1.0 Hz to 50 KHz at 10-6 gauss sensitivity (High pass System) was developed and employed at Tecnic Research Laboratories. The detector specifications are given in more detail later in this paper. Other equipment included a custom designed electrostatic voltmeter, a field intensity meter and two spectrum analyzers. [4,5,6]

The natural planetary impulses and vibrations preceding geologic events suggest that work with multi-station detection can lead to the successful development of an earthquake-volcanic eruption early warning system. We use our magnetic field detector to measure magnetic field changes, some of which reflect oscillatory modes of the earth. These modes of oscillation can be detected as seismic magnetic and electromagnetic pulsations of the earth and earth's surface which move in the earth's normal static magnetic field and the Earth's ionosphere resonance cavity. Movement of magmatic material with ferromagnetic (magnetite) inclusions and corresponding ionospheric changes in turn affect and produce flux fields which affect the entire earth ionospheric processes. [5,7]

In this report, the authors present experimental field data and their analysis and theoretical models demonstrating possible mechanisms of the dynamic earth processes. We also examine the relationship between the results of these data and Tesla's wireless energy transmission concepts.

The ground wave and the ionospheric wave are set up in such a manner as to produce the predicted 1.57 ratio to the velocity of light which was stated by Tesla in one of his 1905 patents. [8] In his model, Tesla treated the earth as a finite capacitive reactive component surrounded by an ion shell of variable altitude, beginning at about 50 km in height, which represents a system whereby a resonant ringing signal can be set up and transmitted. Although the system represents a leaky capacitor with a Q of about 4 to 5, it is possible to set up a resonant state so that it appears as though a signal is transmitted and received from any two points on the earth's surface. In actuality, according to the Rauscher-Van Bise model, the signal is not "transmitted and received," but represents a non-local global coherent state. Any event which can "wobble" the static earth-ionospheric magnetic flux is transmitted as both a local and non-local influence.

In 1966, Rauscher determined the relationship expressed by Tesla in the Colorado Springs Notes in which he utilizes the dimensions in centimeters to represent the units of inductance, "L" in henries and capacitance, "C" in farads. This conversion factor system has been found to be crucial in understanding the principles involved in Tesla's Colorado Springs experiments. The purpose of the experiments and why, to this day, they have never been successfully completed is given. Also explained in detail is the interpretation of Tesla's work and the operation of his

wireless energy device. Rauscher presents the mathematical principles germane to producing ball lightning from a fully ionized resonant stable plasma. [9] This research is summarized in this report and is detailed more completely in other papers. [9,10,11,12]

Tesla's Colorado Springs experiments are examples of a class of coherent state experiments and other experimental examples are discussed. Although much of Tesla's notes and data were lost, "confiscated" or presented briefly and in a cryptic manner, enough information exists to reconstruct some of Tesla's principles and his planned experiments so that we can describe the unfinished phase of Tesla's work. [13] The Tesla materials relevant to this presentation is from the time period of about 1897 to 1910.

Tesla's Vision

In 1905, Tesla described the earth as a finite small capacitance with regard to frequencies in the VLF region, and a resonant LRC system to ELF frequencies. He had hoped to utilize the VLF and ELF frequencies in concert simultaneously to provide a very large conduit through which nature's vast reservoir of electrical forces could be routed for the benefit of mankind. Tesla observed that nature's electrical system is activated by lightening storms or through other meteorologic and geologic activity. The type of system originally designed by Tesla could have acted as a "great energy siphon" by exciting the ionosphere and intervening media and then, by tapping into the flow of this immense reservoir of energy and tunneling it down to earth stations, mankind would today have all the "clean" energy necessary with which to put his machines to work. Tesla's visions, confirmed by his experiments at Colorado Springs in 1899 and by his life-long extraordinary ability in constructing electrical and mechanical devices, led him to develop ideas and concepts for his wireless energy transmission which he described in his patents and papers. In his words,

Now that I have discovered that, notwithstanding its vast dimensions and contrary to all observations heretofore made, the terrestrial globe may be in a large part or as a whole behave(s) toward disturbances impressed upon it]n the same manner as a conductor of limited size; this fact being demonstrated by novel phenomena which I shall hereinafter describe. [8]

With the formulation in this patent, Tesla treated the earth as a finite capacitor and as an element of a circuit. Through the legalities of patent law, Tesla had patented the earth! Use of his device to harness the energy of the earth was not to be, however, and we may be poorer for this undeployed natural resource. He had exclusive rights to the planet-ionospheric energy for 17 years and we, the people, re-own it by now as it is in the public domain. One wonders what our world would have been like had Tesla's vision come true and his "magnifying" transmitter had been deployed.

Tesla had developed the techniques and conducted experiments on the transmission of information through space before the turn of the century. Tesla, not Marconi, was the first to invent the radio and after his death in 1943 and after a review of the claims and dates given by Tesla relating to the invention of wireless communications, the Patent Office conceded that Tesla had indeed preceded Marconi and was actually the inventor of what we now call radio and television communications. Little serious research has been conducted on his effort to develop a wireless energy transmission grid or to examine the relationship between his work at Colorado Springs and Wardencllyffe, New York. Tesla's research from his Colorado Springs Notes and his work in the design and construction of the tower at Wardencllyffe are examined in relation to our current research. [14] We present our interpretation of these experiments and some of our data on measurements of earth resonant phenomena taken over the last eleven years.

Both authors have been interested in Tesla's research and related work since our early teens. It is interesting, in looking back over one's life, how various pieces of different puzzles began falling into place. [15] Our ideas and research on earth resonant phenomena and some possibilities for wireless energy transmission, both natural and man-made appear to complement those of Tesla.

We suggest that a system which involves a pulsed AC system in a high DC potential can create a "steady state." In Tesla's words in 1934

Most people, and not a few electricians, will think that very long and noisy sparks are indicative of great energy, which is far from being the case.

In fact, at Colorado Springs, Tesla ran an AC system and raised and rotated a capacitor ball on a swivel utilizing the natural DC potential charge and discharge characteristics of the earth.

The Colorado air sustains a high potential before breakdown. The purpose of Tesla's experiments were to build up a voltage to achieve resonance; the necessary voltage was often not attainable from the local AC power generators since over voltage breakdown would occur before the necessary potential could be achieved. Needless to say, the problems created at the local power station by Tesla's experiments did not endear him to the power company or the people living in the area—even though he invented the power system!

Tesla carried on extensive correspondence with his laboratory workers in New York as his work progressed at Colorado Springs. His plan was to use the Colorado Springs laboratory as a resonance generating station and use the system to be built in New York as an amplifier and receiver. Work commenced at Wardenclyffe in 1901 at Shoreham, Long Island. Work on this project was never completed due to lack of funding. In Tesla's words,

My wireless tower on Long Island carried a sphere which had a diameter of 67 1/2 feet and was mounted in this manner. It was charged to 30,000,000 volts by a simple device for supplying static electricity and power.

The key concepts are that it was a static, high voltage device. Later he compared it to a Van de Graaff generator. He also explained the purpose of Wardenclyffe to be that "one does not need to be an expert to understand that a device of this kind is not a producer of electricity like a dynamo, but merely a receiver or collector with amplifying qualities."

We have calculated the proper spacing to produce and receive a signal resonant with the earth. The location of Colorado Springs and the Wardenclyffe tower are in the proper relationship to produce earth-ionosphere resonant waves to achieve Tesla's desired results for worldwide communications and an enormous energy system.

Again in Tesla's words, this system would "not only (make possible) the instantaneous and precise wireless transmission of any kind of signals, messages or characters, to all parts of the world, but also allow the inter-connection of the system, telegraph, telephone, and other signal stations, without any change in their present equipment." Again, his stated purpose was to free the human race from forced labor and to create a time when "rich and poor no longer meant differences of materials conditions but of spiritual capacity and ambition—a time when inter-communication all over the earth should be immediate and universal and even when knowledge should be derived from sources now hardly imagined."

Rauscher and Van Bise formulate a simple model involving a resonant system which sets up a ground and air wave that would be simultaneously emitted and would add by resonant reinforcement. In the following and necessarily incomplete analysis we consider two interactive waves of similar but different frequencies. The analysis proceeds as follows.

In calculating the velocity ratio of air and ground waves, one approach is to consider an air (earth ionosphere) wave travelling at v_1 and a through-the-earth wave traveling at v_2 . Consider two waves emitted from the same location on the earth's surface, one in the air and the other through the earth and both traversing paths in the same time so as to come back to the emission location as reinforced. The path length for the air wave is πD and the through-earth wave is $2D$. For equal time of travel, the velocity becomes $v_2/v_1 = \pi/2 = 1.57$. In this analysis, the greater velocity wave, v_2 , is the air wave. If v_1 is chosen to be the velocity, then the relative velocity (v_2) is $\pi/2 = 1.57$ times the speed of light. We could also consider the velocity v_2 as the velocity of light and then v_1 is $2/\pi = 0.64$ smaller than the velocity of light.

In Tesla's patents he makes it clear that the ground wave is the more rapidly travelling wave and the air wave is an electromagnetic wave travelling at the velocity of light. The above analysis is therefore not consistent with Tesla's model. In fact, there would be a mixing and reinforcing of a phonon/earth wave and an electromagnetic wave in the rarefied air and interaction. Therefore the above simple geometric problem does not apply. The problem, in fact, invokes phonon (longitudinal) and transverse electromagnetic wave interactions, as discussed in the next section.

Before proceeding further, any calculation involved in developing design parameters based on Tesla's work, needs examination in the light of two expressions in order to understand his calculations. In the Colorado Springs notes (1899-1900), Tesla obtained expressed quantities of capacitance (normally expressed in farads) and inductance (normally expressed in henrys) in terms of cm. For example, on June 28, 1899, he calculated the capacitance of the secondary with 26 turn windings as $C = 1200$ cm with the self inductance of $L_1 = 9 \times 10^6$ cm with a resonant frequency at 93,458 cycles/sec (Hertz). If we are to apply his calculations, we need to construct a system from E.A. Rauscher's research (from 1966) as capacitance C in cm is related to farads as $l(\text{cm}) = \pm \sqrt{Q^2/mf^2C} \approx 1/\sqrt{C}$ so that $\text{cm} \propto 1/\sqrt{\text{farads}}$ where Q is the charge, m is the mass, f is the frequency of the system. Unit dimensions are given as $C[m^{-1}/t^2I^2]$ where I is the current.

For Inductance $l(\text{cm}) = \pm \sqrt{Q^2/mf^2L} \approx 1/\sqrt{L}$ so that $\text{cm} \propto 1/\sqrt{\text{henrys}}$ for charge Q , mass m , frequency f , and inductance L , with unit dimensions $L[m^{-1}/t^2I^2]$. In the square root relations we utilize the plus solution in both cases. For example, for calculation of capacitance of a hollow conducting sphere with a radius of approximately 250 cm, which can accommodate five million volts charge, the cm equivalent capacitance is 2.9×10^4 microfarads. The electricity created will be about 1.45×10^3 coulombs, depending on the material in the capacitor. [13,16,17]

Energy and Field Resonances in the Ionosphere and Tesla's Proposed Wireless System

As the earth rotates it carries with it all of the kinetic energy of the earth as well as its steady state magnetic field, particulate matter and the atmosphere in decreasing densities out to and through the most rarefied strata above the various layers of the ionosphere. At the same time, all of the natural and artificially generated mechanical, electric, magnetic, acoustic, thermal and gravitational energies at fixed or moving locations on or within the earth, are adding to or subtracting from each other for resonant and anti-resonant nodes as the rotation of the earth carries and drags these energies essentially past a fixed radiant zone illuminated by the sun and its solar wind, which we define as the magnetosphere and the ionosphere.

The ionosphere-magnetosphere-earth system can be treated as though it were in dynamic equilibrium over archeological time, but as subject to significant local and nonlocal effect perturbations waxing over intervening periods. Other treatments of the potential energy available from the earth up to the ionosphere have involved calculations based on theoretical models and measurements and which deal with the

problem of the intervening short periods of time and address the local perturbations as observed and measured by relatively crude instruments within these perturbations. A satisfactory solution which resolves theory, observation and experiment in a self-consistent manner does not yet exist in the literature [17].

We therefore present the following simple calculations based on archeological time and a dynamically equilibrated earth-ionosphere system. The numbers given yield a rough approximation of the potential energy available but the figures are probably conservative since we have not taken into account the well known electrojet-Hall current contributions to the total energy.

We also have not taken into account the Peltier and Seebeck effects, the former occurring at the leading and the latter occurring at the trailing edges respectively, of the earth-ionosphere interface. Thermal energy from the SUN meeting the cold junction of the leading edge of the ionosphere would generate a potential difference and dynamic current as a Seebeck effect. Conversely, the trailing edge Seebeck voltage would be affected by the Peltier junction thermodynamic difference as they trail off into the night-side cold. The night-side hemisphere magnetospheric flux line excitations from the sunlit hemisphere ionosphere-magnetosphere-earth excitation would facilitate transfer of power at the night-side. These effects would give rise to significant local and non-local ionic current flows. An earth-ionospheric interface transverse Hall voltage would be a natural result of the Peltier-Seebeck effect generating earth-ionospheric circulating currents, and these factors are also left out of our potential energy calculations. Nevertheless, the amount of potential energy available within the earth-ionospheric system, if it could be harnessed, is surprisingly large.

The frequency differential between the North American power grid and the European/Asian power grid may also produce unique effects. The 60 and 50 Hertz differential produces a 10 Hz sum and difference frequency ($2 \times 60 = 120 - 50 = 70$ Hz near the Navy project ELF Center frequency). [18]

A great deal of power is being transmitted or pumped into the atmosphere from power line losses as I^2R drop is emitted into the earth-ionosphere cavity, which acts as a leaky but extremely large capacitance. The earth-ionosphere represents two plates of a moving variable capacitor of roughly 24,000 by 24,000 miles area separated by an approximately average distance of some 108 miles.

A simple calculation based on the half sphere of the sunlit hemisphere of the earth shows that the capacitance of the hemisphere from the ground plate up to the D region "plate" of the ionosphere where the peak electron density exists to 65 km (about 108 miles) is approximately 7,568 microfarads.

From the formula $C = (22.45 KA(N-1))/10^8t$ where C is in microfarads, K is the dielectric constant of free space with a value of 1, A is the area of one plate in square inches, N is the number of plates and t is the thickness of the dielectric in inches.

Using an average value of 100 volts per meter increases in the vertical field at the earth's surface up to 65 kilometers, we have 6.5×10^6 volts per unit meter. Twelve thousand miles is 14,400 meters, and for 14,400 meters squared the available potential is about 1.35×10^{15} volts.

Applying Ohm's law for power, we have $P = E^2/R$, where E^2 is the electric potential in volts for 14,400 meters squared and R is the free space impedance in ohms and since R is about 377 ohm, we see that 3.575×10^{12} watts potential is available if it is possible to produce a dynamic resonance motion in the electrostatic potential. By definition, 746 watts is equivalent to 1 horsepower, and for a dynamic resonant earth-ionosphere, the potentially available horsepower on a sunlit hemisphere would be about 4.79×10^9 horsepower!

these factors and radio-television communication systems as well as satellite systems produce extremely complex energy production and re-radiation processes. Certain particular systems can become locked; that is, interaction of energy systems with each other and natural sources may become resonantly coupled or locked. Some of this energy resonates in the ionosphere and some is transmitted from this system which has a Q of 4 to 5. The Q is defined the "figure of merit" or the ratio of the energy stored over the energy dissipated. The transmitted power that does not escape forms frequency mixes such as 10Hz and the odd and even harmonics of the 50 and 60 Hz power systems. These frequencies form a complex based on physical areas of emission from the earth and day/night effects.

The observed ELF artificial impulses in the environment lead one to speculate that such pulses may be the result of a device [19,20] similar to the one envisioned by Tesla and which he described as a magnifying transmitter. By means of such a device, high potential stored electric charges should be able to be converted to propagating magnetic wave resonances between the earth's core, the ionosphere and the magnetosphere. Such conversion, if done with sufficient precision, would make it possible to realize a gain of acousto-electric energy by matching and utilizing the approximately 1.5 Hz rotational vibrations set up in and above the earth as it moves on its axis in its orbit around the sun.

The magnifying transmitter, according to Tesla, was to facilitate worldwide communications while at the same time it could be used to transmit electrical power without wires to ground stations on the globe which are suitably designed for resonance and are connected to a power generator. The local power generators would of course have step down transformers and meters and wires for distributing 97% efficient electric power to a convenient radius of customers. Power would still have to be metered and sold but at considerably lower rates. The I²R losses would be minimal however, although maintenance to the ground generators would be necessary.

The earth's magnetic field lines describe minute motions due to micropulsations set up in them as a result of this rotational vibration. As is known, a moving magnetic field produces a current in a conductor. The earth's core is the likely conductor which would be expected to respond to these minute field variations.

Although the magnetic field of the earth is of small intensity, (about 0.5 gauss in the mid-latitudes) [21], the very large volume of the conductive core and the even larger radius of the surface magnetic field lines, provide a system with a great volume of electric current circulating in it.

Another potentially usable volume of electric current exists in the earth's magnetosphere. Some 10^{12} watts exist as the result of the magnetosphere. The combined electric power potential available from the ionosphere-core-magnetosphere is about 4.5 times the world's electric generation capacity! The major problem seems to be development of a method to gain access to these systems of electric currents.

We believe that Tesla had solved this problem in his experiments in 1899 at Colorado Springs. [13] By means of a specially constructed electrical detection system, he observed stationary waves showing that the earth behaved as a spherical conductor with finite dimensions and he also found that high potential, tuned circuits capacitively coupled to the earth developed two wavelengths when resonance occurred.

A spherical conductor mounted on an insulated pole served as the electrically elevated terminal which emanated radio waves that obeyed the ordinary formula for wave length, where the frequency divided into the speed of light yielded the length of the waves. However, the earth terminal, coupled to the secondary of a critically tuned inductor through a low value capacitance of special design, ostensibly propagated waves at the same time which were longer by a factor of about 1.57 times

the velocity of light, or some 40% to 60% greater in length [19]. Tesla said that the Maxwellian electromagnetic component from the elevated terminal would become negligible as resonance of the earth's core and ionosphere developed. The magnetic flux from Earth's steady state can be "strummed" communicating such phenomena as "pearls" or vibrating magnetic flux density increases at nodes and anti-nodes and the vibrations propagate almost with no delays. [7]

The elevated terminal was to be specially constructed with a unique and very large radius of curvature in order to raise the electrical pressure extremely high and to store it there by virtue of its own electrical attraction until released into the air and ground terminals in a pulsed manner. The initial primary current would be of very large magnitude until the condition of resonance was struck on the earth's half sphere radius, after which the primary current could be expected to lower to a more practical value.

The earth-ionosphere was evidently envisioned by Tesla to be able to be treated, in certain electrical cases, as a lossless transmission line containing kinetic energy from its rotational motion which would be able to be utilized with a magnifying transmitter. The air above the elevated high potential terminal would offer the conductive path to the lower ionosphere by virtue of pulsed ionizations of the air molecules directly above this highly charged terminal. All vehicles could operate on electrical power and aircraft could fly on electrically driven motors and none would ever cross the ionization paths due to repulsion effects and thus all could be collision-free.

In order to gain access to the closed earth magnetic field core system, the period of the wave from the transmitter would have to be carefully controlled and would have to be somewhat below 20,000 Hz down to a low of 6 Hz or cycles per second, for practical utilization.

Furthermore, the time interval (on/off time) of the wave train excitation should be between one eighth and one twelfth per second. The electromagnetic component, free space, half wave length and longer magnetic half-wave length would thus be able to couple in a heterodyne manner-"mixing" in a constructive interference pattern at each half wavelength around the earth from the transmitting device producing larger magnitude effects. When these two waves couple, a lateral travelling wave plus a vertical standing wave should develop. By carefully adjusting the repetition rate and impulse duration, these transmitted dual waves may be "latched" onto or ride on the earth's magnetic field lines. The vertical wave might then begin to move in a path through the earth and out into space again, gaining kinetic energy (harmonic pendulum effect) from the earth's mechanical/rotational vibration system. These dual waves of the same period but of different lengths, interacting, may be sufficiently compressed to exhibit plasma-like wave circulation forms which could fit the criteria of a macrocosmic soliton-antisoliton. Solitons or solitary waves are dynamic entities that are localized in space and retain a fixed shape or form. Nonlinear recohering terms in the wave equation describing soliton-like behavior overcome dispersive losses so that the wave appears non-dissipative in space. The amplitude of these wave-like quantities is proportional to their velocity.

Tesla had stated as early as 1904 that the mode of excitation and the action of his magnifying transmitter may be said to be diametrically opposite to that of an electromagnetic transmitting circuit. He described the magnifying transmitter circuit as a device which acts like an immense pendulum, indefinitely storing the energy of the primary exciting impulses and impressing upon the earth and its conducting atmosphere, uniform harmonic oscillations of very great intensities. He also said that the electromagnetic radiations of a properly tuned magnifying transmitter would be reduced to an insignificant quantity. In addition, Tesla said that a number of distinctive elements put together in a manner analogous to the

human nervous system, would enable the magnifying transmitter to send, simultaneously, many thousands of encoded messages without serious mutual interference [22].

Tesla had predicted 95% to 98% efficiency in the transmission of electrical energy without wires via his magnifying transmitter. The primary currents, however, would be very large and require a substantial amount of input energy. Once electrical resonance was established with sufficient energy expenditure, Tesla felt that the sustaining of large current-carrying standing wave ionized paths on the planet, could provide almost lossless transmission channels.

The frequency of about 30 Hz is an interesting one in view of Tesla's writings regarding earth-resonance and his magnifying transmitter. He noted that the ground terminal would produce waves with a length: $\lambda = (\pi/2)cv$, while the elevated terminal would produce waves obeying the ordinary formula $\lambda = c/v$, where c can be taken as the speed of light in free space $\{2.99 (10^8)$ meters/sec $\}$ and v is the frequency of the pulses. At 30 Hz then, the ground wave length would be 15,707.96 kilometers and the free space wave length 10,000 kilometers (see also Appendix I). Monitoring has indicated that about 30 Hz waves exist over vast areas of the North American continent and maximum intensities appear both from overhead and below a vertical coil orientation as if the core and the ionosphere-magnetosphere were being excited.

The distance from the surface of the earth to the inner core is about 6,370 kilometers and, interestingly enough $\lambda/4$ at 30 Hz in free space is 2,500 kilometers while $(\pi/2)\lambda$ is 3926.99 kilometers. The sum of these quarter length waves is 6,426.99 kilometers, almost exactly the distance from the earth's surface to the inner core for $\lambda/2$. If one assumes that a phase velocity delay occurs both from the core up to the surface of the earth and from the magnetosphere, at ten earth radii, down to the earth's surface, a vertically oriented acousto-electrohydrodynamic cylindrical wave may develop along a boundary layer near the earth's surface with its uppermost boundary extended some $\lambda/2$ or 5,000 kilometers. The configuration would resemble a "slow moving" standing wave. Heterodyne-like patterns may be expected to occur which can be measured and the converging up waves and down waves would be able to produce magnetosonic waves near the surface of the earth, which, at times, might reach the audible range as "clicks" and "booms."

Analogies in physical optics might be applied to the concept of a single source frequency with two different wavelengths existing simultaneously; they are the phenomena of birefringence and double refraction [23,24]. It is also possible to consider selective resonance absorption, also known as *restrahlen* and sometimes referred to as "ghost rays," which we have observed in two of our midnight graveyard in Portland, Oregon and Skull Valley, Arizona ELF measurements. These residual rays can be produced by molecular rotation (which is related to magnetic rotary power and magnetic rotary dispersion) [25]. Though resonance absorption is usually associated with optically active absorption bands [26], it is possible to extend the relationship of the optical equations into the ELF regions.

It is known that the index of refraction varies with the wavelength of refractive waves [27]. The earth's core and ionosphere-magnetosphere may be able to be treated as a single-system special case of a dense-rarified reflective medium which may show an anomalous dielectric constant under the condition of resonance. The usual description for absorption and selective reflection defining a complex angle of refraction is $\alpha + i\beta$. Absorbing media can be described by the complex index of refraction $n(1-ik)$ and the wave traveling in it damps and introduces a phase shift between the parallel and perpendicular polarized components of both the transmitted and reflected wave producing elliptic polarization. If $k \ll 1$, the medium is weakly absorbing, and if $k \sim 1$ or $k \gg 1$ and $\sinh \beta \gg 1$, wave penetration is only on the order of a few wavelengths. The relationships are paradoxical, ie. a strongly absorbing

medium is one which rapidly attenuates the part of the electromagnetic wave that penetrates inside it, but since most of the electromagnetic wave is reflected from its surface, a strongly absorbing medium is really a poor absorber, if measured by the fraction of the total electromagnetic wave energy absorbed. At about 30 Hz, the earth elastic-acoustic wave and the ionosphere magnetic wave couple at the core. Thus about 30 oscillations are able to be sustained by the kinetic energy of the planetary rotation, which fits our observation.

During field measurements in 1979 and 1980, a curious anomaly was discovered about one mile east of the Bonneville Dam in Oregon, in a region where no 30 Hz waves were found. The complete area of absent waves was not plotted but the measurements indicated that a "hole" existed beginning at about the Eagle Creek fish hatchery and stretching approximately east south eastward. It is possible that a resonance of the earth-ionospheric cavity might cause resonance absorption bands at nodal locations on the earth's surface. In the case of ELF resonance absorption, the reflection-absorption-retransmission zone would be of large radius and could possibly result in a photon-phonon gyroscopic spin wave effect [28,29]. The spin precessional frequency of waves may be sustained by a given absorption producing frequency as long as the driving pulse intensity is present at a given threshold level. The damping factor will be reduced, perhaps to the degree necessary for sustaining a spatial soliton wave [30,31,32]. Latent effect periods (delayed re-emission) would occur and depend upon pulse duration and repetition rate. When pulse transmissions change in frequency, the waves may damp momentarily and at times might precess to a rate that could match the vibrational rate of various piezoelectric geologic materials such as quartz, which might induce earth movements (volcanoes and seismic activity).

Since it is well known that a difference in phase in field intensity and polarization is always accompanied by energy absorption, it may be that ELF magnetic field resonance absorption effects cause far-field electric vector effects (earth to ionosphere E-field) and may produce a near-field, high-intensity magnetic component at even wavelength distances from an ELF source. At the same time, a high intensity electric field may produce as a far-field effect magnetic pulses at each quarter wavelength distance from the electromagnetic emitter source. If ELF absorption effects exist at areas on the earth's surface as a result of core-ionosphere-magnetosphere excitations, the energy may be retransmitted from those areas at substantially greater intensities than the intensity of the pulsed energy originally absorbed. This would be seen as abnormally high electric field intensities.

Examples of real time data covering a period of time from 1979 through 1986 are given in Reference 14, and a few illustrative examples are given in Appendices I and II. Experimental field measurements in the ELF-VLF frequency ranges were begun in 1972 and in that year, an approximately 10 Hz infrared frequency shift pulse was detected in the summer day-lit sky around noon and 4pm from a monitoring station in Portland, Oregon. The pulse was only on at intermittent intervals during the day for the next few months, then the pulse disappeared. In late 1975 and officially in July 1976, the 10 Hz pulses of the "Russian woodpecker" [33] came on the air and has remained on the air until the present time.

In the late summer of 1979 other artificial signals came on the air with repetition rates of 15 and 30 Hz. In November and December 1979, monitoring in the Pacific Northwest yielded magnetic signals of many different waveforms and frequencies mixed in with 10 Hz, 15 Hz and 30 Hz.

Many signals of natural and artificial origin coexist and synergistic effects between the natural resonances and man-made energies allow us to make a working hypothesis of the electromagnetic hydrodynamics of the earth-ionosphere, particularly with regard to geologic activity and weather.

Some of the artificial impulses have been interfering with lawful communications worldwide since 1976. Significant Interfering electromagnetic signals were found on the 3 to 30 megahertz (MHz) bands and are usually pulsed at an on/off rate of 10 per second. The 10 Hz signals may have resulted from what the Soviets have admitted to be "radio wave experiments." They presumably originated somewhere east of the Baltic Sea. Some of these signals were seen to be phase and pulse width correlated with magnetic waves. Since July 1979, variable pulse width magnetic waves of approximately 10, 15, and 30 Hz resembling pulse time modulation (PTM), along with data-like impulses, were also observed with intensities exceeding an order of magnitude above the earlier observed natural signals in this frequency range, with an amplitude of about 100 to 150 microgauss (μG). As earlier stated, most of the artificial magnetic waves in the 10 to 30 Hz range were observed to propagate at maximum amplitudes in the vertical direction, suggesting the possibility of altered earth- ionospheric resonance excitations.

We have examined the characteristics of some of the natural waves and, as we have already noted, related these frequencies and wave forms to some of those hypothesized by Tesla. We have also examined some of the artificial, man-made signals as perhaps emanating from a modern variation of a device patented by Nikola Tesla in 1905 and which was termed a magnifying transmitter. (See data in Appendix I).

Measurements of Magnetic and Electromagnetic Pulsations in the ELF Frequency Range

The device we used in making our magnetic field measurements is described as follows. The T-1050 field detector operates on the principle that a coil of conducting wire, insulated and consisting of some 150,000 feet of #44 AWG wound on an insulating spool form with a high(μ) permeability mu-metal material adjacent to the inner windings, responds to a fluctuating magnetic field; or, if the coil is moved in a static magnetic field, it will respond to the field in a dynamic manner [34]. In either case, coil response to magnetic field fluctuations results in the generation of fluctuating voltages. The voltage is proportional to the number of turns of wire and the dimensions of the coil, the permeability of the mu-metal material and the magnitude of the magnetic field.

The sine of the angle of the "cutting" of magnetic field flux lines is another important factor in the sensitivity-frequency response characteristics of a coil-core type of magnetic field detection system. Slow moving magnetic flux changes in the coil, such as would be the case at frequencies below 1 Hertz, will induce a much lower voltage at the coil output than, for example, magnetic fluctuations moving at a 100 Hertz rate. There is an order of magnitude difference between 0.1 Hz and 1 Hz, but there are about three orders of magnitude of decreased sensitivity between these two frequencies and less than an order of magnitude (about three times less) between 1 Hz and 100 Hz.

In a coil system such as used in the T-1050, the resonant frequency of the coil-core is about 48 Hz; normally the resonant frequency is determined by $f_r = 1/(2\pi\sqrt{LC})$. Ordinarily the inductance L and the capacitance C in radio frequency circuits are directly calculable by the above formula. However, in a coil-core magnetic field detection system, other complicating factors are introduced, such as the permeability of the core, the distributed capacitance of the wire over its length, the magnitude of self induction relative to the induced back electromotive force and non-sinusoidal wave fronts acting on the coil-core, etc. These are some of the problems which need to be addressed when utilizing a coil-core type of magnetic detection device system. These are dealt with in the equalization, filtering and amplifying networks following the coil-core generated voltages. We take advantage of the fly wheel-like storage capabilities of a coil system and feed the coil generated voltages through carefully

designed electrical networks to achieve extraordinary sensitivity and equivalent frequency response. The Faraday shielded coil allows us to "trap" the E-fields generated internally from the moving B-fields on the coil windings and utilize this energy to "MASE" (Magnetic Amplification of Stimulated Electrons) the sensitivity and frequency response. The T-1050 detection-equalization-amplification network following the detector coil-core sensor well accommodates real time wave shapes, forms and frequencies for ready analysis with spectrum analyzers, oscilloscopes and other instruments. In spite of the complexity of the above addressed problems which the T-1050 solves, its operation is straight-forward. We have examined the magnetic field flux with both shielded and unshielded coils. The shielded coil allows the pickup of varying magnetic lines of force only without electric field components. By using shielded and unshielded coils in simultaneous measurements, we can examine the E field contribution at ELF frequencies, even though externally generated E-fields contribute very little energy below about 300 Hz. [34]

We have been making magnetic field measurements for over twelve years. One of us (Van Bise) has been observing an approximately 31.5Hz ambient signal since 1979. We began monitoring of magnetic signatures on a regular basis, observing a signal of about this frequency since the end of 1983. We used a Spectral Dynamics model 335-B Spectroscope II real-time spectrum analyzer with a range of 0.06 Hz to 50 KHz to analyze the frequency components of detected ELF (extremely low frequency) and VLF (very low frequency) signals. With careful analysis, the 31.5 Hz signal was determined to be at 31.4 Hz. Note $2 \times 1.57 = 3.14$, which is π , which is what led us to consider the relationship of this frequency to the Tesla $\pi/2 = 1.57$ ratio. Even before making more accurate measurements with our spectrum analyzer, Rauscher predicted using Tesla's approach, that the 31.5 Hz signal was 31.4 Hz. The following analysis is intriguing but perhaps not definitive. Using the velocity ratio defined by Tesla as $v_1/v_2 = \pi/2 = 1.57$, for the two velocities for the same wave length, we can determine the two associated frequencies ν_1 and ν_2 for $\nu_2 = \lambda\nu_2$, and $\nu_1 = \lambda\nu_1$ and therefore $\nu_2/\nu_1 = \pi/2 = 1.57$. One assumption is that a signal associated with this frequency ratio activates oscillations in the earth and the earth-ionospheric resonant cavity and is associated with the so-termed 10 Hz "woodpecker." Then we may consider a ten times factor of the 1.57 frequency ratio or 15.7 Hz. Note that if this wave represents a wave length, then we have $2 \times 15.7 = 31.4$, which is the dominant frequency outside of the 60 Hz powerline, which we see in the western hemisphere.

We have measured the 31.4 Hz frequency in northern and central Oregon, central and southern California, central Arizona, southern Louisiana, in the New York area and in the Boston area. (See Appendix I.) Intensity of this frequency varies with location and time of day. From 1979 through March 1985 the frequency remained around 31.4 Hz and between March and April 1986, we observed a shift in this major intensity frequency, shifting from 31.4 to between 30.4 and 30.6. We sometimes observed simultaneous 31.4 and 30.6 signals or a cluster of signals in this range with side lobes up to four or five. Other clusters exist, around 48.5 Hz as detected by a "T" antenna measurement of electric field impulses. (See appendix I and II) [35]

We have considered a number of possible sources of this signal and the reason for the frequency shift in 1985. The wave forms are very regular displaying a surge in power from back EMF (electromagnetic force) as the signal goes away which indicates a man made source; perhaps a spurious side band of Project ELF which happens to be near one of the earth's natural resonances. It appears that the 31.4 Hz or 30.6 Hz signal does not involve a powerline subharmonic or mix of 30 Hz but occupies a more fundamental role. One hypothesis is that it involves an excitatory mode of the earth, activated by some specific external man-made source.

The 31.4 Hz signal can be analyzed as about a 30 Hz signal, heterodyning and mixing with the approximate 1.5 Hz earth rotational vector frequency. Other frequencies we have observed associated with natural phenomena, such as volcanoes and seismic activity, are complex, showing sine-waves with interspersed jagged waves unlike the 30 Hz signals and other artificial ELF frequencies. Some of the man-made signals display telemetry like characteristics.

Seismic activity has been occurring periodically in San Leandro in the San Francisco Bay Area of California. We have been observing irregular slow waves of 0.48 Hz and some clusters at 1.32, 1.56, 1.84 and 3.18 to 3.2 for the vertical coil configuration. For example, these frequencies were observed at 8pm on January 14, 1986. News reports later that evening indicated that earthquakes occurred near Salinas and San Jose, California measuring 4.3 and 5.2 respectively on the Richter scale.

We observed the onset of a 3.2 Hz wave maximum with an approximately north-south coil orientation from the 6th through the 13th of November 1986. Previously, this frequency and other specific frequencies had been associated with the volcanoes we observed with the Mt. St. Helens activity in 1980. On November 15th, 1986 the enormous volcanic eruption of volcano Nevada de Ruiz, near Bogota, Columbia was reported and this event occurred south of our observation station. This activity had been preceded by some steam eruptions before the major blast that killed over 23,000 people. A small quake of 3.2 on the Richter scale occurred that day in San Jose, which was consistent with our observation of the north-south coil orientation measurements of slow waves. Some other example predictions of seismic activity are our measurements in the period preceding August 1986, where we observed magnetic field oscillations around 1.5 Hz and 3.2 Hz which were most intense in the north-south direction.

During this period an earthquake occurred in Alaska measuring 5.0 on the Richter scale and two others occurred in China measuring 6.8 on the Richter scale. A "precursor" quake occurred near Mexico City and another occurred at Santa Barbara which measured 3.3 on the Richter scale. Earthquake signatures continued and we expected more and stronger activity. On the 19th of August, 1985, news reports stated that at 8:18am Pacific time, a quake occurred 250 miles west of Mexico City measuring 7.8 on the Richter scale which was felt as far away as Houston, Texas. Predictions of continued activity was made and the next day another quake occurred measuring 7.3 on the Richter scale which was called an "after shock." Some 20,000 lives were lost during that period. [14]

Theoretical Models of Collective, Coherent Resonant States in the Earth and Ionospheric Resonant Cavity

Our observations of frequency and time domain wave form similarity indicates the need to formulate a more complex dispersion relationship than the usual ones. That is, the relationship between wave number (or wavelength) and frequency is not of a simple form, ie. one cannot use the simple relation $c = \lambda\nu$. One can, however, proceed from a dispersion relation and then derive specific wave equations for specific applications. We proceed in an opposite manner and utilize our data, interpreting it as wave form solutions to a wave equation and then deduce nonlinear dispersion relations in which the leading order term is $c = \lambda\nu$.

The simultaneous occurrence of similar wave forms and frequencies over the globe would indicate a large portion of, or even the Earth as a whole, has been set into dynamic resonance by natural and man-made events. The existence of such electric and magnetic waves indicates the presence of a local and global resonance. The impulse waves observed and the on-off intermittency of the about 30 Hz and other ELF signals, would indicate that one or more local resonator-generators are

activating very non-linear modes of oscillation in the Earth. Our data indicates that a mechanical-electrical system or systems can activate normal complex modes of oscillation in the earth and earth-ionospheric resonant cavity, some of which are naturally occurring and some are artificially induced.

We proceed in one or more of three ways to determine a wave equation which describes the observed generated wave forms. (1) One Way is to determine the complex and perturbations-expansion dispersion relationship from which a generalized wave is derived. (2) Another way is to introduce the formation of a new geometric space metric of more than four dimensions, which we term geomagnetic space. The prefix Ge is determined from the Greek term for earth and leads to such terms as geology or geography and geometry (earth measure). (3) A third procedure is to present a generalized, nonlinear wave equation and its solution which appears to fit the general form of the data.

Our experience with other electromagnetic and hydrodynamic systems leads us to proceed in the third manner and set down a general nonlinear equation and its solutions. The earth is a highly dynamic and enigmatic system whose origin and detailed structure remain a mystery. It appears in general to be a structure of a layered elastic sphere, as is evidenced by scattering of seismic waves by the Gutenberg discontinuity between the earth's mantle and core. Discreteness of the structure of the concentric zones appears to be due in part to different major compositional components of the various layers such as the crust, mantle (upper and lower) and core, resonantly locked together. The lithosphere, the stony outer portion, is elastic and flexible as determined from ice and geologic materials which show uplift and rebound. Temperature gradients produce convective processes within the earth and associated seismic waves travel at from 7 to 8 km/sec.

The earth forms certain normal modes of oscillatory states which are a function of its size, composition, inhomogeneties, elasticity, viscosity, capacitance etc. These normal modes can be activated by natural phenomena, as we mentioned before, such as volcanoes, meteorological activity, solar wind, etc. These states can also be activated by artificial or man-made systems. For example, nuclear testing, power line systems of 50 to 60 Hz, radio, television and other communications systems. A vast amount of power is pumped into the earth-ionosphere resonant cavity primarily during daytime and early evening hours on the sunlit hemisphere of the earth. Some of these frequencies interact with the natural electromagnetic fields of the earth and can either enhance or diminish these resonant modes. We strongly believe that the current power grids and other electromagnetic radiation will prohibit the design and use of the wireless energy system as Tesla perceived it. Certainly a system based on Tesla's design would have to be modified to accommodate current developments including aircraft travel and satellites.

There are some very striking and intriguing properties of soliton phenomena that lead us to formulate a model of earth resonance in terms of a dispersive-nonlinear wave equation having soliton-like solutions. The earth system is a media which has elastic rebound properties or acts fluidly as observed by the continental drift, and supports nonlinear coherent resonant wave modes that disperse, such as Love waves (or S-wave or stress wave-like) and Rayleigh waves (or P-waves or pressure wave-like) which can be activated from seismic adjustments. The earth acts as a dynamic nonlinear resonator with dispersion. (See Appendix I and II)

We have made extensive measurements of some of these resonant modes which are activated by man-made or other natural sources. Some of these modes may be self sustaining soliton-like waves similar to the process suggested by Tesla. A soliton is a pulse-like traveling wave solution of a linear dispersionless wave equation or a nonlinear equation with dispersion. The basic form of soliton wave equations have the classical wave equation as their leading order terms. If we have a linear equation with dispersion, i.e. the usual classical wave equation, no soliton waves will

occur as the Fourier components of any initial condition, and it will propagate at various different velocities and as the interface of Fourier as components in which energy will be lost. If nonlinearity is introduced without dispersion, again the possibility of soliton wave modes does not occur since a continuous source of pulse energy must be injected via harmonic generation into higher frequency modes. In the time domain, we often see such phenomena as a shock wave, i.e. a wave of relatively short duration. Soliton waves can form with both dispersion and nonlinearity. The soliton wave can be quantitatively understood and interpreted as representing a balance between the effect of the nonlinearity and of the dispersion process. Phenomena amenable to this type of description involve nonlinear, coherent resonant states with dispersive losses.

Examination of natural phenomena, such as sun spot activity, ball lightning, hydrodynamic solitary waves and biological colonies including man, exhibit self-organizing approximately "non-dispersive" processes. These classes of phenomena that involve (1) non-linearity, (2) non-equilibrium, (3) coherent resonance and (4) collective particle states, can be described as self-organizing and non-dispersive. These phenomena can involve solid, liquid, gas and plasma states of matter-energy and can be mechanical and/or electrical (or electromagnetic, chemical or biological) in nature. The key element in such processes is that they do involve dispersion (or diffusion) but that this dispersion (diffusion) is overcome and recohered by the non-linear structure and or fields of the system under consideration. A prime example is that of the hydrodynamic soliton phenomenon, well described by the Korteweg-deVries equation developed in 1895 to describe the observations of John Scott Russel in 1834.

These equations describe phenomena which is dispersive in the third order derivative in space, $\partial^3 U / \partial x^3$, rather than the usual wave equation, which is dispersive in the second order in space, $\partial^2 U / \partial x^2$, which is "balanced" by the nonlinear term of the form $U(\partial U / \partial x)$, where U is a wave function amplitude dependent on space and time. There are also quantum analogies to this classical equation such as the sine-Gordon equation.

We have examined the structure and form of soliton equations applicable to a wide variety of physical, chemical and biological systems and demonstrate how these equations relate to the usual wave equation.

$$\frac{\partial^2 U}{\partial x^2} - \frac{1}{c_0^2} \frac{\partial^2 U}{\partial t^2} \quad (1)$$

where c_0 is the velocity of the wave amplitude, U, and we have the usual dispersion relation for $k = v/c_0$ for wave number k and frequency v. Each non-linear equation which exhibits a soliton wave-like solution has a different associated dispersion relation. We have presented ample examples of natural phenomena that exhibit these properties and demonstrate the application of these theoretical models to describing geologic phenomena [34,36].

We will now discuss the soliton model for the development of possible efficient energy devices. Although these devices will not violate the second law of thermodynamics, they are highly efficient and utilize some of the available ambient energy as efficient energy converters [37].

In deriving the form of a generalized nonlinear wave equation, one can usually proceed from a general dispersion relation where in the wave equations the dispersion term is independent of the nonlinear aspect. This method has its limitations when the above condition does not hold, i.e. these terms are interrelated such as in the sine-Gordon equation, the method breaks down and becomes cumbersome to use.

Proceeding along the lines suggested by A.C. Scott's mechanical analogy [37], we examine the wave forms we have observed as describable by solitary wave-like phenomena and that these solitary waves are solutions to the sine-Gordon equation. We will also demonstrate the manner in which one can easily relate the sine-Gordon equation to the Korteweg-deVries equation.

We consider the periodic variation of the amplitude of the earth's magnetic flux ϕ and governed by the nonlinear evolution equation. We proceed from the sine-Gordon equation

$$\frac{\partial^2 \phi}{\partial x^2} - \frac{\partial^2 \phi}{\partial t^2} = \sin \phi \quad (2)$$

which can be written in compact notation as $\phi_{xx} - \phi_{tt} = \sin \phi$. If diffusion as well as dispersion occurs, then additional terms in ϕ_{xx} and ϕ_t will exist on the right side of the above equation. The flux amplitude ϕ plays the role of the wave amplitude, U

$$L = \frac{1}{2} \left(\frac{\partial \phi}{\partial x} \right)^2 - \frac{1}{2} \left(\frac{\partial \phi}{\partial t} \right)^2 - \cos \phi \quad (3)$$

or in compact notation

$$L = \frac{1}{2} (\phi_{xx})^2 - \frac{1}{2} (\phi_{tt})^2 - \cos \phi \quad (4)$$

For x dependence only. For the more general case, x, y, z dependencies of the flux can be examined.

The wave equation and its Lagrangian can be modified by the introduction of certain perturbation terms that can account for fundamental and harmonic resonances [14]. These terms are taken as small and in the form of an exponential. Examples are given in the above reference.

For example, the linear stability of traveling wave solutions of the sine-Gordon equation have the form $\phi(x, t) = \phi(x - ut)$ which is expressed in terms of an elliptic integral with three arbitrary parameters, u , the traveling wave velocity, ϕ_0 , the value of ϕ for $(x - ut) = 0$ and C an integration constant,

$$\int_{\phi_0}^{\phi} \frac{d\pi}{\sqrt{2(C - \cos \phi)}} = \pm \frac{x - ut}{\sqrt{1 - u^2}} \quad (5)$$

If $C = 1$ is chosen and $\phi_0 = \pi$ is set and corresponds to ϕ rotating by 2π as $-\infty < x < \infty$, the integral yields a soliton solution,

$$\phi = 4 \tan^{-1} \left[\exp \pm \frac{x - ut}{\sqrt{1 - u^2}} \right] \quad (6)$$

If $u = 0$, the factor in the exponent reduces to x .

The plus sign in the exponent corresponds to a positive sense of rotation and the wave pulse can be conceded to be a soliton; the minus sign can be considered to be a negative sense of rotation yielding an "anti-soliton." Solitons and antisolitons are created or annihilated in pairs and the sine-Gordon equation is invariant to a Lorentz transformation which can be defined for luminal and sub-luminal velocities.

The soliton model yields a description of a very stable entity which exhibits both particle and wave like properties. The solution to the sine-Gordon equation are stable for example for $u = 0$ and $C \geq 1$, and unstable for $|C| < 1$. For moving solutions where $u \neq 0$, the dynamic symmetry of the nonlinear wave equation can be expressed by its invariance to the Lorentz transformation defined by $\phi(x,t) \rightarrow \phi'(x';t')$ as

$$x \rightarrow x' = \frac{x-ut}{\sqrt{1-u^2}} \quad \text{and} \quad t \rightarrow t' = \frac{t-ux}{\sqrt{1-u^2}} \quad (7a,b)$$

and the appropriate derivatives $\partial/\partial x$ and $\partial/\partial t$.

The point to be taken at this juncture is that although the sine-Gordon form of nonlinear equations yield solutions which appear to reflect some of the properties of elementary particle physics [38], these forms may be useful to our application as well. Scott's mechanical analogy description in reference [37] suggests to us that some of our observed wave forms might well be described by a similar approach involving elliptic integrals with space, time, velocity and also frequency arguments; see Appendix II.

We can write a more familiar form of the soliton solution by writing our elliptical integral as

$$\int_{\phi_0}^{\phi} \frac{d\phi}{\sqrt{P(\phi)}} = x - ut \quad (8)$$

where the term $P(\phi)$ can be written as a polynomial expansion in terms of integration constants C and C_2 , and velocity u up to third order in ϕ as

$$P(\phi) = 2C_2 + 2C_1\phi + u\phi^2 - (g/3)\phi^3 \quad (9)$$

The above integral can be written (in the form which in general is not Lorentz variant) as

$$\phi(x-ut) = \frac{3u}{g} \operatorname{sech}^2 \left[\frac{\sqrt{u}}{2} (x-ut) \right] \quad (10)$$

which now looks like the solution to the Korteweg deVries equation for $u \geq 0$. The constant g then appears as the nonlinear term of the nonlinear equation of the form

$$\frac{\partial\phi}{\partial t} + g\phi \frac{\partial\phi}{\partial x} + \frac{\partial^3\phi}{\partial x^3} = 0 \quad (11)$$

which is the Korteweg-deVries equation that occupies the role of a coupling constant of the nonlinear term which balances the highly dispersive term $\partial^3\phi/\partial x^3$.

For completeness we can write the Lagrangian density as

$$L = \frac{1}{2} \frac{\partial\theta}{\partial x} \frac{\partial\theta}{\partial t} + \frac{g}{6} \frac{\partial^2\theta}{\partial x^2} + \frac{\partial\theta}{\partial x} \frac{\partial\psi}{\partial x} + \frac{1}{2} \psi^2 \quad (12)$$

or as $L = 1/2 \theta_x \theta_t + (g/6) \theta_{xx} + \theta_x \psi_x + (1/2) \psi^2$ where we define $\partial\theta_x = \theta_x = \phi$ and $\theta_{xx} = \partial^2\theta/\partial x^2$, etc.

We have observed similar wave forms in both the time and frequency domain. See Appendix I. From these data taken simultaneously in time and in frequency, we deduce that the dispersion relations governing these wave forms is a complex relationship between wave number (inverse of wave length) and frequency or frequencies. Since the wave length of these waves are so long for these low frequencies, we are essentially detecting these waves as observers from a frame of reference "within these waves." The approximately 30 Hz waves which we observe always look like well formed sine waves.

For the usual kinematic wave equation $c = \lambda v$ we can relate the frequency and the time as $v = 1/t$. For more complex wave equations, this simple relation of time and frequency may not hold.

Analysis of the periodic nature of the observed data waveform amplitude in time (oscilloscope tracing) and power density vs. frequency (spectrum analyzer display) allows us to deduce the relationship of time t and frequency v . One procedure is to identify the frequency μ with a frequency domain time τ . From this theoretical model we can construct a five dimensional geometry in the coordinates (x,y,z,t,τ) where $\mu = 1/\tau$ and $t \neq \tau$. We have explored in detail elsewhere, the construction and application of five and eight dimensional geometries. See References 40 and 41 and references therein.

Measurement and analysis of the acoustic-seismic modes and magnetic field oscillations in the ELF and the VLF region of the earth and earth-ionosphere cavity, leads us to re-examine issues related to the measurement process. We proceed from a generalized wave equation with coherent, solitary wave solutions to a wave equation with five independent variables, three dimensions of space, the usual time and associated frequency, and an additional time-like variable with a unique additional frequency variable.

Interestingly, the problem of measurement of the ELF phenomena is opposite, in a sense, to that for high energy process--x-rays, gamma rays, elementary particles and quarks. For ELF phenomena, the observer is significantly smaller (internal) than that which is observed, which is external large-scale phenomena. Whereas, for high energy quantum processes where \hbar -applies, the observer is significantly larger (outside) than that which is observed. Treatment of the problem of an internal or inside observer of an external large-scale phenomena is made in terms of a five dimensional wave equation. A four-space description may well suffice if the observer is larger than the scale of that which is observed.

The recent GUT (Grand Unification Theory) for strong, weak and electromagnetic interaction, involve ten and eleven dimensional spaces. Part of the subspaces of the GUT theory is the five-dimensional space of Kaluza-Klein with four spatial dimensions (one a periodic rotational spatial dimension) and the usual time dimension.

We explore in more detail, the relationship of macroscopic electromagnetic and gravitational interaction. Also examined is the modification of the gauge conditions as applied to electromagnetic interactions in the ELF region. In the conventional view, an electromagnetic wave of about 7.8 Hz has a wavelength of approximately the circumference of the earth. In the conventional view of wave packets, we are dealing with a photon the size of the earth! [5,14]

We can treat the problems of an internal (inside) observer or an external (outside) observer. It may be most useful to treat the wave equation as solvable in five-space for the internal observer whereas our-space may suffice for the external observer, where the relationship of v and t is less complex. We can define a frequency v associated with t as $v = 1/t$, we associate a wave number k with v as $k = 1/\lambda$ where $c_w = \lambda v$ and a wave $q = 1/\Lambda$ where $c_w = \Lambda \mu$ where c is the velocity of the wave so that can be equal to c_w or c_w where w equals $2\pi\mu$.

We can write a general form of the electromagnetic field $F_{\mu\nu}$ which depends on the electric and magnetic fields E and B so that (for $\psi \rightarrow \mu, \tau$)

$$F(x, \chi, t, \tau) = F_0(x, \chi, t, \tau) e^{i(kx - \omega t + q\chi - w\tau)} \quad (13)$$

which comprises an eight-dimensional representation. Elsewhere, we have examined the symmetry conditions and Lorentz invariance in five and eight dimensional geometries in which the group elements of the five dimensional space is a subset of the group elements of the eight dimensional space. The twister algebra of the eight-space is mappable to the spin or calculus of the five space [41,42,43] (See Appendix II, a brief description of some data.)

One of the outgrowths of this procedure is the formulation of the relationship of the transverse and longitudinal components of the \underline{E} and \underline{B} fields. The existence of actual longitudinal components of \underline{E} and \underline{B} , non-Hertzian waves, entails modification of gauge invariance, which we presented in detail elsewhere. [14,44] Extensive evolution of multidimensional models have been made including the application to the design of specific parameters for emission and reception antenna.

Exciting possibilities of a new picture of explaining, understanding and utilizing earth resonance modes may emerge from our five and eight dimensional wave equations. Our theoretical work and experimental data has allowed us to predict earthquake and volcanic activity with approximately 84% accuracy. [4] Future research should lead to more accurate predictions and predictive methods.

Specifically, we can define an orthogonal set of dimensions x, y, z, t, τ . In general, we can express a form of the five dimensional generalized wave equation from the Laplacian form

$$\hat{\square}^2 \psi = \square^2 \psi - 1/c_0^2 \partial^2 \psi / \partial \tau^2 \quad (14)$$

where we define a new five dimensional operator $\hat{\square}^2$ and where \square^2 is the usual D'Alembertian operator

$$\square^2 \equiv \nabla^2 - 1/c_\omega^2 \partial^2 / \partial t^2 \quad (15)$$

and ∇^2 is the del operator representing the spatial part of the equation as $\nabla^2 = \partial^2 / \partial x^2 + \partial^2 / \partial y^2 + \partial^2 / \partial z^2$. We define the wave amplitude as dependent on the five space independent parameter as $\psi(x, y, z, t, \tau)$. We define a velocity c_w associated with the time variable τ and frequency μ and c_ω is the velocity associated with the time variable t .

Assuming a functional dependence of w on $w(t, \tau)$ and ω on $\omega(t, \tau)$ and where w and ω are "locked" so that the time frequency domain simultaneously display a similar wave form, where amplitude versus time t and power spectrum versus frequency ν are similar forms.

We express these conditions in a form of a general wave equation as

$$\hat{\square}^2 \psi = \frac{1}{c_0^2} \frac{\partial^2 \psi}{\partial t^2} - \frac{1}{c_w^2} \frac{\partial^2 \psi}{\partial \tau^2} - \frac{1}{2\pi c_0^2} \iiint_{-\infty}^{\infty} A \psi e^{i(kx - \omega t + q\chi - w\tau)} d\omega d\nu d\tau d\tau \quad (16)$$

Here we consider ω and w being in the same units (we are not using the usual definition $\omega = \nu/2\pi$ but $\omega \neq w$ where ω and w are distinct frequencies). The velocity c_0 is associated with wave emission in both time and frequency domain where c_0 can be a function of c_ω and c_w and the wave function ψ is a function of the five dimensional space, as $\psi(x, y, z, t, \tau)$. The variable amplitude A has a dependence on variables as $A(\omega, \nu, c_\omega, c_w)$ to insure Lorentz invariant conditions are obeyed.

The usual relations can hold $c_w = \omega/k$ and $c_w = w/q$ for wave numbers k and q . But from the above generalized wave equation, we can consider the possible form of a dispersion relation which is a complex form involving the relationship of ω , w , c_w , c_w and c_w with the associated wave numbers k and q .

In order for the time and frequency waveforms to appear to be of similar forms, the form of dispersion relation is such that the generalized wave equation is dispersion-free, or of a nonlinear form in terms of the integral term in terms $A(x,y,z,t,\tau)$ which overcomes dispersive terms.

For some general problems, the appropriate dispersion relation can assume a complex statistical form and may take on a nonanalytic form which is unsolvable except by Noval computer analysis techniques. As we suggested in our discussion of the sine-Gordon equation, it may not be most efficient to proceed from a dispersion relation. The determination of the form of the term A depends on the form of the dispersion relation and the insurance of Lorentz invariant conditions for the wave generalized equation in some applications which are relatively invariant.

Let us examine a possible form of the wave equations and solutions in a first approximation as follows. We rewrite our nonlinear equation so that the linear terms appear on the left and the nonlinear terms on the right.

$$\nabla^2 \Psi - \frac{1}{c_w^2} \frac{\partial^2 \Psi}{\partial t^2} = \frac{1}{c_w^2} \frac{\partial^2 \Psi}{\partial \tau^2} - \frac{1}{2\pi} \frac{1}{c_w^2} \int \int \int \int_{-\infty}^{\infty} A \Psi e^{i\omega t} e^{iw\tau} d\omega d\nu dt d\tau \quad (17)$$

We can treat the term $(1/c_w^2)(\partial^2 \Psi / \partial \tau^2)$ as either linear or nonlinear. If we choose a linear form for this term then t and τ are additive and this tensor can be combined linearly with $(1/c_w^2)(\partial^2 \Psi / \partial t^2)$ so that the term in τ adds only a coordinate shift. Hence we are reduced to the trivial case where we need only consider a single frequency term ω related in a simple manner to the time t . Since the trivial case is not useful, we will resume our consideration of the term $(1/c_w^2)(\partial^2 \Psi / \partial \tau^2)$ in terms of its nonlinear form.

We can define a complex form of a coupling constant that defines the relationship of the times t and τ and frequencies ω and w . We denote this term as $g^2(\omega, t, w, \tau)$. The relationship of the quantities in the term $g^2(\omega, t, w, \tau)$ determine, in part, the term $A(\omega, w, t, \tau, c_w, c_w)$ and can be derived from the five dimensional Fourier transforms.

We can write the usual Fourier Transforms for frequency and time in four-space as

$$\theta(t) = \frac{1}{\sqrt{2\pi}} \int_{-\pi}^{\pi} \phi(\omega) e^{i\omega t} \quad (18a)$$

and

$$\phi(t) = \frac{1}{\sqrt{2\pi}} \int_{-\pi}^{\pi} \theta(t) e^{i\omega t} \quad (18b)$$

In five dimensions, the Fourier transforms are expressible in terms of a 4x4 matrix array, $\phi(\omega, t, w, \tau)$ and can be written in a form as follows:

$$\theta(t, w, \tau) = \alpha \int \phi(\omega, w, \tau) E d\omega dw d\tau \quad (19a)$$

$$\theta(\omega, w, \tau) = \beta \int \theta(t, w, \tau) E dt dw d\tau \quad (19b)$$

$$\xi(w, \omega, t) = \gamma \int \zeta(\tau, \omega, t) E d\tau d\omega dt \quad (19c)$$

$$\zeta(\tau, \omega, t) = \delta \int \xi(w, \omega, t) E dw d\omega dt \quad (19d)$$

where α , β , γ and δ are constants including a 2π factor and E is the exponential $E = e^{i(\alpha x + \beta t + \gamma \tau + \delta w)}$.

The above applies for any relationship of t , τ , ω and w , and simplifies for our particular case. Consider a specific example of our data for the polarity shift phase and amplitude modulated 30 Hz Wave, with rotational vector frequency 1.54 Hz. This waveform can be described as a rotational or a screw wave in an (x,t,τ) coordinate space where the amplitude or power is expressed in the x dimension. We define a wave function solution which is related to ψ for psi (x,y,z,t,τ) in the above equations as $U(x,t,\tau)$ in terms of one spatial dimension only. The nonlinear terms of our wave equation are expressed as

$$-\frac{1}{c_w^2} \frac{\partial^2 \psi}{\partial \tau^2} - \frac{1}{2\pi c_w^2} \iiint A \psi E dV = \frac{g^2}{2\pi} \iiint P(A, \psi) E dV \quad (20)$$

where dV is the form differential $dV = d\omega dw dt d\tau$ and E is the exponential function $E = e^{i(\alpha x + \beta t + \gamma \tau + \delta w)}$. Then we can write $U(x,t,\tau)$ which is a viable solution to the above wave equation

$$U(x,t,\tau) = 4\eta_0 \operatorname{sech}\left(\frac{x - V_\omega t}{l_\omega}\right) \operatorname{sech}\left(\frac{x - V_w t}{l_w}\right) \quad (21)$$

where η is a constant and where the terms in ω and w separate out since the 1.5 Hz rotational wave (as the Foucault pendulum demonstrates) represents a five dimensional rotation of the 30 Hz Wave. If the rotational effect did not exist then the above form would reduce to the usual solitary wave form.

$$U(x,t) = 4\eta_0 \operatorname{sech}^2 \eta \quad (22)$$

where $\eta = (x-vt)/l$ and where v is a simple function of v_ω and v_w and τ represents a linear coordinate transformation of t . The terms in v_ω and v_w then just add an arbitrary phase shift to the term $\eta = (x-vt)/l$ and represents a unit length normalization so that the argument of the hyperbolic function is dimensionless.

All measurements of the 30 Hz waves and some of the 10 Hz waves couple to the earth's rotational velocity of about 1.5 Hz so that the above simple case does not hold in general.

The integral $P(A,\psi)E$ of the wave equation is derived from the coupling constant expression involving x,ω,t,w,τ . [44]

Detailed computer analysis from our data will better determine the allowable forms of $P(A,\psi)E$. [44] We see that the solutions to these wave equations will be similar to the sine-Gordon equation with soliton solutions. See Appendix II for discussion of geometric conditions on spatial, time and frequency dependence of some of our data.

Possible Activation of Earth and Earth-Ionospheric Resonance States by Solar Wind Activity

We speculate on some additional causes for seismic and volcanic phenomena as well as activation of major storm systems. Seismic activity produces physical movement of the earth in its own steady-state magnetic field and produces charge and acoustic coupling which modifies the earth's field locally. Major field coupling effects can occur due to solar wind effects, particularly during heavy particle interactions which follow major solar flares.

Planetary magnetic field organize ionized matter. The resulting magnetospheres are unique domains or "cells" of plasma that are semi-isolated and considerably different from neighboring plasma regions. The earth's magnetosphere and that of other planets are affected by planetary rotation and ionic flows from the sun and its rotational dynamics and we suspect that the diurnal cosmic bombardment also plays a significant magnetospheric role. Co-rotational plasma flows, production of plasma waves, radio emissions, and ion acceleration of thermal electrons to hundreds of MeV occur within the magnetospheres. Plasma processes can involve the usual plasma instabilities related to ionic interaction with the earth's magnetic lines of force.

Primary driving forces of magnetospheric features involve the solar wind (and its induced changes from solar flare processes) and the earth's rotation (including the steady state magnetic field as well as disturbances within this field due to the earth's physical "adjustments" such as seismic activity and volcanoes). Planetary and stellar magnetic fields are believed to organize ionized matter in stellar and galactic systems.

The deformation of the earth's magnetosphere occurs as the solar wind (an internal expansion of the solar corona) interacts and mixes with the intrinsic magnetic field generated by or intrinsic to the earth. The solar wind at the earth's orbit has an ion density of about 10 ions/cm^3 with an energy density of a few times $10^{-8} \text{ dynes/cm}^2$.

Some General Comments on Theoretical Prediction of Seismic and Volcanic Activity: Research Conducted 1979-1990

Our data and records indicate that earthquakes and volcanic activity seem to be able to be modified by sunspot/solar flare activity and cycles in a manner similar to the effect of tidal action (caused by the gravitational pull of the moon) except that this sunspot/solar flare/earth interaction produces electromagnetic activity in the earth environment. Weather processes also appear to depend on solar cycle patterns. As is known, sunspot magnetic "storm" activity produces changes in the solar wind. The heavy particle interaction with the ionosphere produces charged state changes within the E layer and other charged layers of the atmosphere which creates induced magnetic fields. These fields and current flows interact with, affect, modify and perturb the earth's "steady state" magnetic field. As the lines of force of the earth are affected and "wiggled," the core mantle interface is affected. Extreme effects produce energy releases in the form of earthquakes and volcanic activity. Upper atmospheric effects can drive the jet streams and modify their paths and structures and thus affect the weather. Concurrent with major seismic and volcanic occurrences is the production of lightning which also affects weather. As is well known, increased atmospheric gases and particulate matter can affect global weather patterns.

Large earthquakes can also "wobble" the lines of force of the earth's magnetic field and hence, in turn, affect ionosphere ionization states, thus affecting weather and other reverberatory seismic modes of excitation. Lightning strokes and piezoelectric releases in rocks in the earth produce electromagnetic field spike-like impulses which are measurable with suitable instrumentation. All these phenomena produce characteristic electromagnetic wave signatures which we can and do record and analyze.

Earthquake tables containing predicted location and estimated magnitude can be constructed in a manner analogous to tide tables. Predictions of possible volcanic activity can also be generated. These and other data might also be utilized to generate long term weather profiles.

Conclusion

The earth and the life forms upon its surface vibrate and resonate in harmony in such a manner that radiant energy from the sun and materials and vibrations of the earth support this life and its evolution. Some of the major normal oscillatory modes of the earth are in the 9-13 Hz range which, interestingly enough, is about the power spectrum peaking for most people's alpha frequency.

It is clear that we depend on "Mother Earth" for our life, but whether, in some sense, the earth itself depends on the life forms on its lands and in its seas and atmosphere, is another matter; ie. is there a symbiosis between the earth and the life it supports?

We know that man can create great changes, some of which have polluted the air, land, streams and seas with chemicals, radioactivity and electromagnetic waves. Some changes wrought by man can be repaired by the earth but others may not be so easily repaired. The question of why man should pollute his life support system continues to go unanswered. Some of the electromagnetic waves generated by man may have global significance for the earth and the life forms upon it.

In this project and in this paper, we have explored the earth's magnetic field emanations, those that are natural and those activated by man. There are a multitude of natural modes, such as the earth's mechanical rotation, seismic activity, volcanoes, solar wind and solar broadband noise activity and many others.

Also impressed upon the environment are many man-made sources disturbing both the atmosphere and the earth. Some of these emissions may be reaping irreparable damage to the ionosphere and earth which, in turn, threatens our very existence. We must examine what we are doing as people, as societies and as nations!. If we do not develop a new consciousness and awareness, destruction of life will inevitably result.

When the earth and the life upon it is in harmony, the system is mutually life enhancing. Man has (or has had) great abilities and potentials and yet, most of his recent technologies have been to strip nature away from us—to shield us from nature, to "conquer" and control her while designing ever more dangerous weapons systems with which to more efficiently strip all life from the planet. We must examine why man has moved toward such insane motivation, toward mutual destruction and whether mutual life enhancement and sanity can again become the noble objective of pursuit which desperately need implementation today.

Acknowledgements

The authors appreciate the assistance of Harold Faretto in helping us with some of the measurements and engineering work on TRL projects and thanks to Hal Treacy for his assistance in providing us some necessary equipment for TRL projects.

Measurements Of Seismic Precursor Excitation Modes

Earth mechanical or seismic oscillations produce longitudinal excitations in the earth itself. These oscillations produce local and global disturbances which involve local field coupling which perturb the earth's global steady-state magnetic field. The seismic excitations produce pressure and stress waves which have acoustic components as well as "wiggle" the Earth's lines of force producing a magnetic fluctuation component. These acoustic and magnetic components are related, albeit, in a complex manner. The magnetic field oscillations associated with seismic and volcanic activity all lie at the low end of the EMR spectrum (0.3 to 300 Hz). Also, the associated acoustic modes lie in a similar frequency range to that of the ELF activity.

As we have explained elsewhere, ELF magnetic field oscillations have transverse as well as longitudinal modes of excitation and the longitudinal modes appear to be acoustic-like, at least as considered in "four space." Most of the earth-activated ELF modes are non-sine wave-like, having a number of Fourier components.

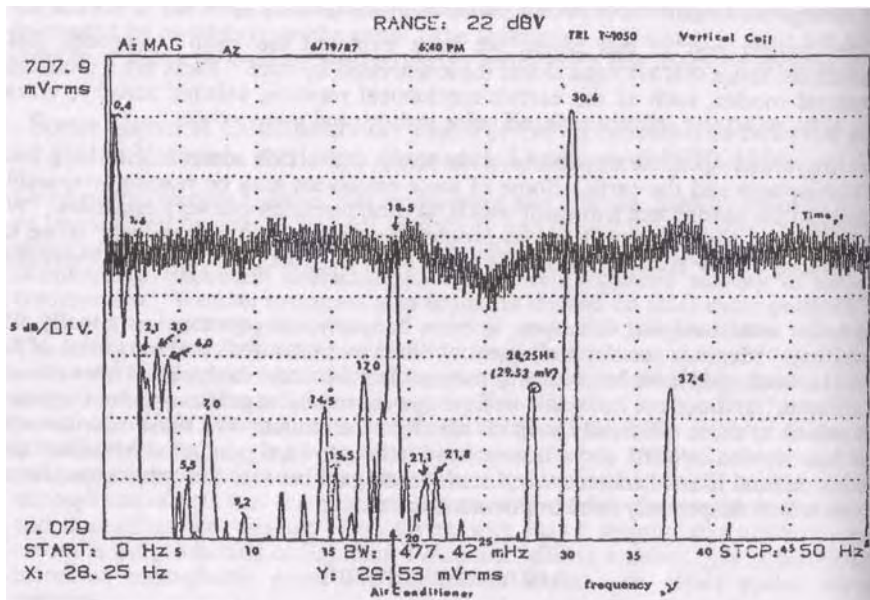

Figure 1. Typical frequency and time domains of magnetic field oscillations which are dominated by the approximately 30 Hz signal. The about 1.56 Hz signal heterodynes with the 30 Hz signal as seen in the time domain. Most of the frequencies below about 11 Hz are natural geologic and atmospheric oscillations. The 0.4 Hz is the Earth's fundamental magnetic rotational component and the 1.56 Hz is its standard rotational vector and the 3.0 to 3.2 Hz magnetic pulsation component is the seismic precursor signal.

The 5.5 to 5.9 Hz signal is usually associated with excitation in the ionospheric D layer and the 9.2 Hz signal appears associated with heavy particle interactions from solar flare activity bombarding the ionosphere. Frequencies of 12 Hz and above are primarily from man-made sources. The 17 and 18.5 Hz are from the air conditioner compressor near the building where the data was recorded and disappeared when the air conditioner was shut off. The 30 Hz signal with 28.25 Hz side lobes is probably a spurious emission of Project ELF.

Precursor frequencies of magnetic field oscillations, observed before the onset of seismic activity, are usually the third and fourth harmonic of the earth's rotational excitation. The difference between the earth's steady state magnetic field and the earth's mechanical rotational axis is 22.5 degrees at the poles. Hence, the first oscillation of the actual rotational vector is 0.4 Hz ($= 3.14 \times 360/22.5$). The second harmonic is 0.8 Hz and the third harmonic is 1.6 (more precisely, 1.56 for the nonlinear progression) and around 3.16 to 3.2 is the fourth harmonic. [45]

As the earth rotates, the Coriolis force is stored in the earth's body. We observe this energy storage as a build-up of a magnetic signal of about 3.16 to 3.2 Hz. From about 24 to 72 hours before an impending event, the approximately 3.2 Hz signal disappears. Triangulation on the maximum magnetic amplitude of the 3.2 Hz signal is used to locate the future or impending event. If the 3.2 Hz signal reappears within the 72-hour time frame, then the time line starts running again for another 24 to 72 hours.

The 1.56 Hz signal is almost always present and, from this signal which we term rotational vector, we can estimate the magnitude of the future event. The percentage of deviation from the normal value of the rotational vector gives an approximate magnitude, depending also upon the distance from the measurement instrumentation and the epicenter of the impending event.

We observe a range of "rotational vector" values between 1.26 Hz and 1.80 Hz. The smaller the deviation from the normal value of the rotational vector, the smaller the quake will be. The deviation of the rotational vector is proportional to the impending quake magnitude. For example, 1.26 Hz or 1.80 Hz can be associated with over 6.5 to 7 on the Richter scale depending on the distance from the detection point to the site of the impending event.

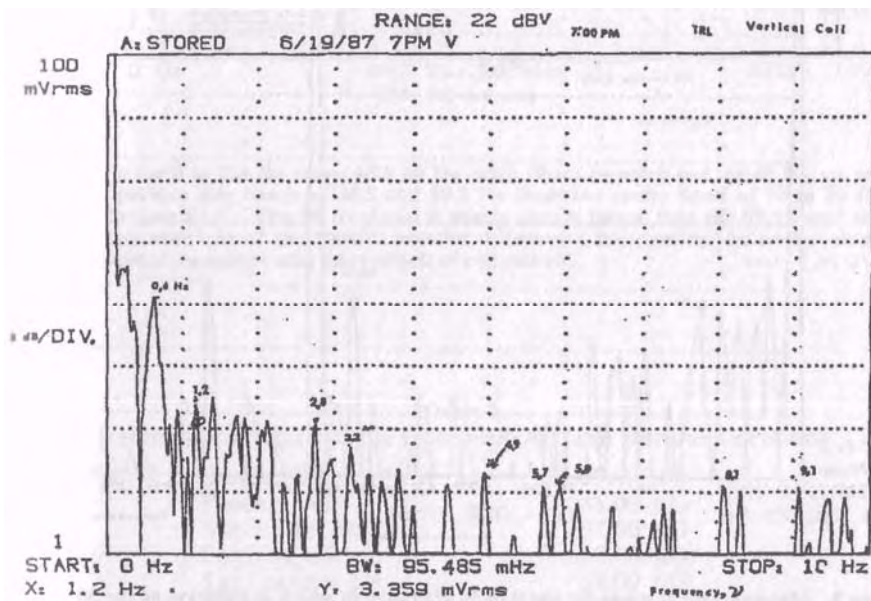

Figure 2. Again a typical display of natural magnetic frequency emissions is given in the "geologic frequency range." Both Figure 1 and Figure 2 data were collected from the vertical orientation of the coil antenna.

The earth and sun have oscillatory modes which we can treat in a manner analogous to that of a ringing bell. These acoustic modes are actually the mechanical motion and they perturb the earth's steady-state magnetic field of 0.5 gauss at the San Francisco Bay area latitude, giving rise to magnetic field oscillations and electromagnetic waves. Hence, magnetic and acoustic modes are related to each other.

The longitudinal modes of ELF waves can be detected by a coil of about 17 miles of AWG #44 wire wound on a spool. These modes travel at about $v_b = 3 (10^8)$ cm/sec as compared to $c = 3 (10^{10})$ cm/sec, so that for transverse electromagnetic radiation for a 7.80 Hz signal wavelength, $\lambda = 25,000$ miles--approximately the circumference of the earth. For the longitudinal modes of excitation traveling at v_b for a wavelength, λ is about 1/4 mile at a frequency of 7.80 Hz. The coil detection system responds well to the nonlinear ELF waves and the coil containing about 52,800 feet of wire which is very adequate to measure down to the frequency of the thrust waves associated with Love and Rayleigh wave activity of about 0.2 Hz with a wavelength of about 10 miles. We have observed the 0.20 Hz thrust waves associated with on-going seismic events on numerous occasions.

The nonlinear coil response acts like a "giant resonant" (as in nuclear physics) detection (without the circuit amplifying and smoothing elements) and has a peak primary response at 48 Hz for $f_r = 1/(2\pi\sqrt{LC})$ for the coil system currently in use at this frequency range acts as if it has a large cross section (or giant resonance) for ELF detection.

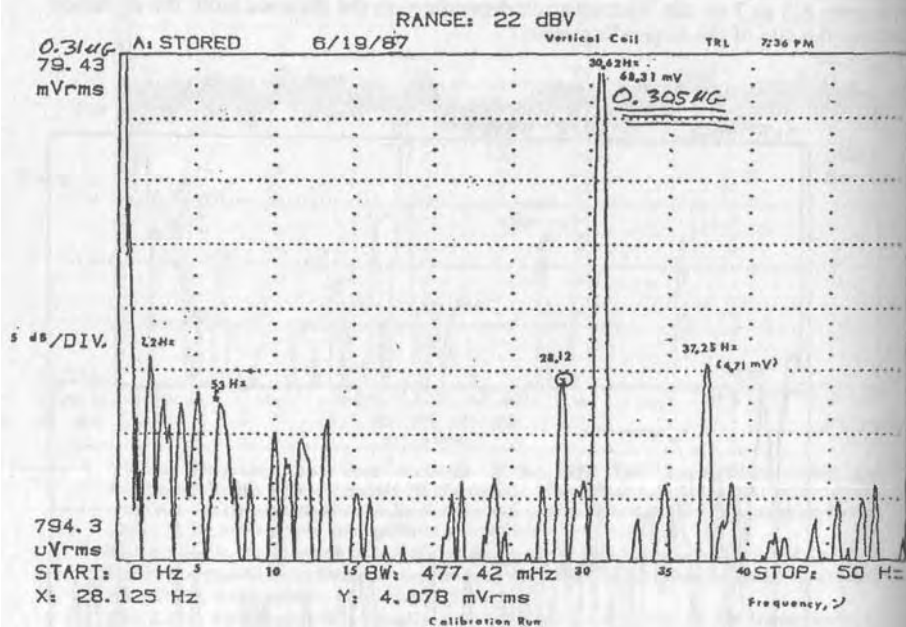

Figure 3. Measurement is made for the 0 to 50 Hz range in which calibration of the 30.625 Hz signal is made as a secondary standard to NBS. Table 1 following this figure gives approximate relative magnitude of the 30 Hz signal measured at various times, as time averages in various locations. All data in these figures was taken prior to 1987.

The T-1050 magnetic field detector has a series of amplifying, smoothing elements and notch filters which make for flat response from 0.1 to 50,000 Hz for magnetic field strengths only detection with a sensitivity of about 10^{-6} Gauss for the high pass circuit; 0.1 to 200 Hz for the low pass circuit with a sensitivity of 0.5×10^{-10} Gauss.

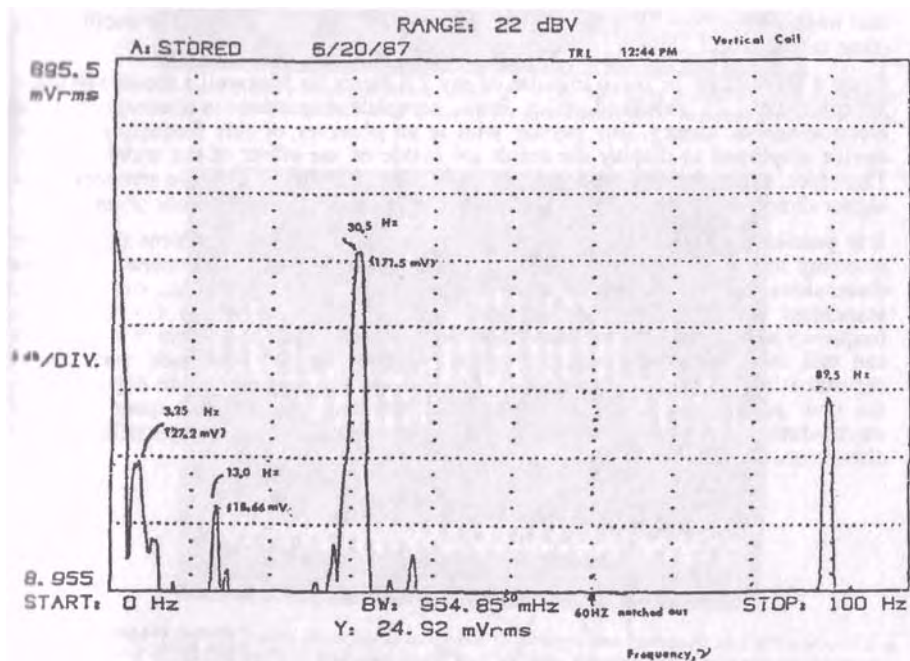

figure 4. In the 0 to 100 Hz range with 60 Hz notch filters to notch out the 60 Hz, we see the spurious side bands of 30.5 and 89.5 Hz from the center band of 70 to 76 Hz for Project ELF. The 30 Hz signal is nearly always larger than the 89.5 signal since it lies near one of the Earth's rotational resonant frequencies. In earlier measurements there were also some effects of coil roll-off.

Table I.
Relative Magnitude of the Observed 30 Hz in Various Locations

Seattle, WA	90.00 μ G
Phoenix, AZ	88.00 μ G
Vancouver, BC	37.50 μ G
Portland, OR	30.00 μ G
San Leandro, CA	03.00 μ G
New Orleans, LA	00.99 μ G
Kirkland, AZ	00.30 μ G

APPENDIX II

ELF Data Evidence Implying the Need for a Five Dimensional Geometry

Measurements for ELF frequencies in the region below about 300 Hz with a coil magnetic detection system indicate the need for a mathematical model consisting of greater than four dimensions (of space and time) in order to explain the observation that impulses in the ELF region appear as identical patterns both on the oscilloscope (time domain) and a spectrum analyzer (frequency domain).

Since a wavelength or wave impulse of say 7.8 Hertz (in Maxwell's theory) requires approximately 25 thousand miles for a complete excursion in the conventional electromagnetic theory, any person who is an observer of this frequency and the device employed to display the result are inside of the effect of the wave impulse. Therefore, either the observation of the event and the display of it are erroneous or a higher dimensional treatment of the results are necessary to explain our observations.

It is possible to explain the observation of similarity of space and time displays by resorting to a five dimension geometric description of ELF phenomena. The five dimensions are composed of three spatial amplitude dimensions, one of time associated with the amplitude or usual time or A-t plane where $t = 1/\nu$ and a frequency associated with the amplitude frequency or A- μ plane where $\tau = 1/\mu$. We can call this "space" the x,y,z,t, τ space. (We define the amplitude variation as dependent on the usual parameters as $A(x,t,\nu)$ and the new amplitude dependent on the new parameters $A'(x,\tau,\mu)$.) Note that this five dimensional space with all macro-dimensions is not like Kaluza-Klein geometry with a compactified spatial dimension. [46]

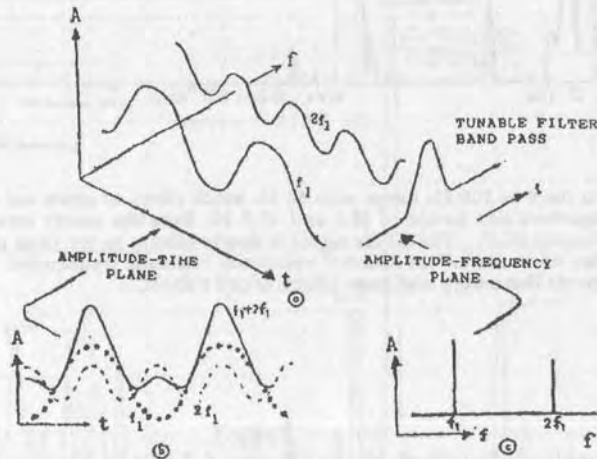

Figure 1. a) Three-dimensional coordinates showing time, frequency and amplitude. The addition of a fundamental and its second harmonic is shown as an example.

b) View seen in the t-A plane. On an oscilloscope, only the composite $f_1 + 2f_1$ would be seen.

c) View seen in the t-A plane. Note how the components of the composite signal are clearly shown.

The nonlinear coil response acts like a "giant resonant" (as in nuclear physics) detection (without the circuit amplifying and smoothing elements) and has a peak primary response at 48 Hz for $f_n = 1/(2\pi\sqrt{LC})$ for the coil system currently in use at this frequency range acts as if it has a large cross section (or giant resonance) for ELF detection.



Figure 2. Five second display from spectrum analyzer set at 100 KHz resolution and zero span gathered in Portland, OR. Top trace 10 Hz electromagnetic variable polarity waves.

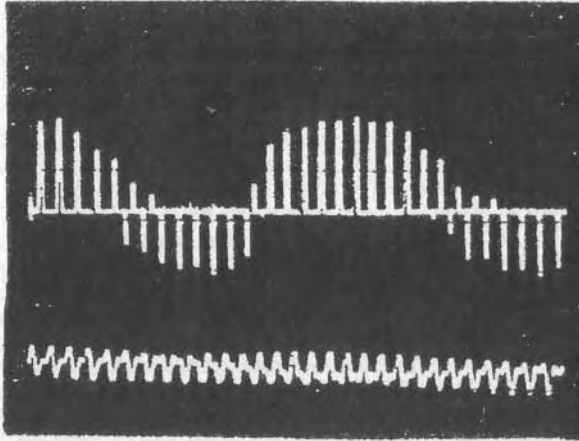

Figure 3. Two 1 second traces of ambient magnetic field impulses gathered in California with a coil detection system and displayed in the time domain on a storage oscilloscope. Top trace railed; bottom trace normalized headroom. Note the variable polarity serpentine like characteristics similar to Figure 2.

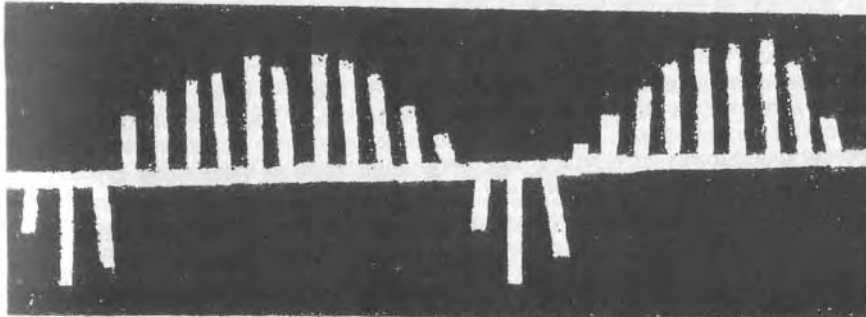

Figure 4. This diagram was taken from the cover of Reference 31, A.C. Scott's text "Active and Non-Linear Wave Propagation in Electronics." This figure is generated as a mechanical model to represent the wave output of a system obeying the sine-Gordon equation. A series of small pegs or nails of equal length are placed on a wire (which would look like the proverbial white picket fence). To create the figure, the center flexible wire is rotated two and a half twists, creating the display observed and photographed in this figure. Observe the similarity between this figure and Figure 3 which is the time display of the 30 and 1.5Hz signals *heterodyning*.

Maxwell's equations are only approximately valid in the ELF region when coil emitters and sensors are utilized and the results plotted by means of oscilloscopes and spectrum analyzers. Gauge invariant conditions are modified in the frequency range of ELF. [44]

We present examples of frequency and time domain measurements which lend support to the statements we have just delineated. Figure 1 shows the unusual relationship of a typical sine wave and its representation in the frequency and time domain. Figure 2 is an example of the serpentine-like appearance of the "Russian Woodpecker" in the frequency domain as demodulated by a spectrum analysis. Shown are the 10 Hz pulses on a high frequency "carrier."

Figure 3 is a representation of a magnetic field measurement of about a 30 Hz signal gathered with a coil detection system and displayed on an oscilloscope in the time domain. Although the frequencies are 10 and 30 Hz respectively, the ELF region of interest that they occupy are close enough to note that both of these displays are highly similar and serpentine-like, implying a comparative measurement in the frequency domain; and time domain at higher frequencies do not exist at ELF.

The trace in Figure 4 is generated as a mechanical model of soliton waves generated by the sine-Gordon equation which has periodic soliton solutions. Note the similarity to Figure 3 which is a magnetic signal observed with the T-1050 displayed in the time domain at about 31.5 Hz which can be decomposed into a 30 Hz signal heterodyned with a 1.5 Hz rotational vector. The amplitude is 2 volts/division for a one second trace. Pulse modulation at 3.33 Hz was observed. Normally one would describe this signal as a Heterodyne of 30 Hz and 1.5 Hz but the rotational wave characteristics are better seen in the nonrailed signal in Figure 3, the second trace. The signal in the top trace in Figure 3 is actually a slice in two dimension from a rotational wave in five dimensions or five dimensional rotor or screw wave which is like a five dimensional twister algebra related to a four dimensional spinor calculus.

In Figure 5 is a five dimensional representation of this screw or rotational wave. To represent it in a two dimensional figure on flat paper, we consider amplitude as a function of x only rather than x, y and z . The other variables of the wave amplitude are time, t , and frequency, μ , where $t \neq 1/\mu$ but $t = 1/\nu$ for $\nu \neq \mu$. This figure can explain the observation seen in Figure 2 and 3 and a great deal of other similar data with the model of the multidimensional soliton wave. Figure 6 is a schematic representation of the tube-like waveform in x, t, τ space which moves like a "slinky" toy. The "slinky" coils represent the Fourier of the magnetic field and can be seen as the wave with spikes in space and time.

Simple solutions to solitary wave equations can be found in terms of the usual conic section form of the trigonometric functions of sines and cosines built on the relationship to the sphere. Simple second order equations generate parabolic and hyperparabolic forms $x^2 + y^2 = c$ as contour integration of exponential functions in the complex plane $z = x + iy$ for $i = \sqrt{-1}$.

We will examine the properties of Fourier and Laplace transforms and Lorentz invariants conditions and relate these to Gauss's theorem.

Consider a simple description of the waveforms and their relationship and the frequency and time domain to generate Figure 5. Consider the simple case where the cross-sectional area of the volume generated by and swept out in the frequency and time domain in circular so that more forms observed in the frequency and time domains appear the same. Also consider the envelope on the curve as seen as extended oscillation, in their amplitude dependence or frequency and time, obey sine waves such as $x = \sin(t/t_0)$ and $x = \sin(f/f_0)$ contained under the envelope of the curve. Note that in general, the five dimensional travelling wave can be elliptical, having different "periods" or extensions in time and frequency, for example, the

extension in time could be associated with the major axis and the extension in frequency with the minor axis of the ellipse in Figure 5, we represent only one period cycle in the x-t and x-f planes.

In actuality, waveforms in space and time and frequency dependence extend out in the x-t (also termed x-v) and x-f (also termed x- τ or x- μ) planes so that wave effects extend as amplitude disturbances in the five dimensions of (x,y,z,t, τ) for t association with v and τ with μ or f in Figure 5. Then the t-f, x-t and x-f planes represent slices through the five dimensional space. Even though the figure looks like these planes are generated by a projective geometry, in fact we consider a mapping procedure which does not produce distortion. We will consider an example of this later. For the wave amplitude extension, we consider one dimension x of space only rather than x,y,z considering the relationship of frequency and time, the simplest case becomes $t = 1/f$ (where we use f and v interchangeably). The case where $t = 1/f$ is given in Figure 1 in which we observe a sine like wave forms in the time domain and spike wave forms in the frequency domain. In Figure 5, we can associate f with v (and t) or μ (and τ). This form in general obeys that for a rectangular hyperbola of the form $(t/t_0)^2 - (f/f_0)^2 = 1$ asymmetrically bound to the upper quadrant t and f axis, with a lower image and symmetry exists for $t_0 = f_0 c_0^2$ so that $t^2 - f^2 = t_0^2 = f_0^2 c_0^4$ is a unit length space of c_0 for velocity $c_0 = l_0/t_0$ dimensionless, gives the gradient of the asymptotes gives $\tan \alpha = \pm 1$ for $\alpha = 45$ degrees. Note also that $t = t_0 \cosh \eta$ for $\eta = (fc_0)/(f_0 c_0)$ which is dimensionless.

Returning again to Figure 5, the frequency and time relationship of τ and μ act as a rotational frequency in x, τ space. The general relationship x,t, τ can be represented as a circle or ellipse as a slice through the 3 space x,t, τ in the one dimension of space, x approximation in which we use to solve the sine-Gordon equation. Then we can write $(t^2/t_0^2) + (\tau^2/\tau_0^2) = 1$ where $|t/(rc_0)| \leq 1$ and $|\tau/(rc_0)| \leq 1$ and let $c_0=1$ and where r is an average radius of a circle, $t/r = \cos \theta$ and $\tau/r = \sin \theta$ and $t + i\tau = r(\cos\theta + i \sin\theta)$ where r is in units of t and τ (in seconds) for $C_0=1$ and $0 \leq \theta \leq 2\pi$. Consider the case where $v=30\text{Hz}$ "heterodynes" with the $\mu=1.5\text{Hz}$ signal, then $t=0.033\text{Hz}$ and $\tau=0.667$ (about 1 second). Then the rotational process in 5D spaces moves 1.5Hz as seen in our data in Figures 2 and 3. The value r is defined as $r = \sqrt{t^2 + \tau^2}$ with eccentricity $e = \sqrt{(t^2/r^2) + (\tau^2/r^2)}$ or taking $t_0 + \tau_0 = 1$ then we can write $e = 1/\sqrt{1 - \tau^2/r^2}$ so that $t = e/\sqrt{1 - \tau^2/r^2}$.

In general, proceeding with the Cauchy Integral theorem in the complex plane, we define an analytic function f(z) in a simple region of space bounded by a region, R of the Argand plane. Then on a simple closed path in R, we have $\oint f(z) dz = 0$ where $z = x + iy$ where the vector z makes an angle θ with x. For a circle $\oint dz/z = 2\pi i$ for $i = \sqrt{-1}$ and x, y and θ are real. For this example $z = Re^{i\theta}$ the real and imaginary exponential occupy a fundamental role in describing our sections and the geometry of electromagnetic waves.

Consider the conformal mapping from a linear space to an elliptic or hyperbolic plane. For $W = u + iv$, $x = a \sin \mu \cosh \mu$ and $y = a \cos \mu \sinh \mu$ for $v = a$ constant not equal to zero maps to an ellipse and $\mu = \text{constant}$ not equal to zero maps to a hyperbola in the z plane. If $W = \sin^{-1}(z/a)$ then $z = a \sin w$. Note that these procedures generalized to the complex plane, generate the conic forms in terms of exponents such as $e^{ix} = \cos x + i \sin x$ and $e^x = \sinh x + i \cosh x$ and $\cos ix = \cosh x$. A number of the trigonometric and hyperbolic functions can be generated from the real and imaginary exponents. Note that the hyperbolic functions $\sinh x$ and $\cosh x$ describe the path of a chain suspended at two points.

Turning our attention to what appears as a series of Fourier components, we consider Laplace and Fourier transforms. Consider the Laplace transforms of the Bessel function $J_0(t) = \sum_{n=0}^{\infty} (-1)^n (t/2)^{2n} / (n!)^2$ which gives the transform $\phi(p) = 1/\sqrt{1-p^2}$; where $P \rightarrow 0$ and

$\int_{-\infty}^{\infty} J_x(t) dt = 1$. Returning to the usual Fourier transforms written before for $\theta(t)$ and $\phi(w)$, we have $\phi(w)$ as e^{-w} transforming as $\sqrt{2\pi}/(1+i^2)$ or e^{-w} transforming as $\sqrt{2\pi}/(1-i^2)$. Let us briefly turn our attention to invariant conditions.

Note simply that if $x^2/r^2 + y^2/r^2 = 1$ for $z = x + ib$ represents a parabola then the complex conjugate of z or $z' = x - ib$ generates the equation of a hyperbola $x^2/r^2 - y^2/r^2 = 1$ for $|z| = r$. Orthogonality of states can be defined here in terms of z and z' .

Forms such as $\int dx \sqrt{1-x^2} = \text{arc sin } x$ occur. For the proper time $t' = t\sqrt{1-\beta^2}$ for $\beta = v/c$ which defines the "four vector velocity" $v = dx/dt$ and the time-like component is

$$P_4 = t = mv_4 = \frac{imc}{\sqrt{1-\beta^2}}$$

An equivalent set of Lorentz conditions are made at a low velocity of propagation and these are the forms that we use in the theoretical soliton model presented in the text.

In the the usual four space representation we use the (+ + + -) signature so that x_4 or time = ict where a four vector space (space and time representation) requires a complex space description. Consider the example of a uniform magnetic field along the z axis when charged particles will move in a circle in this field. We will say a few words about the particle path of motion in the relativistic approximation detailing more in a future paper. In a uniform magnetic field, the particle velocity and momentum goes as $v = u \cos kt' + u \sin kt'$ where $k = (e\mu_0 B)/mc$ and in a uniform electric field $v' = c \sinh Kt' + b \cosh Kt'$ for $K = eE/mc$ where the proper time, t' define the relativistic and invariant is given as $t = [(1+\mu^2+v^2)/c^2]t'$ and $dt/dt' > 1$ which means that when the energy of the system increases, the orbital particle path becomes smaller which is the resonant principle of the cyclotron. Also this principle applies to the MASE process in ELF phenomena for the magnetic amplification of stimulated electrons.

Invariance principles are statements of conservation laws. Gauss's theorem defines the conservation of flux or charge within a closed surface S . Applied to electric fields $\int_S \mathbf{E} \cdot d\mathbf{S} = 4\pi Q/\epsilon_0$ where Q is the algebraic sum of all charges inside the surface, S where the integral is taken over the surface, S . This condition expresses the manner in which a Faraday shield works and applies to the conditions on the operation of the shielded coil for the T-1050 detector. We can write Gauss's theorem in terms of the electric potential or $\int \mathbf{E} \cdot d\mathbf{S} = -\nabla^2 \psi$ so that we have Poisson's equations as $\nabla \cdot \mathbf{E} = -\nabla^2 \psi = (4\pi Q)/\epsilon_0$ where units $\epsilon_0 = 1$ are often used. We can apply Gauss's theorem to fields other than electric fields--such as the earth's gravitational field. Application of Gauss's theorem and a Poisson-like formalism can be applied to magnetic flux conservation on a hyper-dimensional surface defined in five dimensional space. This conservation principle leads to the great stability ELF flux phenomena that is well described by Soliton physics.

The usual form of Poisson's equation is $\nabla^2 \psi = 4\pi\rho$ in three dimensions, which Einstein expanded to four dimensions $\square^2 \psi = 4\pi G/C^4$ in general relativity. We write a similar expression in x, y, z, t, τ space as $\square^2 \psi = 32\pi\rho_p/C_5^4$ where ρ_p is the magnetic flux density in five dimensional states. We define the generalized Laplacian form as before as $\square^2 \psi = \square^2 \psi - 1/c_5^2 \partial^2/\partial \tau^2$.

The magnetic flux field, B in five dimensions acts as a bundle of the magnetic flux lines in a variable diameter cable tube. The magnetic flux potential is conserved in five dimensions forming Gauss's theorem in an analogous manner to that done in three dimensions, we define a surface integral over a four space S_4 and define a magnetic flux vector B_5 in five dimensional space having a flux density ρ_p of so that

$$\iiint \int_{S_4} = B_5 \cdot dS_4 = \frac{16\pi\rho_B}{C_0^2}$$

See reference 9 for a more detailed description of the model and its application to geophysical and other magnetic flux phenomena.

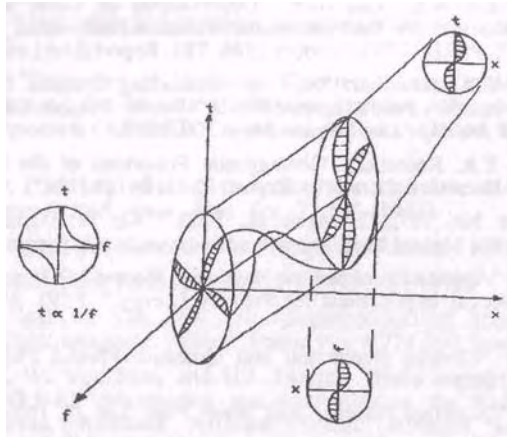

Figure 5. In this figure is displayed a symbolic representation of the rotational or twister wave in five dimensional space.

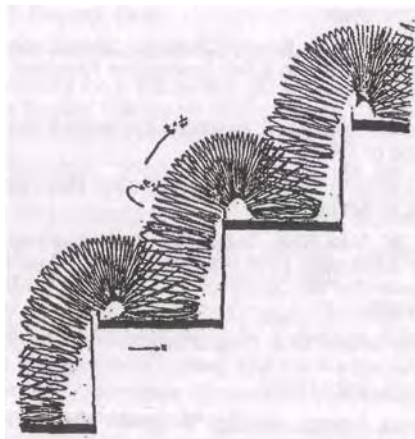

Figure 6. Representation of the Fourier components of an ELF wave in a Five Dimension Space in which the frequency and time domain appear to be similar to each other.

References & Footnotes

- [1] W. V. Bise. "New Method of Presensing and Monitoring Volcanic Activity at Mt Saint Helens, Washington," Planetary Association for Clean Energy 2:2; page 9, May 1980.
- [2] W. V. Bise. "A Week in the Magnetic Life of Mt. St. Helens," Planetary Association for Clean Energy 2:3; page 10, July-August 1980.

- [3] W. V. Bise. "Magnetic ELF Comparisons with Acoustic Measurements on Mt. St. Helens" Planetary Association/or Clean Energy 3:1: page 26, June 1981.
- [4] W.L. Van Bise and E.A. Rauscher. "Instrumentation and Techniques for Analysis of Extremely Low Frequency (ELF) Magnetic Field Impulses Proceeding Geologic Events," Bull. American Physics Society 32,67, 1987; PSRL-17630AJ, October 1986, TRL Report, San Leandro, CA. 94579
- [5] E.A. Rauscher and W.L. Van Bise. "Observations of Local and Global Earth Ionospheric Excitations for Earthquake and Volcanic Predictions," Bull. Am. Phys. Soc. 32,67,1987; PSRL 17741, October 1986, TRL Report SA n Leandro, CA. 94579
- [6] W.V. Bise and E.A. Rauscher: "Non-superconducting Systems for Detecting and Analyzing Low Intensity Pure Magnetic Fields." Tecnic Research Laboratories Report, published in Bull Am Phys Soc, Volume 34, p. 109, 1989.
- [7] W.V. Bise and E.A. Rauscher: "Geomagnetic Pulsations of the Earth's Magnetosphere." Tecnic Research Laboratories Report, PSRL-24125 (1987).
- [8] N. Tesla, Patent No. 787,412. April 18, 1905. "Act of Transmitting Electrical Energy Through the Natural Medium" and related patents and papers.
- [9] E.A. Rauscher. "Application of Soliton Physics to Plasma-MHD and Super Conducting BCS: Theoretical Implications for Primary Energy." PSRL-3107, TRL Report, November 1982.
- [10] E.A. Rauscher. "Electron Interaction and Quantum Plasma Physics," J. Plasma Physics 2, 517 (1968).
- [11] E.A. Rauscher. "Quantized Plasmas" Bull. Amer. Phys. Soc. 15, 1639 (1970).
- [12] E.A. Rauscher. "Nonlinear Coherent Modes in MHD-Plasmas," Bull. Am. Phys. Soc. 21,1337(1983).
- [13] N. Tesla, The Colorado Springs Notes, published by J. Ratliff, The Tesla Publishing Company, Milbrae, CA 1980.
- [14] E.A. Rauscher and W. Van Bise, "Geologic Significance of the Fundamental Excitatory Modes of the Earth and Earth-Ionosphere Resonant Cavity," PSRL -70253, January 1986.
- [15] E.A. Rauscher commuted daily to Lawrence Livermore Laboratory on Tesla Avenue from early 1966 to end of 1969.
- [16] E.A. Rauscher, "A Unifying Theory of Fundamental Processes," UCRL 20808, June 1971, University of California LBL Press.
- [17] E.A. Rauscher and W. Van Bise, "Multiple Wave Analysis Measurements at Low Frequency (LF) and Extremely Low Frequency (ELF) Artificial and Natural Radiation," Pac. NW Center for the Study of Non-Ionizing Radiation Report. Portland, Oregon, September 1980.
- [18] Project ELF, formerly referred to as Project Sanguine and Project Seafarer, is reviewed in several issues of Aviation Week and Space Technology and also J.R. Waite "Project Sanguine," Science 178, 272 (1972).
- [19] Nikola Tesla: Lectures. Patents. Articles. Belgrade, Yugoslavia: Nikola Tesla Museum, 1956.
- [20] K.M.Swezey, "Nikola Tesla," Science 122, 1147,1958.
- [21] M. Sugiara and J.P. Heppner, "Electric and Magnetic Fields in the Earth's Environment," American Institute of Physics Handbook. McGraw-Hill Book Company. 1972; Section 5 pages 265-303.
- [22] N. Tesla. "The Transmission of Electric Energy Without Wires," Electrical World and Engineer. New York: March 5, 1904.
- [23] M.M. Frocht, "Experimental Stress Analysis," Handbook of Physics. McGraw-Hill Book Company, 2nd edition, Part 3, Chapter 6, page 84.
- [24] E.V. Condon "Molecular Optics," Part 6, Chapter 6, page 117.

- [25] J. A. Silva and G. Lochak. *Quanta*. New York: McGraw-Hill Books Company 1969. (page 1969)
- [26] F.M. Lowry, *Optical Rotary Power*, London: Longman's, Green & Co, 1935.
- [27] E.V. Condon, "Electromagnetic Waves," Part 6, Chapter 7, page 5.
- [28] H.B. Callen, "The Energy Band Theory of Solids, Part 8, Chapter 8, page 24.
- [29] J.C. Anderson, *Magnetism and Magnetic Materials*: London: Chapman and Hall, Ltd. 1968; Page 199.
- [30] E.A. Rauscher "Properties of Nonlinear Coherent Modes in MHD Plasmas and a Possible Solution of the Plasma Combinent Problem," Proceedings of the Tesla Centennial Symposium (An IEEE Centennial Activity) Editor, E.A. Rauscher, Tesla 1984.
- [31] E.A. Rauscher, "Solitary Waves, Coherent Nondispersive Solutions in Complex Minkowski Spaces," *Bull. Amer. Phys. Soc.* 27 135 (1982).
- [32] C. Rebbi, "Solitons," *Scientific American*; page 92, February 1979.
- [33] *Aviation Week and Space Technology*, page 19, Nov. 8, 1976.
- [34] E.A. Rauscher and W. Van Bise, "Non-Superconducting Apparatus for Detecting Magnetic and Electromagnetic Fields." Patent No. 4,724,390, Issued February 1988.
- [35] E.A. Rauscher, W. Van Bise, and H.J. Faretto: "Field survey measurement of the ambient ELF-VLF-LF frequencies and intensities at the Kalish Ranch site and surrounding areas, Kirkland Arizona." *Tecnic Research Laboratories Report*, PSRL-27643, August 1987.
- [36] E.A. Rauscher, "Theoretical Examination of Nonlinear Far From Equilibrium Self-Organizing Phenomena," TRL Report PSRL-103764, Abstract March 1985, Presented at the USPA. July 1985, Dayton, Ohio.
- [37] A.C. Scott, "Active and Non-Linear Wave Propagation," *Electronics*, 1985.
- [38] W. Van Bise, "Extremely Low Frequency (ELF) Radio and Magnetic Signals-New Biologic Clues in the Pacific Northwest Environment," N.W. Center for the Study of Man-Ionizing Radiation Report, Feb 1980, Portland, OR.
- [39] J. Beal and E.A. Rauscher, "Modern Science Reads the Earth's Electromagnetic Fields," Invited paper at the University of California at Davis, Symposium co-sponsored by the Institute for the Study of Natural Systems, September 10, 1988.
- [40] C. Ramon and E.A. Rauscher, "Super-Luminal Transformations in Complex Minkowski Spaces," *Found of Physics* 10,661 (1980)
- [41] E.A. Rauscher Paper in *The Frontiers of Physics* (Iceland Conference Proceedings, Reyjavik, Iceland) B.D. Josephson and A. Puharich, Editors, *Essentia Research Associates*.
- [42] E.A. Rauscher, "Complex Coordinate Geometries in General Relativity and Electromagnetism," *Bull. Am. Phys. Soc.* 23, 84 (1978).
- [43] E.A. Rauscher, "Electromagnetic and Non-Linear Phenomena in Complex Minkowski Spaces," *Bull. Am. Phys. Soc.* 2£, 351 (1983).
- [44] Detailed analysis of a variety of wave equations with oscillatory solutions is in progress using an iterative procedure in which multi-frequency and multi-time analysis is made with the computer code CORF AC in FORTRAN IV, IBM Compatible. An update version is in progress.
- [45] E.A. Rauscher, "The Earth's Coriolis Force as an Energy Storage and Release Mechanism for Mediating Seismic Activity," ONR Grant through the University of California, Berkeley for (1) modeling systems using multidimensional geometries (2) Modeling seismic activity (1970-1974)

- [46] After we hypothesized our five-dimensional modeling a device was developed and marketed that could measure events in the time-frequency domain called the modulation domain. The Hewlett-Packard HP5371A, frequency and time interval analyzer was introduced in 1988 and is a very important instrument for analysis of seismic activity as a readout from the T-1050 Detector, as well as other uses.
- [47] E.A. Rauscher and W. Van Bise, "Relaxation of gauge invariant conditions for ELF and VLF phenomena and their implications for magnetic and electromagnetic wave transmission." Tecnic Research Laboratories Report, published in Bull Am Phys Soc. 34, p. 82,1989.

About the Authors:

Dr. Elizabeth Rauscher received her BS, MS and PhD from the University of California Berkley in Nuclear Engineering and Nuclear Science and Cosmological Models. Dr. Rauscher's main fields of research include nuclear physics, astrophysics and cosmological models, plasma physics, biomedical engineering, and geophysical monitoring. In addition to publishing over 100 papers and 4 books, Dr. Rauscher co-founded Tecnic RESEARCH Laboratories

William Van Bise is a biomedical engineer with degrees Tulane University and the Oregon Health Sciences University School of Medicine, including doctoral studies at the Oregon Graduate Center. A member of IEEE, ICWA, and AAAS, he has considerable background in biomedical instrumentation design.

(Together they hold US patents #4,724,390, #4,723,536, and #4,889,526. The first patent '390 is a non-superconducting ELF amplifier that triangulates the location of a pending earthquake, based on the well-known ELF signals that the piezoelectric rock emits while stressed, just before the impending movement we call "an earthquake." It is a masterful work that I highly recommend for those who want to learn more about the earth Schumann cavity, earthquake detection, and ELF waves, while being very readable and comprehensive. The USGS could be using the Rauscher/Van Bise invention to warn Californians, for example, before any major earthquake. Some of the patent content is discussed on p. 233-234 of this book. - Ed. note)

Elizabeth Rauscher and William Van Bise can be reached at Tecnic Research Labs, 3500 S. Tomahawk, Bldg. 188, Apache Junction, AZ 85219 and BVR@uswest.net

SECTION III

Miscellaneous Tesla Articles and Reference Material

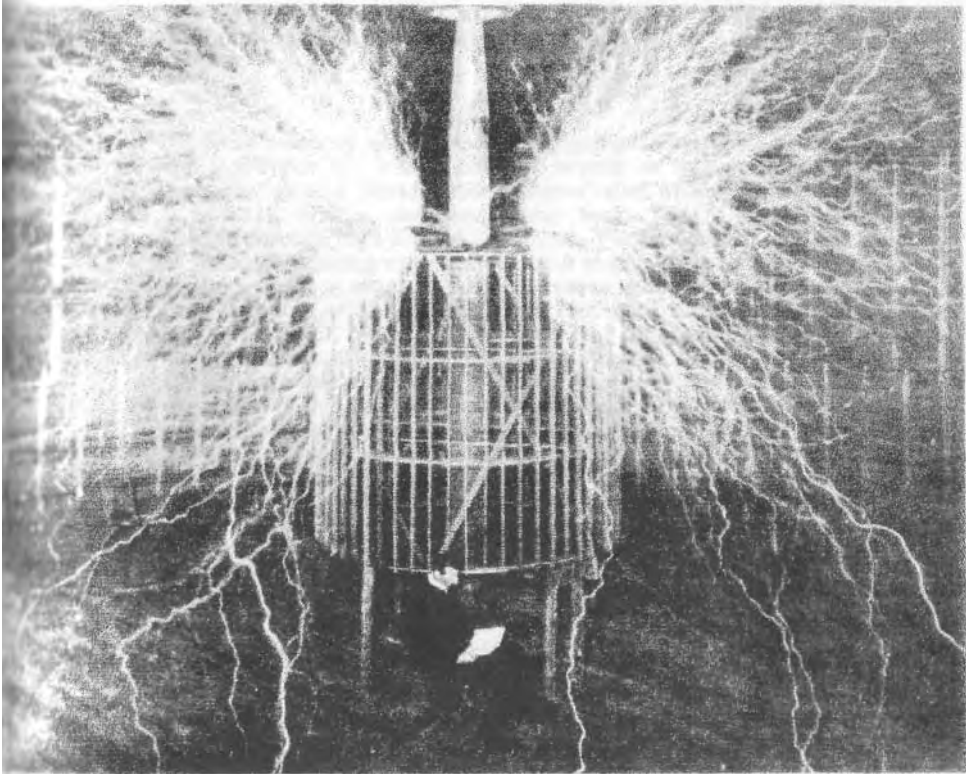

Tesla amazingly seated at the base of a huge coil in action with remarkable symmetry at Colorado Springs without any concern for the lightning he is creating. The fir tree at the top supports his antenna. "By providing a sort of roof, I get on the under side a support on which the electrical density is nothing, and then the support is absolutely safe, even in rain, because it keeps dry, and it is always in contact with a conducting surface of low electric density." — Nikola Tesla, quoted in Anderson, *Nikola Tesla on His Work with Alternating Currents*

15 The Homopolar Generator: Tesla's Contribution

Renrinted from Proceedings of the International Tesla Symposium. 1986

Thomas Valone, M.A., P.E.

"The One-Piece Faraday Generator" is now published as the book, The Homopolar Handbook. The Forbes 1888 dynamo, with like poles at each end of the rotating armature magnet and opposite pole in the center (U.S. patent #338,169), simplified current extraction in a manner similar to Tesla's two-disk concept described below. - Ed. note

Abstract

With the continued interest in Faraday or homopolar generators, it is good to review Tesla's experiments in this field. Tesla proposed several methods for increasing the output of the generator, including the "current accumulator." In this paper, the range of homopolar generators Tesla experimented, the Forbes Unipolar generator and my work on the one-piece homopolar generator will be discussed. We will look at why Tesla believed that he could build a self-sustaining dynamo.

Introduction

This paper will center on a very simple but very intriguing device that is a model of the planet earth (see Figure I). It's the unipolar, acyclic, or homopolar generator which is also referred to as a "Faraday disk dynamo" after Michael Faraday who discovered it in 1831. (Hence, the title of my book. The One-Piece Faraday Generator, available through High Energy Enterprises, PO Box 5636, Security, CO 80911) Note the self-sustaining nature of the earth model that's presented in the following Scientific American article. (For your convenience, the article, "Modeling Magnetism: The earth as a dynamo," by S. Weisburd is reprinted in full.) [Science News, V.128, p.220, 1985] They are describing an unusual mechanism of the earth which pumps current in a spiral manner strengthening the magnetic field, as described by Tesla in the following pages. (This could have great significance for a new, liquid metal Homopolar Generator if someone wants to try a novel approach. The article says, "F.H. Busse proved that by virtue of the dynamo action of the fluid motions, the magnetic field could increase substantially from a small initial value"-p.124). It appears to be a "free energy" device, with no dissipative effects, but the theory, as well as my experiment, has shown that a one-piece homopolar generator should exhibit back torque. Therefore the earth should be slowing down quite noticeably. However, it's not appreciably slowing, so there must be a method nature uses to avoid the back torque.

Modeling Magnetism: The earth as a dynamo

In 1600 William Gilbert, the physician of Queen Elizabeth I published a treatise on magnetism called *De Magnete*, in which he dispelled the notion that lodestones are attracted to heavenly bodies. Instead, he concluded from an experiment with a spherical lodestone that the earth itself is a giant magnet.

Centuries passed before scientists developed any reasonable ideas as to what causes this geomagnetism. The main, dipolar part of the earth's field clearly resembles that produced by a bar magnet. But it has become apparent that the field could not arise from permanently magnetized minerals in the earth. Most of the earth is too hot for such materials to retain their magnetism for long, and in order to create all of the changes observed in the magnetic field, solid magnets would have to scurry around within the earth--an impossible feat that would result in massive upheavals of the planet. Moreover, earthquake data indicate that the outer region of the core is a fluid.

Scientists believe this outer core is a rotating liquid made principally of molten iron and nickel, which conduct electricity. This view of the core has led to the only surviving idea out of many theories (including the notion, once considered and then dropped by Albert Einstein and others, that magnetism is an inherent property of all rotating masses).

Forty years ago Walter M. Elsasser at the University of California at San Diego and Edward C. Bullard of the University of Cambridge in England developed the "self-exciting dynamo" model for the core. The illustration below ... [Figure 1]... shows a simple example of a dynamo invented by the 19th century British scientist Michael Faraday. When the metal disk spins in the initial presence of a magnetic field, currents are generated in the disk. In a self-exciting dynamo, these currents are fed into a solenoid, or coil, which creates a magnetic field of its own.

If the spinning fluids of the earth's outer core act like the disk in the dynamo, the earth could similarly produce a large magnetic field, provided there was a small magnetic field around at the beginning. (The small field that pervades the galaxy would be a good candidate, according to some scientists.) Another provision would be that the core fluids keep moving, and the unanswered question here is what energy source is responsible for doing just that.

Of course, the actual core movements must be considerably different from and much more complex than a spinning disk. So the present focus of research is to devise complicated flow patterns consistent with the magnetic field's behavior—its reversals, secular variations and now possibly the jerk.

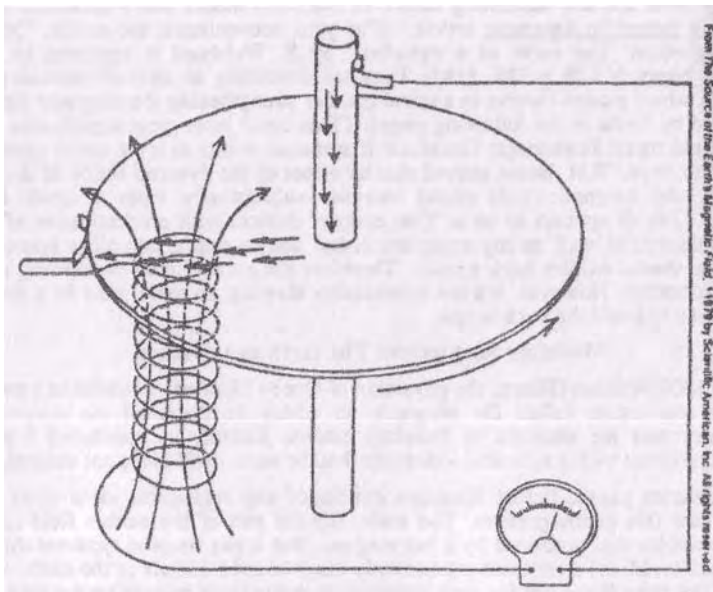

Figure 1. In this self-sustaining Faraday disk dynamo, an electric current (small arrows) in the copper disk reinforces the magnetic field of the coil (from "The Source of the Earth's Magnetic Field" by Scientific American, 1979).

Another interesting aspect of the earth as a unipolar generator (the title of another journal article) is the electromotive voltage that is produced in the rotating armature. Faraday thought it would be measurable in the rotating reference frame. He looked for a voltage in rivers and streams. My experiments with a small LED voltmeter, described in my book, show that no voltage is measurable in the rotating environment. The reason is that (see Figure 2) there is an equal and opposite electrostatic field created when a charge displacement is induced by the Lorentz force. This essentially maintains a neutral environment on the disk, even during sizable current flow, that will act as a voltage regulator. I could measure a voltage across the rotating disk in the stationary lab frame but my LED voltmeter could not measure even a millivolt when one hundred times that was present in the lab frame. In other words, we can't draw power from the earth's homopolar generator while rotating with it.

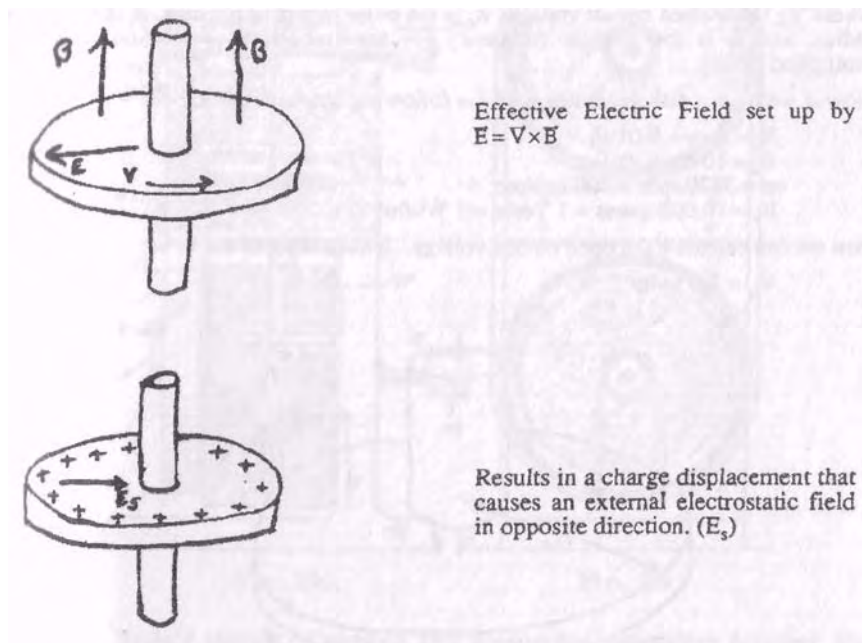

Figure 2. Charges displace until equilibrium is established. Fields cancel within a disk. This explains why a constant voltage will be maintained across the disk even during high current output.

In calculate the voltage generated with an homopolar generator (Figure 3), we find that the equation depends upon the magnetic flux density, rotational speed, and the radius of the disk squared. The internal resistance is the only thing that limits the power output of the device. It is important to note also, before going on with the aspects that relate to Tesla's article, that all of the recent experiments that have reported anomalous effects have all been done with the one-piece Faraday generator, the one with the magnet rotating with the disk. (Dr. Stephan Marinov, on p. A-73 of

my book, has a couple of published articles to this effect. Also, Dr. P. Tewari just published "Generation of Electrical Power from Absolute Vacuum by High Speed Rotation of Conducting Magnetic Cylinder" in Magnets, August 1986, p. 16, based upon his experiments, not to mention Trombly and DePalma.) We notice that the one-piece is closer the a model of the earth as well.

Calculation of the HOMOPOLAR GENERATOR Voltage

As seen in Electromechanical Devices by Woodson and Melcher, p.287 & 289, we use,

$$V_{oc} = \frac{\omega B_o}{2} (R_o^2 - R_i^2) \quad (1)$$

where V_{oc} is the open circuit voltage, R_o is the outer radius of the disk, R_i is the inner radius, and ω is the angular frequency (or the frequency of rotation in Hertz multiplied by 2π).

Now if we have a disk generator with the following characteristics:

- $R_i = 1\text{cm} = 0.01\text{ m}$
- $R_o = 10\text{ cm} = 0.1\text{ m}$
- $\omega = 3820\text{ rpm} = 400\text{ rad/sec}$
- $B_o = 10,000\text{ gauss} = 1\text{ Tesla} = 1\text{ Wb/m}^2$

then we can calculate the open circuit voltage. It should come out to be:

$$V_{oc} = 2.0\text{ volts}$$

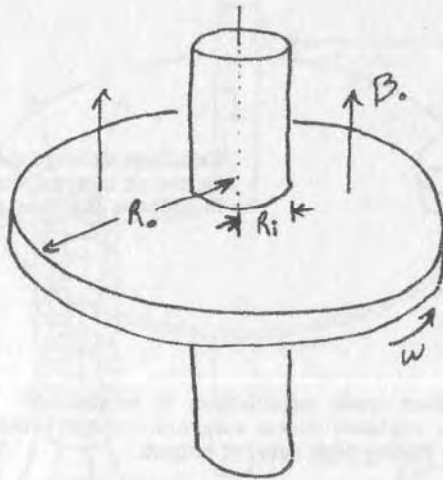

Figure 3. Calculation of the homopolar generator voltage.

Back to Nikola Tesla's article, we see that he performed a few experiments with models of the device and published the results and theory in an article entitled, "Notes on a Unipolar Dynamo" (Electrical Engineer, Sept. 2, 1891, p.258). (Note:

This article of Tesla's is reprinted in its entirety in the Appendix of my book, *The One-Piece Faraday Generator.* For your convenience, key portions are excerpted for reference throughout this paper.

The general design, shown in Figure 4, is discussed in the first portions of Tesla's article, (also reprinted in *Inventions, Researches and Writings of Nikola Tesla*, by Thomas C. Martin). "... such a machine (the homopolar generator) differs from ordinary dynamos in that there is no reaction between armature and field." It is a key sentence which Tesla qualifies by limiting the circumstance to magnets that are weakly energized.

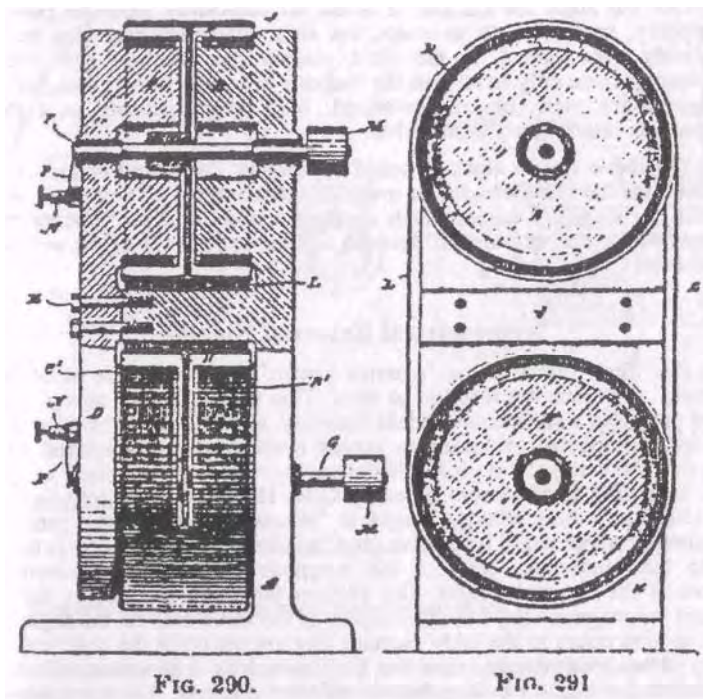

Figure 4. Tesla's Design: Coupling two homopolar generators together for higher output and better brush conductivity.

In my experimentation with strong (almost 1 Tesla field strength) ceramic magnets mounted on a copper disk, I was able to measure the reaction between the disk (armature) and field which is technically labelled "back torque" (the force which slows down the spinning disk when current is drawn from it). We can ask, "How does the one-piece homopolar generator experience back torque when there is no stator, only a rotor?" The best explanation that I could come up with when I measured it is the following: The electrons in the armature (disk) current push against the magnetic field, not the magnet, causing the reaction force. By the way, it's just the radial component of the current that contributes to the back torque, according to the traditional methods for applying the torque equation.

Tesla, however describes it as a reaction between the magnetic field set up by the armature current and the electromagnet's coil current. This is probably equivalent to the equation of torque (T) being equal to the current density crossed with the magnetic flux density ($J \times B$). He also notes another aspect of the generator that is a key to reducing back torque, the symmetry of the external circuit:

... Considered as a dynamo machine, the disc is an equally interesting object of study. In addition to its peculiarity of giving currents of one direction without the employment of commutating devices, such a machine differs from ordinary dynamos in that there is no reaction between armature and field. The armature current tends to set up a magnetization at right angles to that of the field current, but since the current is taken off uniformly from all points of the periphery, and since, to be exact, the external circuit may also be arranged perfectly symmetrical to the field magnet, no reaction can occur. This however, is true only as long as the magnets are weakly energized, for when the magnets are more or less saturated, both magnetizations at right angles seemingly interfere with each other.

For the above reason alone it would appear that the output of such a machine should, for the same weight, be much greater than that of any other machine in which the armature current tends to demagnetize the field. The extraordinary output of the Forbes unipolar dynamo and the experience of the writer confirm this view...

Symmetrical External Circuit

We note that Tesla refers to the "external circuit" which is made to be "perfectly symmetrical" to reduce the reaction to zero. This was a popular notion, which still may have profound significance. Adam Trombly, the builder of the most successful "over-unity" hornopolar generator in recent history, also emphasized to me the symmetry of the external circuit in his design in order to reduce back torque. It is believed, according to the theory noted by G.W. Howe in *The Electrician*. (Nov. 5, 1915, p. 169), and others, that the torque or "reaction" in a unipolar generator, that tends to slow down or retard its motion (and thus keep its efficiency less than 100%) is due to the interaction between the magnetic flux and the current-carrying conductors in the external circuit. Our present theory only looks at the armature current and the magnetic field but this aspect of the force may be the neglected part. The next section refers to the eddy currents that are set up in the disk with external symmetry. They tend to magnetize the field, which is a beneficial effect. A disk without external symmetry pulling current off from one spot (like my generator, to a great extent) will tend not to contribute to reinforcing the field.

It's interesting to note that Howe also published an article 37 years later entitled "A Novel Form of D.C. Motor" (*Wireless Engineer*. Nov. 1952, p.285) in which a spiral path hornopolar generator is described. It was subsequently built by Ku and Kamal a short time later (see *J. Franklin Inst.* v.258, 1954, p.7) and tested.

Tesla also notes in the next paragraph that in all other motors and generators "the armature current tends to demagnetize the field" which may be greatly reduced in his design of a unique Faraday generator.

Beneficial Eddy Currents

The next illustration (Figure 5) of a unipolar dynamo with relatively small magnets demonstrates a principle that Tesla wishes to exploit. He points out that path "n" will tend to predominate because the current will choose the path "which offers the

least opposition." He believes that the currents in such a generator tend to reinforce the magnetic field and may even "continue to flow" when the field magnet is turned off (assuming electromagnets).

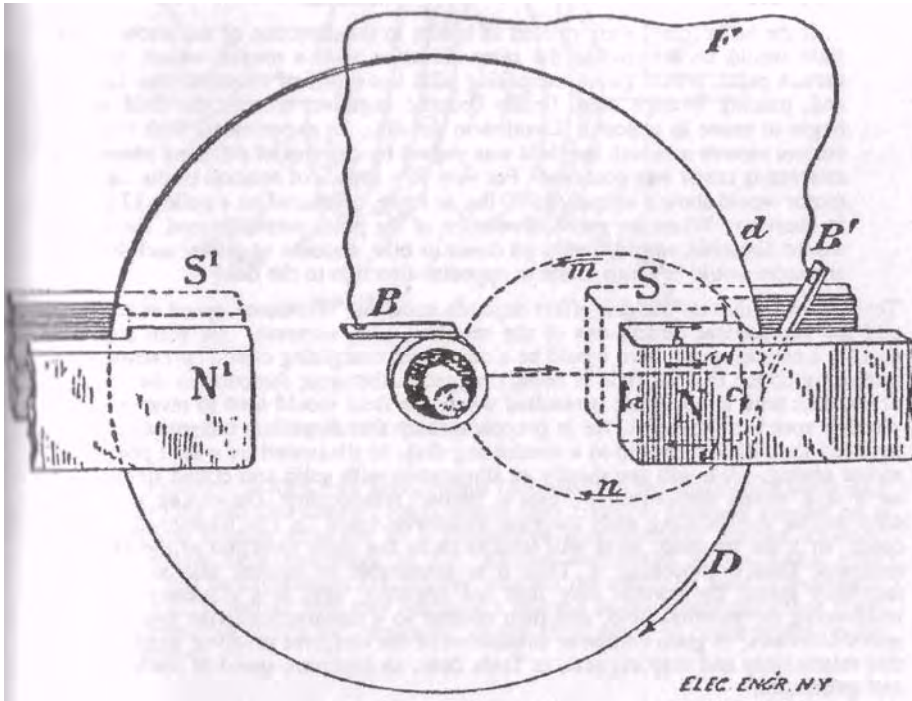

Figure 5. General schematic of a homopolar generator.

... In consequence of this there will be a constant tendency to reduce the current flow in the path A B' m B, while on the other hand no such opposition will exist in path AB'nB, and the effect of the latter branch or path will be more or less preponderating over that of the former. The joint effect of both the assumed branch currents might be represented by that of one single current of the same direction as that energizing the field. In other words, the eddy currents circulating in the disc will energize the field magnet. This is a result quite contrary to what we might be led to suppose at first, for we would naturally expect that the resulting effect of the armature currents would be such as to oppose the field current, as generally occurs when a primary and secondary conductor are placed in inductive relations to each other. But it must be remembered that this results from the peculiar disposition in this case, namely, two paths being afforded to the current, and the latter selecting that path which offers the least opposition to its flow. From this we see that the eddy currents flowing in the disc partly energize the field, and for this reason when the field current is interrupted the currents in the disc will continue to

flow , and the field magnet will lose its strength with comparative slowness and may even retain a certain strength as long as the rotation of the disc is continued...

... If the latter [disc] were rotated as before in the direction of the arrow D, the field would be dragged in the same direction with a torque, which, up to a certain point, would go on increasing with the speed of rotation, then fall off, and, passing through zero, finally become negative; that is, the field would begin to rotate in opposite direction to the disc. In experiments with alternate current motors in which the field was shifted by currents of differing phase, this interesting result was observed. For very low speeds of rotation of the field the motor would show a torque of 900 lbs, or more, measured on a pulley 12 inches in diameter. When the speed of rotation of the poles was increased, the torque would diminish, would finally go down to zero, become negative, and then the armature would begin to rotate in opposite direction to the field.

Tesla notes further on that this effect depends upon the "resistance, speed of rotation, and the geometrical dimensions of the resulting eddy currents," He then suggests that "at a certain speed there would be a maximum energizing effect," presenting the intriguing notion that the field is being dragged in the same direction as the rotation of the disk until a maximum is reached where the field would tend to reverse as the rotation speed is increased. He is proposing here that there is a phase relationship between the field concentric to a conducting disk, as illustrated by a split phase AC motor analogy. We will see shortly an illustration with solid and dotted spiral lines on a disk which demonstrates Tesla's "phase" relationship. Depending upon the direction of the spiraling eddy currents, clockwise (path "n") or counter-clockwise (path "m"), the magnetic field will tend to be in the same direction as the external magnetic field or opposing it. Thus it is reasonable to assume that as the disk increases speed, the current may start out spiraling, say, in a clockwise manner reinforcing the external field, and then reverse to a counterclockwise spiral as the speed increases. A good computer simulation of the variables involved would reveal this relationship and may suggest, as Tesla does, an optimum speed of operation for self-generation.

Another article that reinforces Tesla's ideas is "A Laboratory Self-Exciting Dynamo" by Lowes and Wilkinson, reprinted in *Magnetism and the Cosmos*, in 1965, by NATO Advanced Study Institute on Planetary and Stellar Magnetism in the Departments of Physics and Mathematics at the University of Newcastle upon Tyne. On page 124, they mention that "a more efficient geometry was found, so efficient that the dynamo would self-excite in a completely homogeneous state (i.e. with no insulation) at a much lower rotor speed than was believed possible." Their design is based upon conducting spheres or cylinders rotating like eddy currents in a conducting medium (also see page 126 of *Sci, Amer.*, "The Source of the Earth's Magnetic Field," 1979).

My Experiment With Field Rotation

I'd like to mention that I have tried the experiment of rotating an 8" disk magnet on a non-conductive (wood) disk within one centimeter of a copper disk (and vice versa), along with the help of Dan Winter in Buffalo, NY (see Figure 6). We were unable to find an effect of rotating a symmetric magnetic field on the output voltage though we didn't look at the output current which is what Dr. Tesla is referring to.

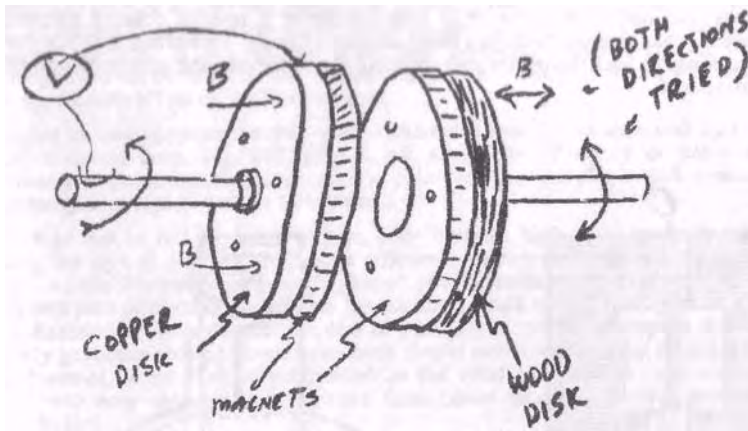

Figure 6. Dragged rotating field experiment.

Here, it is important to also note experiments (described in my book) by Cramp and Norgrove (1936) and Das Gupta (1963) which have failed to find any torques on a non-conductive magnet adjacent to a conductive disk carrying current. In fact, several scientists have proposed, as Mr. Klicker mentioned at the Tesla 1986 Conference, that no experiment can resolve whether the magnetic field is rotating if it is symmetric. However, this may not have a bearing on the phenomena that Tesla is talking about concerning the "dragging" of the field, since he concentrates on the spiraling currents.

Removing The External Magnetic Field

The next part of Dr. Tesla's article proposes that in a solid disk, as described above, we may be able to find that the field magnet may be removed while the generator disk is kept rotating. Tesla suggests that, due to favorable eddy currents, the entire generator may continue to function and even increase in output when the speed is increased, forming a fascinating "current accumulator."

To return to the principal subject; assume the conditions to be such that the eddy currents generated by the rotation of the disc strengthen the field, and suppose the latter gradually removed while the disc is kept rotating at an increased rate. The current, once started, may then be sufficient to maintain itself and even increase in strength, and then we have the case of Sir William Thomson's "current accumulator." But from the above considerations it would seem that for the success of the experiment the employment of a disc not subdivided would be essential, for if there should be a radial subdivision, the eddy currents could not form and the self-exciting action would cease. If such a radially subdivided disc were used it would be necessary to connect the spokes by a conducting rim or in any proper manner so as to form a symmetrical system of closed circuits ...

In the next illustration (Figure 7), we see a suggestion for giving the disk, an additional push from the generated currents by leading them through conductors that pass into coils. Here, the coils then encounter a reverse polarity magnetic field which tends to give the coils a small amount of push. This effect may not work at all but tends to lead the reader into thinking about curving the generated currents to an advantage.

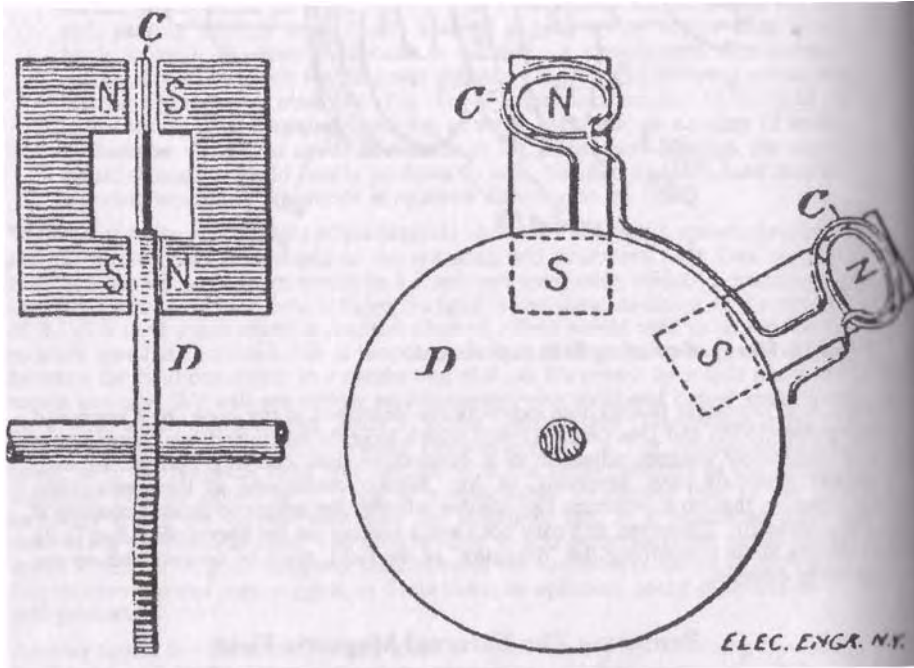

Figure 7. Possible enhancement to give discs an additional "push."

Sub-Dividing The Disk

The suggestion of sub-dividing the disk is now discussed, in order to "do away with the field coils" entirely! As illustrated in Figure 8, sub-dividing the disk spirally (actually cutting the disk in radial directions that spiral outward) tends to create a self-generated magnetic field.

... But a unipolar dynamo or motor, such as shown in Fig 292, may be excited in an efficient manner by simply properly subdividing the disc or cylinder in which the currents are set up, and it is practicable to do away with the field coils which are usually employed. Such a plan is illustrated in Fig. 295. The disc or cylinder D is supposed to be arranged to rotate between the two poles N and S of a magnet, which completely cover it on both sides, the contours of the disc and poles being represented by the circles d and d' respectively, the upper pole being omitted for the sake of clearness. The cores of the magnet are

supposed to be hollow, the shaft C of the disc passing through them. If the unmarked pole be below, and the disc be rotated screw fashion, the current will be, as before, from the centre to the periphery and may be taken off by suitable sliding contacts, B B', on the shaft and periphery respectively. In this arrangement the current flowing through the disc and external circuit will have no appreciable effect on the field magnet.

But let us now suppose the disc to be subdivided spirally, as indicated by the full or dotted lines, Fig. 295. [Fig 8; ed. note] The difference of potential between a point on the shaft and a point on the periphery will remain unchanged, in sign as well as in amount...

We note here that in AC induction motors, eddy currents have to be controlled by laminating the core to obtain a reasonable efficiency, which demonstrates the same principle. As the illustration shows, the dotted path of radial current generation is the preferred path of current that suffers the standard "back torque" and goes in the opposite direction to the rotation of the disk in a usually successful attempt to slow it down. (My generator slowed down from hack torque rather well, to my disappointment.) However, if the disk is subdivided in the solid line manner, the current generated will now enhance the magnetic field (since rotating currents generate magnetic fields).

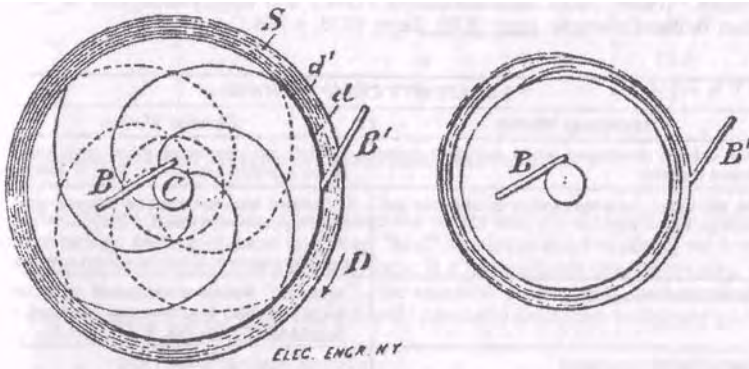

Figure 8. Spiral Disc Detailed.

At this point I would like to propose that the etched disk for sale by Borderland Research Foundation, in the pattern of a golden mean spiral, may be an interesting unipolar generator for the Tesla experiment proposed.

Of course, as Figure 8 shows, we may use an external spiral or coil encircling the disk to obtain a similar effect. Note the similarity between this drawing and the first one (from Scientific American) which is a model for the earth's core.

Forbes Dynamo

The Forbes dynamo is now discussed, from Figure 4, which seems to be simply a very efficient homopolar generator modified with two disks for higher voltage. For that example, Tesla proposes using the external coil but also a conductive belt, in

what turns out to be a very innovative idea for increasing conductivity and decreasing resistance of the dynamo. The current is thus extracted only from the shafts of both generators.

... Instead of subdividing the disc or cylinder spirally, as indicated in Fig. 295, it is more convenient to interpose one or more turns between the disc and the contact ring on the periphery, as illustrated in Fig. 296. [Fig 8; ed. note]

A Forbes dynamo may, for instance, be excited in such a manner. In the experience of the writer it has been found that instead of taking the current from two such discs by sliding contacts, as usual, a flexible conducting belt may be employed to advantage. The discs are in such case provided with large flanges, affording a very great contact surface. The belt should be made to bear on the flanges with spring pressure to take up the expansion. Several machines with belt contact were constructed by the writer two years ago, and worked satisfactorily; but for want of time the work in that direction has been temporarily suspended. A number of features pointed out above have also been used by the writer in connection with some types of alternating current motors.

Noting that his work on these generators has been suspended in the recent past, Tesla abruptly ends a most entertaining article unequalled in all of the homopolar literature. [Note: More information on Forbes and his dynamo can be found in Robert Belfield's article, Jour. IEEE, Sept. 1976, p.344.]

RELATIVITY COMPARISONS	
Rectilinear Motion	Circular Motion
- No voltage developed when bar and meter move together	- Voltage not developed when disk and meter move together, but electric field is generated
- No difference between motion of observer and charge: $M_1 = V \times P_1$	- Difference between rotating charged sphere or rotating observer (Schiff, 1939) B Field vs. no field - Ring currents developed causing magnetic field for sphere rotation
- No absolute motion detectable	- Absolute Rotation measured (wrt inertial frame) Sagnac, Marinov; see Marinov, <i>Foundations of Physics</i> Vol. 8, 1978 p.137
- Special Relativity applies	- Special relativity doesn't apply
- No volume charge by special relativity transformation laws	- Volume charge: $E = V \times B$ $D = \epsilon_0 E_{\text{total}}$ $\rho = \nabla \cdot D$ $\rho = -2\epsilon_0 \omega B$
- No forces for uniform, constant velocity	- Centrifugal and coriolis forces generated

Relative Motion

In order to help some researchers distinguish between what they believe is true for the linear motion and what really happens on a rotating disk, I have included a couple of charts, not published previously. In Figure 9, we see the left hand column contains some major aspects of rectilinear motion taken from a classical physics text. On the right is my rotational analog to each of the same experiments, i.e., rotate the magnet (+) but not the meter (-) nor the disk(-), etc. Notice that the results are the same whether we rotate the magnet or not (to the best of our knowledge).

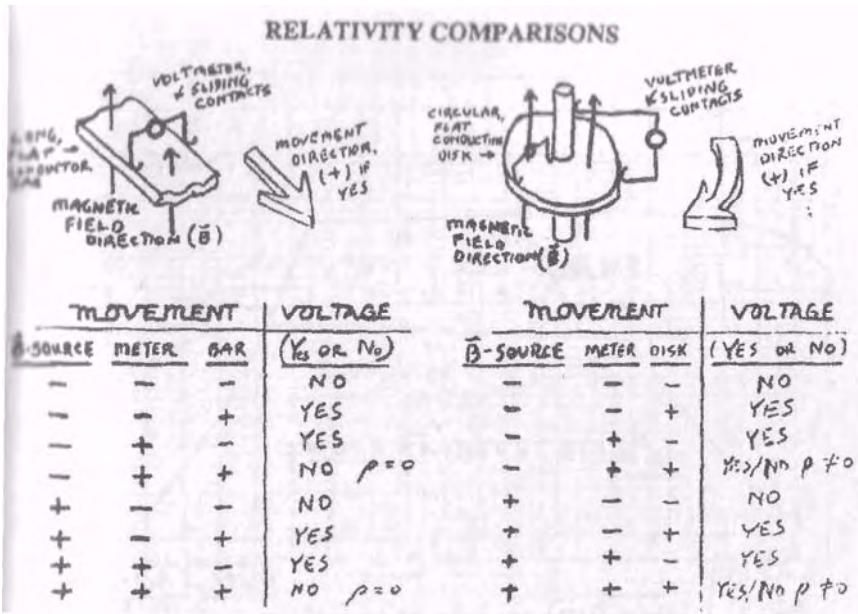

Figure 9. Comparison between linear and rotational motion.

The only debatable part comes when we rotate the meter and the disk with or without the magnet rotating. Here if we ask about an "emf" or electromotive force, we know that here is one present (yes), or if we ask if there is a nonuniform charge density, we answer yes, but if we ask about "voltage", the reaction of a meter, in the rotating frame, we have to answer no. (I placed a small, specially designed voltmeter on the disc to test this unusual effect.)

The Relativity Comparison Table is a comparison between linear and circular motion in a more theoretical fashion. Notice the many differences present for any rotating object.

My \$1000 Homopolar Generator

When I came back, from California in 1980, after a trip exploring the \$25,000 generator that Bruce DePalma had built at the Sunburst Community (now called The Builders); I was determined to build one myself. This evolved into a Master's Degree project for the Physics Department at Buffalo's State University. Thanks to Erie Community College, I was able to test it at the school, in one of the labs.

In Figure 10, we see the results of a typical run. At the top, the trial was performed with the circuit closed, generating about 380 Amps and the DC motor demanding 266 Watts. Note the slowdown time here was about 0.57 minutes. Next, at the bottom, we see the test run with the circuit open, generating just voltage. Here the motor demand lessened to 249 Watts. Note the slowdown time is now longer (0.64 minutes) showing less "resistance" with the lack of back torque. The last verification of this analysis is the comparison of generated power (about 25 Watts) and the difference in the motor demand (about 17 Watts in this case). They are about the same.

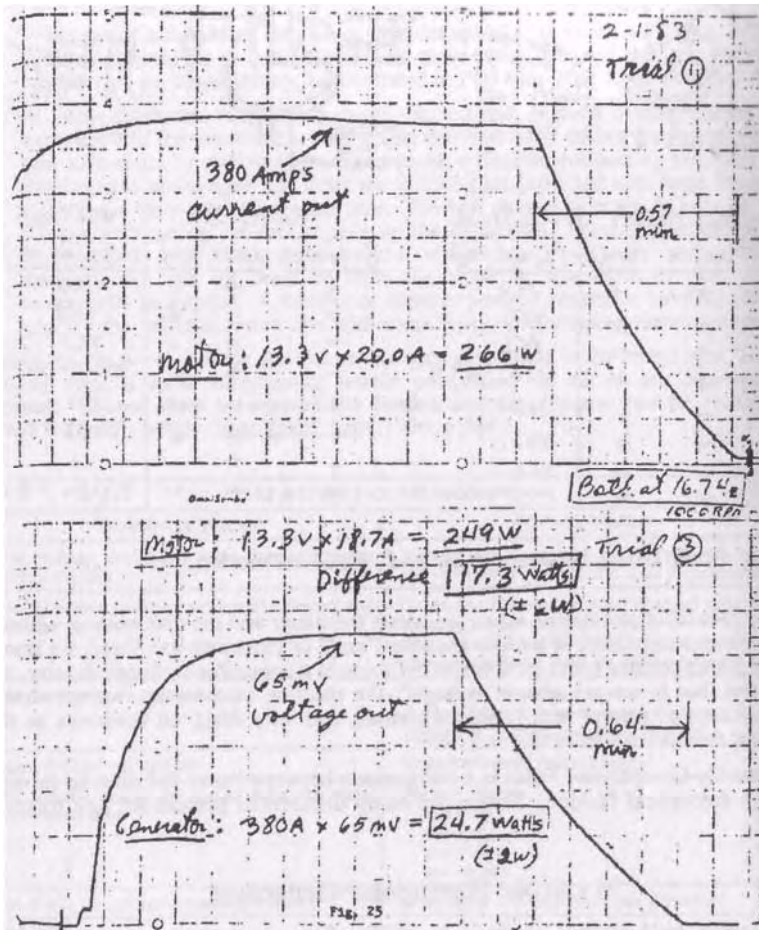

Figure 10. Current run charts for the \$1000 generator.

In Figure 11, we see the results of another trial. Here the generated power and the difference in the motor demand was even closer ~ less than 1 Watt between them. Quantitatively and qualitatively we see evidence for the existence of back torque in a one-piece Faraday generator. The output of the generator tended to be compensated by the increase in the motor demand for power from the batteries.

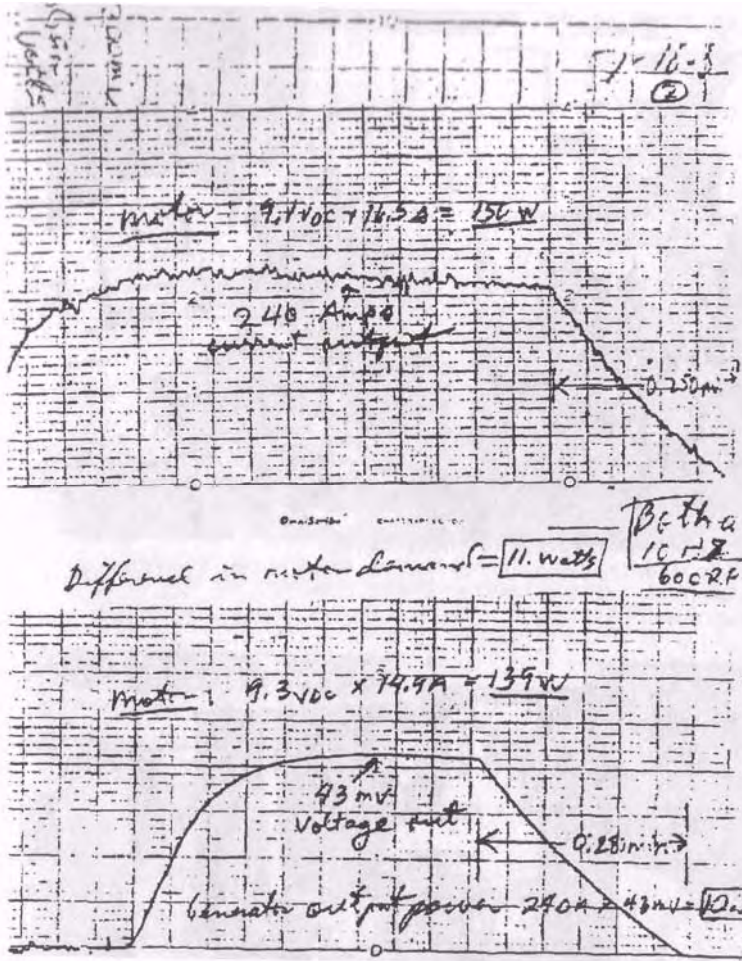

Figure 11. Additional run charts.

We know that a decrease in resistance of the system, from 1 milliohm down to about 1 microhm (recommended by Adam Trombly) would improve the performance. Also some of the design ideas of Tesla's would also contribute to a more self-sustaining generator.

The last few figures show various pictures of my generator. They are the best photos of my large generator with 8" ceramic magnets. For more information, including a complete copy of the Trombly-Kahn patent application, I would recommend my book. The One-Piece Faraday Generator.

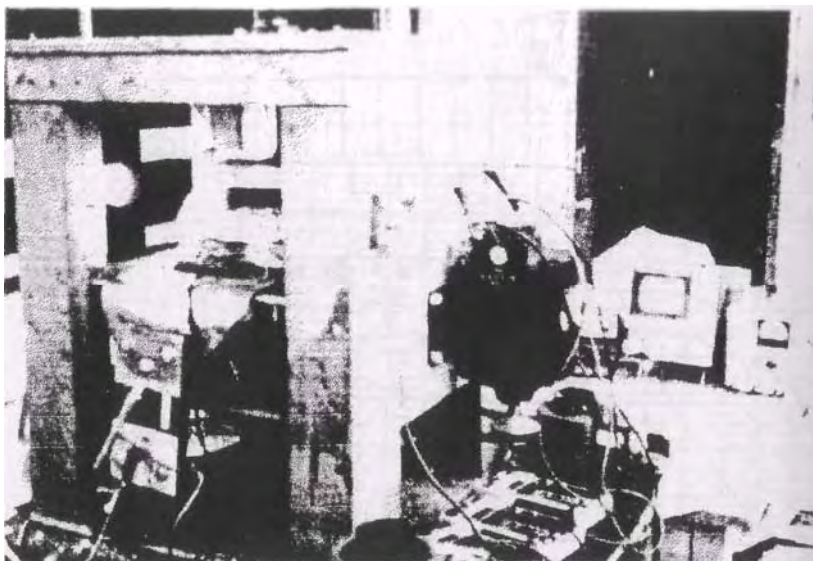

Figure 12. Homopolar generator - nonrotating.
Background: Digital Frequency Counter, Oscilloscope, Power Supply for Circuit
Foreground: DC Motor, 2 Variacs for Heaters, 3 Digital Voltmeters.



Figure 13. Homopolar generator - front view exposing the General Electric 2500 Ampere 50 millivolt current shunt.

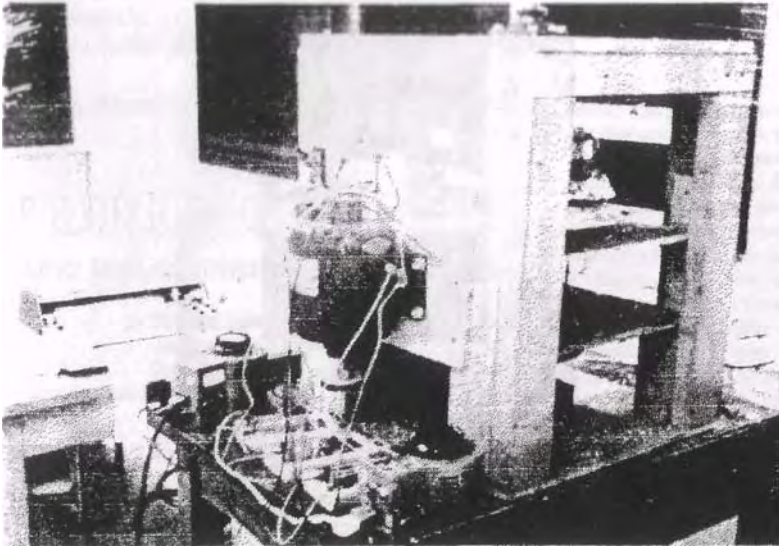

Figure 14. Homopolar generator with strip chart recorder shown on left.

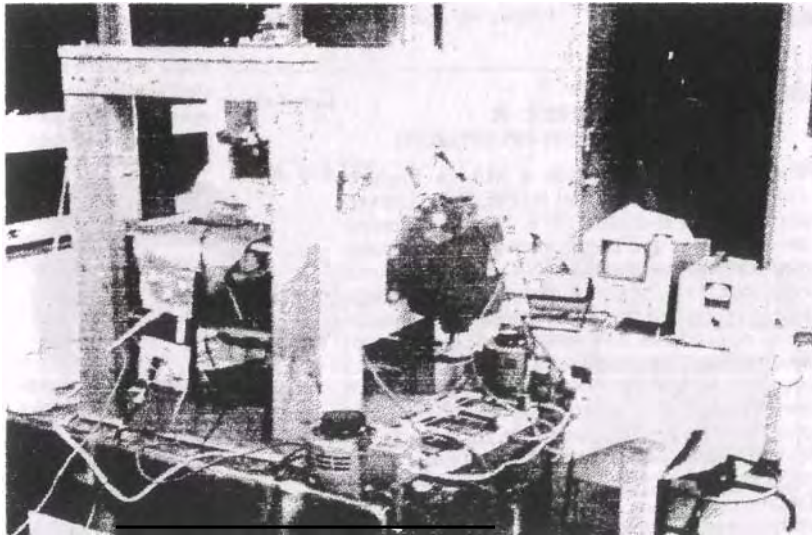

Figure 15. Homopolar generator - rotating.
Square wave on Oscilloscope is the photocell circuit output.

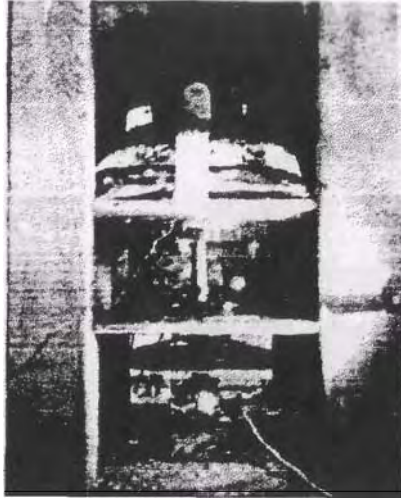
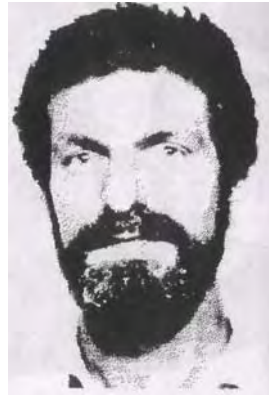

Figure 16. Homopolar generator - Metal arm at top holds photocell close to rotating magnet assembly. A strip of aluminum foil has been attached at the top of the magnets, covering half of the circumference for reflection of light into photocell.

About The Author:

Thomas F. Valone holds a MA in Physics, 1984; a BS in Physics and BSEB, State University of NY at Buffalo, 1974. Tom is a Professor of Physics and Electronics at Erie Community College in Buffalo, NY, a Professional Engineer, and President of his own company, Integrity Electronics & Research. His company is engaged in computer sales and specialized instrument manufacture. Tom has been involved in non-conventional energy research for the past ten years. He established his prominence in this field by beginning an investigation into a non-conventional energy generator in 1979, as part of a Master's Degree program at the State University

This information and picture was accurate back in 1986. The author can be reached at iri@erols.com and www.integrityresearchinstitute.org



16 Tesla's Ionizer and Ozonator

Thomas Valone

Reprinted from *Tesla: A Journal of Modern Science*, 1997

AIR PURIFICATION

USING TESLA'S IONIZER AND OZONATOR

by Thomas Valone, M.A., P.E.
Professional Engineer
Retired College Teacher

OVERVIEW

Indoor and outdoor air quality has deteriorated due to airtight homes, more artificial materials and excessive air particulates in every major city. Oxygenating and ionizing the air has been shown to be a superior technique for purification, even surpassing the best air filtration methods. Nikola Tesla's patent on a method for generating ozone was issued in 1896. With a better invention than one would believe, we acknowledge Tesla for inventing the medically-approved method for producing ozone during its centennial. His method has been incorporated into Alpine air purifiers along with a mysterious invention of Dr. Pat Flanagan's that produces ionization at a distance. The merging of ion and ozone production in one machine, both based on Tesla technology, is a remarkable outgrowth of two separate inventions.

TESLA'S OZONE PATENT

At the turn of the century, there was a great deal of high voltage in Tesla's laboratory, as is seen in several photographs of Tesla seated in the midst of high voltage discharge which

generated a good amount of ozone. Tesla was exposed to ozone ("triatomic oxygen") for years throughout his work.

The circuit that Tesla used to produce ozone is very simple. The diagram (from Tesla's 1896 patent #568,177) in Fig. 1 shows two parallel plates connected to a high voltage transformer, along with a fan to move the air through the parallel

plates. The patent examiner reviewing this case cited three patents for synthesis of ozone to purify liquids from as early as 1882. It is worth noting that ozone was discovered in 1785 by Van Marum who passed air through an electric discharge.

Since 1896, three classes of ozone generators have become available: electric spark discharge; ultraviolet (UV) light; and "cold plasma discharge." As noted in *Explore More!* (No. 7, 1994, p.30) only the cold plasma discharge method (which is the technical name for Tesla's invention) produces the purest ozone, with virtually no nitrogen oxides, and "is the type used by German medical doctors and health clinics worldwide for the treatment of disease."

OZONE/OXYGEN THERAPY

The book *Oxygen Therapies* by

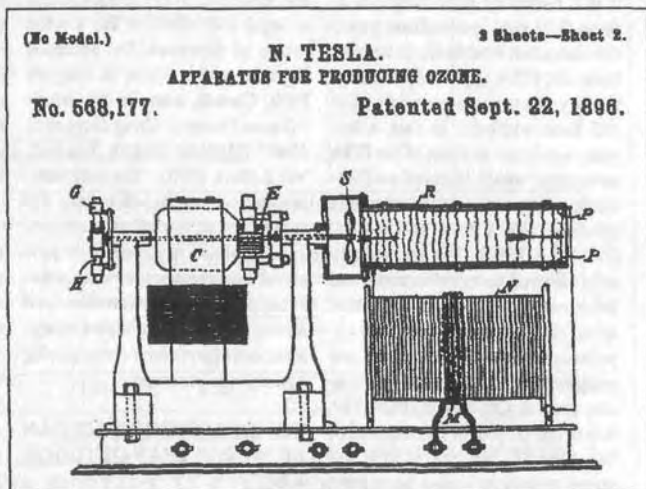

Fig. 1 - Tesla's Original Patent Application for the Ozone Machine

Ed McCabe (available from [The Tesla Resource Center](#)) is an excellent review on the subject. Journal articles such as "Ozone Selectively Inhibits Growth of Human Cancer Cells" (Sweet et al., Science, Vol. 209, 1980, p.931) and "Do Oxygen Therapies Work?" (East West Jour., Sept. 1989, p.70) have attracted much attention to the therapeutic effects of ozone, even for blood dialysis treatment of AIDS (more information available on the Internet). Dr. Andrija Puharich (a speaker at the 1984 ITS Symposium) presented a paper at the Sixth World Ozone Conference in 1983 on the successful treatment of neoplasms (cancer) with ozone. He stated, "if gaseous ozone is administered directly into cancerous tissue in mice, the tumor would dissolve in a matter of seconds to minutes leaving the surrounding tissue unaffected."

Unfortunately, the FDA has classified ozone as a drug, even though it is a naturally occurring gas at about 0.03 parts-per-million (ppm) concentration worldwide in country fresh air. FDA approval for ozone therapy as a treatment modality has still been withheld. In fact, a few years ago I saw an issue of the FDA newsletter which featured an illustrated cover story about an ozone machine which they had seized. (DISCLAIMER: We are legally only allowed to mention anecdotal information and emphasize that ozone can be used only on an experimental basis, without recommending or prescribing.) Companies such as OZ-TECH (POB 730, Alton, NH 03809) or Excalibur (314 W. 53rd St., NY, NY 10019) sell water treatment ozone generators which some people have configured

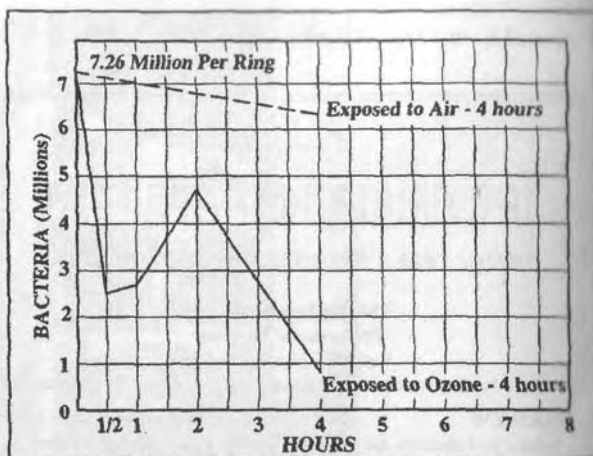

Fig. 2. - STAPHYLOCOCCUS AUREUS

for rectal insufflation or body bag exposure for skin absorption. The Bradford Institute (800-227-4473) is a good source of quality information on ozone therapy, operating their own hospital in Mexico, where it is legal. Canada and Europe are also countries where ozone therapy is legal and effective for a wide range of diseases. Dr. Michael Prytulfa, with a clinic in Niagara Falls, Canada, states in his article "Ozone Therapy: Using Oxygen to Heal" (*Holistic Health Journal*, Vol.2, No.4, 1995), "The only problem ozone has in being fully accepted is that, like all naturally occurring products; it cannot be patented. Imagine how the manufacturers of pharmaceutical products and manufacturers of radiation equipment would feel about ozone getting equal press coverage."

EPA FINDS INDOOR AIR CAN BE WORSE THAN OUTDOOR AIR

Nature only produces ozone with

thunderstorms and alternatively with sunlight. Indoor air, however, contains no ozone whatsoever. Laboratory tests have shown (Fig. 2) that only 0.05 ppm of ozone will kill mold, E. coli, salmonella, and staph germs in 4 to 6 hours. At the same time, trace amounts of ozone (0.01 to 0.03 ppm) reduce odors, and increase oxygen absorption by hemoglobin. Consequently, the use of ozone generators in homes, offices, beauty parlors, hotels, and even in the President's limousine, is becoming more popular.

Since the average person spends over 90% of their time indoors, he/she should be treating the problem more seriously. In 1987, an EPA report ranked indoor pollution at the top of the list of environmental risks that Americans face. In one of the most exhaustive studies ever, the EPA fitted 800 people around the country with battery-operated sensors, in 1980, to measure levels of 20 chemicals in the air around them. In a few cities, the lev-

its of 11 of those chemicals were higher in the family den (up to 70 times higher!) than were found outside the huge petrochemical plants and refineries nearby.

Indoor air is filled with pollutants such as benzene, carbon monoxide, sulfur dioxide, trichlorethylene, carbon tetrachloride, mold spores, pollens, fungi, etc. However, during the energy crisis a few decades ago, we started to build houses and office buildings that are airtight. Airtight buildings do not breathe and must rely upon a certain number of air exchanges per day. It is distressing to note that most hotels are not designed for any air exchange or circulation at all! Further compounding the problem is the finding reported in Science

News (March 27, 1993) for sick buildings, labeled "*The Ventilation Conundrum*." In a double-blind study which doubled the flow of outdoor air, from 30 to 64 cubic feet per minute (cfm), into a building already reporting complaints of "sick building syndrome", there was no decrease in worker symptoms. The concentration of volatile chemicals had decreased but the workers "perceived absolutely no difference."

Clothing, furnishings, construction products, paint, plywood, and particle board all "outgas" chemicals. Also, heating and cooling systems "can grow microbial products such as bacteria, fungi, and protozoa" (Indoor Air Review, Oct., 1992, p. 11). These colonies

of microbes grow more often in the ventilation systems or air ducts which return air to the furnace, because they are not subject to filtering until just before the furnace.

"DIRTY AIR CAN SHORTEN YOUR LIFE," STUDY SAYS

A front page article from the Washington Post (Mar. 10, 1995, p. 1) used the above title for the largest study ever conducted on the health effects of airborne particles which found that people in the nation's most polluted cities are 15 to 17 percent more likely to die prematurely than those in cities with the cleanest air, like Topeka, Kansas, thus losing approximately one year of life expectancy. The study cited particles 2.5 microns (millionths of

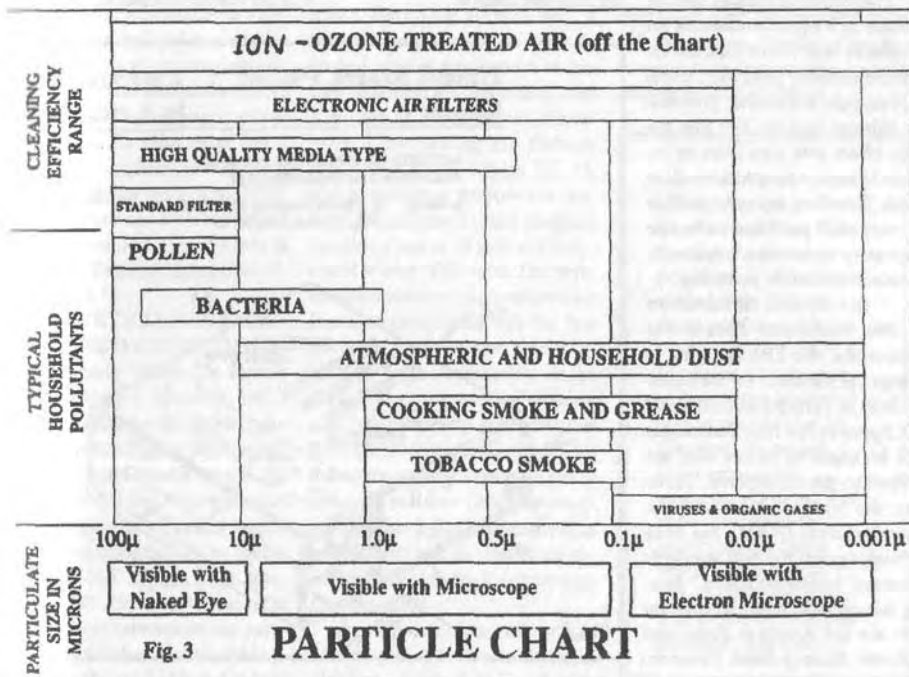
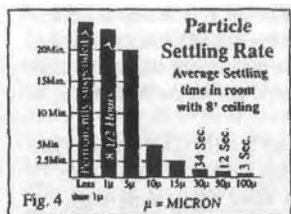

Fig. 3



a meter) and smaller as the culprits, because they stick in the deep recesses of the lungs and limit oxygen exchange.

In July, 1995, *Science News* (Vol. 148, p.5) reported that "a spate of studies show that daily hospital admissions and deaths from respiratory disease tend to fluctuate nearly lockstep with variations in airborne dust—even when particulate levels fall within federal limits." Their findings indicate that the increase in hospital admissions for congestive heart failure matched the increase in small particulate levels of 10 microns and smaller. A revealing sideline was the fact that the same effect was seen from an increase in carbon monoxide levels in the air. Therefore, it may be possible that very small particulates affect the respiratory system in a way similar to carbon monoxide poisoning.

In a report in the November 1, 1996 *Washington Post*, it was written that the EPA is trying to change the standards for the industry from 10 Parts per Million (ppm) to 2.5 ppm so that finer particulates will be captured before they are emitted to the atmosphere. However, the National Association of Manufacturers (NAM) has been fighting against the new standards to control "particulate matter." Joining this opposition to tighten controls are the American Petroleum Institute, Geneva Steel, Chevron,

DuPont, Xerox, American Automobile Manufacturers Association and others.

What are these particles and how do they affect us indoors? Most studies, including those from local environmental testing firms, confirm that indoor air can be more polluted than outdoor air. One report, from the testing of the Takoma Park Library (in Maryland) by Aerosol Monitoring & Analysis, Inc., found on the average, 7000 to 10,000 particles per cubic centimeter (cc) throughout the library. Our nose and lungs have to process all of these particles which can consist of dead skin, bacteria, pollen, dander, dust mite droppings, viruses, etc. The lungs and the cilia of the cells can expel particles that are bigger than one micron.

Many people rely upon air filtration, and even high efficiency "HEPA" filters, to grab those nasty particles. However, the best filters will only arrest particles that are bigger than one micron, with varying retention rates. Clients inform me that even with the best electronic or electrostatic filters on their furnaces, they find very fine dust on everything. In Fig. 3, we notice that most dust particle concentration is in the sub-micron (below one micron) range, where the majority of the 7000 to 10,000 particles per cc reside. *Consumers Digest* (Oct. 1992, p.40) reports that "sunbeams in a home wouldn't be visible if it weren't for the suspended airborne particles that scatter the light in the beam's path." In Fig. 4, we see that it is the sub-micron particles which

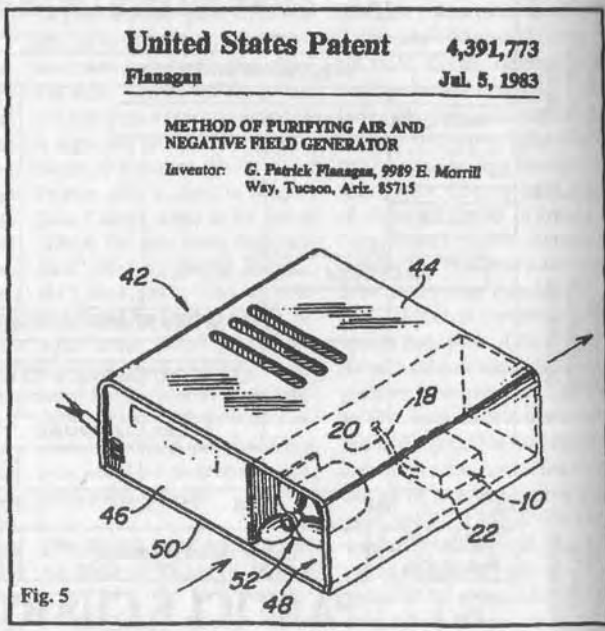

are permanently suspended in the air, mostly from the "Brownian motion" of such microscopic particles.

IONIZATION SOLVES SUB-MICRON PROBLEM

Ironically, it is the smallest particles which can be ionized most easily. They quickly move under the influence of an electric field set up by an ionizer. Ions (from the Greek for "traveler") are electrically charged air molecules that have gained or lost an electron. **The Ion Effect by Fred Soyka** (Ballantine Books, 1991) is the only book that I am aware of on the subject of ions and health. It describes the medical experiments that have successfully treated a variety of respiratory diseases, mostly with negative ions. Negative ions tend to lower serotonin in the brain, making people more alert. Russian studies have indicated that "atmospheric ozone and ions are the vehicles of freshness." The results of two Russian doctors (**Priroda**, No.9, p.26, 1976) testing indoor air with only 0.02 ppm of ozone and negative ions is reported in **Explore More!** (No. 16, 1996, p.21).*

THE MYSTERIOUS ELECTRON FIELD GENERATOR

In the early 1980's, Dr. Patrick Flanagan made a discovery with a Tesla coil and a few dielectrics, producing an ionization field which even affected adjacent rooms. He states, "I found that electrons could be released from electrical insulators and semiconductors by means of a Tesla coil" (**Acres USA**, Mar., 1992, p.20). Shortly afterwards, he found how to miniaturize the package, using a flyback transformer operating at about 35 kHz and at least

5000 volts (see Fig. 5). When I spoke to him at that time, he described his laboratory electrometer which pegged at its limit, far from the device, when he reached the right parameters for the circuit. Tests revealed that the electron field released foam from the walls of pillow factories, in most of the rooms in the building. Dr. Flanagan received two patents on the device (#4,391,773 and #4,743,275) and markets the machine as model ECP-1000 (Vortex Indus., 1109 S. Plaza Way #399, Flagstaff, AZ 86001).

By the mid-1980's Mr. Bill Converse was given the opportunity to test Dr. Flanagan's device and formed his own company shortly thereafter to market a very similar machine with an added ozone generator. Surviving a court test of patent infringement, Mr. Converse formed what is now known as Alpine Industries and has sold almost 1 million of the machines worldwide. Upon testing the flyback transformer in the Alpine XL-15, which includes a "radio-wave ionizer," I found that its peak resonant frequency was at 35 kHz and it operated at over 5000 volts. The mysterious ceramic or dielectric which Flanagan determined was the "radiator" of the ionization field, may actually be the removable ozone plate. The Alpine machine's ionization field, reaching out to 60 feet from the machine, does seem to reduce airborne dust. Tests with black-mirrored surfaces (daily dusting), halogen flashlights (sunbeam effect test at night) and air vent tissue paper (dust collection) all seem to confirm the effect.

Alpine's Model 880 or XL-15 incorporate Tesla's cold plasma discharge method for producing

ozone and the Tesla/Flanagan method for producing ionization at a distance. While I find it gratifying that such Tesla technology has penetrated the market so successfully, it would be great if acknowledgment were given to Tesla and Flanagan in Alpine's sales literature.

*A free ion/ozone booklet and a copy of "Fresh Air Curative Effect Related to Ions and Traces of Ozone" from **Explore More!** is available from the author by calling 800-295-7674.

This article is an abridged version of the presentation at the 1996 International Tesla Society Symposium entitled, "Tesla's Contribution to Indoor Air Purification." The complete transcript will be available in the 1996 Proceedings of the ITS Symposium. A video of the lecture and slide presentation is available from ITS for \$29.95.

Ed. note: Alpine is now called "EcoQuest International" but still has Bill Converse as president. He has never settled with Pat Flanagan for making millions with Patrick's invention. It may also be true that a lawsuit was never initiated by Flanagan for patent infringement but certainly could be. The video presentation shows the spectrum graph of the Alpine transformer and is also distributed by Integrity Research Institute.

19 Bibliography of Tesla Resources

Wizard: The Life and Times of Nikola Tesla
Dr. Marc Siefer

Lightning in His Hand: The Life Story of Nikola Tesla
Inez Hunt & W. Draper

My Inventions : The Autobiography of Nikola Tesla
Nikola Tesla; Ben Johnston, Editor

Tesla
Tad Wise

Inventions, Researches and Writings of Nikola Tesla (hardcover)
Nikola Tesla; Thomas Commerford Martin, Editor

Nikola Tesla: Lecture Before The New York Academy of Sciences, April 6, 1897
Tesla Presents Series Part 2
Nikola Tesla; Leland I. Anderson, Editor

High Frequency Oscillators for Electro-therapeutic and Other Purposes
Nikola Tesla

Nikola Tesla On His Work With Alternating Currents and Their Application to Wireless
Telegraphy, Telephony, and Transmission of Power
Tesla Presents Series Part 1
Nikola Tesla; Leland I. Anderson, Editor

Nikola Tesla: Guided Weapons & Computer Technology (hardcover & paperback)
Tesla Presents Series Part 3
Nikola Tesla; Leland I. Anderson, Editor

Nikola Tesla's Teleforce & Telegeodynamics Proposals
Limited Edition
Tesla Presents Series Part 4

Nikola Tesla; Leland I. Anderson Editor

Colorado Springs Notes, 1899-1900 (hardcover)
Nikola Tesla; Commentary by Aleksandar Marincic

Dr. Nikola Tesla - Complete Patents
Nikola Tesla; Compiled by John T. Ratzlaff

Dr. Nikola Tesla - Selected Patent Wrappers, 4 volume set (spiral)
Nikola Tesla; Compiled by John T. Ratzlaff

Tesla Said
Nikola Tesla; Compiled by John T. Ratzlaff

Solutions to Tesla's Secrets
Nikola Tesla; Compiled by John T. Ratzlaff
Thomas Bearden

The Transmission of Electric Energy Without Wires
Nikola Tesla

Fantastic Inventions of Nikola Tesla
Nikola Tesla & David Childress

Nikola Tesla On His Work With Alternating Currents and Their Application
to Wireless Telegraphy, Telephony, and Transmission of Power
Tesla Presents Series, Part 1.
Leland I. Anderson

Nikola Tesla: Lecture Before the New York Academy of Sciences - April 6,
1897 : The Streams of Lenard and Roentgen and Novel Apparatus for Their
Production
Tesla Presents Series, Part 2
Leland I. Anderson
xix, 123 pages, illustrated, indexed.
ISBN 1-893817-01-6 \$12.95

Nikola Tesla: Guided Weapons & Computer Technology
Tesla Presents Series, Part 3
Leland I. Anderson, ed.
xv, 241 pages, illustrated, indexed, hardcover & paperback.
ISBN 0-9636012-5-3, 0-9636012-9-6

Nikola Tesla's Teleforce & Telegeodynamics Proposals
Tesla Presents Series, Part 4
viii, 119 pages, illustrated, indexed.
ISBN 0-9636012-8-8
Tesla Coil Builder's Guide to the Colorado Springs Notes of Nikola Tesla
Second Edition

Richard Hull
xxvii, 203 pages, well illustrated, spiral.
ISBN 0-9636012-2-9

Dr. Nikola Tesla Bibliography
John T. Ratzlaff and Leland I. Anderson
250 pages, spiral.
ISBN 0-9636012-6-1

PRIORITY IN THE INVENTION OF RADIO -- TESLA VS. MARCONI. Leland I. Anderson, 9 pages, 8 illustrations, 17 references, 5" X 8".

JOHN STONE STONE ON NIKOLA TESLA'S PRIORITY IN RADIO AND CONTINUOUS-WAVE RADIOFREQUENCY APPARATUS. Leland Anderson, 24 pages, illustrated, 5" X 8".

BALL LIGHTNING & TESLA'S ELECTRIC FIREBALLS. Leland I. Anderson, 31 pages, illustrated, 8" X 11".

THE TESLA BLADELESS TURBINE. Nikola Tesla, C.R. Possell, vi, 24 pages, illustrated, 8" X 11".

TESLA OSCILLATOR AND FLUORESCENT TUBE DRIVER. Gary Peterson, 17 pages, illustrated, 8" X 11".

TESLA'S FUELLESS GENERATOR AND WIRELESS METHOD. Oliver Nichelson, v, 48 pages, illustrated, 8" X 11", ISBN 0-9636012-0-2.

HIGH FREQUENCY OSCILLATORS FOR ELECTROTHERAPEUTIC AND OTHER PURPOSES. Nikola Tesla, 12 pages

THE TRANSMISSION OF ELECTRIC ENERGY WITHOUT WIRES (reprinted article/brochure). Nikola Tesla, 7 pages

NIKOLA TESLA'S RESIDENCES, LABORATORIES, AND OFFICES, (list). Leland Anderson, 11 pages, illustrated,

TESLA TURBINE REFERENCES, (bibliographic list). Leland Anderson & Warren Rice, 23 pages,

Tesla videos

The Secret of Nikola Tesla: The Movie

Tesla: Master of Lightning

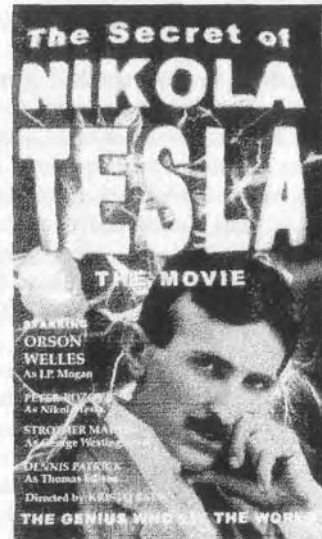

Tesla websites for books, information and tapes

<http://www.tfcbooks.com>

<http://www.teslamemorialsociety.org/videos.htm>

<http://www.netsense.net/tesla/>

<http://www.yurope.com/org/tesla/>

<http://www.nickf.com/tesla.htm>

<http://www.neuronet.pitt.edu/~bogdan/tesla/mdex.htm>

<http://www.mall-usa.com/BPCS/tesla.html>

<http://www.pbs.org/tesla>

20 Glossary of Tesla Terms

Excerpt adapted from "Project Insight: A Study of Tesla's Advanced Concepts," H. W. Jones, Proceedings of the Tesla Centennial Symposium, 1984

Advanced Concepts - Those ideas which Tesla was known to have conceived and developed to some extent, but did not pursue to fruition because of lack of funding and laboratory facilities. The more dramatic of these concepts were: free energy, wireless transmission of energy, employment of scalar technology, non-Hertzian waves, the Tesla shield, the Tesla ray.

Ball Lightning - A form of lightning in which a slow-moving, extremely high temperature sphere forms. Only rarely seen in nature, but producible by artificial means. Currently being used in the study of harnessing fusion energy for commercial use. See Robert Golka articles.

DeBroglie Wave - The quantum mechanics wave associated with a particle of matter which can theoretically give rise to intra-atomic interference effects. In his speech accepting the Nobel Prize, DeBroglie emphasized that these waves are real and must not be regarded simply as mathematical oddities or conveniences.

Electromagnetic Pulse (EMP) - A sharp pulse of energy and electromagnetic radiation occurring when an explosion occurs in an unsymmetrical environment. Tesla theorized that an EMP would result when two longitudinal scalar electrostatic potential wave patterns met and coupled into a flash of vector electromagnetic energy. See early Tom Bearden articles.

Electromagnetic Theory (EM) - Conventional electrical theory currently taught in our educational system, mainly giving credit only to Hertz, Maxwell, and Faraday. Tesla's work challenged the adequacy of existing EM theory, as do many physicists today. EM theory is only good for "far field" EM waves, as only electrical engineering EM textbooks (e.g. Magid) will admit. The recommended physical perspective, is to ask whether we are within the "near field," i.e., within the first couple of wavelengths. In this region, a capacitively-created EM wave will still retain mainly electrical characteristics and can be stopped by a Faraday cage, however, an inductively-created EM wave still retain mainly magnetic characteristics and go right through even the most expensive Faraday cage (made with Mu Metal) such as the quarter-million dollar one at Wright-Patterson AFB. Especially when dealing with extremely low frequency (ELF), most staunch EM theorists are stymied because we are always within the near field with ELF waves. See Thomas Phipps, Heretical Verities book.

Electromagnetic Wave — A Hertzian wave. A wave that oscillates transversely rather than longitudinally, having electric (E) field and magnetic (B) field effects (each may be detected). If two sine waves are pictured, perpendicular to each other, one on the x-y plane (vertical) and the other on the x-z plane (horizontal), both traveling in the x-direction, the E-field will be designated by the x-y plane wave (if it is polarized light) and the B-field will be the x-z plane wave. Polaroid® sunglasses work because they only let the E-field light through if it is in the x-y plane, whereas any reflected glare will have the E-field oscillating in the x-z plane (which is horizontal). Non-Hertzian waves are not transverse and often occur because near field, distorted waves are created in the experiment.

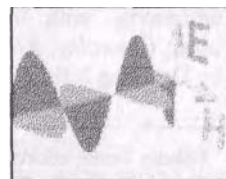

Energy - The capacity to do work, which is the result of a force moving a mass through a distance. Measured in "joules" it is the timeless version of power times time, such as kilowatt-hours (kWh), A energy conversion example is: 1 watt-hour = 3.4 British thermal unit (Btu), which is used as a measure of heat energy, See zero-point energy.

Ether - (also aether) Simply stated, it is the same as the physical vacuum. This differs from the common understanding of empty space, since theorists regard the ether (and the physical vacuum) as having substance (and particles in negative energy states). With the Silvertooth experiments, now showing a preference of direction for the old Michelson-Morley type of experiment, the ether is coming back into vogue. Very compatible with Eastern mysticism.

Free Energy - Energy which is free. Often confused with perpetual motion, free energy has three aspects; 1) no cost for input; 2) plentiful and inexhaustible; 3) one-time capital expenditure. Renewable energy is free energy, Zero point energy (ZPE) is also free and equated with the ether. A prophetic endorsement for free energy comes from Tesla's comment that "it is a mere question of time when men will succeed in attaching their machinery to the very wheelwork of nature."¹ He implies, what was discovered years later, that in open systems, it appears that energy is not conserved (e.g. ZPE vacuum fluctuations), However, in closed systems, we know that the second law of thermodynamics and energy conservation laws apply. Compare with the physics definition $G = H - TS$ where G is "Gibb's free energy," H is enthalpy, T is absolute temperature, and S is entropy. In words, free energy is the internal energy of a system minus the product of its temperature and its entropy.

Gravity - The phenomenon characterized by the physical attraction of any two material bodies, defined as the product of the masses divided by the square of the distance between them. Today, physicists are surprised to find evidence of 'antigravity' in the accelerated expansion of the distant galaxies (Science, Dec. 18, 1998) which was called "the breakthrough of the year." However, Tesla talked about controlling gravity many times. The fact that gravity is always attractive and never repulsive is a curiosity that physicists have always wondered about. The fact that gravity has to travel many times faster than light speed to prevent aberrations has caused a lot of commotion.² NASA recently tested the Allais & Saxl experiments during a solar eclipse, showing that there is a shielding effect from the moon when aligned.³ There are many accepted modalities for creating artificial gravity and antigravity with high energy electromagnetism.⁴ See book, Causality, Electromagnetic Induction and Gravity, by Dr. Oleg Jefimenko; Hunt for Zero Point by N. Cook

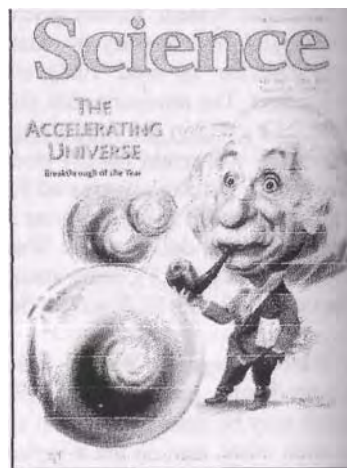

¹ Nikola Tesla, addressing the American Institute of Electrical Engineers, 1891

² Tom Van Flandern, "The Speed of Gravity - What the Experiments Say," Phys. Lett. A, 250, 1998, 1-11; also in Future Energy: Proc. of COFE, 1999, IRI

³ Saxl & Allais, "Observation of Periodic Phenomena with a Massive Torsion Pendulum," Report #702, Integrity Research Institute (IRI)

Longitudinal Wave – A pressure type of wave, similar to sound, in which the vibrations are along the direction of travel, a sequence of compressions and rarefactions. E and B fields are misaligned. Scalar waves are longitudinal, as contrasted with EM “Hertzian” waves which have transverse oscillations. Longitudinal waves are non-Hertzian as a result, as Tesla said many times, regarding his magnifying transmitter. The current density (or any vector field) can be split into transverse J_t and longitudinal J_l components.⁵ The transverse or solenoidal current has $\nabla \cdot J_t = 0$ while longitudinal or irrotational current has $\nabla \times J_l = 0$. See Dr. Thomas Phipps book, *Heretical Verities*.

Radiant Energy – Term used by Tesla in his two 1901 patents, #685,957 and #685,958, indicating radiation of any kind. In this case, it indicated Roentgen rays or x-rays as they are called today. He intended the single end x-ray tube to operate at the top of a Tesla coil or preferably, the magnifying transmitter.

Scalar Field – In physics, each point in space for a particular potential is assigned a magnitude but no direction. The scalar potential is just the Coulomb potential due to a charge density $\rho(x,t)$. This is the origin of the name “Coulomb gauge.” Compare with the vector potential A created by a toroidal magnetic field that satisfies the inhomogeneous wave equation. While EM waves travel at light speed, “the scalar potential ‘propagates’ instantaneously everywhere in space.”⁶

Scalar Wave – (see Longitudinal Wave.) Also Tesla Wave. An oscillating field of pure potential without E and B fields. Starting with $B = 0 = \nabla \times A$ and $E = 0 = -\nabla \phi - 1/c (\partial A / \partial t)$ the solutions are $A = \nabla X$ and $\phi = -1/c (\partial X / \partial t)$ where X is a scalar and obeys the wave equation. X is a scalar wave varying harmonically in time but only longitudinal fields exist because $A = iKX$ which shows that A points in the direction of travel. Normally, this is regarded as a gauge transformation but in quantum mechanics (e.g., Aharonov-Bohm experiment) it has real effects on the electron wave function. Because no energy or momentum transfer occurs, X fields can penetrate all objects and in fact can traverse the whole universe. Scalar waves thus may in fact, travel faster than light speed c, since no c-limited fields are involved.⁷ See “Scalar Potentials Fields and Waves,” Report #303, Integrity Research Institute.

Tesla Fireball – (see Ball Lightning.) A self-sustaining globe of radiant EM energy, exhibiting soliton behavior.

Tesla Ray – Forerunner of the laser, it was an EM device demonstrated by Tesla and offered to the British government in 1937 as a defense against the Luftwaffe threat. It was ridiculed and rejected. There is a variation is called the Tesla Death Ray, which was a particle beam weapon. See “Tesla, Man of Lightning” video www.pbs.org.

⁴ "Antigravity Report: Collection of Seminal Articles for Futurists," Report #707, IRI

⁵ J.D. Jackson, Classical Electrodynamics, Second edition, J. Wiley Pub., 1975. P.222

⁶ Ibid., p. 223

⁷ Dr. Jack Dea, "Instantaneous Interactions," Proc. ITS, 1986, p.4-34 and Raymond Gelinas, "Curl-Free Vector Potential Effects," p. 4-43

Transverse Wave - A standard Hertzian EM vector wave which oscillates laterally, as contrasted with a Tesla electrostatic scalar wave which vibrates longitudinally.

Vacuum - (See Ether.) A plenum which is filled with particles in negative energy states. Dr. Paul Dirac became a Nobel Prize winner for predicting the existence of the positron (antimatter electron with positive charge) after theorizing that under high voltage circumstances, and electron-positron pair can emerge, like magic, from the vacuum and go off in opposite directions. Such experiments (shown here with cloud chamber picture) have verified the vacuum is teeming with activity. See zero-point energy.

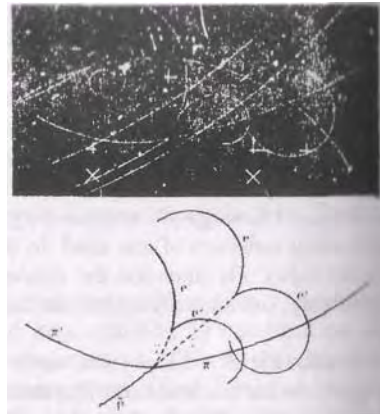

Vector - A force or field that has magnitude and direction, compared with scalar fields. EM waves are vector fields and contain momentum.

Wardencllyffe - Name of the first transmission tower in the world, erected 1901-3 in Shoreham, NY by Tesla which rose to a height of 187 feet, The Tesla Wardencllyffe Project, Inc. is a firm dedicated to recovering the property for a commemorative site. Contact CEO, Gary Petersen, POB 2001, Breckenridge, CO 80424

Zero-Point Energy - The energy of the vacuum that is sustained even at zero absolute temperature and no air (complete vacuum). This is the "very wheelwork of nature" and even implicated in the antigravity effect seen on the acceleration of distant galaxies (Science, Dec, 1998) The Casimir effect, experimentally verified, shows that virtual particles, as they emerge from the vacuum, also exert a measurable force, Zero-point energy (ZPE) has so many unusual characteristics that it forms the most intriguing field of study in physics today. It is predicted that, since the ZPE Casimir force already exhibits perpetual wavy motion already in nanotechnology (endless oscillations of nanostructures under tensile stress), we may soon see a revolution in energy production that is fuelless, as Tesla predicted. Recently a vacuum energy transducer was theoretically designed to contain a complete engine cycle with electrical output. "Free energy" was also a phrase used by the JPL scientist, Dr. Pinto, in the abstract of his corresponding journal article.⁹ See M. King books, Tapping the Zero Point Energy and Quest for Zero Point Energy or "Zero Point Energy and the Future" Report #822. IRI.

Further research information on all of the above-mentioned topics is available from the free Future Energy newsletter and catalog from Integrity Research Institute, 202-452-7674 or 800 295-7674

⁸ Gu Hai-Cheng, et al., "Influence of Combination of Casimir Force and Residual Stress on the Behaviour of Micro- and Nano-Electromechanical Systems," Chinese Phys. Lett. June, 2002, p.832

⁹ F. Pinto, "Engine cycle of an optically controlled vacuum energy transducer," Physical Review B, 60 (21) 14740, Dec. 1, 1999