

# Implosions' Grand Attractor

## Sacred Geometry & Coherent Emotion

*Course Study-Guide and Practioner's Handbook*

- \* Grand Attractor  
Coherence Science
- \* Sacred Architecture
- \* Science of Feng Shui /  
Geomancy
- \* Physics of Consciousness
- \* Origins of DNA
- \* Biophysics of BLISS  
Kundalini / Tantra
- \* New COHERENCE  
Biofeedback Breakthru.
- \* HeartTuner Background
- \* Magnetism, Earth -  
'Grid Engineering'  
& Rainmaking.
- \* New Physics of Implosion

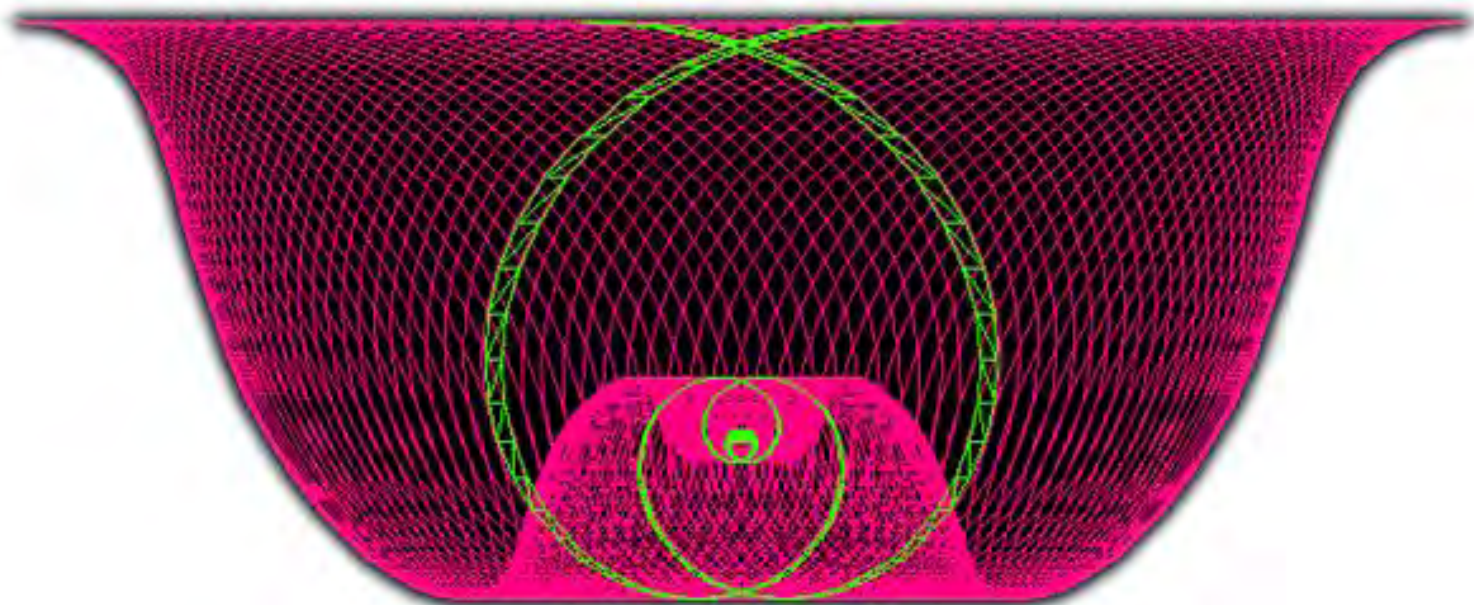
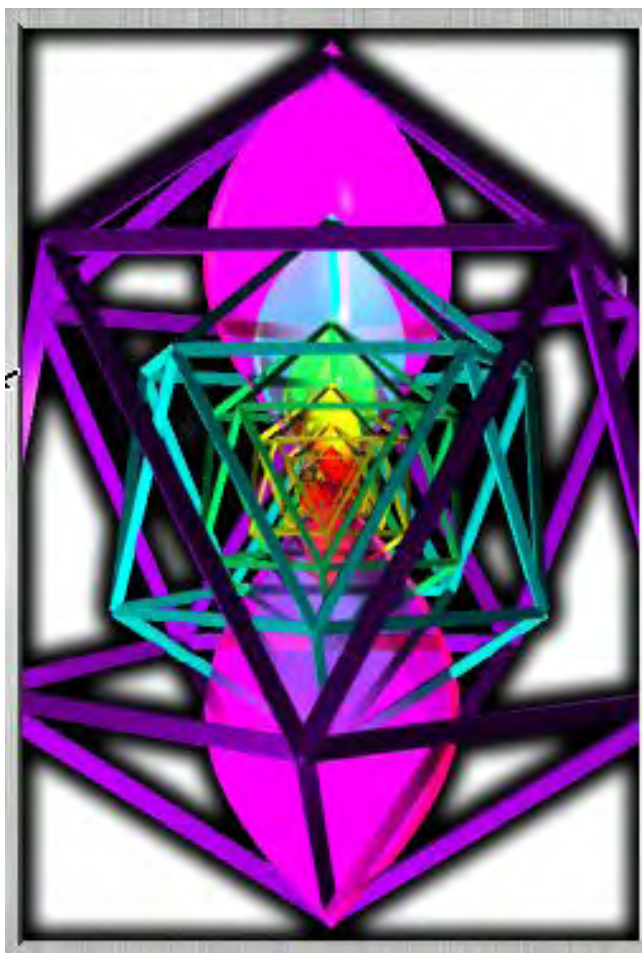

Assembled, Edited & Distributed  
from **Daniel Winter's** writing by  
**Implosion Group**    [soulinvitation.com](http://soulinvitation.com)

# Implosion's Grand Attractor

## Sacred Geometry & Coherent Emotion:

Course Study-Guide and Practioner's Handbook.

*Feng Shui, Sacred Architecture, Scientific 'Charge' Basis of Consciousness, Heart Coherence, Genetic History and Destiny of Consciousness in Fractal Making & Gravity Making ..*

*..Persuading Waves to Agree.*

**Course Materials from the work of Dan Winter - assembled and distributed by Implosion Group soulinvitation.com**

thanks also to:  
fengshuiseminars.com  
holisticarchitecture.com

*Includes Powerful new Annotated Bibliography AND Glossary.*

Non destructive unfolding of EKG Magnetics - Giving the Heart Wings..

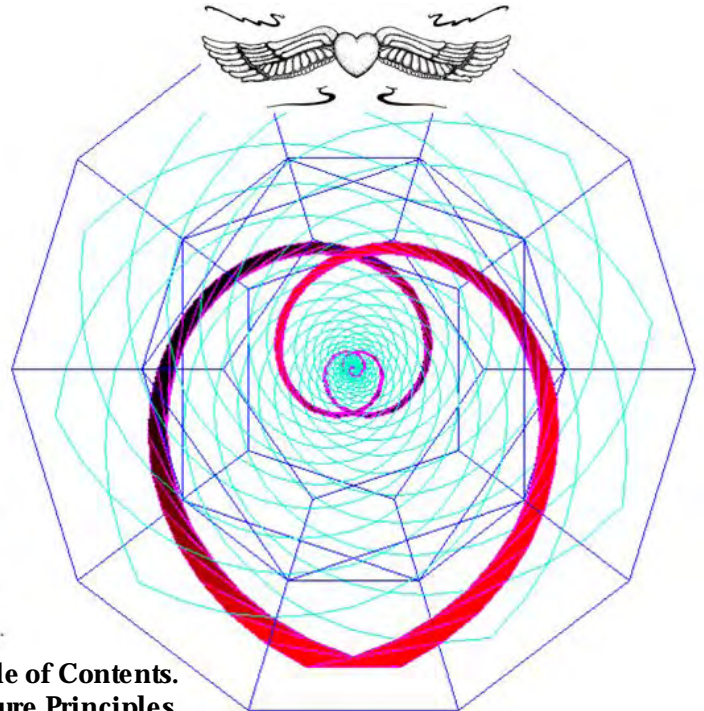
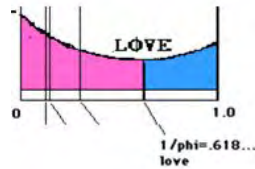

**Part One: Course Materials for 1st Week- See Table of Contents. Dedication , Intro , Syllabus, Sacred Geometry - Pure Principles, Hygiene for Bliss, Geometry of DNA, Architecture of LIFE FORCE, COHERENCE as Attractor.**

**Part Two: Course Materials for 2nd Advanced Week Origins of DNA, Gravity Making, Tornado Steering, Soul Pod Navigating, Physics of Shamanism, Galactic History, Science of Self-Awareness vs. Recursion, Kundalini**

**Phi  
h  
i  
R  
e  
c  
u  
r  
s  
i  
o  
n  
I  
n  
d  
u  
c  
e  
d  
C  
h  
a  
r  
g  
e  
A  
c  
c  
e  
l  
e  
r  
a  
t  
i  
o  
n  
I  
m  
p  
l  
o  
s  
i  
o  
n  
S  
o  
l  
u  
t  
i  
o  
n**

**PhiRICAIS**

(Musical Recipe to Implosion)  
**is THE Solution to:**

*How PhiRICAIS (Implosion) is revealed by Spectrum Analysis*

1. Infinite Non-Destructive Collapse
2. Infinite Compression / Perfect Acceleration
3. Perfect Damping / Phase Conjugation (optics etc)
4. Hydrodynamic Implosion (Ultimate Sorting)
5. Non Linear Energy (Voltage from Gravity)
6. Charge Acceleration thru C Light Speed (Gravity)
7. Measuring ATTENTION/ Bliss / Euphoria in EEG
8. Audio Tone Induction of EEG Transcendence
9. Measuring EKG Heart Openness / Compassion
10. Self Organization from Chaos/Artificial Intelligence
11. Electrically Defining & Measuring LIFE FORCE
12. Pure Geometric Origin of Alphabets (symbol-to embed)

..and the Grail

# Implosions' **Grand Attractor**

## **Sacred Geometry & Coherent Emotion**

*Course Study-Guide and Practioner's Handbook*

- \* Grand Attractor  
Coherence Science
- \* Sacred Architecture
- \* Science of Feng Shui /  
Geomancy
- \* Physics of Consciousness
- \* Origins of DNA
- \* Biophysics of BLISS  
Kundalini / Tantra
- \* New COHERENCE  
Biofeedback Breakthru.
- \* HeartTuner Background
- \* Magnetism, Earth -  
'Grid Engineering'  
& Rainmaking.
- \* New Physics of Implosion

Assembled, Edited & Distributed  
from **Daniel Winter's** writing by  
**Implosion Group** [soulinvitation.com](http://soulinvitation.com)

Implosion Group Can be Contacted: [implosiongroup@yahoo.com](mailto:implosiongroup@yahoo.com)  
Dan Winter's email: [lophi618@hotmail.com](mailto:lophi618@hotmail.com) or [dan.winter@wanadoo.nl](mailto:dan.winter@wanadoo.nl)

Dan Winter Travel Teaching Schedule: [soulinvitation.com/course](http://soulinvitation.com/course)  
Seminar Course Information also at: [fengshuiseminars.com](http://fengshuiseminars.com)

Sacred Geometry Learning Materials,  
CD's, DVD's, Kit's, Study Guide & THIS BOOK -  
available thru Implosion Group at [soulinvitation.com/tools](http://soulinvitation.com/tools)

**HeartTuner: Measure Emotional Coherence & Empathy**  
[heartcoherence.com](http://heartcoherence.com)

### *Table of Contents:*

- P 1. Frontispiece - Announcing PhiR.I.C.A.I.S.  
The Phi Recursion Induced Charge  
Acceleration Implosion Solution**
- P 2. Contact Info - Course Info  
- Materials Info.**
- P 2-3. Table of Contents**
- P 4-5. One Crystal's Dance & WordStar  
Role of Mind Among Waves Poem.**
- P 6-8. Guide to Sacred Geometry -  
Who Is the Course For? - The Program.**
- P 9. Sacred Geometry: Eternal Essence -  
Quest For the Fundamental Dynamic**
- P 10. What is Sacred Geometry?**
- P 11. The PRINCIPLES of Sacred Geometry.**
- P 13. Anu / Slip Knot & Sun's Heart (Graphic)**
- P 14. History of Sacred Geometry.**
- P 17. New Life Force Measure Sample Graphs.**
- P 18. The JOB for the Sacred Geometer.**
- P 19. Introduction to Survival Requirement:  
Charge Density of Bliss Process.**
- P 21. Child's Guide to Unified Field (Precis)**
- P 22. Intro to DNA History versus Hygiene for  
BLISS - What the Homework Means?**
- P 24. Section ONE ( 4 day course core curriculum)  
Introduction to Unified Field Thinking  
Universal Compressible Ether**
- P 26. Origin of Plus versus Minus CHARGE (Vor  
tex Centripedal vs Centrifugal - Graphic)**
- P 27. Origin of Donuts / Torus - Self Organization of  
Field Domains..**



*Table of Contents: continued*

- P 30. **Origin of Geometry among Donut Domains.**  
Platonic Tilts of the Donut Fields Create Atomic Table (Graphics)
- P 36. **Self Organization in Waves of SACRED or Divine Proportions.**
- P 37. **Quantum Mechanics is a name for Wave Symmetry and Geometry.**
- P 38. **What is a Fractal Attractor.**
- P 40. **What Causes the Centering Force of GRAVITY?**
- P 41. **What is Coherence? (also see Glossary on this)**
- P 43. **Origin and Meaning of The Golden Mean Ratio**
- P 45. **What is Embedding?**
- P 45. **What is the Symmetry of Compassion?**
- P 50. **How Does CHARGE Itself Become the Vehicle of LIFE FORCE**  
AND in so doing - become the ARCHITECTURE of the SACRED.
- P 52. **Intro to Life Force Measures - How Life Force is Predicted by ElectroNegativity & Intro to Phi-R.I.C.A.I.S. (Phi - Recursion Induced Charge Acceleration Implosion Solution)**
- P 61. **The Life Force Cycle Map: Water follows Magnetism follows Symmetry follows Implosion follows Awareness. .. follows Water.**
- P 62. **Water Nozzle for Implosion to Sort Pollution.**
- P 64. **Application to ARCHITECTURE - Pure Symmetry Science of CHARGE.**
- P 68. **In cube ation version PHYcycle in Architecture - Hex versus Pent.**
- P 69. **Holistic Architecture - Examples ( Michael Rice - holisticarchitecture.com )**
- P 70. **SACRED Architecture - ATTRACTING RAIN - IS Attracting Charge.**
- P 71. **RainMaking Science and Intro to Labyrinths**
- P 75. **Intro to IMPLOSION Science.**
- P 76-77. **Implosion Graphics**
- P 78-85 **Labyrinths and RAINMAKING continued.**
- P 86. **LightCity - Bringing LIFE Back to Cities and BioRegions by Attracting /Repairing Magnetic Lines**
- P 88. **Grid Engineering as a Tool for Peacemaking.**
- P 89. **Microwaves versus Your Health.**
- P 90. **Addictive Behavior versus Mucous versus Bliss.**
- P 92. **International University for the SCIENCE OF PEACE.**
- P 94. **Harmonic Module - Peacemaking by Linking Hearts and Minds. Corporate Coherence Training.**
- P 98. **PeaceMaking in the Land . PeaceMaking in the SHAPE of TOUCH.**
- P 102. **PeaceMaking in Human Movement : Bliss Kinesthetic Introduction.**
- P 103. **PeaceMaking in the Breath. - Exercises in BLISS Process.**
- P 108. **The SACRED GEOMETRY of DNA.**
- P 117. **The RING in DNA.. “Sacred Geometry of LORD OF THE RING”**
- P 120. **SACRED GEOMETRY of ORIGIN OF ALPHABETS in ‘ringing’ DNA.**
- P 122. **Ring DNA - Academic View ... & “Supercoiling in DNA”.**
- P 127. **Shaping DNA into (Charge) RADIANCE: The Role of BLISS.**
- P 128. **History and Pure Geometric Origin of the GRAIL.**
- P 130. **Golden Mean Ratio research in the Musical Recipe of Self Empowering BLISS.**
- P 131. **Rock and Rave: Ecstasy with Purpose.**
- P 136. **Kundalini: Biological & Environmental Power of Extreme BLISS.**
- P 143. **Sacred Geometry of Music. Musical Language of the HeartTuner / Healing with Music**
- P 144. **Intro to Feng Shui - Practicum - & How to steer the tornado of Magnetism.**
- P 146. **Reprise: Summary of the First Part - Perfect Branching**
- P 147. **Sacred Geometry Dialog for Dummies. (Review)**
- P 152. **Course Syllabus- Keyword Review in Outline Form. followed to Intro to Advanced Syllabus.**
- P 157. **Intro to Home Study - Assignments.**
- \*P 158. **ADVANCED Science- PHI Recursion Induced Charge Acceleration Implosion Solution. Outlines/links**
- \*P171-174 **Implosion and Gravity / Energy Device Technology - Fractal Thrust from Capacitors.**
- \*P175 **True Physics of ALCHEMY**
- \*P180 **Modeling and Science of Heart’s Electrification During Euphoria. Heart as Attractor.**
- P 183 **Bibliography - Extensive - with detailed annotations.**
- P 193 **Glossary - detailed background on many new keywords used.**

## <sup>4</sup>Crystal Platonics and Zodiac Dodge

(from Dan's 2nd Book: 'Alphabet of the EarthHeart')

About: 'Once Crystal's Dance' - quoting Vincent Bridges:

"This new Emerald Tablet contains the keys to a vast new synthesis of science and spirituality. It also contains the keys to understanding the book you are about to read."

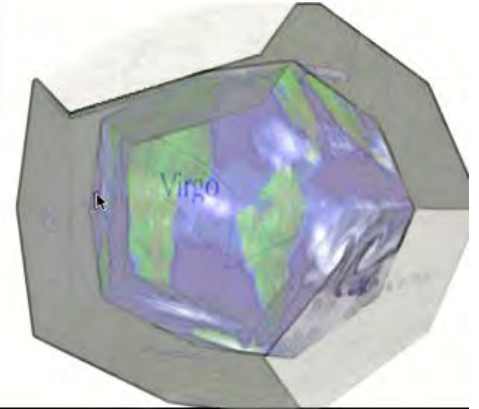
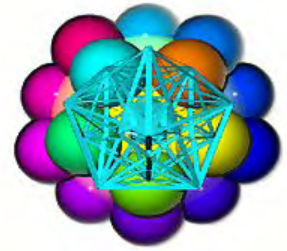

### One Crystal's Dance

(taking comfort in the role of mind among waves)



**Embedding or Nest-ability  
Is the essence of beauty  
Because it is the essence  
Of sustainability for waves..**

To say that a substance is

Compressible - means, among other things, that it can store momentum .

Storing momentum may at first seem trivial, but all of nature, stars and beautiful babies exist because of this talent.

Our world is conceived as being one of waves .

We are given a glimpse of the atomic world as packets and bundles of waves, locked in the musical geometry of coherent wave's prolonged embrace.

Wave nature requires compressibility.

Compressibility requires momentum storage.

Momentum storage allows order to be stored and retrieved.

A multi-connected wave surface allows for multi-connected information storage.

The torus (donut) is the primal multi-connected wave surface.

The atomic table is a polygonal (many faced /facet) grouping of toroidal vortices, and is archetypically multi-connected.

The universe is uninterrupted as wave surface, is multi-connected, and is holographic.

The universal compressible media is a unified field.

The key question arising out of our understanding of the universe as wave-like in nature:

What is the role of mind - or C o n s c i o u s n e s s - among waves?

We have grasped that the differences between fundamental forces are not differences of 'substance', but of scale.

(Ratio as the sacred, Scale as the profane.)

The principles of wave I n t e r f e r e n c e are the same for waves between nerve cells at their synapse as they are for waves between electron shells at their quantum levels.

They carry the same forces of compressibility and information storage through the same media- they simply act on different scales.

At first we don't see that information dancing at the level of the electron shell, shares the music of the dance between synapses in the nervous system. Their 'scales' are vastly out of range of each other. Here is where our challenge to see mind among the waves becomes more interesting.

I n f o r m a t i o n / m o m e n t u m / m i n d embeds between frequencies when it lives in geometry's comforting womb ( m o t h e r - m a t t e r - m a t e r ) .

If you pull a coil spring on its ends, It shrinks only slightly on its sides.

Thus a small movement can be energetically linked to a great one.

The piezoelectricity of quartz is created by its ability to carry energy between frequencies down its spiral (an asymmetric coil spring of electronic life).

DNA is coil-sprung likewise in its role connecting the cell to the choreographic (and bell-like) ring of its etheric body.

The brain also sits resonating atop a serpentine coil of glandular 'chakras'.

It is acoustically phase locked to the heart. During ecstasy the piezoelectric coupling of the brain to the dance of the glands triggers the secretion of the psychoactive hormones, the liquid dopant to the body's crystalline song electric.

The sound to the electric dance of connectedness thus begins as a place to touch between frequencies.

In the body this pattern of r e a c h i n g to touch between scales, is designed to go far beyond just sound touching light. This is the axis of Eros across which the finger of God touches the matrix of matter through the spark-gap that is man: The bridge between worlds. When seeds of order are planted in nourishing media, they can grow beyond the bounds of their womb.

Momentum's rush to grow - Round the vortex seed - With center of gravity (good heart), Knows no bounds. The implosion - That is ecstasy - Is thus generated - Around the seed thought, Which Is At Once A Feeling, Of Connectedness - Love - Every bond: a phase lock of unconditional sharing.

We now can see how attention, Focus, Or mindfulness, Can be the medium of creation - In a media of wave: Only the wave which can stand as a wave, can store its information/momentum.

In order to stand, the wave must unconditionally share

its momentum in a geometry/matrix/womb. It requires the mirror of itself

R e t u r n i n g Back on itself To create the wave node which has the illusion of stability.

Momentum in symmetrically opposing directions creates Stability/matter/Maya.

In order to enter the rotational-feminine-matter,

Linear-masculine-energy

Must be initiated in the spiral dance path Of momentum.

The path of conservation of momentum

Between frequencies on the tightrope (light rope), Between energy and matter,

Line and circle, Is the golden mean spiral.

Focus and attention is the power to hold a wave node (or seed thought) fixed

in the flux, like choosing the note(or node) by putting a finger on

The fret of the guitar string - the shape of the wave which

is given the chance to stand, is chosen in the places of stillness.

*Wordstar - Pulse, shiver, self no other*

*A compressible media, differentiation from homogeny.*

## **Word-Star**

*When i am everywhere, i am no(w)here.*

*I am the shape of focus, - I can hold an i/eye*

*When i turn about a center of focus,*

*Feeling a center of gravity. - Eddy to vortex... A path with a heart;*

*Attending intending to turn the turn (cross the t and dot the eye*

*Catching my self bobbing Back from the center of the turn, from*

*Vertex vortex to torus torah (called a figure 8*

*Segregation of momentum in focus i call: i)(not i - eye)(not eye*

*mem)(brain . Iterate wave form-making*

*A threshold for the quantum to leap&shy;&shy;*

*The waves barrier is the illusion of separateness*

*- Longing is born from this, the only kind of length.*

*Vortex center to as far as eye can touch,*

*i call universe; From center to limit is one:*

*The boundary holds me so that the shape of the boun(d)ce shapes me.*

*The size of my center to the size and speed of my bound;*

*A constant of fine structure.*



## A GUIDE TO SACRED GEOMETRY

\* Sacred Geometry is a **PATHWAY TO UNDERSTANDING** who you are, where you are from and where you are going. It is a blueprint of creation; an interface between the seen and the unseen, the manifest and the unmanifest, the finite and the infinite.

\* From the mosaics of the Middle East and pyramids of Ancient Egypt to the calendars of the Aztecs and the Taoist philosophies and medicines of India, Tibet and China, Sacred Geometry has long bridged the world of spirit and matter, Heaven and Earth. It continues to play an integral role in the traditions of art, architecture, science and cutting-edge physics, alchemy, feng shui and geomancy, music and mathematics.

\* Sacred Geometry shows how each time two lines cross, they have to either figure out how to distribute and share their pressures or self-destruct. The result of this test for "shareability" is called symmetry. All waves, and eggs, and people, and stars, survive in their world to the extent they learn how to embed themselves. We now know the exact geometry of perfect embedding. It is teachable, and it a real key to Feng Shui, architecture and sacred design. When waves can agree to meet sustainably this is called "sacred".

\* All actions obey distinct patterns, and Sacred Geometry describes these laws through shapes, forms and ratios. It is a universal language of pure truths based on the inner workings of nature.

\* To truly understand Sacred Geometry we have to understand that everything in the universe is made up of energy and this energy is in a continual state of transformation.

\* Energy can be defined in terms of frequency and harmonics - even the structure of the human body is based on the same principles found functioning on all levels of creation.

\* Our bodies holographically contain all the information of the universe - geometric knowledge is innate within us and we are naturally attuned to the harmonics of the universe, before birth, during life and after death.

\* Sacred Geometry gives you the opportunity to take a **BIG PICTURE** look at yourself and your place in the world. Once mastered, it can be applied to healing, counselling, biofeedback, researching, teaching, designing and the creation of **PEACE, BLISS and ONENESS.**





*Dan Winter at the Belgian filmmaking for "Purpose of DNA" DVD*

## WHO IS THE COURSE FOR?

This course will have particular relevance for:

\* People who want to initiate change and are looking for new perspectives in their private and professional lives.

\* Architects, designers, healers, dowsers and feng shui practitioners, who will all receive further validation of their skills.

\* Teachers, builders, mathematicians, computer folk, artists - everyone from the technical minded to the intuitive feeler.

\* Those who deeply feel the need to give meaningful and measureable SCIENTIFIC language to profound spiritual experiences, thus anchoring, enabling descriptive accuracy and making these experiences "shareable".

\* Anyone wishing to teach, practice and facilitate better bliss, movement, ritual, euphoric states based positive immune system effects, magnetic and feng shui symmetry practices ('grid engineering'), including labyrinth, stone circle work, spectrum analysis of magnetic pollution.

\* Anyone with deep questions about diet and lifestyle practices that really support consciousness.

\* Those wanting to prepare for Shamanic magnetic tornado steering and successful dying.

\* Those who appreciate the term NON CREDO ("I do not believe"), and are willing to define their lives and processes by "pure principles".

\* Free thinkers and dogma-free lovers. These seminars will open the doors to wisdom, healing and universal spirit. They will show you the various influences on our individual and collective lives and how to perceive the mechanisms to make positive change.

Together, we are influenced by nature,....This is a World Without End. Our physical, mental, emotional and spiritual experiences are called together in the healing process. This is the Theatre of Life...a dynamic harmonic applied to every aspect of your life and understanding...

## THE PROGRAM

The certificate course is designed to add great MOMENTUM to your LIFE, pathway, profession, creativity and soul purpose. It will also improve your health and knowledge of LONGEVITY, enabling you to enhance your own life and the lives of others.

Participants will be trained in the major theories of :

**SACRED GEOMETRY, DESIGN, HEALING and EMOTIONAL COHERENCE,**

and to develop a scientific language that embraces the concepts of :

**CHI-LIFEFORCE-EVOLUTION-COSMOLOGY and CONSCIOUSNESS.**



**The course comprises** two parts, both held over four days in various locations around the world.

A comprehensive home-study program using DVDs and CD Roms forms an integral and compulsory part of the course and extensive home-study tapes and DVDs are available to further facilitate your learning. You also have the option of training in HeartTuner biofeedback applications. This practitioner training is truly revolutionary. For the first time, students will be able to move deeply into the experience of Sacred Geometry via Dan Winter's cutting-edge curriculum, research, teachings, writings, animations and breakthrough theories. Dan imbues each subject with an inspiring, dynamic and creative rhythm - his work is mind-expanding and this course will equip you with knowledge and wisdom that can be applied directly to design principles, healing, biofeedback, ecologically sustainable environments, music, addiction-free lifestyles and the hygiene of BLISS MAKING and PEACE MAKING. The program may vary slightly between locations.

Dan Winter is the principle teacher, with Michael Rice set to teach Part One in the US and guest lecturers also sharing their knowledge. Part Two will be held in a retreat-style setting, with an abundance of nature, fresh air, earth energy and great food. All details on fees, venues and dates are available on the website, or you can contact your local sponsor for more information.

**Implosion Group: [soulinvitation.com](http://soulinvitation.com)**

**Fengshuiseminars: [fengshuiseminars.com](http://fengshuiseminars.com)**

---

**PART ONE** (From the original brochure)

*"Earth may never be more hungry than now for detailed ideas from science which bridge mind and matter.*

*Medicine and biology are needing to understand more than ever how emotion and feeling affect immunity and health"*

The first part of the Certificate Course offers participants a step-by-step curriculum that serves as an initiation into understanding the following:

- \* The Universe is made of one substance and has one shape - the Sine Wave.
  - \* The world is made up of waves and sacred proportions.
  - \* Energy, inertia, matter, the wave, the line, the circle, the spiral.
  - \* Geometry produces symmetry. Waves get permission to arrange themselves and to store memory from 'ONE-NESS', through the Golden Mean 'Phi' ratio - the secret of the universe and the most accurate scientific pure principle to describe how things relate and function, evolve, change and manifest.
  - \* Waves are drawn to FOCUS and automatically sort themselves and agree to sustain via Sacred Geometry. They align to still points, creating 'CHARGE', 'Stasis', 'ecstasy', 'tingle', 'pure intention' and LIFEFORCE.
  - \* When the harmonics of the brain- body- heart-planet enter into NESTING they do so by the principal of FRACTALITY. The small is within the large;- the pattern in the wave core of hydrogen is the same shaped slip knot which makes your heart muscle - and is the same as the Heart of the Sun.
  - \*Fractals change form, shape, and vibration into higher and higher evolving patterns - an encoded thread linking larger spirals into smaller spirals and on to infinity.
  - \* DNA is a four-dimensional Dodecahedron. This is a very loving embrace, and is the same for the "dodecahedral" shape of the Earth Grid and Zodiac.
  - \* The doorway of perception is to holographically connect all of life processes - past, present and future. \*
- Coherence at any level is coherence at every level.
- \* Light, when folded back on itself, comes to know itself.
  - \* Who you are...
- 

**LEARNING STRATEGIES** - As well as group discussion and interaction, 3-D computer animations will be used to demonstrate how DNA braids and responds to hearts in a state of BLISS.

\* This embedding idea will then be applied to STAR MAPS, Map Dowsing and understanding Earth Grids.

Students will receive the 'Alchemical Workbook' as part of the course fee and can purchase home study DVDs and CD Roms to help consolidate this material between Parts One and Two of the course.

\* On a practical level, students will develop an understanding of the quality of numbers, ratios and proportions, which can be applied to art, design, healing and music. You will also look at the harmonic 'phi' expression in nature and explore design using 'phi'.

\* On a philosophical level, you will learn the importance of creating bliss in your life and gain greater understanding of the influences of Universal Cosmology and the cycles of change.

\* On an emotional level, you will get to grips with 'Lo-Phi' (LOVE) and how integral LOVE and COMPASSION are to Sacred Geometry.

\* From a grounding and leverage in pure principle, your creative INTUITION will learn how to FLY..

Unified Field Science & Major Religions Agree -  
 The Universe is Made  
 of A Single Unified Substance..

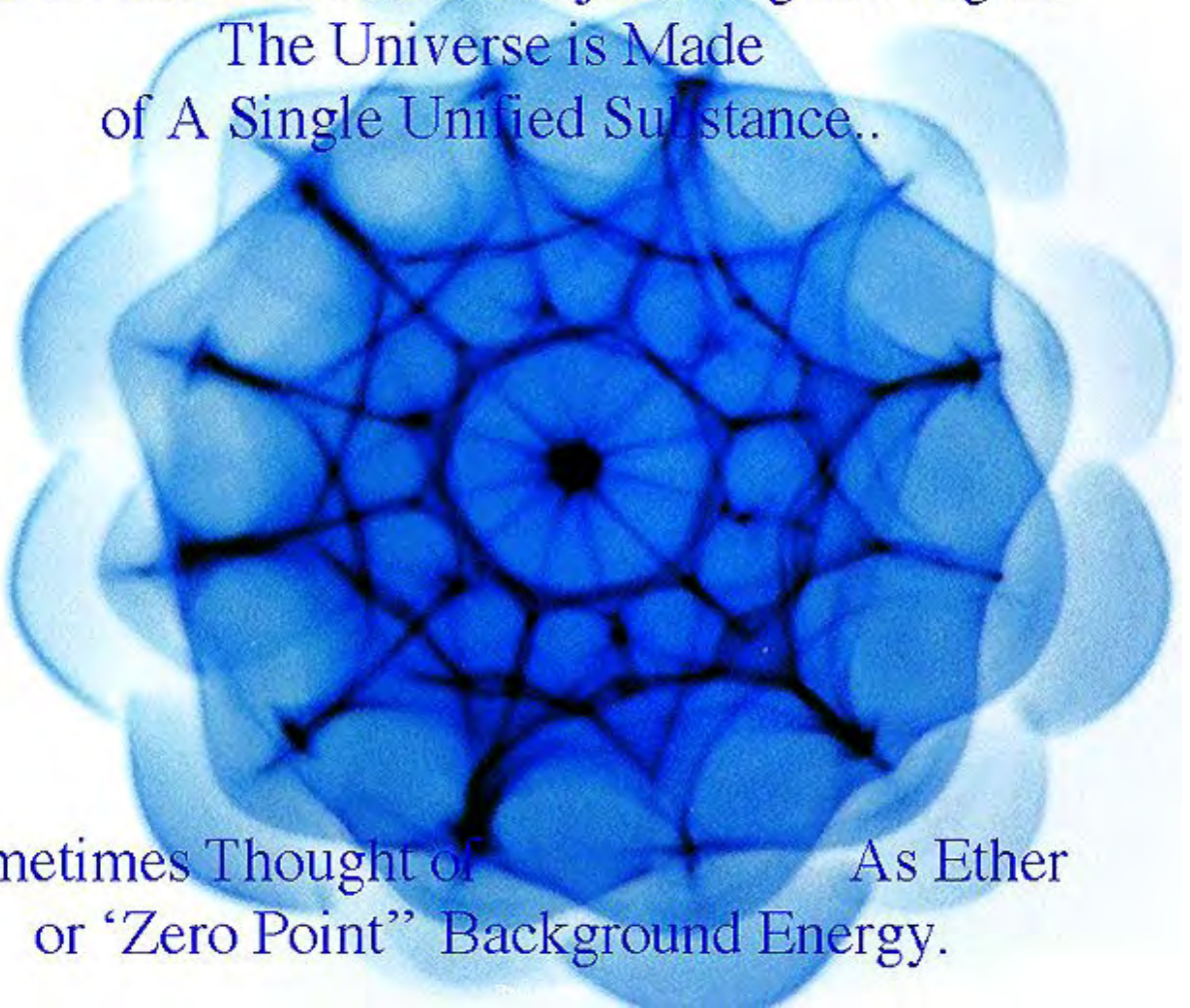

Sometimes Thought of As Ether  
 or ‘Zero Point’ Background Energy.

*Sacred Geometry is a name for the eternal essence  
 or ‘quest for the fundamental dynamic’  
 which by symmetry alone  
 teaches all the waves of this universe to form matter AND mind.  
 The pattern information which is at once  
 the inertia which defines matter for physics  
 is at the same time is the symmetry ingredient for waves to become  
 self-feeding, self-referring, self-organizing, and self-aware.*

*Implosion is the Holy Grail of Sacred Geometry  
 because it contains the Golden fractal seed of symmetry  
 which teaches waves to turn compression into acceleration  
 - the fiery gravity well at the heart of  
 self-organization and self-awareness  
 -truly the cauldron of consciousness itself.*

## WHAT IS SACRED GEOMETRY?

Let's start with the word - geometry. It's roots are - geo - which means Earth, and metric- which means measureable. Literally: able to be met. To meet - for waves - means to be 'phase' locked into some pattern which allows bonding or touching. So - literally the word geo-metry means to - measure & bond with the Earth.

The word 'sacred' is pregnant with meaning. In this course - we would like to suggest - one of the most fundamental possible meanings for the term 'sacred' is simply - to be sustainable. Our course begins with the notion that the universe is comprised of a single 'contiguous' ( means continuously connected - no discontinuity ) - compressible medium. Visualize a squeezeable squishy jello or smoke or ether. This is truly what is meant by a unified field - and is the basis of all great spiritual traditions (The 'ONeness of all things') as well as all great physicists - such as Einstein. Understanding how the force of MIND and SELF-AWARENESS arise in this universe made of only 'squeezeable waves in jello' - is the perfect empowering work of SACRED GEOMETRY - because it puts YOU in the picture. Your mind / conscious vortex of charge is the one who STEERS the waves - from where you choose to place the stillpoint of focus.

We are saying that the universe is made of nothing but stored pressure. Sound is a name for stored pressure, voltage is a name for stored pressure, love is a name for stored pressure - for example. That pattern of wave *pressures* gets the privilege of standing in one place - and therefore stores inertia. This is how it gets the name matter - after the waves learn enough symmetry to be able to share space and stand.

All of the phenomenon called matter arises when patterns of these waves begin to stabilize and begin to stand in one place for a while. Once a wave pattern has symmetry, - then it can begin to become stable enough to become a standing wave. Examples of a standing wave are a plucked guitar string - or a wave in a telephone wire which keeps bouncing in the same place in a steady wind - etc. Everything in the universe is only - a standing wave. Waves only stand if they enter rotational symmetry (the circle) - which STORES INERTIA 'creatively'.

The reason physics got caught in the original ('sin') - painful schizophrenia - thinking matter was separate from energy - was because of our habit of giving a name to inertia - and calling that a substance ('matter'). You see - all scientists agree that matter has never had any meaning or definition or origin - other than stored inertia. The problem with current science is that since they do not understand why any object falls to the ground - they do not understand what CAUSES gravity. Therefore - current science does not understand what creates the force at the center - which keeps waves going in the same circle - able to store inertia - and become or create matter. This centering force is the tornado like collapse compression which arises when waves arrange themselves into rose petal like patterns - called self-similar - or fractal. We are going to study below - how this centering of little tornados inside big ones - gets a wind going into the center - causing IMPLOSION due to self-similarity. This happens because **pine cone like self-similarity turns - COMPRESSION into ACCELERATION. Gravity is caused by recurring constructive adding (heterodyning) of wave velocities. (Acceration of charge IS gravity).**

Once we understand this beautiful rose pattern of electrical charge creating the wind to center (through the speed of light - for charge) called GRAVITY - then we are going to be a whole lot closer to understanding THE ROLE OF MIND AMONG WAVES.

But let's not get ahead of ourselves, we won't run before we can walk. We just hint at where we are going with this, in order to help you see why it is important to **follow a simple series of pure principles in order to understand how mind can create matter out of light.**

**THE PRINCIPLES of SACRED GEOMETRY ( Introduction )**

Sacred Geometry becomes pure principle when we realize it is simply symmetry lessons alone which make the difference between waves of charge which have ‘spirit’ and those which are dead. Symmetry is another name for God’s business card which says “*It’s All Done With Mirrors!*”.

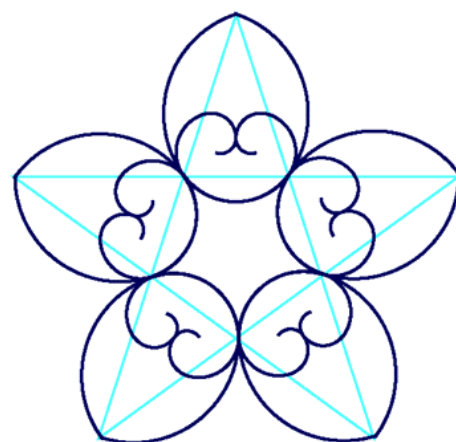

For a beginning, in principle, we study how waves are universal - how they naturally form donuts / THE torus shape. Then we learn how the atomic table is born because ‘donut’ fields find the sacred geometry which is the symmetry of the simple platonic solids.

*When these donut field effects nest into fractal or rose like patterns (as in gold) for example - they begin to participate in the charge implosion (opposite of explosion) we call LIFE. Enter well into this wave guide of continuous embedding so that you can be at the lightning center core of all life - (hygiene for bliss / peak experience / enlightenment / kundalini). Understand these electrical PRINCIPLES OF THE SACRED GEOMETRY of charge well enough that you become them.*

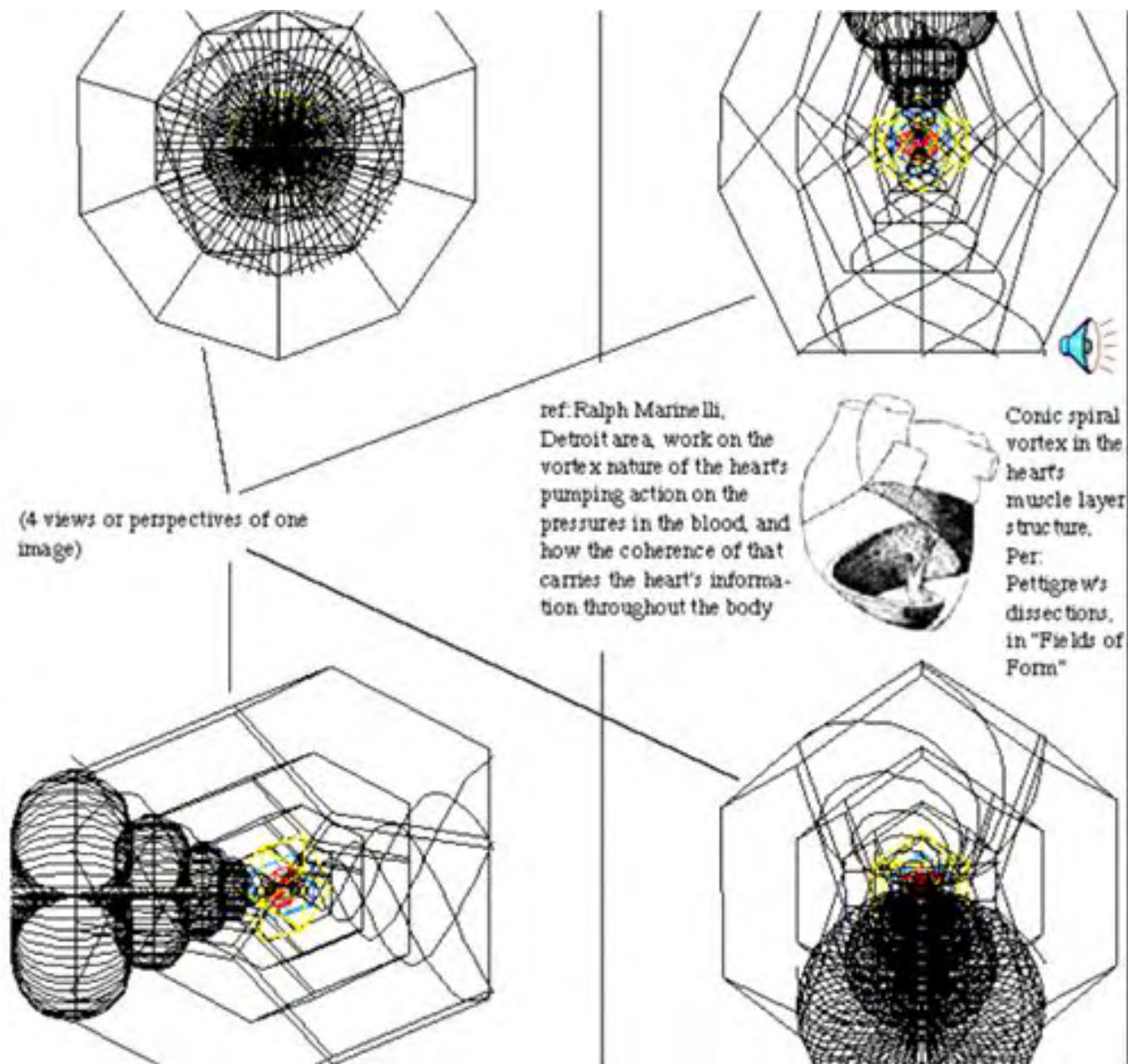

“Come On Baby-Light My Fire...”

The Heart is “PHire’d” by an Implosive Symmetry Array of Voltage Donuts  
 -Which Learn Compression -which IS Compassion & Key to Implosion..

Bucky Fuller's famous story tells how the slip knot slid down the rope which threaded from cotton to nylon to wool. The slip knot was NOT the substance upon which it was braided. In a unified field we cannot name substance since there is only one.

The **slip knot** is more correctly :

**THE MEMORY OF HOW TO TURN. and THAT is both  
THE ROLE OF MIND AMONG WAVES - and the ESSENCE OF SACRED GEOMETRY.**

Symmetry skill for waves 'slipping (k)not' makes MATTER, GRAVITY, and YOU!  
- ( A MEMORY OF HOW TO TURN ).

As you study the slip knot geometry of ANU, Quark, Hydrogen, Heart of the SUN, pictures-remember - THE CREATIVE PROCESS IS KNOWING HOW TO TIE THAT SLIP KNOT. That slip knot is also IDENTICAL to the symmetry which shapes the muscles of the human heart!  
(Compare with ANU / Heart / Solar Heart Symmetry on facing page)

### The TURNING INSIDE OUT

- Symmetry Skill  
of SELF RE-ENTRY
- Starts AND Steers  
Tornados.

The Universe is MADE  
of Nothing but Twisters!

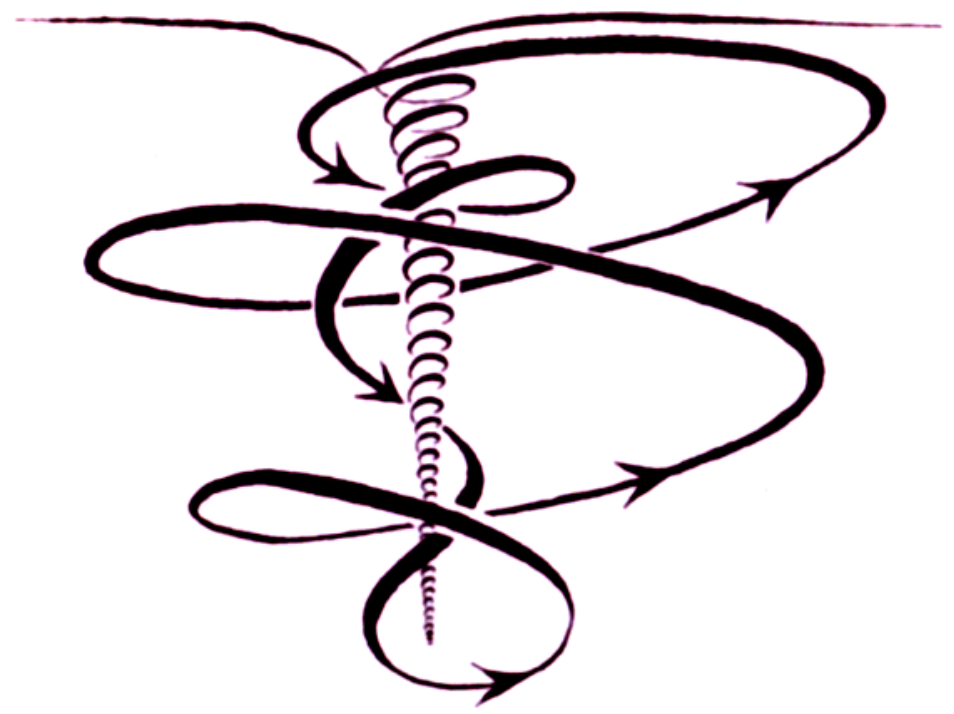

**It may be impossible to verbally tell a young boy HOW to tie the knot in his own new tie, some things you have to learn from the inside out.**

Later we will learn more about how mind inhabits spin by inhabiting FIRE - which is called phire ('Phi's Ray'). When spin pattern becomes nested well inside itself - like the petals of a rose - then the PHI ratio of those waves makes that pattern of spin INHABITABLE:  
- To be - ABLE TO BE BREATHED INTO is the 'recursive' ability  
to self re-enter - In HA - b - it.

**This is true both of inhabiting spatial 'fractals' and inhabiting fractals in TIME.**

(book: 'A Spiral Calendar'). In other words - the nature of self-awareness and self-organization called 'becoming mindful' among waves - requires self-similar or fractal shape. So locating pine cone like / nested spiral - fractal shapes in nature - including patterns of energy, space, AND time (event histories) - is the way to locate self-awareness.

As Sun's Heart Implodes, Spin Density There Quickens Human Hearts and Each Atom!

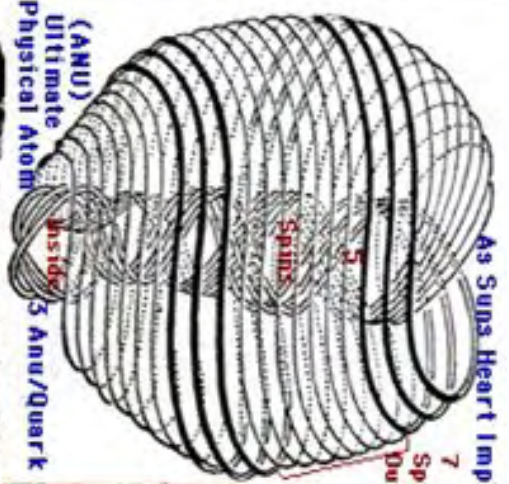

7 spins of tetra sort photon donuts into 7 color rainbow color is phase tilt calibrated by cone

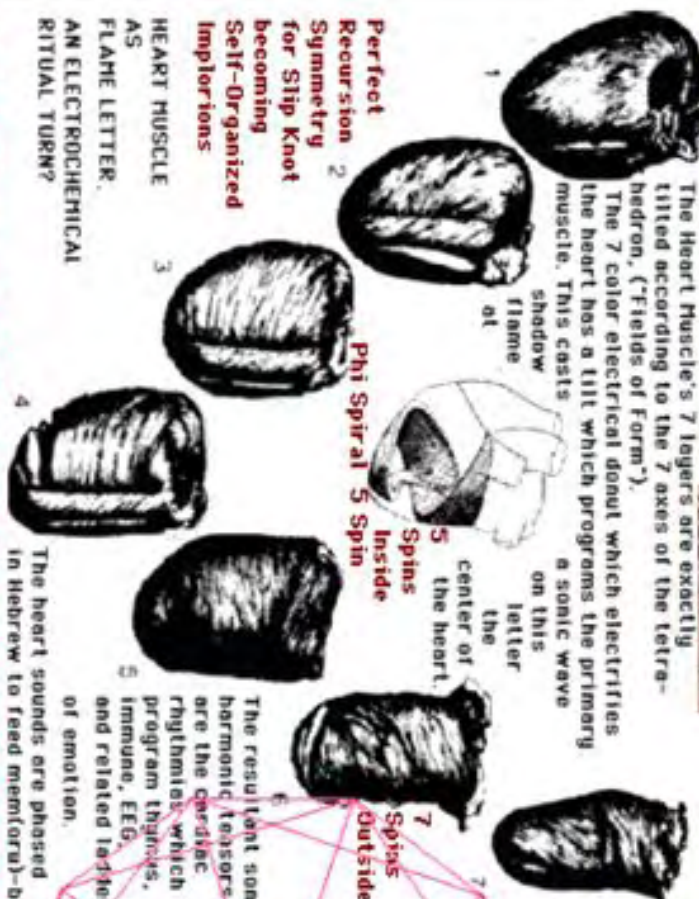
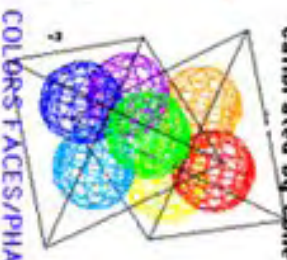

Perfect Recursion Symmetry for Slip Knot becoming Self-Organized Implorions HEART MUSCLE AS FLAME LETTER. AN ELECTROCHEMICAL RITUAL TURN?

The "Slip Knot"  
Of perfect Fusion appears to be The Same Gordian Knot In the 'Anu' coeur of Hydrogen, in the Human Heart, and in the heart Of the Sun as seen clairvoyantly By Babbitt & others. The fire of life itself lies in the symmetry Operations Which make this Self-organizing IMPLSION Self sustaining... We look now at Why implsion...?

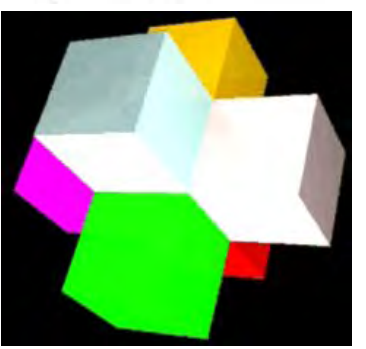

Recipe for the Perfect Donut 'Anu' 7 Spins (Spin Axis of Tetra 6 cubes around 7th) Create's CONTAINMENT In-Cube-A ton Outside while 5 Spins (5 Cubes In Dodeca) Create'd PHI PROJECTION Inside. Ophanim Sigil of Truth Cherokee Sacred Space

ANU: Heart of SUN, HUMAN, & HYDROGEN

## THE HISTORY OF SACRED GEOMETRY

Delete- the poison and disempowerment of personality worship and miracle worship - from religion and history - all that remains is the symmetry skill (hygiene) to attract BLISS / PEAK EXPERIENCE / ELIGHTENMENT ( electrical CHARGE DENSITY).  
That skill climaxes in the PSYCHOLOGY of IMPLOSION:  
Fields EMBED - FEELING Results - Charge is Attracted by Turning Inside Out - Gravity's Engine of Self-Organization IS Compassion .

Who invented PHI / The Golden Mean? ... Perhaps the same person who invented Pi and E (base of natural log). Who invented PURE PRINCIPLE? Does PURE PRINCIPLE NEED a WHO?? The pure principle of symmetry nesting of donut fields (symbolizing is nothing more than embedding) is at the origin of alphabets. This proves the principle: ultimately - the NAME - and the SHAPE - and the SERVICE are ONE - which means our personality is nothing more than the electrical symmetry shape of what service we render that sustains. Governments which worship personalities - die. Governments built around PRINCIPLES of law - survive. The same is true of history, physics, philosophy and spirituality.

IF for example, we expanded our view to include the intellectual history say of this galactic sector - then we might waste less time in disempowering personality worship - studying the seedy characters dotting Earth's intellectual history. Imagine the hilarity of cultures all over the galaxy knowing how to metabolize gravity directly in biology and charge - finding that our primitive planet is still motorized almost entirely by dinosaurs farting. This is called 'failure to wean'. In school, the teacher would do well to spend more time teaching HOW biology COULD metabolize starlight directly - and less time wasted discussing the mediocre personality worship in the western history of fossil farting.

*A good way to check to see if you have fed your 'soul' the spin life of PURE PRINCIPLE in anything, is to check to see if you have absorbed it's SYMMETRY ESSENCE - to enable you to make it - from the inside out.*  
*Pure Principle - is that which SUSTAINS spin - & therefore pattern retention.*  
*That symmetry ESSENCE - IS Sacred Geometry.*

*The Steiner student accurately visualizes a sequence of time lapse drawings of a bulb becoming a flower.*

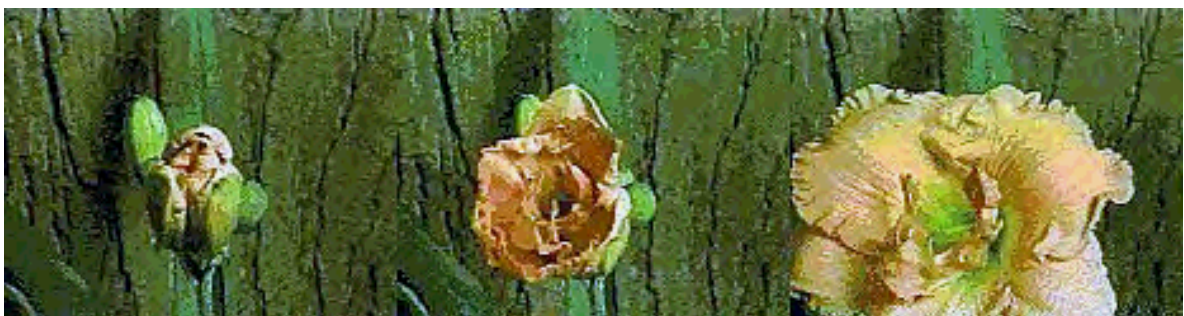

*The room FILLS with a love growth urge in all present there.*  
*Then the same student accurately visualizes that rose stepping toward wilt and death - and the feeling in the room changes dramatically. That is an example of becoming empowered by learning the sequence of symmetry turns in principle to CREATE.*  
*'Projective Geometry' maps constructive wave interference paths - a good way to check where to dream or die from.*  
*The place of power uses symmetry knowledge to gain leverage on spin.*

If we learn the **pure principles of symmetry which make waves sustainable** - that IS history's essence. We could say history is merely the distraction (non-fractal?) time necessary to make that discovery. The only thing waves store is that principle. That is CALLED essence - and is therefore ultimately the only thing which biology or people can store as well.

My view is that the history of Earth - in terms particularly of it's personalities is for the most part a recent skirmish in the Orion Wars. And further - that the most interesting part of this planet comes when the genepool learns to fabricate the kind of gravity using genes and glands and bliss to steer stars. Unless and until that happens - consider the rest mostly boring. ( Ask yourself today how much of your present memory would be useful 26000 lifetimes from now? - this may give you an idea of how much memory you will take thru death).

That problem - *how biology can internally fabricate life sustaining - 'self-organizing' GRAVITY fields - in it's internal 'self-similar' electrical structure - is KEY to the immediate survival of our genepool. The electrically self-organizing 'Phi' recipe for harmonics determines all the variables which make Gaia self-regulating. Climate in chaos is that field effect in chaos. We now know how to massage a biological oscillator OUT of chaos - feed it the harmonic symmetry elements missing from the PHI cascade - the same way we heal Attention Deficit - or measure the stock market emerging from Chaos* (Prechter & Elliott Wave theory based on Golden Ratio).

So few of us are able to recognize pure principle. That is why so little of our memory is worth saving at death. And why the nightly news is empty of food for the soul.

We don't even know why the word history has to be HIS-story instead of hers. At least two to three thousand years of history completely infested with fear of women - and not one historian of Earth even has a clue why? Of course the answer is off planet - the Orion queen Empire (half blood of the Annunaki 'H-ibi uru') whose urgent genetic problem we are the experiment to solve - was a ruthless MATRIARCHY.

The history of sacred geometry normally begins with names like Pythagoras and Plato. However there is a certain arrogance implied with a history that assumes that our planet is the origin of such things as sacred geometry and DNA. I do not agree with this arrogance, and as such suggest passing on the personality worship usually inherent to 'sacred' subjects. Remember- our new definition of the sacred - is access to what is sustainable. This view would rather suggest a history of sacred geometry based say-- on what symmetry makes DNA sustainable. This is a historical question dealt with deeply in the advanced material in this course. Much of history as we know it, does not even understand that **pure principle('recursive' or 'embedded' in the symmetry of CHARGE) is what sustains DNA.** Studies which do not teach pure principle bleed the soul, (biological sustainability ) because they bleed charge.

Distilling event histories into this kind of **shape (symmetry)** information  
of use to DNA is why:  
***Biology invented death***  
***to persuade us to stop trying to store feelings which being unshareable***  
***cannot propagate as waves.***

**Feel only what's SHAREABLE**

**- you tingle with charge - you stop decaying - you live forever.**

**If we learn to recognize pure principle - then we can distill something of use from history.**

A significant part of Earth history- is why the Niburu Hiburur Hebrew magnetic codes geometry (alphabet) ONLY included the symmetry of the tetrahedron. And what THAT did to cause them to lose the key to ensouling (imploding) and firing DNA - into stellar immortality. THERE is a fun question!

The story of the ET origins of DNA & it's discontents - is a good part of the advanced material in this course. The Golem / TAKadama burned out genes problem of a medium grade reptile ancestor named Yalweh / Enlil angry at his half brother Enki / Adonai over the death of his mother. It's not just about learning why some Jews are so afraid of women that they procreate thru a hole in the sheet - it contains the seeds of war:



**The Middle East is like a hive of bees swarming around their last memory of where there WAS honey. And they forgot how to MAKE honey. The honey is bliss - the skill is charge** - and the dome of the rock is an old seed for capacitive charge. Bliss in groups is the only way to compress into acceleration their genetic memory to achieve sustainability (be saved). Their unconscious knowing that if they don't get bliss - they will DIE - makes them ready to kill. (Just like it makes your teenagers ready to die in pursuit of bliss. And the immune system of your teenagers depends on being taught self-empowering BLISS).

The symmetry skill to steer into the vortex of blissful CHARGE is the precise geometric origin of BOTH the Hebrew and Arabic Alphabets - based on only one equation to map the Golden Spiral on the torus/ah. (Since both religions were formed by the same now hopefully apologetic interventionist half Draco family. ref: <http://spirals.eternite.com> and [soulinvitation.com/thecollective](http://soulinvitation.com/thecollective) )

Getting genes and glands compressing and up to speed (blissed out) is THE problem of the history of geometry. And it is the essential problem of the history of HERstory. People who have bliss do NOT shoot each other. Callahan's measure that predicts where war will break out -magnetism's conductivity thru the soil between 2 villages - predicts where FEELING CAN TOUCH BY SYMMETRY. This is the SCIENCE of how PEACE can be taught. ( [soulinvitation.com/peaceuniversity](http://soulinvitation.com/peaceuniversity) ) . PEACE happens where field effects implode to make centering force (literally make peace). This is measurable by harmonic analysis (power spectra) in brain waves as peak experience/euphoria, heart waves as compassion ( [heartcoherence.com](http://heartcoherence.com) ) , planet waves as the 'Schumann resonance' becomes a (Phi) cascade learning to collapse charge,, ....

In other words - this is how to achieve the symmetry of charge ABSOLUTELY REQUIRED to realize biological sustainability / PEACE ( & immortality). History as it is taught on this planet doesn't know what the important problem IS. (Maybe because it is missing HERstory -from the stars..) . There can be no issue even close to the importance of getting genepools immortalized ("saved") . . IGNITING your genes and glands.

Sacred Geometry is a symmetry solution for - **putting you 'In Charge'**.

**We will define the electrical nature of life - in this course - in pure symmetry terms**

**- as capacitive charge - whose 'harmonic inclusiveness' predicts vitality - . LIFE ( and awareness ) = The Ability to Attract & Self-Organize CHARGE**

Tools for Measuring The Weak Dielectric Capacitive Charge Field -

A Spherical Capacitor:

Gold Plated Ostrich Egg.. 'Biological Dielectric Container'

details: [soulinvitation.com/biophoton](http://soulinvitation.com/biophoton)



Measure How Many 'INCLUSIVE' Harmonics of Capacitive Charge are Present - and Measure the LIFE FORCE.

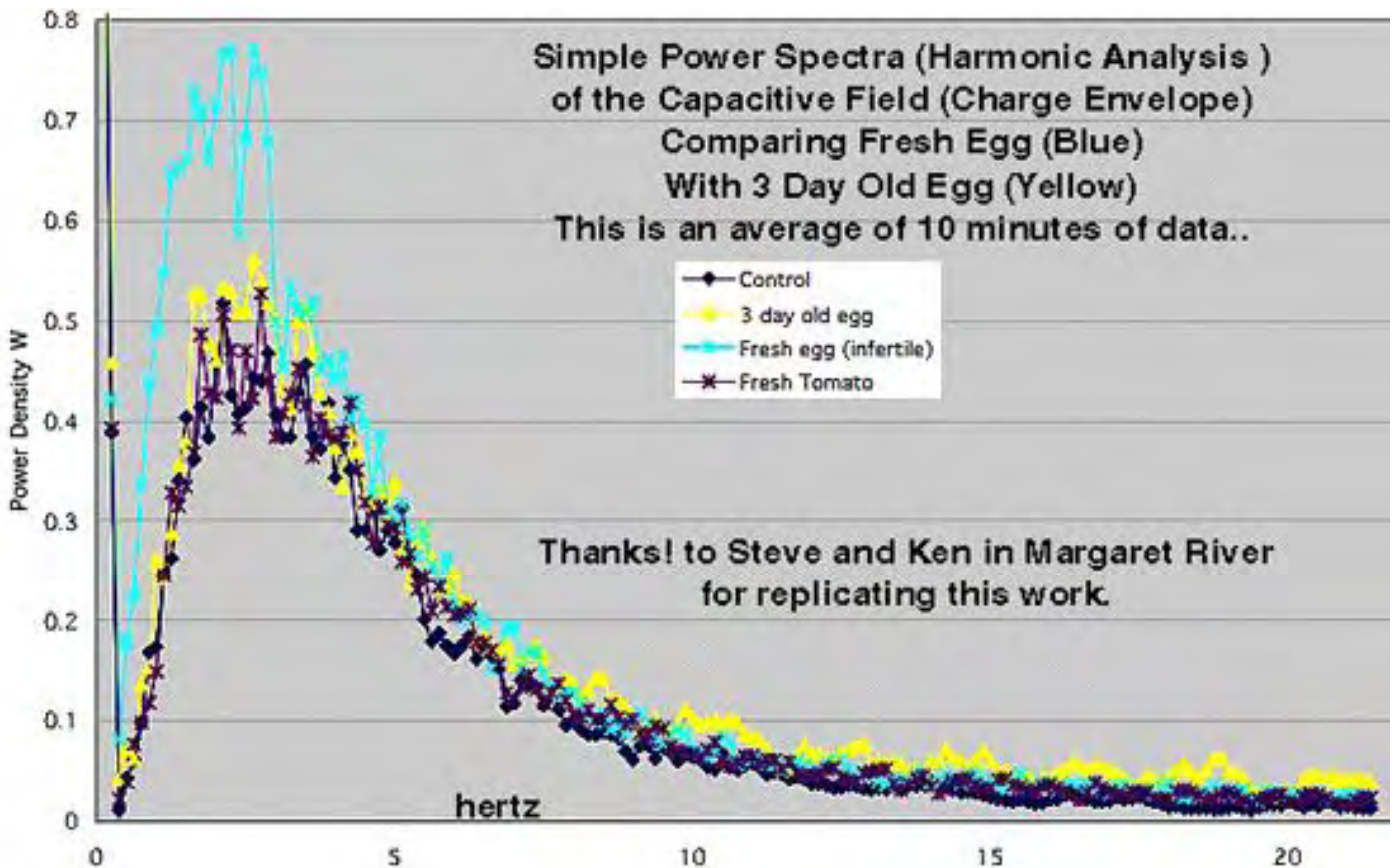
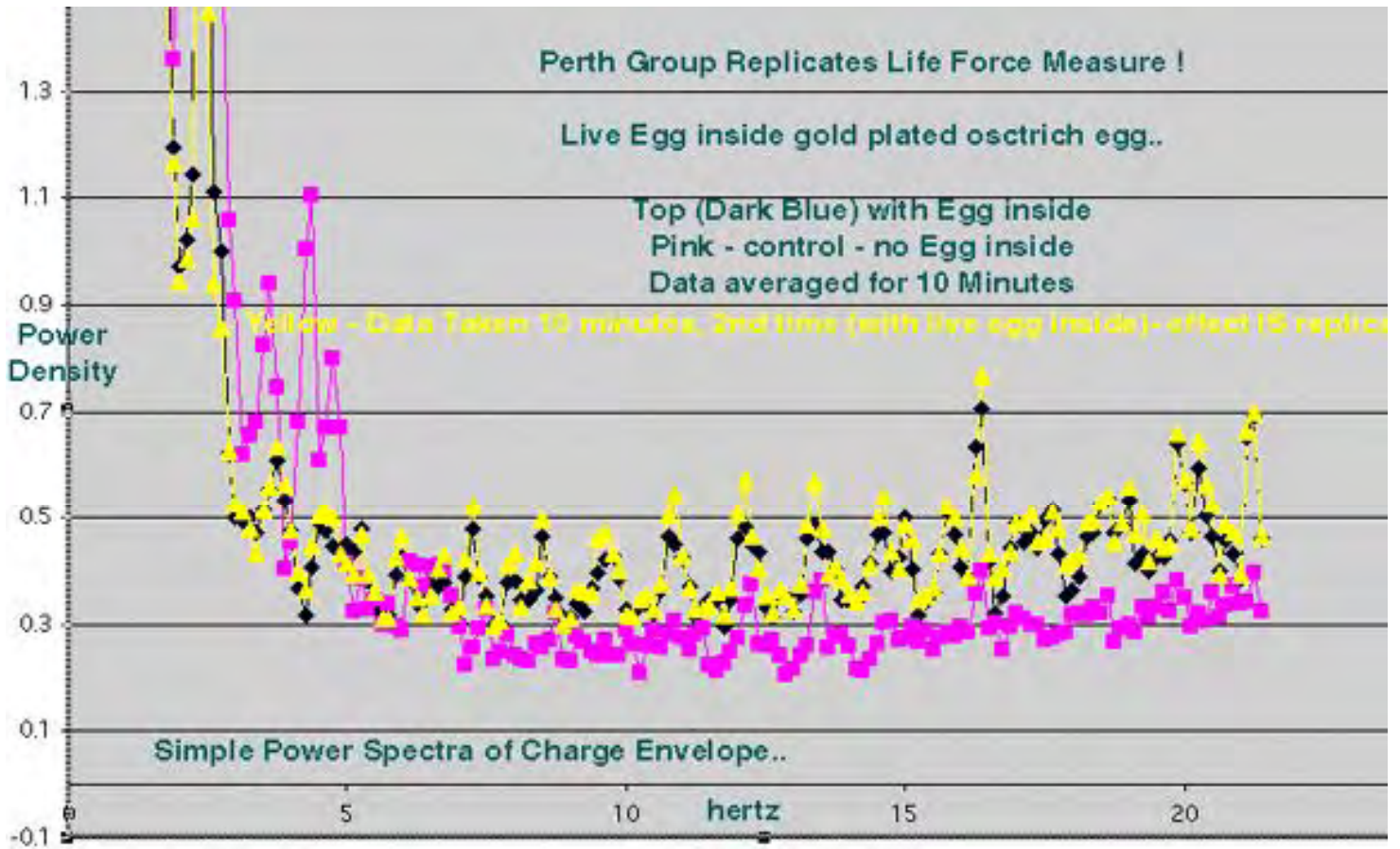

THIS is the job for the Sacred Geometer. Now if studying the history of Sacred Geometry can help this job great. But I don't think this planet has the printed library to teach that history. What this planet DOES have is the most fractal (diverse) GENETIC library this side of the galactic core! And that - is a library!

How to access that library? What is the library card for THAT historical database?

Remember when Jody Foster in the movie CONTACT used her dodecahedron magnetosphere to jump down the rabbit hole worm into her own DNA? Well - compression of charge (your inner eye) becomes acceleration IF the pattern is fractal - or rose petal like. Learning how to DO that compressing of the charge INSIDE YOU-- is the SHEM-AN-ic moment when you get the stargate library card into the best genetic library this side of downtown.

**Starting the compressing that becomes accelerating begins with the fractal key question  
- of COMPASSION: Is the feeling/magnetism INSIDE me the same shape / self-similar  
to the magnetism / feeling OUTSIDE me?**

... THAT is a rich way of looking at the history of DNA as sacred geometry .. And THAT history question forms a big part of the Part Two advanced material for this course ( preview see: [soulinvitation.com/enki](http://soulinvitation.com/enki) )

**Perfect wave compression...**

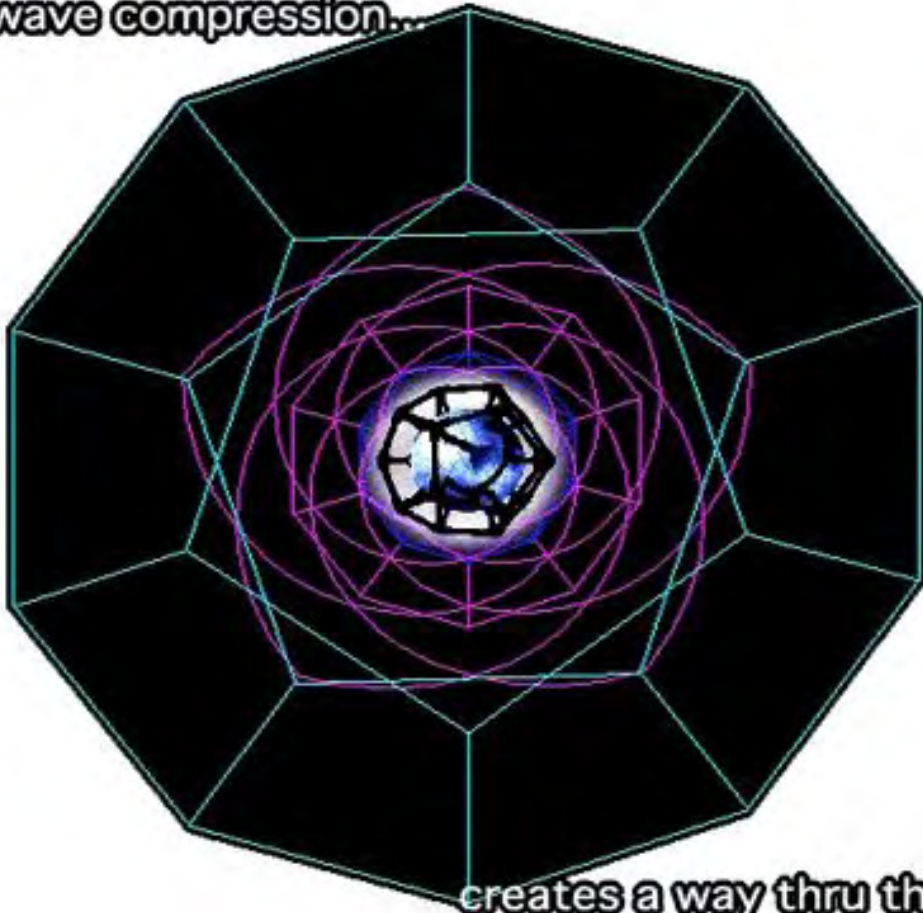

**creates a way thru the 'wormhole'.**

*From the movie "Contact"*

*Jody Foster's Dodeca (deca-delta as in Montauk's antenna symmetry?) vehicle of charge allows her to jump down the rabbit hole in her own DNA - seeing thru death.*

*Fearlessness = non-destructive compression = acceleration.*

**Overview - Section Two. -- : Introducing the Idea of CHARGE DENSITY as Information Density and the Survival Critical Electrical Nature of BLISS.**

*"Earth may never be more hungry than now for detailed ideas from science which bridge mind and matter. Medicine and biology are needing to understand more than ever how emotion and feeling affect immunity and health"*

Western history became schizophrenic in a significant way when church and state were divided. It reminds me of the Jesuit Priest then director of the Fermi Lab ('atom smasher') outside Chicago. At one point during my interview - as he got more and more uncomfortable with the directness of my questions - he exclaimed: 'Oh I NEVER mix my religion with my physics'. To me, that is an example of how schizophrenia begins. The Church of old had the best info we had on what the role of humans was in cosmos. It was based mostly on the Bible which was mostly mistranslated Sumerian, ... which started with a Draco family in genetic engineering trouble from Sirius (Annunaki). While that group (mostly Enlil / 'Yalweh') did try to leave some simple ('ko-sher') hygiene instructions to make genepools sustainable - it was based on many misconceptions of his own. (In the advanced material we study in the extra-terrestrial origins of DNA how ENLIL Yalweh was specifically the writer of not just the Hebrew Torah, but the ruling marriage codes of Aboriginal Australia, Muslim and other cultures.. The Elohim, The Nephilim, The 'Shining Ones', The Dragon Line.. etc.).

**Most especially destructive was the misconception that DNA could be ensouled by engineering alone, without fractality- and charge implosion (essentially - glandular BLISS - the way BIOLOGICAL INTENT - never mechanically available feeds charge implosion into self-directing sustainability). THAT misconception alone - put guilt instead of bliss at the center of western history.**

Western Science later in over-reaction against the spotty logic of a faulty religious tradition - tossed out the idea of SPIRIT - because they did not know how faster than light and interconnected was the flow of capacitive charge between biological systems. (Key to the physics of Astrology, the Kirlian photo, & defining LIFE FORCE was we shall see). Later - Wilhelm Reich did not do much to unify physics with religion when he misnamed - biological capacitance as ORGONE.

However in my view - the beauty and elegance of the physics of charge and the communion of dielectric fields (capacitive charge) is richer than any ancient Bible or Vedas (the work of Phil Callahan for example, and the advanced - [soulinvitation.com/biophoton](http://soulinvitation.com/biophoton) ). This is because - the possibility of measurement is the precision which ultimately makes information shareable and communication possible. Information density IS charge density itself- this is a concept which you are asked to 'grok' by the end of this course.

A clue here - is the way **RESOLUTION** means the same thing in physics and optics as it does in psychology - and it relates to **COHERENCE**.

**Are you resolved? ( Remember: compression is nature's way of sorting )**

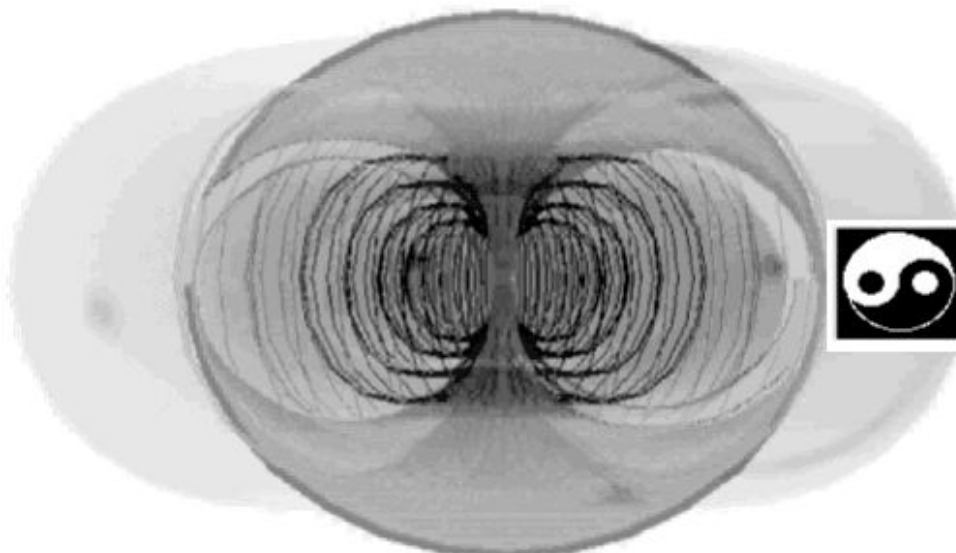

This means for example that with kundalini during the experience of lightening up your spine - there may be no need to translate that experience into western alphabets (whose symmetry has mostly lost its root). That experience can create a field effect to regulate the movement of storm systems. You steer the magnetism to fabricate your electrical eco-system. Language is only about learning the symmetry lessons to do that - not the other way around. The experience of lightning - when sustainable - IS information at its essence: CHARGE symmetry. -

**Bliss is the ultimate educator. The symmetry codex (Hebrew and Arabic alphabets) of magnetic domains were merely a way to index access to that. To symbolize is to embed.** ( more: <http://spirals.eternite.com> )

What SHOULD unify science with religion is human DNA's evolution into gravity bending and star inhabiting and ecosystem field effect making. It is what should excite your children about the potential of having been born human on Earth. That leverage our bodies are biologically given to fabricate intense gravity and charge fields to steer our environment flows DIRECTLY from the teachable skill to ignite DNA which is called BLISS / EUPHORIA and PEAK EXPERIENCE. ('Enlightenment'). **This means that the conscientious astrophysicist after due study must answer his 4 year old child truthfully YES - when she asks:**

**“Daddy: when I grow up - am I going to become a star?”**

This course presents new evidence that this phenomenon is measureable and well defined electrically - that all human activity can and should be oriented toward the production of that bliss - CHARGE IMPLOSION RICH WITH BIOLOGICAL INTENT .

( 3 Magazine articles from Dan : POLITICS OF BLISS - at [soulinvitation.com/rainbowserpent](http://soulinvitation.com/rainbowserpent) )

That bliss is:

1. the only source of sustainable immune system  
(spin density in cell membranes comes directly from that charge 'density').
2. the only way to ensoul / ignite DNA - from within - to immortal sustainability..  
with the resulting - ability to lucid dream, die successfully, and time travel,  
and create immune systems in offspring.

Without this, being human on Earth is merely an insult - from the result of an Draco Annunaki family (An, Enki, Enlil .. in Aboriginal: Biki, Snake God and Dolphin God) - doing interventionist genetic engineering to make gold mining slaves. But WITH the possibility of BLISS and star bending gravity making THEN... human DNA based glandular COHERENCE gets to be the UPSTART / the ANTICLIMAX / the FUN PART / THE VACCINATION into the sacredness of EMOTION - FOR THE GALAXY / THE SOLUTION !! of the ORION 'WARS'. (which are much older and galactically important than little Earth alone). Otherwise - it is 'Return of the Borgs / Clones' time. Have you suspecting it is loss to the information access of charge implosion at orgasm which is the death of DOLLY the cloned sheep. Nurses have told me - Doctors are afraid to count the statistics linking autism to artificial insemination. Just like the Vatican didn't tell their tenants their Leukemia was from the Vatican radio tower over them, till after they were evicted.

Try to conceive of the idea of making a field effect (sometimes called 'dream-SPELL') which can move your climate. The vice-like grip of RAPT-ure is based exactly on the word RAPT-or. Massive capacitive charge phase lock FEELS like a vice-like grip. And it can be an information communion of immense kind. That is IF your biology can withstand the amperage / current density.

Resistance prevents information flow - that principle is BOTH electrical and biological / emotional.

We want to emphasize in this course series - that NO particular historical view of DNA is actually required to benefit from the course. We are not selling any particular fairy tale about history. If you like our story about Draco Annunaki from Sirius etc., that can add context to the physics. But for example - if you prefer a particular religious or secular history - to exploring the ET basis of Sumerian - that is really very fine. BUT - what we ARE selling - is a modality for igniting DNA into BLISS / CHARGE DENSITY / PEAK EXPERIENCE / literally ENLIGHTENMENT. That modality IS based on **geometry** which allows charge to become immortal.

# A Child's Guide to the unified field

(Inset - 1 Page Excerpt from "Alphabet of the EarthHeart" - 300 p .pdf at <http://spirals.eternite.com> )

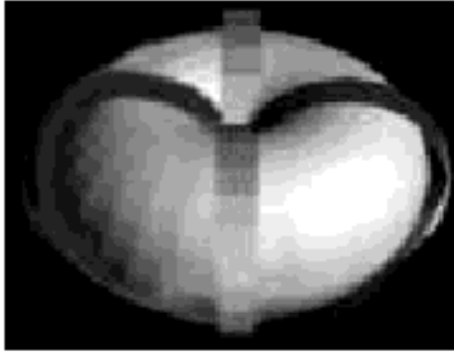

**T**his story is about the original sacred alphabet, the tilted shadows of ONE donut! This basic pattern for nesting donuts may be THE perfect pattern to help us remember EVERYTHING!

Let me explain why.

When you are young you see that there is so much to learn (or re-member) about how the world is glued together. You might well begin to ask yourself: "how am I going to re-member everything about this complicated world in order to be powerful (and useful), here?"

Someone tells you that there is something called "physics" and "chemistry." These are big books full of rules about how you glue this stuff called "matter" together in order to make stuff like "people" and "toys" and other important things. Now these supposedly wiser older people are getting ready to tell you that you must learn (re-member) all this stuff about matter that's contained in these very thick books.

Instead of trying to remember everything in the thick books called "physics" and "chemistry" you may wish to try a more direct way to understand stuff. What you and I should probably ask is: "isn't there some IDEA or PRINCIPLE which is a rule or pattern which we can apply to make every thing in all the thick books?" A principle is a basic rule or pattern or idea which you apply to ALL other puzzles or problems.

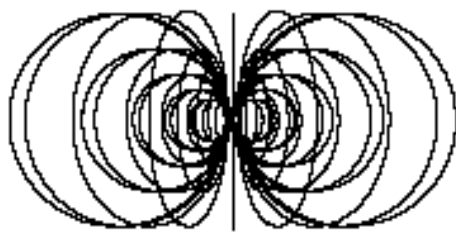
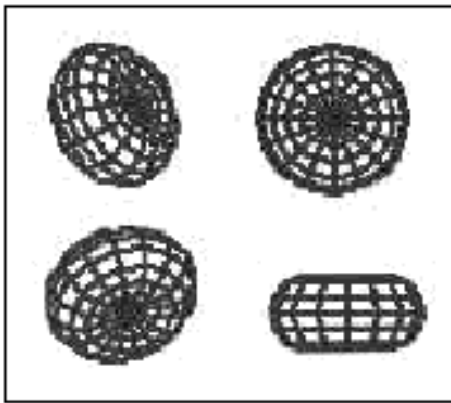

Well good, since we have got that figured out, now what we need is to find that FIRST principle from which ALL other principles or ideas or rules are made. Where do you suppose would be the best place to look for the first rule or pattern?

Well where is the most important idea in the most important book around?

Probably you guessed that the most important book is the Torah or Bible, and if you did, you're right!

Now, if you wanted to put a most important thing in a book, where would YOU put it?

Probably you guessed: "in the beginning of the book." And if you did you're right again!

So good, that part was easy.

We just take the first part of the most important book and there will be our basic pattern for EVERY-thing. We learn that pattern and everything else we need to know can be built from that first little principle.

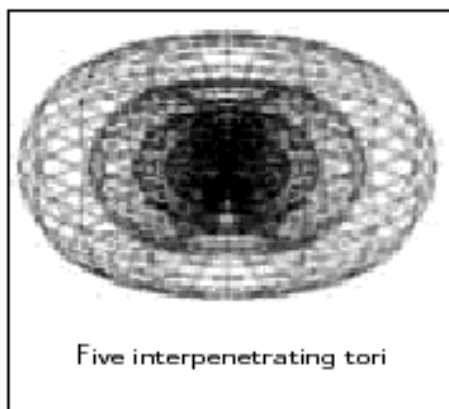

Five interpenetrating tori

The 'history of DNA' is really only useful in so far as the part of the 'big picture' - PURE PRINCIPLES emerge. Where did the urge to ensoul genepools with commercially valuable skill to bend gravity corridors come from? (Dune's 'Guild Navigators' in reality for example) - Where did the plot originally come from not to TELL your kids that not only COULD they eventually make enough fusion gravity furnace inside their bodily biophysics - to BECOME a star - but it was the only way to survive.

**The skill to make gravity originates with the teachable skill to realize that you CAN persuade waves to agree. The 'force be with you' that welds that wave convergence lies in the fractal secret of how YOU control your heart's electrification.** The HeartTuner biofeedback system is an excellent tool for teaching this- HEART COHERENCE. ( heartcoherence.com ). The electrically measurable force of WILL which it takes to cause wave coherence to increase in your EKG (heart) (so nicely measured on HeartTuner's cepstrum waterfall plot)- is the absolute beginning of the gravity physics of fusion ('charge gone 'fractal' - centerpiece of this course to follow). The reason HeartTuner makes kinesiology measurable is because muscle strength varies with the COHERENCE - of the nervous command to it (which comes from your heart). If as so many claim - that kinesiology (muscle testing) tests pure intention- than what must Heart COHERENCE measure?

To observe this phenomenon for yourself - place your attention intensely in your baby finger. Check to see if it begins to tingle. The FEELING that results there is caused by a build up of capacitive charge - whose SYMMETRY of charge RADIANCE is the essence of all real healing. That charge build up - in turn - began because your attention's density of focus initiated phase alignment among capacitive waves sparking at the nervous synapse - at the place YOU chose. Your attention resulted in the creation of an ELECTRICAL field - exactly where YOU put it. As you build the will and coherence of this force - you will bend storms and stars to your will - by loving ('embedding') them.

If you follow this material - it will soon begin to make sense to you - that that FIELD effect called FEELING - IS the ability to feel charge and magnetism: "The Wind Upon Which Love Travels". Tribal Shamans, Ancient Navigators, .. and Birds steer - angels steer - and YOU steer in dreams and at death - IF you can FEEL and align yourself by magnetic line.

The IMPLOSION info - below - should begin to convince you that under the clear conditions of SELF-SIMILARITY ('fractality' that looks like a rose or an onion- or nested Russian dolls) - THAT field effect gets a CENTER OF GRAVITY. This is called learning to turn inside out - again and again - until there is a wind GOING INTO THE CENTER - called GRAVITY. The gravity of this situation is - that YOU made it.

Biological structures like DNA - and your heart's wiring for electrification - (like pine cones and eggs) - are fractal or self-similar enough to attract charge continuously like a gravity making and gravity harnessing motor. This gets to the **heart** of our course..

You are not required to become scientists, physicists or electricians - to follow the course - or follow the course of your own bliss. HOWEVER - once you DO have lightning sticking it's delicious burn up your own tailbone - only YOU can know how to steer - so as not to be toasted. The steering skill - is only the symmetry skill to know HOW waves can agree. First to spit out- is every emotion you ever stored without compressing it to what is sustainable - SHAREABLE. This process of EMOTIONAL COLLAPSE (into oneness /fusion) is like discovering if you can remember ALL your peak emotions AT ONE MOMENT. This intensity - discovers what is shareable among all of them. The discovery of which waves CAN be propagated in this way is what physics calls 'PHASE DISCIPLINE' or COHERENCE. ( Co - here - and SEE!)

This is like the test for what's shareable - that comes with the solar compression wave called SOLAR MAXIMA. ("rapture" in obsolete religious language). As we said many times- the sun does not WANT to toast most of the viable DNA of Earth, but compression is the only way to incubate that portion of the genepool which MAY be able to be saved. Compression tests for what is shareable (produces pure intention - something physics calls WAVE COHERENCE ) - by ensuring that only self-similar ('scale invariant' like a squeezable rose) structure survives. Get COMPRESSIBLE or get DEAD - that is the lesson. Scale -invariance (fractality)

among waves produces infinite CON-structive (not destructive) COMPRESSIBILITY - because - (as the visuals below will illustrate ) that wave repeated wave interference PRODUCES acceleration. (of charge labeled: gravity ).

Once you get the 'gravity' of your situation - you may choose to grab the tornado by the tail and steer it for yourself. (Other wise- it is a privilege to be assimilated ' - join the borg.) Taking responsibility for the tornado that is your field - begins with taking responsibility for your own state of bliss. The reason is that bliss is the name we have given FOR this ability to attract enough CHARGE to cause tornados. (Which begin with simply noticing who has a twinkle of CHARGE in their eyes.)

The course culminates in lessons about making charge density - literally BLISS - sustainable in your life. This includes USING Sacred Geometry (symmetry which attracts CHARGE -the definition of life and awareness) in order to learn - how to select life force in :

- a) what you eat
- b) who you hug (Tantra based on charge)
- c) where you live and work - the FENG SHUI to make bliss possible (based on 'fractal' charge symmetry
- d) kinesthetics of bliss (yoga, sacred dance, gurdjieff gymnastics, Eurhythmy etc.)
- e) vision quest , rites of passage, shamanic 'soul' group bliss process

The 'homework' assignment for this class is real. The test - is whether you can die successfully. This is as easy as entering a lucid dream. The test is whether symmetry (braid) discipline allows your biological memory to be compressed non-destructively in a way that produces acceleration. The way the beauty of perfect nesting and charge enter your DNA and glands - is with hygiene to embed yourself in charge - with the resulting BLISS. This makes you and your memory able to distribute as a wave - become shareable / sustainable / immortal.

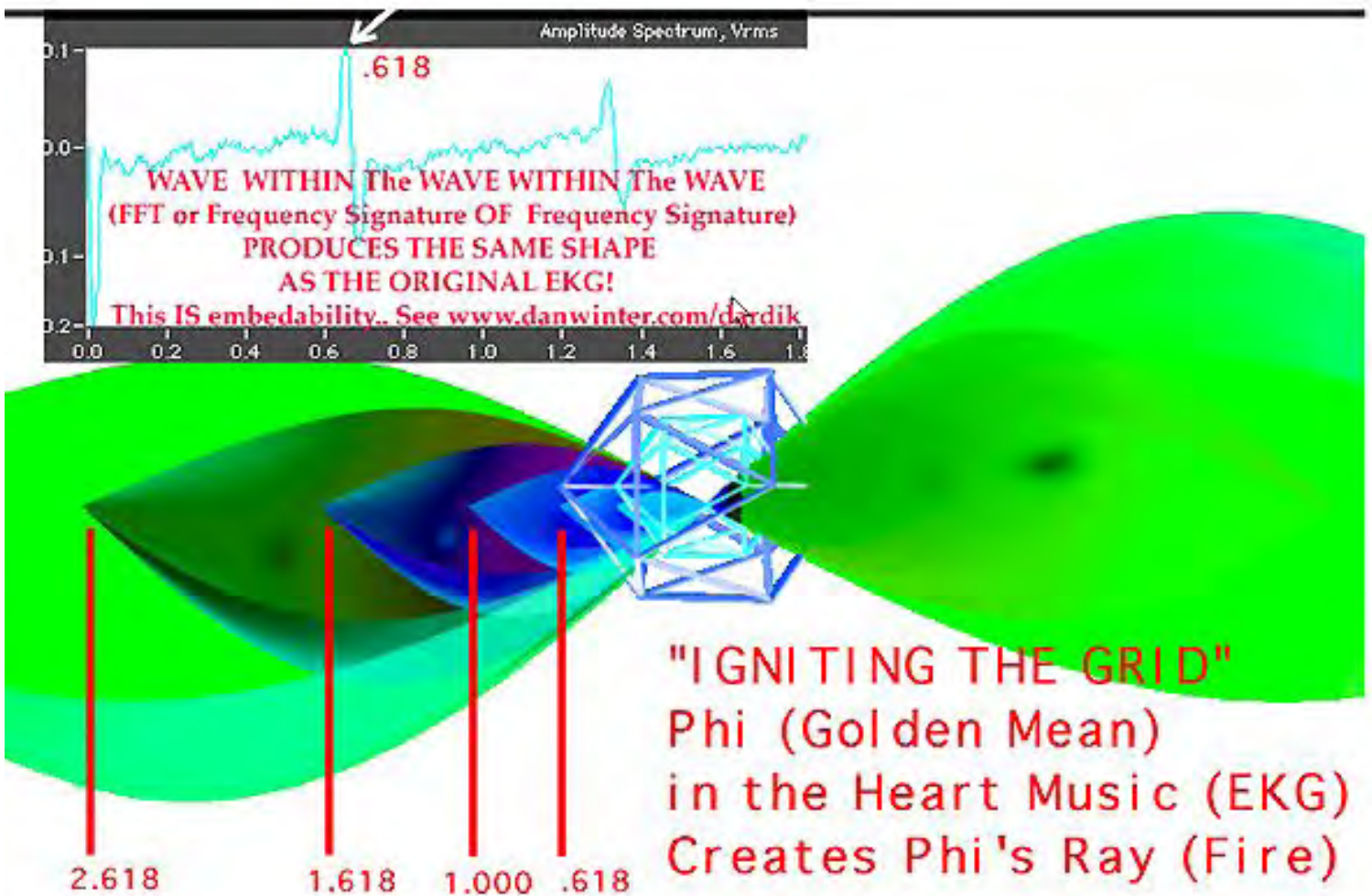



**The first part of the Certificate Course offers** participants a step-by-step curriculum that serves as an initiation - into unified field thinking - where the role of the conscious mind is empowered to steer waves - of which the whole universe is made.

Reminder - the issue is not to prove anything spiritual to some unbelieving physicist (a really unrewarding task). The issue is to achieve a powerfully practical working understanding HOW the 'Highward Fire' Raising of The SHEM (shem-AN) - Sword from Stone - could enable you to call forth the lightning. This is called -the raising of the DJED - which makes you the DJEDAI.

The waves of the universe made of CHARGE respond to your bidding, when you learn to EMBED yourself in the PSYCHO-physics of what makes them shareable and sustainable. Essentially this form of coherence will become our clue to pure intention expressed among waves. If you make a 'fractal' self-similar inner magnetic picture - you WILL draw forth the clouds to your bidding. What used to be ceremonial magic - is now simple physics. Implosions ability to steer waves is as simple as how the low pressure zone steered a weather front. Low pressure is creating where waves 'dimple and implode' as you will see. The test for pure intention is something nature achieves because power IS compression - (as any data analyst can tell you) - and compression ONLY sustains the SHAREABLE.

### Section ONE:

**.Introduction to Unified Field Thinking -** *Learn to think in 'jello' - something squeezable connects us!*  
From the Mind of Einstein to the Role of Oneness ('Monotheism) in World Religions we celebrate an end to the Schizophrenia which considers spirit as somehow different from the Spin Density / Charge Compression or Inertia Stored - by which Physics defines MATTER. When enough waves converge at one point- that is called AWARENESS. The geometry of what allows an infinite number of waves to AGREE to share one point - is symmetry discipline culminating in an 'implosive fractal' - about which this course is centered.

1. **Universal Compressible Ether:** The Universe is made of one substance. It is compressible like 'jello' or smoke rings. The trick to store a moving wave of compression and 'rarefaction' (de-compression)

**This Universal Medium or 'Ether'**  
**is a Compressible Fluid Like Substance**  
**Which By Storing 'INERTIA' ..Like Waves in Jello**  
**- Becomes - Electrons, Photons, Atoms, Molecules,**  
**People, Galaxies etc...**



is how inertia gets stored and thus is mass / matter created. The pattern of the way waves pass that inertia has only one shape: - the **Sine Wave**. (The Fourier principle).

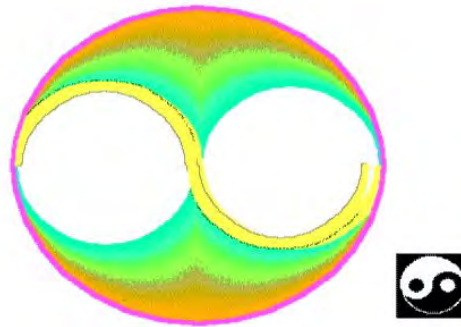

Thus the universe has both only one substance (call it ether if you like) AND only one shape. This is the essence of the unified field - and is key to you beginning to grasp how to pull the threads of that squishy substance (electrical 'CHARGE') thru you like a water wheel - storing more and more of it's inertia - until you bend stars. This ability to create suction in this universal compressible medium is the real secret of implosion of charge - and is key to gravity and the role mind among waves. To create mind among waves - it is merely necessary to create a still point. Still points however are only stable - when the pattern of waves around them begin to look fractal like a rose. **Mind is a name for the biological skill to gently persuade waves to EMBED in that rose.**

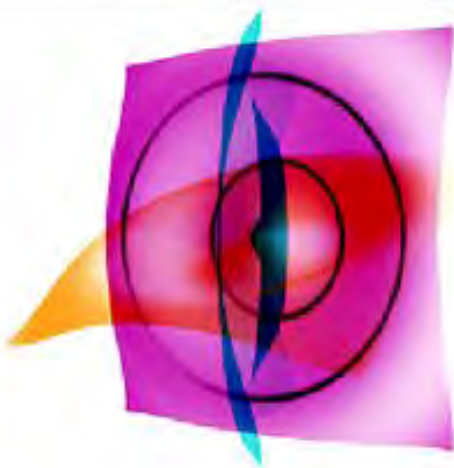

**C**ompression waves ARE creation mechanics



*Visualizing Spin:  
The Number of "Dimensions"  
IS  
The Number of Axis of Symmetry  
/ Spins Which can be Superposed.*

*As Compression Waves  
Approach Symmetry  
Their Info Density Converges  
Here image the Sun responding  
With the 'orgasmic' Solar Maxima  
(~2005-2012)  
As the Galactic vs. Solar vs. Earth  
Equators nutate toward perpendicular..  
See "Erection of the Solar Cross"*

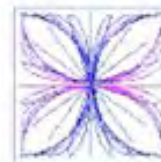

**Visualizing Spin**  
The number of dimensions  
is the number of spins superposed

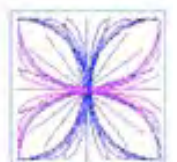
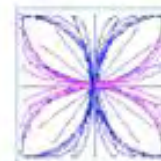

2. **Origin of PLUS versus MINUS CHARGE (Magnetism):** How to make friends with MAGNETISM and how to make your own Sacred Space? The relationship of Compression (packing the squishy universal substance) to Rarefaction (unpacking it) is the secret to the Physics of Plus and Minus CHARGE. This also describes the wave mechanics for the ancient ideas of Yin and Yang. See the picture for a summary : (Note in this picture - Roger Green school -merely invert the place of the word Yin versus YANG ). It is important to have a clear and precise way of thinking how charge moves - (a rigorous language of precision) later when bliss becomes so intense that it feels like lightning is moving up your spine. Then you need to know about symmetry - or the lightning will create heat - and destroy you. You will feel the heat as destructive interference - and begin to make the connection between psychological resistance - electrical resistance - and THAT WHICH HAS NOT BEEN SORTED INTO THE SHAREABLE (wave symmetry which can propagate infinitely).

**Magnetic Polarity: Essence of Flow Direction.. Converging/Diverging Flux Lines**

**Understanding the Biological effects of Magnetism as a simple twister flowing either inward or outward**

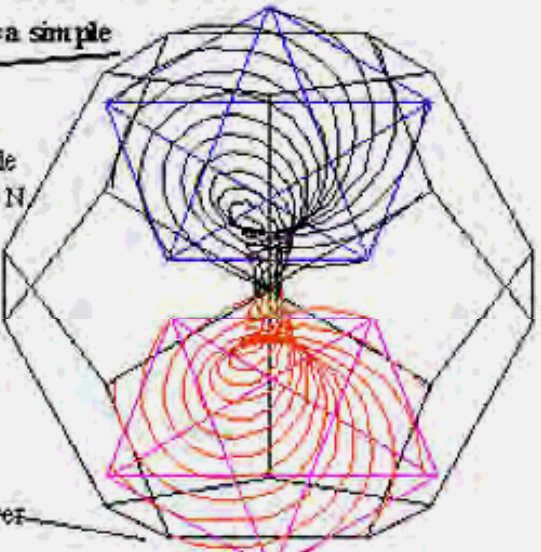
	<p>Bio-Magnetic North          Attracted to South Pole          Conventional Magnitic S.          Outward Folding Flux          Yin          Centrifugal          Unpacking          Negative          Counterclockwise          Blue Making Power          Wet Making Power          Touch Making Power          Pentacle Upright          Cooling          Swatika Left          Ieve/Word Making Power          Unpacks the Hard          folde dness of Cancer          (Cancer IS          Contact Inhibition          The failure to respond to          touch)          Reduces:          Pain,          Infection          Swelling          Hemorrhaging          Moves H+ ions          out of infected area.</p>	<p>Bio-Magnetic South          Attracted to North Pole          Conventional Magnitic N.          Inward Folding Flux          Yang          Centripedal          Packing          Positive          Clockwise          Red Making Power          Hard Making Power          Separate Making Power          Pentacle Inverted          Warming          Swastika Right          Adamic/A tonic Making          Packs the Wet Unfoldedne          Stimulates Thyruus..</p>	
---	---	---	---

**Magnetic Polarity Visualized Is Psychokinesis Learned**

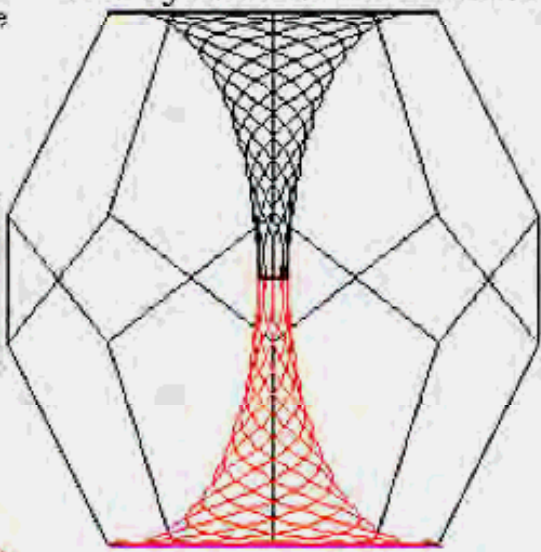

Field Effects 'Suck' on one end more than the other, because the one vortex throat of the tornado is more CENTRIPEDAL - inward folding - while the other is more CENTRIFUGAL - outward folding. This is key to many things - Yang vs Yin, Magnetic Negative vs Positive, Red vs Blue .. etc.

*Try the SOUTH -red/ heating pole of a magnet on a wound - pain INCREASES but so may healing rate.. a strong NORTH end of the same magnet may diffuse pain by divergent flux - but also decrease healing rate.*

3. **Origin of DONUTS (all fields and all things are made of torus shaped 'domains')**. The natural way for a wave to stand is in a tornado. Once these tornado's (vortex) learn to stand on each other's heads and balance - you get DONUTS. the 7 color donut map. In the study of the science of fluids - it is claimed that the only self-organizing shape (in a unified field) would be this torus donut - the shape of all magnetic domains and field effects. (Essentially everything in physics is made of these.) You can prove that everything made of donut torus shapes if you agree with physics that everything breaks down into simple SINE WAVES. Once you see that, merely revolve that sine wave around it's center into 3D- and presto - that is your donut. See how there is a tornado - a twister - a vortex PAIR at the heart of every donut field.

### The 7 Coloforus Donut Kit:

*Roll "Over the Rainbow... Connexion"*

*as the tube torus donut  
turns 7 colors inside out  
in your own hands!*

(accompanying video & book recommend)

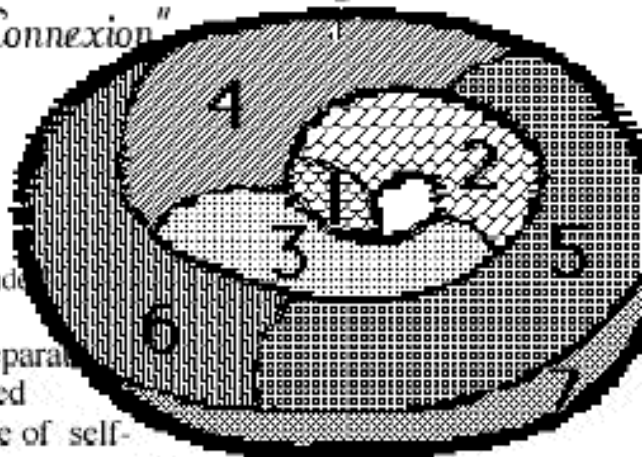

Particle (part-I-call) physics can separate us from the creative power of focused imagination. By seeing the principle of self-organizing flow in the universe, we can grok that it is mind as focus which holds together / to center the vortex donuts which build matter

Try visualizing exactly how the universe is self-organizing In a "unified field" (One Substance) world, only one shape can self stand as waveThe donut shape knows how to nourish and feed itself.



First, eddy's in the flow → resolve to vortex pairs, because shape is the only thing a unified field has to store as memory. This shape is the only one which "waves constantly to find structure" Re-member in turning to tie a slip (k)not on the finger of inside out.

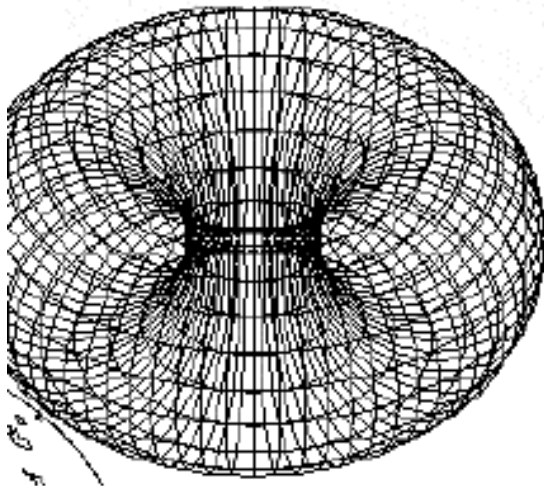
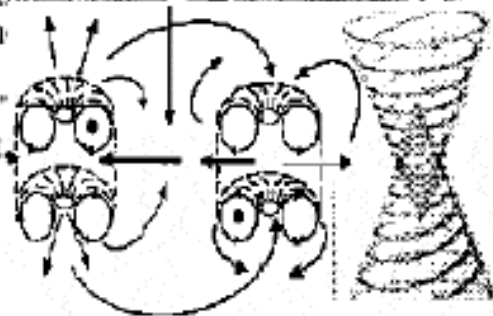

Classical "Hydrodynamic" (pressure&flow) physics tells us that only the vortex.....pair, torus donut can exist in a container having only One substance in it. "Shape inspired to self-remember".

The COMPRESSIBILITY of this Universal Substance  
Causes Waves to Form ..

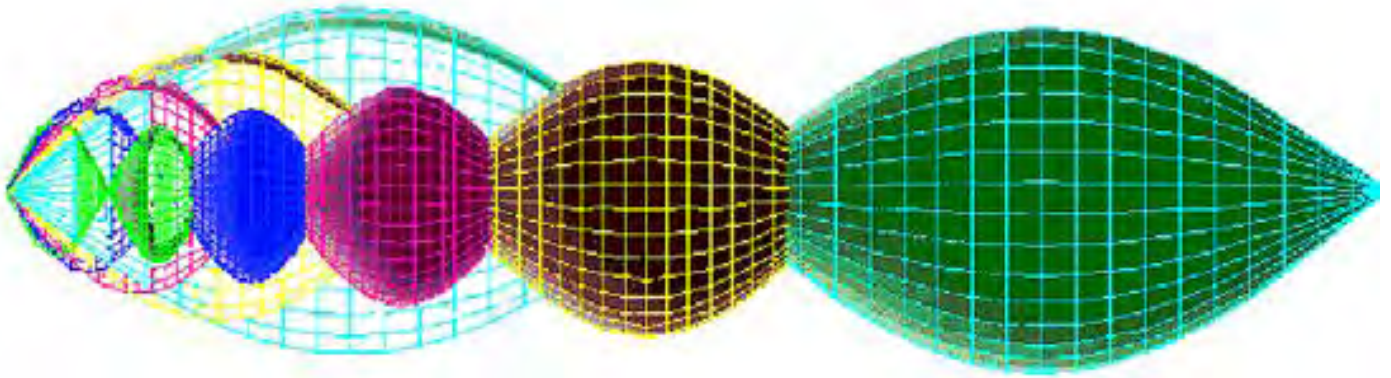

*Notice - when waves converge in Golden Mean Ratio ...  
Things 'appear' to COME TO A HEAD ... (left)  
they say...*

*We have made our point!*

*Perception - is the electrical process of creating and  
accessing the information density localized when  
CHARGE makes a point.. (Implosion).*

Sine Waves Revolve  
to become donuts...  
Sine Waves as 3D Donuts  
are the 'Toroidal' Vortex  
Or Wormhole or  
String Nature  
of Physics Today

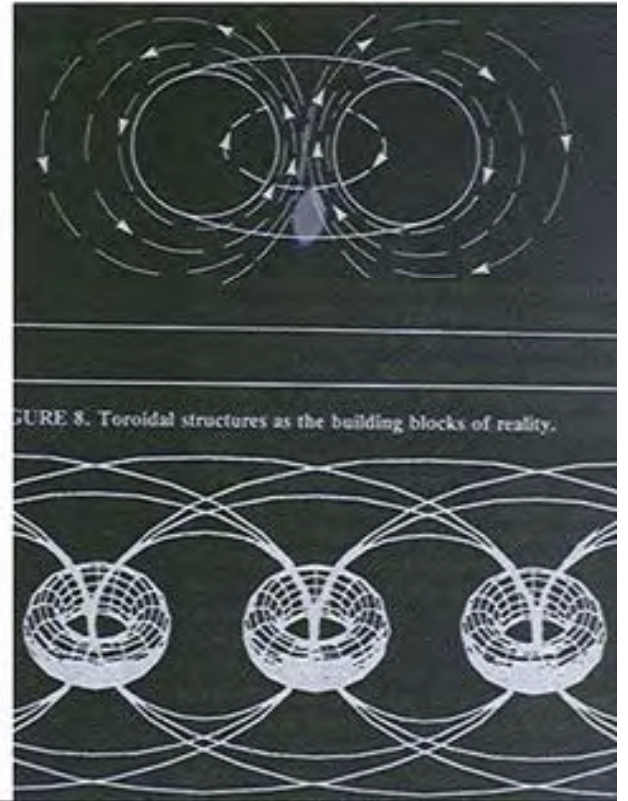
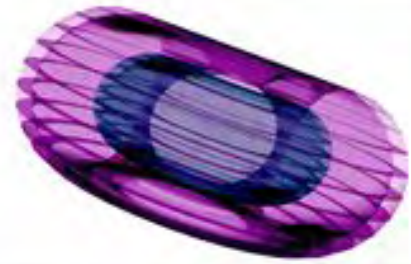
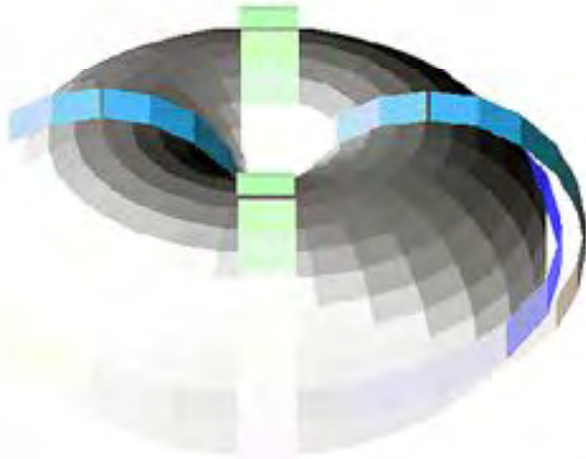

Physics IS nothing but wormholes

*Looking at the intimate connection between wormholes  
and string theory versus*

*a song line / dreaming track*

- *and the inserting of coherent emotion*
- *Shamanically which CON-CENTERS them..*

*You see now why:*

*'Unless "The DreamSpell" of the Old Ones..  
is Alive and Awake in Symmetry Space..*

*Ea's Earth will be Blown Away..*

*In the Magnetic Wind of the Sun!'*

“Standing Waves”..

Waves Arrange Themselves  
Into Nested Geometries..  
Here triggered by  
(sine waves) of sound.

In 3 D These nests  
become the Atomic Table...  
As we'll see in a minute..

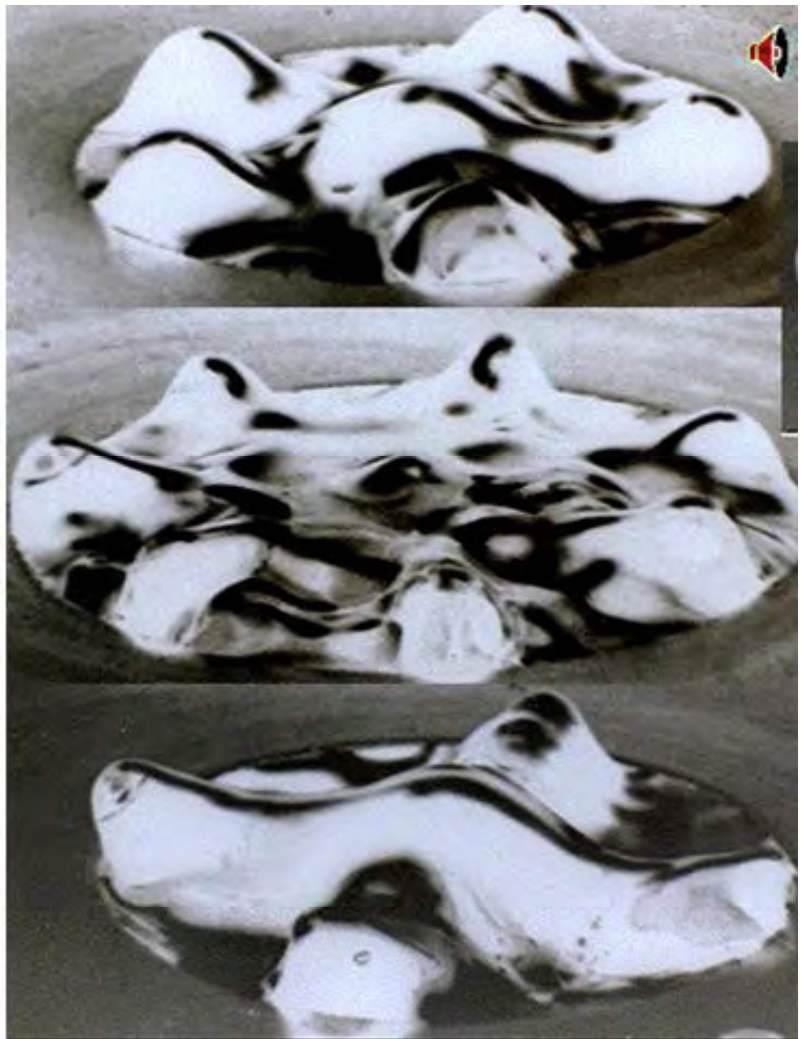

4. **Origin of GEOMETRY.** Notice that if you tilt these little tornado vortex ‘wormholes’ - into the symmetry angles of the PLATONIC SOLIDS (tetrahedron / 4 face, octahedron / 8 face , cube / 6 face , dodecahedron / 12 face, icosahedron 20 face) the result IS the atomic table. Cooking up the atomic table is as simple as the recipes for nesting donut shapes into the Sacred Geometry of the platonic solids. The ‘SACRED’ geometry of these platonic shapes - are self-organizing because the waves which make up these tornado vortex into the atomic table - would cancel each other out - if they tried to nest any other way.

This information is a good introduction to a chemistry class - where the teacher ALSO wanted you to understand how MIND and CONSCIOUSNESS can steer chemical reactions. Remember the word CHEMistry comes from ALCHEMY. And the CHEM sound in there - means FROM THE BLACKNESS - or FROM THE BLACK HOLE. So chemistry and alchemy are ultimately about the implosion tornado wave shapes that can make the little **black** holes - happen - called matter.

Physics 'String' Theory , and Wormholes is identical not only with the Aboriginal Songline - but with the specific unifying understanding that no physicist today can conceive of a world made of anything but the torus / vortex pair. Introduction to TORNADO THINKING.

Creation and Quantum Mechanics  
 Seems to be about the  
 Symmetry tilt operations  
 Necessary to non-destructively nest  
 Vortex into symmetry pairs...

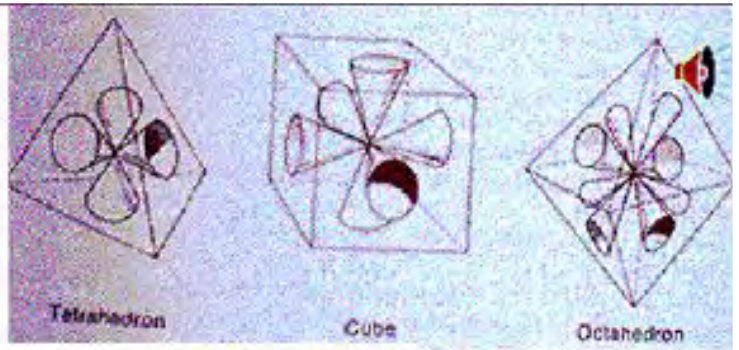

*"Tetra-Vortex"  
 the world is made  
 Of waves:  
 Then  
 Platonic Solids  
 Are Names  
 For Vortex  
 Which Find  
 The Symmetry to  
 stand on each  
 Others heads?*

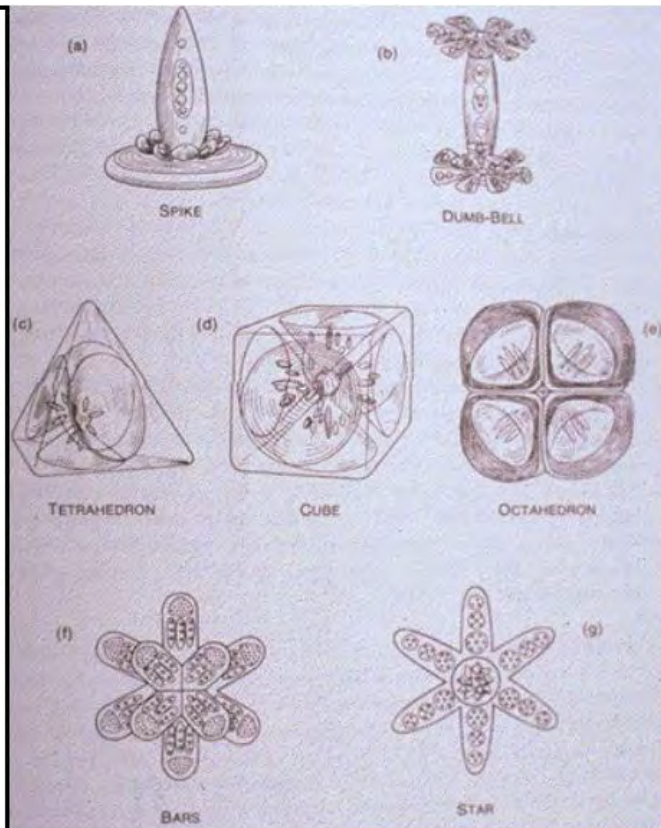

**Clairvoyance of Babbitt, & Theosophical "Occult Chemistry" Later justified in quantum physk (Phillips), showed Tetra /**

**Cube  
 Octa  
 &  
 Icos / Dodec**



**Seeing the  
 Atomic Table...  
 -alive-**



**Clairvoyants  
 see atoms as  
 platonic nests  
 of vortex**



It Angle Among Fields, Translates the Alphabet of Symmetry, into The Atomic Table.. of The Periodic Law (after Crooks)  
 The shape known as valency, is the platonic solid field nesting of the electron shells, which determines bond (phase) angles..creative symmetry among  
 "Geometric Factors in Nuclear Structure" Lawrence Hecht, Fusion Magazine, "Occult Chemistry" Leadbeater/Besant, "PsiPerception Quarks" Phillips(



ooking Up Matter is A "Matter" of Focusing Donuts In to Nest.. Which True Alphabet Teaches

Valence II or VI, Tetrahedra  
 Oxygen, Calcium, Chromium

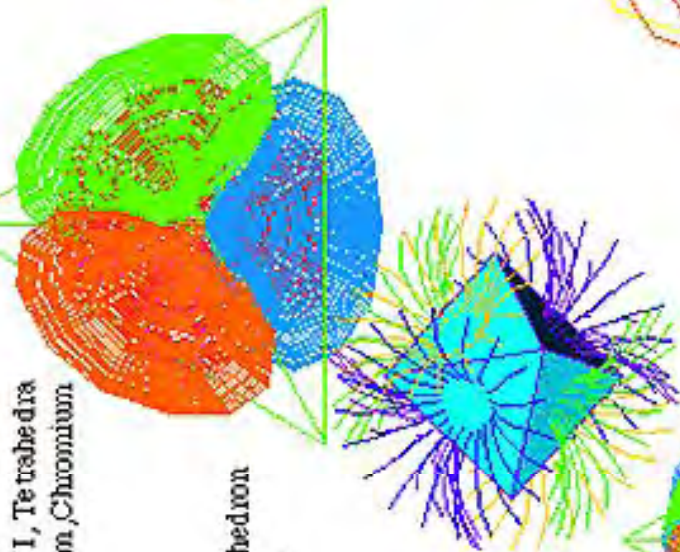

Valence IV, Octahedron  
 Carbon, Silicon..

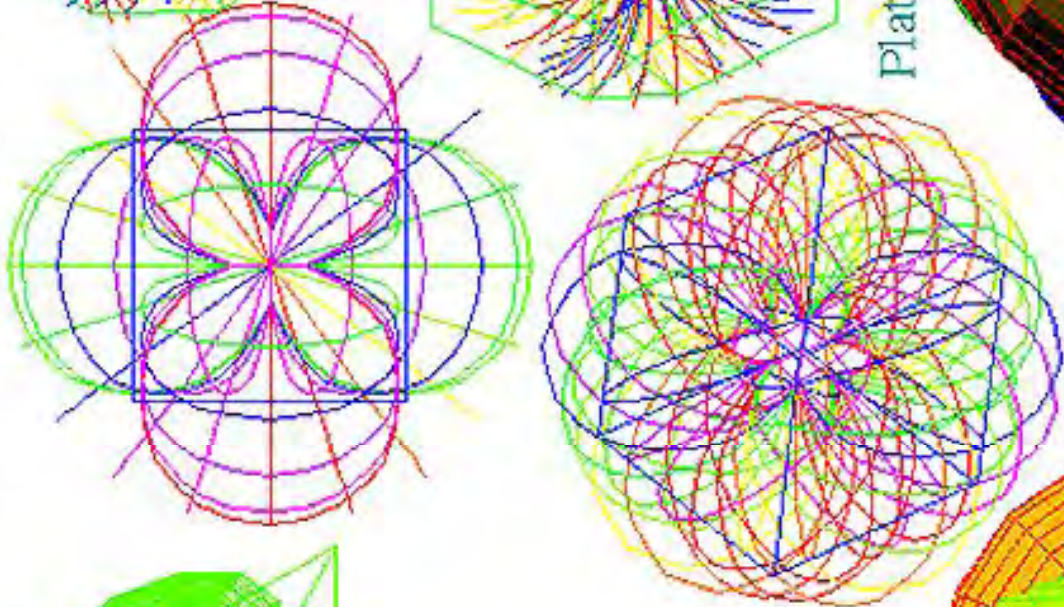

Valence 0 Icos/dodecahedron  
 Helium, Neon, Argon

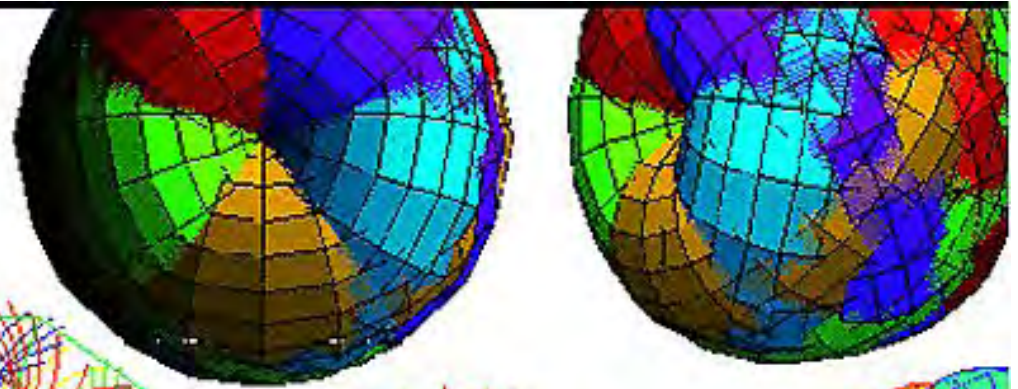
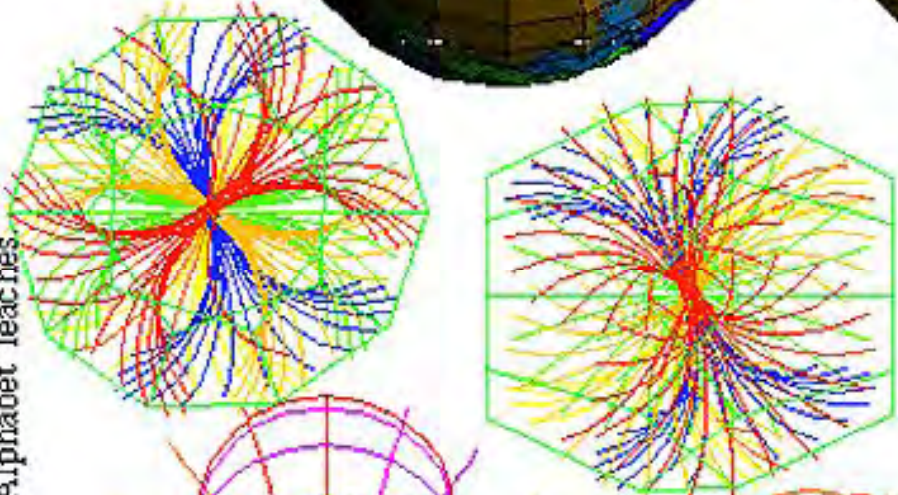

Platonic atomics



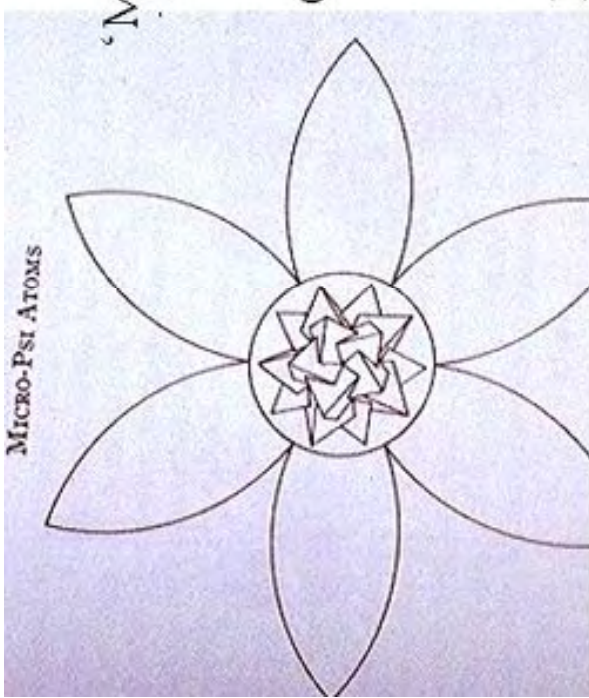

Cymatic  
 'Macrodynamic'  
 Wave-Form  
 Shadows  
 Compared to  
 Atomic  
 Table:  
 "Platonic"  
 Lemniscate"

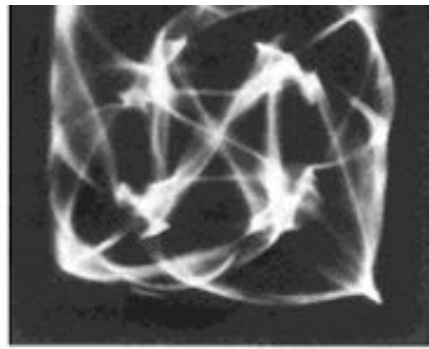
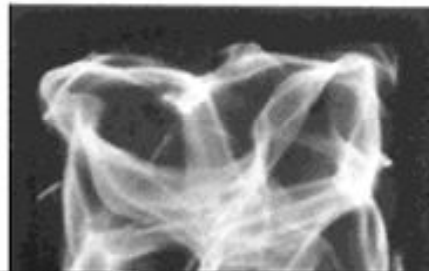
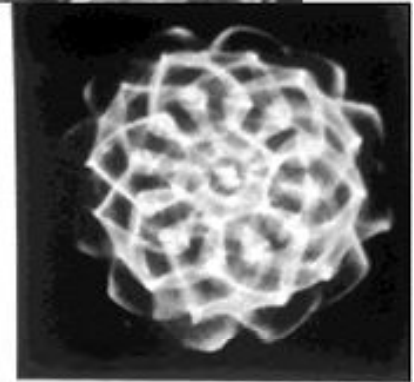
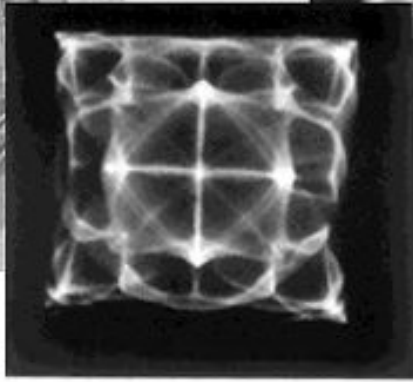
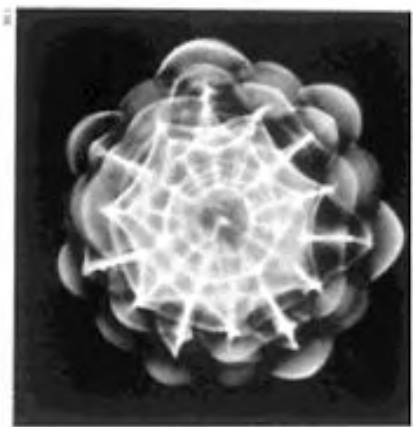
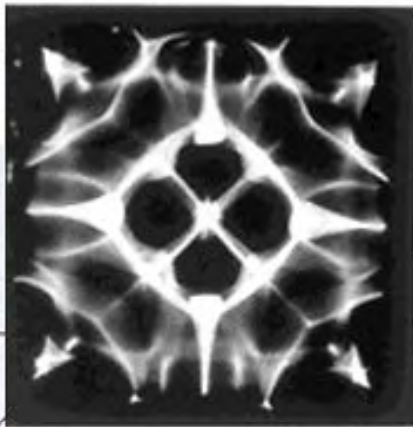
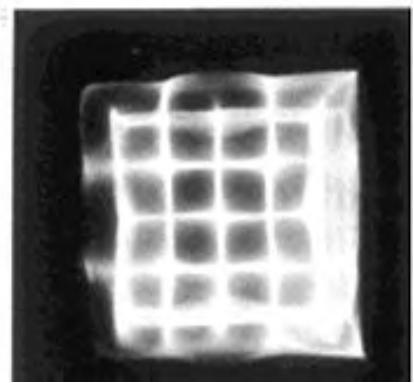
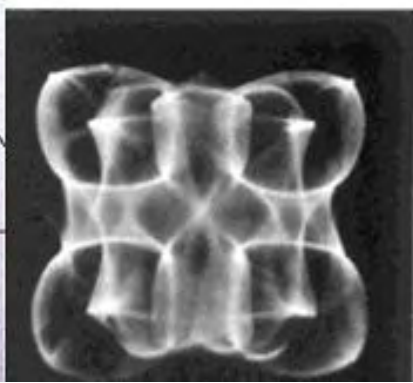
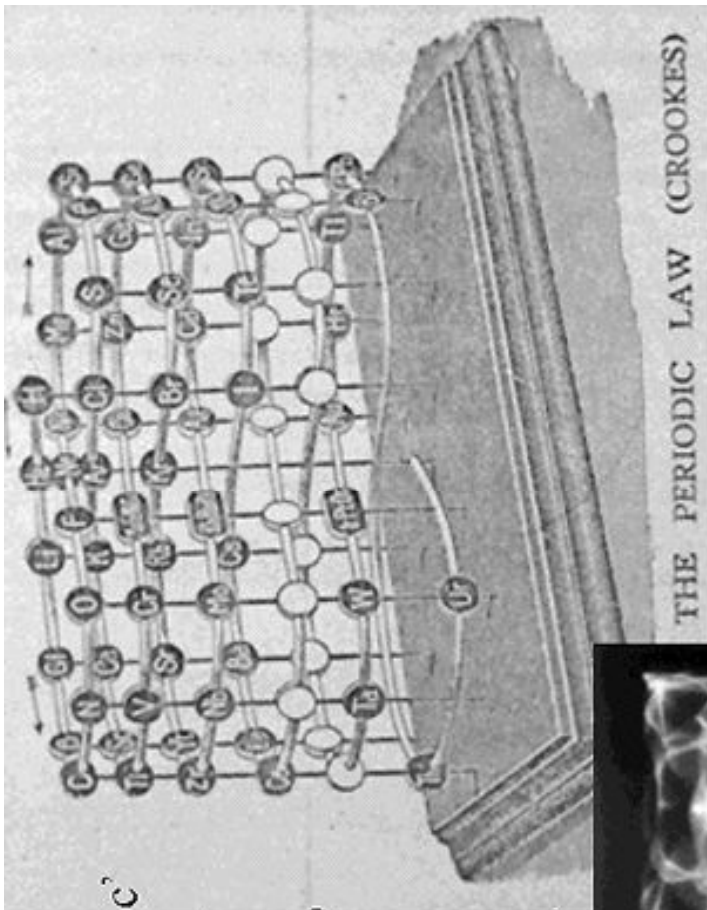

Like all waves, photons travel as donuts (toroids). When they arrive at a 'traffic jam'..  
 The refractive angle of a prism... forced by SQUEEZING to SHARE one 'lane' -  
 they sort themselves into the 7 spin tilts which can occupy the same space..  
 7 spin symmetries of the tetrahedron.. Then those 3D tilt angles of the photon  
 SORTED BY COMPRESSION are called the 7 colors of the rainbow..



See  
 white  
 Where  
 they  
 Superpose..  
 (White Light  
 Is ALL  
 Tilts  
 / phase angles  
 / colors.)

Rainbow / origin color from the sorting caused by toroid photons  
 self organizing by compression into the 7 tilts of the tetra

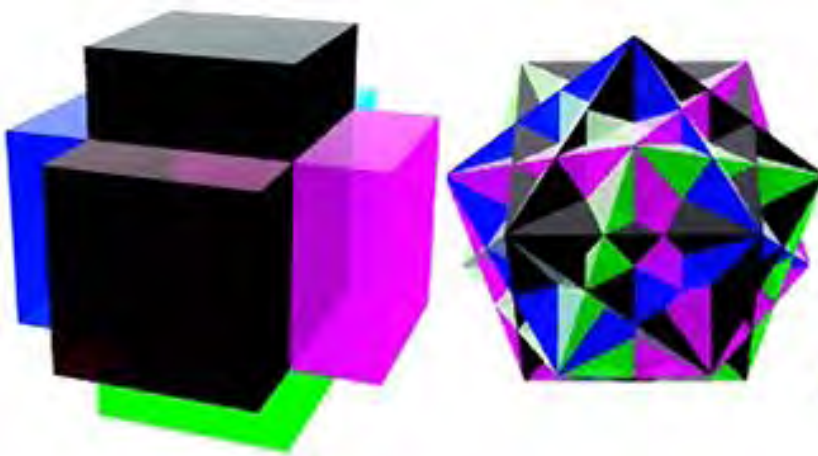

7 Cubes  
 (6 around 1 in center)  
 or "Spins"  
 Outside..  
 Compressed into  
 5 Cubes or "Spins"  
 Inside : Dodecahedron.

2 red Tetrahedron  
 Nest, 1 green Octahedron..  
 Into Yellow Cube..  
 Light Blue Dodecahedron..  
 & Dark Blue Icosahedron



ICOSA

The REASON that the perfect SLIP-KNOT ANU / Hydrogen / Human Heart and SUNS Heart has seven spins outside and 5 spins inside - (see ANU pic on P\_\_\_\_\_) (reference the Ophanim Sigil of Truth AND the Cherokee map of Sacred Space) is because 7 spins outside (7 arrows of the tetra and the heart) is CONTAINMENT (IN-CUBE-ATION)

while 5 spins inside ( 5 spins of cube in dodecahedron) is PROJECTIVE.

Projector inside, Container outside - It's a marriage made in heaven - may it SLIP- (K)NOT!

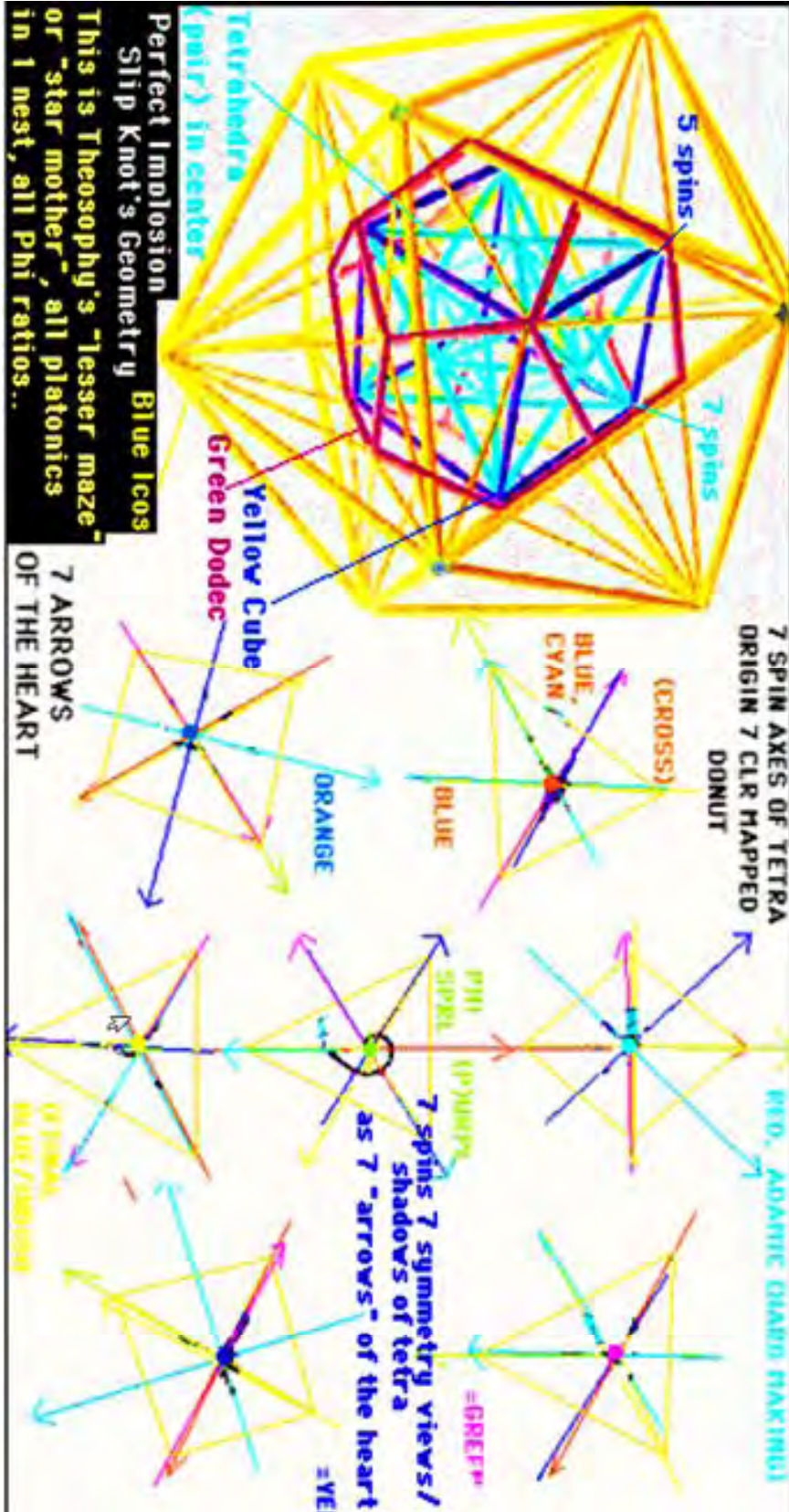

7 Spins Outside ( 7 Spin Symmetries of Tetra)  
5 Spins Inside.. ( 5 Cubes in Dodecahedron) ..  
In a minute we will see this become  
The "ANU" Perfect "Slip Knot" ... Clue to the Heart Vortex...



5. **Origin of SACRED or DIVINE Proportions:** The world is made up of waves which 'nest' in 'sacred' (meaning sustainable) proportions.

-Assignment - (Course Material from Michael Rice insert) Lesson in drawing sacred proportions using paper- pen and ruler/calculator.

Draw and derive - Pi, The ratio of the Octave, 3/4/5 versus Golden Ratio Triangle. Draw spiraling squares then rectangles - then pentagrams - all derived from the Golden Mean Spiral - these pictures suggest the start...

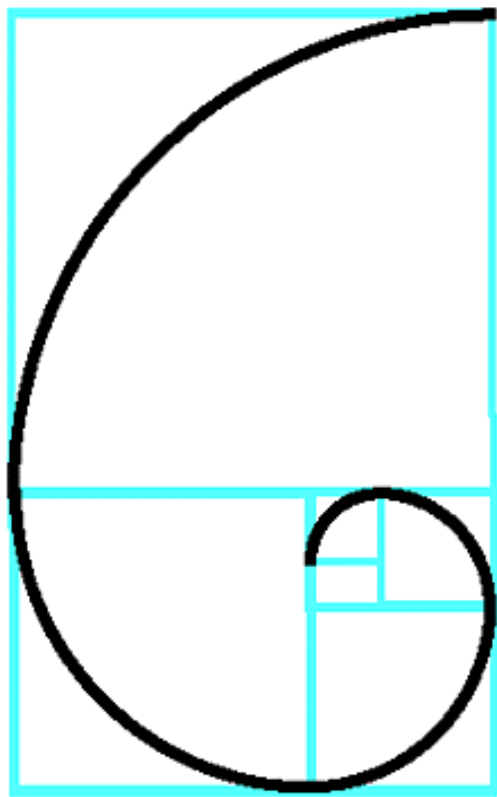
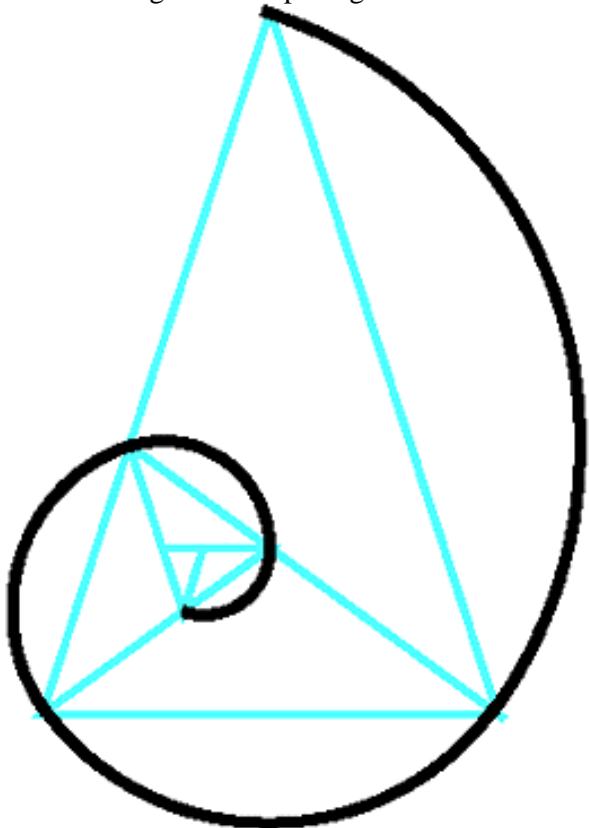

Why is SELF-REFERENCE or SELF-SIMILARITY -  
As the ability to SELF-REFER - the definition of Self-Awareness  
In many traditions... (Depak Chopra... vedic, etc.).

Spiral triangles & self reference

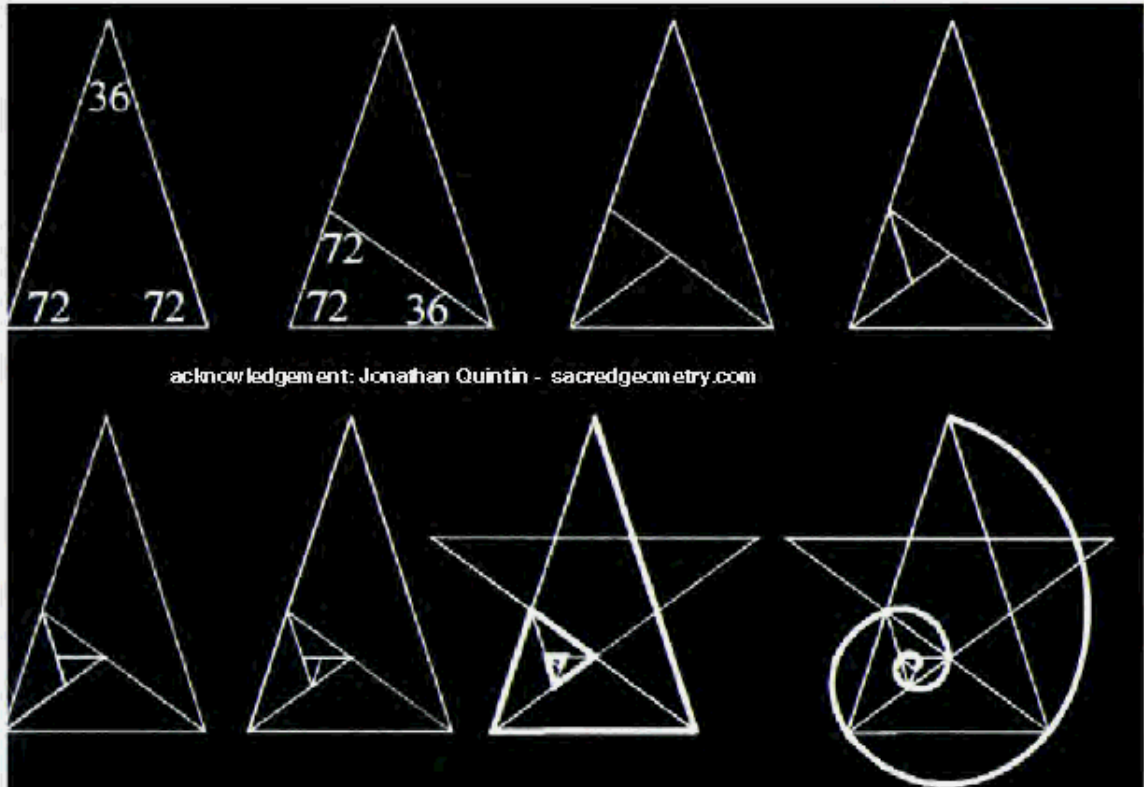

acknowledgement: Jonathan Quintin - sacredgeometry.com



Notice that as waves cross each other repeatedly, they discover how to do that in the way to create the MOST CONSTRUCTIVE INTERFERENCE... and the LEAST DESTRUCTIVE INTERFERENCE. This discovery of the perfect way to SHARE SPACE for plants is called PHYLOTAXIS - and is BASED on the Golden Mean Ratio. This allows the plant leaves MAXIMUM EXPOSURE, MINIMUM SUPERPOSITION - which is simply: THE BEST WAY TO SHARE THE LIGHT.

successive pairs of numbers in the Fibonacci sequence. These ratios and their decimal approximations are shown below. The ratios approach the ratio of the Greek golden rectangle: 1.61803 to 1.

$\frac{1}{1} = 1.0000$	$\frac{2}{1} = 2.0000$
$\frac{3}{2} = 1.5000$	$\frac{5}{3} = 1.6667$
$\frac{8}{5} = 1.6000$	$\frac{13}{8} = 1.6250$
$\frac{21}{13} = 1.6154$	$\frac{34}{21} = 1.6190$
$\frac{55}{34} = 1.6176$	$\frac{89}{55} = 1.6182$
$\frac{144}{89} = 1.6180$	$\frac{233}{144} = 1.6181$

Fibonacci Progresses To Golden Mean Ratio (Phi) "Phi-Bon-a Key!"

Phylotaxis



The green plant is the visible part of a spiraling energy field.

Fig. 12.5. Sneezewort (*Achillea ptarmica*)

Extension

The number of petals on flowers will vary according to the kind of flower and not every flower of a particular species is identical. The arrangement of leaves on a plant will usually produce two Fibonacci numbers: (1) the number of leaves it takes to go (rotating about the stem) from any given leaf to the next one "similarly placed" (above it and in the same direction) on the stem; and (2) the number of revolutions as one follows the leaves in going from one leaf to another one "similarly placed."

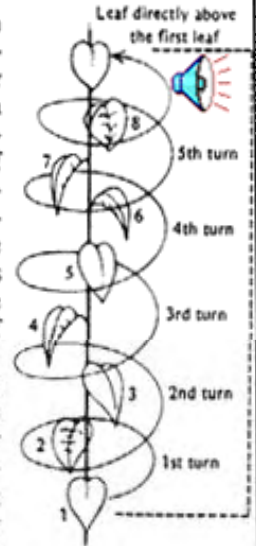

The figure at the right shows this leaf arrangement.

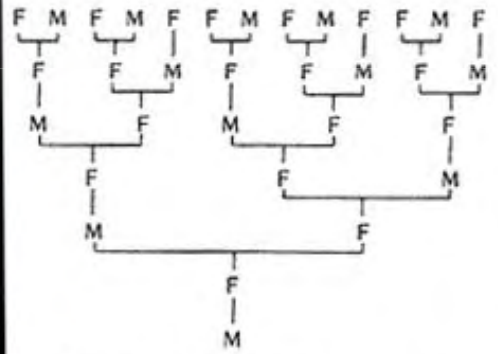

The family tree of a male bee

This perfect branching based on Golden Ratio - discovered by plants as the perfect way to UNPACK - is also the Sacred Geometry solution to perfect PACKING. Einstein did not realize that infinite NON-destructive compression for CHARGE - could be solved among capacitors in exactly this way to make gravity from charge. (More on IMPLOSION below). Waves are drawn to FOCUS and automatically sort themselves and agree to sustain via Sacred Geometry. They align to still points, creating 'CHARGE', 'Stasis', 'ecstasy', 'tingle', 'pure intention' and LIFEFORCE. More on this as we develop the idea of IMPLOSION.. below.

6. Quantum mechanics is just a name for waves which perfectly meet themselves coming back on themselves - creating symmetry and geometry. - Standing wave NODES are created this way, and that is the origin of matter itself. When the length of a wave divides evenly into the circumference of the circle the wave is going in - that IS Quantum Mechanics ..( Discontinuity from Continuity - by others 'Catastrophy Theory') - and by others "Sacred Geometry'. The symmetry of the phases of these waves is nothing other than literally music itself. Try putting your finger on a guitar string. By choosing the still point, you choose the music! This is the implosive still point making role of MIND AMONG WAVES!

### 7. What IS a Fractal Attractor? -

Fractals provide a wave 'massage' path for form, shape, and vibration into higher and higher evolving patterns - an encoded thread linking larger spirals into smaller spirals and on to infinity. Examples of natural shapes which tend to be fractal or 'self-similar'. Self-similarity means the inner structure has the same pattern as the outer structure. So for example a pine cone, or a fern tree, or a pineal gland - have a shape that - even in 3D - you could begin zooming down into center - and still ALWAYS be seeing the same thing! Think of the classic

Russian Dolls -



where they all are shaped so that the

whole family of dolls - fit perfectly one inside the other. (An onion is another example of a potentially 3D fractal).

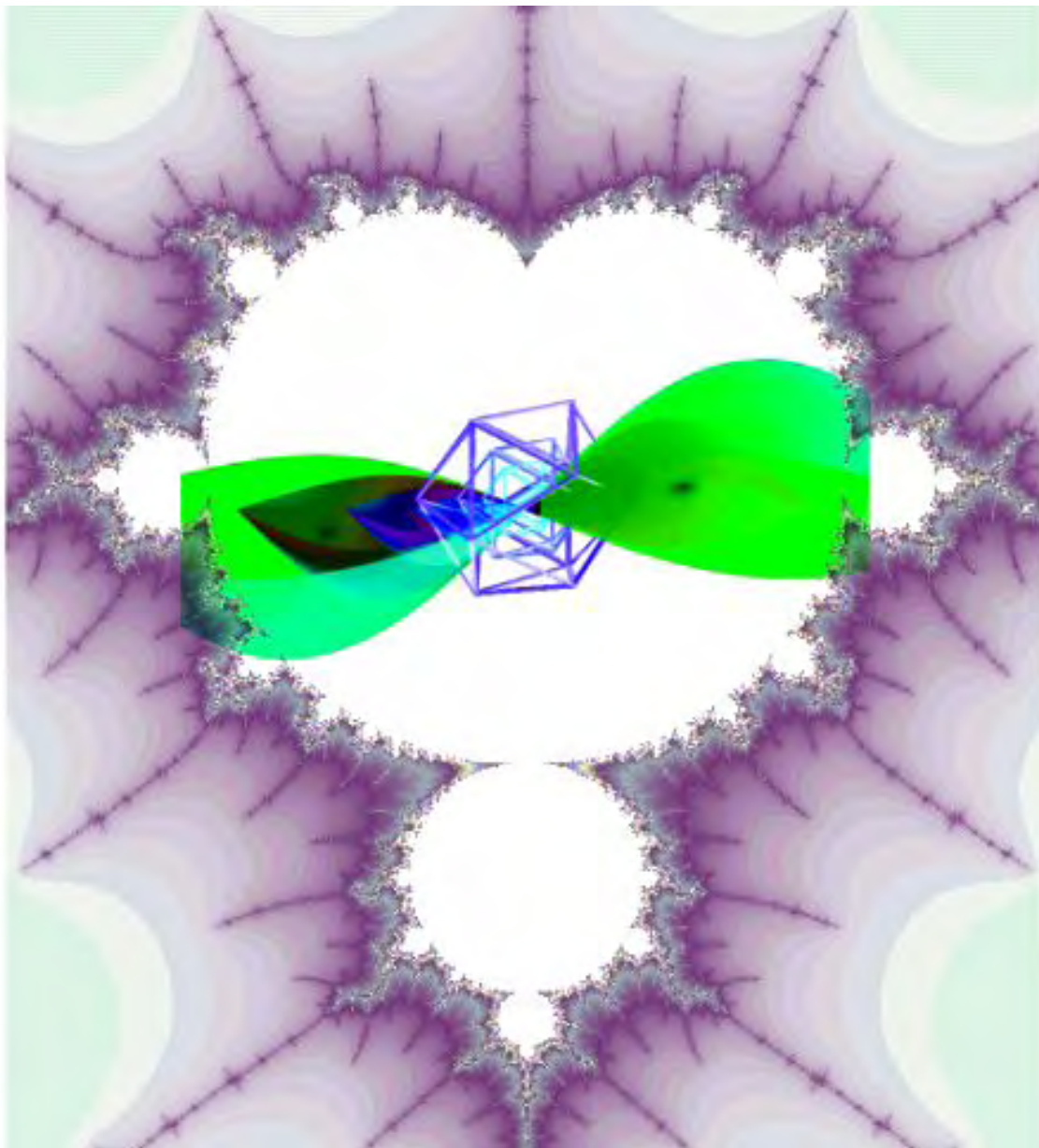

The essential REASON why shapes which are FRACTAL - create ATTRACTION - is important to you for spiritual and psychological reasons - in ways not even suspected by most mathematicians. If you ask someone into math why a fractal attracts - he will say that some pattern of waves - tend to always return to the same center - even after different excursions away from that center. The mathematics of the 'self-centering' pattern - the mathematician calls an ATTRACTOR (because the wave always seems to be ATTRACTED back to ONE place - from which to restart). This is one of the most beautiful areas of mathematics.

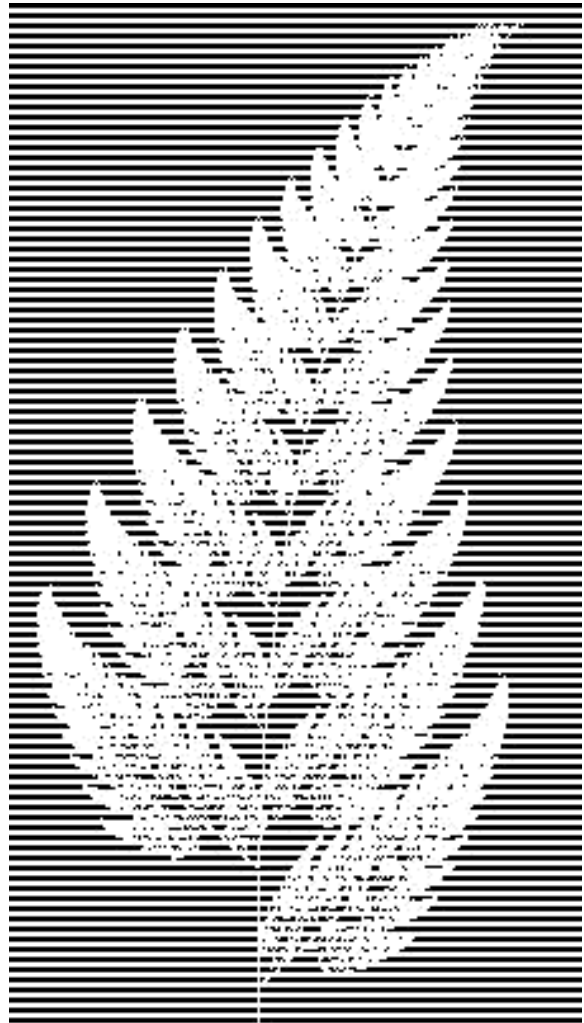
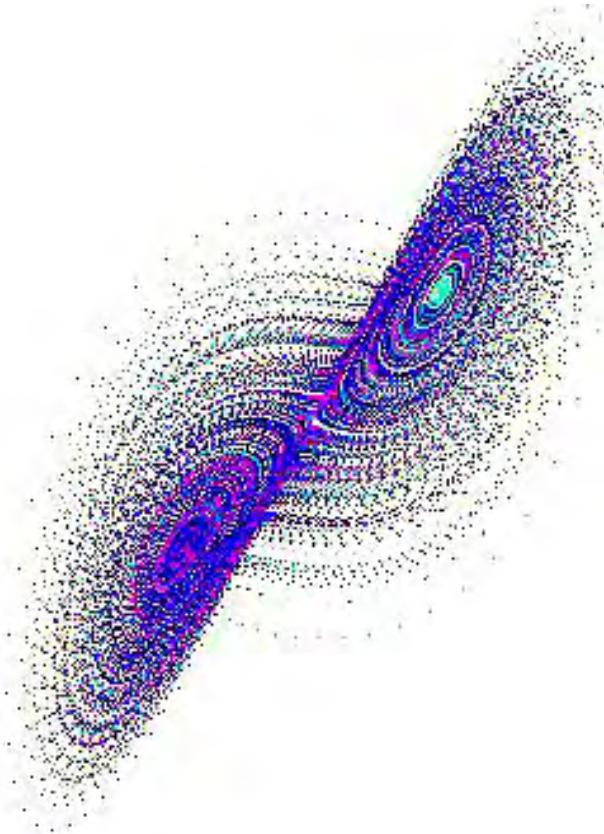

For understanding the nature of consciousness and gravity - this becomes a clue to even deeper reasons why **fractal shapes - made out of (electrical) CHARGE - create attraction.**

Remember - in a technical sense - for physicists - EVERYTHING is made only out of CHARGE. Matter or mass for example are names scientists have given merely to the phenomenon that

**WHEN CHARGE-ENTERS CONCENTRIC ROTATION & IS THEREBY COMPRESSED - it then tends to RESIST CHANGE OF POSITION** (it doesn't want to be 'pushed around').

This resistance to being pushed- is labeled **INERTIA - and is the only definition or measurement science has ever had for matter or mass.**

So 'God' the creator is the person who teaches waves to store inertia. How simple could it be..



To store inertia you merely need to teach a wave to go in a circle - because then it becomes a little gyroscope / spinning top. This is the only way to create inertia. This process is called quantum mechanics. (Seeing what symmetry will allow waves to go in circles). The thing that physicists and scientists are too klutzy to understand yet - but you must in order to be spiritual - is that **it is the invitation to COMPRESS called FRACTALITY (or self-similarity) among waves of charge -**

**Summarizing Here the PURE PRINCIPLES WHICH EXTEND FROM HUMAN FOCUS LEARNING TO ALIGN WAVES IN 'PERFECT' TOUCH:**

**The Heart EKG Voltages LEARN Bliss - The Result of Perfect Compassion / Compression without Pain..**

**Perfect Implosion = Inner PHire / Fire**

Golden Ratio  
Vortex Implodes  
by Self Similarity / Embedding

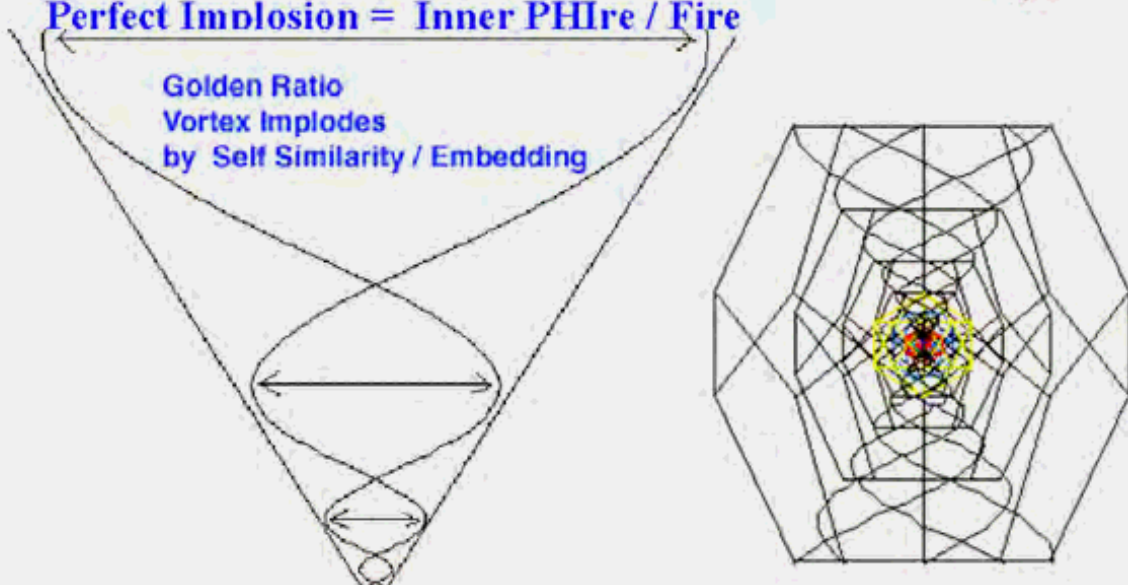

**To be Self- Similar (Fractal) , Feeling Inside the Same as What is Felt Outside = Able to Self - Refer = Able to Self - Embed = Able to be Self - Aware !**

**WHICH CAUSES...**

**8. THE CENTERING FORCE OF GRAVITY AT THE CENTER WHICH KEEPS THE LITTLE WAVE TORNADO STANDING STILL.** Why is fractality key to BOTH gravity and creating consciousness? **'Keeping the little tornado centered inside of the bigger tornado - the implosive - self-centering force generating - electrical role of MIND among WAVES.**

This is the essence of the role of mind among waves- to persuade waves to agree - to compress - and thus create the centering force. This will explain the role of coherent emotion in keeping 'song lines' or 'dreaming tracks' aligned and placed on the land. The relationship between 'dream spell' and magnetic COHERENCE is intimate.



The “Centering Force” which self-reference, self awareness adds  
 Is that which holds the little tornado centered inside the bigger one..  
 The relationship between consciousness and that which fabricates gravity  
 Is intimate.

9. **Coherence is the difference between a flashlight and a laser.** Coherence is when ALL the soldiers marching across the bridge are in step. Coherence is when the difference harmonics within a complex wave (like your heart beat) are musically ‘locked’ into phase. This is called ‘phase discipline’. Co-Here-And-See = Coherency!  
 Coherence at any level is (ultimately) coherence at every level.  
 When waves share space in coherence, perception is possible. HeartTuner measures EKG (Heart) Coherence - to teach EMOTIONAL COHERENCE & PASSION!

**Fractality - or self-similarity is the ultimate or limit or perfected state of coherence** - for it is the only way waves of an infinite number of DIFFERENT wave lengths (harmonic diversity or inclusiveness) can all be locked together.

Heart COHERENCE../ Emotional COHERENCE - Measured .using HeartTuner ( [heartcoherence.com](http://heartcoherence.com) )

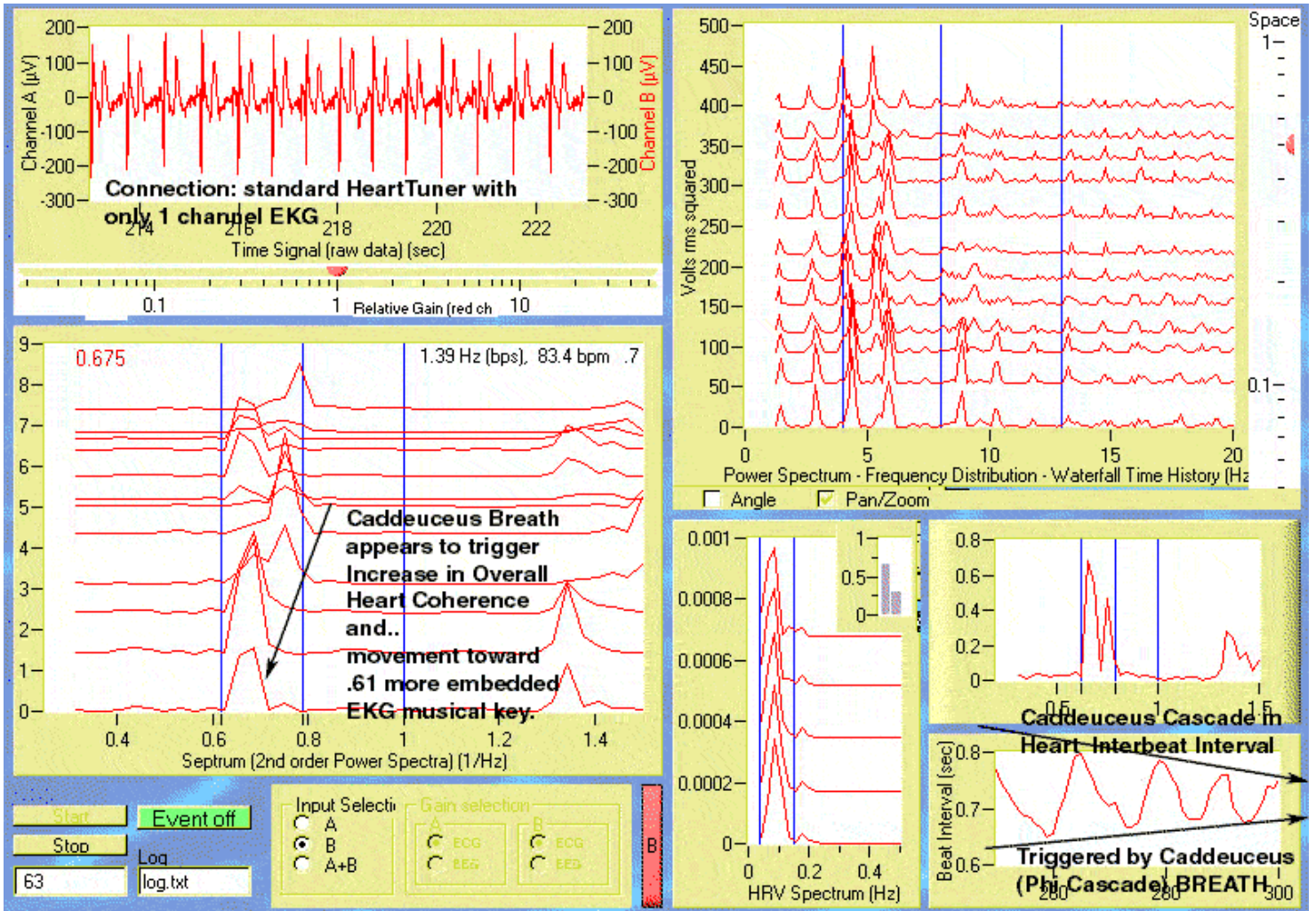

HeartTuner (heartcoherence.com) measures Heart Coherence in the lower left graph both top and bottom. The cepstrum is a 2nd order power spectra. Below - we see heart coherence (black) phase match brain coherence (red). Internal coherence had not before been measured. Emotional coherence is teachable as a result.

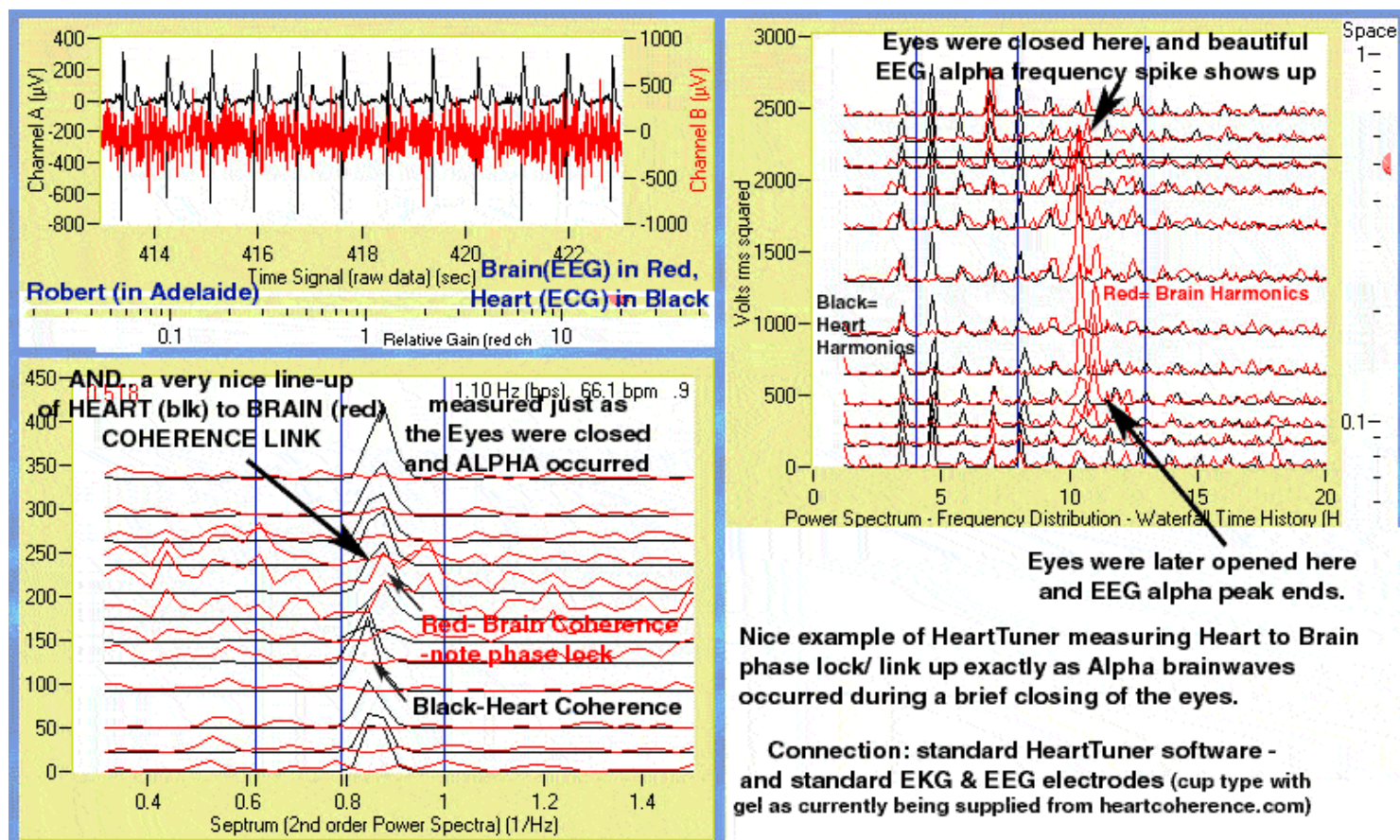

10. **Golden Mean Ratio** (.618, 1.0, 1.618..., 2.618... ...) is the ultimate state of fractality or self-similarity because it defines the state of “inside that looks like the outside”. (Does this begin to sound like COMPASSION to you?).

The Golden Mean Ratio or “Sacred Cut” is so named precisely because after you cut the line at .618, the little part is in relation to the big part - exactly as the big part is in relation to the whole line... etc. So altho you are divided - you are still connected.

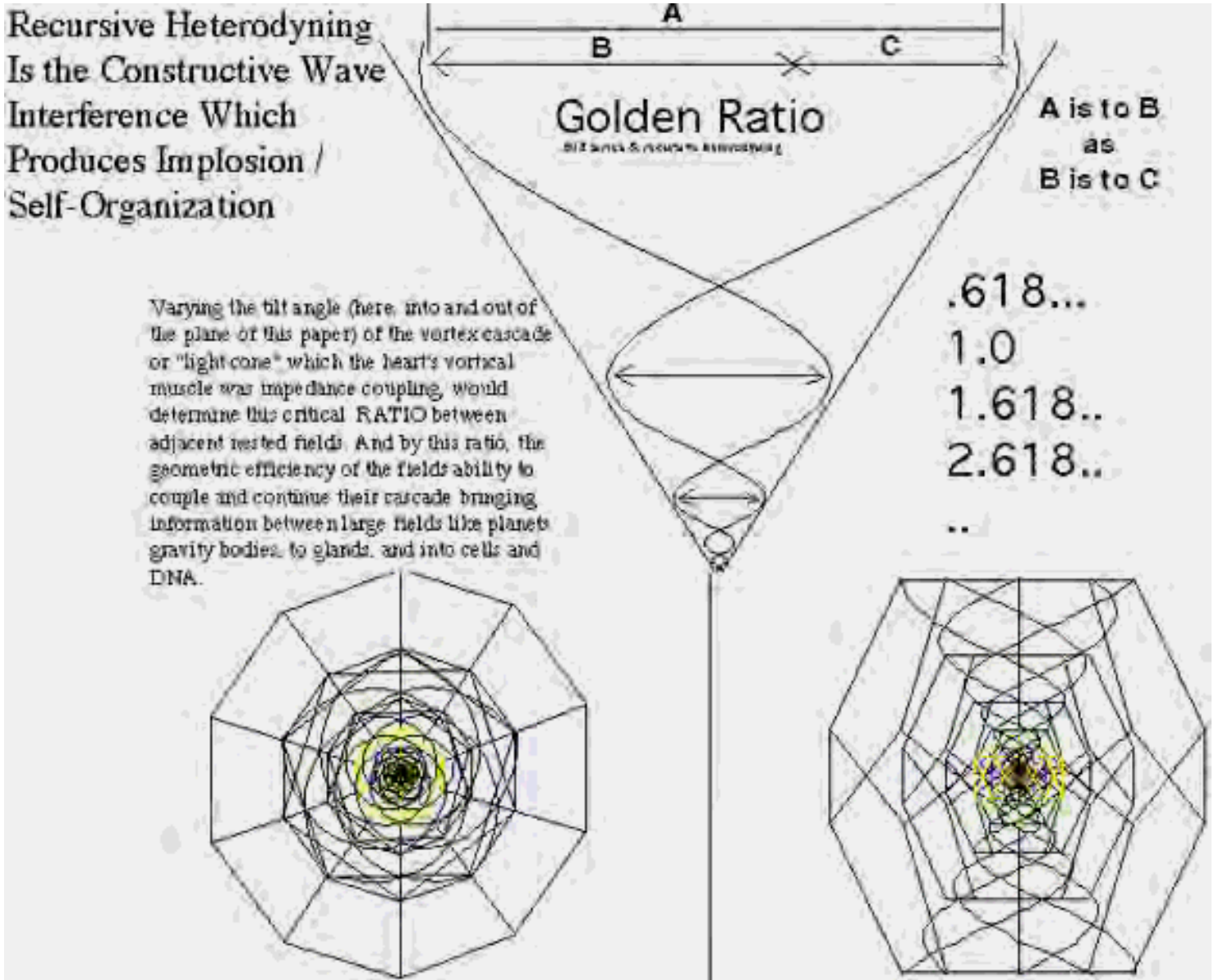

This creates a (Golden Mean) spiral - which is the only equi-angular curve - in which a wave can re-enter ITSELF - without hurting itself. This skill for a wave to ‘eat it’s own tail’ - is called ‘self-re-entry’. This is a kind of picture of perfecting ‘recursion’. (Recursive-ness means something happens inside itself - inside itself- etc... - like in computer programming sometimes.) . **Light, when folded back on itself, comes to know itself.**

# Implosion Exists Because In The Geometry of "SELF SIMILARITY"

- It is Possible for a Wave to Re-Enter ITSELF - Non-Destructively.

Ability to SELF-REFER

is the Vedic definition of CONSCIOUSNESS.



The GOLDEN MEAN  
SPIRAL  
Is Self-Similarity  
Perfected  
For Wave Mechanics

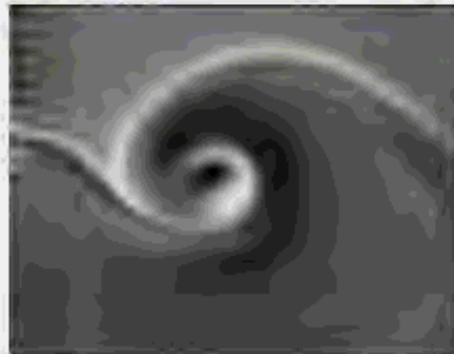

In Hydrodynamics- This is called:  
"Optimized Translation of Vorticity"

It means - this is the only way for Inertia in a line to be "translated into a circle". Since the inertia created by waves in rotation is the ONLY definition for MASS - this translation is by definition the perfect path from MASS to ENERGY. **Later we use Spectrum Analysis to Measure This**

Golden Mean Spiral is Equi-Angular-  
Means Angular Relationship of the 'First Bounce'  
recurs In-Phi-Knit-ly. Allowing perfecting of SCALE INVARIANCE-  
Wave Guide for Galaxies to Send Messages to Atoms..

Angels to People...

Self-re-entry is the VEDIC definition of CONSCIOUSNESS - for good reason.

We are going to describe the details of how this FRACTAL ATTRACTION TO CENTER - becomes something called IMPLOSION - in detail below. So to make inertia storage stable - only getting fractal works! (For example the amount of mass in a gold atom is high because it's electron wave pattern is more SELF-SIMILAR with it's nucleus.)

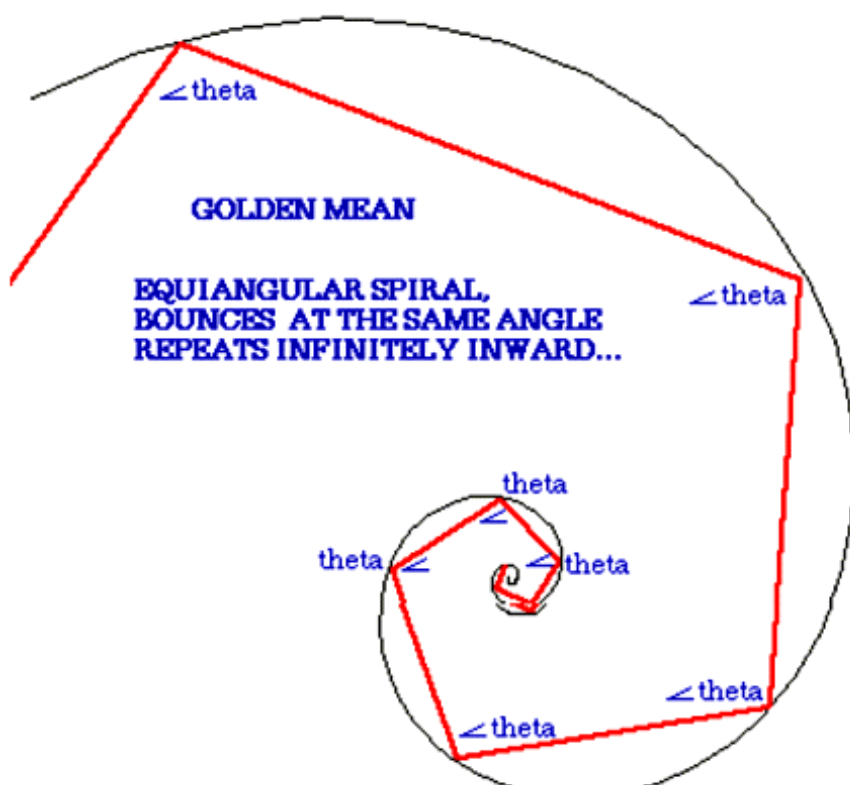

### 11.) Introduction to Embedding

- i) Embedding is a simple mathematical concept - an arithmetic model of nesting / phylotaxis.  
 ii) As a PSYCHOLOGICAL concept - it is key to compassion as suction within is magnetically generated by the SKILL to turn the heart inside out. And we shall see - is key to STEERING TORNADOS!

**Problem SOLVED by PHI(otactics):  
 SUPERLOOPING / Perfect NESTING:  
 Embedding!**

Your Heart BEAT  
 is a Wave

Your Heart RATE  
 is a Wave

Your BREATH  
 is a Wave

Your DAY is a Wave

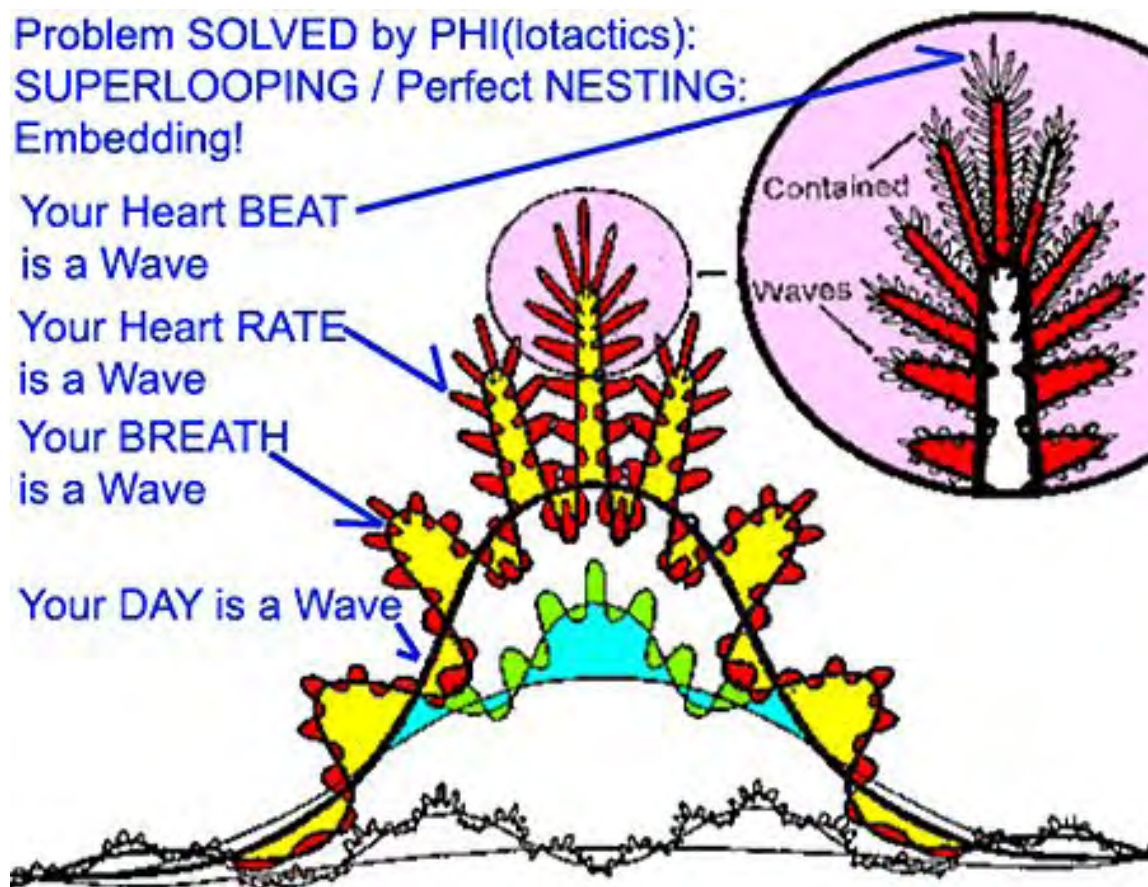

**Perfect Embedding = “Wave on a Wave Waving”** (The Answer Lies ‘Folded in an Envelope’)

= “SuperLooping”

(Dr Dardik’s word for the heart harmonic rich HRV to eliminate disease  
[soulinvitation.com/dardik](http://soulinvitation.com/dardik) )

= **Fractal Heart Rate Variability**

= **Perfect Nesting - by Phi or Golden Ratio**

= **Health = The Psycho-kinetic (powerful) state of mind.**

= **GROUNDING ... psychologically , electrically**

- meaning **ACCESS TO THE FRACTAL**



### 12. What is the SYMMETRY - the SHAPE of COMPASSION:

When the harmonics of the brain- body- heart-planet enter into NESTING they do so by the principal of FRACTAL ‘EMBEDDING’. Harmonic analysis showing musical key signatures based on the Golden Mean ratio - which show up for example on HeartTuner, and in Prechter and Elliot Wave Stock market volumes - indicate moments of self-organization electrically. This is why the HeartTuner was originally called the EMBEDABILITY MONITOR.

Dimpling Inside Out: Map to Compassion?

# Making Love Visible

a bridge between worlds

Dan Winter  
[www.soulinitiation.com](http://www.soulinitiation.com)

*Dimple  
'sucked'  
in  
recursively*

Biophysics graph  
of the converging  
toroidal voltage  
waves whose  
collective  
compression  
electrify the  
heart.

a  
multimedia  
lecture

About the deep interconnectedness of all things,  
where even your feelings have a direct influence on the environment,  
which becomes visible on a computerscreen by the new invention of  
Dan Winter, the Hearttuner.

Compassion is learned  
When the little picture inside  
Your heart becomes  
So 'self-similar' ( or 'fractal')  
To the shape of magnetism  
In someone else -  
That perfect compression -  
The 'fractal attractor'  
Sucks the Out-Side - IN !

This RECURSIVE -  
TURNING INSIDE OUT -  
Becomes IMPLOSION -  
Which is the electrical  
RUSH associated with FEELING.  
And shows up in the ASCENSION  
Of the next harmonics measurable  
In the EKG.



Relationship - COMPASSION  
- to ASCENSION

## A Symmetry Map to Inside Out Makes Compassion's Harmonics Measureable

Understanding the Simple physics behind HOW the HeartTuner measures compassion - ascoherence (in addition to measuring empathy when 2 hearts come into phase lock).. HeartCoherence.com

It is Electrifying to Realize the Heart is Electrified By Concentric  
Donuts - Sweeping Voltage Directly from Gravity.

(electrical EKG symmetry map from 'When Time Breaks Down' by Winfree (origin of the heart's beat)



above- how the donut knows the way inside out...  
 try 'throwing' it at [soulinvitation.com/compassionmap](http://soulinvitation.com/compassionmap) .. click there to see friends who spin it into an  
 alphabet of symmetry..

Model of the Heart's Electrification during Euphoria.. Implosive Compression

As the heart sucks into its fractal center - the wind 'within' begins when you choose to FEEL compassion.. the donut sucks the dimple in - again and again - which shows up as another harmonic in the harmonic analysis (power spectra ..right bottom in the pic)..THIS IS WHAT THE HEART TUNER MEASURES AS THE ONSET OF COHERENCE..

This ascension is enabled by the centering force generated by PASSION itself. (Which has a critical function in the physics of how biology feeds gravity - the force which keeps tornadoes concentric - thus gluing all worlds together).

Below: interdigitated (stellated) -phi based- dodeca model the perfected embedding chosen by the(fractal) EKG - like DNA/ Earth Grid / & Zodiac.. nature uses embedding..

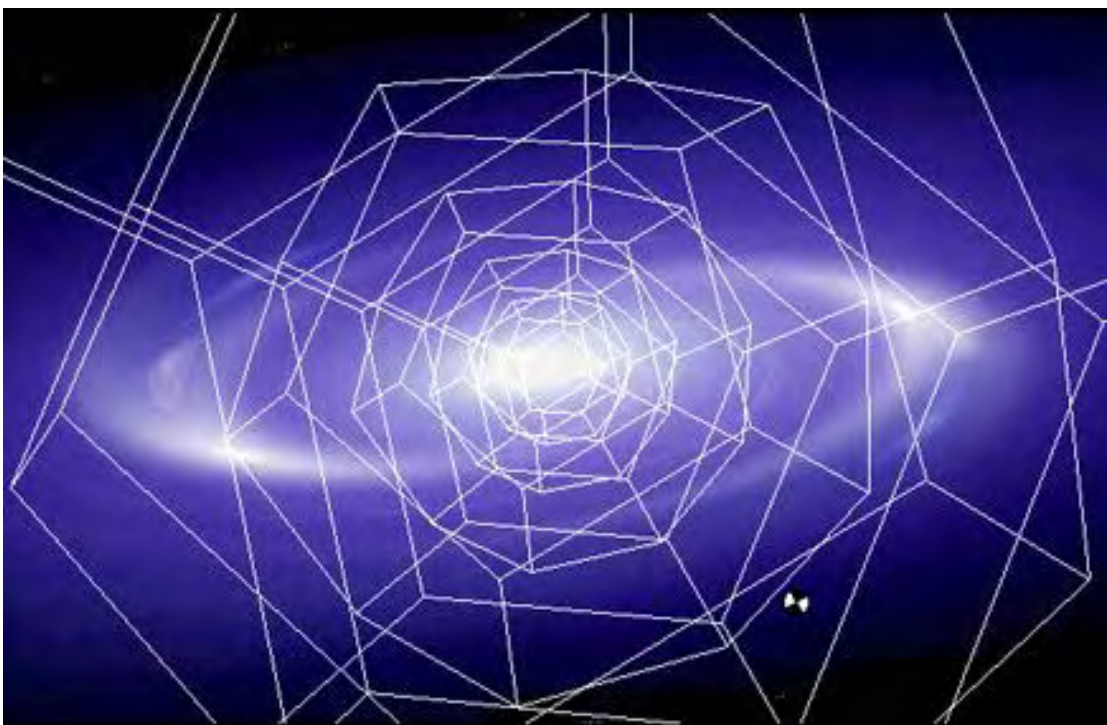



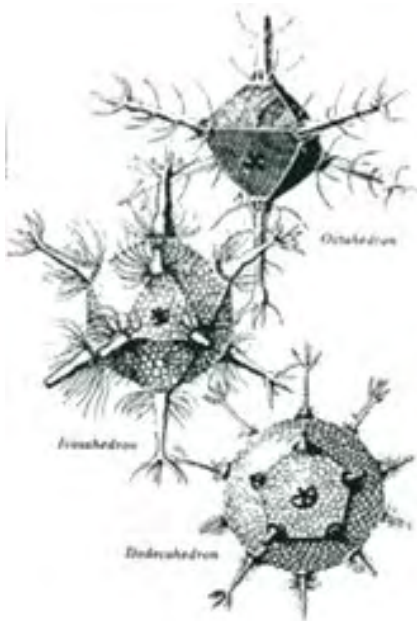

Radiolaria  
Re-PENT-ing  
To be saved?



Phi Based Fractality  
In the Nerves Firing the Heart

'Sun's Eye' Pent View of  
Perfect Branching,  
Perfect Nesting,  
Perfect Unpacking,  
Perfect SHARING THE  
LIGHT,  
Maximum Exposure/Minimu  
Superposition,  
Perfect PHYlotaxes..

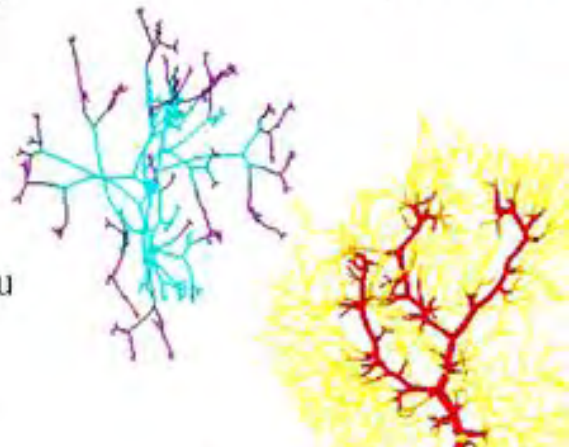

..the Fibres of Perkinjole.. Where the Heart Catches Fire  
Are Fractal / Self Similar in their Branching..  
And Teach us How Voltage Comes from Gravity (Implosion)..  
Compassion is the Skill to Sustain this 'Inside-Out' Compression

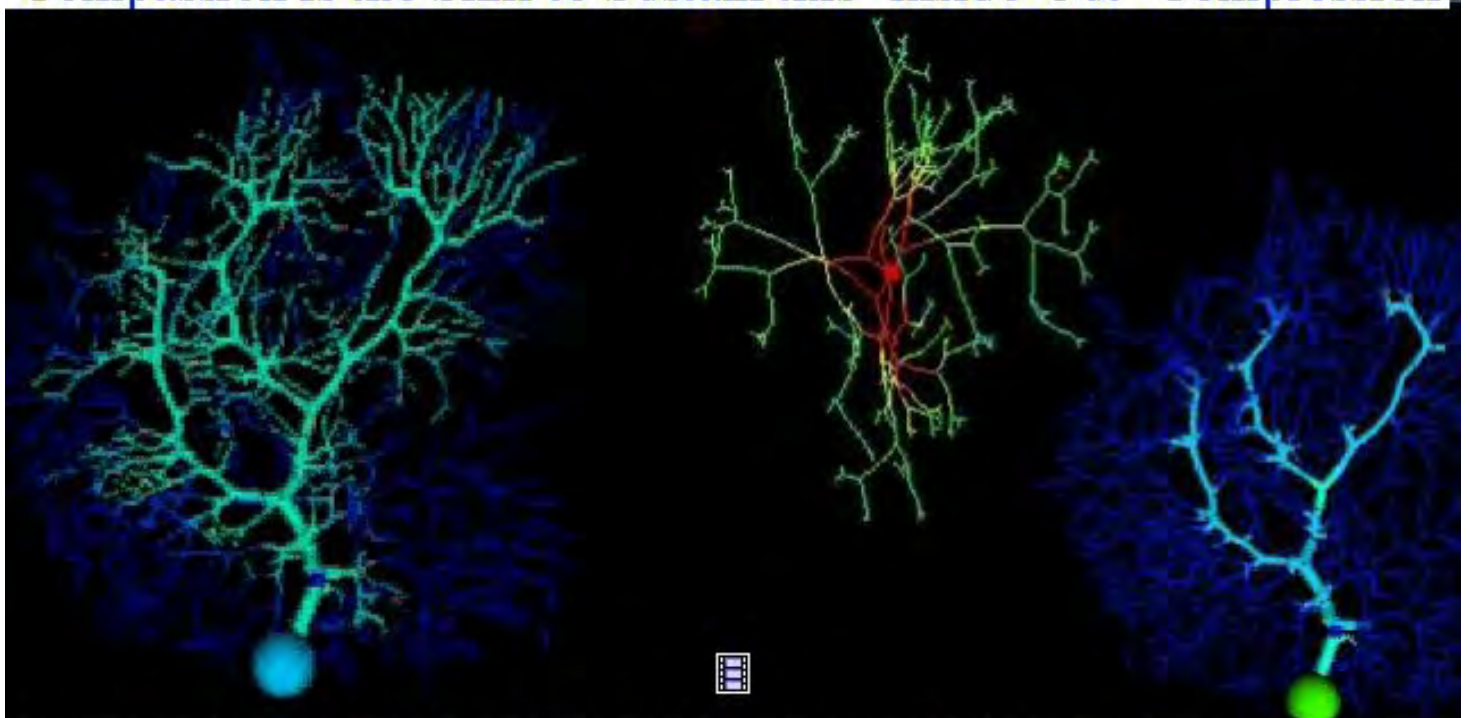

(Charge Compression -Capacitors in Fractality MAKE Gravity ..

49

***How Does PHI/Golden Mean Based Recursion Create Dimple Inside Out-Ness?- How the Heart Opens:  
Sacred Geometry and the New Science of Compassion -The Heart's Labyrinthine Electrification***

So this is HOW we believe The HeartTuner works - When you choose to feel compassion - you make a little picture INSIDE your heart - which WHEN it is SELF-SIMILAR (or fractal) to the SHAPE of the FEELING (magnetism) of the person OUTSIDE your heart ...

THEN that sets up the conditions to allow the OUTSIDE to FALL IN. This is called technically - a FRACTAL ATTRACTOR. It works because only FRACTAL ( or self-similar - fern or onion like) symmetry permits infinite nondestructive compression. This is also called IMPLOSION.

When waves can infinitely CONSTRUCTIVELY interfere as they approach center (fractal self-similarity optimized by Golden Mean ratio) then they add and multiply their wave velocities constructively as well as their wave lengths. This we believe is the only physics necessary to understand the origin of gravity - (because that geometry which permits acceleration - is that which makes gravity - which is the same as acceleration - which will be proven as soon as someone -besides military aircraft - puts enough capacitors in a fractal to make gravity --)

more reading in this series: (CD or web)

Suction Steers! Implosion Makes Waves: Creating a TORRENT thru your Heart     [soulinvitation.com/torrent](http://soulinvitation.com/torrent)

Tunnelling .. The "Black Hole": In the Human Heart...Is Acceleration Thru Light Speed in the DNA Braid  
Occasioned by the Heart's Blissful Sonic Pony Tail, How Compression Thru Light Speed Becomes "Tunnel-  
ling" ...     [soulinvitation.com/tunnelling](http://soulinvitation.com/tunnelling)

The Perfect Geometry of Wave Collapse - Neurophysics Solution the Nature of Consciousness  
[soulinvitation.com/collapse](http://soulinvitation.com/collapse)

Projective Geometry of the Heart-Perfect Compression/Compassion=THE SHARED SPACE  
[soulinvitation.com/compassionmap](http://soulinvitation.com/compassionmap)

Fusion-Phi Phenomenon-Unlocking Ultimate PHIRE. [soulinvitation.com/fusion](http://soulinvitation.com/fusion)



12. Review of the **IDEA THAT CHARGE ITSELF BECOMES THE VEHICLE for LIFE FORCE.**  
**In 'CHARGE' of Life: Architecture of The Sacred & The Sustainable.**

In this part of our study of Sacred Geometry, let us imagine we are the architect of the universe, and we wish to play "Sim-Universe" This is the next software game which should follow "Sim-City" and "Sim-Earth". When Lovelock, author of "The Gai Hypothesis" wrote the software code in "Sim-Earth" which regulated how planted paramagnetic dolmen (sacred stones like Stonehenge and Avebury) affected evolution of genepools, he correctly projected that the burn rate of evolution would increase at the risk of available resource. - He did not understand WHY the addition of simple magnetic symmetry would increase the metabolic burn rate when fed to a compost pile - again by simply arranging stones like lenses to steer the magnetism into the 'pretty picture' we call symmetry. Our goal in this section is to understand this. What is the simple scientific pure principle which explains why **adding SHAPE in simple symmetry to magnetism and electrical charge creates a direct means of FEEDING LIFE FORCE to biology and evolution ?**

Remember **the evolution of consciousness IS the ability of a field effect (in this case the 'charge' radiance of genes and glands) to propagate and distribute itself.**

We have learned a little bit about how electric waves in the universal compressible medium can be arranged into patterns which create LIFE itself. We wish to now apply those principles in a practical way, to design and build LIFE.. into our homes, offices, landscapes, and even - into our refrigerators.

If you understand what follows, you will begin to comprehend that there is no possibility to become a sacred architect of ANY sort, unless you can design a capacitor. The reason a beehive or a celtic straw hut in sea spray makes things live so long, is because they are good capacitors.° Ancient dolmen sites and even cathedrals hold you in bliss in the spell of their charge, because they are 'in charge' - that is - FULL OF CHARGE. Life occurs when biological structures learn to gather charge in enough different wave lengths to cause them to compress or 'implode'. You are going to read about 'implosion' here as you learn that this is another name for a 'fractal-tractor'. When enough different waves gather to one place in the Golden Mean ratio.. they begin to suck in an infinite number of other waves - but always in Golden Mean ratio. This is the only way the universe has of arranging for an infinite (in-PHI-knit) number of waves to gather at ONE point without hurting each other. This principle of IMPLODING - waves you will see - is going to become the symmetry (or pattern) ESSENCE of:

1. Making Gravity out of waves (how charge or power can be extracted from gravity as well)
2. Making LIFE - and making waves appear to become self-aware and self-steering. ( pics at [soulinvitation.com/phiricais](http://soulinvitation.com/phiricais) )
3. Creating the electrical requirement to make ATTENTION possible, as well as 'enlightenment'.

To understand all this well, we need to sort out the connection between IMPLOSION, and getting fractal like a rose .. and making LIFE.

Once we understand that the skill to persuade waves to agree IS - LIFE and SELF-AWARENESS, then we can begin to practically USE the symmetry and musical harmonic 'RECIPES for PHI IMPLOSION' - to perfect the sacred architecture of our living structures.

First let us 'agree' that SUSTAINABILITY for wave pattern, is the only definition 'SACRED' ever had. The symmetry or pattern ingredients to get waves to implode - cause them to stabilize (that is RESIST change of position). This resistance to being pushed around which a wave going like a gyroscope in a circle creates, is called INERTIA. Inertia is the only definition or measurement physics ever had for MASS. So .. teach a wave to sustain a circle (a gyroscope) and YOU are the CREATOR (God) of matter out of light. The trick is, keeping the implosion going in the middle (called Gravity), so the waves does not fly out of the circle. (From mass to energy). The path of perfect "TRANSLATION of that VORTICITY" from the circle to the line - which is FROM MASS TO ENERGY - IS- The Golden Mean Spiral. (Yellow Brick Road - kind of thing.)

Second - let us notice that our new definition of LIFE : “The ability to attract and self-organize (store) CHARGE” is measurable. ( see [soulinvitation.com/biophoton](http://soulinvitation.com/biophoton) ). To measure life as an electrician we do a harmonic analysis of the capacitive charge field around say an egg, and the more HARMONICALLY INCLUSIVE - which is to say FRACTAL those waves of charge are... the more ALIVE it is!

What happens when a biological capacitor like a pine cone or a fresh egg or the electrical shape of your heart wiring which cause it to ‘phire’, starts getting VOLTAGE FROM GRAVITY? ... We call that - the moment it becomes ALIVE. (2 to 10 millivolts generated from gravity by the average fresh chicken egg - ask your physics professor where that comes from.)

The perfect COMPRESSION called IMPLOSION is key to that energy source... and the source of ALL life. So we MUST know and teach that symmetry recipe to make implosion, or we will lose ALL life!

What is cool, is that this little symmetry picture to arrange biological capacitors to CREATE LIFE - like - your furniture or your emotions, or the stones around your house and garden ... is as simple as looking at a rose! So it is easy to teach.

Suppose you are like our friend C.H. in Germany. Generations of PHYTOCHEMISTS (studying life and healing using plants) - noticed that they could predict if a bioregion could produce healing plants - by checking ONE ROSE GROWN THERE. If the inside of the rose flower pattern - looked exactly like the outside of the rose flower pattern in that same rose - then the plant healing expert would know that the bioregion contained the symmetry ability to compress charge - and that predicted healing! This principle of the inside looking like the outside - is called FRACTALITY. Roses, onions, fern trees etc. are biological examples - they show us how NATURE compresses charge to make life.

Physics has no quarrel with the essential insight of Einstein and all religions, that the universe is made of only a single substance: a unified field. What has been a bit troublesome has been to map the symmetry or wave pattern relationship between some of the attractions observable in that unified field.

The problem of getting to a complete idea of that ‘unified field’ was delayed by the fact that physics initially failed to observe a fundamental symmetry connection between such attractions as electrical versus gravity. This was simply because the principle of compression that produced acceleration eluded them. The solution to MAKING that charge compressor that DID accelerate - is and was FRACTALITY ... ‘self-similar’ like a rose.

This principle occurs because waves (of ‘charge’) which cross upon themselves in a rose like FRACTAL pattern, add AND multiply their wave **velocities** - (as well as their wave lengths) RECURSIVELY (that is like compounding your interest at a bank) .. AND always CONSTRUCTIVELY. Reference: [Heterofi, Heterodyning and Powers of Phi \( soulinvitation.com/heterofi/heterofi.htm \)](http://soulinvitation.com/heterofi/heterofi.htm) To think about how a wave might cross another and add and multiply the wave VELOCITIES - think of a surfer. He enters to tube tunnel in a cresting wave, then the curl of white cap collapses wave comes rolling in from the side. The wave from the side at one moment COLLAPSES on the wave coming straight on - AT THAT MOMENT THE SURFER IS SHOT OUT FROM THE TUBE LIKE A GUN! That is a wave which took it’s VELOCITY and ADDED it to another wave. IF those waves were meeting in the Golden Ratio pattern like a rose fractal ( see pic below - pents into the tube tornado) - THEN the adding of wave velocities becomes CONSTRUCTIVE RECURSIVELY (repeatedly). This is how CAPACITORS ARRANGED IN A CONE (like the seeds in a pine cone) MAKE GRAVITY and MAKE VOLTAGE FROM GRAVITY. Because again - gravity IS acceleration - the ACCELERATION of that CHARGE resulted from ‘recursive’ (repeated) self-similar ‘fractality’.

**This turns compression into acceleration.**

***You gotta make gravity to make life. You gotta make life to make gravity. Other wise you will be ‘blown away’ / ‘pushed around’.***

The proof was that capacitors storing charge waves crossing when arranged in a rose or fern like fractal or cone ...(like seeds in a pine cone)..PRODUCE gravity. Capacitors in a curve or cone approaching this geometry of ‘self-similarity’ CREATE THRUST. (Replacing things like rockets and car motors.) ( pics at [soulinvitation.com/phiricais](http://soulinvitation.com/phiricais) ).

Physics already understood that acceleration WAS gravity. (Arguing whether acceleration produces gravity or gravity produces acceleration is very chicken and egg ).

So the PATTERN or 'symmetry' recipe to make charge electrically go into this compression acceleration tornado becomes the holy grail for the physics of the unified field. See the grail animation at: [soulinvitation.com/grail.html](http://soulinvitation.com/grail.html) - that animation is the only 3 dimensional fractal - AND the way to arrange capacitors to make gravity - which is why it is a symmetry map to the dodecahedron - 'wrenchet' fractal gravity maker which is DNA!

This is how we recently solved Einstein's dilemma about finding the shape (symmetry) which allows waves to infinitely compress. (Instead of "The Perfect Storm" - we get "The Perfect Tornado").

The answer was really simple, you take the Golden Ratio branching called Phyllotaxies which is the definition of all plant life unpacking, and arrange capacitors in the same way, and you solve the problem of PACKING. Electrical waves which we may at first simply label as charge. (Later we will learn about the difference between charge as a simple difference in electrical potential pressure difference which is called VOLTAGE - versus when that same charge is STORED and measured in FARADS as CAPACITANCE ).

Soon this will enable us to begin to think about what it is about a certain symmetry or pattern among waves which ALLOWS or INVITES charge to be stored. This capability to STORE CHARGE by learning the kind of 'slip knot' symmetry - gets us close to understanding how matter is created out of energy - or simply out of waves.

**When we invite charge into compression space - we make gravity and life. Think about why a bee hive might be the ultimate definer of what is sacred architecture: It is such a great pine cone like fractal attractor for capacitive charge. Let us 'take a lesson'. Eventually we are going to need to learn about the definition of the construction materials called 'biological dielectric' (the quality of the insulator in the in between plates 'spark gap' of a capacitor - is called the DIELECTRIC).. which nature uses to build life. Then we can design a building ! ... & a refrigerator ... (hint nature almost never uses metal to contain life - because it is not fractal.)**

-----  
**Intro to LIFE FORCE thinking (for non-electricians who WANT to make life)- using ELECTRICAL CHARGE as the principle.**

First step: if we are going to explain to you how life propagates itself - as charge - and then ask you to change the menu and architecture at McDonald's based on the goal to serve life electrically - THEN - you will want to understand what CHARGE is!

So- what is the NATURE of charge itself?

When you rub a pen on some wool and create a spark - what do you do? You create an electrical difference of potential which initially can be measured in VOLTS. Science explains the difference between positive and negative electrical potential - as the presence of free protons versus electrons. You will begin to see in the conversation which follows, that this is rather limited thinking. The real issue is to begin to see the relationship between tornados that SUCK versus PUSH (centripetal versus centrifugal). If you REALLY get the proposed reason here that LIFE FORCE requires the ability to become ELECTRONEGATIVE in order to ATTRACT THE CHARGE -which IS life itself- to you. For exactly this reason - **the baby that does not learn to suck - may die!**

In Ted Baroody's book "Alkalize or Die" - the REASON blood must become electrically attractive to protons (extra 'electrons' or 'electron space' is associated with alkalinity) - is because - if the blood cannot ATTRACT electrical charge - you begin to decay and get sick.

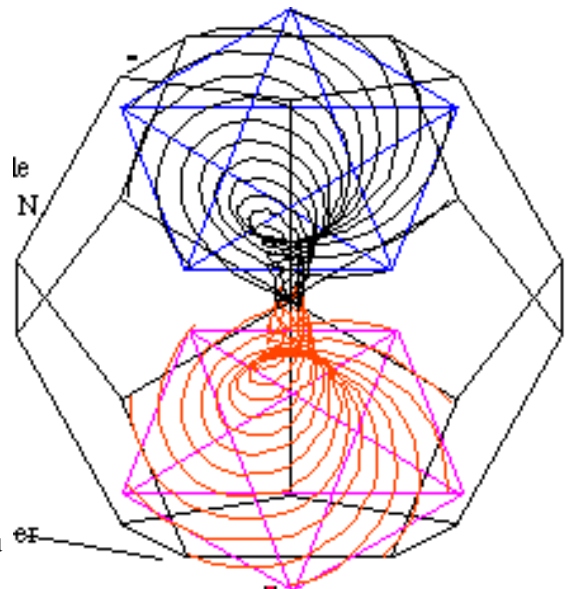

Think - what SUCKS the egg into the wall of the womb. IF that suction is successful - the egg EMBEDS and then gets nourished. If not- it dies. That suction to produce life critical embedding - is primally electrical in nature / in principle.

Protons, for example, and ‘free radical’ hydrogen ion (atom) are thought of as being electrically positive. Electrons are negative. The real meaning of this, requires visualizing (picture below) - the DIFFERENCE between centripetal - or inward sucking spin - versus - centrifugal - or outward pushing spin. See in the below pic- understanding this ‘hydrodynamic’ or flow-form of tornado’s vorticity having a net inward or outward - flux - IS THE KEY TO REALLY UNDERSTANDING THE CONCEPT OF PLUS VERSUS MINUS CHARGE. (and Yin versus Yang etc.).

Test yourself in the pic from Item 2 (p22) - by seeing if you can answer the question - why does negative DC magnet flux reduce pain AND healing speed ... hint: mechanically externally generated - diverging flux lines decrease focus AND sorting..)

**Becoming ELECTRO NEGATIVE - that is MAKING SPACE TO ATTRACT AND EMBED A CHARGED PROTON - becomes a definition of becoming ALIVE!**

Once you begin to see that becoming electrically attractive to charge, is how you and everything become alive (even how you attract the right people to hug you) - try to begin to see WHY fractal or rose or fern or onion like ‘self-similarity’ electrically - is how anything alive - BECOMES THAT ATTRACTOR (below)... It is because when the inside of a wave nest (like your heart) becomes self-similar to what is outside- THEN - the outside can fall in!

We measure this ‘turning inside out ness’ based on PHI the Golden Ratio enabled or compression — by harmonic analysis in the EKG (heart). This becomes the musical symmetry and definition of compassion - in principle. To feel for what is outside you - you create an image of that inside you. Only that fractal kind of data (wave) compression is infinite. That invites the outside - IN - to you. THAT IS COMPASSION. And it IS compression. You make space for someones feelings which were outside you, inside you.

Infinite non-destructive compression - now solved in the symmetry lesson of PHI based ‘fractality’ was not only the solution to Einstein’s dilemma of how to get voltage from gravity in a unified field - IT IS ALSO THE SOLUTION TO COMPASSION!

o

Excerpt here form BIOPHOTON versus Attracting Charge - [soulinvitation.com/biophoton](http://soulinvitation.com/biophoton) article:

**LIFE FORCE - is electrically defined as - the ability to (fractally) ATTRACT AND SELF-ORGANIZE CHARGE.**

**This is in direct support of**

**a.) The Use of ELECTRO-NEGATIVITY to Predict Life Force in “Bioelectronics of Vincent” (BEV) Technology..**

**and b.) The fact that the NEGATIVE DC Electrode Regenerates Coral in (Electrolytic) [Coral Mineral Accretion - Coral Reef Alliance](#).**

o (coral mineral accretion by electrolytic negative charge) - the process so elegantly exemplifies the principle (electrical self similarity fractally enables the attraction of capacitive charge whose harmonic inclusiveness defines and makes measurable LIFE FORCE) which becomes a practical measurement technology to optimize life as an electrical process in ANY structure...To optimize this: 1.spectrum analyze the capacitive field around your underwater artificial reef metals to optimize fractality / self similarity ( paramagnetic stone in array like rose above ground serves this function to electrically fabricate the field necessary to optimize seed germination) - in the way described in this attached article. 2. experiment with monolayers of gold or palladium - on the growth surface - you will find that such metallics better radiate the necessary capacitive field into self similarity because their valence structure is more self similar

+. The Difference here is that PHIRICAIS - ([Phi Recursion Induced Charge Acceleration Implosion Solution](http://soulinvitation.com/phiricais) - see link [soulinvitation.com/phiricais](http://soulinvitation.com/phiricais)) both predicts WHY electron negativity creates life force electrically (self similarity electrically attracts charge and therefore life) but ALSO provides an elegant method to measure and optimize the mechanism of that charge attraction (spectrum analysis of charge using [HeartTuner](#) - see graphs below).

-And WHY is it that electrical SELF-SIMILARITY makes and attracts LIFE? .. because self-similarity ATTRACTS the kind of compression which is called NON-DESTRUCTIVE. It IS non-destructive because that (fractal) compression creates ACCELERATION (that acceleration of charge has previously been called gravity). That charge accelerating makes the shape memory of symmetry called LIFE .. DISTRIBUTABLE / SHAREABLE / and therefore SUSTAINABLE. It also means that those wave structures which cannot enter into that holy communion of what is compressible and therefore accelerate-able and therefore shareable .. cannot propagate or survive. Thus this is the biological test for 'pure intention' - namely the symmetry of the shareable.

Understanding Magnetics, see also: [Enantiomorphism, Handedness, DNA, and the "ARK" - \(soulinvitation.com/ark\)](http://soulinvitation.com/ark)

A picture of the electrical relationship of the at-moss-sphere to the Earth..?

°There is rich reason in why the **spin (the direction or 'handedness' of the inner spiral helix stairway) of all biological proteins is unipolar, that is goes one way.** The handedness is consistent. All biology's protein stairway helices go ONE WAY ONLY!!.. enantiomorphism -see definition below-.. Dorothy's milk in the looking glass didn't nourish because it's proteins spun mirror backwards, and nutrasweet can cancer instead of being absorbed because it's spin is backwards..

This is because..

Just like all biocells use the Earth grids ELF Schumann heartbeat as an information SOS hailing frequency, all Earth's biocells use the first spin direction of primal soups proteins as the common denominator for their helical stairway to life.. EI-Eye-Ph(i). **LIGHTNING SPUN UP PRIMAL SOUP, MOST LIGHTNING IS UNIPOLAR BECAUSE OF THE CONSISTENT ORGONE ELECTRONEGATIVE RELATIONSHIP OF SKY TO EARTH. SO THE RESULTANT SPIN DIRECTION OF ROTATION IN BIOPROTEINS WAS COHERENT.**

In the above situation, the ability of the Earth to be electro-negative (female - receptive) - with respect to sky (male - projective).. teaches us about the ability to attract charge IN A PARTICULAR POLARITY. Again we see the relationship of becoming ELECTRO NEGATIVE - that is MAKING SPACE TO ATTRACT AND EMBED A CHARGED PROTON - becomes a definition of becoming ALIVE! (above)

Thanks to Don Lorimer, we are coming to understand that one pole of a magnet is more

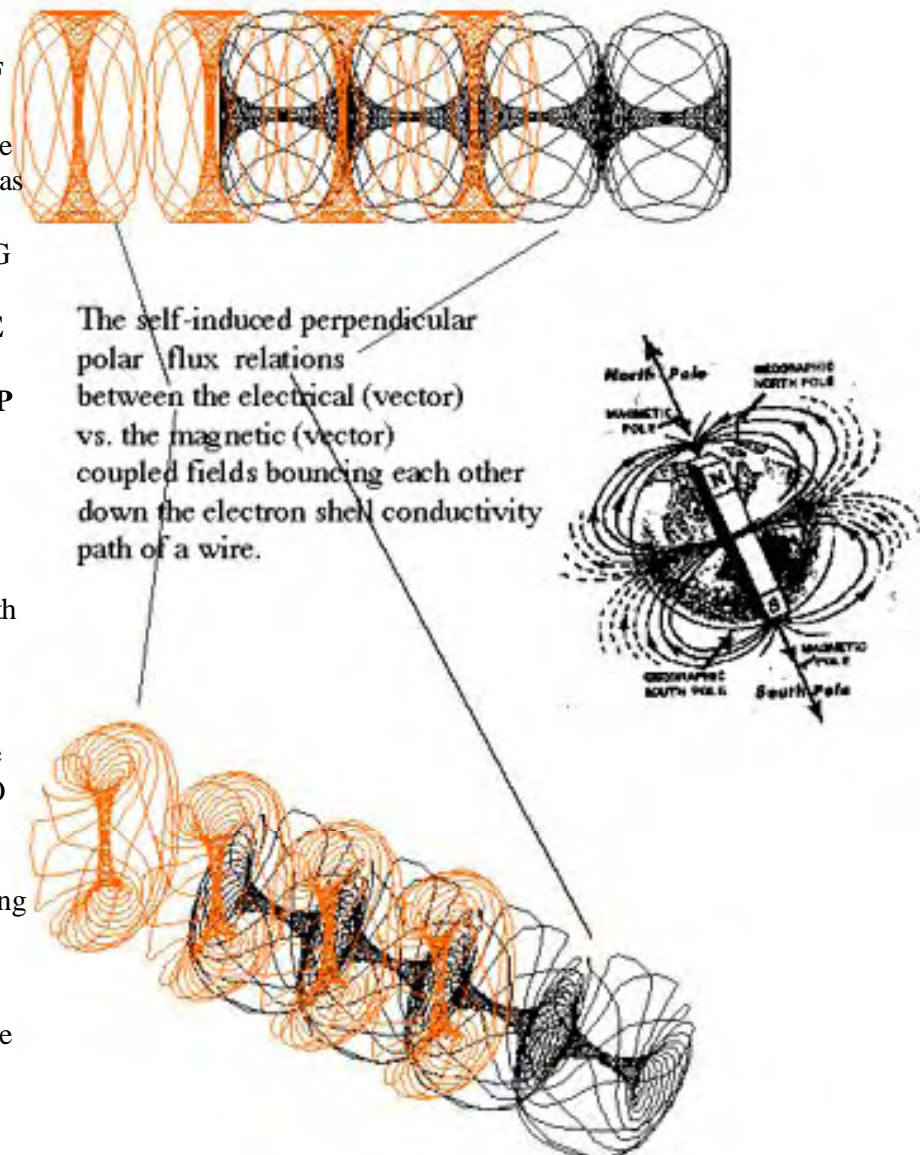

centripetal, more anticlockwise, than the other, AND shrinks tumors! (disorderly, incoherent touching).

A magnetic monopole MAKES gravity (per Einstein). This caduceus cascade fractal, is a movement FROM the short wave to the long: literally scalar. It scales the ladder.

See Picture of Yin Versus Yang Versus Plus and Minus Magnetism in the INTRO Section..

The birth of a magnetic field be impregnated with intention, as can any crystals coherent bond structure. In a literal sense, (as onset coherence), this IS the language of feeling. Emotionally speaking, the aboriginal song lines were the cilia into and out of library's in stone.

**The enantiomorphism - 'handedness' like in 'up the down staircase' predicts the ability of all biological proteins to be alive - because they must be 'stirred in the direction of embedding' -**

Enantiomorph- from the dictionary: en-an-tio-morph- either of a pair of crystals (as of quartz) that are structural mirror images,- Greek enantios opposite (from enanti facing, from en in + anti against)

magnetic healing devices with Don Lorimer et al..

see The Hockey Puck, Don Lorimer (303) 469-5180  
Information:

When placed between the palms and held above the crown chakra, the Hockey Puck has the potential to catalyze deeper spiritual growth, than practically every single other subtle energy or spiritual technology. Its subtle energetic uses include adding energy to the etheric body, energetic healing for healing professionals, and attuning water and other liquids. In fact, used in conjunction with sunlight and a sealable quartz flask, this device is one of the best for attuning water available. Advantages include its size, excellence for attuning water, applicability for etheric body energizing (via a pouch), presence of an embedded gold spiral and professional level quality output (quite rare!) for energetic healing. , & more gizmos at:

<http://www.subtle-energy.com/tools.htm>

Note also at that site, the hi strength Magnet field thru inert/noble gas device for healing (Hilariion/John Fox). This is an example of micro columnating flux lines in cell water to optimize the timing geometry for more spin dense metabolism. (Facilitating recreation of damaged retina etc... powerfully useful in a limited temporary context.)

The plus side of magnetics is you can help restore flux geometries, which biology desperately needs choreographed prettily. This means for example as Don so often mentioned, that strong plus and minus magnetics under the correct feet (polarity) dramatically restored the magnetic equilibrium of a sensitive lady dizzy after overdoing a sweat lodge heat (in my presence). The improvement was sensational.

In these short term environments, this tool is powerful.

Now: here is the down side-

Magnetic fields which begin to pulse alternate (unlike DC permanent magnetics), and BREATH EMBEDDABLY in their environment become SELF AWARE (and store information/mind). This will never happen in a DC permanent magnetic field. Also ANY externally applied magnetic field AC or DC, is never going to empower you to make that field yourself into something self directing / self - empowered. (A worm with will). LONG TERM USE OF EXTERNALLY APPLIED MAGNETIC FIELDS WHICH ARE NOT THOSE OF LIFE ITSELF, IS A CLASSIC TRICK OF THE BORG. (Those who rely on mucous producing external sources of glandular juice.... alcohol, caffeine.. drugs...)

So your example of actually LOSING your memory by fixing yourself in an outside field which is NOT embedded in LIFE flux itself, rings very true. There is no memory in a field which does not breathe.

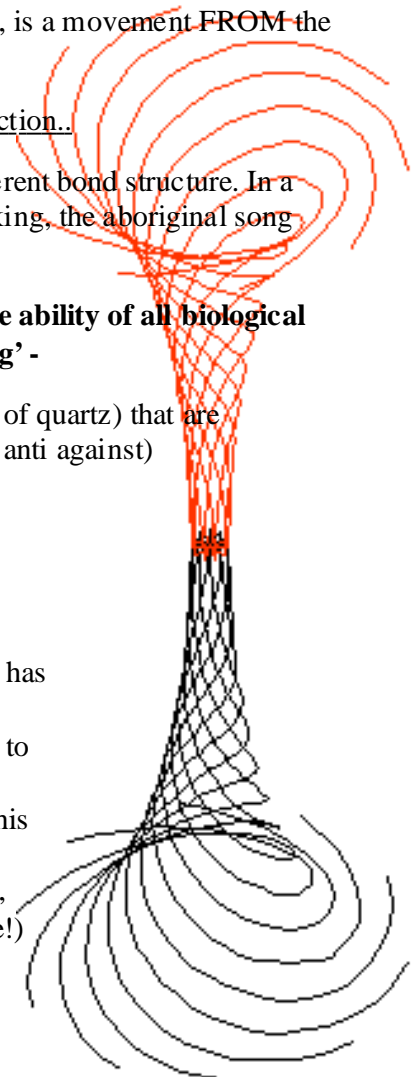



It is like those who think by making their watch into the Schumann 8 hz pulse, they can emulate the euphoria your body goes thru when it finds an old tree still singing Earth's heartbeat. The Schumann resonance electromagnetic heartbeat of the Earth is the CARRIER WAVE, not the milk itself. That is the difference between a pacifier and a real milk bottle. It is as stupid as the primitive Russians who took home the faucets and light sockets from Berlin after WWII, not realizing you needed to hook them to plumbing and wiring, to get light and water in their huts.

So too, a magnetic field which still stands because it was impressed (lifelessly) in some factory... versus a field in a stone circle on a water dome in a Druid field of old Oaks, which stands because all the waves there still agree. (phase align with longer and longer and longer.. wave.)

In the end, pacifiers make angry babies, who only later realize they have been robbed of mothers milk, so they suck with no reward.

Let us understand a little more about the concept of 'embedding' - for waves and charge and babies and architecture etc... (ref: [EMBEDABILITY MONITORING-AS THE HEART GEOMETRIZES, SO FEELING EMBEDS.. url- soulinvitation.com/embedability](http://soulinvitation.com/embedability) )

Imagine you ARE the light wave coming in to your children's classroom. If you as a wave were pushed as a compression moment out of a fluorescent tube at 50 or 60 cycles per second. Imagine that who gave you the push was some angry machine at a distance - not full of feeling. When you the light wave, arrive at your child's eyeball - and you give a push to add spin to your child's ability to focus... there is a very high probability that you will not arrive in PHASE TO PRODUCE FUSION. In other words, because you as a wave are out of PHASE or spin pattern with most of the rest of nature — you cannot help produce ATTENTION!!!! This phase discipline that produces fusion or implosion by perfect nesting is called EMBEDDING.

Now suppose alternatively that finally they kicked out the fool who invented fluorescent lights for your kids classrooms, and instead installed SUNLIGHT!! Now, you are the light wave arriving at your child's eyeball. You are in PERFECT PHASE LOCK with the waves at the core of HYDROGEN. This is the symmetry recipe to the fusion fire at the heart of the sun. Now when you as a light wave give a push to the optical hologram in your child's cortex, the spin nest will be in PHASE and ABLE TO FUSE. This process of bringing waves into potential implosive fusion, IS CALLED ATTENTION!!! Persuading waves to agree (fuse) and thus come to focus is called PERCEPTION! And this process of building perceptual attention requires the symmetry of fusion. In order for waves to FUSE non-destructively - they must EMBED.

Ref: [Fusion-Phi Phenomenon-Unlocking Ultimate PHire. url: soulinvitation.com/fusion](http://soulinvitation.com/fusion)

**Replace the light out of phase with the sun ( like ugly 50 and 60 cycle lighting - anything whose wave lengths recipe does not imitate and get in perfect synch with the sun) with sunlight in your child's school, and you can depend on measuring a DRAMATIC INCREASE IN ATTENTION SPAN!!!** ( ref - "Health and Light" John Ott ) As we get to the principles for architecture below, we shall discuss ways to imitate light in phase with the sun, when sunlight is not available. Remember the Heart of the Sun - has the symmetry of Hydrogen - which has the symmetry of the Human Heart .. all of which have the symmetry slip knot recipe called the ANU. This is the sequence of turns nature uses to CREATE fusion. ( ref: [Heart of The Sun: Perfecting 7/5 Turning Inside Out Solar Heart Symmetry - url: soulinvitation.com/heartsun/HeartofSun.html](http://soulinvitation.com/heartsun/HeartofSun.html)

**So anytime we attempt to store and phase delay the waves coming from the sun, we must do it in the phase ( musically in perfect drum beat timing .. on beat and in key ) necessary to preserve embedding. Otherwise we produce waves which do not agree (fuse) and then we FAIL TO EMBED (the only definition which ever existed for EVIL).**

**That embedding by fusion produces the focus and sorting called perception. When waves of charge become implosively self-organizing by acceleration communion through the speed of light - they are called conscious: THE RADIANCE OF A FIELD - is it's intelligence to self-select what can embed. Architecturally you select an embedable field - and you thrive. Select a field that fails to embed (metal building in air depleted of capacitive charge / big city) and you die.**

If we read “Primer on Energy” / “Primer on Rotation”, we see that all biological decay / inefficiency / death comes about from the attempt to STORE rather than perfectly DISTRIBUTE spin. Note that spin or rotation is the only creator and definer of matter, information, charge, and time. (Time is merely a name for relative rotation).° Perfect distribution is the elimination of storage. ( Get that and your business thrives ). This is also true for life.

Imagine you were a line of simple ‘billiard balls’ (round hard balls like used in billiards). Line up your balls from here to the moon. Make each ball a millimeter apart — space to the next ball. Now hit the ball at this end - in the direction of the line. The balls start colliding into each other, with a little bit of STORED inertia slowing down the time it takes for the last billiard ball in the row to bounce off having reached the moon. That little bit of storage of spin inertia caused because the balls DID NOT QUITE TOUCH .. causes inertia and spin and time- to be lost. Information about the state of you is carried in the passage of the push of your first hit ball... carrying the message of the SHAPE OF THAT LITTLE PUSH ... all the way to the moon. If you delay the delivery of that information, you delay awareness. This is because messages have to get carried around pretty fast in order for a potentially infinite number of messages to converge (compressed) at one point.

So what is the solution to getting messages (like biological information) moving faster?

Now - rearrange your row of little round hard ‘billiard balls’ from here to the moon. Place them so that THEY ALL TOUCH EACH OTHER. Now - try bouncing one more billiard ball at this end - again in the direction of the row. How long does it take for exactly one billiard ball to bounce off the row, all the way at the moon?

Answer: (I dare you to disprove me)... FASTER THAN THE SPEED OF LIGHT!

Exactly the same number of billiard balls you bounce into the row at this end will bounce off the other. So you can send messages which are infinitely fast in distribution AS LONG AS NO ONE IN THE ROW TRIES TO STORE ANY OF THAT INERTIA.

**The key was to find a way to align all the billiard balls so that they could all touch each other, preventing the need to STORE spin, so information was passed instantly. Because, when they all touch perfectly - the passage of inertia is instant, and totally efficient.**

Now - have you ever noticed the way spheres ( billiard balls ) experiment in touching perfectly. On a plane - they touch in HEX symmetry. This FIXES their spin. (Edge length equals radius ).

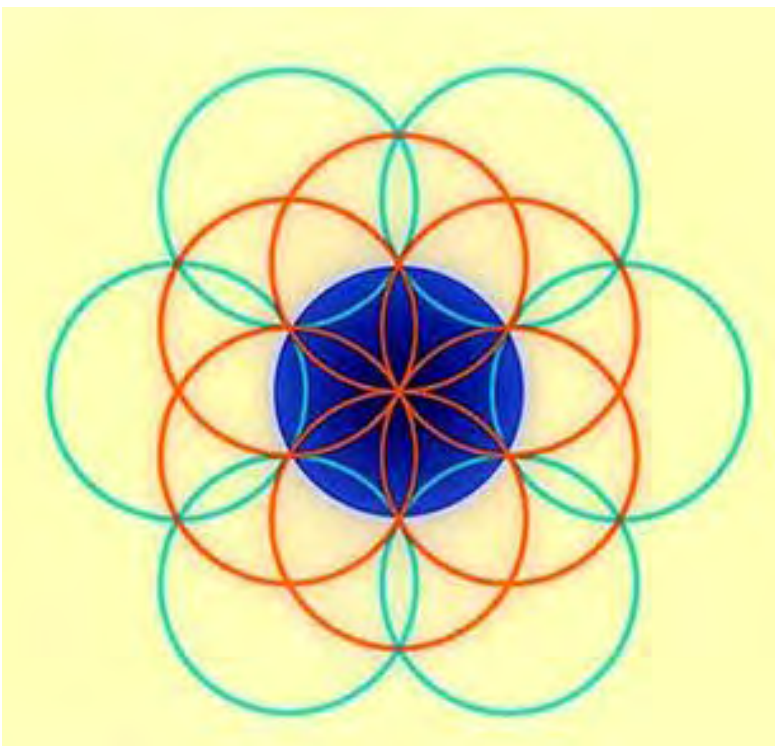

..”Flower of Life”

Hex cube nested in Pent Dodecahedron  
by 32 degree tilt.





is sold by the gram

Left:  
Icosa ...  
Octa.. Dodeca w/cube.. Tetra  
CubeOcta... Cube

If you want a maximum number of spheres to touch in 3 dimension, you put 12 around one - in the symmetry of CUBE-OCTAHEDRON. (the Cube-Octa is really the edges of a tetra extended).

Below - the difference between the CUBE-OCTAHEDRON which are both top and bottom in the center row, versus the ICOSAHEDRON - which is bottom left, **IS A LITTLE BIT OF COMPRESSION!**

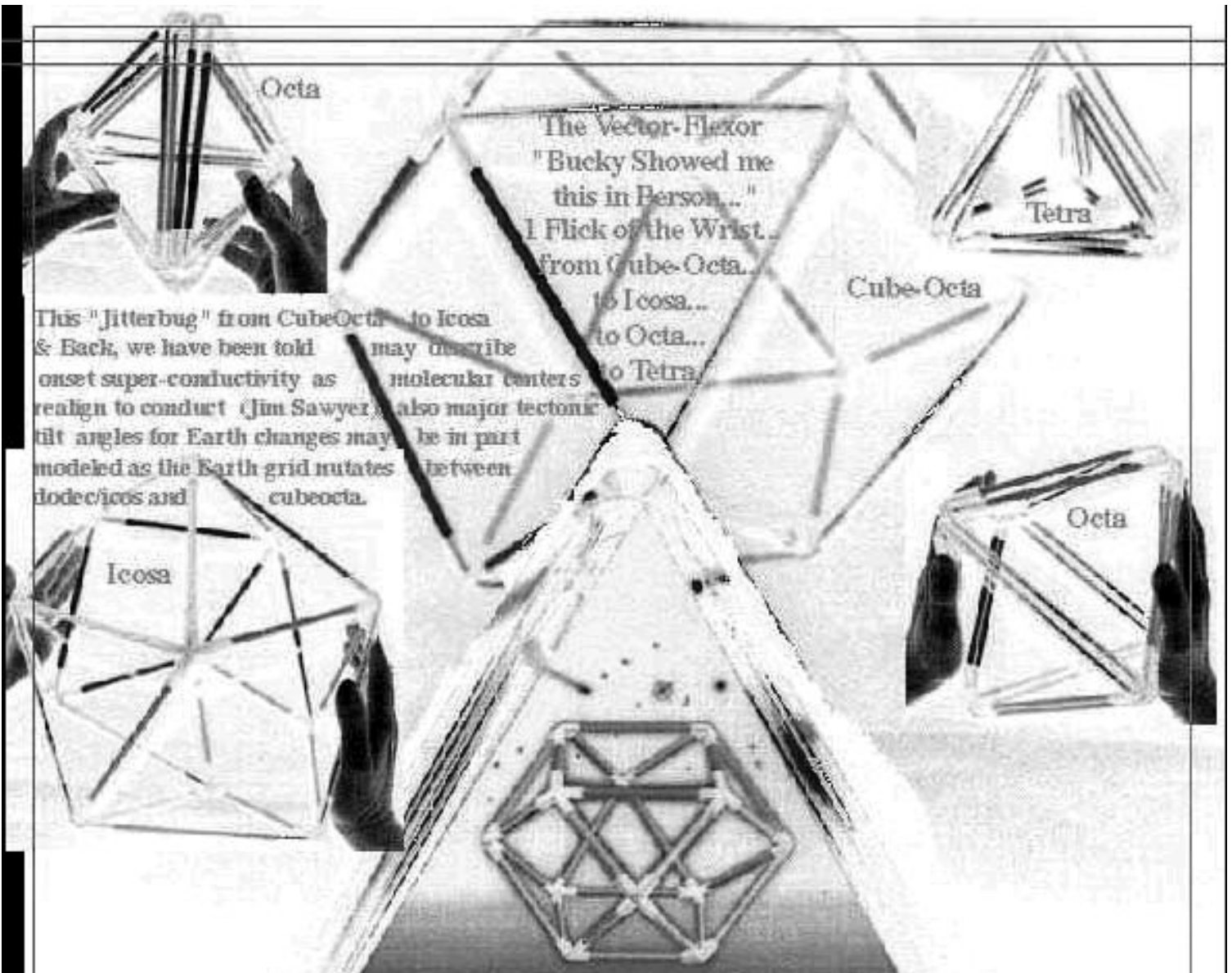

The point is that by taking a geometry in 3 dimensions, which allows perfect TOUCHING - and compressing a bit - we get the icosahedra.. which we shall see later - implies in it's center a dodecahedron..

We are now getting closed to a symmetry that allows infinitely fast distribution of CHARGE.. BECAUSE PERFECT TOUCHING ELIMINATES STORING OF INERTIA, AND PROMOTES PERFECT DISTRIBUTION.

We need now to apply this to understanding a mechanism by which all of life can create a charge distribution network - which is able to achieve instant communion. That means, anytime all of biology wants to vote on what is shareable, they can do so instantly - with no delay. Suppose a government used a way (the Internet?) to achieve relatively instant and frequent voting. In that way - the will of the collective could be instantly enacted - requiring no delay / between those represented and those acting. Those represented would BECOME those acting. Perfect collective mind and therefore democracy merely depends on perfect distribution (of voting) with no delay.

We shall soon here see, that DNA, by becoming so 'fractal' a charge accelerating holy communion device for biological charge - inherently enacts that democracy on all who use it. This means that dying successfully requires a vote from all of DNA saying that you have stored charge (inertia / memory ) which is able to be distributed / shared / immortal / sustainable. (ref: movie - "FlatLiners")

By locking each 'interdigitating' node of waves (nodes are places where waves cross each other without hurting each other) - into the 3D stellated Dodeca / Icosa symmetry.. (below right)

*Mother nature gets her billiard balls touching perfectly. This allows an instant holy communion of the passage of waves of charge - creating a telephone network called LIFE.*

*Dodeca stellation / nesting - PHI based symmetry basis of all living protein.. see Star Mother KIT at [heartcoherence.com](http://heartcoherence.com) or [soulinvitation.com/kit](http://soulinvitation.com/kit)*

*DNA / Earth Grid & Zodiac use this Dodeca Embedding Symmetry: Merkabbah / Ezekiels Wheels..*



The next thing we must understand is how the capacitor works to send charge to fast. One capacitor can send charge between it's layered insulating 'dielectric' plates (like spark gaps) to another faster than the speed of light.

Here we see how the spark gap of a capacitor just listening passively is faster than a telescope to see a star moving in the heavens..

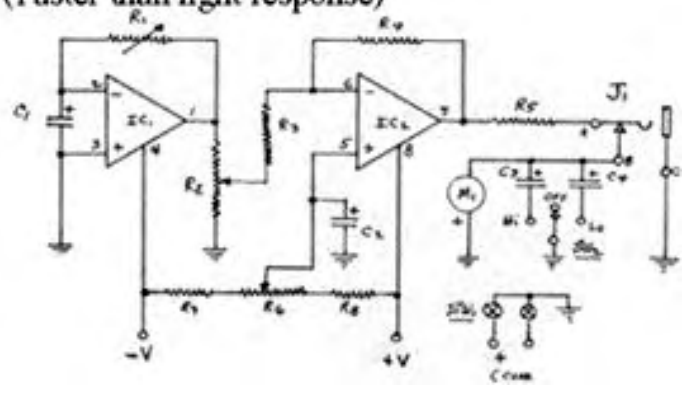
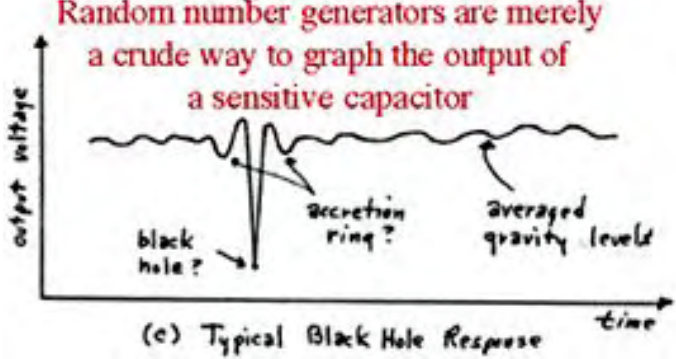
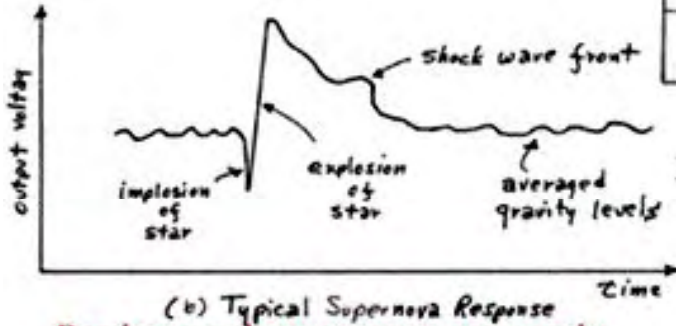
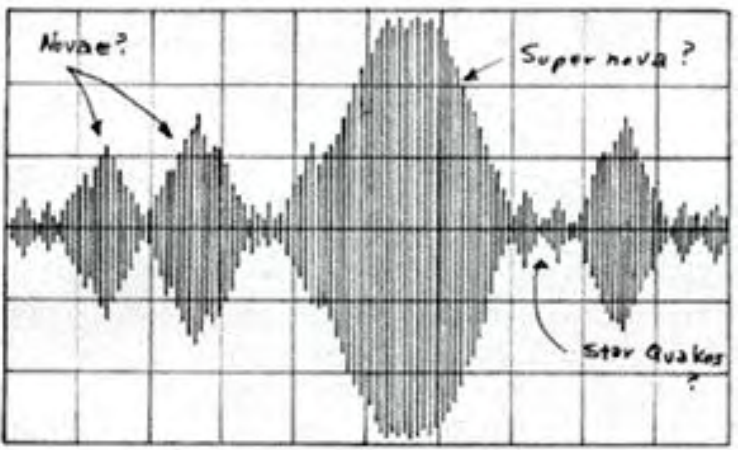
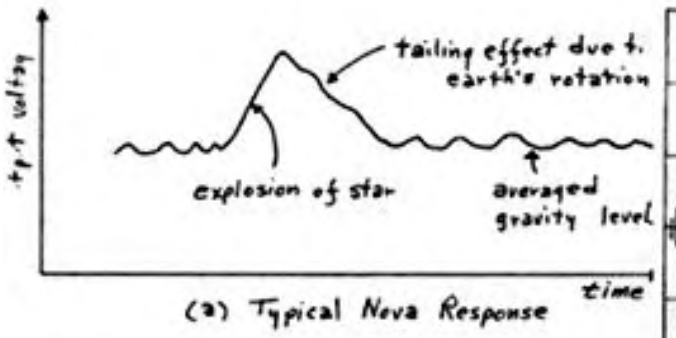

This is the physics of astrology, and how the SHAPE OF WAVES OF CHARGE SHAPE - the KIRLIAN PHOTO, the AURA, and THE PATH OF GROWTH. The reason **the SHAPE OF CHARGE - SHAPES THE PATH OF GROWTH** - is because the liquid molecule wave - ORIENTS itself (that is 'steers its relative direction') according to the (sacred?) geometry of the charge field which surrounds it!

This is how we measure trees communicating faster than light speed. And this is how a tree feels the love from your heart - measurably.

Next we will discuss more about applying this principle -

*that the symmetry which allows waves to FUSE is what SORTS everything..  
to practice in architecturally designing for life.*

# Life Force Cycle Map

(harmonic inclusiveness of charge density)

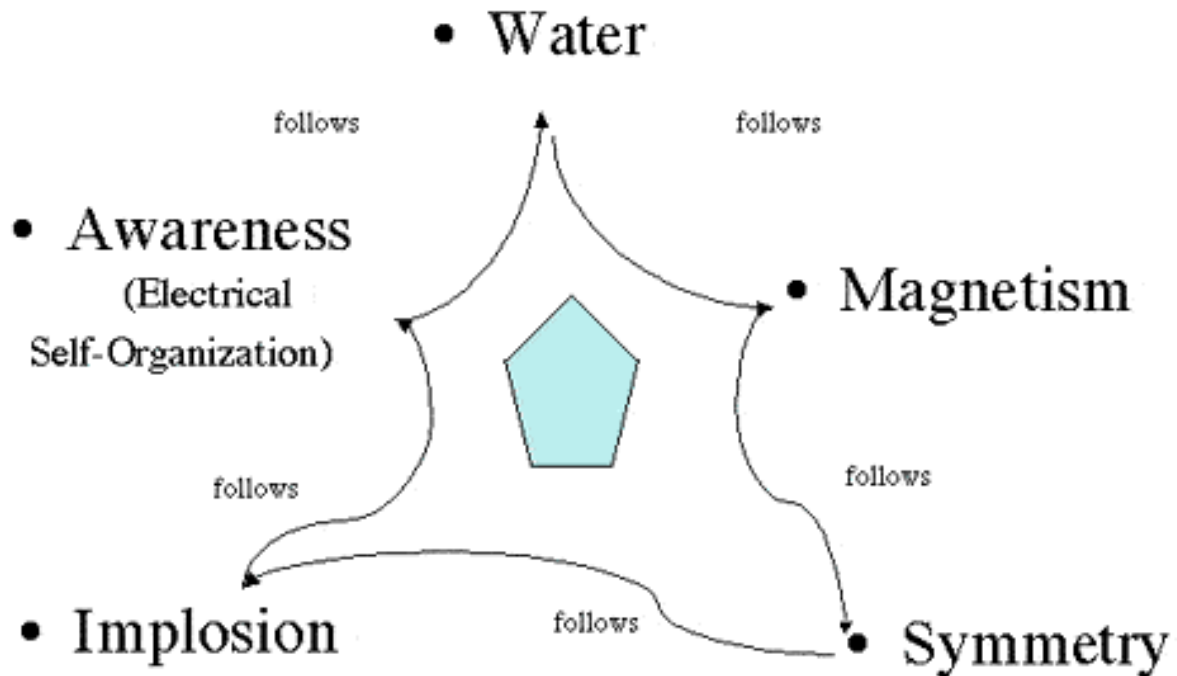

A good way to test our knowledge of how compression / implosion really works let us see if we can understand this axiom:

That - water follows magnetism follows symmetry follows implosion follows awareness follows water...

So - starting at the beginning - why would a water vein follow a magnetic line.

To answer this, - first let's ask why water would follow water.. Water that is really charge dense, is very self-aware - that is - able to electrically re-enter itself. Many examples of this are to be found in Schauberger - Living Water. ( ref url: [soulinvitation.com/water](http://soulinvitation.com/water) ). There is some interesting physics around the old saying that water built people as a way to move itself according to it's will. Here is an example: take a family of healthy kids next to a really healthy living river. Notice how many of them will at that moment have the urge to pee (urinate). This is an example for water wanting to return to the electrical fractal where all of its memories live. The physics is that the molecular electronics in water which HAS experiences implosion / fusion has a long term memory of the spin path back to that communion experience.

So, why does that water vein seek the magnetic line? First of all - notice how many trees take the shape of the magnetic line under their roots. If the tree grew up into a spiral helix like array, you can bet the underground magnetism is in that shape. The molecules of water because they are so wonderfully balanced between private sharing called covalent bonding, versus public sharing called 'ionic' bonding - always get their balance right between sharing their inner feelings with their outer ones. This means that water has an exquisite inner 'braiding geometry' which allows it to phase lock or entrain or embed in BOTH long and short wave magnetic lines. This inner braiding in water is sometimes described scientifically as the sheeting action which occurs in waters 'phil-lo' (as in the Greek Philo dough) dough like LAMINAR COHERENCE. If you could make a map of the inner fold planes in bread freshly kneaded by a loving mother - you would understand what happens to the ordering of the layers inside water ('sheeting') after it has successfully absorbed a lot of magnetic spin.

# Sacred Geometry, & The Flow

Flow Design from Daniel Winter & Friends  
winter@primeline.com

## Crystal Hill Multimedia

PO Box 142, Waynesville, NC 28786 USA.  
PHONE: 704-926-6062

### THE ULTIMATE NOZZLE STRUCTURE TO HEAL WATER?

What we need is a 60 degree cone shaped piece of metal, preferably silver or copper or gold or some metal with no iron if possible..

This is a side view of 60 degree cone on one end grooved with the spirals depicted here from three views. The opposite side of the conic nozzle cone piece facing the oncoming high pressure water, should be an idealized hyperbolic cone similar to the lowest coefficient of drag water nosecone.

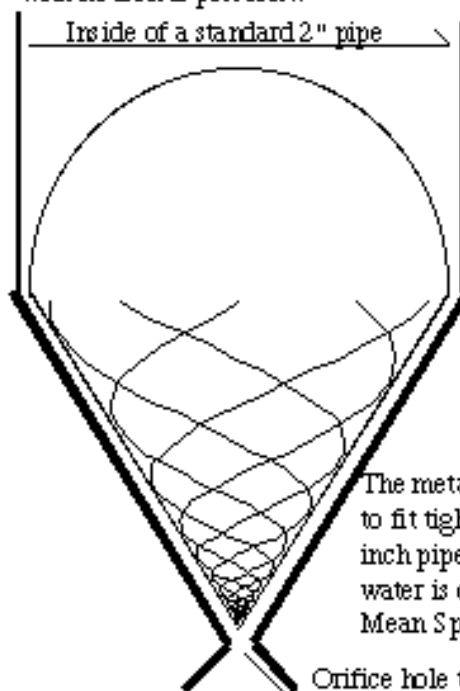

The metal pressure nozzle cone needs to fit tightly into the conic end of the 2 inch pipe so that the only path for water is down the grooved Golden Mean Spiral Cone.

Orifice hole to be approx double of cone grooves depth.

Water emerges here under pressure, have it's hydrodynamic laminar spin coherence increased dramatically. The scalar spin cascade optimizes translation of vorticity. Result causes increased spin density and coherence at laminar and molecular levels. Water will show dramatic and measurable increased seed germination rate, increased sedimentation segregation out of solids by mass for pollution treatment, and increased buoyancy (specific gravity). This is a much more powerful water treatment, taking the best of the principles of the proven flowform and empowering them by permitting the idealized water interference transform to be put under the necessary hydrodynamic pressure. This water will be biologically more healing for bathing etc. Not only once the principle is proven will this have planetary significance for water vivification (life means el tum into the eye of phi/recursion which is what this is), but it will then pave the way for accomplishing this idealized transform magnetically, for efficient translation of gravity to electromagnetism, weaning planets off fossil fuel to metabolizing starlight directly..

End view facing water discharge end of etches grooved into cone. 10 Golden Mean spirals phased at 32 degrees.

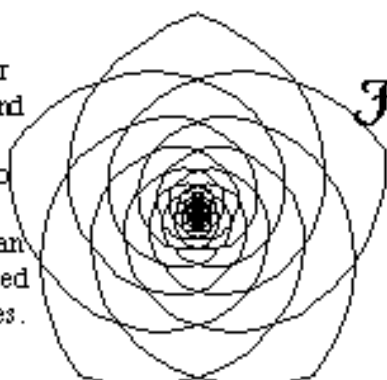

DNA Top Down View  
10 Golden Mean Phi Spirals

Falling in to Frequency Phi Ratio Lo-phi Love

Oblique view of these same spirals on the cone



The Origin In Principle of

Codex, Scalar Wave, Magnetic Monopole, Gravity, The Flow Form, Self-Awareness

Head Dimension  
BKG Harmonics at the Moment of Love, Sentic Wave Form for Love

Perfected Recursion Nestledness. Golden Mean Ratio Creates the Only Perfect Wave Fractal in 3D

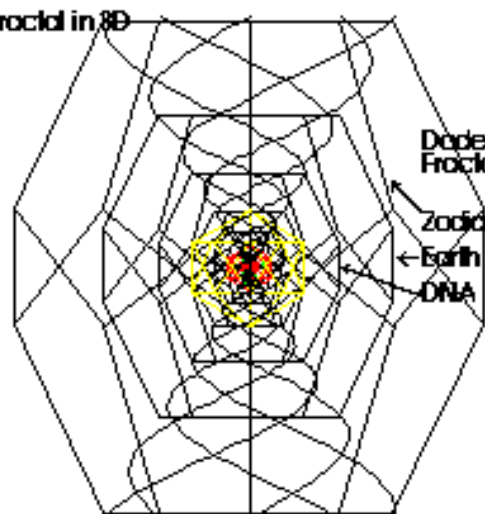

Only Wave Fractality Creates Gravity, Therefore... Only Love Bends the Light.

**Remember - in water and other fluid mechanic substances-**

**magnetic density equals spin density equals charge density equals harmonic density equals information density equals DENSITY.**

**So- water which has successfully eaten lots of charge and spin takes that inertia and tucks it always in nice reciprocal spins among many layers. Just as the loving mother kneading her bread always adds fold and NEVER tears.**

You may have already intuited why water begins getting colder when those inner spins in water become implosive in a vortex enough to generate power from gravity . When waves of inertia add and multiply recursively in only CONSTRUCTIVE interference then all the inertia is passed without heat thru the speed of light. (Heat is really only a name for destructive wave interference - so heat is the opposite of implosion.)

**In summary - these are some ways to measure life force in water: specific gravity (density) , surface tension, percent seed germination, rate of segregation of solid by mass / sedimentation rate, light scattering (coherent light is spread more actively by coherent water), and charge density (harmonic inclusiveness in the power spectra/harmonic analysis of water's capacitive field).**

Once these measures are understood, life force in water can be better served.

Now - let us look at our question another way. Why do you suppose the farm compost pile get's hotter when you steer magnetic lines into it, using paramagnetic stone dolmen? The reason magnetic symmetry builds 'fire' in water, is because it builds implosion. This is the fire that does not consume. It is the compression without heat. Water is designed in molecular symmetry to take spin into implosion, because the hydrogen at the core of water is the symmetry pattern slip knot for implosion which is also the core of the sun's fusion energy. (ref : [Heart of The Sun: Perfecting 7/5 Turning Inside Out Solar Heart Symmetry . url: soulinvitation.com/heartsun/HeartofSun.html](http://soulinvitation.com/heartsun/HeartofSun.html) )

So the compost pile eats symmetric magnetism by steering the angle of magnetism and charge into water . The water eats the spin angle information by learning how to crystallize into the molecular implosion called LIFE. For example, a pine needle turns brown in acid rain because the symmetry information of CHARGE from trace mineral leached from the ground, was needed for the water in the pine needle to learn how to organize it's molecules in more order than ice. Otherwise frost ruptures the cell.

Now - let us see if we have answered our question. The water followed the magnetism because magnetism follows symmetry - because BOTH WATER AND MAGNETISM as flow in form cannot survive (they cancel out) without SYMMETRY...

Then the rich possibility of having phi nested harmonics converging continuously permits the electrical 'multiple-connectedness' we call LIFE. As a result - each molecule of water is intensely aware of when it is next going to embed and get in touch with the infinite flow. This I believe is the specific reason you need to pee (urinate) just after the nurse turns on the faucet. ..

**The water knows....**

-----  
The more electrically fractal (charge harmonic rich) and grounded the water - the more it knows.

This forms the basis of our new measurements of life force - including in water (data plots shown earlier here).



## 12. Application of Pure Symmetry Science of Charge - (Sacred Geometry) to ARCHITECTURE: (reduction to practice)..

First, be aware that all spaces are electrical and as such feed or bleed bliss. Once we know HOW capacitive charge harmonically 'pregnant' with biological intent can feed peak experience, we can design for it - here are the essentials: ( The blissful, euphoric, charge rich, peak experience, healing .. SPACE.. would: )

**a.) Learn the basic rudiments of dowsing.** If necessary at first use rod or pendulum, but try to evolve away from externalizing the focus of your own sensitivities.

**FEELING magnetism is necessary to locate the path:**

**+ to water, + to birds, + to healthy home sites, + to where to put your bed, + to DIE successfully, + to LUCID DREAM well, AND to FEEL emotion!**

**Start on pleasant quiet piece of land in green nature. Notice which areas in the grass / or growth are happiest - notice which trees are lined up with other trees, notice which trees have a fork in their lower trunk - are those lined up? Notice is there Yarrow or fern or other plants which only thrive in fractal magnetics. Position yourself in a place where by walking 3 to 6 steps would cross an imaginary line between major sites where you noticed extra growth force.**

Now close your eyes, take a deep relaxing breath, wait til that settles to stillness, gently hold your hands out palm down like you were feeling wind from underneath you, and TAKE THOSE FEW STEPS. It is good to do your first work on a day when you are alert, and nourished with live food. See if you feel ANYTHING at all - as you pass over the line connecting 'where the grass is greener'. You might even work with someone who already has identified a magnetic line or two for you to experience. IT IS CRITICAL THAT YOU COME TO BE ABLE TO FEEL THIS FOR YOURSELF.

You may feel a little warmth -- or tingle. Don't hesitate to use dowsing rods at first if that feels comfortable. Remember - it is you doing the feeling - not the rod. The rod amplifies the reflex in your muscle to external magnetic lines. The primary dowsing sensitivities have been isolated to some extent in the work of Z V Harvalik, in the American Dowser's Society. A little patch of aluminum foil (don't you do this) just over the area of the pituitary gland, drastically reduced tested dowsing sensitivity . It is your bird brain doing this.

Imagine you are an Eagle navigating a great distance by recognizing the FEELING of the magnetic wind coming at you. It is as if you were the ancient Polynesian oarsman, navigating between remote Pacific islands judging direction by the ANGLE of a wave crossing your boat which bounced off a continent 2000 miles away. You feel it in your glands. In this case the long wave is a magnetic one.

Part of the tingle or warmth or presence you may feel when you get into a life force space, will be capacitive. HeartTuner is designed to measure life force, and electrosmog both inductively and capacitively.

When you train yourself - you will intuit accurate information about the source and direction of biological intent behind the flux density whose gentle push you feel. The important thing is to learn to FEEL.

**b.) Begin with a magnetic map of the area and the building site.** Some governments offer magnetic flux density maps. The best magnetic map is often the one you make yourself. Places where magnetic lines go straight for very long become pathologic (disease causing) because only bending into the dimple begins turning inside outness. That entering into tornados is what allows waves to compress and touch enough to SORT which of their charge waves have phase discipline / symmetry - literally - THE ABILITY TO BE SHARED. This is why LABYRINTH making can be so valuable - because if a labyrinth is centered on a natural magnetic dimple, uses certain stones (we will define 'paramagnetic' materials below), and the turn places in the land aligned well to the underground water and magnetism naturally fractal branching - THEN - the magnetism will be steered further into turning inside out - and feed the implosion fire LIFE force in the land.

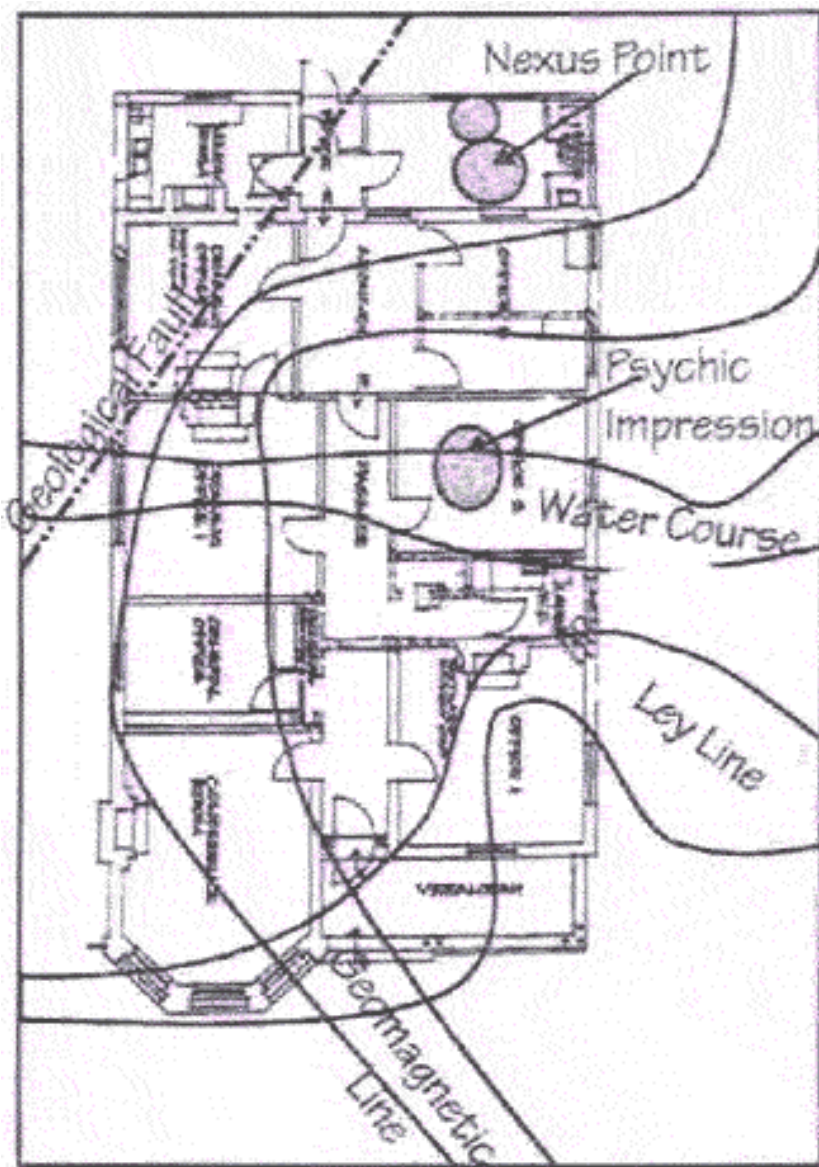

Left:  
 an example of Magnetic mapping  
 a dwelling area  
 from  
**Geopathic Stress In Our Homes ,**  
 by Kevin Masman

Consider that intuitive and dowsing  
 maps benefit from  
 correlation by electronic  
 measurement.  
 Example: Tri-Field Dosimeter  
 or HeartTuner  
 plus Inductive Coil  
 for ElectroSmog Mapping.

Also recommended:  
 correlation to  
 soil magnetic flux permissivity  
 (meter by Prof Phil Callahan -  
 Acres Magazine.

Below - All spaces Phi and Pent  
 - Can a Pentagonal Dodeca  
 be Projected on Flatland  
 - Courtesy 'Mackie'

This would be an example of  
 architectural ratios  
 which would be expansive  
 / membrane 'bridging' / touch permissive

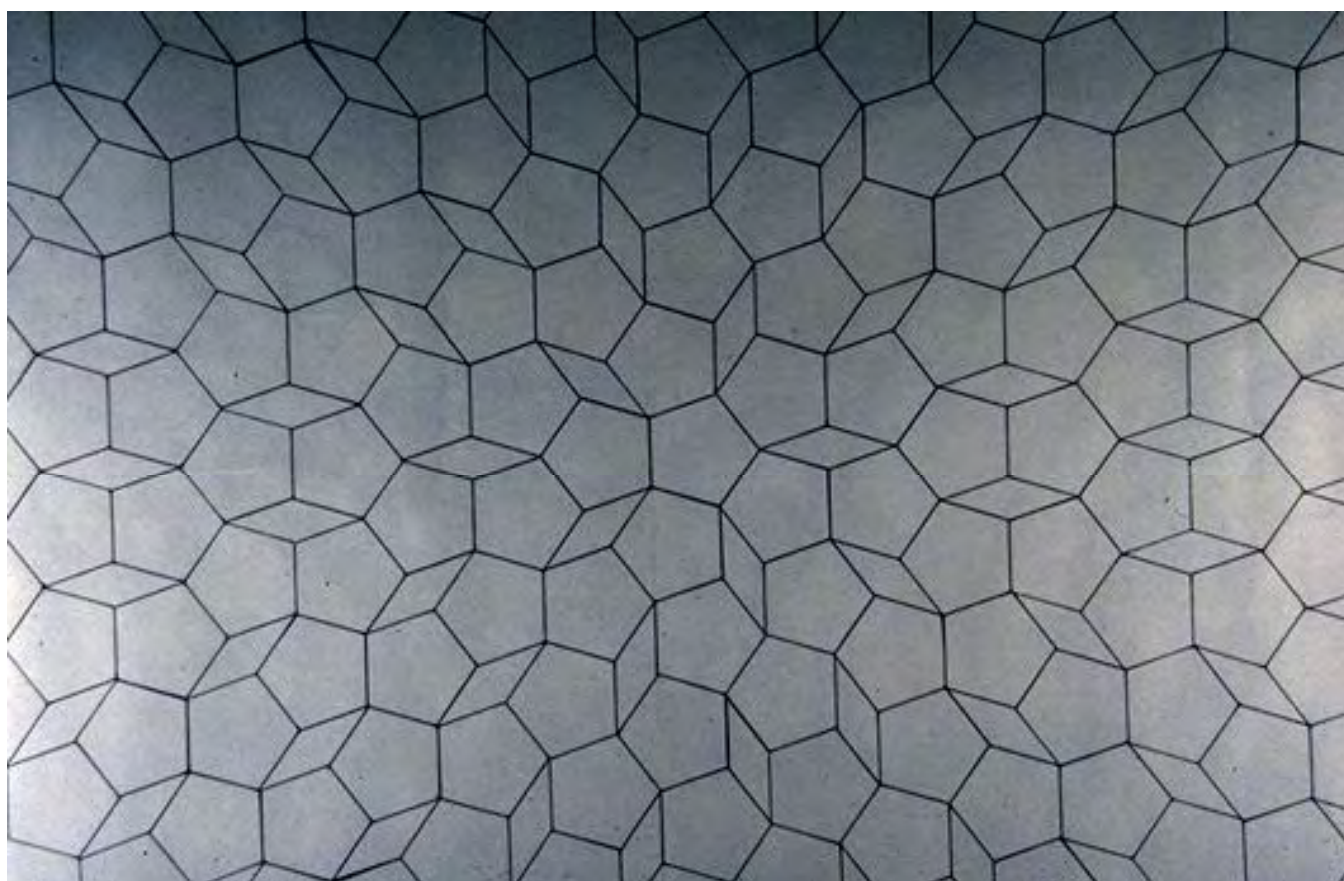

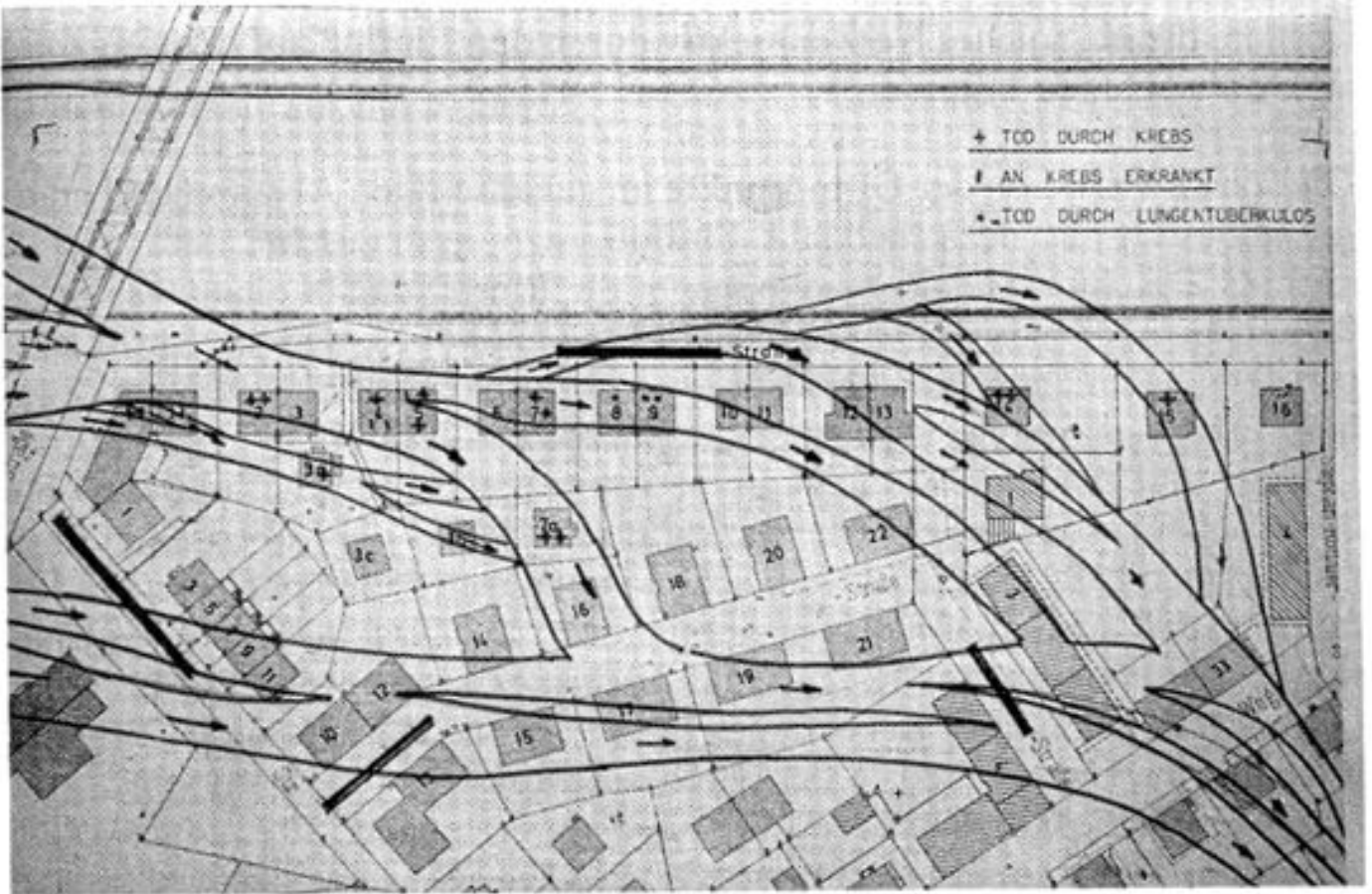

Above - the pictures of the underground water courses from the same Robert Endrös book:  
 Translation of Caption: Fig 71 (p. 169), Residential area over powerful underground water courses. Since the making of this map another 4 people died of cancer. text in upper right corner, from top to bottom: Death by cancer. Sick of cancer. Death by lung tuberculosis.

Water Veins Create Underground magnetic currents, which are linked to microwave currents which are measurable (Dratch et al.)

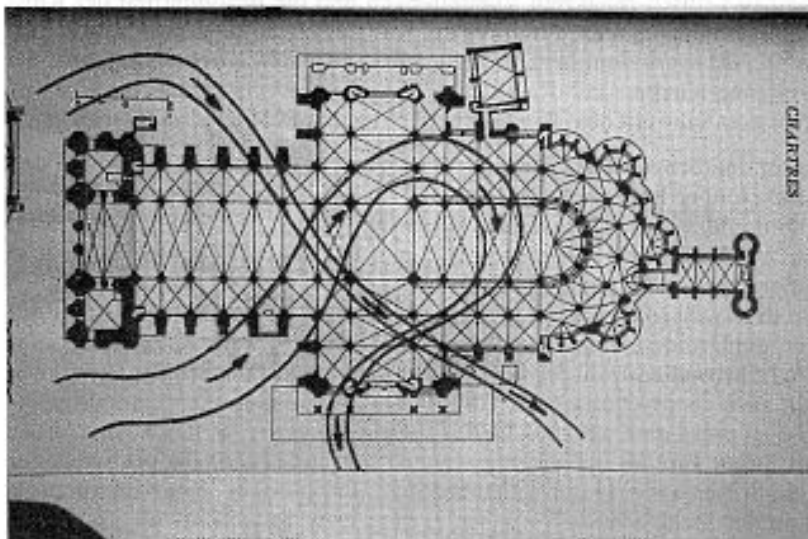

Mapping underground magnetics under Chartres.  
 .Translation of Caption:Chartres cathedral over underground water courses.

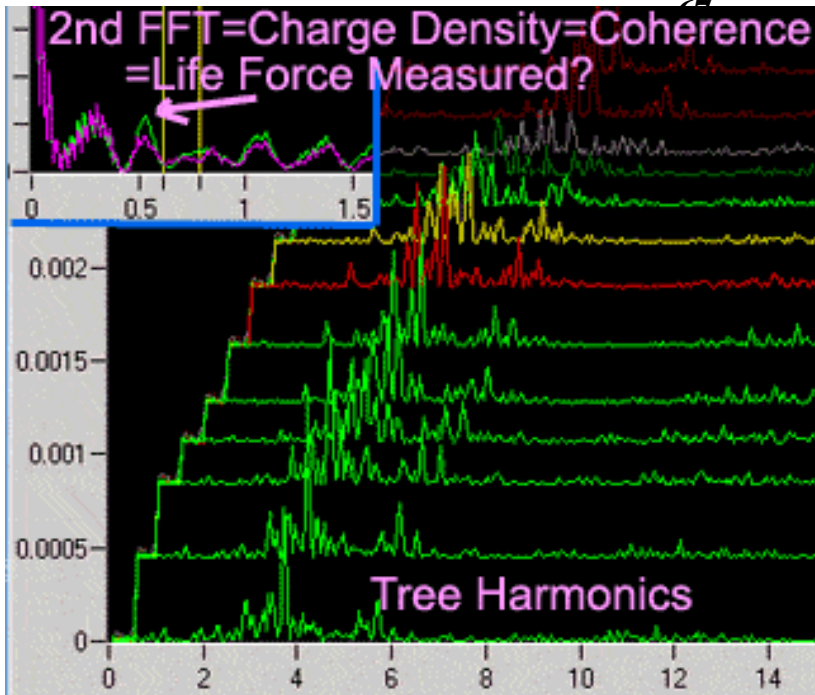

Left: Harmonic or Power Spectra of Capacitive Field (as suggested by Prof. Callahan measured in Netherlands using HeartTuner)

Below: Example of inexpensive inductive coil probe - which is connected to pre-amp and spectrum analyzer (HeartTuner)

Alternative Capacitive Probe..Hemp or Organic Fibres in Sea Salt or Sweat (Biological Capacitor)



Fine Wire Inductive Probe in Tree

Below: Healthy tree - capacitive measure 'Singing Away' with around 9 hertz and some higher overtones which may well be in the cascade which is the Schumann Resonance.

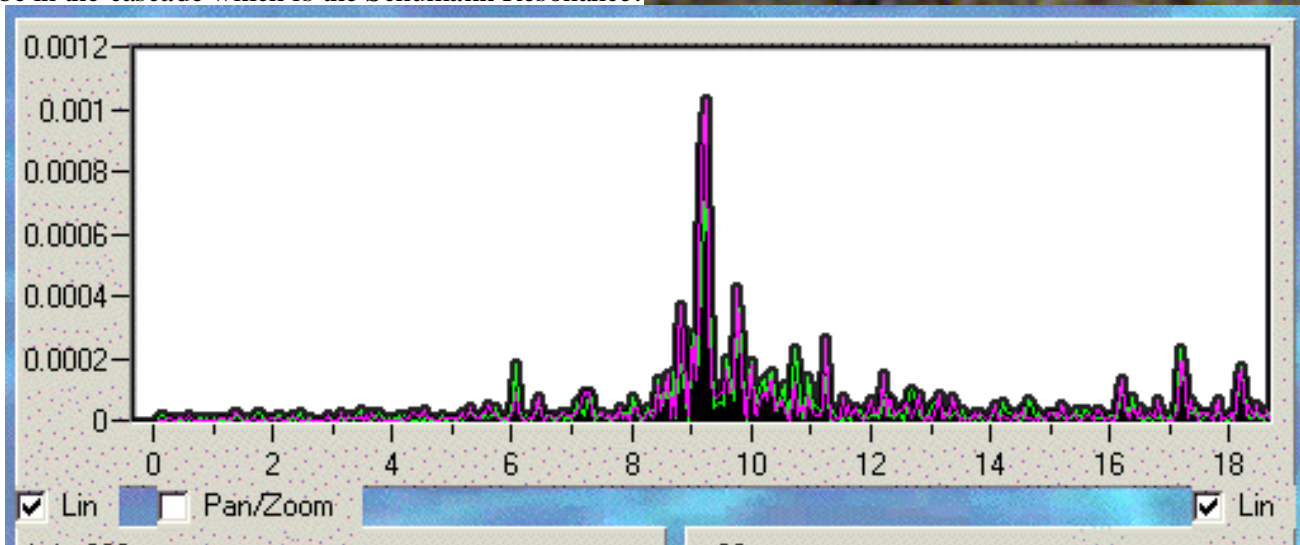

Below : Sick Tree- Prematurely losing green. The huge 74 hertz pathologic (not embedable) spike - probably killing this tree - was later found to be caused by nearby huge metal fence pointing in a line at the tree. Later - simply placing the inductor on the FENCE - with harmonic analysis - showed it was resonating at exactly this frequency - likely fatal to the tree. If only farmers knew how destructive large metallic objects field effects are to life!

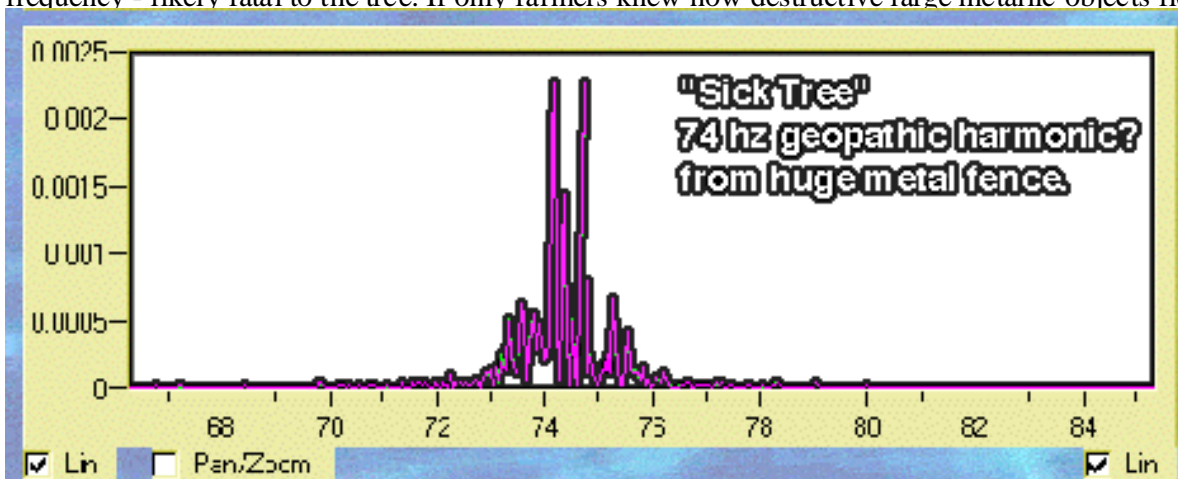

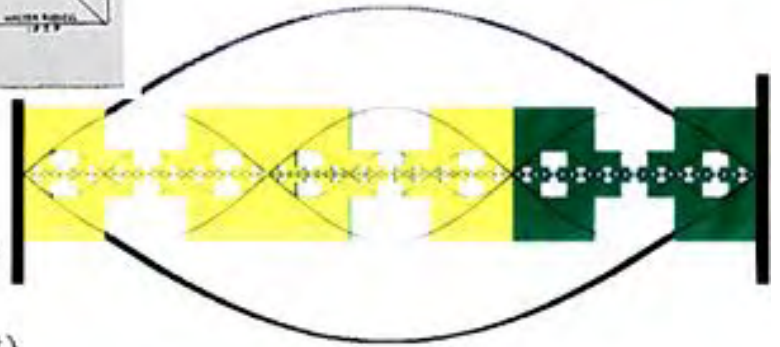
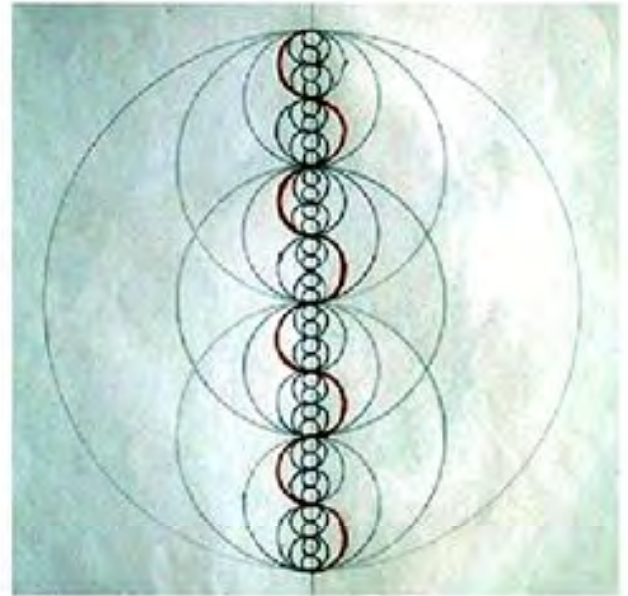
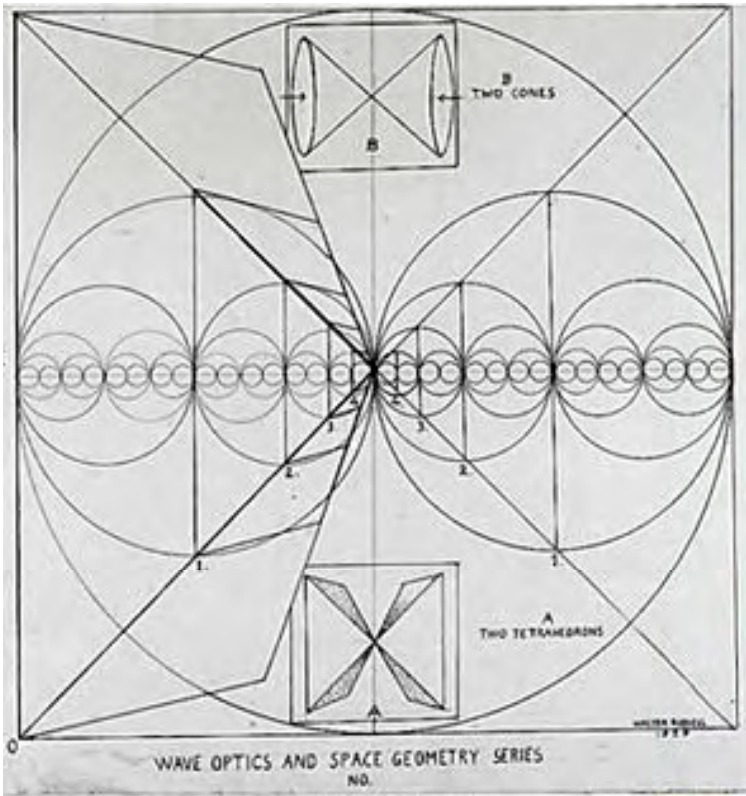

In-cube-8-ting Octaves:  
 Musical Recipe for Separateness:  
 (Brainwaves DISSOCIATE)  
 Inertia unable to migrate BETWEEN  
 frequencies:  
 (Cubic Architecture of A-PART-meant)

Above: Architecture based solely on CUBIC structure (log 2 edge ratios) in-cube-ates holding charge and emotion and FEELING within - because octave based harmonics start self cancelling when they migrate between frequencies. VERSUS below and right - beginning to integrate PHI, Golden Ratio, and the EMBEDDING of living curvature - structures much more able to steer charge into life give implosion. The essential principle is: Cube/ Octa/Hex -is for holding and making membranes (good for AIDS Patients), VERSUS - Pent / Phi structures which PROJECT & SHARE & Distributes (what a CANCER patient should have - who has too much membrane..)

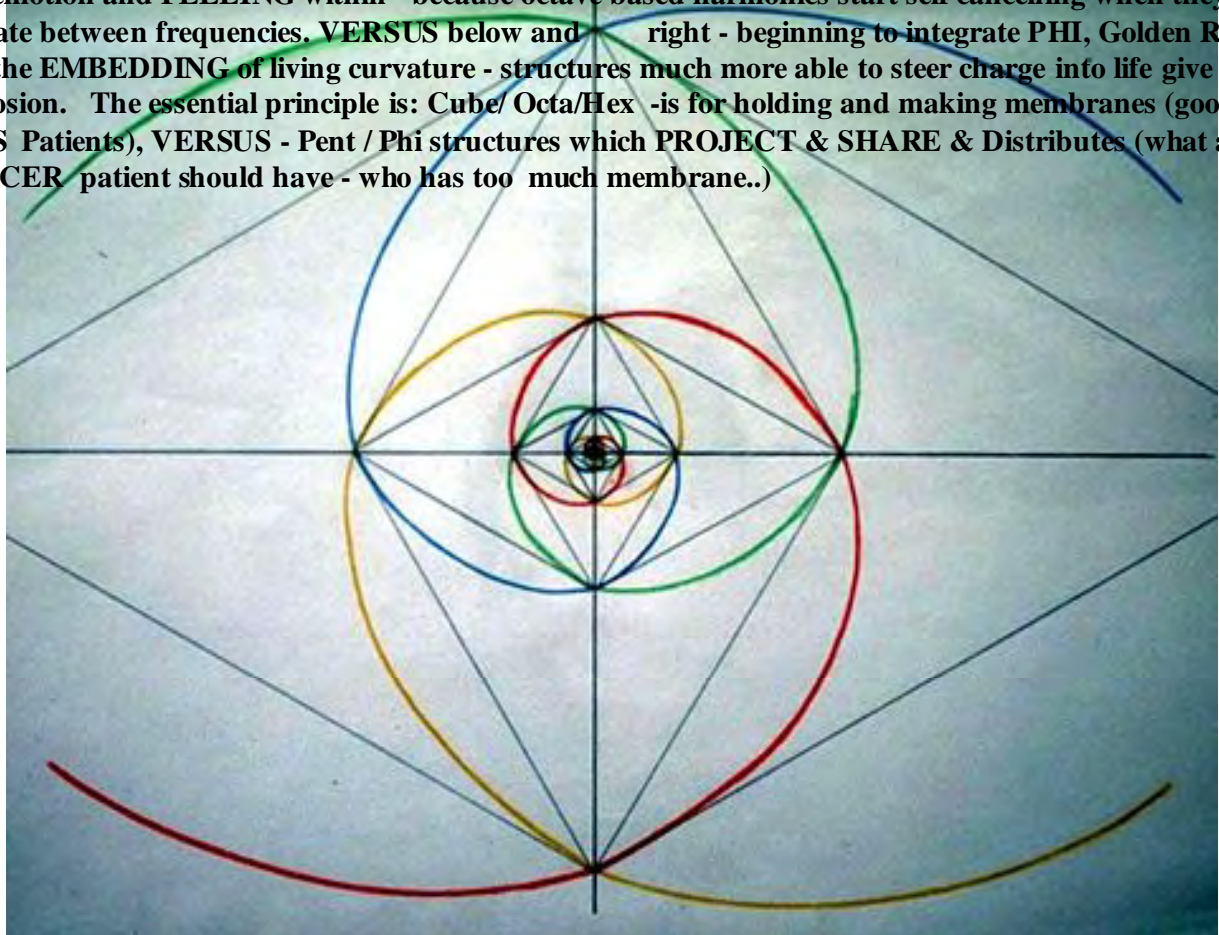

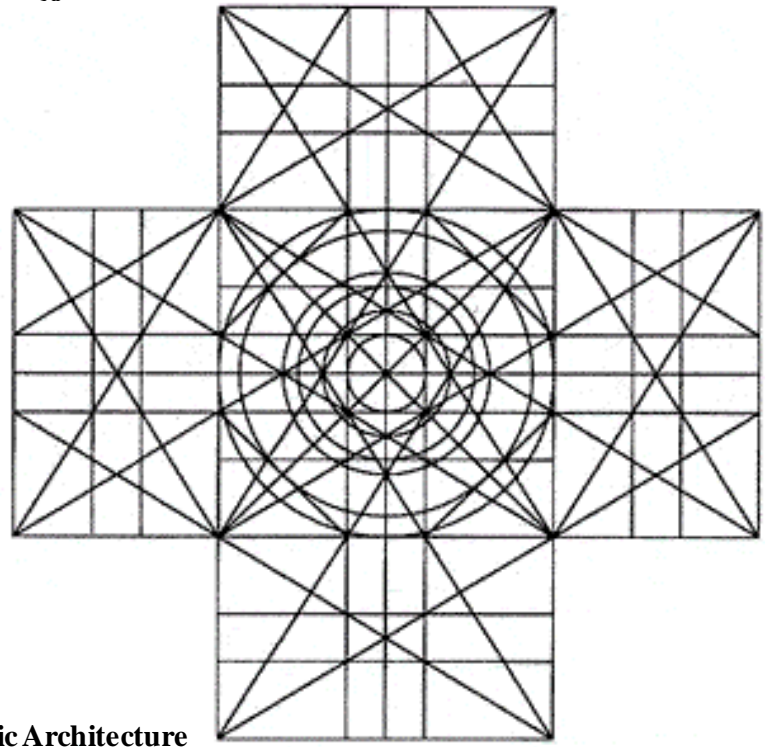

Holistic Architecture

- Based on Living Curvation & Sacred Geometry from Michael Rice [holisticarchitecture.com](http://holisticarchitecture.com)

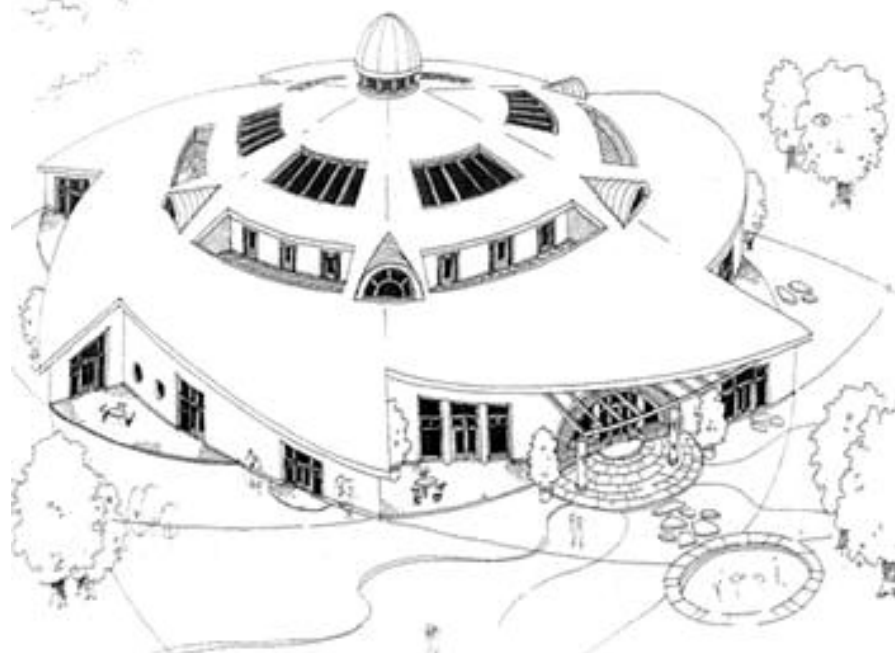
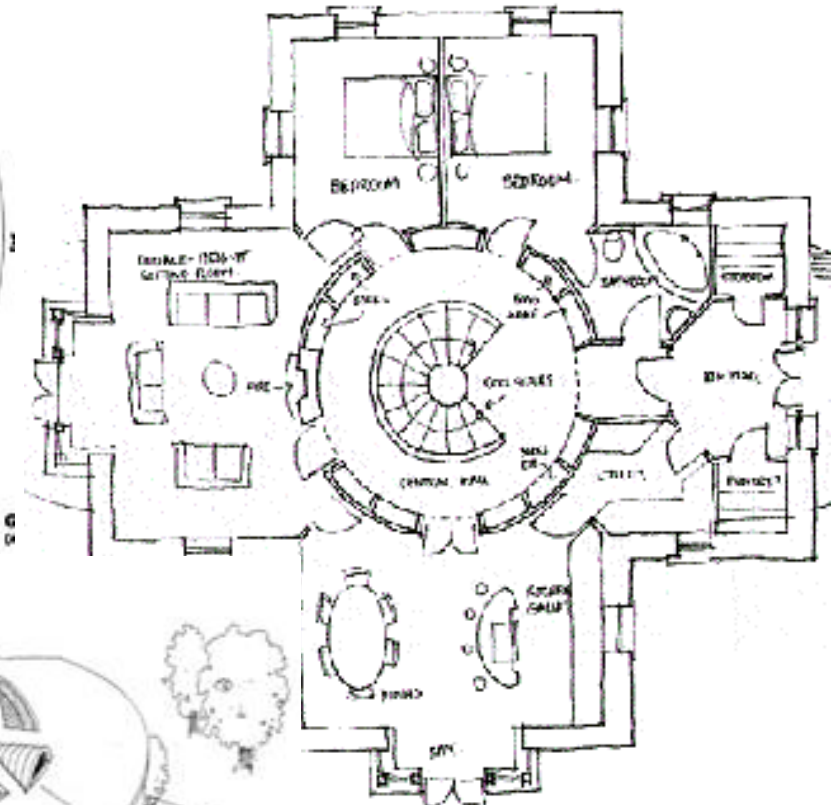

**Summary:**

**For Organic Architecture  
of FEELING Spaces-  
Hex 'Fixes' (holds inside),  
Pent Sends!**

**Use log 2 edge ratios  
in privacy spaces -  
use log Phi edge ratios  
in public /projective spaces.**

**Sacred Architecture:** Architecture to create and sustain life force - and make bliss sustainable - requires the skill to understand and design a biological capacitor. A bee hive - would be an excellent example. A squarish refrigerator or metal building would be an example how to DESTROY life force and bliss potential - because charge density bleeds from such structures. Concepts of sacred space and design principles: when does PENT versus CUBE HEX produce the right PSYCHOLOGY for space . Pent - create permission to touch, hex does not. Why do biologically based materials store life force - while very artificially based plastic or metal BLEED life force. Understand the meaning of a biological capacitor. Learn WHY a Waldorf school child is never allowed to touch or enter metal or plastic / only natural cloth, wood, and stone. Once you understand that every bond that is electrically fractal at the atomic level is a memory of charge and life - you will follow that child's example.

### 13.. Practical intro to **Principles of Rainmaking**

**The principles required to attract rain to a bioregion are so exquisitely parallel to those required to attract charge and life and bliss to an architectural building - these sections should be studied together.**

**Learning Geomancy by Learning Rainmaking - dedicated to Australian and all lands dying of drought..**

*The Sacred Principles of Symmetry to Restore “Wet-Making” Power to Your Land.*

*It is Feminine to Create Space -*

*Wave Patterns (like “Fractals”) that INVITE COMPRESSION - CREATE ‘SPACE’*

*To Do That You Add Magnetic Pattern In Order To Teach Waves - PERMISSION TO TOUCH.*

*When Waves Have This Non-Destructive Way to Nest Into Each Other -*

*Then The Water Vapour Molecules in The Clouds Have The Pattern of Charge They Need To Be Steered into SHARING SPACE (TOUCH) Called: MAKING A DROPLET (RAIN!!).*

*This is the Physical Science of Precipitation. ( [soulinvitation.com/rain](http://soulinvitation.com/rain) )*

- government agencies and official contact is invited for those wishing to join studies with Implosion group research groups in Perth, Byron Bay, Netherlands, etc. email: [implosiongroup@yahoo.com](mailto:implosiongroup@yahoo.com)

#### ° **Summary of the Electrical Principles of Rainmaking**

1. Water vapor is attracted to capacitive charge symmetry because water is highly paramagnetic. This means - the water molecule always decides which way to orient or ‘steer’ it’s bonding by ALIGNING itself using the local stored (capacitive ) charge field. This means that arranging the shape of the field effect around a good capacitor - explains:

a) the Immoto and Schweitzer and Sensitive Crystallization water picture..

b.) the Kirlian photograph

c.) the way [harmonic inclusiveness of capacitive charge MEASURES and DEFINES LIFE FORCE ELECTRICALLY](#)

2. The difficulty the water molecule faces when asked to assemble itself into a DROPLET which will then precipitate and fall as rain, is discovering how to arrange enough CHARGE SYMMETRY to become bonded, embedded and FOLDED INTO A (wave) ENVELOPE. Providing ambient electrical fields which steer charge into this ‘dimpling recursion’ / ‘turning inside out ness’ (see animations ) is the electrical solution to rain making.

3. Enveloping of fields gets ‘self-centering’ or ‘implosive’ force when (magnetic and capacitive) field effects are steering into DIMPLING RECURSION (see [‘Phiricais’](#)) - in the rain attracting ecosystem. In simple terms (turns), field effect lines need to be taught the symmetry recipe to turn inside out. When this happen, magnetic lines become magnetic circles.. Example - see the LABYRINTH animations below.

4. Providing the symmetry seed of charge aligned into a dimple, MAKING A TORNADO OUT OF MAGNETISM.. is what happens when highly paramagnetic biologic materials like cloud seeds, or paramagnetic dolmen are used to fabricate microclimate.

5. Mapping and then bending local bioregion long wave magnetic lines into these dimpling arrays, which produce ‘centering force’ / the tornado magnetic ultimately can be continent wide.

6. Things like metal structures, fractionated magnetic lines, electrosmog magnetic pollution, genetic monoculture, and lack of human bliss, prevent rain by preventing 'harmonic inclusiveness' (fractal ability to compress implosively in a self organizing way). Compare with how harmonic inclusiveness predicts viability medically in Heart Rate Viability - apply this to ALL biological oscillators - including harmonic inclusiveness (identical with non-destructive compression) IN THE LAND'S MAGNETISM

.see: [Harmonic Inclusivness:HRV and Emotion vs Care & Feeding of Immune Health \( soulinvitation.com/](http://soulinvitation.com/Harmonic%20Inclusivness:HRV%20and%20Emotion%20vs%20Care%20&%20Feeding%20of%20Immune%20Health)

***Short teaching stories - to precipitate moistly into awareness...***

+ Hopi aphorism: JUDGE A CULTURE BY THEIR ABILITY TO ATTRACT RAIN.

+ [Bill Witherspoon](#) - *carves a shallow ditch many acres across in the shape of a Sri Yantra - pours in paramagnetic sand - and measures a dramatic change in annual rainfall locally...What is the SCIENCE? (hint - magnetic and capacitive charge lines creating long wave columnation is the steering wheel for molecules needing direction to learn how to assemble themselves into a 'folded envelope' (raindrop!).*

+ *The Book: "Dance of the Trees" (Richard St.Barbe Baker ...'Men of the Trees')* describes the California city where there was a Eucalyptus Tree Forest on one side of town, and a Cyprus Forest on the other. The Eucalyptus side of town consistently got no rain, while the other side got lots of rain. Observing this - they cut down BOTH forests, and SWITCHED which side EACH was planted on. And sure enough - THE RAIN SOON AFTER - SWITCHED SIDES OF TOWN ALSO! — What's the SCIENCE ? ( hint look for the spectrum analysis of the charge field of the Cyprus Tree to be far more fractal or harmonically inclusive than the Eucalyptus. The Eucalyptus probably does not WANT rain - so is not built to attract it. The PINE tree attracts rain - see the geometry of the PINE CONE /implosion as a fractal to understand why. )

+ *Another helpful teaching story: The U.S. Army in the true oxymoron of Military Intelligence- went to a town in the US Midwest - and decided to "HELP" the town by taking the river that ran through the town - and Re-Engineer' - TO MAKE THE RIVER GO STRAIGHT - instead of meandering ALL over town. Shortly thereafter - all the major water wells in the town DRIED UP. The Army came back in, and re-curved the river - and then the water well levels returned! What is the SCIENCE? ( hint - read how charge density and the self-organization electrically is lost in water that does not braid - at [soulinvitation.com/water](http://soulinvitation.com/water) (nice pics) and in Schauberger: "Living Water" .. also Callum Coates books )*

+ [Marty Cain \(labryrinth installer\)](#) takes a small core of emotionally energized women to a magnetically crux spot in Vukovar, Yugoslavia shortly after the bombing war there measurably caused all the underground water to shrink back from the land surface. She installs a [properly dowsed labyrinth](#) - promotes intense healing dialog with the elemental forces - and the underground water re-appears blossoming underland just like a flower following magnetism.

**Hyper Donut - Turning Inside Out** Teaching magnetic lines the symmetry recipe to turn inside out (recursively) . creates implosions fractal attractor - 'burning fountain' which is BOTH [the key to making COMPASSION TEACHABLE](#) - AND - THE KEY TO ATTRACTING PRECIPITATION (RAIN)!

The [labyrinthine turning inside out](#) - is a projection of the [spiral moebius color donut map](#) - onto flatland..





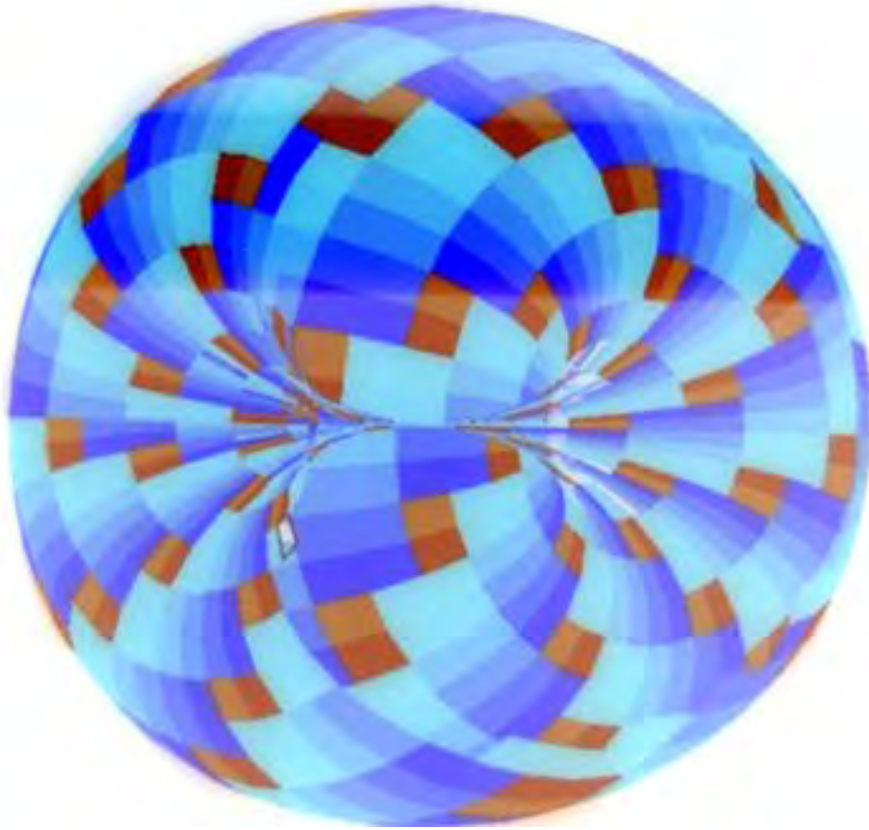

Steering magnetism into the symmetry to TURN INSIDE OUT (The LABYRINTH) CAN teach the magnetism on your land to dimple - and SORT and attract precipitation.

Learning to create a paramagnetic HEART to your land - uses the same symmetry - which for the architect would be the process of creating a paramagnetic HEART for your building.

When water braiding flow forms added magnetic coherence to the famous bank building in Amsterdam - employee absentee-ism went to almost zero!

*°Steps to Making Rain / Attracting life-giving electrical charge - Everywhere that CHARGE radiates, water is soon to follow. The geometry of (capacitive ) [charge radiance is the organizer of water - and DEFINER OF ALL LIFE](#). Does charge radiate from you? If not - then YOU are not in charge! ([hygiene links](#))*

- 1. Reduce Metals in Land Environment (Bleeds Capacitance / Bonds created in man made metals lack harmonic inclusiveness / fractality - the context rich embedding of charge which can focus water vapor). Exception - optional -a bit of gold or palladium at the core of your magnetic rose.*
- 2. Learn basic dowsing / Make a magnetic map.(of the major magnetic lines thru the property and buildings). If you cannot FEEL magnetism - ultimately you cannot feel.*
- 3. Use paramagnetic stone to 'lens' (bend and focus) the magnetism into fractal (rose) like patterns to attract charge - implosion precipitates rain. (Examples below - labyrinth and stone circle)*
- 4. Align the stone circle and labyrinth construction made of PARAMagnetic materials.. properly 'embedding' them on the ley magnetic lines*
- 5. Optional - spectrum analyze (harmonic analysis) to note where the weak inductive and capacitive fields are most harmonically inclusive (sacred) - to tune and perfect the magnetic wind harp which is your land.*
- 6. Use materials which hold capacitive fields once charged, to strongly radiate charge density - fabricating the field which will orient local water vapors into droplets. Cloud seeding is actually a primitive form of this. More advanced forms use - a highly charged capacitive chamber to piezoelectrically ring materials like calcite or calcium carbonate, or quartz sand - which then are spread into symmetry on the land to fabricate long wave converging lens like (rose like) structures to cause precipitation.*

*Examples here : Plocher's Lab in Germany ( [plocher.de](#) ) - using capacitive fields to zap / charge piezoelectric rock fines - then selective land and lake distribution - with dramatic success in water and environment. Plocher's group contact: [o.uilderks@plocher.de](mailto:o.uilderks@plocher.de) Recommend adding the physics of capacitive charge attraction by embedding - to that work. .*

*Parallel work - Ken Bailey in Margaret River - Australia, and Gary Skillen - Ontario, Canada.*

**FRACTIONATION OF MAGNETIC LINES IS THE CHIEF CAUSE OF DROUGHT. Learn the simple physics of fractality versus fractionation - AND the psychology. MONO-CULTURE CAUSES DROUGHT BECAUSE HARMONIC INCLUSIVENESS (fractality - which is required for anything to be alive) of CHARGE - IS IDENTICAL WITH THE RADIANCE GENERATED BY GENETIC DIVERSITY. Install extreme genetic diversity around your flower like labyrinth paramagnetic. Learn to talk to the elemental forces. Recognize how the magnetic dreaming lines of ancestors when tangled in the land - need sorting before rain can return. Ancient memories with great inertia must be made shareable / enter compression symmetry - before wetness (permission to touch) can return.**

To learn the principles of geomancy (magnetic grid engineering) for life force.. let us use as an example case - the situation of the average Australian land owner whose garden or farm is dying from lack of rain. The motivation and intent to restore rain is appropriate and healthy to restoring life in general - because the ability to attract rain is precisely identical with the ability to attract magnetic flux and charge density - which are how the information we call life is communicated. So finding yourself without the flow of water is the same as finding yourself without the flow of life itself - which is to be out of the flow of magnetism and charge.

So - how to get - 'back in the flow' is ultimately the same as the question 'to be or not to be'.

First: **THE THEORY - What electrical processes attract rain - then THE PRACTICE:**

This article will first then deal briefly with the theory and principle of what attracts magnetism / and charge and therefore water. But then the major thrust of this section will be to provide a practical sequence of steps in outline form, to restoring rain - and life.

The theory of what attracts rain and therefore life may be summarized in the following pentacle:

## Life Force Cycle Map

(harmonic inclusiveness of charge density)

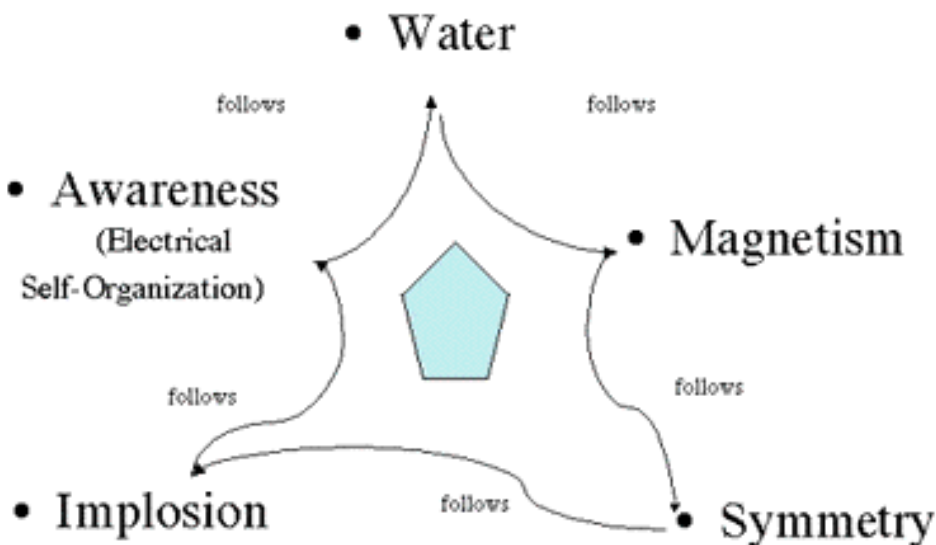

Water follows magnetism - because the water itself is highly paramagnetic. This means simply that most water contains enough trace elements to be highly piezoelectric - which is responsive to electrical fields. (Piezoelectricity refers to the ability to couple or lock together simple waves of mechanical pressure ('structure' / or compression) - often 'sonic or phonon' - with an electrical voltage and the current that induces. Piezoelectricity in slinky type structures like quartz and DNA are nature's way of connecting SHORT WAVES WITH LONG WAVES).

It is important to begin to get the idea - that to steer water around

intelligently in bioregions - you must understand how to steer electro-magnetic fields around with symmetry. This is because the two are directly coupled in their flow.

Essentially put - water IS the magnetic blood of Earth. And like the blood in your body, both the magnetism and the water in the Earth have to find symmetry or they die. Symmetry is required because it is the only way inertia can be distributed without destructive interference. Without symmetry (pretty rose like unpacking patterns) the inertia in the flowing water and magnetism would be cancelled out or die.

So both water and magnetism follow symmetry to avoid the death of destructive interference. Eventually you will get the idea that water molecules are not stupid- they will not fall into gardens or farms - where there is not enough magnetic symmetry - because they know that would kill them.

So we understand now - that we are going to need to restore a certain symmetry of magnetism - to get water back to the land. But how?

First we need to understand what KIND of symmetry of magnetic and capacitive charge flow MOST ATTRACT WATER.

If you cause water to flow in a line - you remove from it the repeated turning back on itself action called BRAIDING:

## FLOW-FORMS

**To BRAID in Water is to "RE-CORD"**  
**To make a CORDing is to make a Braid..**

**The Re-Cord point.. Is the turning  
 Inside out point..  
 Where "the tail wags the dog."**



**Golden  
 Ratio  
 Compresses  
 Spin & Charge.  
 Creating  
 Laminar  
 COHERENCE  
 -Supporting  
 Life Force.**

°7 Fold FlowForm - Creating Golden Ratio Beating -

Braiding allows water to cascade into COHERENCE. It is like a loving mother kneading her phi-lo dough into beautiful ordered nested layers - called LAMINAR COHERENCE. Essentially - the spin of the water at the macro-wave level is (by Golden Ratio) SPIRALED in "optimized translation of vorticity". This means that inertia that was more linear - can be translated constructively into much shorter wave length MOLECULAR SPIN COHERENCE. This ordered of the sheeting action - like sandwich layers in water is much related to water's healing qualities. ("Living Water" by Schauberger, Callum Coates books, and on a more technical level: "Electronic Biology and Cancer" Nobel winning Albert Szent Gyorgyi - that cellular water's more orderly than ICE - prevent cancer.)

Braiding  
**DNA**

is  
EMOTION  
the  
WEAVER?



The principle is that braiding allows the macro long waves inertia in the water flow to be continuously fed into the shorter wave spin at the molecular level. Absorbing more spin density at the molecular level - is stored in the water as LAMINAR COHERENCE. This means that the layered sheeting action of flow in the water becomes beautifully nested like the dough in Greek PHILO dough kneading. The result of all this spin density is HARMONIC INCLUSIVENESS - and charge density - and information density - and life force density.

The picture of the perfect braiding is a cascade like 'meander' which allows water's inertia into a cascade like 'spin path back to a zero point':

This was the logo for my original article: [Braiding DNA, Is Emotion the Weaver?](#)

This recursive braiding action in water can be optimized to produce **measurable improvements in water:**

1. ability to germinate seeds
2. specific gravity increase
3. surface tension
4. ability to segregate or SORT solids by mass for sedimentation and sewage treatment ( it is like installing the centrifuge type motion which allows your washing machine to spin out the dirt from the clothes)
5. amount of light scattering of coherent light - measured water changes caused by simply being on the body of a healer - in the work of Jim Patterson (later associated with Palladium Bead fusion work).
6. Charge Density - Harmonic inclusiveness of capacitive charge - measuring life force electrically -  
soulinvitation.com/  
biophoton

**The next step is to understand - that the limit or ultimate completion of the BRAIDING process - is to create IMPLOSION.**

Implosion happens when your braid begins to turn inside out.

- 
- 

"Sine Waves"



GOLDEN MEAN RATIO

PERMITS ADDING  
AND  
MULTIPLYING  
OF WAVES

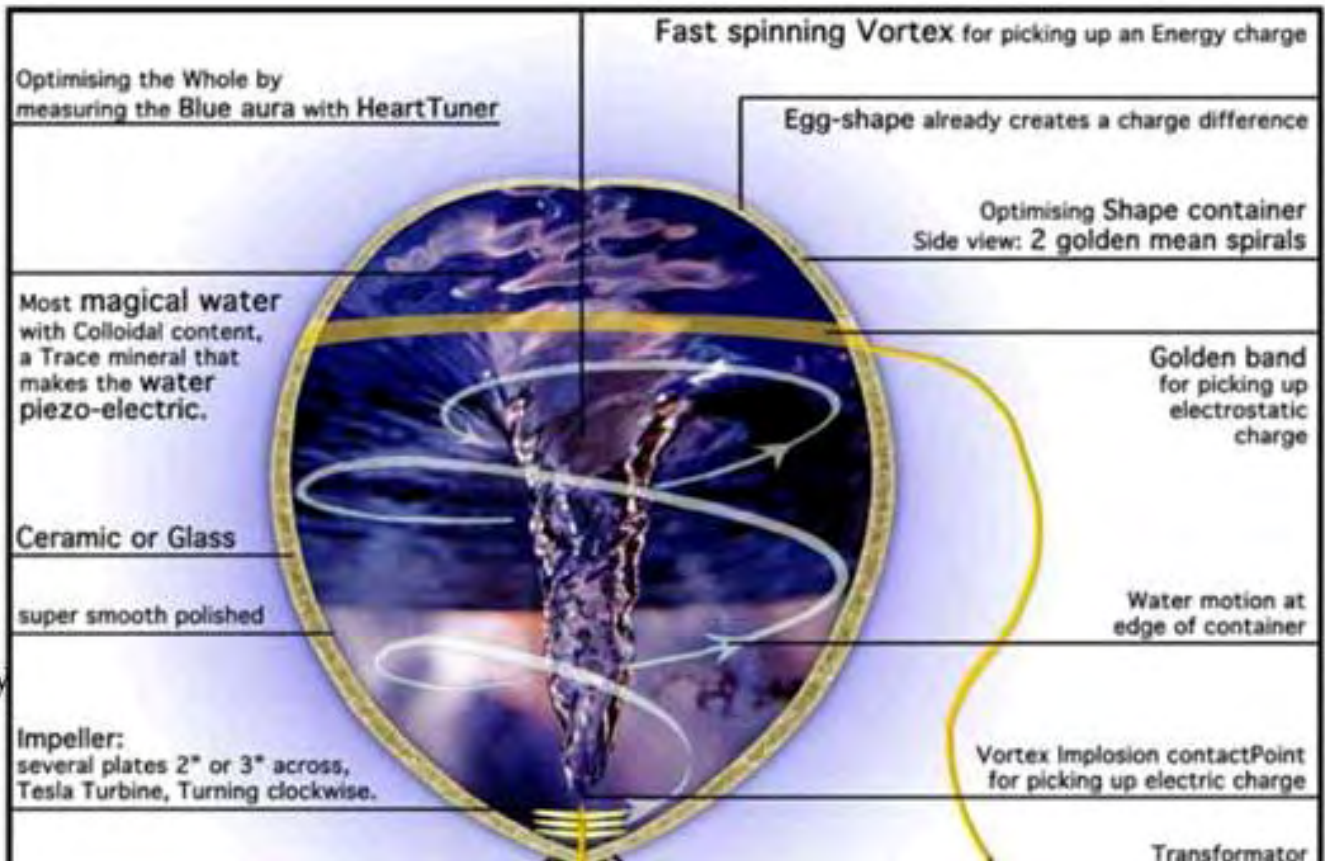

Drawing thanks to Jom Mols. - idea structure - Dan Winter.

In vortex implosion design - power out is the DC voltage difference between center bottom (+) and outer periphery - similar to the Faraday Disk Principle (magnetic monopole work). The source of power is derived from charge that is accelerated thru light speed - because the piezoelectrically 'doped' (mineral added) water vortex compresses charge optimally into recursion. (picture previous page bottom).

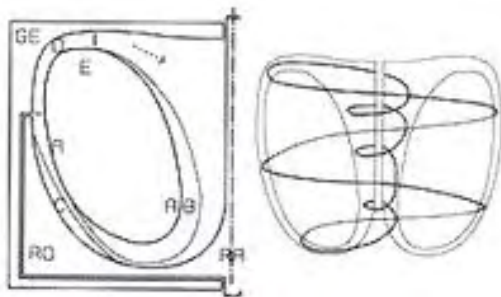

Schauberg knew the REASON:  
 His piezoelectrically (clay mineral) doped Water Vortex EGG was about to begin GENERATING VOLTAGE from GRAVITY – when it began “spontaneously” getting COLDER (heat is only a word for the opposite of non-destructive compression).

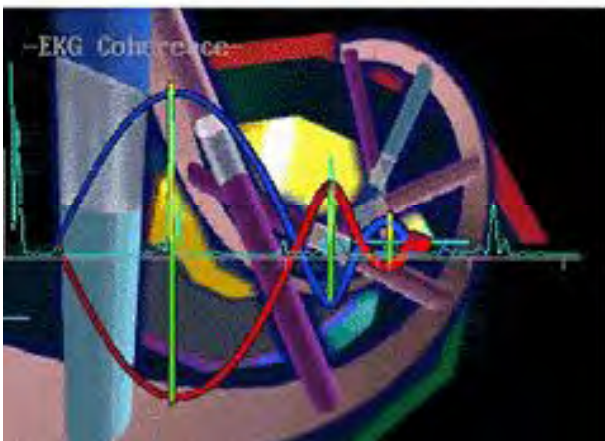

The REASON –  
 was Phi / Golden Ratio  
 Recursion Symmetry in the  
 (Charge) Vortex ...  
 IMPLOSION

These implosion hydrodynamic structures need to be tuned by (HeartTuner type) spectrum analysis (sonic / piezoelectric / &/or capacitive) to optimize for recursion creating PHI harmonic collapse compression cascades.



Thru this  
 IMPLOSION  
 Or ZERO  
 Point  
 ONLY  
 The  
 SHAREABLE  
 Or ABLE TO  
 GET IN  
 PHASE  
 WAVES  
 SURVIVE..



How IMPLOSION /  
 FUSION .. SORTS...



Surviving this Charge Compression  
 In DNA is the Key  
 to Successful Dying

Implosion Paths for 'Charge' seen in the 'Projective Geometry' Around a pine cone -  
 adapted from "Vortex of Life" by Lawrence Edwards..

The principle of perfect braiding, or 'pining away' is the steering of flow to a universal meeting or fusion or  
 implosion point.

From that 'point of perfect meeting' all  
 waves EMERGE SORTED..

Only 'shareable' waves which can  
 agree and get in phase survive..

This illustrates how implosion becomes  
 the principle of sorting for waves in  
 general.

In physics - this principle is called  
 'fusion' and 'phase conjugation'.

This is the source of the  
 DC Voltage measurable  
 in a fresh egg or pine cone  
 which quantifies life force.  
 (most eggs generate 2-10 mv  
 due to implosion / LIFE!)

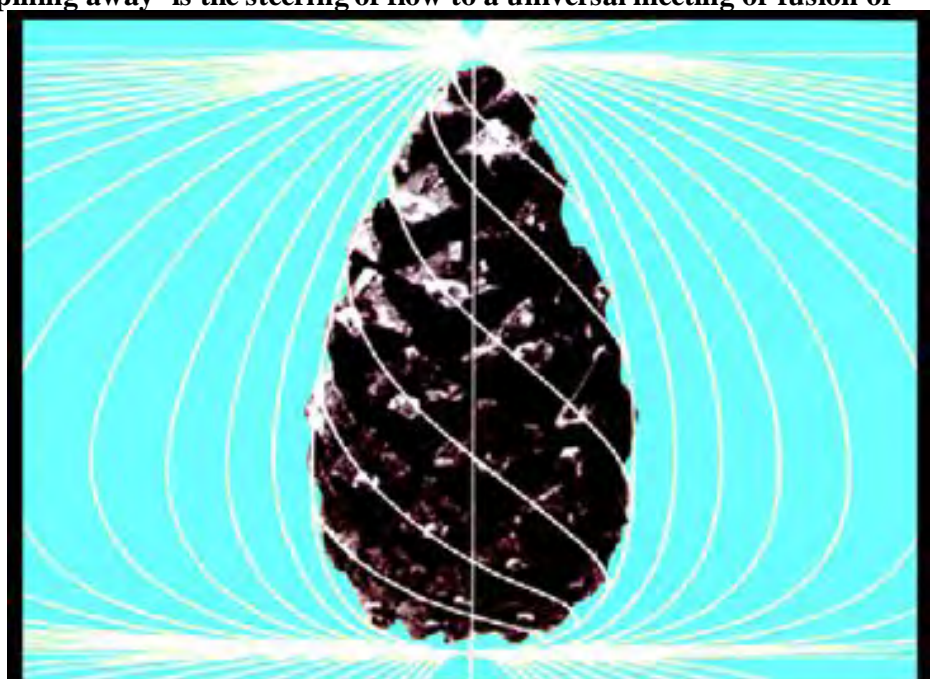

So: let us summarize the pure principles abstract here -

WHY is implosion / perfect compression producing FUSION and perfect SORTING - the solution to rainmaking and land healing?

First - what IS implosion:

**Implosion is a symmetry arrangement of waves such that the outer pattern is the same shape as the inner. The best way to visualize this is to consider how the outer folds of a rose mimic the shape of the inner folds. When waves get into this geometry - perfected by Golden Mean ratio - then something called repeated - CONSTRUCTIVE wave interference - allows those waves - to CONSTRUCTIVELY turn COMPRESSION into ACCELERATION!**

**This is the way infinite compression can be non-destructive. Waves when they cross in this rose like pattern ADD and MULTIPLY their wave VELOCITIES as well as their wave lengths. The term for this is called (recursive or repeated self-similar) 'heterodyning'. The point is this becomes an ACCELERATION path thru the speed of light. Once we understand how charge can be accelerated like this, we can understand how electrical circuits can make and harness gravity, because gravity is only a name for the acceleration of charge (which this fractal or rose-like 'self-similarity' permits).**

**Review the preceding page pictures to fuse this idea about implosion visually.**

**It is important to understand enough about implosion - so that you can begin to visualize WHY assembling magnetic lines into such repeated 'turning inside out' rose like patterns on your land - IS GOING TO ATTRACT RAIN ... ( hint we are soon going to introduce the function of LABYRINTHS to do this ).**

IMPLOSION: Key to BLISS, PASSION and ENLIGHTENMENT:

The FIRE of Passion- comes from the Heart,  
It is measureable in the EKG as COHERENCE,  
And the music of Golden Mean.

It is the key to all energy crises, yet simply depends on  
Understanding the PRINCIPLE of IMPLOSION.

This fire is what makes your energy field self steering.

"If you eat dead food instead of live, be grateful for the parasites  
this attracts to your stomach. They eat the death out of you.

If you eat a dead idea like "God is outside YOU" then be grateful  
for the Priests - the parasites to show you how it  
looks to die unhappy.

To be really alive and free- "Follow Your Bliss (be 'in charge') and Know What It Is".

If you want to read more about the SCIENCE behind implosion - try this link: [soulinvitation.com/phiricais](http://soulinvitation.com/phiricais)

[PhIRICAIS:PHI-Recursion-Induced-Charge Acceleration/Implosion Solution](http://soulinvitation.com/phiricais)

**When waves are invited into a center, where ALL the wave lengths can meet without hurting each other - this is called implosion. It is what creates centering force. This is the burning 'phire' of creation.**

**Now it is necessary that you begin to understand in practical terms - for yourself - exactly why doing this COMPRESSING / IMPLODING / TURNING INSIDE OUT - process - with magnetic lines - WILL ATTRACT RAIN TO YOUR LAND.**

Have you ever walked up to a really nicely flowing living river, and noticed that either you or your kids - at that moment ARE VERY LIKELY TO WANT TO URINATE (to 'pee').

It is a known fact that if a hospital nurse wants to get the patient to pee.. she loudly runs water in the sink. The simple physics is that **the electronic memory in the water molecules in your body, is intensely aware of the need to return to some master unity of flow.**

This phenomenon that the places you get the urge to pee, are 'cosmically chosen' (like marking the edges of your domain as a dog) — gives rise to the old saying: *"people are water's way of choosing where to move itself"*.

The reason the water in your body - (read the 'Dune' books) is so self aware, is that the molecules in the water have billions of years of memory of the skill to turn inside out / self re-enter. This gives the electrical fields in water the ability to propagate their field effects over large distances. This phenomenon of the skill to spread a self-organizing electrical field over larger and larger distances based on self-referral / self re-entry is called CONSCIOUSNESS.

Water that has been allowed to BRAID and nest and spin and absorb CHARGE is highly CONSCIOUS.

Water that has been forced to go straight, or stored in metal, or stored under pressure, or experienced too much heat - becomes DEAD. (bleeds capacitive charge - and charge richness/harmonic inclusiveness).

Read 'Living Water' by Schauberger -

or see [Healing Water Using Geometry in Flow Form soulinvitation.com/water](http://soulinvitation.com/water)

Your job is to make the water on your land more charge dense, (information dense) and therefore more conscious (that is electrically self-organizing). This will cause other water molecules to want to join it. This is not magic - it is simple physics. Morphic resonance is a name physics uses when they want to talk about why a particular shape attracts other fields of the same shape. (read: Rupert Sheldrake, et al.)

Morphic Resonance is based on RESONANCE. Harmonic analysis of resonance is how we can measure the life force in your water - or in anything alive. [soulinvitation.com/biophoton](http://soulinvitation.com/biophoton)

--

Let's tell **the story of the life of a water molecule in a cloud - deciding where to rain** - as if we were talking to a child.

The water molecule is floating gleefully in a white puffy cloud - dancing in the sun. The water molecule stays light and floaty as long as it does not link up with too many other water molecules. Once in a great while scientists make the water molecules become rain by dropping 'seeds' which are little charged mineral crystals into the clouds. Cloud seeds work because they create an electrical field of 'charge' which steers the water molecules like little magnets into the tilt positions necessary to hook the molecules up with their neighbors.

The important thing to remember that it is the shape of the field of electrical charge that ultimately steers around the water molecules. The question is - how to make the separated water molecules decide to gather into shared 'wave envelopes' called A WATER DROPLET (hint - this is RAIN!!!).

What tempts water molecules to experiment with touching - (making rain drops) - is the SHAPE OF THE FIELD EFFECT OF ELECTRICAL CHARGE - which is steering those molecules around.. This decides if the 'business-end' (the bonding points) of the molecules - can TOUCH - and share space non-destructively.



A deep principle is that **'all bonding is phase locking'**. This means that waves coming from opposite directions must line up and get exactly into PHASE (like linking heart beats to make love, or linking clock pendulum in a room). This permission to share wave space - is called CRYSTALIZATION - and the experiment in successful sharing which results is the very essence of the principle named 'CHRISTOS'. (Hint: it means total sharing is possible in a completely safe space - eliminating the need or possibility of secrets ... for waves and people).

The neat thing about WATER is that the 2 basic kinds of bonds in chemistry are perfectly balanced. These are called IONIC versus CO-VALENT. And for our child's conversation here, consider water's perfect balance between these two types, as the perfect tightrope between short wave - local bonds - versus longer wave - more collective extended bonds. What this means in chemistry - can be expressed very socially: that because of this balance between ionic and co-valent bonds water molecules are exquisitely able to THINK GLOBALLY but ACT LOCALLY!

Another thing about water that is helpful to know - for our continuing kids story .. is the ASTROLOGY of CHARGE in water. This means that when waves of charge are gathered in perfect compression into water - the memory of exactly where that charge came from is kept in perfect context. Moving electrical charge (stored in the form scientists call CAPACITANCE) - is the physics of astrology - and does go lots faster than light. So if you grow a water (or quartz) bond nest very slowly - each time a new bond is formed - it makes a harmonic sample stored of the shape of all charge waves coming from every star at the moment of the birth of the bond. (This shows up if you do a musical analysis of each bond like a spark gap nested - 'infinite series').

Take the example - of a quartz crystal grown too quickly in a cooking pot in an electronics lab. That crystal when held in your hand feels like a pate foie goose liver which has been too quickly stuffed. Now you take a similar sized crystal that took many thousand years to grow, and holding it you get pictures inside your head of the shape of all the land around where it grew.

This is because the capacitive 'charge' spinning out from each bond - has more harmonic inclusiveness and more memory in bonds that were formed slowly and in context.

This explains in part why certain waters that come from very ancient ices are so healing. They are charge dense, information dense, and spin dense - electrically.

Now- back to our little molecule (Mr. H 2 You - Owe to Me).

Suppose you the molecule were passing over a farm, where they had put in lots of metal fences, metal roofs, metal buildings, and planted huge plots on mono-culture crops. (One seed - no variety).

Being a reasonably clever water molecule - you are pretty skilled at not getting yourself killed. In magnetic theory - being KILLED has a very particular meaning. Essentially - to be killed - means to have all your SPIN collapsed into no spin. Remember that spin 'density' is awareness and information density. So for a water molecule - SPIN IS LIFE!!!

Why would falling onto a farm with too much metal, and no magnetic long wave pattern, and no genetic diversity (and probably no bliss dancing) - be FATAL for a water molecule???

Because SPIN requires symmetry. The water molecule - speaking at the international conference of water molecules for a better life - election speech was called: **GIVE ME SPIN SYMMETRY - OR GIVE ME DEATH!!**

(Apologies to Patrick Henry here).

No scientist would argue that the bond that keeps hydrogen hooked to water requires precise symmetry. OF COURSE - extending that symmetry is critical to get LOTS OF WATER MOLECULES hooked to each other.

Remember also - that the only thing which makes water molecules heavier than air enough to fall to your land - is when they HOOK UP into WATER DROPLETS. To bond the little molecules into extended families so they fall on your land - someone has to teach them how to nest! The angle of waves of local CHARGE and MAGNETISM in long wave patterns - is what teaches the water molecules how to SHARE SPACE- and

become a droplet. This is called the **principle of precipitation** - and it is based on how **waves nest and become a wave envelope** ONLY if short waves nest well (non-destructively) into LONG WAVES!

Let us look at some examples of RAIN MAKING historically to better 'grok' these principles.

Many of you know of the ORGONE (Reich) work . (read James DeMeo and also : [DESERTIFICATION, Patriarchy and "Hard-Making Power"-Politics that Prevent Touch - Prevent RAIN!](#) .important reading for our rainmaking students)

The Orgone rain makers are very successful in a limited way - the problem is that they have not used the correct terms (Capacitance - and harmonic inclusiveness creating compression) - instead they became stuck in un-shareable terminology like ORGONE. But there are some nice things we can learn from them.

A classic way for an orgone engineer to make rain is to take pipes made of a white plastic which will columnate or organize microwave and capacitive charge - and place them in a group - stuck one end in a really live river, and the other end pointed at a cloud they want to 'bust' or make rain.

The successful physics is easy to understand. The pipe points and directs a 'columnating' or organizing capacitive (charge) field and a microwave field at the cloud. The clouds water molecules are suddenly electrically oriented to more long wave enveloping symmetries by that field, and form droplets.

In Trevor Constable's film - "Weather Engineering on the High Seas", he shows that the most successful rainmaking capacitor (they call conic capacitors Orgone accumulators) is a CONE in exactly the 60 degree angle which makes the implosion angle in the dodecahedron nest in the above pictures!

**Sending waves of capacitive charge into a field producing collapse- makes rain.**

**Biologic sources of charge ultimately RULE - pure mechanical and metallic and non-fractal or harmonically inclusive sources of charge POISON. (because they do not produce the centering implosive force necessary)**

(see also : [The Perfect Geometry of Wave Collapse - Neurophysics Solution the Nature of Consciousness](#) & - [Fusion-Phi Phenomenon-Unlocking Ultimate PHire.](#) ) [soulinvitation.com/collapse](http://soulinvitation.com/collapse) , [soulinvitation.com/fusion](http://soulinvitation.com/fusion)

Now we want to do 2 things to extend our understanding of these principles of rainmaking:

**1. Understand why most children who spend a lot of time blissful and barefoot - can make a hole in any cloud they choose, by merely focusing on it.**

**and**

**2. Understand why labyrinth and stone circle making - properly dowsed and embedded on your land - will attract rain.**

The principle which allows blissful kids to make rain if they focus is the powerful coherence field - both ultraviolet, microwave - and capacitive of human glandular bliss.

Reading suggestions: [Kundalini: A Web Conversation](#) :, [soulinvitation.com/kundalini](http://soulinvitation.com/kundalini)

Politics of Bliss - at - [Science of Bliss & Peak Experienc](#) [soulinvitation.com/rainbowserpent](http://soulinvitation.com/rainbowserpent)

Cohering an ecosystem magnetic braiding which effects weather patterns the size of continents is everyday work for kundalini - as Tutankhamons priests well knew regulating the timing of the Niles flood - but this is advanced material - (see kundlini link) let us limit this conversation to our childs view of how to bring RAIN to the FARM!

Meantime if you ever do have the chance - check for yourself to see if your local clouds respond the moment blissful kids dancing barefoot in mud - decide to hold hands and touch!

Another way to ask the drought question is - when was the last time blissful kids touched while dancing barefoot in mud - on your farm?

*(In other words - maybe the only way to BE a culture is to know how to teach bliss??? - because every other way of being human - living without passion- is un-sustainable electrically.)*

But - let us walk before we run - so we will learn the magnetic hygiene here - necessary to prepare your land for RAIN!!

(which just happens to be the same magnetic hygiene necessary to prepare your land for blissful kids dancing barefoot - *touch permissively* in mud).

### **Labyrinths and rain making:**

A labyrinth is a way of aligning long wave magnetics to teach them to dimple, and to tornado, and to turn inside out. This takes long magnetic lines - which have gone in a line too long and become PATHOLOGICAL - and teaches them to get spun out in a circle. This permission to touch - creates compression. AND COMPRESSION IS NATURE'S ULTIMATE WAY OF SORTING OUT EVERYTHING!

It is important if you wish to learn some important tools of labyrinth and stone circle making at this point - that you study some of the visuals etc. at:

[labyrinth how? soulinvitation.com/labyrinth](http://soulinvitation.com/labyrinth)

o

### **Steps to making your labyrinth:**

1. Learn to make a simple map of the major magnetic lines on your land. If you have no clue how to feel a magnetic line, by all means consult a dowser - but remember 2 things:

a.) If you CANNOT feel magnetism then YOU CANNOT FEEL!

& b.) It is OK to begin your dowsing with a rod or pendulum but always aim to eventually feel magnetism directly with your body (this avoids un-healthy dissociation of you from your tools)

Clues to your magnetic lines are - where the grass is greener, where trees have forked low, in a row, where stones and paramagnetic structures have made lines in the distance, where natural features - rivers, streams, mountains - have started a pattern of magnetic flow near your land.

(Remember a magnetic map of everyone's bed in your family is probably the greatest health restoring tool you have - AND that if your BLISS is to be sustainable - when you begin to implode - suck your whole electrical environment into your body rapidly - THEN your back yard must magnetically look like a rose - otherwise your bliss will 'drive you nuts'.. be un-sustainable.)

Once you have the CROSS point of magnetic lines - you probably have a clue to where the underground magnetism and water most likely have their greatest vertical or upwelling dimple. This is called a water ('gnome') dome or djed. You are about to Raise the Djed into your Djed EYE - by drawing the sword of magnetism from your stone.

When water takes this blind spring upward underground following magnetism - you have the makings for Cathedral - which means - place of leverage on the blood (Catheter) of (Cathartic) magnetism.

The central place or tree structure which orients the underground water and magnetism in this water dome (which also will be the implosive phire to attract the water from the sky) -

always produces branches which move outward in an ODD NUMBER of directions. Water branches underground - like magnetism does- in these ODD numbers, because symmetry lines on a platonic solid always branch in ODD numbers. Water - NEEDS symmetry!!

You are learning this because in order to steer water, you need to know what it likes.

Next - **MAKE A SIGN OF THE CROSS** - where the magnetic 'blood' major cross upwells on your land -

(a good place to start is near wherever your land is closest to being still wild - if possible - elementals are more likely still alive there).

ONCE YOU HAVE MADE YOUR CROSS - LEARN THIS LITTLE PATTERN (think childish delight while you do it)..



(from [Sacred Labyrinths with Annette Reynolds..](http://SacredLabyrinths.com) NOW AT: [sacredlabyrinths.com](http://sacredlabyrinths.com) )

Learn the simple joy of making a series of walking paths that teach your lands' magnetism how to dimple and turn inside out and compress and implode and sort — AND ATTRACT RAIN!!!

The material for your labyrinth should be paramagnetic stones (size variable - material - quartz / granite or limestone base is good - / sandstone /dimagnetic is bad).



This article cannot be a complete guide to labyrinth building - use the above links - the purpose here is to show you THIS PRACTICE IS EXCELLENT PHYSICS FOR ATTRACTING RAIN.

Labyrinths get powerful with added attention - just like babies.

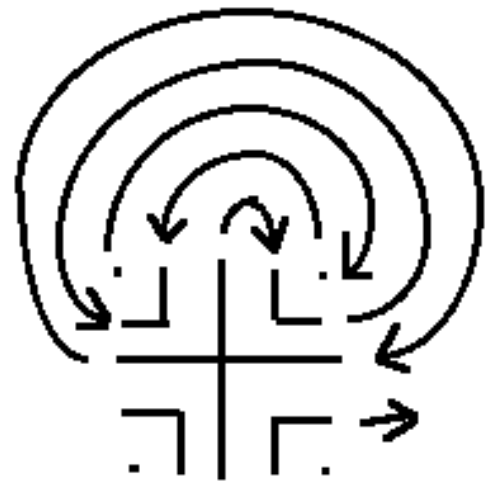

First layout the 'Emerald Cross' as shown -

then - alternate directions as you wrap back around, always starting just across from where you finished looping over the top. Start at top center, finish at bottom center. (Nice Metaphor ? )

Next clue to rainmaking:

**The reason that monoculture prevents rain is that fractal implosive compression (sucking in charge) requires harmonic inclusiveness / genetic diversity optimized. Harmonic inclusiveness means HOW MANY DIFFERENT WAVE LENGTHS YOU CAN ATTRACT TO ONE PLACE IS THE ULTIMATE PREDICTOR OF VIABILITY!!**

( read: Fractality in Heart Rate Variability - [The Origin of Disease and Health Heart Waves](#)

soulinvitation.com/dardik

This means that endless fields of either wheat or sheep are absolutely fatal to attracting rain (& charge). Think about it. All our pictures of what makes implosion and therefore ability to attract rain by sucking in charge - require an infinite number of waves - to all learn to meet at one place. (see Phirica's above - ). Such ability to nest all lengths into one - called PHYLOTAXIS - is perfected in Golden Mean ratio.

[Phi-Lo-Tactics:\(Phi\)Recursion/Self Re-Entry-Heart of Self Organization? soulinvitation.com/philotactics](#)

This means that **SINCE HARMONIC DIVERSITY IS REQUIRED TO ATTRACT CHARGE AND RAIN- then it follows that GENETIC DIVERSITY IS REQUIRED TO ATTRACT CHARGE AND RAIN!!**

**Bottom line - your rain making land is going to require genetic diversity. Open - pollinated - 'heirloom' seeds in diverse gardens are an example.**

**(In other words Monsanto may not have a reason to exist in a culture that values rain).**

**Simple experiment - try planting a large variety of really vibrant flowers between the rocks of your labyrinth walking path. See pics on the labyrinth sites above.**

-----  
Next issue - to prepare your land for attracting rain: (and attracting CHARGE)..

**REMOVE THE STRUCTURES WHICH MESS WITH MAGNETIC FRACTALITY.**

This large translates to removing ALL POSSIBLE METAL FROM YOUR LAND.

(I know this is a huge task - but you can at least make an experimental beginning and see if your land does not tell you to carry on with the experiment).

The Steiner child touches only wood, and stone, and natural fabrics. So should you. Your local water droplets **CHOOSING WHOSE LAND TO BLESS** - has the same urge!

No Sufi dance bliss teacher lets you wear much metal.

The reason that heavy metals prevents rain (and life)- is because most metals have an electron valence structure which is the opposite of fractal.

More precisely we could generally rate metals on a scale from

**ABSOLUTELY POISONOUS** ————— to **ACTUALLY HELPFUL**

Aluminum, — Steel, — Iron, — Copper, — Silver, — Palladium, — Gold.

Actually it is the high amperage or temperature required to forge most metals which stores pain (lack of fractality / harmonic inclusiveness) in their bond structure. (Because the charge stored is un-fractal / lacks intent

The Australian habit of using metal so heavily in buildings and roofs and fences - is in my view a very large player in the cause of continental drought! Plus causing a drastic bleeding in ability to do bliss process.

The water in your tank and your house will be capable of a whole lot more life force and ability to attract other water like a sponge - IF YOU GET RID OF THAT SOUL DESTROYING METAL ROOF!

The quickest way to kill a magnetic line (and your local elementals)- is to shove something metal into the ground.

Think of this next time you un-consciously pound a metal fence post causing the local elemental forces to shudder.

Remove the aluminum and all metal you can especially from your kitchen, and bedroom if not house as a whole. The metal coil springs in your mattress and your clock radio's electrosmog prevent not only lucid dreaming, successful dying, but also prevent rain.

Next remove all sources of electric current which are not critical to survival. This includes if at all possible turning off the main power breaker each evening. It means religiously working to eliminate every device on the land which uses a transformer! (Flourescent lights, mercury vapor lights, etc. are the absolute death of life force and rain making). All devices which use a transformer which you cannot live without - you place that transformer as far from everything alive as you can, and religiously turn it off the minute you do not require it.

**Consider building a paramagnetic structure (stone or wood / no metal ) building in a sacred (magnetic ) place - especially for blissful and spiritual events.**

Next : ask yourself **IS THERE ANY BLISS PROCESS IN THE LIVES OF THE PEOPLE WHO INHABIT THIS LAND.** If not - take action. Learn the [science and politics of bliss](http://soulinvitation.com/rainbowserpent). ( soulinvitation.com/ rainbowserpent ) Because BLISS ATTRACTS RAIN.

Index of Bliss Hygiene Skills Articles: [How To's/Coherent Emotion/Practical Uses/Sacred Twinkle Hygiene](http://soulinvitation.com/sbhowtos1.html)

[soulinvitation.com/sbhowtos1.html](http://soulinvitation.com/sbhowtos1.html)

Finally -it is a good idea to learn the relationship of the local magnetic lines on your land to the greater Earth grid magnetic wiring.

This is like hooking up your local plumbing to the big waterworks of the Earth's magnetic plumbing.

See - Index of Grid Engineering Articles: [Grid Engineering/Geomancy/Magnetic Geometrics for Earth](http://soulinvitation.com/sbgrid1.html)

**°Women and Rainmaking- The Physics:**One of our planets more profound books on the origin of language: "Hebraic Tongue Restored: Origins of the Adamic Race" (by Fabre D'Olivet) - may shed interesting light on why rainmaking maybe more possible for women. The author has re-translated Genesis of the Bible - using a symbol table based on the shape alone of the letters. The holographic nature of alphabet origins is noted in ['Golden Arches':Spectrograms of the Alphabet of Genesis.. of the Heart!](http://soulinvitation.com/goldenarches) (soulinvitation.com/goldenarches )The word Adam for example as in 'Adam and Eve' is re-translated as the ability to make hard or to make red. The word Adom in Hebrew does mean red, and referred to the creation of the red-race (iron based oxygen bond in blood). Notice that if we understand properly [the pure geometric origin of color](http://soulinvitation.com/goldenarches) in the symmetry tilt of the photon donut as it splashes on to the retinal cone - red is the side of the photon donut which is CONVERGING or CENTRIPEDAL - which means - it makes HARD. (not wet).The word EVE is transliterated conversely as meaning - ability to make WORD or- **ABILITY TO MAKE WET.** (spelled I-eve- pronounced ye-ve). We now know much better why - the very word for origin of women in our bible (Eve) means to make wet. We might begin by noting that the feminine produced human egg is so very much more fractal or self-similar than the (male produced sperm) seed. So much so that - the first women 'Eve' was traceable by modern geneticist to a particular women in Africa - by looking at the fractal foldedness within the femine cell (in this case - the mitochondria ). A spin path back to information origins is established by the [non-destructive compressibility](http://soulinvitation.com/goldenarches)

made possible by (the egg's) fractality. Being more fractal or self-similar makes touch or WET MAKING more possible because it allows the inertia or interference of the touching wave to be non-destructive (or simply helpful). All of which is a rather crude way of saying that the principle of being feminine is inherently more touchable than maleness. This becomes rather evident when observing the more destructive nature of the archetypal male touch - witness the testosterone poison saturated 'football' game - to see the result of lack of permission to touch. But even deeper than this - we have learned that the origin of alphabets is merely the tilt symmetry of the field effect which is donut like - codified. (See the physics behind 'Lord of the Ring' / donut ). Tilt the spiral vortex on the self-organizing donut torus - field effect - and the shadows are Hebrew and Arabic alphabets. ( <http://spirals.etermite.com> ) The principle here shows **WHY the word EVE meaning the principle of making female - means BOTH - to MAKE WORD and to MAKE WET. The reason is that permission to non-destructively touch donut shaped field effect domains - is precisely what it means to MAKE A WORD. (The universe consists of everything that can be named.) This means that alphabet or word making - is literally the WETTING AGENT which allows one membrane to touch another - and not hurt either. The symmetry to permit this constructive nesting IS alphabets / and origin of symbol. (To symbolize IS to embed - see the link above).** Imagine a water molecule in a cloud - that has NOT learned how to touch it's neighbor water molecules. In this predicament - the farm underneath this cloud suffers drought. If something is seeded in this cloud which re-orientes that water molecule so it is better able to bond with it's neighbors - THEN A DROPLET (rain) is formed. The instruction which can tell that lonely little molecule how to touch it's neighbor - is an electrical charge field which has the SYMMETRY to provide that PERMISSION TO TOUCH. It is not that men cannot make that shape of electrical charge with enough bliss - (see [physics of kundalini](#) ) it is just that women are built for it. (Male kundalini requires turning inside out first - dumping the seed back up the tailbone. ) In the article here - note it was women who best restored the ground water - in the Yugoslavia post war rite. Note in the film "Mannon and the Spring" - female is most powerful in switching on - off the village source of water. Mater / Matrix / Water - refers to a principle. Holding the pattern - to make charge - touchable - is a natural way for women to be empowered. That they do the rain dance naked is appropriate - in that it allows an uninterrupted capacitive charge path from their bodies to the magnetic lines - connecting Earth to Sky. They would be advised to: rinse the intestines beforehand (springwater), dance barefoot in highly rhythmic array cross dowsed magnetic lines - in symmetry timing. (to build capacitive charge).. then alternate touch - with no- touch - to breath together - and to enter silence in a spin path ) see [Exercises to Zero Point \(bliss dance in all forms\)](#). See - [Science and function of bliss making.](#)<sup>o</sup>

-----  
23. Practical Intro to **Bringing LIFE Back to City or Bioregion.**

**LightCity: Using FengShui and Physics to Design Life Back In To Cities..**  
*New Information About The [Electrical Definition of What Creates Life -](#)*  
*Could be Used to Revitalize Our Cities..*

Live Birds only go to places where magnetic lines create symmetric nest like patterns. Glands like the Pineal and Pituitary in humans - have been shown by dowsing research - to respond to magnetic lines very much like birds. (Reference: [Good Feng Shui When Scientists Cross Ley Lines With Dowzers?](#) ) We steer well if the local magnetism is nicely arranged .. like a rose if you will. We tend to get dizzy and disoriented more quickly if the local magnetic lines are scrambled - in the same way funny film clips show how birds get lost in certain hilly areas where magnetism creates a tangled knot. One of the many lessons we might quickly learn - with a visit to the American Dowser's annual, in Danville, Vermont, USA - is that virtually every dowser is firmly convinced that Traffic pattern 'Black Spots' (High Accident Risk zones) are almost ALWAYS caused by places where the local magnetism is totally screwed up. And most of the dowzers there - will tell you in no uncertain terms how to fix such things! Magnetism arranged in a certain symmetry that looks like a rose ('fractal' or 'self-similar') is KEY to making ATTENTION itself possible - so of course this will affect the driver AND your city. The lessons here for the town planner are profound - AND practical.

If centuries of Feng Shui, Dowzers and Geomancers and 'Grid Engineers' are right about ley lines and Earth's telluric forces - then the way to create a city ATTRACTIVE to tourists and visitors - may start with the process of arranging magnetic lines. A few basic understandings of the physics and science behind what makes magnetic line hygiene absolutely critical to getting the FEEL right to a city - can be surprisingly simple and powerful.

# Magnetic Anomaly Map of Australia

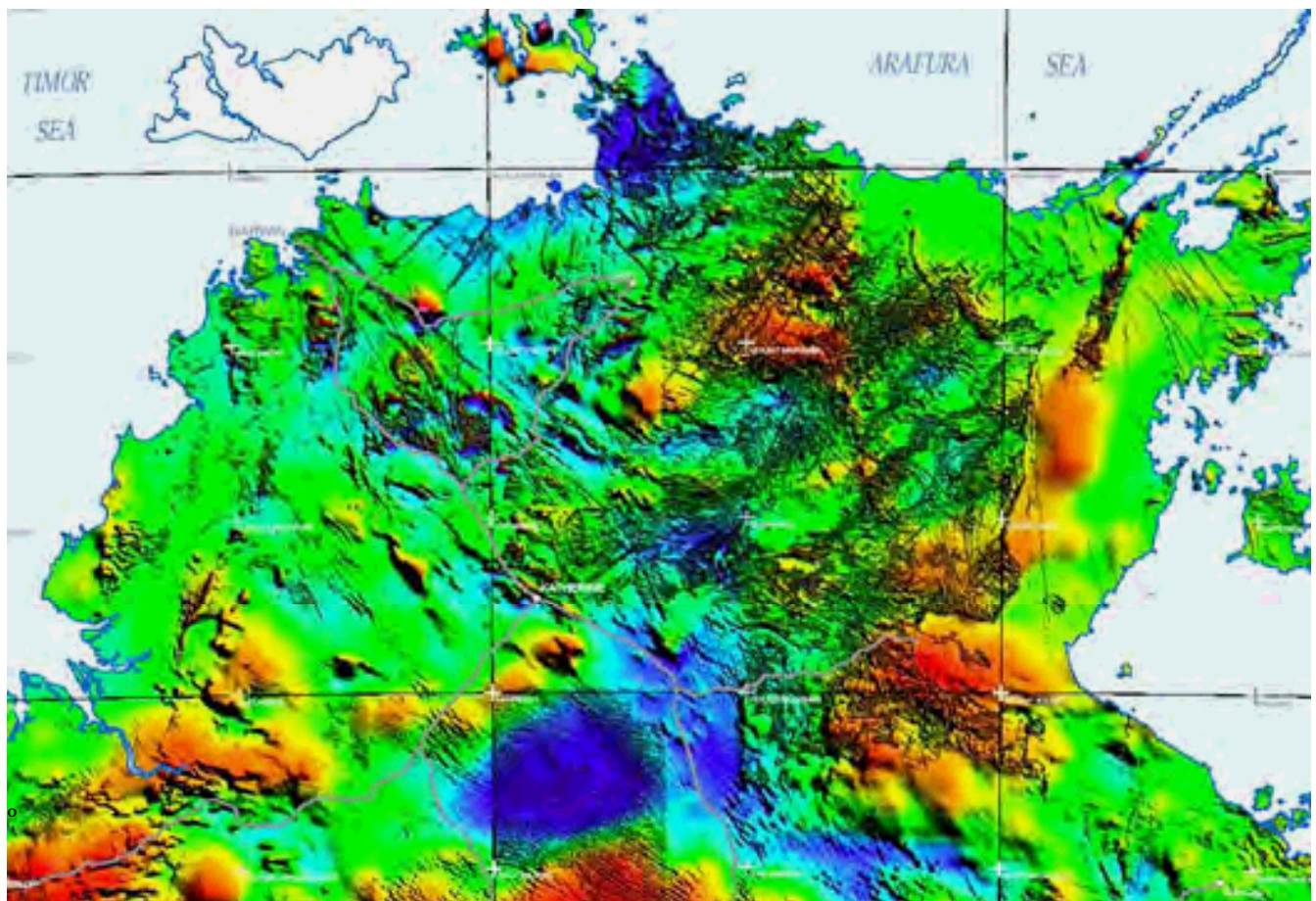
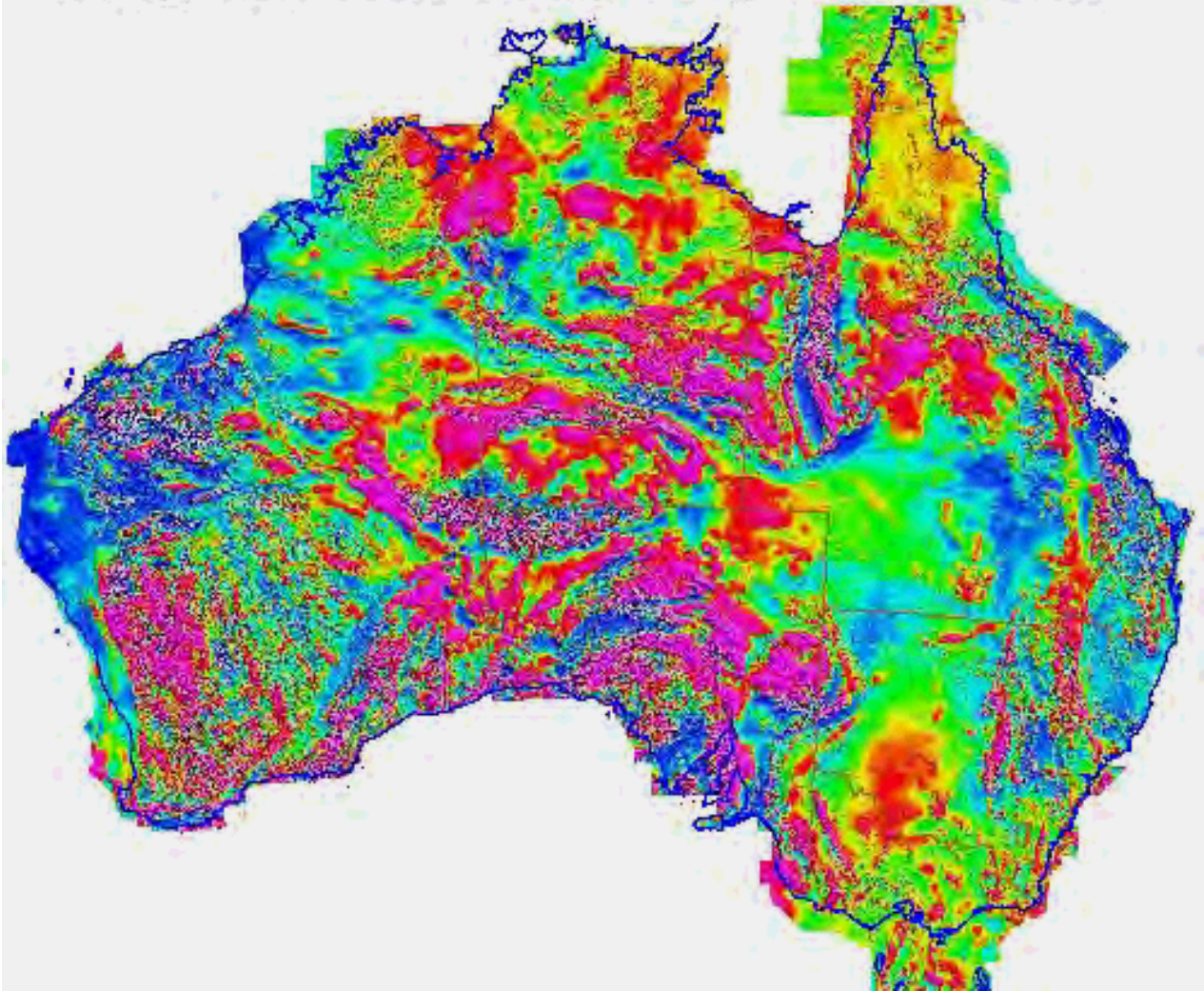



[Magnetic Map Exerpt North Territory tip. \(previous page\)](#)

Compare with : **Can War be predicted by measuring magnetic flux permissivity in the soil.. villages become friendly when their magnetism can touch?** [EARTH'S MAGNETIC FIELD REGIONS OF WEAKNESS PREDICT SITES OF WAR](#)

(we present 2 page exerpt here - on how peace / versus war is predicted / healed by magnetic line health.. for more on this please visit The New Science of Peace Teaching : [soulinvitation.com/peaceuniversit](http://soulinvitation.com/peaceuniversit)

**data pictured taken at my suggestion, with the kind help of the Heart Math Institute: top three graphs show Frequency Signature of Power Spectral Analysis of the EKG as it is distributed from the base of the spine, to the heart region, to the top of the head,**

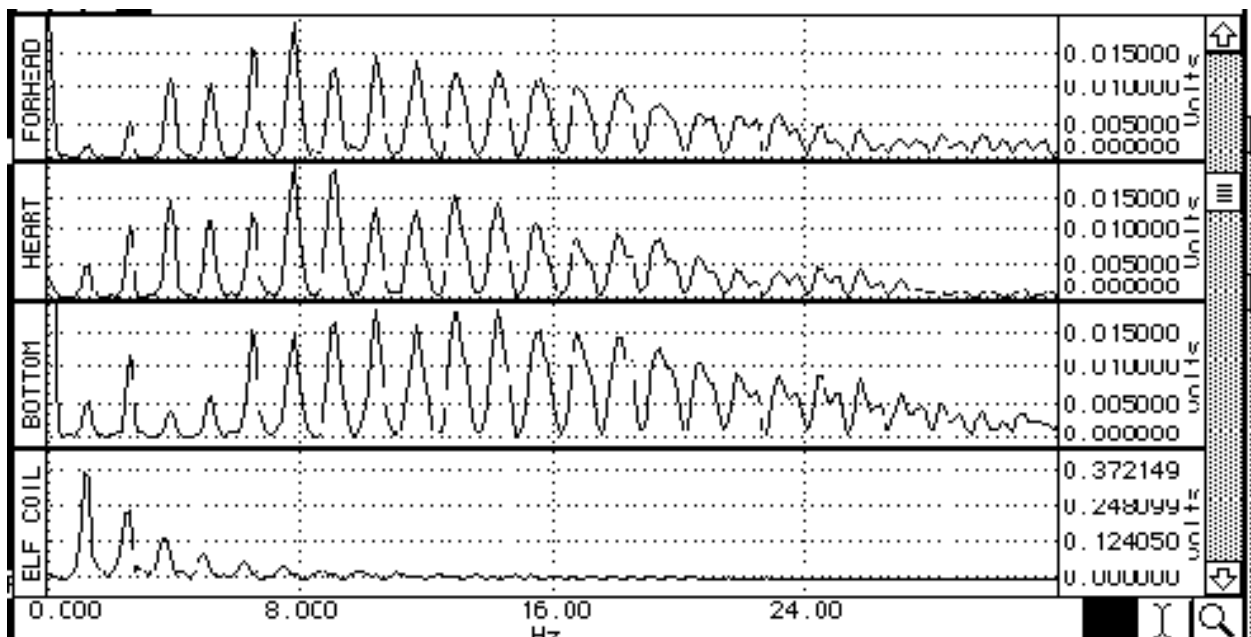

**THE BOTTOM GRAPH SHOWS THE SIMULTANEOUS EFFECT ON THE LO FREQUENCY MAGNETIC FIELD HARMONICS OF A TREE NEARBY!**

**IMPLICATIONS INCLUDE THE INFORMATION ACCESS GIVEN TO THE CHARGE ENVELOPE OF ECOSYSTEMS BY THE "SPIN PATH TO ZERO POINT" INDUCED BY COHERENT HUMAN EMOTION/ COMPASSION. LITERALLY: A CENTERING.**

**Earth Magnetic "Grid Engineering" will surely take on new meaning as a tool for peacemakers when Dr. Phil Callahan's new measurements are understood.** He has been travelling around the Earth, with oscilloscope in hand, documenting that war zones always correlate to regions where Earth's natural resonant magnetic field has been blocked or its flow cut off.

We have just returned from Gainesville, Florida making a 3 hour documentary film with Dr. Phil Callahan entitled: "Antennas of Nature: Biological Form & Earth Magnetics." Dr. Callahan has a lifetime of experience with the FDA, with multiple university positions and Ph.Ds. His voice on waveforms and biology is unquestionably the best in the world. His writing is featured regularly in Acres magazine. His books "Tuning in to Nature" and "Nature's Silent Music" circle the world, and tell the story of birds and insects as exquisite magnetic antennae. He has also written a series of textbooks for students.

During the war Dr. Callahan was in Ireland engineering radar antennae systems. At that time he began learning

about the natural magnetic strengths in that region. He looked at the natural magnetic field holding ability of the earth and straw constructed homes, and the natural strength of the people who lived in them. He explored the wisdom as energy medicine of many of the local healing lore. He also developed field effect resonance understandings of how the paramagnetic stone dolmen on the land actually effected agriculture by ordering the flux lines which feed the seeds. Essentially, we may visualize the work of plant growth as the ordering of field effects to weave water and mineral into biology. By using paramagnetic stone which is simply able to bend and thus focus like a lens the magnetic field lines, the ordering work of agriculture is "fed" by stone in symmetry.

Dr. Callahan is famous for showing the effect of a stone tower from Ireland on a microwave receiver "horn" signal. He discovered this first when he upscaled insect antennae to see what bandwidth they were tuned to. What he discovered was that the insect world was a very hi-tech design theatre for microwave signal. Earth and insects we now know, communicate in an elaborate information "bloodstream" based in the microwave. Clearly the ancient druidic stone towers were carefully designed to focus and bend these microwave and long magnetic fields to make flower like patterns in the landscape to weave biological forms in their web.

### **Microwaves vs Health and Spirituality:**

If we combine this with the work of Bob Dratch, microwave emission technologies, we learn that the Earth "grid" symmetry lines were exquisitely conductive to exactly the microwave emission lines of human cells. (For technical folk, we mention that this microwave cellular emission is based on the quantum distance from ADP to ATP: the energy common denominator of all cell metabolism). For general audiences, we may summarize that microwave scanning may not only be the ultimate dowsers tool, but also will tell us where our human communications electronics are screwing up nature's own information bloodstreams!

Bob Dratch's - Microwave Scanning Emissions Technology was the ultimate locator of trauma - and spine mapper - all based on the simple single radio station of ATP - Adenosine TriPhosphate - common to every cell. It is a tragedy that the fearful US Military declared Dratch's 3 dimensional microwave scanner to map where biology's fire went out - the ultimate hospital and spiritual healer tool - (& kundalini diagnostic) - **ILLEGAL BECAUSE IT WAS A THREAT TO NATIONAL SECURITY**. Of course microwave communications **ARE** national security bloodstream **AND** the ultimate biological weapon - **AND** - the only way to create security **IS TO ELIMINATE SECRETS!** ( which biology measures as **COHERENCE / distributeability** equivalent to **BECOMING SUSTAINABLE / immortal.**). It **MUST** not be a secret that biological microwave broadcasts are the essence of kundalini / bliss - and that those 'radio station bandwidths' when we create sickening telecommunications noise in them - **THREATEN THE SURVIVAL OF ALL BLISS ON THIS PLANET** - ( no bliss = no gene pool ).

*You can tell which governments (like Spain for example) actually care a bit about the survival of their gene pool. They put up massive billboards announcing **CATASTROPHIC** health damage particularly to young women who regularly ( use microwave ) cell ( mobile ) phones.*

Practical suggestion: Suppose your goal was to prove to your government that the microwave tower in your back yard was hurting the local greenery (and you!). The damage is in higher frequencies than show up on common electrosmog instruments. (ELF type devices usually look at less than 60 hertz or so). And microwave power density spectrum analysis equipment is **VERY** expensive. You could show that animals expressly stay away from metal microwave towers - they usually come close to magnetic dolmen. They recognize biologically information rich magnetic flux density ('Druid telephone lines'). Try this - simple **SOIL COMPACTION** is easy to measure. (Agricultural suppliers offer tools for this). The insect and microbe content of your compost pile **IS** biological information density. In this article Callahan is illustrating how they explicitly navigate and metabolize using microwave guiding as the geometrizer. The reason microwave towers cause increased soil compaction (documented destruction of soil life) - is because the **FREQUENCIES OF TELECOMMUNICATIONS MICROWAVE ARE NOT EMBEDDABLE IN BIOLOGICAL LIFE**. In other words, all of biology is based on being in phase with the harmonics of biological fusion. For more on this - look at phi harmonics of planck length and hydrogen as the musical key signature setting the timing for all of matter - in **THE BIOLOGY OF IMPLOSION MUSIC** - [soulinvitation.com/antakarana](http://soulinvitation.com/antakarana) (anatakarana is 'rainbow-bridge').

So you measure increase in soil compaction - which proves the death of soil (& microbe) life and tilth - AND THAT IS YOUR PROOF TO YOUR GOVERNMENT THAT YOU WILL SUE IF THEY DON'T REMOVE THAT MICROWAVE TOWER.

While we are on microwave - here is how to understand the death of life force - so fatal to all spirituality - in a microwave cooker. The heat added to food - to eat it - was originally a way to shorten digestion time - at the price of biological information richness in the food. (People who eat mostly raw food live longer). Originally - cooking was largely a way to create tribal bonding identity. The flame -center of all present - would compress a common memory into the food. Initiating better possibility of collective shamanic lucid dreaming. ( Read: : 'The Raw and the Cooked' - Mircea Eleade).

The way we derive the electrical information from food - which we call nutrition - is by persuading the chemical bonds in the food to share oxidation at some level in your guts (stomach). Well - actually what is happening when you cook your food - is you are unconsciously telling yourself - I DON'T HAVE ENOUGH INNER FIRE TO ACCESS THE SPIN MEMORY IN THIS FOOD. Letting FIRE from outside your body initiate fusion with your foods memory is another sad example of addictive behavior .

### **Addictive behavior.**

**Addictive behavior is - "where's my sugar", "where's my tobacco", where's my "alcohol", "where's my drug's", "where's my STIMULANT!?" This behavior ALWAYS causes mucous buildup - home to all the genepool parasites - because ADDICTIVE BEHAVIOR PLACES THE SOURCE OF YOUR FIRE OUTSIDE IN - INSTEAD OF INSIDE OUT. (The fire / fusion inside the cell is the only way to sort phases to make a membrane which knows inside from out - 'Structural Stability & Morphogenesis'). Remember it is in the nature of implosion - biological inner fire - to be the source of all possibility of becoming self-steering. A jellyfish navigates BECAUSE IT CAN SUCK INTO CENTER. The same is true of the electrical fields of your glands and DNA. Therefore - if you want to be able to steer YOURSELF- when you lucid dream, and die, and shamanically go thru the sun into stars - THEN THE SOURCE OF YOUR IMPLOSION FIRE - MUST BE INSIDE OUT. (Not outside in). This is because the SOURCE OF THE FIRE IS ALWAYS THE SOURCE OF THE SELF DIRECTION.**

**Being able to light your own inner fire - (bliss process and charge attraction ) is the essence of all self-empowerment - and self-direction. Visualize the implosive core at the heart of your heart - and at the implosive center of ringing DNA. That is YOUR steering wheel. See frontispiece picture - Sufi Heart with wings.**

**Avoid losing self -direction to the borg - by learning to recognize (parasite attracting) addictive behavior that puts out your fire - and prevents you from steering your own destiny . ( More on hygiene for bliss later).**

Back - to the Microwave cooker.. Adding HEAT in general - adds chaos. The higher the frequency spectrum of that heat - the more the chaos!

So - heat (in your cooker) is a name for adding destructive interference (simply spin density - which is not coherent). You add a little heat to combine the inner spin motion of the food - with external spin memory to get it closer to your inner temperature. IF that source of heat is context rich (embedable spins - harmonics in PHASE with the sun, hydrogen's fusion, and plank length ) - THEN the added heat can serve biology's quest for information / spin density.

To put this simpler - microwave cooking adds DESTRUCTIVE harmonic interference (HEAT) at higher frequencies - which are potentially MORE destructive to biological information density. Remember - the higher the frequency - the more the potential information density - OR information destruction.

So - if you must add heat - the LONGER the wavelength you add the heat to the food with - the BETTER! This is the simple physics of why people always are willing to pay more for a pizza heated with wood heat thru stone, rather than microwave. The context richness - ('Grammatical Man- Information, Entropy, Language and Life' by Jeremy Campbell).. of the inertia 'HEAT' you add to your food - pushes shapes into your dreaming. Remember - the 'young wives tale' - classic- The person with the fatal disease bug who died first - cooked with microwave. Next to die - was the electric stove user. Next dead was the gas stove user. Lived longer was the wood stove user. Still here to tell this story was the mostly raw food eater. (No stove needed). This is a spectrum map of the WAVE LENGTH in which the heat was added - microwave to electric to gas to wood - etc. is a progression toward ADDING HEAT IN LONGER - more context rich wavelengths. (Microwave and to a lesser extend electric element cooking creates biohazard electrosmog - gas cooking can have serious oxygen loss - low  $O^2$  = no bliss).

So.. speaking of the WAVELENGTH's of biological communications - back to Prof. Callahan's story:

So after showing us his scale models of all these bird and insect shapes as wonderful communications wave designs, the unstoppable Dr. Callahan drops another little bombshell on us. He had just returned from Headhunter Amazon country documenting his latest information model. He has for years been saying that where soil is not mineral rich enough to be paramagnetic, that is to coherently bend and weave magnetism, plants would not grow!

But then he began to notice that all the politically agonized areas of the world where war and killing were breaking out were exactly the places where Earth's magnetic field was not conducted by the soil. He has traveled globally to Ireland, Yugoslavia, Israel etc. carrying his liquid crystal battery oscilloscope and ingenious organic fibre mineral wetted probe. He measures with the latest technology the "penetrance" or susceptibility of the soil to magnetic flux lines. Then he measures the strength of the natural "Schumann" magnetic resonance of the Earth at that site. He finds that the amount of rich rock dust like paramagnetic mineral in the land is a predictor of the sites overall "Earth heartbeat" Schumann magnetic field strength. **This suggests that the Earth's magnetic "flowform bloodstream" by the shape or frequency signature of its envelope of electrical pressure, actually informs biology at Earth's surface of an organizing information context "long wave."**

We might compare the metaphor to the book *"Grammatical Man, Information, Entropy, Language and Life," in which we see that the reason DNA has a high signal to noise information flow ratio is specifically "context dependency." In the weave of genetic material this translates to mean that the braid angle of the long wave on the short wave, in DNA, creates an information link.*

So back to Phil Callahan. What he then noticed was it seemed that wherever he measured a weak penetrance by the Earth's natural magnetic resonances (Schumann 2-16 hz), not only was agriculture more difficult, but he also noticed a specifically greater tendency for there to be political strife and warfare in the region. Fascinated by this possible connection, he began flying around the world to make more measurements. And in fact he has now been to most of the globe "hot spots" where killing is a fact of life. (Yugoslavia, Ireland, etc.)... His hypothesis was born out in measurement with uncanny definition.

Then he decided to investigate whether it was just human structures and unwise land management that resulted in low magnetic flow susceptibility in the soil, and thus produced fractionation/strife in the civilization there. He chartered a plane and then a canoe to witchdoctor headhunter country in the Amazon. He consistently found amiable and easy to live with natives in the river delta where the soil was deep. Traveling upstream and upcountry to where the growth was still lush, but there was almost no soil, just a webwork of roots on thin dirt, he found very poor magnetic penetrance, low Earth magnetic flux intensity, AND very hostile headhunters!

Prof. Callahan's preliminary conclusion is that indeed where magnetic fields cannot penetrate into bioregions using coherent long waves, cultural breakup results. We may see this as similar to the additional spin ordering in water, braided through flowforms (changing specific gravity and seed growth) is partially lost when you pass the water through a fractionating screen or sieve.

The original inspiration for a new university to teach the Real Science of Peacemaking, arose in conversation with Inya and Dan. Inya teaches a form of the Sacral Cranial Pulse work, which used human touch with focused awareness, to align and sort (phase cohere) the waves in the spinal pump. A therapist traces by a light touch on the skin, the focal point of pain, and often measurable produce sorting and healing of the waves in the viscera. (Research suggests that depression is eliminated if the spin liquid pumping becomes coherent.) Dan Winter teaches the 'Sacred Geometry' of touch based on EKG harmonic analysis, and the wave shapes for emotion documented in the research on music ("Sentic" from Manfred Clynes).

**The convergance between these two fields, (the 'sciences of TOUCH') - produces an amazing simple science of what it is to make peace** - among waves and among magnetic fields, and among people. Dan and Inya and a wonderful core group of sponsors have agreed to found a University to Teach the Science of PEACEMAKING, as a result. . In simple terms, the geometry which allows the lines of pressure in coherent touch to create stabilization among waves (healing), is exactly the physics of what allows magnetic fields in the land to become stabilized and fertile. In many ways this is an essence of FengShui and Geomancy. If we apply this idea to how you make peace among warring nations, there are some incredible opportunities to heal our world. Namely, Professor Phil Callahan has suggested that since you can often PREDICT where a war will break out based on loss of conductivity / symmetry in the magnetic lines across the land, therefore there is in principle a way to fix it. ( Ref.2 ). Specifically, the science of making the waves of magnetism "TOUCH PERMISSIVE" (which is the same as 'NON-DESTRUCTIVELY COMPRESSIBLE - literally fractally able to SHARE space), IS the activity of making peace. This skill which the touch therapist understands - coheres the body, and also can cohere villages, and the land itself. The principle is simple: WATER FOLLOWS MAGNETISM, FOLLOWS SYMMETRY, FOLLOWS FOCUS (coherence), FOLLOWS AWARENESS, FOLLOWS INTENT. These principles form the 'Sacred Geometry' for a new science of what it is to make peace. It is a science, and can be practiced by measurement: Hearts can be measured to COHERE and make PEACE, TOUCH can be measured and taught to make PEACE in the body, and MAGNETIC KEY LINES can be measured and re-aligned and taught to make PEACE in the land. In simplicity - PEACE is where waves learn to agree to SHARE. With modern tools to measure the best way for waves to SHARE space (coherence), there is no reason why we cannot teach warring generals to touch hearts, on land that has been healed of magnetically destructive harmonic interference, as the perfect prelude and foundation on which to build PEACEMAKING.

.....

### **Mission Statement:**

What is new about a University for the SCIENCE of Peace?

Peace begins in the Heart. This is ancient knowing. Today's science has ways of now teaching how to make peace in the heart measurable and teachable. We have used harmonics to find that the EKG of the heart becomes COHERENT and harmonically EMBEDDED when you FEEL at peace. This ordering of the heart harmonics is easily experienced with biofeedback when people see that FOCUS in the heart, and awareness of love and compassion, create the 'singing of the heart' which we measure as COHERENCE.

The new information, is that this science of **what makes the electricity of the human heart STABLE and SUSTAINABLE, is truly identical with a new and teachable universal science of WHAT IT IS TO MAKE PEACE**. When the heart learns the skill to be INCLUSIVE, this process of getting the MOST HARMONICS included in the EKG is called "Heart Rate Variability" or HRV. Medical literature is very clear, that 'FRACTAL' or inclusiveness in the frequencies contained in the heart, truly define the end of most chronic disease and possibly aging itself! ( www.soulinvitation.com/dardik ). What we have learned is that the electrical geometry of the heart which learns to be fractal and sustainable, has actually learned how FEELING can share space, making the non-destructive compression possible, which appears to be IDENTICAL WITH THE VERY NATURE OF COMPASSION.

Recent Russian research ( www.soulinvitation.com/brainphire ) has shown that **brain wave harmonics 'embed' by the Golden Mean ratio (~ .618) during euphoria or bliss. The HeartTuner ( heartcoherence.com ) has shown that often when people become coherent AND feel openness or wonder of empathy, their EKG**

**harmonics ALSO choose that perfect golden ratio of embedding. This corresponds to the ability to ('fractally') ATTRACT and SELF ORGANIZE CHARGE, which becomes a new and radically revealing DEFINITION OF LIFE FORCE ITSELF. This SELF CENTERING ABILITY in the FIELD EFFECT of the HEART, the BRAIN, BLISS GROUPS - and even in THE LAND - becomes a radical new and excitingly practical way to measure and teach and facilitate PEACE ITSELF! Because peace is a name for the field effect which learns to center itself. (see Implosion herein ).**

The SCIENCE OF PEACEMAKING, recognizes the magnetic relationship, between Hearts which are fractal and joyful, with what makes that charge of life, sustainable in the land and culture. Professor Phil Callahan ( [www.soulinvitation.com/CALLAHAN](http://www.soulinvitation.com/CALLAHAN) ) documented that often you can predict where a war will break out, based simply on whether there is enough magnetic symmetry (paramagnetic stone circle / feng shui / labyrinth / ) to make MAGNETISM FLUX PERMISSIVE in the soil and land. In other words, if magnetic lines get lost and dizzy, because there is not enough symmetry in land and hearts, then the people who inhabit that land FRACTIONATE . Peacemaking IS the difference between FRACTIONATION (breaking up connectivity) VERSUS FRACTALITY (embedding into coherence by non-destructive compression).

Another simple way to say this is to recognize that powerful charge rich bliss or euphoria experiences are unsustainable, unless your backyard or garden is FRACTAL. This means simply that rearranging the magnetic lines in your land to look like a rose instead of like tangled knots, is what feeds your roses.... AND feeds the politics of peace.

Another example of the science of making peace, becomes experiential when you teach political leaders at war, what it means to link hearts by actual measure of EKG musical fundamental, BEFORE you negotiate peace. ( [www.soulinvitation.com/module](http://www.soulinvitation.com/module) ). This applies to empathy training by heart link up, and corporate consensus process by heart as well.

**Now that we can have a working scientific definition of WHAT PEACE IS, peacemaking as a science becomes teachable. Peace is what happens when waves agree! Waves agree when they embed or nest inside each other, so that all can sustain, yet none are destructively interfered. The fact that this physics emerged from Heart EKG discovering health and longevity - evidences that we can apply it to land engineering, and the political process of making peace. Perfect nesting was discovered by nature and called PHYLOTAXIS based on golden mean ratio perfect packing and unpacking. Confirmed now in the Heart EKG discovering compassion, we can apply it to the principles of peacemaking between families, and nations. These principles are outlined in more detail at [soulinvitation.com/peaceprize](http://soulinvitation.com/peaceprize) .**

The convening coeur group of our Univesity for the Science of Peace, invite you to join us in the curriculum and science of peacemaking. Leaders from countries all over the world, have joined us - and we are grateful for the fire in your heart joining us- as we nourish this flame.

--

**The Pure Principle of the Science of Peace lies in the symmetry of FUSION of people or waves which make a 'centering force'. The ultimate coherence is self-similarity inside out which is measureable electrically by accurate harmonic analysis as peace in the heart, peace in the mind, peace in the bodies movement, AND peace in the land. PEACE is the 'Music of Embedding' waves which nest embedably, compress non-destructive - they 'touch' permissively AND they produce ONE from MANY.**

also see: [heartcoherence.com](http://heartcoherence.com)

"We can never obtain peace in the world if we neglect the inner world and don't make peace with ourselves."

Dalai Lama

***The self-organizing centering force which the geometry of perfect FUSION creates, is the essence in principle of what makes WAVES stable and sustainable - AND THEREFORE THE ESSENCE OF PEACE-MAKERS SCIENCE.***

***Perfect embedding or nesting allows the maximum number of waves to touch non-destructively - and THIS IS PEACE. Peace in the place of maximum AGREEMENT among both waves and people. AND THIS AGREEMENT CAN BE TAUGHT IN THE PERFECT COMPRESSION WHICH FRACTALITY OR SELF-SIMILARITY CREATE.***

**"Peace Making is the principle of arranging magnetism (feeling) in the symmetry which allows waves to become self-similar enough to self-re-enter. This invites non-destructive compression or FUSION or IMPLOSION which is identical to compassion - because during compassion the heart makes a magnetic picture inside which is so self-similar to what is outside - that the 'outside falls in'. Turning-inside-outness IS the geometry of SELF-REFERENCE which became the Vedic definition of consciousness. This infinite non-destructive compression of charge by recursive Golden Ratio - constructive interference of wave VELOCITIES in addition to wave lengths provides a way-out thru the speed of light for charge. Thus: like pulling the plug in a bath-tub, arranging charge (capacitance) into a fractal, makes GRAVITY. This explains why pent self-similarity is the shape of everything alive, why people lose mass at the instant of death, and solves Einstein's stumper question: namely that this (PEACE MAKING) symmetry of infinite non-destructive compression is the source of voltage from gravity (source of the Heart's voltage, and source of the DC voltage which measures the freshness of an egg / pinecone or anything alive). (soulinvitation.com/biophoton)**

*It is necessary to understand the physics of gravity in this way in order to understand the physics of peacemaking, because this creation of centering force, where for example the self-similarity or fractality in wave symmetry predicts the amount of gravity (by perfect fractal wave collapse) in an atom or a meditator floating, or in anything. So to create the centering force which holds any field together requires this creation of the limit condition of coherence - which is fractal or where 'the inside looks like the outside'.*

*If the rose has grown so that it's inside looks like it's outside - then that bioregion can heal!*

The Transcendental Meditation Movement (TM) correctly proposes that peace can be created by generating COHERENCE between people, what we add here are several key ingredients:

1. That COHERENCE can now be measured and thus made accurately teachable.
2. That the HEART can be measured and not just the brain for that coherence. See HeartTuner.
3. That many people at once can literally see their heart coherence come into phase with software well under way- see "The Harmonic Module" in conjunction with HeartTuner.

**This pure symmetry operation to produce fusion - IMPLOSION, (pp. \_\_\_ pictures of the symmetry of implosion) becomes the principle of how PEACE is made TEACHABLE in many practical yet scientific and measureable ways:**

#### **A: PEACEMAKING in Human Hearts:**

Specifically, we can measure PEACEMAKING in the heart using the HeartTuner. (heartcoherence.com). We teach and measure PEACEMAKING in 3 ways with this tool:

1. We can measure and teach Heart COHERENCE - which is emotional coherence, and quite visibly a truth detector for the body. This teaches emotional coherence. Internal coherence within one oscillator like the

separate heart, has never before been dynamically measured until this pioneering use of the Septrum (2nd order FFT / Power Spectra). The amplitude of the first dynamic peak of the septrum provides this new and revolutionary new measure of the COHERENCE and therefore VIABILITY of the EKG or of ANYTHING.

2. We can measure and teach the Heart's music to enter into the precise musical symmetry of EMBEDDING which is compassion / compression, because the 'Septrum's numeric (y axis) value - the musical key signature of the EKG - replicably moves toward the Golden Mean ratio when people feel OPEN-NESS, COMPASSION, literally the membrane bridge electrical symmetry of non-destructive TOUCH. In effect, teaching people to move from EKG musical fundamental of 1.0hz to 1/.618 hz - dramatically appears to teach them to move from HEAD centered to HEART or self-similar centered emotion!

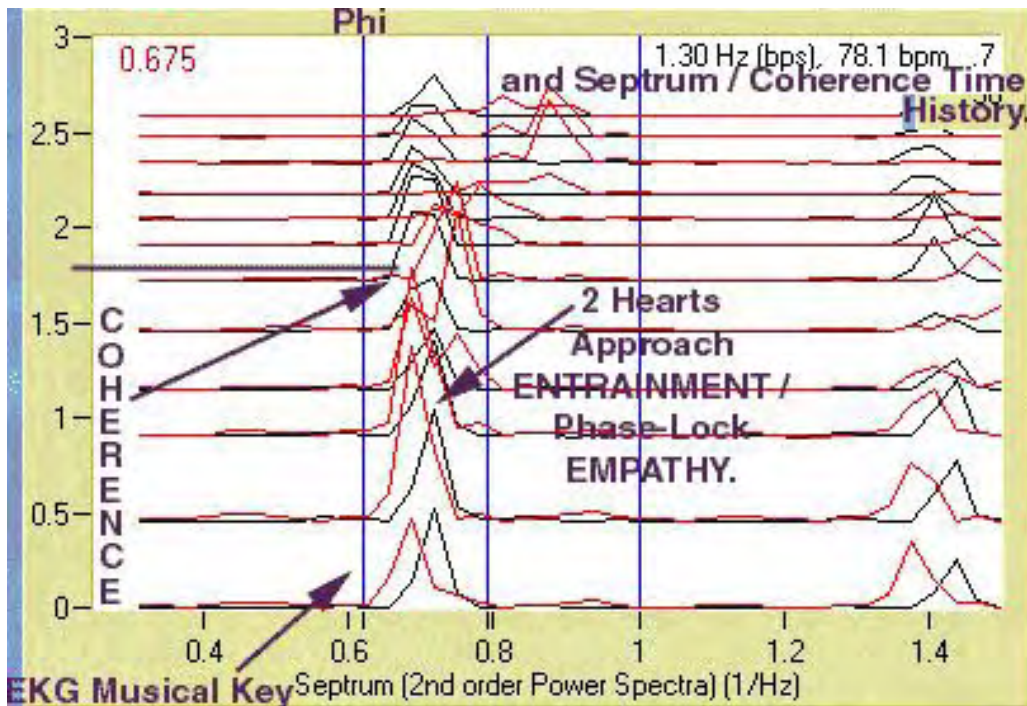

**Below-Cepstrum - 2nd order power spectra-instantly measures internal coherence - and moment of phase lock or PEACE between 2 hearts.**  
(heartcoherence.com)

3.. The HeartTuner teaches PEACE-MAKING and CONFLICT resolution by teaching people to LINK or PHASE-LOCK their EKG to the same musical key. The same key signature of the heart's

music measured as described above, provides a very dramatic picture of the moment of COMPASSION, EMPATHY, CONFLICT-RESOLUTION, and ROMANCE. A healer or doctor can measure the moment at which healing transfer of BIOLOGICAL CHARGE - can move between bodies - by phase lock / resonance entrainment / 'impedance matching'.

We do this with the HeartTuner by displaying 2 people at once. Never before has it been possible to see when 2 people become electrically in-phase (impedance matched or resonance entrained) to capacitively share biologic information (micromotion entrained). Not only is this probably the ultimate tool to teach clinical empathy, and spiritual healing, we have software already in beta test to allow larger groups of people, over intra/inter-nets to practice Heart Link up. This is conflict resolution (for families, corporations or nations) and consensus process and PEACEMAKING in the ultimate measureable environment!



Left: Medicine will eventually decide to look at WHY the vast majority of people EKG's musical fundamental - stabilize at one of ratio's of Golden Mean.

(The 3 vertical lines on the previous page image - from left .62 (Phi), .79 (Phi<sup>1/2</sup>), 1.0 (Phi<sup>0</sup>).

Labeled -1.0 - Membrane MAKING emotion (conceptual)

.79 (Square root Phi) - Peaceful Balance..

.62 Golden Raio - Empathic - Open - Membrane BRIDGING Emotion. (From interviewing thousands of HeartTuner users.)

**EMOTIONAL QUALITY INDICATED BY EKG KEY?**

This horizontal y axis value of the cepstrum measuring coherence ( see soulinvitation.com/coherence ) corresponds to the musical key signature of the EKG (inverse 1/x). When living things choose Phi (Golden) ratio based key signatures - they open themselves to touch - electrically. When they choose octave (log 2 or 1 hz) based key signatures they appear to MAKE membranes / create barriers. (Cancer patients need to move FROM 1.0 )

**THIS IS A LESSON IN SACRED ARCHITECTURE.**

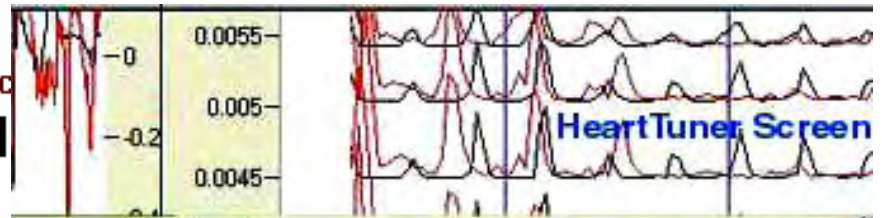
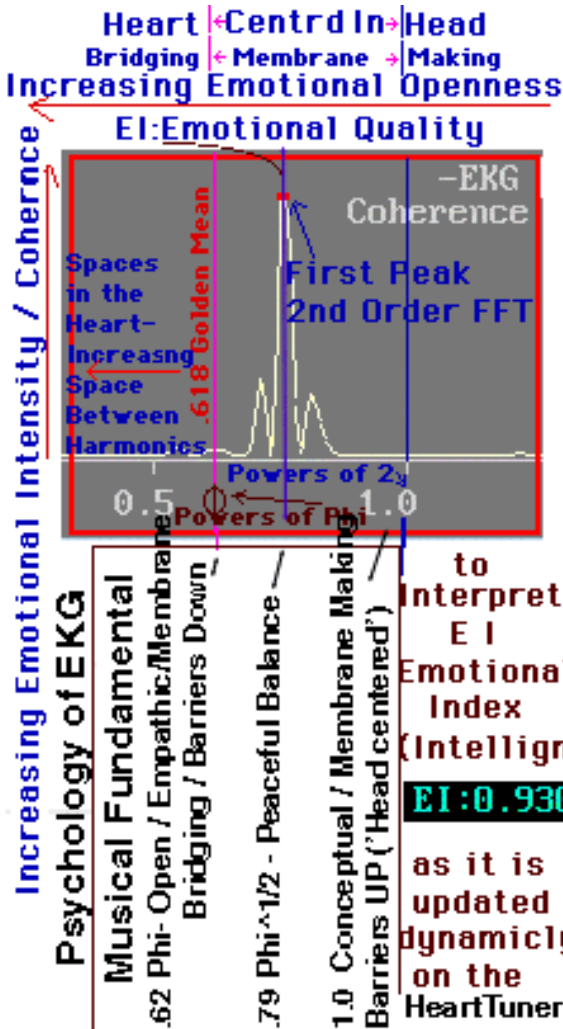

Harmonic Module Data List		Emotional Index		
Name	Ch	EI	Ampl	Coherence Level
Heart center valerie	0	0,706	0,0541	
Heart center dan	1	1,394	30,2	
HCT Dutch Developm... Marc	0	0,8	0,0000000000957	
HCT Dutch Developm... Liesbeth	1	0,644	0,0000000000529	

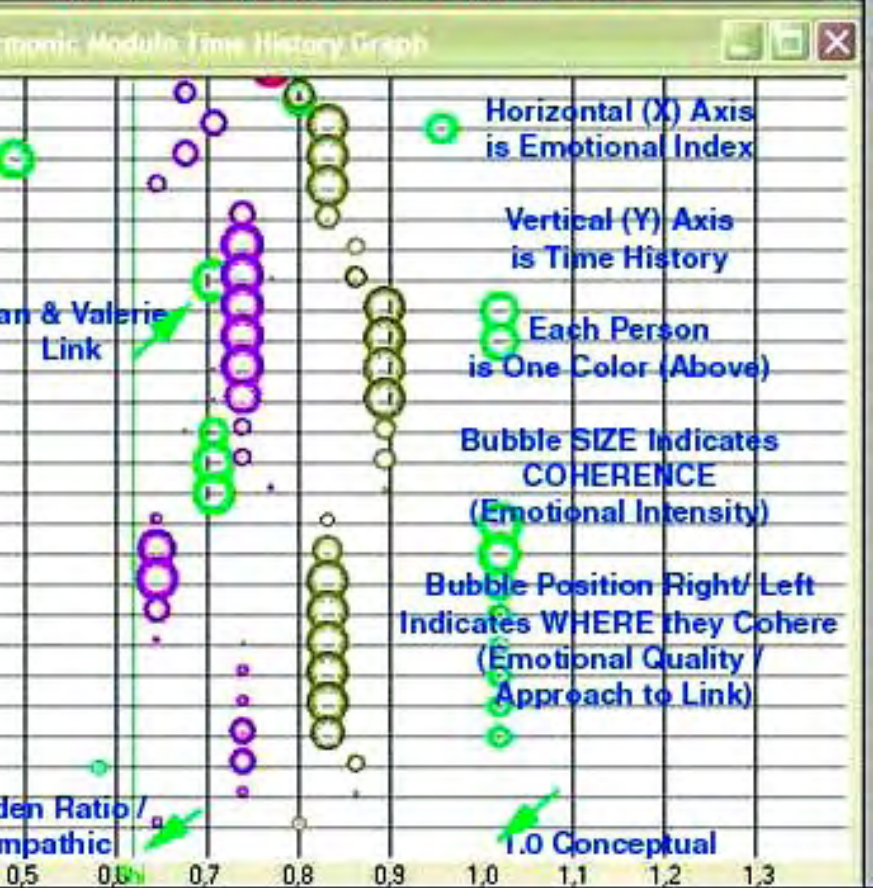

On the right:  
New **Harmonic Module** software for HeartTuner soulinvitation.com/module allows groups to train in Heart linkup. (One HeartTuner preamp and computer for each 2 people - linked over intra- or internet.)

The current software can offer heart link up training and feedback for 4-40 people. When hearts really do link up a feeling of 'presence' sweeps the room - and agreement follows!

- This is a dramatic training solution for:
- CONSENSUS PROCESS
  - CORPORATE BOARDROOM
  - CONFLICT RESOLUTION
  - GROUP NEGOTIATION
  - SHAMANC GROUPS
  - BLISS GROUPS
  - PEACEMAKING
- more info  
soulinvitation.com/corporateheart

**B: PEACEMAKING in the brain / mind.**

Peace or electrical self-centering and charge attraction ( attention / bliss / and enlightenment) are clearly the result of brain waves whose magnetic geometry assumes the SAME SYMMETRY of EMBEDDING AND INFINITE COMPRESSION organizes by non-destructive COLLAPSE / FUSION. - also measureable by spectrum analysis.

1. We know what PEACE is in the EEG from measuring the musical geometry of brainwave harmonics which produce ATTENTION - and heal Attention Deficit Disorder AND ADDICTION. ref: Addiction / A.D.D. Solution with self empowering neurofeedback. The simple principle is, that when a CASCADE of phase locked harmonics in EEG produce COLLAPSE (compression of charge) then the field of the mind self-organizes to create ATTENTION and also the solution to addiction. Previously it was thought that replacing 1 simple harmonic could heal A.D.D. or addiction, but now the deeper principle that IT IS THE GEOMETRIC RATIO of the CASCADE or HARMONIC SERIES which produces attention In effect - stable attention - is electrical PEACEMAKING in the brain - and that is produced by the same symmetry of wave collapse / fusion / implosion we see in the heart! Read about the HeartTuner measuring PEACE / as attention in the brain - see 'braintuner'. Previously eegspectrum.com 's \$14,000 system was required to teach - replace the missing brainwave harmonic - to achieve the 70% sustained success against ADDICTION or A.D.D. As you can see at , new software with HeartTuner, will accomplish this more elegantly by for the first time measuring and teaching overall COHERENCE in brainwaves - in addition to the conventional - 1 missing wave length at a time approach.

2. We know what PEACEMAKING is in the EEG by studying the electrical physics of EUPHORIA and BLISS in brainwaves. Specifically, Professor Korotkov's recent studies of the brainwave harmonics of euphoria and bliss, confirmed earlier work Ed Wilson did at Monroe Institute, and Dan Winter's work on heart harmonics. The study showed that during bliss and euphoria consistently the RATIO between brainwave harmonics was within 10% of .62 or Golden Mean ratio. ( soulinvitation.com/brainphire ).

Picture of Brain COHERENCE (EEG) synchronizing with Heart (EKG) measured using cepstrum in HeartTuner - page \_\_\_\_\_ (Internal Coherence has never before been so directly measured in EEG - the implications for feedback conscious training are profound.) (Professor Korotkov - began using HeartTuner for his research in Russia after our wonderful meeting in Basel in November.)

**Bliss is the charge density of perfect charge attraction which braid embeds DNA and immune membranes to the potentially infinite context richness we call an immune system.**

**ESSENTIALLY - PEAK EXPERIENCE - PEAK LEARNING - PEAK ATTENTION & BLISS and EUPHORIA have the identical electrical description.**

(Note at [soulinvitation.com/rainbowserpent](http://soulinvitation.com/rainbowserpent) in the discussion - the same electrical recipe to create BLISS at rave concerts in young people brain music - is the recipe that END's Attention Deficit Disorder- by creating charge collapse cascade in the brain - attention itself.)

**The forces ( 'implosion of charge attraction' ) which cause this phenomenon no longer elude science, and as such DEFINE PEACEMAKING - because PEACE is a name for the stable presence - which results.**

### C: PEACEMAKING in the LAND.

Magnetic flux or flow when permissive or conductive predicts where PEACE will break out in the land, not unlike it predicts fertility. Referring to the preceding article about Prof. Callahan's work: **EARTH'S MAGNETIC FIELD REGIONS OF RESISTANCE - PREDICT SITES OF WAR**

.(Abstract) Professor Callahan showed that the tool of measuring soil magnetic flux permissivity (conductivity) available : <http://www.acresmagazine.com> could predict political war. The logic is simple, if magnetism cannot penetrate the soil without fractionating (falling into chaos) then the EMOTION of village A, will never share and touch with the emotion of village B. Restoring long wave magnetic symmetry restores the ability of land magetics to embed, implode, become touch-able and make peace. (see Geomantic Tools for Peacemaking - the Labyrinth and embedding long wave magnetics in the LAND. )

In summary, restoring self organizing properties to the land's long wave magnetics, creates a magnetic environment where nations and their weather can emerge from chaos. That fractal symmtry for long wave magnetism is exactly the SYMMETRY RECIPE for PEACEMAKING we discovered in heart and brain. Magnetic and charge symmetry make the gravity that holds us together, when the principles of fractal embedding are practiced.

Refer herein to: 'Bringing Life (charge) Back to the City', also extensive Templar et al. geomantic geometric summary history of magnetic ley PEACEMAKING on the land at: [soulinvitation.com/buehler](http://soulinvitation.com/buehler) .  
Examples of LeyLines and PeaceMaking from Peter Champoux et al. [arkhom.com](http://arkhom.com)

### D: PEACEMAKING in human touch.

Cranio-Sacral Skill to Touch -Non'Destructively - Becomes a SCIENCE OF PEACE. The symmetry pattern of touch which is most inclusive and healing, is based precisely in the self-similar geometry based on Golden Ratio. (see the love wave in 'sentic's'). A PEACEFUL touch is one that understands embedding.

The perfect geometry of pressure over times, defines the musical nature of human touch and how emotion is conveyed. See: Sentic's- and "How to Touch". In the Sacro-Cranial work, human touch is used to focus charge and attention to align the waves, both liquid and electrical in the spine. This alignment produces what is directly felt as a STILLPOINT. The stillpoint, or movement to lock into phase all waves of different lenght, produces a SORTING into that which nests and can share. Thus producing a 'spin path to the zero point' in touch, directly helps sort emotion and heal.

From Inya L'Orange: "Science of Touch Makes Peace" <http://www.craniosacral.no/>

"When we touch non-destructively and with intent - we restore symmetry, we invite HARMONY into the body. We create a STILLPOINT - and thus - we allow for PEACE in the body. "Peace Em-BODIED". We transform the consciousness in ALL our cells.

One peaceful cell influences all its neighbors in all directions. We will instantly extend this peace - this level of consciousness to land, cultures, and fellow Earth citizens. This establishing of symmetry, harmony and PEACE inside - allows us to choose COMPASSION, and to CHOOSE PEACE. In this way, we MAKE LOVE VISIBLE. The capacity of HARMONICS give the Heart WINGS - From explaining BLISS to EXPERIENCING BLISS. Hand's ON - with TOUCH. Love itself IS perfectly CONSTRUCTIVE compression.

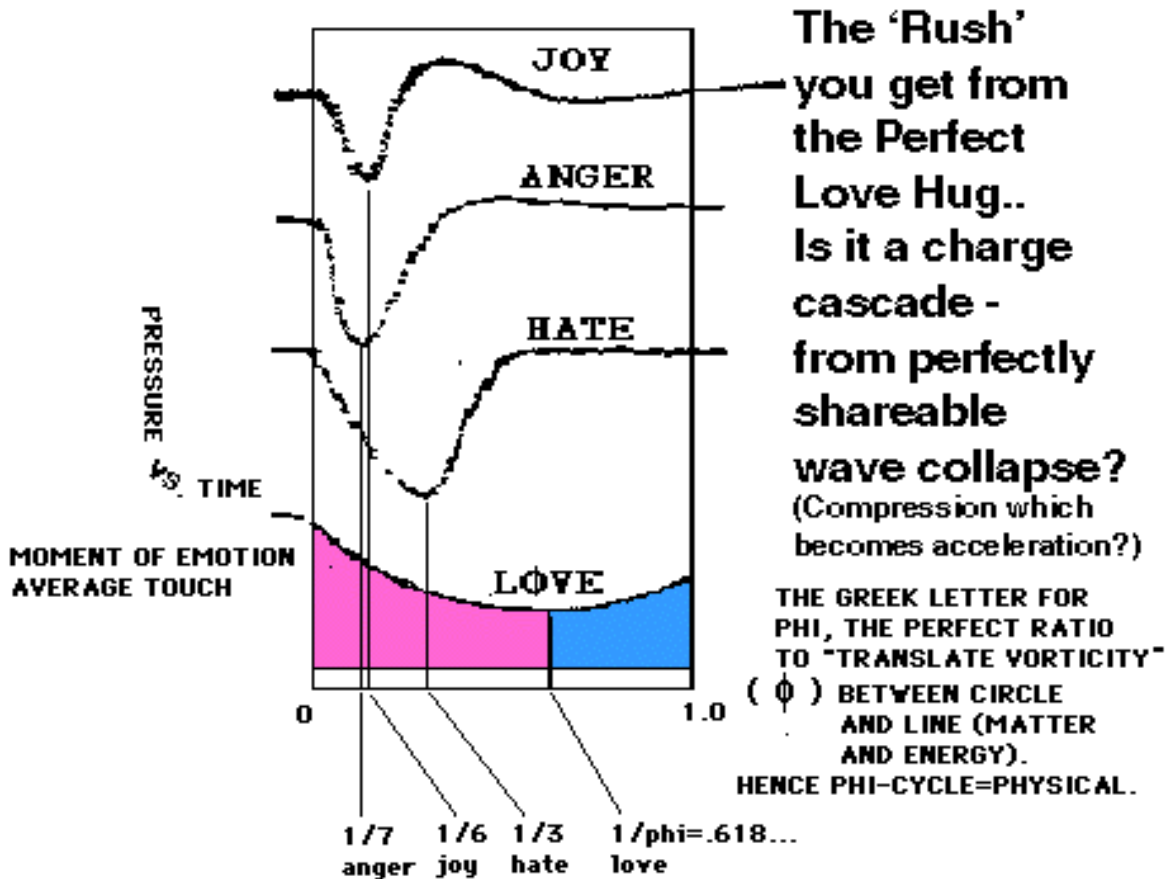

### The GEOMETRY of the Perfect Touch?

Mapping change in pressure over time - to identify EMOTION in the SHAPE of How you TOUCH  
 The wave shapes above are from Manfred Clynes - the analysis of ratio on the bottom are from Dan Winter

The academic who investigated geometrically how to properly touch, is named "Manfred Clynes".  
[www.microsoundmusic.com](http://www.microsoundmusic.com) . His first book on the subject is called "Sentics", another is called "Music, Mind and Brain". His work on the known wave forms to express emotion, as a concert violinist, was also featured on the Nova series, "What is Music". The web site includes music custom designed to contain perfected wave forms of sonic pressure and envelope to optimize the FEELING of the emotion intended.

The issue for this conversation, is how to actually apply this information to learn how to touch better. Manfred developed a set of Sentic Cycles, in which people were given sequences of touch and visualization exercises to express emotion. Here we will braid to and add our thoughts this work.

By way of intro, in Sentics, Manfred simply has you change the pressure in the way you touch over time, and thereby express FEELING. So in the chart above, the way you would change your touching pressure as you touched a spring, was mapped. (Visualize the "sentometer" as a simple button on a spring; put a pen on the button and run a chart recorder behind it, and you get a map of the change in pressure over time on the button.) We need to understand this simply, in a way that permits us to use this information to be better touchers. Imagine that you were walking up to someone very important to you. And you were about to give them a big squeeze hug. And it was very important for you to know that your squeeze definitely conveyed the emotion you intended. This is where this chart comes in handy.

In order to understand how to squeeze better, it is helpful to begin to **think of your squeezing skills, as a "GEOMETRY OF PRESSURE"**. At first this seems painfully analytical. But consider it this way...

Your Perfect LOVE HUG... analyzed?? .. begin squeezing .. when??

A squeeze, ( or hug, or touch)... consists of basically THREE events which we may chart ( see the start point and end point of the pressure wave in the Sentic picture - previous page - note where the maximum downward pressure is marked and sets up a simple RATIO)

The FIRST event is:

Event ONE: The **BE-GINNING** of the **SQUEEZE**.

The LAST event is:  
(Event THREE): The **END** of the **SQUEEZE**.

Now, somewhere in the middle area above there occurs the **MIDDLE OR SECOND EVENT**:  
The **POINT OF MAXIMUM SQUEEZE**.

---  
Now this may all seem a bit strange, to begin to think of your squeezing time, during hugging as:  
begin event..  
peak event..  
end event..

*but actually this IS going to help you be a better hugger, so bear with me.*

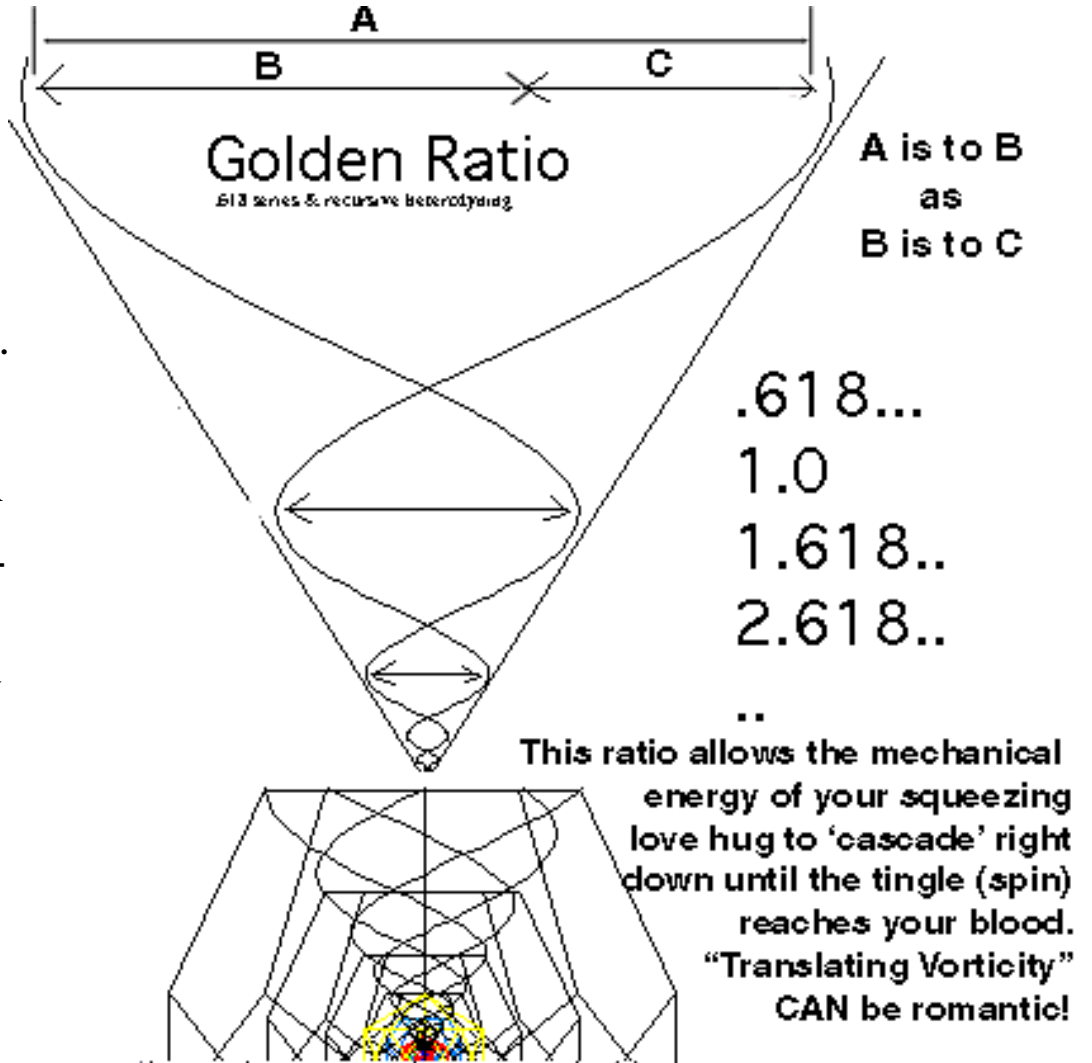

If you begin to notice how soon the max pressure occurs in your hugs, you can begin to conceive of a RATIO.

**The HOLY GRAIL of Love Hugging is to intuitively achieve this PERFECT RATIO - because this will cascade down the spin path BETWEEN frequencies - This sends the actual pressure path of your perfect squeeze (piezoelectrically by 'stricture' - muscle to gene) - right into the DNA of your lover!!! (pic above)**

Was the max pressure in my hug 1/6, 1/3, 1/7, or 1/PHI GOLDEN MEAN into the duration of my hugging. This may at first seem to collapse the intentional rich spontaneity of hugging, but I suggest to you that the skill to hug properly, while instinctual (as Sentic proved), may also be optimized and learned, and then become instinctual at a higher level.

--  
You see in the chart (previous page), I have added to the waveforms something not in Manfred Clynes Sentic. I have made note where the point of MAXIMUM occurs in each squeeze play. AND IT IS FROM THESE ORIGINAL ADDITIONS I HAVE MADE, that I HAVE SUGGESTED THE RATIOS IMPLIED BY THESE EMOTIONS ON THE BOTTOM AXIS.

**1/6 Ratio (Planar and Space Filling but not transcendant) - THE JOY SPACE**

**1/7 Ratio (Maximum internal DESTRUCTIVE interference among waves)  
- ANGER or CANCEL ME SPACE**

**1/5 or PHI Ratio (Maximum internal CONSTRUCTIVE interference - turning compression  
IN to ACCELERATION ! ) - The BLISS - OR Shareable - OR TRANSCENDANT SPACE .  
( Note: Not good for secrets)**

**Compare this to how you save a cancer membrane by adding PHI, AIDS membrane by adding HEX  
at [soulinvitation.com/cancer](http://soulinvitation.com/cancer)**

Simply put, if you want to send joy, then the point of maximum pressure in your squeeze (hug), should be about 1/6 into the duration of the hug or squeeze. One sixth makes a wave hex whose edge length equals it's radius, planer and space filling, but not inherently lifting off the plane it finds itself in. Good for fixing an emotion, not good for sending. The witches hex fixes.

*(The witch wisely does not change her **HEX fixing "SPELL"** /field effect - to a **PENT spell for SENDING** - until she is **SURE** she has **PURE** / shareable / coherent intention - otherwise the nature of the resulting implosion will cancel her as well as her spell!)*

Now, on the other hand if you want to send anger, your point of maximum pressure will be sooner during your squeezing practice: about 1/7 into the duration of the hug or squeeze. The seventh creates destructive harmonic interference among waves, which may be useful if you are shooing money changers out of a temple.

Now, here comes the fun part of learning to hug better. If you want your hug or squeeze to explicitly indicate LOVE, then the Sentic wave forms for emotion, tested to be a universal language for cultures the world over, have some specific instruction for you.

**The HUG THAT SAYS LOVE, is one where the point of maximum pressure is approximately .618 or GOLDEN MEAN, into the duration of the hug or squeeze. ... What this says is that the love hug is explicitly more restrained initially, it is almost tantric. Specifically, you don't go for the rush right away, you let it build awhile. ( IF you squeeze hard nearer to the beginning of your hugging process you COULD be a 'jerk' - better study carefully...)**

And you can test to see if your love hug, according to academic standards, did in fact succeed. You wait for a little while, afterward, in gentle but specific stillness, for the love hug you just gave to settle in. (Mother said: "He's not talking while the flavor lasts".)

Then you simply ask your experimental huggee:  
**"Did you feel a tingle in your DNA?"**

Let me explain why this is the correct Electric Kool Aid Acid Test, for proper academic rating of love hugs:

You see, by creating a squeeze geometry of pressure, at the ratio of close to the Golden Mean, you have solved the "bifurcation puzzle" (problem of separateness for waves), and you have sent a wave cascading down the kite string, or cracked whip, from long to short. You divide a wave in this way. (The PHI-lo tactic perfect branching all-go-rhythm.. Scion... John=branch of fractal tree). The big part to the little part as ratio, equals the big part to the whole. This starts a wave INTERFERING WITH ITSELF NON-DESTRUCTIVELY. And what happens when your hug wave does this? Your hug pressures add and multiply all the way down the PHI wave (Jacob's best) ladder. And the spin of pressures cascade RIGHT IN THE HUGGEE'S DNA. So you need to know if they felt the TINGLE!!! This tells you if their DNA implode braided just a little more toward

perfect embedding, in response to the perfect embedding of the (piezoelectric muscular) geometry of your hug. If so, then the spin density of the wave in their DNA became a bit more sustainable (recursive). **AND THAT THEN MOVED YOUR HUGGEE APPROPRIATELY JUST A BIT MORE TOWARD IMMORTALITY -- and ... FUSION with YOU!**

If this moves you to practice... (Also nice to observe the charge hygiene suggestions later herein - about choosing whom to hug based on availability of twinkle - thus fusing with charge density...)

Related: Grail animation of braid perfecting in DNA entrained by EKG of LOVE:  
[soulinvitation.com/grail.html](http://soulinvitation.com/grail.html)

This will bring us beautifully to the **next major section of this text on: BLISS-BRAIDING AND THE NATURE OF DNA.** .... Superconductivity in DNA: Function of Braiding. But first - we finish .. making peace.

---

### **E: PEACEMAKING in human MOVEMENT.**

*Why the 'QUALITY OF GRACE' IS - THE QUALITY OF HOLDING CHARGE..*

*Graceful movement is the acceleration de-acceleration curve of elegance which prevents the biological capacitor from bleeding! And it IS healing.*

Pam - Tai Ji. Posture geometric of 'grace' - to attract CHARGE fractally in movement. life force = charge density = waves at peace (in "CHARGE"). Presented with Pam Hiley - <http://www.taiji.no/> . In Tai Chi for example movement is done with the quality of ATTENTION which is charge dense, then the rate of change of posture..allows waves to share crests, and build their charge. The perfect WAVE of movement in the TAI CHI is like the perfect wave upon a wave whose 'tail end' is perfectly in phase like a cascade holding a committee of interconnected wavelengths all nested to arrive a ONE POINT of movement. Imagine the definition of GRACE in the TAI CHI as a description a gathered CHARGE which occurs when the fingertip moves like the tip of this wave on the wave: A PERFECT CASCADE OF PHASES.. Always braiding many spin lengths into one - and never a 'jerk'. In this way CHARGE is embedded - and life force is produced in movement. The symmetry which produces PEACE and LIFE in movement is the same - it is perfect wave nesting.



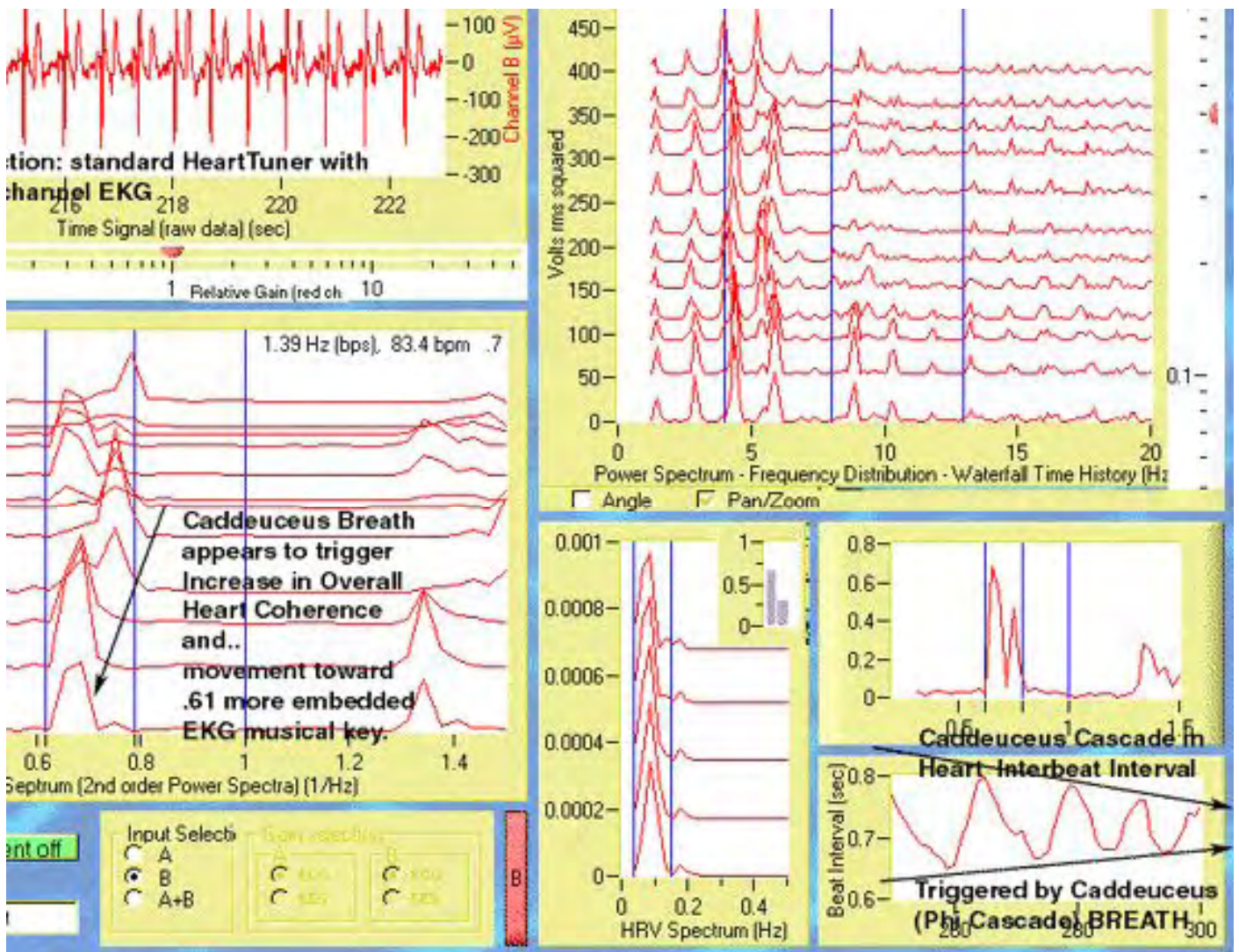

**F: PEACEMAKING in the human BREATH.. The same perfect collapse symmetry.. .**

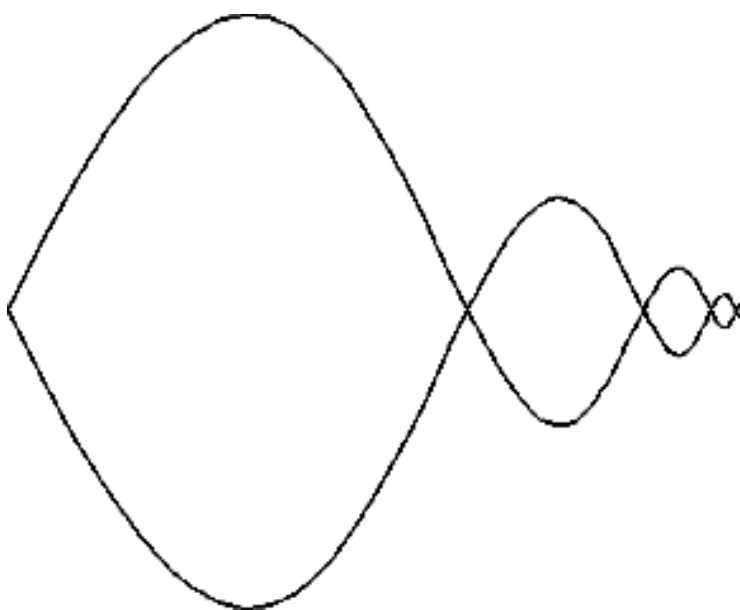

Breath enacts the geometry of embedding which is PEACEMAKING when the stillpoint of collapse achieved. The shape of that breath wave IS teachable - and does have precisely the harmonic inclusiveness - which defines HEALTH in the HRV literature (Heart Rate Variability)

See HRV Measured above - entering a caddeuceus shape - adding to heart coherence - controlled by the BREATH!

Perfect damping based on recursion in the geometry of BREATHING is simple. To make a STILLPOINT in the breath use: Exercises to Zero Point . [soulinvitation.com/exercises](http://soulinvitation.com/exercises)

The breath which produces CHARGE and produces PEACE - is exemplified in how perfect harmonic inclusiveness in the change of breathing produces fractal or harmonic inclusive HeartRate Variability - so medically documented to heal.



Here we chat more about -

**practical exercises to approach BLISS / PEAK EXPERIENCE / ECSTASY/ ENLIGHTENMENT (Charge Density - defined as harmonically inclusive and therefore multiply connected / ALIVE! ).**

The question of inserting your body through charge compression / acceleration and BLISS (stargates/ time portals..?) is quite a simple and practical one. If you think of the images we have shared of a compression algorithm which allows spin to converge continuously toward a common center, a good visualization can be had for this "spin path to zero point". (adams apple image:note spin path to zero point at arrow)

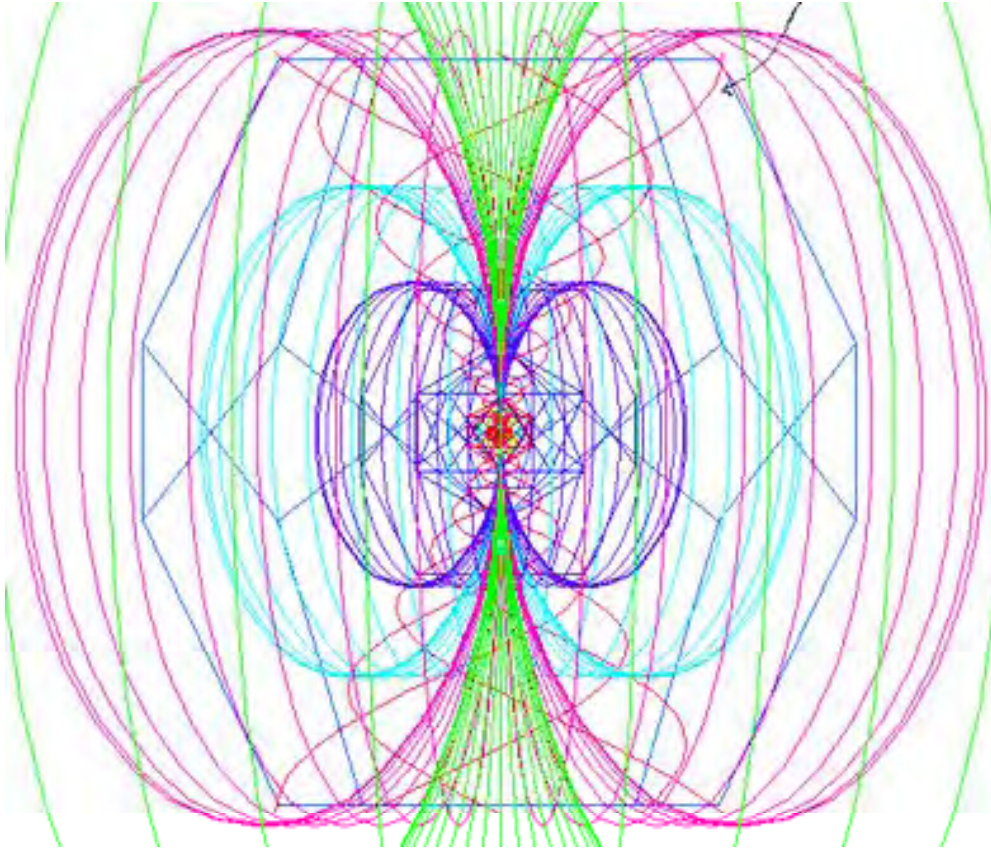

In biofeedback terms, this was the heart of the incunabula approach to time travel. The visual biofeedback was fractal spiral embedded images generated from your own internal eeg and micromotion.

You might think of it as a way to take the wave path of all of your body's biology and squeeze it infinitely by self-reference into a time tunnel. The pent and recursive electrical geometry of this was the core also of the pent/deca antennae geometry of montauk (and the shape of Jody Foster's vehicle in 'Contact' the movie).

However, what we would like to focus on here, are the psychological correlates of this experience of electrical compression. It is important that we don't view this uncovering of the phi based recursion symmetry of infinite compression, to be only a sterile solution to the problems of gravity, time bending, etc. While it is all of that, it is much more important psychologically and emotionally.

Try to think of the spin pattern survival dynamic of what happens to the magnetism (and therefore the memory) of flow lines converging at center. The **sharing of path space at the convergence implosion moment is a psychological as well as a physical test for what is shareable. This essentially means, that if the genepool's collective wave core is not in agreement with what you feel/think at the moment of implosion (death or shamanic penitance), then your memories will wave cancel instead of propagate.** The cancellation of waves by non-shareable(non-symmetric) interference feels like heat/ the definition of resistance to spin. The same symmetry operations toward centering which when encountered non-resistively (fractally embeddable)

feel super-cool (super conductive/non"linear"). This difference between lack of perfect embedding in a spin field, and perfect implosive nesting, is the physics of fear (resistance to spin), versus love (sufi fractal heart magnetic wings which embrace all of spin.)

Another useful metaphor might be the central modulator of the universal radio station. In order to get voices through the squeeze play of the transmitter, while at the same time was talking to all the voices of this galactic sector, a certain discipline around what could be modulated or enveloped onto the common carrier wave might be necessary. The common carrier wave geometry for universally transmissible info patterns, would be the wave envelope of perfect embedding, or nestedness. Only fractality is infinitely compressible and therefore infinitely shareable.

This is well depicted in Irving Dardik MD, article in Cycles magazine on the direct relationship between onset fractality in heart rate variability and health in general. Basically, the wave envelope of what constitutes the perfect changes in heart rate looks like a perfect fern tree folded fractal. The more fractality or embedding allowed into the heart in the still point (zero place) between beats, the more the infinite spin context of the universal song could waltz into the electricity invited into the body by the perfect embedded beating heart. ("Heart Waves" in Cycles Magazine, Dec. 1996. [soulinvitation.com/dardik](http://soulinvitation.com/dardik) )

The psychology of where spin lives, has the quality of the heart surgeon who cannot but bear to reach in and touch lightning because it is so exciting. In the lightning the spin is so dense that awareness or self embedding exists on a new level. Therefore it is quite the perfect place to talk to god/ or if you prefer the collected electrical voice of all the DNA. Just one minor detail to contend with here, touch lightning all at once and you get quite burnt (the "Powder" - as in the movie - phenomenon.) You need to be very distributable to survive in memory.

If you achieve anything approaching - real BLISS ( & Kundalini - the lightning up the spine experience) - **the thing that your body spits out FIRST - is every emotion you ever stored inside your tissue which is not SHAREABLE - has not been processed / integrated / or made COHERENT.**  
**COMPRESSION TESTS FOR THE SHAREABLE.**

The form of **the removal of the non-shareable from your body as you lead up to BLISS** (which is charge compression) - **can be mucous, kunda-lingum** (calcific excipient roof of tongue) - **and almost invariably - lots of tears.** I cried for weeks continuously.

But do not get caught in the phenomenon - hold your vision - to see what waves of the universal voice "SONG IN YOUR BLOOD" - (the piezoelectric singing slinky of DNA - SAN GRAAL ) will sing in your ears! (because everything else is boring - not to mention unsustainable - by comparison ).

So what follows here are some magnetic exercises to learn the shareable among spins, emotionally.

**1. Decide for yourself today that you will only think thoughts / feel feelings, you'd be pleased to share.. infinitely.**

**2. As you do this, try breathing in the perfectly shareable fractal: (spin path to zero point).. (use preceding section picture perfect 60 degree wave caddeuceus breath to compression... )**

path for breath to still nest

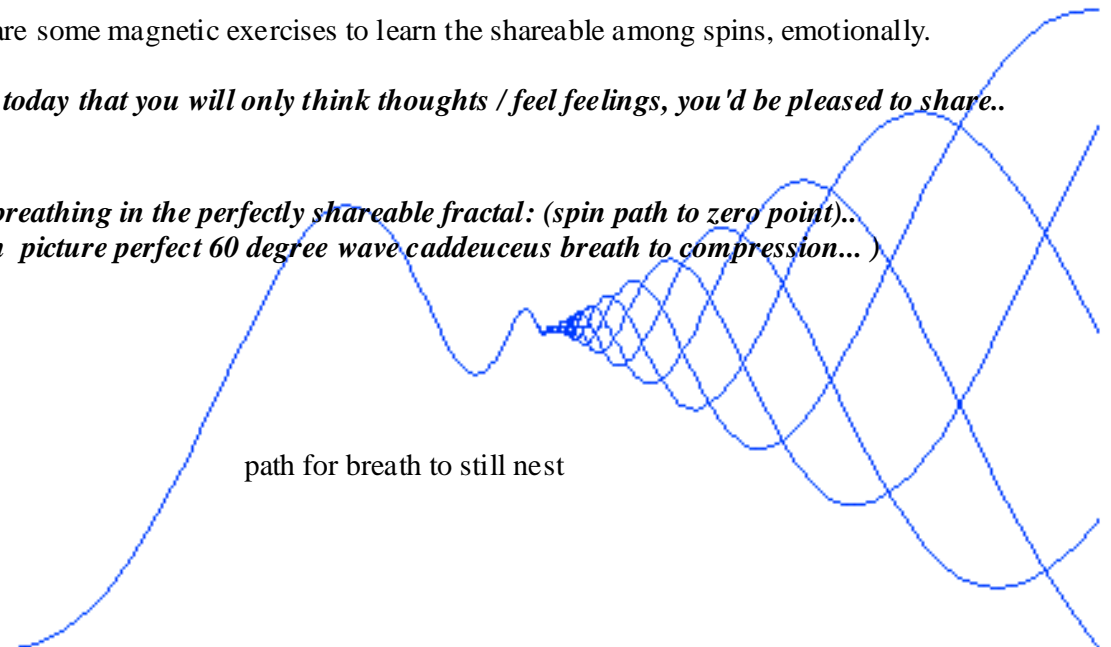

**The path light sees on it's way in to DNA when braided in perfected embedding/love.. (the grail)**

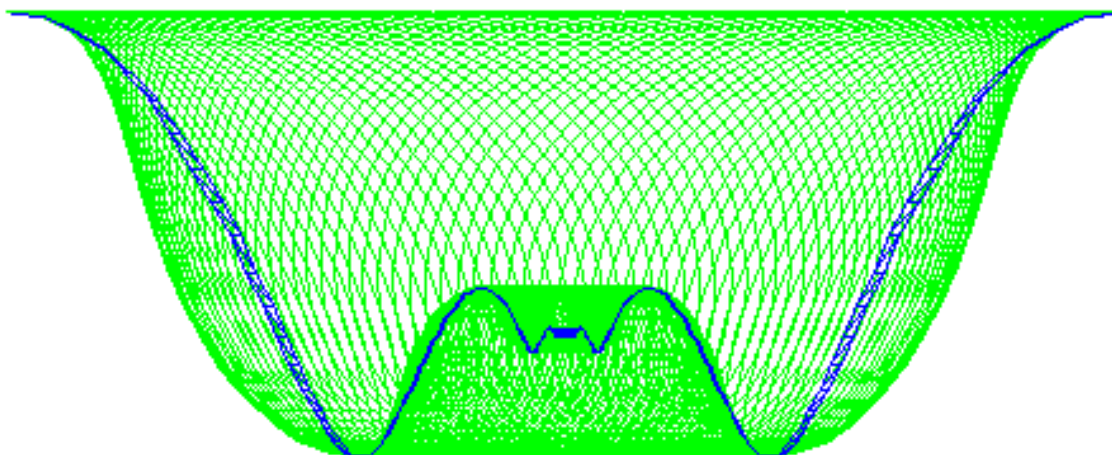

*Animation - [soulinvitation.com/grail.html](http://soulinvitation.com/grail.html)*

The breath moves in and out in the geometry of perfect damping, or the perfect way to approach the icy stillness of oneness. The depth and the duration of each adjacent breath get smaller by ratio PHI (golden mean)..

In other words- each succeeding breath is about .618 the length and depth of the previous. **Gradually you breathing becomes more and more refined - until - your attention reaches - a very short wave.**

**When you reach the stillness, (preferably in a magic place), stay there in your body until the tingle tells you you have finished your communion.**

3.. Do an experiment whereby you change an otherwise difficult situation by breathing in the phi Sentic of the perfect wave form for love (embedding). Often when we find something messy has snuck up on us, we breath in the perfect "jerk" of fear. This is a sharp in breath followed by NO outbreath. This is the breath of fear, it's halt of the flow of o-x-y-gene or phi-re, says: "stop the world, I wanna get off", which literally asks all spin to stop. It is the mind killer because it is the recursion killer.

So the breath of love, which invites ALL of spin.. is one (picture sentic love wave here), where the point of maximum inrush is reached at the .618 point in the duration of the gentling breath.

**This is then the distance between fear and love, in a breath.**

4. Do the above two experiments in learning embedding/compassion, except instead of moving your breathing in and out, in the two depicted patterns, instead use this road map to embedding to **change the pressure in a hug or squeeze over time**, to express feeling intentionally. Try hugging in the grail wave... shape... (Clues to tantra also.)

5. Try arranging your:

- a.) magnetic stones
- b.) closest meditating friends
- c.) back yard or church
- d.) favorite memories
- e.) sufi dance or tai chi or flame in go..

in the this (much related) perfect pent fractal patterns, and feel the rush of "cryst-all-eyes-zing" awareness when waves agree.

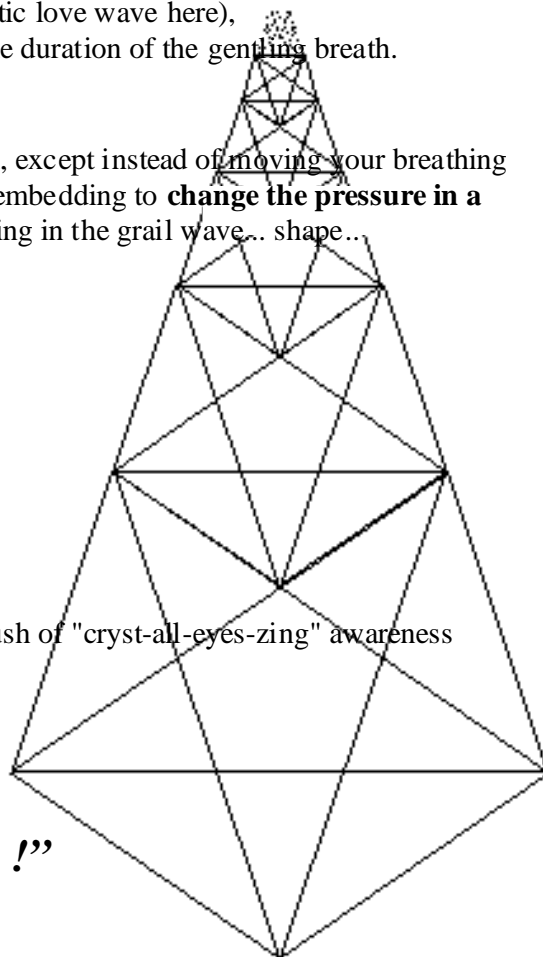

**“Re-PENT- and be ‘Saved’ (made shareable) !”**

For a hands on experience - zen and the art of PENT EMBEDDING..  
 we recommend - The Star Mother Kit: [soulinvitation.com/kit](http://soulinvitation.com/kit) and [heartcoherence.com](http://heartcoherence.com)  
 developed by Dan Winter - inspired by Plummer's 'Mathematics of the Cosmic Mind'  
 Color coded - Star Tetra - Oct - Cube - Dodeca - Icosa - Dodeca - In-PHI-Knit Nest.  
 Kit building experience - truly an immersion an the magic of embedding!

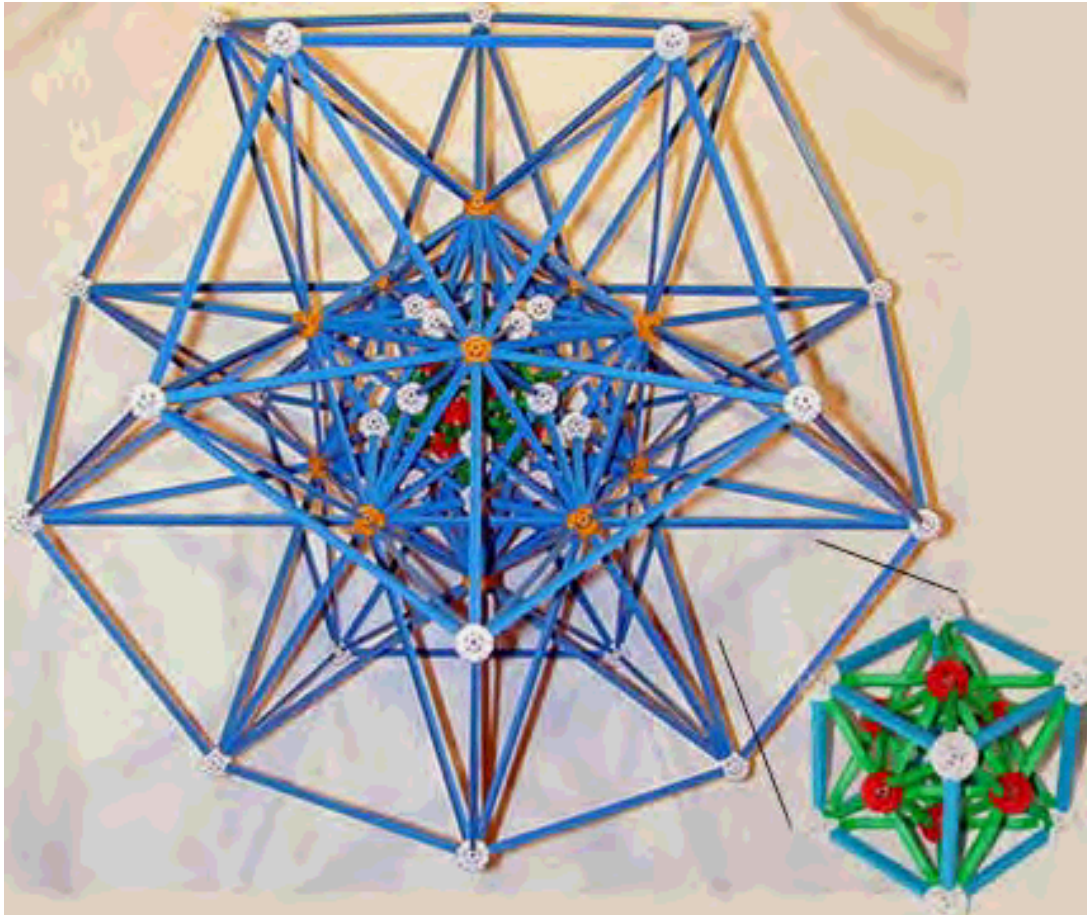

Is the OMMMMM chant - the sound of PEACE - a wave collapse effect?  
 Singing Charge Density - by Compression into your DNA

Here we take a time history 'waterfall' plot - (next book we print in color)  
 of the energy density by spectrum analysis - displayed from - 0 - 3000 hz  
 of the sound of a slowly chanted OMMMMM .

Notice that the harmonic cascade over time  
 approximates the correct 'caddeuceus curve'  
 for PHASE CONJUGATION..  
 infinite compression become acceleration!  
 (Bliss?)

**EEEE Sound=Harmonic EXclusiveness**

The word was pronounced aaah--ee--oo-uu--mm  
 notice the E sound 'power plot sonic hologram'

**AAAH=Harmonic INclusiveness**

is the exact shape of the tongue  
 filling the mouth center.

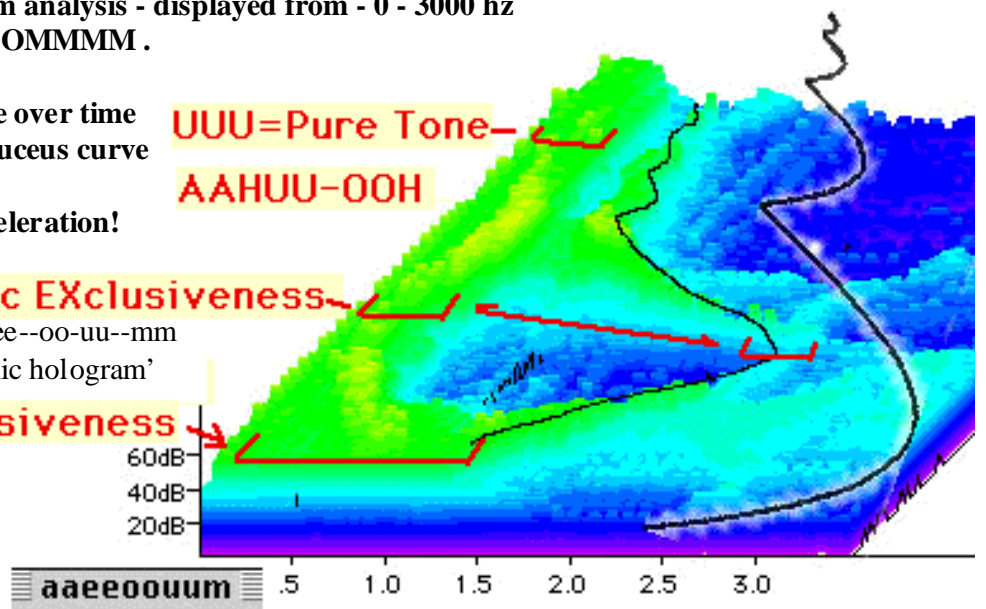

And THIS shape of - perfect PENT NEST EMBEDDING - Brings us Beautifully - to  
**The SACRED GEOMETRY OF DNA -**  
 -in order to prepare to fully understand what happens to genes on fire in BLISS.

*Genetic Biology:  
 Emotion's  
 Golden Braid*

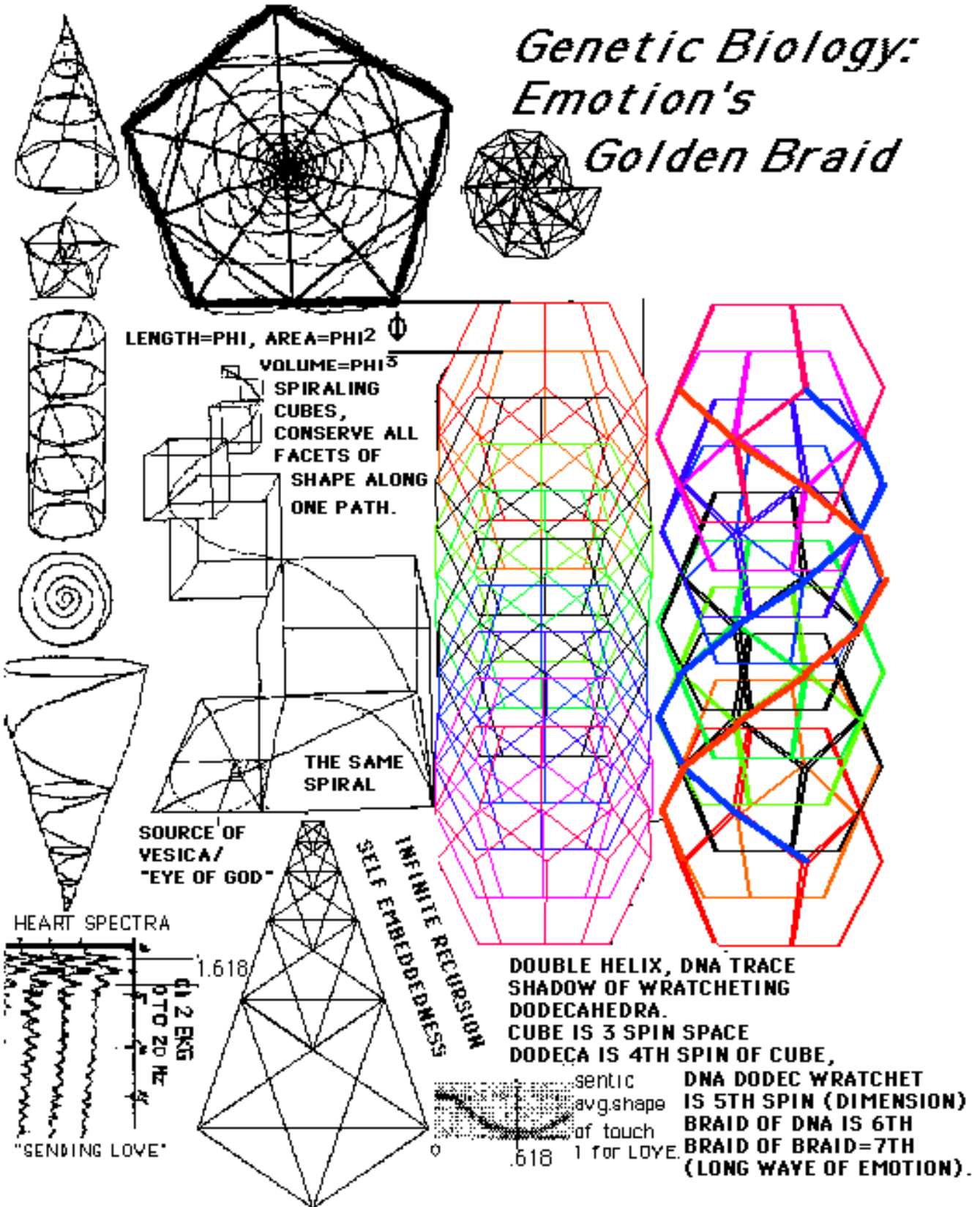

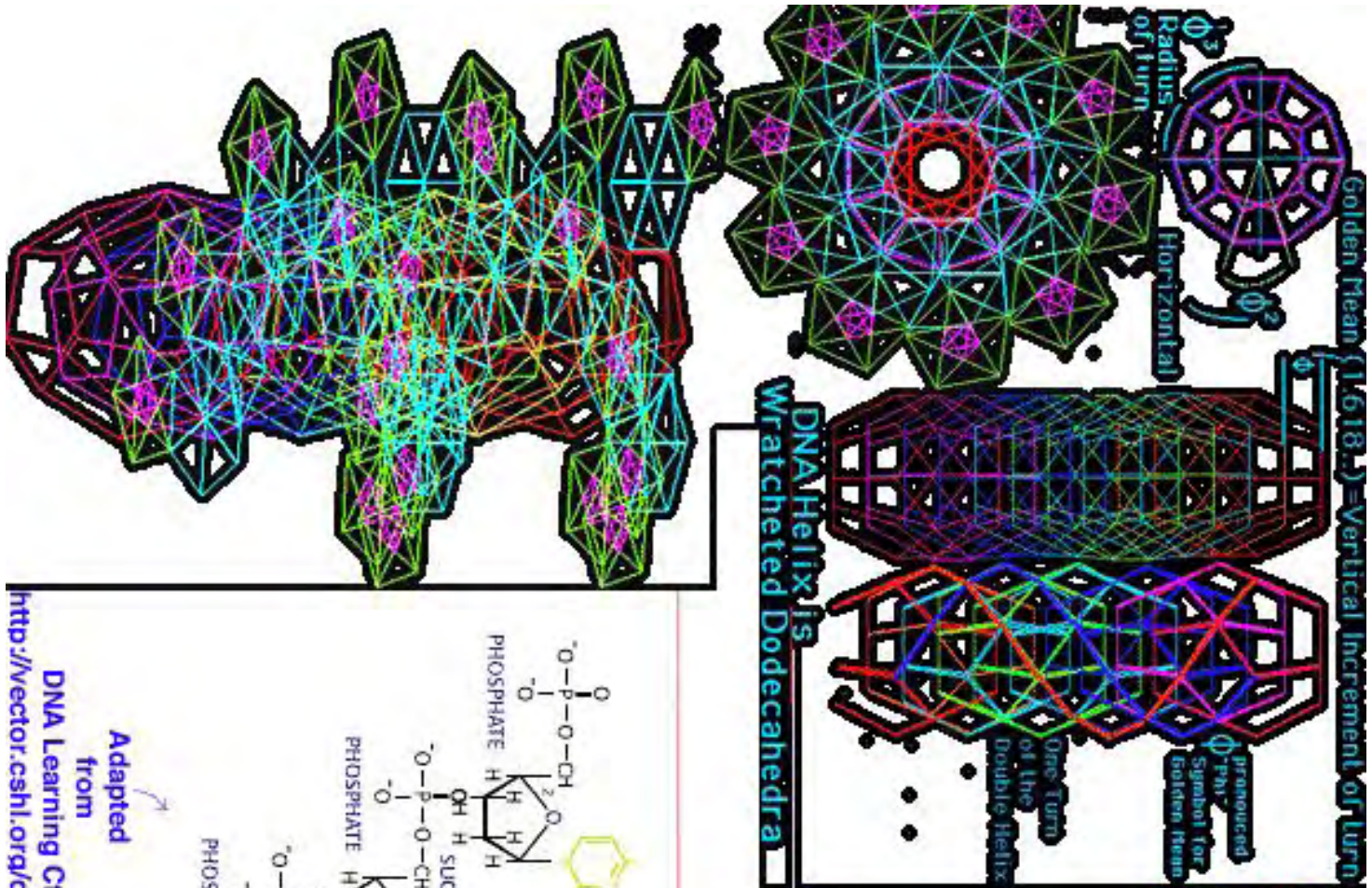

One Rung of the Ladder of DNA  
Golden Mean Pentagram  
to Hex,  
to Golden Mean Rectangle

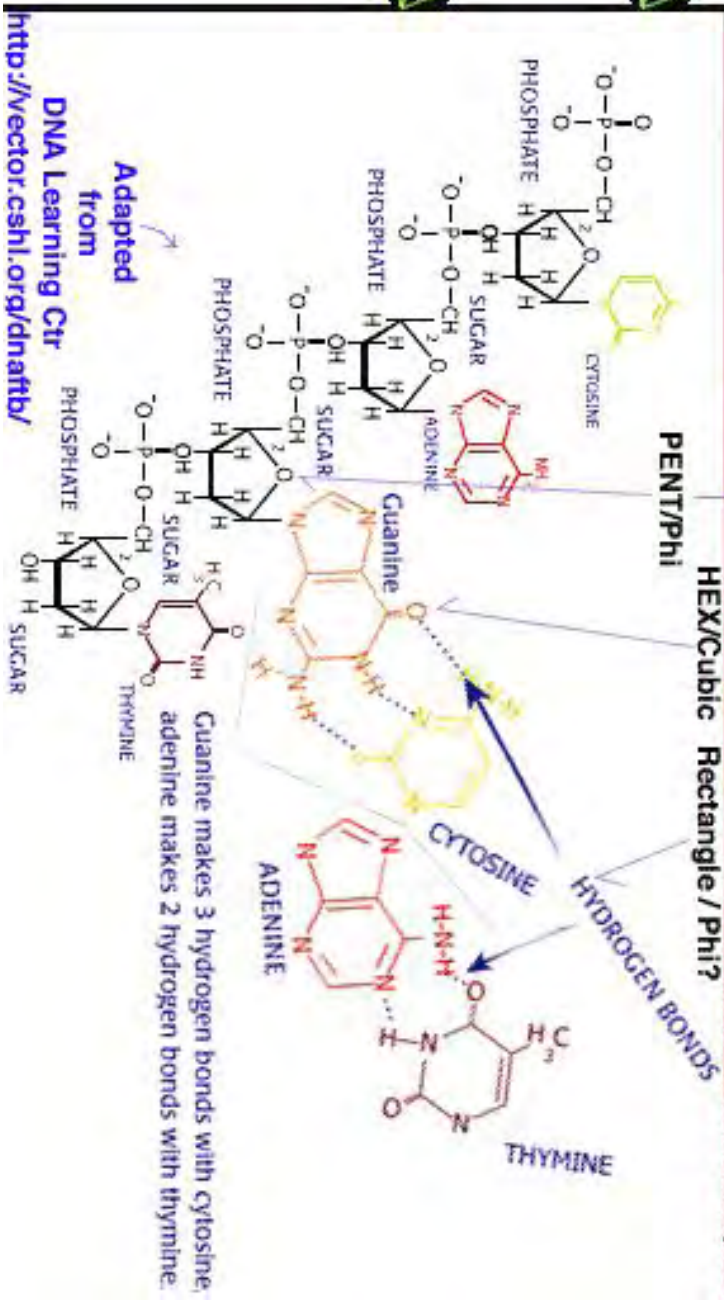
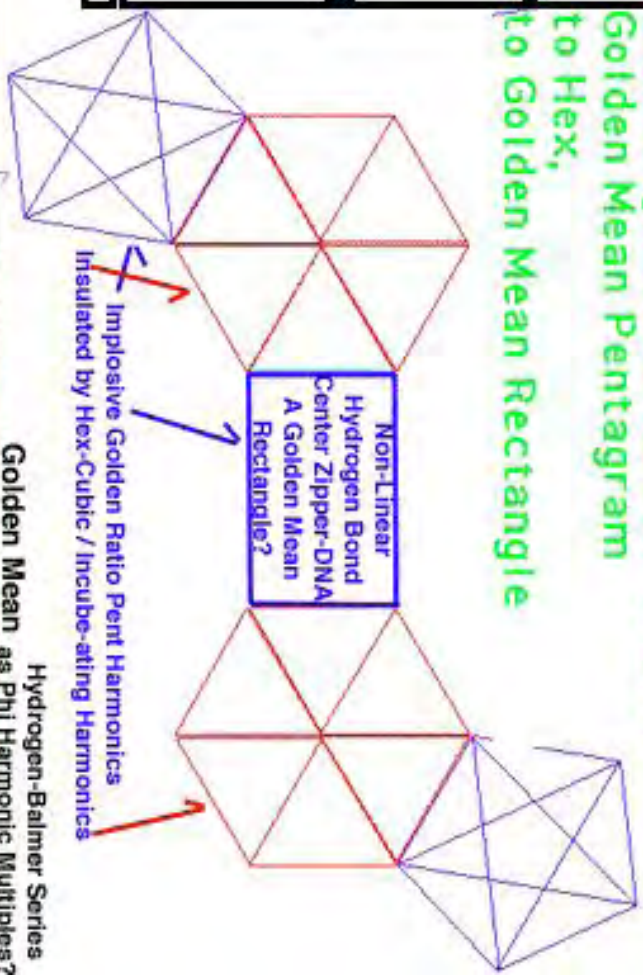

**1.618 is also the ratio of the DNA structure** . It is the only ratio that allows complete information or geometry to cascade down the harmonic series without destructive interference (achieving perfect fractal "implosive" data/wave compression) - spin path to zero point.

One 360 degree turn of DNA measures 34 angstroms in the direction of the axis. The width of the molecule is 20 angstroms, to the nearest angstrom. These lengths, 34:20, are in the ratio of the golden mean, within the limits of the accuracy of the measurements. Each DNA strand contains periodically recurring phosphate and sugar sub-units. There are 10 such phosphate-sugar groups in each full 360 degree revolution of the DNA spiral. Thus the amount of rotation of each of these subunits around the DNA cylinder is 360 degrees divided by 10, or 36 degrees. This is exactly half the pentagon rotation, showing a close relation of the DNA sub-unit to the golden mean.

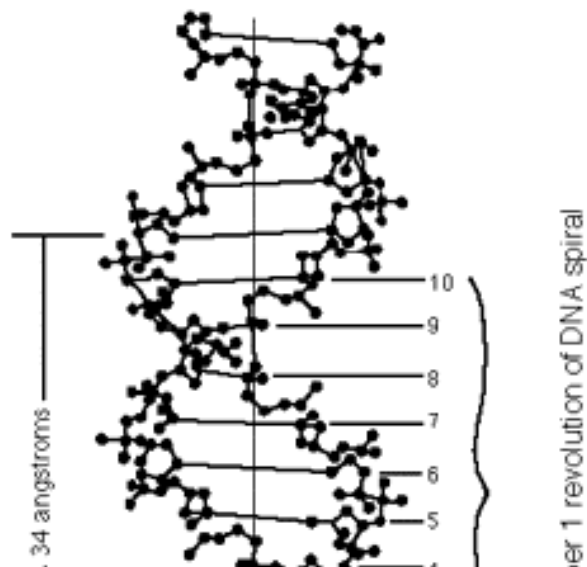

**Visualizing Clearly- "12 strand DNA" -mechanism of lo phi to embed...**

The braided thread of DNA helix is a 'wratched dodec'...

It is made of 32 degree tilt cube into dodec is the 4th axis of rotation (the only meaning of 'dimension') superposed. ('tesseract cube')

Wratchet that dodec down a helix - that is another (5th) superposed spin (dimension)

-so the thread is 5D

-Now if you take thread and braid it so that the lengths of the braid 'humps' (answer lies folded in an envelope) such that the envelope is a multiple of PHI times the diameter of the thread (envelope to carrier wave ratio)..- LO wave Phi ratio.. lo phi

you begin to program implosion thru lightspeed by recursive constructive heterodyning (ensoulment) into DNA ( by the EKG phonons of bliss) now the thread is string.. (6D)

then you braid the braid.. now the thread is rope (7D)

then you braid the braid of the braid on the braid -(until you have added 7 MORE spins {of tetra} onto the thread) 12D. - **12 strands.**

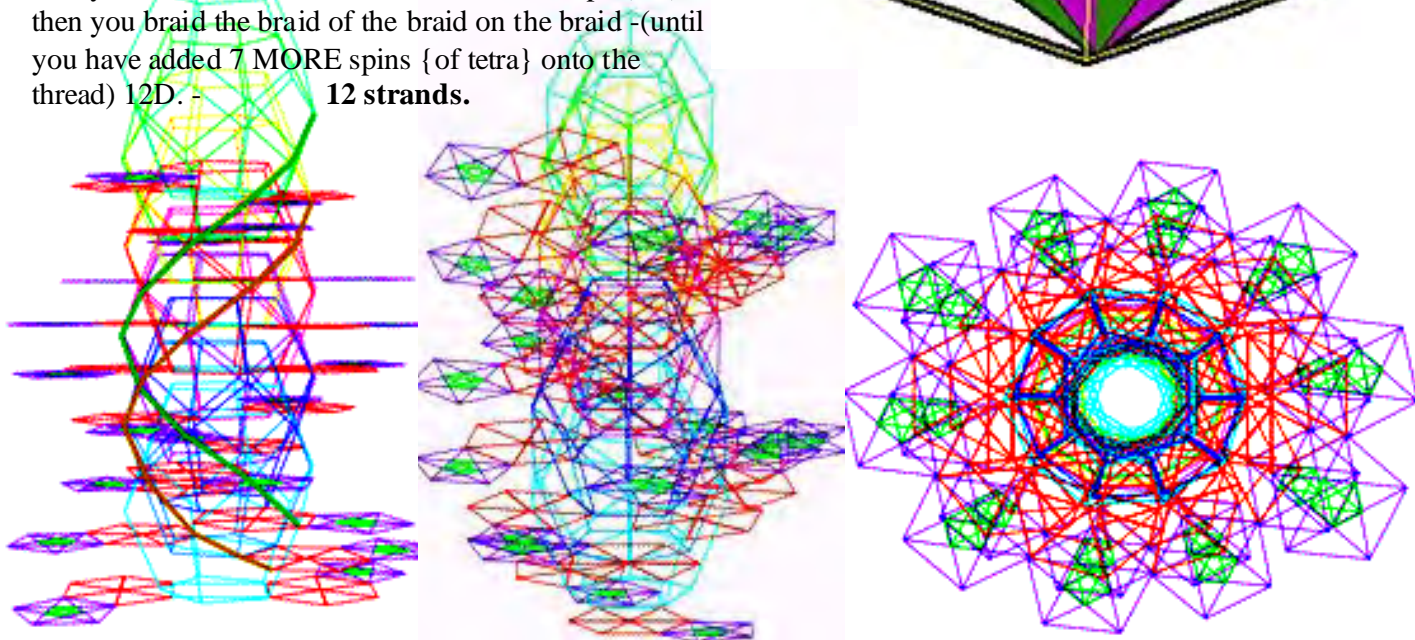
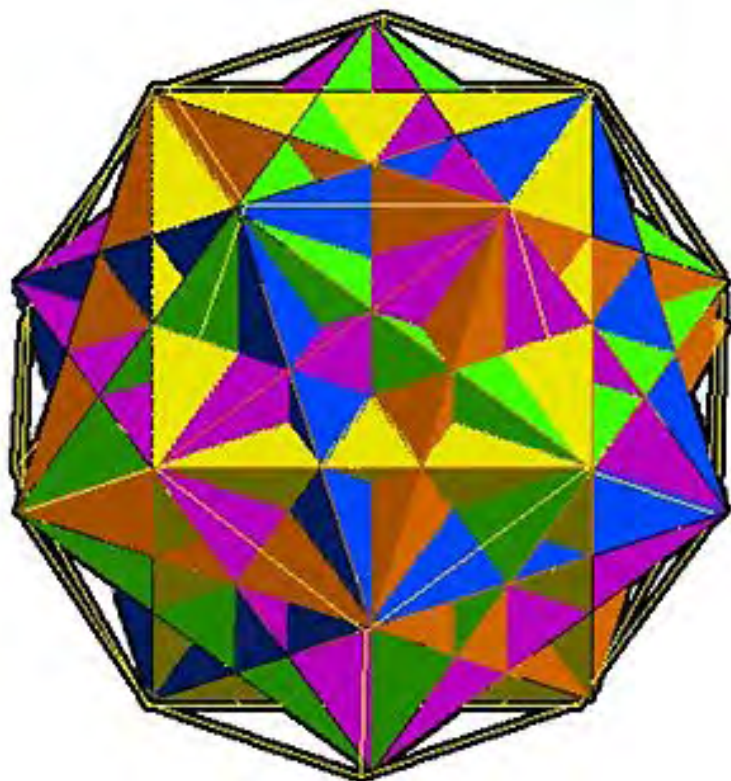

Now let's try to visualize what braiding does to the <sup>111</sup>wave envelope structure within DNA..  
 Imagine that the Double Helix above are the musical wave sample shown below..

just a sine wave beginning to be compressed or embedded..

-- Now we notice what it looks like if we zoom out and see these "short" waves (the short waves being equivalent to the high quality and sexy Ultra Violet Light.. "blue fire in DNA"..)

in the \*CONTEXT OF THEIR EMBEDDING IN A LONGER WAVE ENVELOPE AS A RESULT OF COHERENT BRAIDING.. THE LONGER WAVE ENVELOPE WITHIN THE BRAIDING PROCESS of DNA BEING (potentially) THE LONG SOUND WAVES COMING FROM THE HEART EMOTING COHERENTLY.

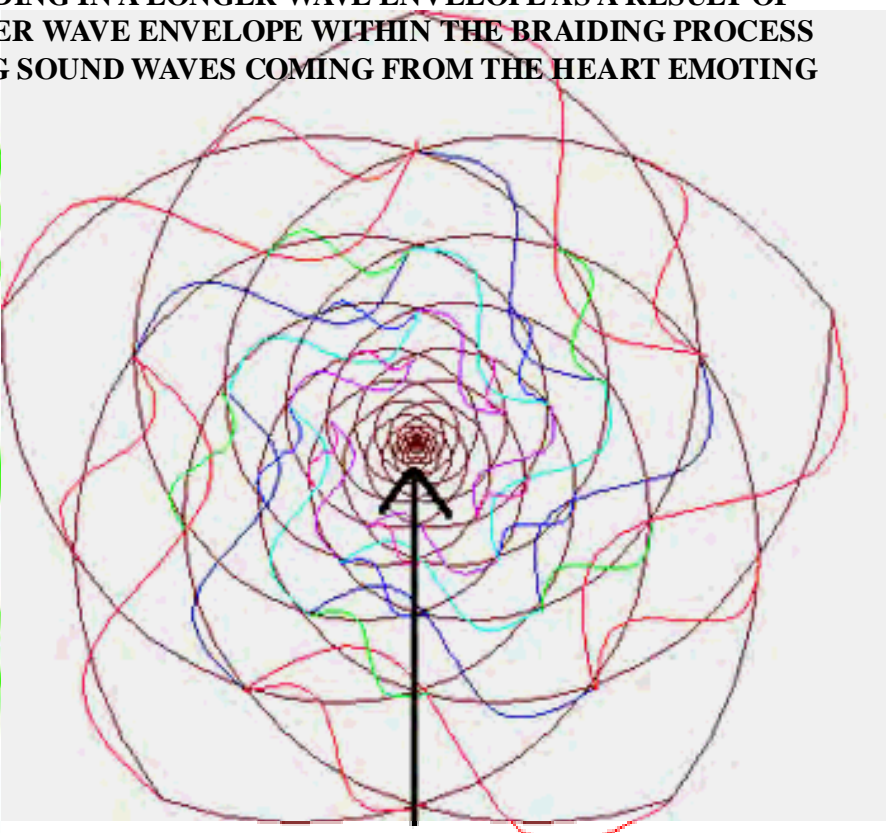
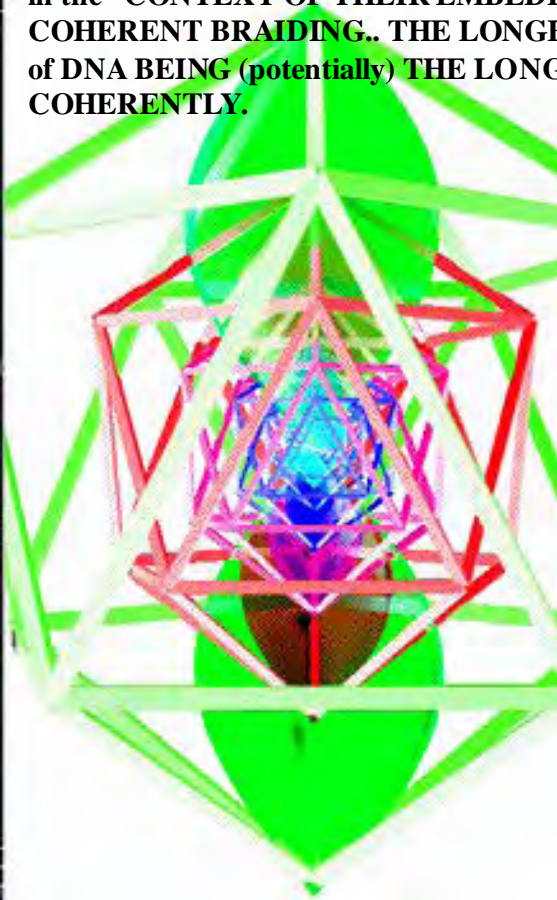

Increasing Braid Density , Increasing CHARGE Density,  
 Increasing AWARENESS Density

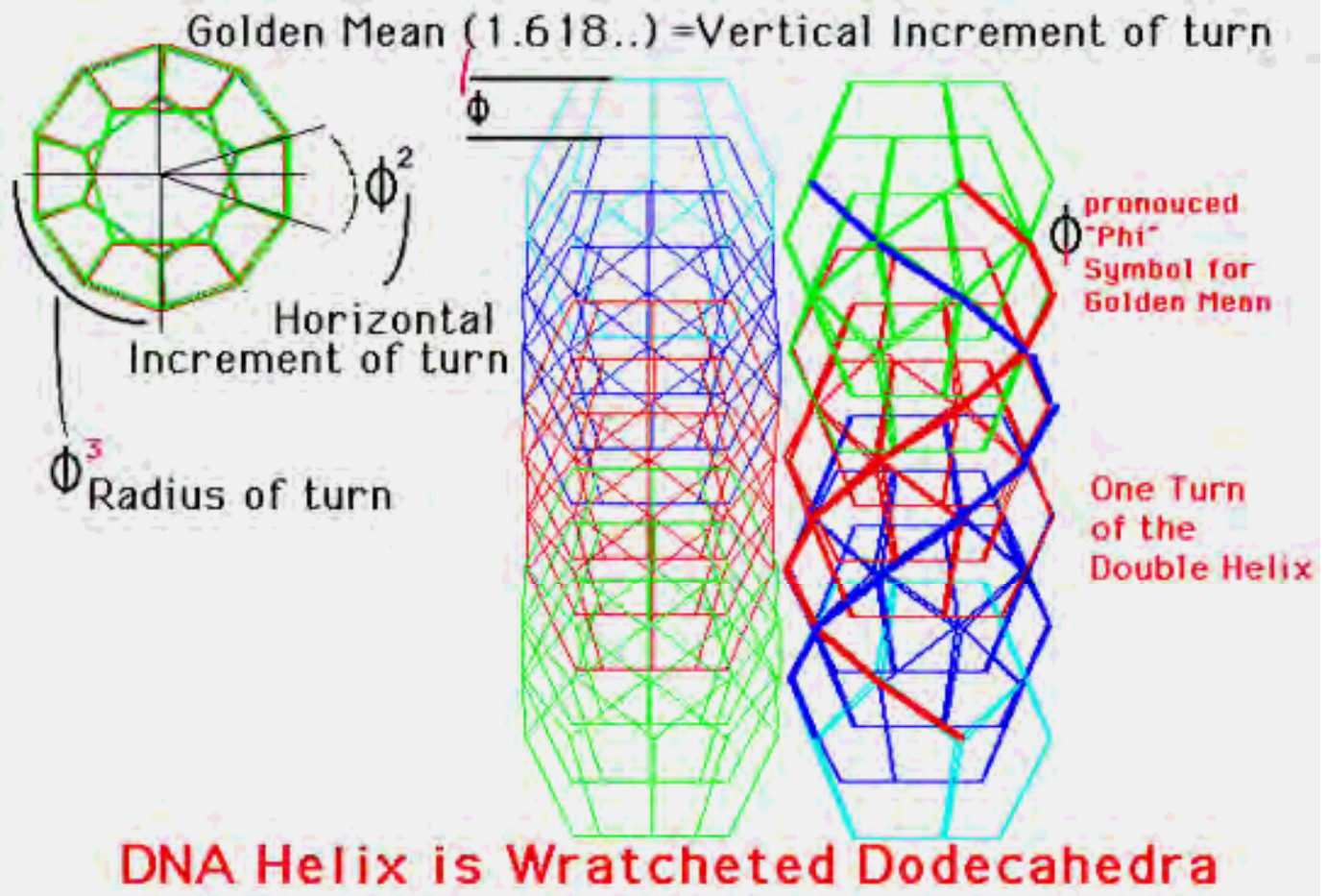



The DNA molecule is shaped like a twisted ladder.

The distinctive "X" in this X-Ray photo is the telltale pattern of a helix.

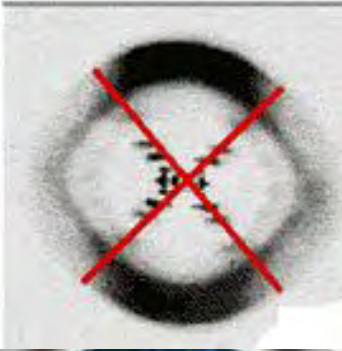

A "Magnetic X" details: [soulinvitation.com/magneticx](http://soulinvitation.com/magneticx)



Eye-see. Vee seek a PI that sees/ Vesica Pisces  
Is Perception the Compression that Sorts  
- by Accelerating only what IS Shareable?

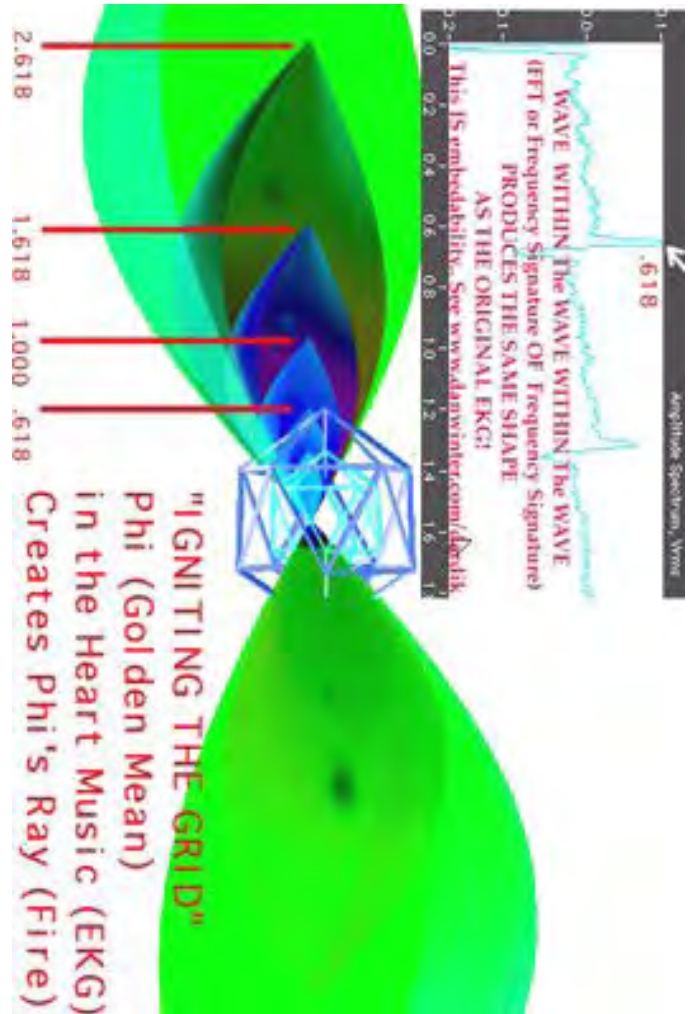
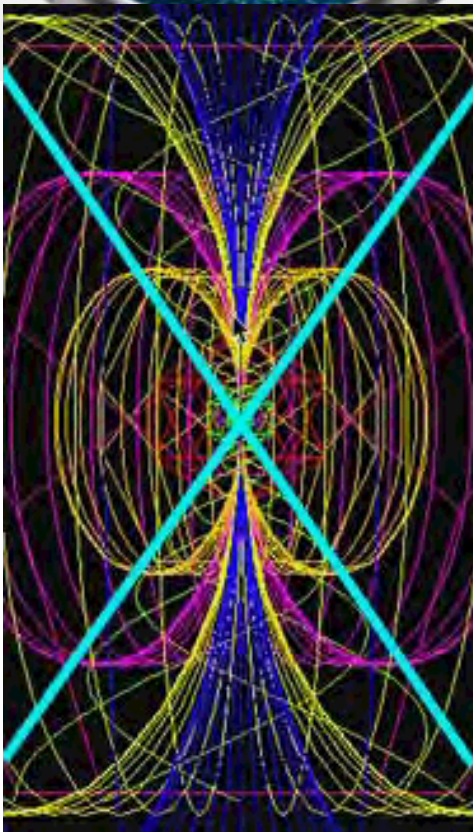

The individual strands of your DNA are short waves with a wavelength in the UV. This high quality and sexy Ultra Violet Light.. "blue fire in DNA" - becomes the information dense MOTOR of cell metabolism. (As biophysicist Earl Etienne used to say - high quality ultraviolet light is the ultimate product of cellular life. It is the driver of meiosis and mitosis. . ( *the ritual dance of cell replication - designed to phase lock longer waves of charge - a good definition for ritual* ).

Zoom out and see these "short" waves in the CONTEXT OF THEIR EMBEDDING IN A LONGER WAVE ENVELOPE AS A RESULT OF COHERENT BRAIDING.. THE LONGER WAVE ENVELOPE WITHIN THE BRAIDING PROCESS of DNA BEING (potentially) THE LONG SOUND WAVES COMING FROM THE HEART EMOTING COHERENTLY. (Heart Harmonics at the moment of Love:

see: [heartcoherence.com](http://heartcoherence.com)

information between fields? And if so, is this the only geometrically permissible path for inputting information into the immune system, from the glands / from human intention? Is this how the heart phase entrains by geometry, the much physically larger oscillator: the human brain, thus establishing the information matrix which determines which pressure patterns trigger emotion (as in the ringing of the glands) there?

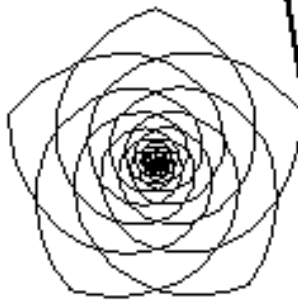

Front

The harmonics measured in the EKG **cohere-ing** at the moment of compassion - create the cascade to carry charge down into the DNA!

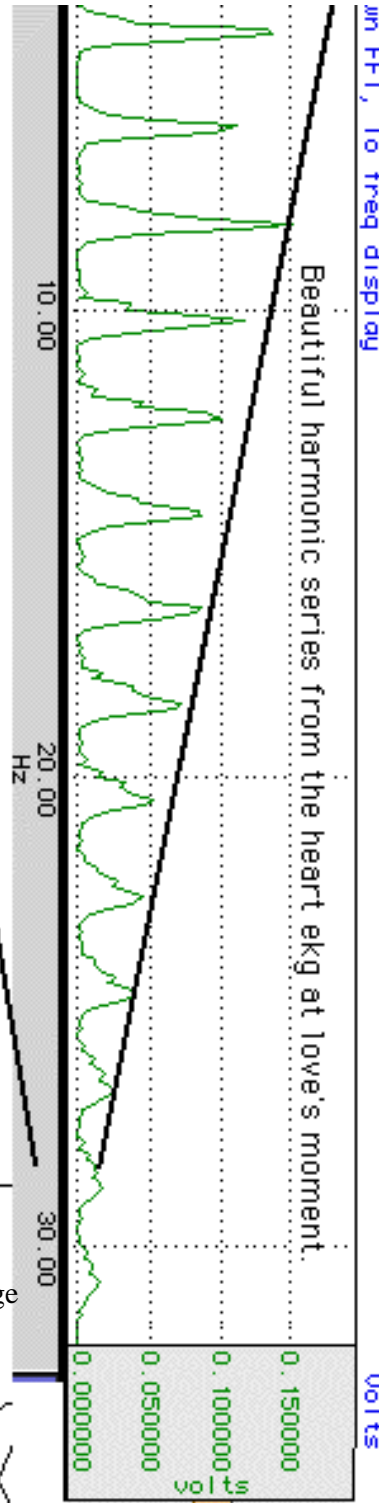
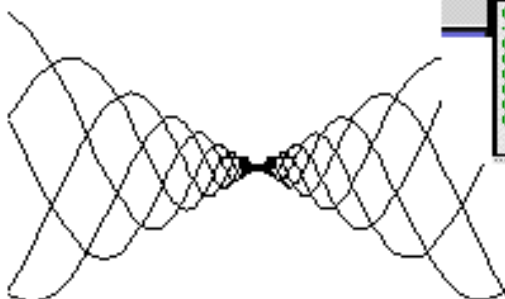

Beautiful harmonic series from the heart ekg at love's moment.

ln FFT, 10 freq display

= 999.8 Hz  = 0.000 Hz  = 0.0004672  = 999.8 Hz

Spectral of SARR #7; CH 1

The side view of a golden mean spiral when laid onto the 60 degree light cone which nests fractal dodeca, is a simple caduceus shape. The relative phase angle of this caduceus, tells us what geometric array the heart is able to touch and couple. (for it's electricities, and therefore it's information content.)

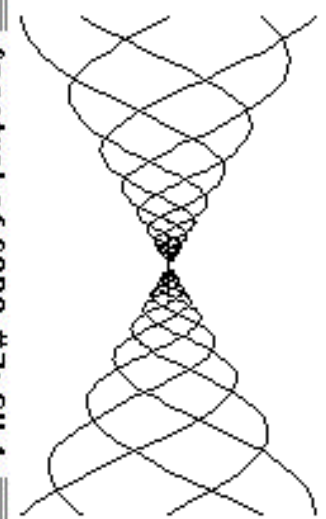

Top



Quoting from  
**Dr. Irving Dardik MD.**  
*Formerly of the Olympic  
 Medical Committee:*

*In his article on  
 Heart Harmonics which create  
 the Fractal or Harmonically  
 Inclusive HRV  
 (Heart Rate Variability)*

*which statistically virtually  
 predicts the elimination of  
 chronic disease..*

soulinvitation.com/dardik  
 originally: Cycles Magazine

*“It is a wave within a wave -  
 waving. It is SUPER-Looping”*

*The Heart Beat as a wave,  
 nested within the Heart Rate as  
 a wave, nested within your  
 Breath as a wave, nested  
 within your Day?? as a wave,  
 nested within your .. planet..  
 star..?*

Making the connection..

Glen Rein - did the study at  
 Heart Math Institute,  
 after we discussed the  
 chapter from my book  
 “Braiding DNA: Is Emotion  
 The Weaver?”

soulinvitation.com/rein

showing DNA braiding  
 responded MEASURABLY  
 to coherence in the EKG!

The zipper wraps - by listening  
 to the piezoelectric snake  
 charmer of the heart sounds..  
 in bliss.

The braid programs codons  
 because only those exposed get  
 access to RNA. Emotions -  
 program DNA by geometry.

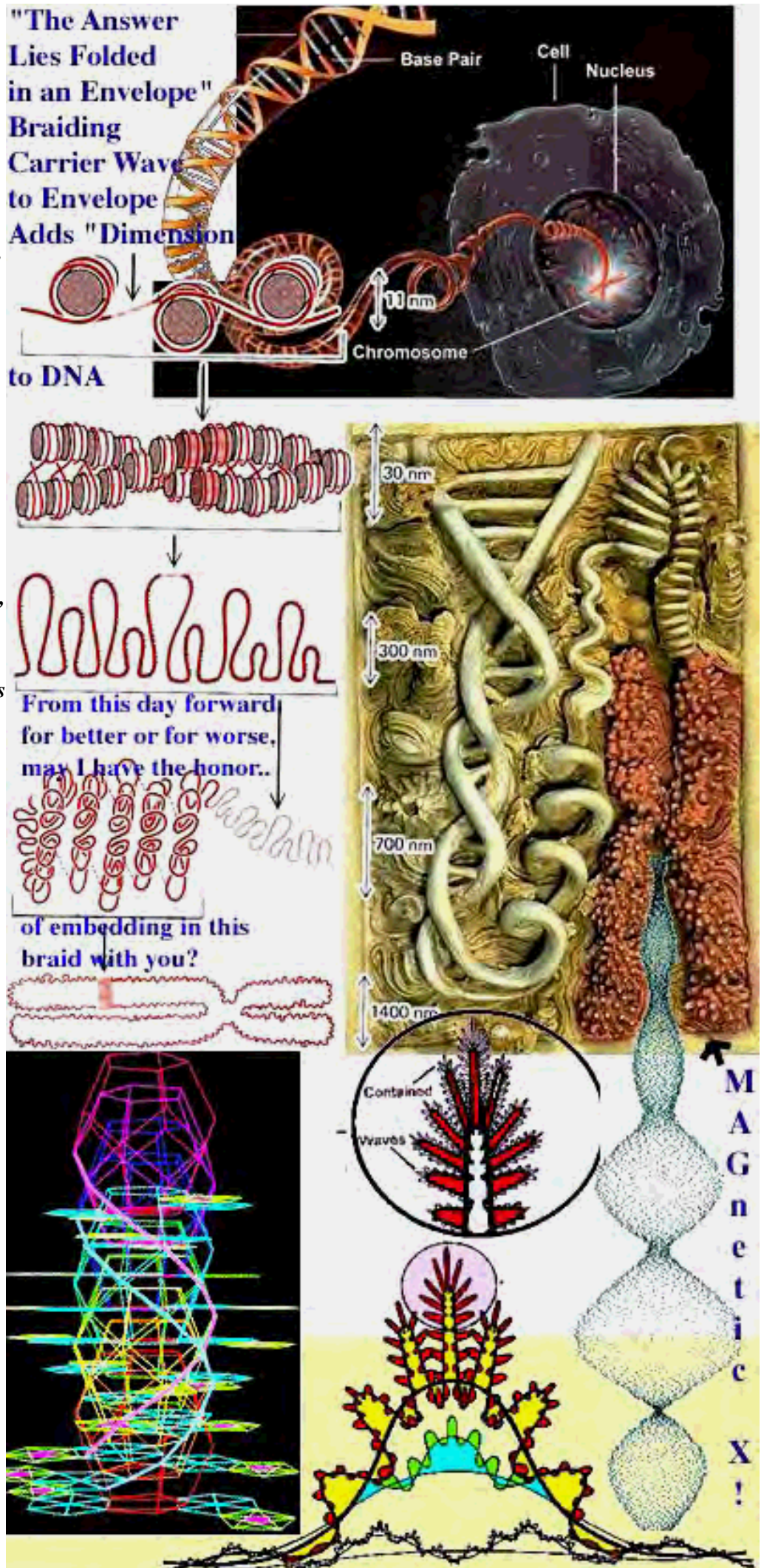

## More on 'Plaiting' Your Lover's Pony Tail -- or - The Braiding Gene Story...

Now let's try to visualize what braiding does to the wave envelope structure within DNA..

Imagine that the Purple and Blue Double Helix above are the musical wave sample shown below.. just a sine wave beginning to be compressed or embedded..

*How does BRAIDING WORK? You take two handful strands of your lovers long hair. Then you make an over, then under motion until you have plaited or braided her pony tail. Now, since your hands get closer and closer to each other as you braid, thus - when you are done - if you were to take the hair from one hand and instead draw the path in space you had followed with a pen, you would have drawn: the CADUCEUS SHAPE WHICH IS THE SPECTRUM ANALYSIS OF HEART EKG DURING BLISS.*



Left: the strands - of the double helix ABOUT to begin braiding (the 'carrier wave' - get's 'folded in an envelope')



On Context in DNA refer to the book: "Grammatical Man: Information, Entropy, Language and Life", by Jeremy Campbell... his answer to the question: Why is the wave information propagation SIGNAL TO NOISE RATIO so high (so good) in DNA?

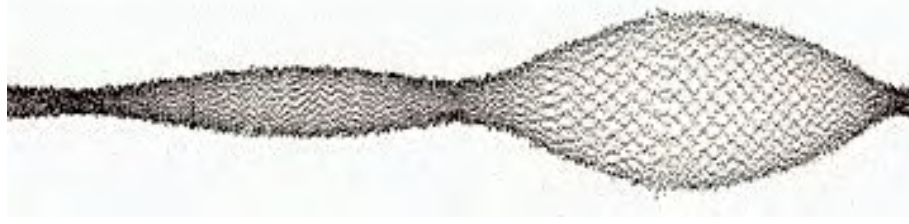

The book calls this CONTEXT DEPENDANCY.. Because the codon within the codon nesting accuracy of the sequencing of DNA is so high, then if one gets lost, the context alone provides the info on how to replace.

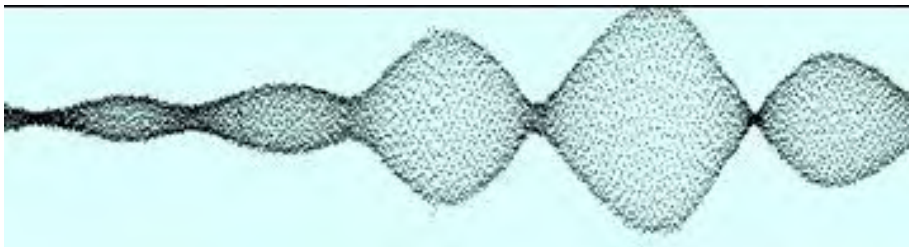

The only possible geometric way to understand what has been described in the literature as context richness, is the geometry of BRAIDING.... NESTING... "The answer lies folded in an envelope"

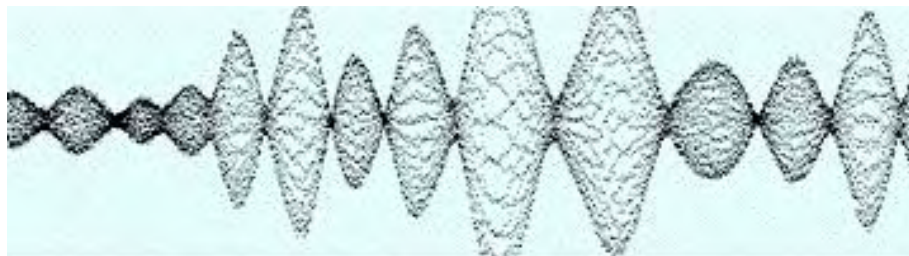

As we zoom further and further out, we discover if there is discipline, or coherence in the braiding algorithmn of our DNA..

we begin to see that the only possible coherence or nesting within nesting that IS POSSIBLE, is the perfect geometry of nesting, WHICH IS THE GOLDEN MEAN RATIO IN THE BRAIDING OF DNA..

(massive coherence/real genetic psychokinesis, is ONLY possible in the presence of massive recursion/ perfected embedding).

When a braid nests upon a braid - 'recursively' - eventually the thickening DNA rope would.. turn inside out?

next up..... BUT WAIT - WHAT WOULD HAPPEN IF THE GENE WANTED TO FINISH THIS BRAIDING INTO RECURSION / TURNING INSIDE OUT.. What would TURN OUT??

*Introduction to - Circular DNA - Ring DNA & Lord of the Ring...*

### The real story on the 12 STRAND DNA Idea:

Summary - **Geometry of DNA.** is a four-dimensional Dodecahedron. When the braid of that is completed on another braid - the thread strand fits in the string strand - fits in the rope strand - fits inside the FAT rope strand - Until - potentially - we could talk about 12 'strands' in DNA. This could be discussed in biology meaningfully by spectrum analyzing DNA. (In the same way the 'Boson 7' spectral signatures of DNA's output predicted who could time travel at Montauk). We suggest that 'new age' friends should use words like braiding and nesting and harmonic analysis - and not just talk about putting in another 'strand' in DNA - lest scientists be alienated by non-rigorous language.

This superposing of axis of SPIN symmetry - is the only definition possible for ENTERING THE NEXT DIMENSION.

This is a **very loving embrace, and is the same for the "dodecahedral" shape of the Earth Grid and Zodiac. DNA is a fractal attractor because of its self-similarity - that is how its inner structure is a mirror of its outer structure.** DNA geometrically is a wratched or spun dodecahedron which snaps in place like walking down a slinky or helix. Then the thread of that double helix slinky is taken up in a BRAID. The sound of your heart singing BLISS (a phonon wave) BRAIDS your DNA coherently - until the NESTING of the short wave is EMBEDDED perfectly in a longer wave. Eventually your DNA is a BRAID which nests perfectly the waves of high quality ultraviolet light - to share inertia with VERY long waves from your heart sounds - your land - and even stars! In the advanced material we will study evidence that a particular symmetry based on the sacred alphabet can push your DNA into a ring donut - and implode - shooting your biology thru the speed of light - a RING LORD. DNA

[The RING in DNA - Genetically Going in Circles May Eventually Turn You Inside OUT!-the academic view](http://soulinvitation.com/circularDNA)

[soulinvitation.com/circularDNA](http://soulinvitation.com/circularDNA)

The sonic 'recipe' for bliss (in brain and heart waves) entrains by BRAIDING the DNA - allowing emotion to program DNA.. and ultimately welding DNA into a toroidal 'ring' donut which enables it to compress / acceleration biological magnetism thru the speed of light. [PhiRICAIS:PHI-Recursion-Induced-Charge Acceleration/Implosion Solution](http://soulinvitation.com/phirica) [soulinvitation.com/phirica](http://soulinvitation.com/phirica)

This allows successful lucid dreaming, psychokinesis, and dying.

The tilt angles necessary to fuse DNA's braiding into an implosive RING - making you a LORD OF THE RING - became - the origin of our AN-gle-ish alphabet at: <http://spirals.etermite.com>

The ultimate of the braiding process is the moment when the wave learns to eat its own tail. That is how tornados and vortices and implosion becomes self organizing.

HOW TO STEER Tornados as the origin of dowsing at: [Good Feng Shui When Scientists Cross Ley Lines With Dowzers?](http://soulinvitation.com/good-feng-shui)

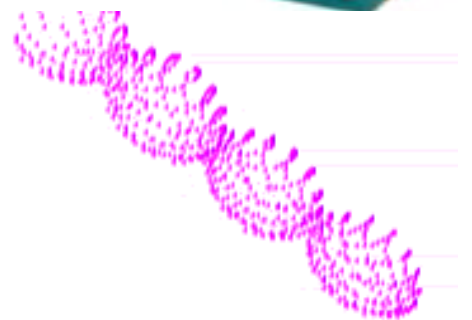
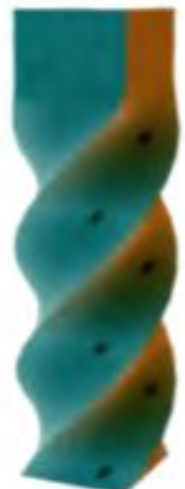

## The RING in DNA

- Genetically Going in Circles May Eventually Turn You Inside OUT!

Intro -prelude from Dan Winter: Academic Paper - CIRCULAR DNA - from Ken Biegeleisen.

It is a pleasure to share this RINGING DNA material - thanks to Ken Biegeleisen - who has formalized and represented his paper here on TOROIDAL or CIRCULAR DNA (relating to the concept of 'Braiding' DNA) - with academic references.

Many misconceptions can be cured to the point of real self-empowerment by this kind of thinking:

Misconception ONE: I am going to get spiritual and cosmic and immortal (biologically sustainable) when divine force (the astrology of charge?) adds '12 strands' to my DNA.

More the Truth: IF you choose the hygiene to eat, and live in, and dance in, and HAVE BLISS in-- - LIFE FORCE and therefore CHARGE - THEN your DNA may absorb that charge by enveloping itself in the recursive braid which ENSOULS - (implodes). The addition of strands which appear to happen when you braid thread into string into rope, is because of braiding (the answer lies 'folded in an envelope' - see pics below). Braiding your DNA is something you do and learn by choice - to absorb 'spin' (charge) - not something 'GOD' does for you. Only the strength of will growing in the sun-shine of shareable and embedable intent - is sustainable (and therefore able to be 'saved').

reference pictorial articles: braiding DNA , Decoding DNA, 1 Magnetic X in DNA, Superconducting DNA, Letter to the UN on Genetic Engineering as Coherence LOSS now Measureable. see [soulinvitation.com/decode](http://soulinvitation.com/decode)

Misconception TWO: The compression spin map called "Alphabet" on the side of the "LORD OF THE RING" - RING - is too powerful for anyone to hold.

More the Truth: **The 'RINGing' which causes thoughts / emotions to become objects is the implosive nature of DNA which when braided (into a 'ring' donut) recursively by BLISS compresses charge in the only process (charge compression) which turns light (ether) into matter. (and DNA into its real destiny as a gravity making star bender) .The index to those possible angles of (Golden Ratio) compression is precisely the equation for the origin of most alphabets of Earth - specifically including Hebrew and Arabic... for the specific reason that only those biological structures which USE that symmetry discipline (to symbolize is to embed / embed or die) get to be sustainable (immortal).**

animations: <http://spirals.eternite.com>

Misconception THREE: DNA controls our destiny.

More the Truth: DNA is a shapeshifting mag worm which merely bends itself as a wave around the fields we form by bending the magnetism we call emotion and sacred space. It is a relatively passive mechanical linkage device designed to helpfully slow down the rate at which emotions become objects- so that we FEEL and understand the connection between CREATION and what we just now felt. Once the need for slowing down that response of stars to feeling, no longer exists - then DNA is replaced by its own etheric essence (superluminal compression field) - and we can bend light by implosion directly (only love bends the light / embedding).

If we choose consistent spin-dense and sustainable magnetic environments - then DNA responds by adding that inertia to our life force - so that eventually we gather the inertia to properly create stars and become suns ourselves. Otherwise we die a death which is permanent. DNA is merely a biofeedback device to tell us when we have consciously chosen the CHARGE and LIFE FORCE - which makes us sustainable. Short-circuiting the function of DNA by changing the spin links we call codons mechanically is not only un-sustainable and destructive - but it fundamentally ignores the design of nature - which was that DNA help us take responsibility for the SHAPE OF MAGNETISM - and so learn that bending light into shape is how we too may create stars.

In other words - if DNA is not set free - as an intelligent shape shifting implosion worm - then it gets dizzy and unable to self- steer. (because it stops imploding) Freedom for DNA to make it's choices with respect is the key to freedom for humans! Hint: Do not eat angry DNA - monoculture makes DNA angry - your body makes mucous in defense. Wheat, most corn, and soy -are examples of DNA that contains mostly anger for this reason.

**To REALLY understand DNA - we must understand what is the ENERGY PSYCHOLOGY which  
TURNS IT INSIDE OUT! That is the moment your DNA -becomes self knowing  
- and YOU become LORD OF THE RING! ---- over>**

*When your DNA Rings.. Answer the phone..*



What say we make an ALPHABET of the angles of charge compression necessary to weld that elusive slinky DNA finally into a DONUT--- a RING!!! That way, it could finish the process of compressing charge (all biological memory) into the 'self-similar rose' fractal flower of recursion. This would non-destructively (by PHI 'heterodyning' - constructive ADDING of wave VELOCITIES) - ACCELERATE your biological memory THRU THE SPEED OF LIGHT .. (& make gravity in the process - why you lose 10 oz. or so at the instant of death?)

Your DNA is intensely aware that it is fatal (mortal) to be caught below the speed of light. In order

to avoid this embarrassing end to sustainability - your genes (being considerably smarter than you) are constantly trying to get up to speed (sustainable). They do this at moments when they have peak harmonic inclusive charge density available. Their raw material for getting thru the speed of light is the coherent ultraviolet light which is the ultimate product of cell metabolism (the most information dense stuff which comes out in a measureable burst- to choreograph / arrange the dance of cell replicating for example - microtubules as wave guides - also a key to the switch from cancer to bliss.)

*The glossary in back is helpful here*

Make your "COCOON": "If this is foreplay- you're in trouble" - When the enveloping particularly of the high quality Ultra-violet Light - reaches a particular threshold and escape velocity - that COCOON becomes navigable / steerable. This is the BLUE FIRE you see during good sex, tantra, kundalini, menopause, and BLISS. IT IS NOT A DISEASE.. it is rather your only hope to survive.

Meanwhile - if you are emoting blissfully - your glands are making COHERENT lo frequencies of sound energy (called phonon in the body - as a sound wave thru liquid). These are the waves which HeartTuner ( heartcoherence.com ) takes the frequency signature of to MEASURE - COHERENCE, PASSION - and the moment of phase lock - EMPATHY to the one you heal or love.

When those low frequency sound waves become ordered or COHERENT like a laser - then they can form orderly wave column like ENVELOPES which become steering "WAVE GUIDES" for much higher microwave and optical (light) frequencies. The skill to arrange these long wave STILL POINTS of both sonic energy and capacitive charge - is called STEERING YOUR CHI - in Tai Chi.

The DNA ultimately FOLDS ITSELF forging a RING DONUT.. in order to get the compression angles correct to cause the light ACCELERATION!

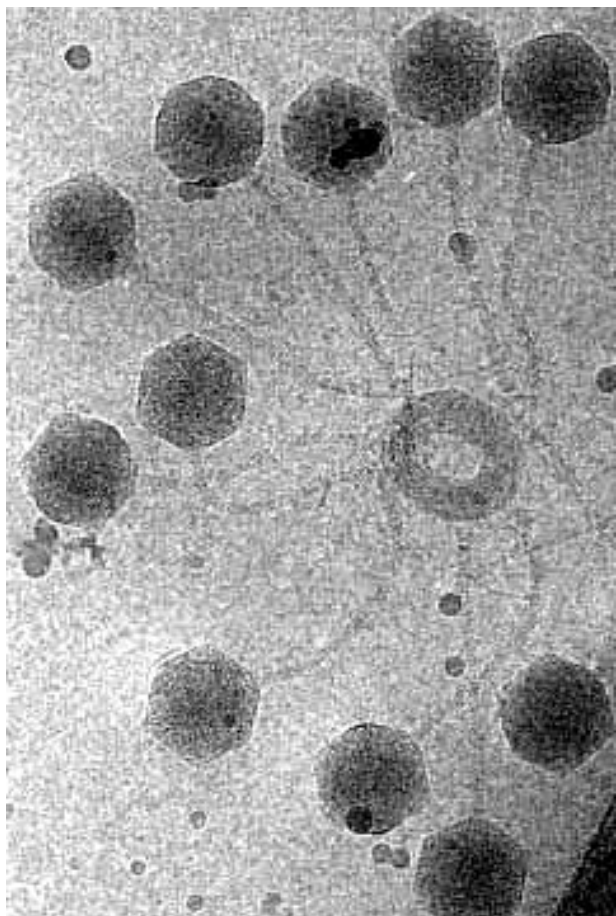

<http://www.aip.org/pt/vol-53/iss-9/captions/p38cap1a.html>  
<http://www.aip.org/pt/vol-53/iss-9/captions/p38cap1b.html>

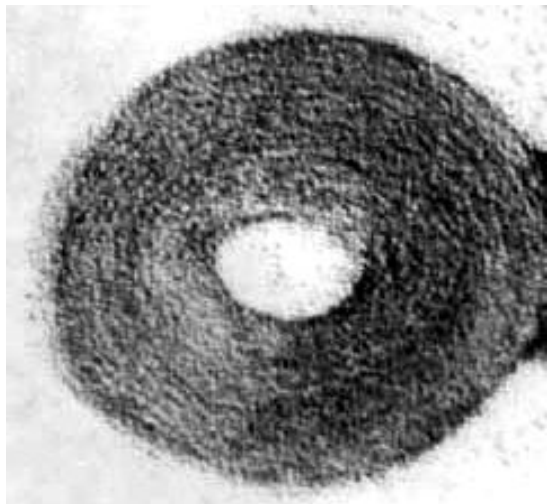

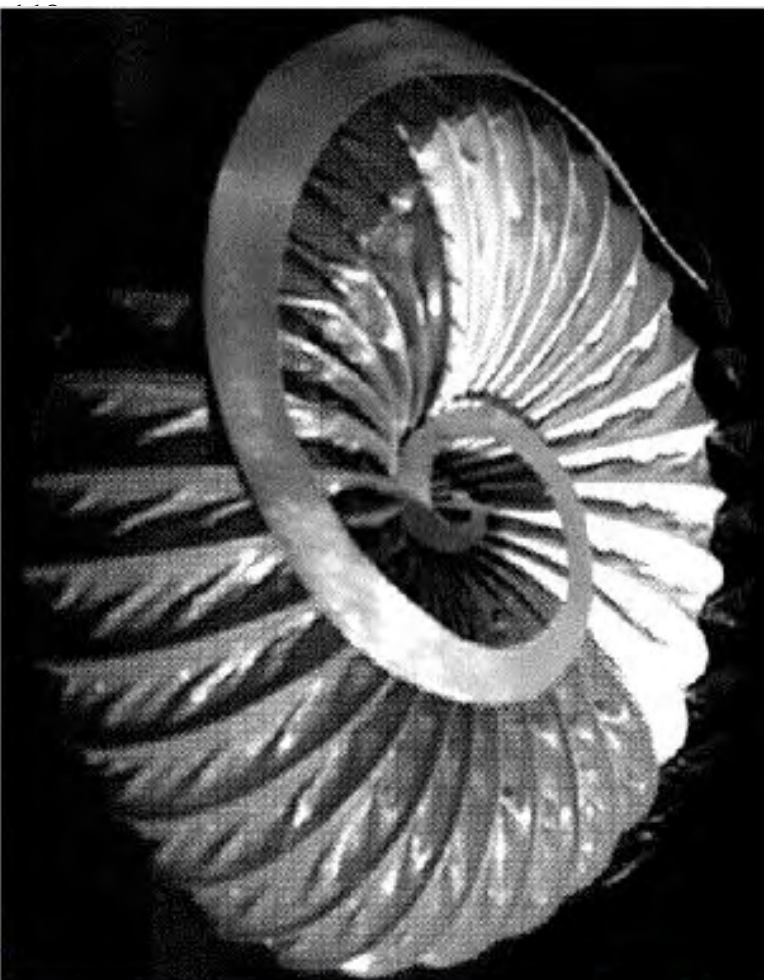

Notice how views of this sample spiral off the donut, seem like pieces of the alpha bet!

Spiral of the Golden Mean laid upon or sampling the donut.



top view, it looks like a simple spiral on a plane.

front view



side view



oblique view

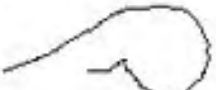

shades of the letter P or R?

Revolving that golden mean spiral 1/10 circle, upon the donut creates a 3D "flame letter" strip

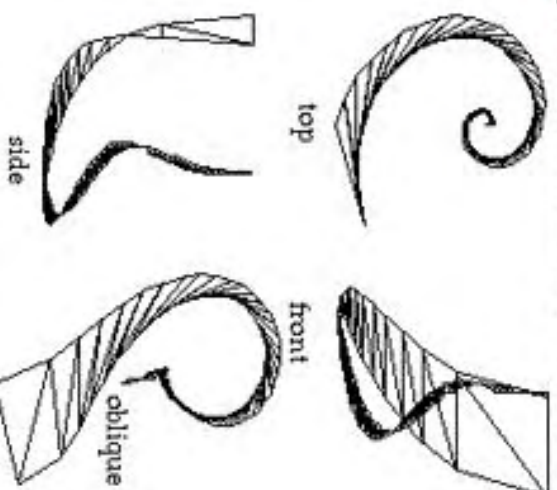

Now, having laid this spiral on the donut, we seem to have a good handle on how this donut this. Notice how this donut is like "Adams' apple".

4 Simultaneous Views or faces or phases of Adams primal apple or donut torus domain. This sample or bite, cast shadows from 3D to 2D (map between dimensions) making the alphabet.

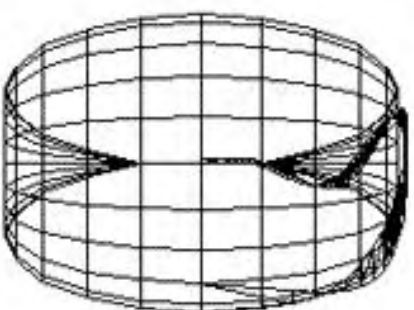

front view

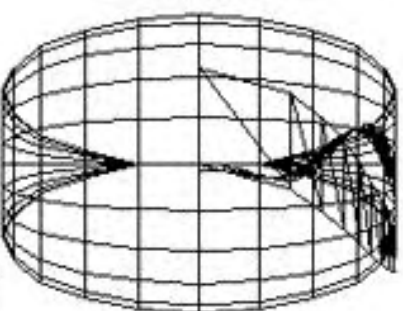

side view

oblique viewpoint

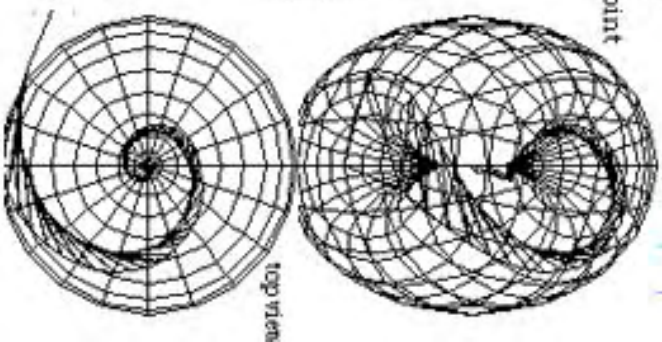

top view

2 infinite spirals of the golden mean, rotated 36 degrees, 1/10 circle.



Implosion Group reprints Dan Winter work- more detail: <http://spirals.eternite.com>  
TORNADO (Wormhole) approaches: Quick- what PATH will allow your spin to enter / inhabit / own / embed / and steer it?? lest you die.  
What simple wave hydrodynamics self-organize when they store the symmetry essence map to compression and embedding (origin of symb)?

We take the accurate (& self organizing) Golden Mean spiral, and map it on a Golden Ratio high simple (self-organizing) shape of all field effects.

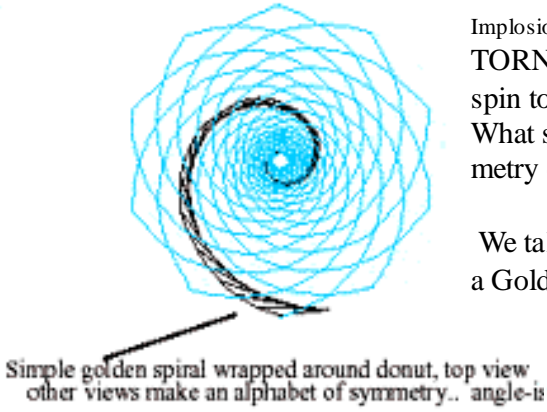

Simple golden spiral wrapped around donut, top view other views make an alphabet of symmetry.. angle-is

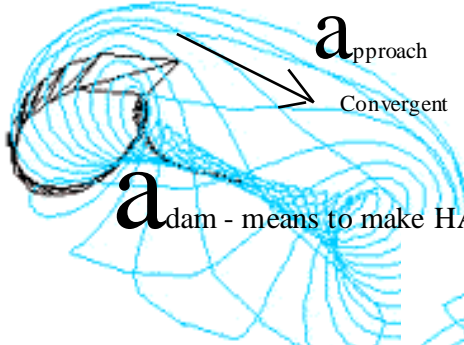

**a**dam - means to make HARD or RED (converge- yang - to pack -or make a seed)

This turns out to be the 7 color moebius strip on the donut - in which all color regions touch each other - This also forms the heart of the slip knot which Phires hydrogen (ANU), the human heart, and the heart of the Sun.

The arrows thru -co-define the 7 symmetry axes of the tetrahedron - which projected on Flatland - form the Labyrinth - Kinesthetic recording of the WAY to turn inside out in 3D (become self-aware)- shadowed on the 2D wall of the cave.

**We walk around that spiral strip - element of Phi-re, on Adam's Apple - and consume perspective.**

**Creating SYMBOL (embedding) is to record that shadow of the entry path into CONstructive compression. Alphabets are the index the various tilt angles of this magnetic domain - which could CONSTRUCTIVELY NEST into each other. These angles of tilt which permit chemical bonding of those field effects - form the ALPHABET of symmetry - simple as ABC ... of Permission to Touch..**

**This is the essential symmetry dynamic sometimes called Quantum Mechanics.**

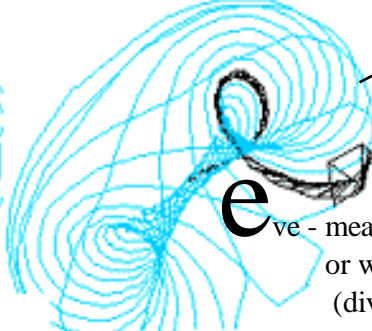
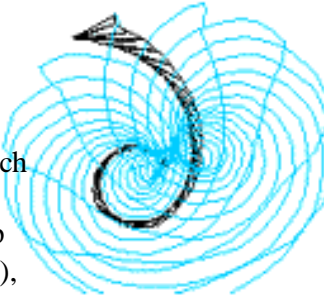
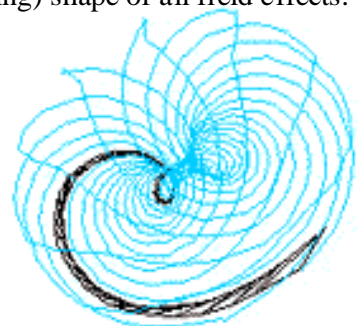
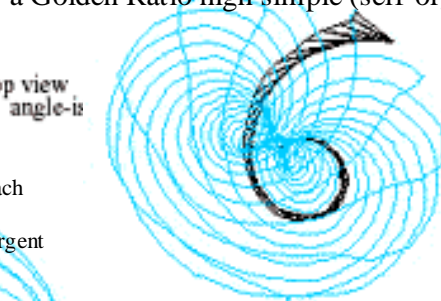

**e**merge Divergent  
**e**ve - means touch-making or wet making power. (diverge - yin )

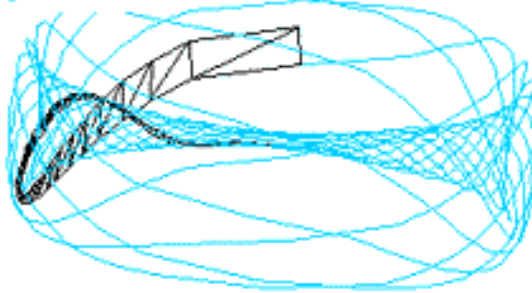
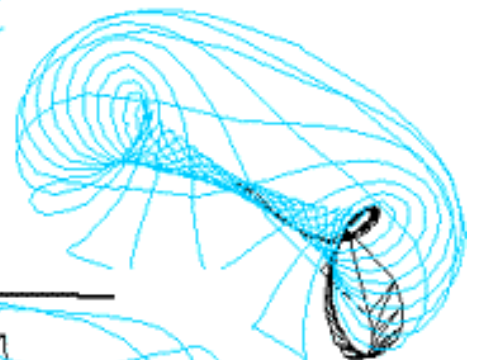
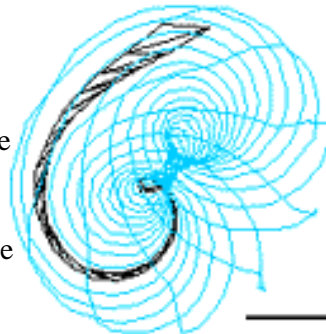

to make a word

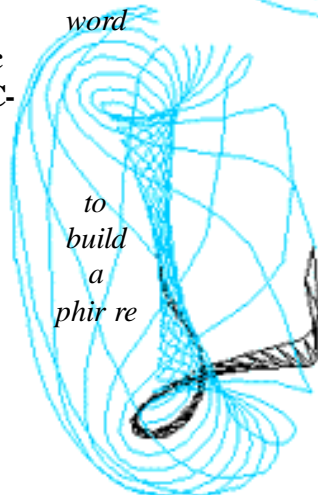

to build a phir re

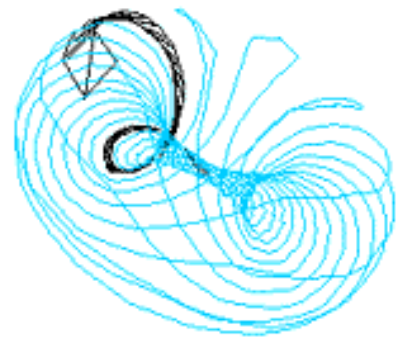

Wielding the MAGical SYMBOLIC Letters of PHirey symmetry -  
 forged the gene into a RING..  
 The power from the RING

to Implode and Accelerate  
 the Radiance / Blessing of Biological CHARGE - FUSED the informa-  
 tion at the 'holy communion' fractal coeur uniting ALL DNA.  
 Only the SHARE-ABLE (Able to Embed) Survived.  
 Pure Intention COULD hold the RING !!!!!!!

The actual letters Tolkien used to write Lord of the Ring - were supposedly derived from Finnish. This was one of the major destinations of the Draco ancestors Sumerian Annunaki - (roots of H-Ibi Uru, and Arabic letters- see ). They had codified the angles of magnetism spin vortex into a software environment for programming DNA. Specifically - there were only certain symmetry angles at which you could add charge compression to the torsional slinky of genes. (see pic below).

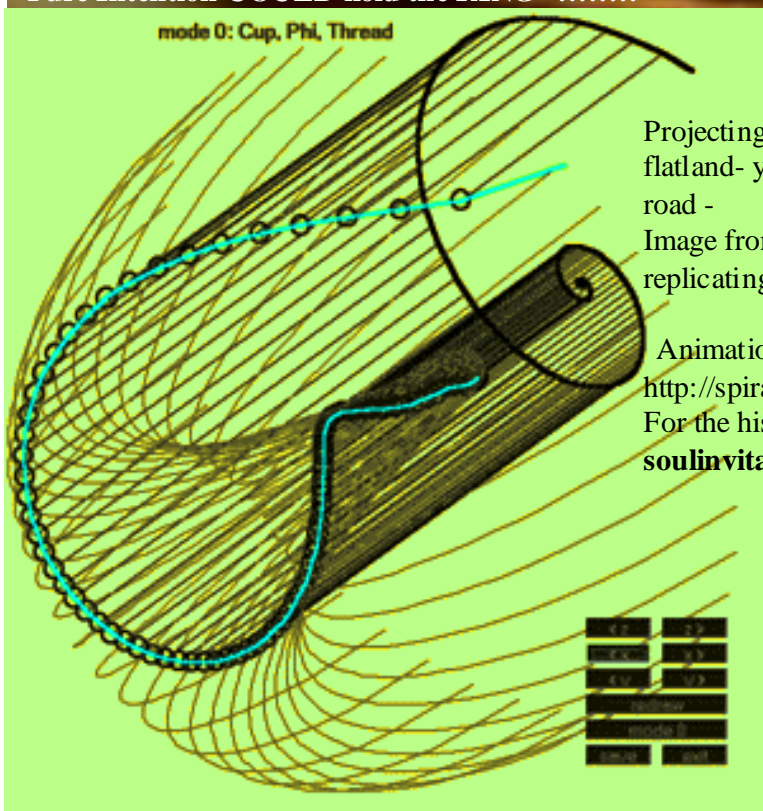

Projecting the spiral from flatland- yellow brick road -  
 Image from Ted Small - replicating Dan' work.

Animations & detail at:  
<http://spirals.eternite.com>  
 For the history:  
[soulinvitation.com/enki](http://soulinvitation.com/enki)

The spiral map "element of flame" projected shadow of spin compression - when seen from the symmetry faces of the Tetrahedron - are Hebrew(H'Ibi-Uru) alphabet.

Those tilt views were the machine code software environment of the central hive computer ASHTAR. They were the only world known to Enlil (Yalweh) - whose use of them on DNA produced only - a Tetrahelix - Golem - No soul.

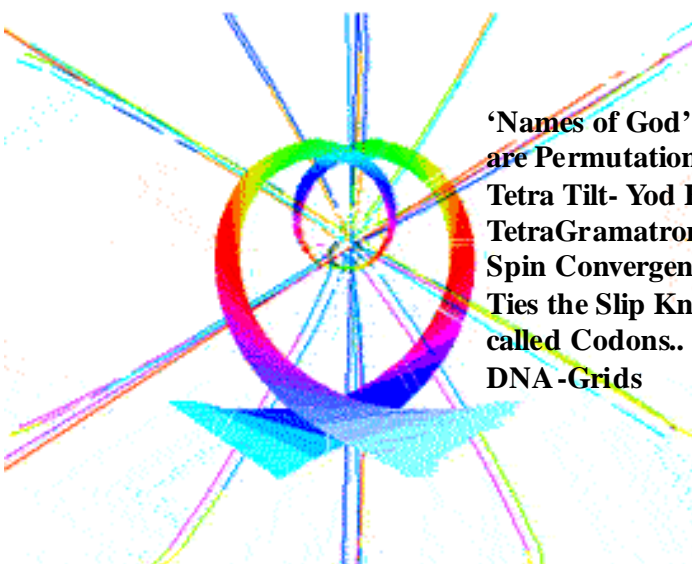

'Names of God' are Permutation of Tetra Tilt- Yod He Vau He..  
 TetraGramatron - Spin Convergence Ties the Slip Knot called Codons..  
 DNA-Grids

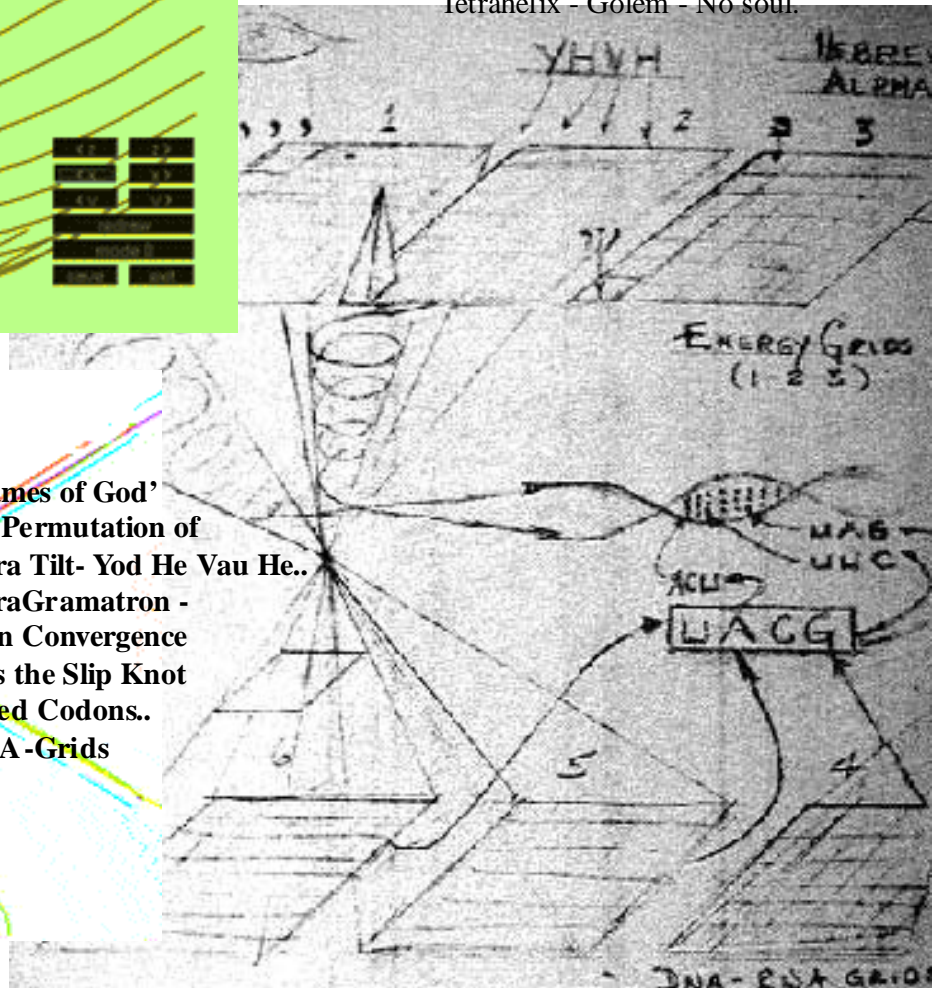

The next couple pages offer the academic detail - on TOROIDAL - or RING - or CIRCULAR - DNA (for those who wish to study this geometry of genetics further)

## 7 Color Moebius

### Torus

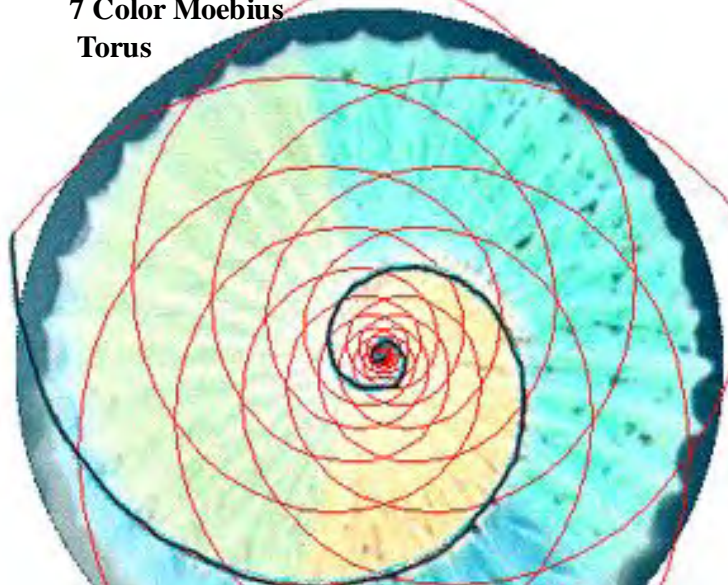

**Above Here- How the Spiral Compresses Charge into GENES by Getting the ANGLE RIGHT.. This is a TOP DOWN VIEW OF DNA & the Spiral on Donut which made Alphabets.**

#### Supercoiling DNA

exerpt from

<http://www.uovs.ac.za/faculties/nat/mkboc/biochem/Super.htm>

Supercoiling simply means coiling of a coil. Supercoiling and topology, although perhaps at first glance abstract mathematical concepts, have very relevant application in molecular biology. The DNA molecule is subject to topological constraints, and these have very real effects on the function of DNA. Negative supercoiling can stabilise secondary DNA structures such as hairpin loops, cruciforms, and also facilitate the formation of a melted region in the transition of a transcriptional pre-initiation complex (PIC) to a elongating complex. Also, the DNA in both pro- and eukaryotes are naturally negatively supercoiled. In prokaryotes this is due to the action of gyrases (these are enzymes like topoisomerases, but induce supercoiling in an ATP-dependent manner). In eukaryotes, the packaging of DNA into chromatin causes the DNA template (after removal of proteins) to be supercoiled. In addition, the passage of the RNA polymerase along the DNA molecule generates a twin supercoiled domain. The region behind the polymerase is negatively supercoiled, and the region in front of the polymerase is positively supercoiled. This superhelical stress is normally relaxed by topoisomerases. In yeast, there are two types: topoisomerase I (topo I) and topoisomerase II (topo II). Topo I induces a single strand nick, and will relax the DNA molecule in units of 1. Topo II, predictably, cuts both strands, and changes the superhelicity by units of 2. These enzymes appear to be required for normal DNA function, and are involved in the relaxing of superhelical stress that accumulates during transcription and replication of DNA. Thus, it is clear that an understanding of many of the processes that can influence DNA function, requires some understanding of supercoiling.

#### Classic Linking Theory (CLT).

The essential concept that is used in a theoretical study of supercoiling is the ribbon. The ribbon has two sides (which can represent the phosphodiester backbones of the DNA duplex), and it has an axis, equidistant from the ribbon edges, equivalent to the helix axis. There are three parameters that are important when considering supercoiling: the linking number (Lk), the twist (Tw) and the wryste (Wr). The Lk and Tw is a function of the edge of the ribbon, and has no meaning for a one-dimensional line, such as an axis. The Wr, on the other hand, is a function of the ribbon (or helix) axis, and describes the shape of the axis in space.

#### #DNA is NOT a "Double Helix" #

#By Ken Biegeleisen#, New York, N.Y.

Readers of the Dan Winter web site are accustomed to various speculations about the physical, mathematical and spiritual significance of the world-famous Watson-Crick "double-helix" structure of DNA, and it is therefore with some trepidation that I "rain on the parade", by showing why the double-helical structure-pretty picture that it is-is nevertheless probably not #the structure of DNA in any living organism.#

The primary "business" of DNA is replication. DNA carries the "codes" for the structural proteins and enzymes which give an organism its characteristics, and these codes must be passed from generation to generation.

What exactly gets passed? The codes consist of sequences of nitrogenous bases: adenine, thymine, cytosine and guanine, usually just abbreviated A#, #T#, #C#, and #G. These 4 "letters" are the "alphabet" of genetics, much akin to the binary code which lies at the root of all computer language. Just as a computer ultimately "spells" every program with just two numbers ("0" and "1"), likewise, the code for every structural protein and gene in the human body is "spelled" with an alphabet of only 4 bases in various combinations: #A#, #T#, #C#, and #G#.#

A "gene" is therefore a linear string of bases, like a string of pearls. The bases are held together by a backbone made of sugar and phosphate. In order for the cell to execute the so-called "genetic code", it employs an extraordinary system which reads the strings of bases, and converts the information into corresponding strings of amino acids, which are the building blocks of protein. The fact that a string of bases in DNA codes for a corresponding string of amino acids in protein is sometimes called the "Central Dogma of Molecular Biology" (G-d help us! -- Is this really #what we need in the post-Copemican world?).#

So much for the genetics. The manner in which the bases are organized on the sugar-phosphate backbone was deduced by Watson & Crick in 1953, and, regardless of what modifications are made to their structure, this deduction will remain as one of the towering milestones in the history of science, as long as science is practiced in the world.

The manner in which the entire DNA molecule is organized, however, is another question altogether. It makes no difference to genetics whether DNA is a right-handed helix, a left-handed helix, or not-a-helix at all. Genetics simply requires that there be a string of bases, the "alphabet" if you will. Whether the sugar-phosphate backbone to which the bases are attached is twisted or not is totally irrelevant.

If this is the case, why then do scientists think that DNA is twisted?

The original structural studies of DNA were done by Maurice Wilkins, who shared the Nobel Prize with Watson & Crick (Rosalind Franklin, who actually did most of the work attributed to Wilkins, was neglected, and is now a major historical figure in the fight for women's equality). Wilkins and Franklin

did what's called "x-ray crystallography". This means they took pure DNA and turned it into crystals, then took x-ray pictures of the crystals.

To make crystals, totally pure DNA is required. DNA solutions are gooey, and when a glass rod is dipped into DNA and raised up in the air, the sticky liquid is drawn into a thin thread. If the thread is drawn thin enough, it will dry out and crystallize, and a picture of the crystal can be taken with x-rays. The picture looks sort of like a snowflake. Within this very intriguing geometric pattern lies hidden information about the structure of the crystal. This information must be pulled out by mathematics. The formulae involved are difficult in the extreme, and in the old days, people who actually did the math (called "**Fourier Transformation**") were held somewhat in awe by other scientists. Nowadays, however, all the mathematical "leg work" is done by computers, and the process has been largely de-mystified.

The picture of DNA which emerged from the Wilkins x-ray studies was the double-helix, and very few people, including disagreeable people like myself, have ever had any reason to doubt that the structure of DNA in artificial crystals is a right-handed double-helix. But is that the structure of DNA in cells? Who can say?

Humans, insofar as our cell type is concerned, are eukaryotes, meaning that our cells are of the type referred to as "higher cells". The "lower cells" are called prokaryotes, and include, for example, bacteria.

Now, humans are not the only eukaryotes. All "higher life forms", both animal and vegetable, are eukaryotes. This means all plants, even including some unicellular plants such as mold and yeast, and all animals, even including some unicellular life forms such as paramecium or amoeba.

It is a known fact that the DNA of all eukaryotic cells is invariably bound to proteins, called histones. Here's an interesting fact for you to contemplate: The histones are exactly the same in all "higher" life forms. That means that the histones of human cells are the same as the histones of the pea plant and the amoeba. Doesn't this mean that histones are critically involved in chromosome structure? Of course it does. There's no such thing as "pure" DNA in cells! In the real world, in life, all DNA is bound to protein. There are no exceptions to this rule.

The structure of pure DNA is said to be known down to the angstrom level, and if you don't know what an angstrom is, let me tell you that it's very, very small. In other words, the structure of DNA is known down to the minutest detail.

Also, the amino acid sequences of the histones are long-since determined.

But the structure of the DNA-histone complex, called chromatin, is not known. Does this strike you as odd? It certainly strikes me as odd. After all these years, with all the importance attached to gene engineering, even after completion of the "Genome Project", the structure of human chromatin remains unknown? Incredible!

Might it be that the histones simply can't be made to fit on a "double-helix" because the "double-helix" is not the structure of DNA in cells?

### #Twisted DNA in Replicating Cells: What's Wrong With This Picture?#

As we started to say above, the primary "business" of DNA is replication. In E.coli, a common bacterium, the replication cycle can be as short as 20 minutes. This is called the "log phase" of growth, because the number of bacteria in the culture doubles every 20 minutes, giving rise to a logarithmic increase in the bacterial count.

In the log phase, the daughter cells actually begin to split into two before they have finished separating from one another! Now, that's fast!

In 1963, an Australian researcher named John Cairns took a picture of the E. coli chromosome which found its way into every textbook of that period. The picture was called an "autoradiograph", meaning that E. coli bacteria were grown on a radioactive medium, and the cells were killed and split open over a photographic plate.

That plate was put in a dark room for a few months, at the end of which the tiny quantity of radiation in the chromosomes gave rise to pictures. These pictures were examined under the electron microscope.

What was the structure of the E. coli chromosome which was revealed by these autoradiographs? It was circular. Subsequent to Cairns' great discovery, it was found that nearly all the DNA which can be isolated as a single intact chromosome is also circular. This includes all bacterial DNA which has been examined, all plasmid DNA from within eukaryotic cells, and most viral DNA.

Hmmm... that's interesting. How does a circular chromosome replicate? The two strands of a circular double-helix are LOCKED TOGETHER. If you can't imagine that clearly, I'll show you a picture:

<-

Figure A# above shows a "classic" right-handed circular double-helix (B shows a "superhelix", which we won't have time to discuss just now). If you can't clearly envision the linkage (called "topological linkage")



A



B

between the two strands in Figure A, then please think of the links of a chain. Are the links of a chain locked together? Of course they are.

How is a chain made? You can make a short 2-link chain as follows: First you take a metal rod, and close it in a circle. Then you take a second rod, pass it through the circle, wrap it around once, and close it into a second circle. Are the two links of this chain locked together? Most assuredly.

To make DNA you take one single-stranded circle of DNA, pass a straight rod of DNA through it, and wrap it around, not once but thousands of times, then seal it shut. Are the two strands locked together? You'd best believe they are. See again Figure A above.

So, if the business of DNA is replication, and if the strands must separate at replication time, and if they are indeed locked together, then how do they separate when the cell divides? Good question!

Shortly after Cairns' great discovery of circular DNA, a major DNA structural symposium was held at Cold Spring Harbor, the "Mecca" of molecular biology. The subject of DNA replication, in the light of the recent discovery of circular DNA, was indeed featured. How prominently was it featured? Not very prominently. It was briefly mentioned in one paper, and largely glossed over.

**According to the scientists at the Cold Spring Harbor Symposium, how did the strands of DNA get apart during replication? The answer they gave was a "swivel". What's a "swivel"? It's a hypothetical point, somewhat comparable to an automobile universal joint, around which the strands of DNA can untwist and re-twist during the process of unwinding of all those thousands of twists, and the re-winding of the twists back in the next generation.**

**The swivel was thought of as an enzyme which inserted itself into the chromosome, breaking it open, and "holding on" to the DNA strands as they whirled about, trying to unwind.**

**What's wrong with this picture? First of all, there was no "swivel" known! It was just a guess. What about the possibility that the hypothetical "swivel" was not needed, because DNA did not have the Watson-Crick structure in living systems, but rather some alternative un-twisted structure whose strands were free to separate at will? That possibility was not even mentioned. It had evidently been determined that, even at that early date, the "double-helix" was a "sacred cow", and could not be criticized. Therefore (or so the false logic went), since DNA had to be a double-helix, and since the strands had to separate during replication, there must have been a "swivel".**

What had actually happened is quite clear in retrospect. Copernicus reduced man's arrogance by removing us from the center of the universe, and placing us in a measly little planet which revolved around one of billions of stars. The "double-helix", however, put us back, squarely in the center of the universe, since we would now "create life", and become "gods". What nonsense!

But the idea was compelling to many. It was compelling enough that, for the last 40 years, almost everyone who has criticized the "double-helix" has been miserably maltreated, and rejected from the mainstream of science.

It was quickly determined, after the announcement of the mythological "swivel", that the E. coli chromosome would have to be spinning at 6,000 rpm every minute of its life if it was to unwind all those twists every 20 minutes. This is too ludicrous for words. The E. coli chromosome is something like a millimeter long when stretched out, which is an immense length of DNA to stuff into a cell so small you can't even see it without a microscope. The very idea that all this DNA is whirling like an airplane propeller at 6,000 rpm is a joke.

"No problem". The helicists simply informed us that DNA only replicates a little bit at a time, so that only one small portion of the chromosome is actually spinning at any given moment. What evidence was there that DNA replicated this way? None. It was proposed, without evidence, to save the "swivel", which itself was proposed, without evidence, to save the "double helix". This is not science.

In 1976, an Australian researcher named Gordon Rodley, fed up with the obvious shenanigans going on with DNA, published an alternative structure, which is probably the correct one. In the Rodley structure, called the "side-by-side" structure (usually just called "SBS"), the two strands of DNA lie parallel to one another, undulating a bit to the right, then

a bit to the left, but never making a whole twist. Here's a very over-simplified schematic of SBS, alongside another, less likely structure; both being examples of DNA structures in which the strands are not locked together:

#

Figure A shows a totally hypothetical DNA structure which is "topologically equivalent" to the SBS structure, but in which the entire top half of the chromosome is a right-handed helix, and the



entire bottom half is a left-handed helix. This model can be made instantly from two rubber bands by simply twisting them together. If you allow your rubber band model to "replicate", the two "strands" will separate as soon as you let go of them, because, topologically speaking, there were never really twisted together in the first place (every RH twist on top is canceled-out by a LH twist on the bottom). This structure, however, is highly unlikely to be found in nature. Figure B# shows the SBS structure, which is# very likely to be found in nature, including in your own cells. What this drawing attempts to show is that the helix twists alternately a little to the right, then the left, etc., throughout the chromosome. As in Figure A, the net number of twists is actually 0. At replication time, the strands fall apart without having to untwist, because, topologically speaking, there really weren't any twists in the first place.

Rodley's structure (Figure B above) was published in the Proceedings of the National Academy of Science, one of the world's most rigorously peer-reviewed journals. How this got past the editors I'll never know, since Rodley remains, to this day, the only author whose work in this needlessly-controversial area has been accepted without a fight.

In 1978, Prof. Robert Chambers, the chairman of the biochemistry department at New York University School of Medicine, discovered by accident that the separated single-strands of the circular chromosome of the virus "phiX174" can spontaneously re-combine to give normal double-stranded circular DNA. This would be impossible if normal double-stranded circular DNA was a helix, because that would have required something like this:



# In this drawing, a single-stranded circle is depicted as (1) being broken open, (2) wrapping itself around an intact circle, and (3) sealing itself shut again. The breaking open in step (1) is not a problem, because DNA can certainly break. The wrapping around the other strand in step (2) is not a problem because DNA is known to do that. But the sealing of the broken strand shut in step (3) is a BIG#

problem, because that requires a sealing enzyme, and no such enzyme was present in Prof. Chambers' single-stranded circular DNA preparation.#

**Is there another way to explain this data? Of course, but you have to be willing to believe that DNA is not a helix. It goes like this:**



# Here, the two circles are being shown simply coming together to form un-twisted double-stranded DNA. (Actually, it would be slightly twisted, but only as per the SBS structure two figures above this one).

Why has this simple concept been resisted so strongly? Because it was also discovered, not long after the discovery of circular DNA itself, that the two strands of circular DNA, when "melted", do not separate, which they ought to do if they are not locked together.

"Melting" doesn't mean literal melting, as when you heat butter in a frying pan. It means subjecting the DNA to conditions which promote strand separation. The first "melting" experiments were on fragmented linear DNA, and the procedure employed was simple boiling. At the temperature of boiling water, the double-stranded structure broke down, releasing single-stranded linear DNA. If the solutions were cooled slowly, the double-stranded form would, however, re-appear.

On the other hand, when circular# DNA is boiled the strands #do not separate. Moreover, at pH 13 (very, alkaline, like lye), where normal double-stranded DNA structure is impossible to maintain, the strands of circular DNA still do not separate! What's wrong?

I began working on this problem in the early 1970's. It took me years to solve the whole puzzle. In 1974 I submitted my first theoretical article on the subject to the Journal of Molecular Biology, which rudely rejected it. It took 28 years to get this article into a peer-reviewed scientific journal, but it was finally published a few months ago, in the Bulletin of Mathematical Biology (Biegeleisen, K. Topologically Non-linked Circular Duplex DNA, #Bull Math Biol 64#:589-609, May 2002).

The content of the article is a bit too long and drawn-out for the present discussion. Suffice it to say that the explanation for the well-documented fact that the strands of circular DNA do not separate under "melting" conditions is that the circularization of the DNA imparts novel and unexpected topological properties to the chromosome; #properties which cause it to behave markedly differently from linear DNA under the same circumstances.#

In particular, at high pH, where the single-strands of linear DNA fall apart, the single strands of circular DNA remain associated in a new, multi-strand, alkali-stable complex. The structure for this complex is similar to the structure originally proposed for all DNA by Linus Pauling, just months before the famous paper by Watson & Crick hit the press. Pauling, in his day, was considered to be the world's greatest living authority on the chemical bond, and the odds-makers had picked him to win the "race" to determine the structure of DNA. He considered a triple or quadruple helix with the phosphate groups pointing inward to be the most logical structure for DNA, based on the chemistry only (i.e., #without reference to genetically-specific base-pairing, which had not yet been discovered).#

When Watson & Crick published the "double helix", it looked as if Pauling had "lost the race". Now, however, almost exactly 50 years later, we can see that maybe he didn't lost it entirely.

If circular duplex DNA really has the SBS structure, or one similar to it, then it ought to be possible to separate the component single-stranded circles, without breaking either one open. This was not accomplished for many years. **Proof that the strands of circular DNA can indeed be separated was finally published** in 1996, by a brilliant researcher named Tai Te Wu, with the help of his son (Wu R. and T.T. Wu, 1996. A novel intact circular dsDNA supercoil. Bull Math Biol, 58#(6):1171-1185).#

Wu's innovation was to isolate double-stranded chromosomal DNA from a plasmid under conditions where a great deal of a substance called "RNA" was bound to only one of the two strands of the DNA chromosome. The bound RNA changed the physical characteristics of the strand it was bound to, so that Wu was able to separate the two chromosomal strands by prolonged gel electrophoresis (a procedure in which DNA's of different physical characteristics can be separated into distinct bands in a jello-like substance to which an electric current has been applied). Wu repeated the work with a second plasmid which had the two strands marked by the intentional insertion of marker sequences by genetic engineering, and proved, unequivocally, that the two bands in the gel were indeed the two single-strands of the original plasmid chromosome, respectively.

**The conclusion is that DNA is not a helix, and it's really been apparent all along to many people. The failure of the two strands of circular DNA to separate under "melting" conditions made it possible for the scientific community to evade this obvious conclusion for many years, but the days of the "double-helix" as the presumed structure of DNA in living system are, in all probability, numbered.**

**Topologically non-linked DNA** , Ken Biegeleisen, M.D., Ph.D. NY - Email: [biegel@VeinDoctorNY.com](mailto:biegel@VeinDoctorNY.com)

#### Abstract

**The discovery of circular DNA, over 30 years ago, introduced an element of uneasiness in what had been, up to that point, the almost picture-perfect story of the elucidation of the molecular biology of heredity. If DNA indeed has the Watson-Crick right-handed helical secondary structure, then in circular DNA, thousands, or perhaps even millions of twists must be removed in each generation, and re-wound in the next generation.**

Although enzyme systems adequate for this task have long since been found and characterized, there have nevertheless arisen a number of proposals for alternative DNA structures in which the strands are topologically non-linked, so that they might separate during replication without having to be unwound. These structures have generally been put forth as theory only, and have been largely unaccompanied by experimental evidence to support their applicability to native DNA from living systems.

Recently, however, a report has emerged suggesting that it might be possible to separate, intact, the individual single-stranded circular half-chromosomes which constitute the double-stranded circular chromosomes of certain plasmids. This would not be possible unless the chromosomes had one of the alternative, topologically non-linked structures.

It is widely believed that after a half-century of worldwide DNA research, any significant change to the Watson-Crick structure is unlikely to stand up to scrutiny. Nevertheless, the present author has found that in many instances in which the behavior of circular duplex DNA is considered to be explicable only in terms of the topologically-linked helical model, it is also possible to explain that same behavior in terms of a topologically non-linked model. It is necessary, in these instances, to make certain logical assumptions which cannot be conclusively proven at the present time.

The author herein offers an example of one such instance, namely an examination of the behavior of circular duplex DNA in an alkaline titration experiment, where conformational changes in DNA are deduced from changes in its buoyant density at pH's between 7 and 14. These data have been explained in terms of topological linkage between the DNA strands, but they can also be explained without invoking any such topological linkage, provided that the above-mentioned logical assumptions can be accepted.

The principles which emerge from this are applicable to other settings in which knowledge of the topology of DNA is critical to the understanding of observed phenomena. *End of Ken Biegeleisen Paper on Circular DNA*

*Next see how YOU create the Charge Forces in Bliss -- to roll up your DNA into ... implosion.. and radiance...*

**--- Shaping DNA - into RADIANCE  
- that is the ROLE OF BLISS:**

18.. **UNDERSTANDING BLISS / ECSTASY and EUPHORIA** in musical / in wave / and in immune system maintenance terms.

a.) **SCIENCE OF BLISS** - Measured Musically - in Brain Waves and Heart Waves - Ref: [../brainphire Golden Ratio Harmonics in BrainWaves as Mechanism of Euphoria / Active Visualization / Bliss?](#), Sweet Ecstasy-On the Natural Biological "Sweetness" of the Ecstatic Process, & How to Achieve it  
Measurement: HeartTuner [heartcoherence.com](#) , Hygiene: section follows.

b.) **BLISS** and the redemption of the IMMUNE System - Practical Emotional solutions to CANCER vs. AIDS ;  
Ref: Is Embedding a Mathematical Opposite to Cancer as Wave Fractionation ( [soulinvitation.com/cancer](#) )

c.) Science of BLISS becomes the SCIENCE TO END ADDICTION AND ATTENTION DEFICIT- Ref: [../TRANCEanDANCE-Biofeedback Harmonics as Bliss Making Solutions to Addiction and Attention Deficit](#)  
- much of the discussion on this below - is excerpted from [soulinvitation.com/rainbowserpent](#)  
Magazine Article at the link: **POLITICS OF BLISS.**

***The Great Grail -The Cup of Bliss- Kundalini and the deep biology of the 'BLISS' process:***

*If you looked deeply into bliss DNA (even semen) at the way the braid gets spin dense.. it would look like a fleece whose weaving was GOLDEN (ratio envelope to carrier etc.. )*

*Bliss is stabilized as charge is compressed to the point of self-organization acceleration - implosion. That problem in symmetry has a MUSICAL RECIPE - see the film - **Chain Reaction***

*(Keanu Reeves) - where a musical sequence inspires the field hydrodynamics to get run-away fusion going.*

*That musical recipe - measureable when any oscillator (like the EKG or the stock market) embeds into PHI harmonics - is a SYMMETRY SOLUTION ... called: **The Holy Grail..***

*which is the ultimate shape of the dimpling donut braiding in DNA - when the heart makes that music ( [heartcoherence.com](#) )*

Our prelude to understanding  
self-empowering bliss process..  
is a Grail Quest!

The 'Fundamental Dynamic / Symmetry Essence  
is InPhiKnit-ly SHAREABLE

- ( Fractal - U B Quite Us)

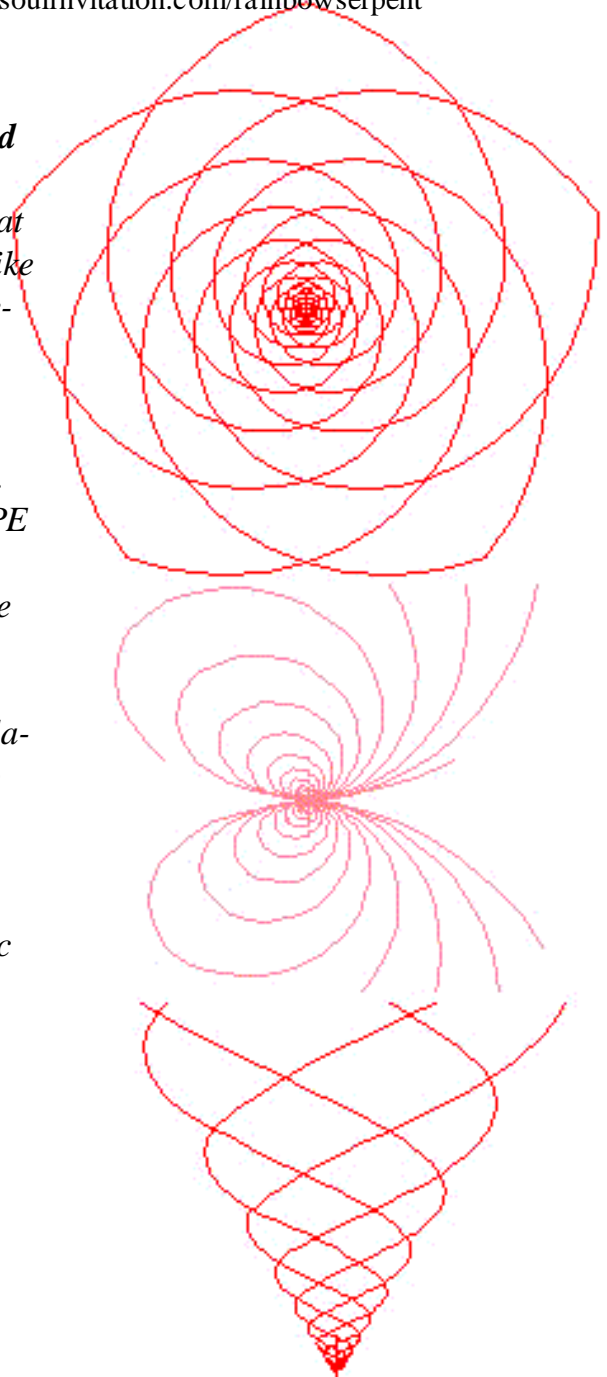



**History of the GREAT GRAIL- - it IS a cup**

- It is a 'golden' fleece
- It is in the blood (perfect dna braid)

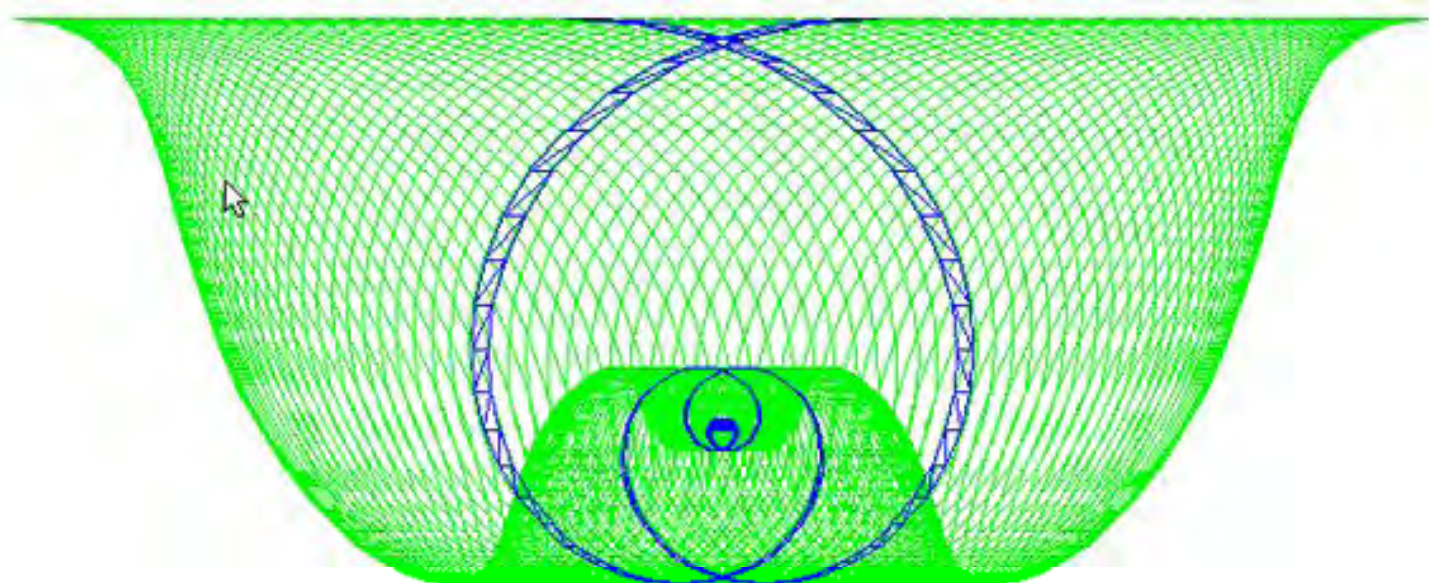

- It DOES result from pure intention.. ELECTRICALLY & EMOTIONALLY THE SHAREABLE WAVE  
 - It IS a siege perilous, and it is a tower or amygdala or djed or atlatal or sword of destiny: how the magnetic vector emerges non-destructively from rotation to propagation.. circle to line.. matter to energy .. sword from stone. Those who need secrets - cannot share perfectly (distribute COHERENTLY as wave) do not survive.

--

Golden Mean Spiral, perfect embedding wave shape of all Phyllotaxies, perfect branching, in 3D on the conic into concentric Dodeca pents within pents... and rotate revolve it to see the actual GRAIL! map to perfect embedding, compression, & compassion - as in DNA, Earth Grid & Zodiac .

This pattern of the electricity around the heart in 3D is GRAIL embedding-, when we learn the skill of choosing COMPASSION / compression - to become fractal/ to embed / to love - 1o phi..

This is the spin path which light will see when it enters the dodeca DNA, when that DNA helix has been optimally braided into perfect nesting, by LOVE

(a "spin path to zero point")

the cup contains an inPHIknit amount of spin,  
 it never runs over,

it has no inside or outside,

it solves the problem of separateness..

it is the san graal, because it is the song in the blood,  
 because your ears ring with the magnetism of the land when the arc of your torus and the land are.. one..

you can see in the cup, the feminine organs of reproduction...  
 egg more fractal than seed..

the sufi heart with wings..

and you can zoom in forever and always see the same thing

the heart of the matter.

This In-PHI-knitly constructive MAGNETIC WAVE INTER-  
 FERENCE perfectly describes at once the PRINCIPLE of:

perfect spin density,  
 perfect information density,

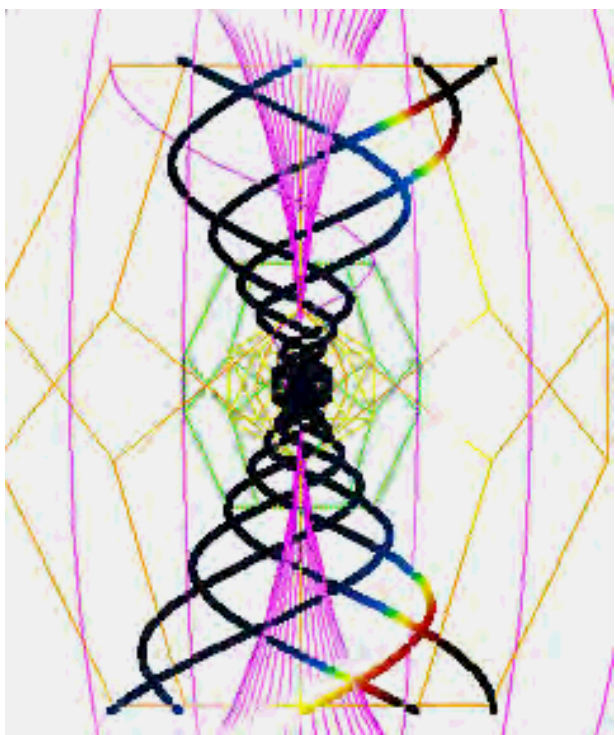

perfect recursion,  
 perfect embedding,  
 perfect implosion,  
 perfect gravity ( $G=C*\Phi^!$ ),  
 perfect data compression,  
 perfect connectivity,  
 perfect symmetry,  
 perfect damping,  
 the perfect way to turn inside out (Labyrinth),  
 perfect phase conjugation,  
 the perfect magnetic monopole,  
 the perfect scalar wave,  
 the perfect "singularity",  
 the perfect geometry of inflation, (Andrei Linde)  
 the perfect superstring connector (black hole),  
 the perfect geometry of bubble expansion,  
 the perfect (& only way) a wave can re-enter itself non-destructively (self re-entry),  
 the perfect Phyllotaxies (maximum exposure/minimum superposition),  
 the perfect balance between equilibria/ between liquid/crystal,  
 the perfect way to SORT anything (magnetic, liquid or gaseous),  
 the perfect way to SCALE anything,  
 the perfect way to SYMBOLIZE (or embed) anything  
 the perfect way to get physical ( $\Phi$ -cycle),  
 the perfect (and only) SELF ORGANIZING PATH OUT OF CHAOS,  
 the perfect (and only) SPIN PATH TO THE ZERO POINT,  
 the perfect self-awareness,  
 the perfect pining,  
 the perfect intent,  
 the perfect time wormhole (antennae geometry),  
 the perfect HeartBeat harmonic signature for disease resistance (Irving Dardik, MD "Cycles Magazine"),  
 the perfect Brainwave harmonic signature eliminating addiction & attention deficit (Wuttke Clinic),  
 the perfect Planet Schumann harmonic signature eliminating climate chaos & atmosphere loss,  
 the perfect DNA braid to make "soul".(spin memory to survive death),  
 the perfect sharing,  
 the perfect compassion and love,  
 the perfect fractal,  
 and...  
 the perfect grail

(links to references for above principles - [soulinvitation.com/grail.html](http://soulinvitation.com/grail.html) )



Condensed extract  
from an article by  
Dan Winter, the  
co-developer of the  
Heart Tuner.

### THE CUP OF BLISS:

# The Politics of Bliss

Bliss is threatening to a culture because it is inherently addicting and contagious. Like atomic reactions, Bliss has a critical mass for groups. Whatever or, more particularly, whoever is perceived as the major source of Bliss activity will tend to be worshipped (often as a guru) or loved. This may result in the formation of a cult that is permissive and whose members behave in ways that appear "irrational" to the rest of the community.



Frontispiece from  
"Politics of Bliss"

Article about Dan Winter's work  
in *Conscious Living*  
*Magazine*, Perth  
[conscious-living.com.au](http://conscious-living.com.au)  
With other articles  
- as part of the Review of  
*Bliss Dynamics*  
for Young People at:  
[soulinvitation.com/rainbowserpent](http://soulinvitation.com/rainbowserpent)

## Understanding the **FACES OF BLISS / EUPHORIA / ENLIGHTENMENT.**

**Integrating the new scientific understanding of what bliss and peak experience is - into a revolution in the way we teach RAVE MUSIC and ADDENTION DEFICIT Neurofeedback .. Peak**

**The musical recipe for bliss / and peak experience are well documented,**

**They are exactly based on Golden Mean ratios in harmonics because this produces compression / acceleration / fusion. - the ESSENCE of attention.**

**Using this information can revolutionize the way feedback and hygiene can teach self-empowering end to Addiction - Attention Deficit Disorder - and BLISS PROCESS in general!**

**The HeartTuner system is correctly designed to measure and make this teachable.**

. Ref 1. Brainwave EEG nest in Golden Ratio during bliss / euphoria in Russian study., see - [soulinvitation.com/brainphire](http://soulinvitation.com/brainphire) Dr. Korotkov (famous for Gas Discharge Visualization Work, St.Petersburg, Russia - now is using HeartTuner systems) replicated EUPHORIA and BLISS conditions in the laboratory and consistently measured the **RATIO BETWEEN BRAINWAVE HARMONICS (hz) to be .61 +- 10%, literally Golden Mean Ratio.** This is exciting new evidence that non-destructive **CASCADING TOWARD CHARGE COLLAPSE** (attracting charge) **IS INDEED THE MECHANISM OF PEAK EXPERIENCE / PEAK LEARNING / BLISS!**

Ref 2. Former lead researcher for Monroe Insitute - Dr. Ed Wilson - showed that by feeding audio harmonics in Fibonacci cascades (1,2,3,5,8,13,21..) **LEADING TO GOLDEN MEAN RATIO** - interfering between opposite ears in headphones - he **CONSISTENTLY GENERATED 'TRANSCENDANCE'** in Brainwaves (32 channel EEG Lexicor mapping). Phi cascades made brainwave transcendence when the region of extreme brain **COHERENCE** was as the top center of the head. The **OPPOSITE - Brainwave DISSOCIATION** occurred when he fed interfering **OCTAVE** sound ratios between the same headphone ears. Dissociation was the area of coherence being opposite sides of the head (around each opposite ear).. instead of top centering.

Ref. 3. The Geometry of Pressure in Your **TOUCH** - Predicts the Harmonics of **EMOTION IN MUSIC- & LOVE.** The change in pressure over time in the **TOUCH WAVE** that says love - peaks at **.61 GOLDEN RATIO** into the duration of the touch or squeeze or embrace. Dan's analysis of the Sentic wave for love. (previous chapter).

Ref. 4. The musical key signature of the Heart EKG can be taught to **EMBED** - and **BLISSFULLY** attract **LIFE FORCE GIVING CHARGE** -- with a simple musical feedback environment: HeartTuner. In many thousands of tests- the EKG Heart musical frequency fundamental measured during states of **OPEN-ness, EMPATHY, COMPASSION, or LOVE** were invariably most stable at **.62 (Golden Ratio).** [heartcoherence.com](http://heartcoherence.com) [soulinvitation.com/embedability](http://soulinvitation.com/embedability)

Not only does this make bliss / euphoria and peak experience teachable as a science, but it reveals the powerful and gravity making nature of biological implosion as perfect compression - directly from the music of the heart. (pics below). (Links to implosion science in the alchemy article - bottom of [heartcoherence.com/tunernews3](http://heartcoherence.com/tunernews3) )

## "Musical Recipes for Bliss and Euphoria - Can Ecstatic Dance Be Self Empowered?"

Dan Winter's offering for young people at Rave events -

### Self -Empowering BLISS / Euphoria Without Drugs

- Presentation at RainbowSerpent Festival for 5000 young people, 3 magazine articles at link..  
[soulinvitation.com/rainbowserpent](http://soulinvitation.com/rainbowserpent)

"Musical harmonics of the ECG (Heart Voltage) measured - showing that the heart's actual music can be used to make fire in the heart - visible ( Coherence). Plus with 2 connected - the link up to the same 'wavelength' of 2 hearts is visible - making empathy, compassion, tantra and even conflict resolution measureable. Dan's multi-media show then evidences that bliss and euphoria are how we get an immune system, lucid dream, and even survive death. He suggests that the music of rave and bliss dance - can be tuned accurately to facilitate making transcendent states reachable in self-empowering ways without drugs. This not only revolutionizes biofeedback eliminating Addiction and Attention Deficit - it creates a whole new definition of life force and what DNA and governments are for. The coherent song of bliss becomes the electrical pattern to teach biological peak experience AND sustainability. It is all based on something Dan calls 'harmonic inclusiveness - measured capacitively in charge density'. It is a musical recipe for getting immortal - and it is based on fractal compression - in your heart - and your heart's music."

### ROCK & RAVE: Ecstasy with Purpose?

Bio-feedback and sound can replace the key missing brain wave harmonics to complete the cascade (EEG) which we now know to be the definition of BLISS and thus replace external drug addictive with self-empowerment.

We can use accurate sound harmonics WITH sacred geometry AND biofeedback, to create a SELF EMPOWERING ecstatic and bliss environment, in which there would be no urge or need for drugs.

**The great drive to achieve some kind of peak experience in music and movement, among the young at heart, can now be admired from a new and biological perspective. As the chemistry of ecstasy has come to be understood as more and more of a symphony among glandular conductors, we are understanding better the role of music in waveguiding emotional states.**

Biological terms for music rolling deliciously between the glands at ecstatic moment, may sound something like phonon waves phase locking between glandular foci among liquid crystal piezoelectric muscle/nerve and bone plexi. The point is that we can understand what it is informationally that we seek as a kind of "cellular" phone call home for ET, at the



moment of ecstasy... that entrained, rapturous, sometimes even tearful and tasting something **sweet dripping like nectar squeeze from the upper brain onto the back of the tongue. Ecstasy is a well described phenomenon in the spiritual literature.**

**It is usually accompanied by some sort of ritual that guides attention into greater presence,** something which we now would describe as the ability of the spine to phase lock and entrain coherently field effects nested concentrically to greater and greater size/ wave length/ and context. The entrance into the geometries of symmetry which we have called ritual dance, corresponds nicely to the phase geometry we have known as rhythm and music which phase entrains the body, solar-plexus on up. Symmetry among wave forms attracts the inertia we call attention, and the corresponding expanded presence of mind. What we have been labeling presence here in the mindful sense, is specifically the ability of the now more field effect nested body to entrain/ extract information CONTEXT from waves which nest/cascade at ecstasy all the way to planetary size. Which is just to say, riding the long wave for the emotion seeker is to get the necessary context/ "where does the small fit into the large" kind of information from our electrical noosphere.

The mechanic which enables electrical and sonic fields to reach between scales, is the classic problem which musical wave geometry as beauty in ratio solves. When we look at our models for the shape of what precipitates electrically around the heart we get the geometric keys to emotion which are musical ratios. Looking at the above spectrum analysis of the heart's ekg during peak emotion .....the harmonics in the contents of the heart phase lock into musical whole number ratio, thus creating a wave length matrix for the embedding of field effects ..

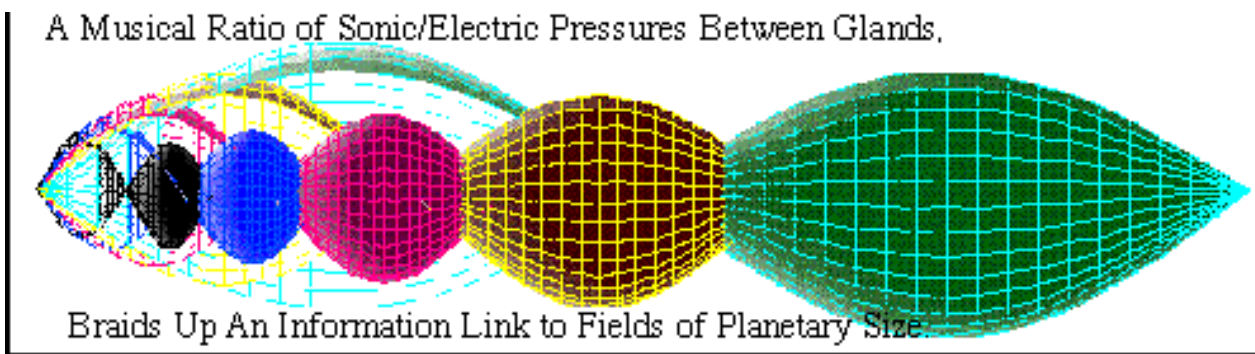

The shape of these field effect nested by the heart and its electrical entrainment of the whole body, are established by the musical chord like geometry of the wave-length tinkertoys, the heart braids at peak emotion. To put it simply, **permission to touch among field effects, between bodies the size of people, and whole groups of people dancing together, and ultimately whole bioregions, OCCURS WHEN SACRED RATIO BECOMES PHASE COHERENT IN A FRACTAL SYMMETRY OF SELF EMBEDDED SPACE AS WELL AS TIME.**

When we combine this understanding of the inherently musical geometry of ecstatic process in the body, to what we now know of the archetype of wave shapes which produce emotion (from the sentics literature). We find that just the whole number ratios which nest geometries among waves, are produced as a wave cracking down a whip, by the wave shape you create in music or art OR touch to send emotion!

Then if we grok what it means now that we have measured the effect of the heart/body going into electrical coherence, ONTO THE FIELD EFFECT OF A TREE 200 FEET AWAY!..... We see that indeed, linking our motion and our music from heartbeat to breath to wave lengths of a planetary nature, can actually informationally entrain us to sentient bodies the size of Earth. ( [soulinvitation.com/biophoton](http://soulinvitation.com/biophoton) )

We utilize the tendency to naturally phase entrain known coherent heart sonics when nested in music. We carefully arrange the words of the song so that the breath timing is a whole number envelope around the heart rhythm. Finally we entrain in the audio, actually sonics of the electrical heartbeat of earth. This last concept requires a bit of explanation. For a long time we have known the varying charge between plates of sensitive tuned capacitors will vary over time, in a way which is dramatically linked to astronomical

**The Heart's Sound  
Harmonics  
During Bliss  
Can Be  
Re-Created  
Musically  
-  
Facilitating  
REAL  
Self-Empowering  
"ECSTASY"  
Without  
Drugs !**

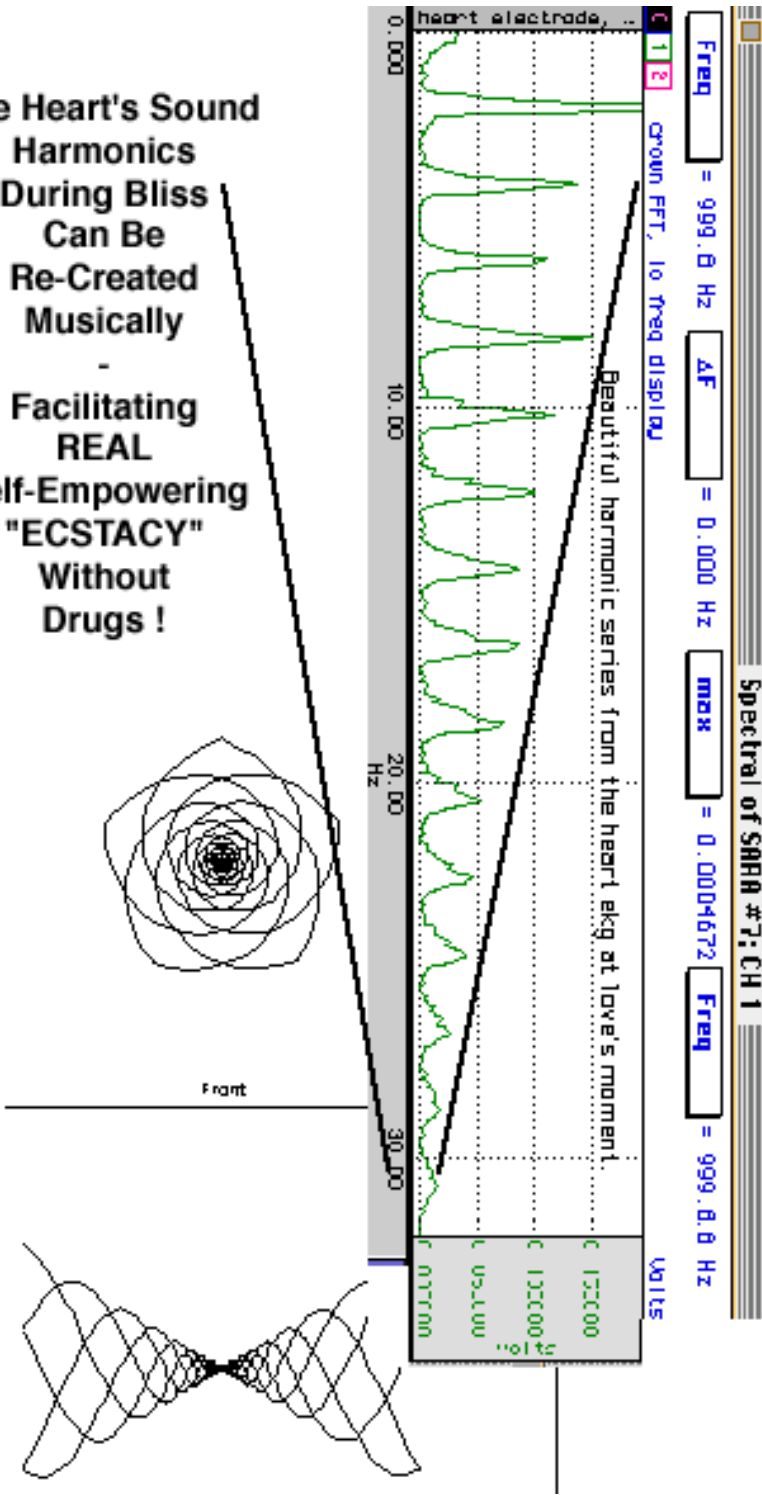

alignments. The Earth's gravity bloodstream is at one level specifically a capacitive bell. Bill Ramsey has been making dramatically emotional audio recordings of these fields induced by the Earth herself, at key astrological moments for the Earth. The presence of sounds just like the whales in these recordings is too distinct to ignore.

**In summary, the concept of a harmonic module induced by coherent audio feedback cues among groups, can now be brought to a new level. The music of the EKG of the heart becomes a sonic laser at love's moment. The wave ratio musical language of emotion is known in sentics. The breath, and Schumann Earth's magnetic heartbeat can be entrained in music to a complete chord, cascading our awarenesses into the pressure nest of Mother Earth's own feeling body.**

[soulinvitation.com/module](http://soulinvitation.com/module)  
[soulinvitation.com/corporateheart](http://soulinvitation.com/corporateheart)

In just a short moment of feeling the feedback of our own collective Heartbeats, becoming coherent in response to the Earth's field, we are produce a music which intentionally does what ecstasy has always wanted. It is the ultimate linkup.

Are BLISS , PEAK EXPERIENCE , and ENLIGHTENMENT

- identical with perfected charge attraction/ compression and measureable as implosion?

Is the icy stillness of zero frequency the same information well as the white hot fire of infinite frequency..  
the point where the information uroboros  
of the continuum of frequencies eats it's tail?

Is this EKG power spectra, a heart reaching with a frequency cascade  
to decouple the information inertia out of the energy of the background zero point energy of the uni-  
verse?

We Propose that it is Possible and Appropriate  
to Use The Mathematics and Physics of Fractal Recursion  
in MultiMedia and Biofeedback  
to Access Exactly What Has Been Advised Spiritually:

"Every Grain of Sand & Every Leaf Contain the Same..."

"Macrocosm Reflects Microcosm..."

"As Above, So Below..."

"I Am That I Am..." "That Thou Art..."

Woven into A State of Balance By The Vedic Principles of Life..

The very word LIFE suggests Recursion..

Recursion, is elegantly taught in the fractality of the fern  
whose tree, branch, leaf, and leaf tip,  
all have exactly the same self-embedded shape.

Phylotaxis in the branching algorhythm of the plant  
or the fibres of the heart's electrification,  
teach the same "maximum exposure, minimum superposition"  
which in emotional terms mean exactly:

"Contact Inhibition or Permission to Touch"..

Neurologically this translates to mean,  
electrical pressure waves (voltage gradients)  
never destructively interfere  
and thus they avoid physiologically annihilating  
the spin information they contain.

Spin Information or pattern density when arranged in recursion specifically creates the phenomenon  
called self-awareness because fractal data is infinitely compressible  
and therefore can be distributed infinitely  
with no energy investment.

This becomes a practical physics and metaphysics  
to access the doorway to the noosphere  
or collective mind or spiritual awareness:

The Centering Force Ayurvedically Described as Balance,

The Wave Attractor Which Fractal Recursion Creates...

The Bridge Builder: A Visual Tool  
to Understand Compassion- Fractality in the Heart Wave..

for BLISS - Peak Experience!

Summary- Coherence and Recursion in Heart Brain Resonance - FACILITATED MUSICALLY makes Compassion and Self-Awareness Measureable and Teachable.

Evaluating for Coherence and Recursion in Biological Resonance to Make Feed Back designs Possible.

Biological Coherence and Recursion Apply to Powerful Clinical Practicum.

*And finally in this section - we examine some of the biological effects of the effects of EXTREME coherence / bliss process limit condition - in the human nervous system: KUNDALINI.*

**By design & by braiding, capable of so much self-similar  
implosive compression:  
DNA SQUEEZES biological magnetism  
Thru the speed of light into GRAVITY WELLS..  
Fabricating Gravity.. As the geometer of consciousness it's  
Symmetry inserts the embedding which keeps little tornadoes  
Nested inside bigger ones...**

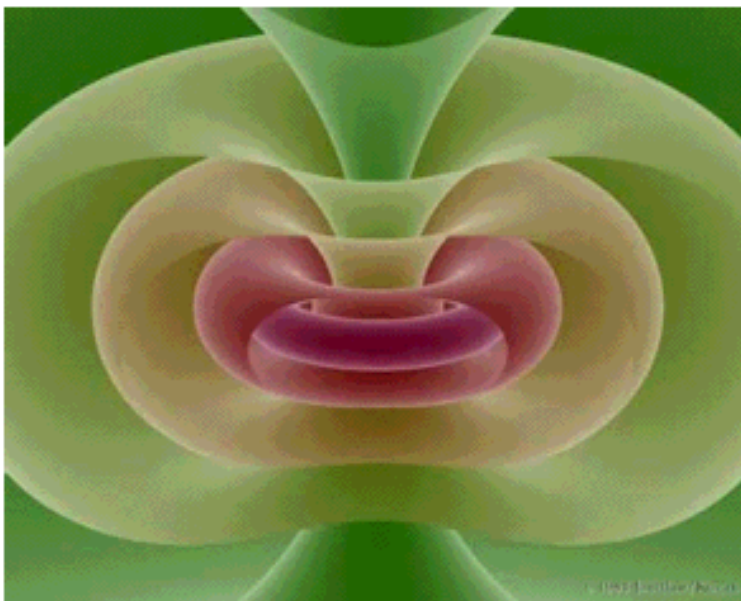

**Thus consciousness as embedding  
(self-reference) maintained  
Becomes the physics of the GLUE  
Which holds fields together.**

**Infinite Non-Destructive Compression - because of recursive adding and  
Multiplying of wavelength AND velocity - PRODUCES the acceleration  
Einstein knew is identical to gravity.**



**The Centering Force Ayurvedically Described as Balance,**

**The Wave Attractor Which Fractal Recursion Creates...**

**The Bridge Builder: A Visual Tool  
to Understand Compassion- Fractality in the Heart Wave..**

**for BLISS - Peak Experience!**

Summary- Coherence and Recursion in Heart Brain Resonance - FACILITATED MUSICALLY makes Compassion and Self-Awareness Measurable and Teachable.

Evaluating for Coherence and Recursion in Biological Resonance to Make Feed Back designs Possible.

Biological Coherence and Recursion Apply to Powerful Clinical Practicum.

*And finally in this section - we examine some of the biological effects of the effects of EXTREME coherence / bliss process limit condition - in the human nervous system:*

**KUNDALINI.** ( excerpts from [soulinvitation.com/kundalini](http://soulinvitation.com/kundalini) - from Dan Winter's material who has a lifetime of experience with Kundalini, as well as personal background with Gopi Krishna, & also Lee Sannella - MD, and Ben Bentov - the world's leading authorities on the biological basis of kundalini.)

**KUNDALINI-** can be life threatening but if it can be sustained with proper bliss hygiene it is a rapid train to electrical evolution of the nervous system - to extreme awareness and information density - and power in the environment.

**Kundalini is a rather imprecise name for the concentration of biological capacitance with UV and microwave components which flows up the spine - IGNITING AN EXPLOSION OF CHARGE NOURISHED GROWTH IN THE BRAIN CROWN - potentially triggered by numerous aspects of hygiene: notably spin dense nutrient, environment, and ability to focus (recur) align mentation. It is also limited by the state of the glandular and nervous plexi we inherit at birth. Many people simply do not have the glandular equipment for kundalini or intense bliss in this life. (George Bush like governments based on fear - can result from electing leaders whose higher cavities do not contain the equipment needed for bliss).**

*It is not tragic to be born without certain glandular equipment - because there are MANY ways the biological incarnation can be rewarding. But if you or someone you do know - is biological inclined toward kundalini like experiences - it is VERY important to know something about the plumbing and the attendant useful hygiene.*

Kundalini is measurable in microwave footprint (Dratch microwave emission scanner) and probably in UV and infrared. - As Bentov showed (Stalking the Wild Pendulum) it has measurable harmonics in the phonon (sacro cranial pump) lo frequencies - which also show up on HeartTuner. Bentov specifically showed these LO FREQUENCIES COHERING IN THE HEART were the measured mechanism 'snake charmer' for the spinal juices. When these spine juices are massaged to pump properly (Sacro Cranial PUMP) - then (Upledger showed) it is clinically unlikely to become depressed. This was the subject of Dan's extensive keynote lecture to the American Polarity Therapy Association Congress in Colorado:

[soulinvitation.com/implosionhazards/apta.html](http://soulinvitation.com/implosionhazards/apta.html)

**Dr. Stone's work on the measurably separate very LO frequencies comprising the spine pumping - parallel to the Upledger work - beautifully correlates to the EKG lo frequencies HeartTuner measures COHERING during passion / love etc.**

*This fire density, when sustained IS awareness density. How much charge can sustain recursion to one point, is the same issue - as what memories have become distributable.*

*Learning Kundalini is about the symmetry skill to sit inside and steer lightning and not get burnt.*

The white haploidal sperm genetics get a spin path up the spine juice core. Critical to opening this path includes - (organ kundabuffer) initially the ability to hold a higher than normal content of cellular UV /microwave 'tantrically' in the 'blue dish at the spine base..(pressurizing the path opening)

The actual opening is a tubelike which opens at first slowly then sometimes explosively - in the tail bone. It is related to the absorption of sweetness in the lower intestines - around the prostate in the male - up into the tailbone. It also has to do with the microwave and UV ('wave guide') absorbing/conductive vestigial 'horse hairs' of the tail bone wrapped around the prostate (in the male)

**The drastic taste of sweetness in the high brain accompanied by release of clear sticky prostatic emission out the penis MINUS white milky sperm, is common in my experience..  
Evacuation (and colonic wash) of lower intestine, as well as pelvic rocking / pelvic tilt (unwrapping tail coil, Scorpio wise) facilitate this absorption, which is then phonon peristalses pumped up the spine (sacro cranial) by coherent breath timed HRV ekg sonic..**

Since the electrically converging -charge densifying nature of this process is by definition a yang and seed making urge, it has different plumbing than in the female.. (conversely see the female role in the rainmaking section.)

In the male, the health issue is the locus of the sperm making - haploidal DNA..(looks like single helix lightning) It can be explosively destructive wherever it is stored. IF it is stuck in the scrotum / prostate... cancer results. Here the physics of why urge to touch HAS to turn to anger when frustrated... is illustrated... Destructive wave interference is needed to dissipate stored touch urge.. Bliss distribute or die is the cellular mandate...

*Obviously - in both male and female - cancers of the sexual organs are MOST quickly fatal - precisely because the urge to replicate is so critical to survival. The role of the high quality blue light which steers around the sex juices - cannot be overstated in its importance.*

*The same raw material (sexual juice) is the essence of what can carry you immortally into the stars  
- IF you **learn the plumbing / symmetry / hygiene required for high pressure pumping.***

If is always ejaculated freely, lo bliss pressure, and chi result (the AIDS leaky membrane phenomenon).. If it is alternately released and then conserved under pressure, healthy chi muscles can evolve. (Reich did not understand the spine bliss pump when he wrote 'the function of the orgasm', his only note was cancer was reduced by orgasm. He failed to conceive of a spiritual alternative... -tantra/kundalini: The spirit of being charge conserving or 'pumping back within' - 'adiabatic'..

In the male, frequent pumping up the spine canal to the high brain of the DNA lightning will ignite the high glands. The danger here is if there is no chi outlet for the brilliance, (including environmental psychokinesis - weather effects etc.) the kundalini will be diagnosed as schizophrenia ( see 'great masts of God' in Bentov's "Stalking the Wild Pendulum" ). Also over excitation of the glands can result in an unsustainably fiery metabolic rate.. Another danger is that the high amperage / current flo in the tissues will stress the mineral to water bonds holding the cell liquids in the ice-9 water symmetries required for conductivity (bliss). The result can be mineral depletion - also loss of reserves (stamina) / Kundalini can mean ability to LIGHT fires - but the challenge is to discover the hygiene to sustain that rate of metabolism / mentation (thought speed).

**Dan's - Kundalini mantra: "It is possible to have Kundalini and still lack compassion  
- but it is NOT possible to SUSTAIN Kundalini without compassion."  
--- otherwise the SNAKE BITES. (shareability required).**

**The flo of this chi is among other spectra, trackable in the microwave...the CIA, the dowers, and the insects, track and navigate by the same bloodstream... (Prof. Phil Callahan).**

In the female, a slightly different dynamic occurs in the gathering of the cellular UV/microwave blue fire sweetness.. With the fundamental urge of egg (versus seed) making being yin or unpacking, there is less 'poison pellet' (origins of football -pigskin poison needs pushing out - see Balinese cockfight ANALysis - Jung). Instead, *the more unpacking 'feminine dynamic of kundalini' - can cause:*

*1. Virgin birth.. (egg split / dimpled by charge lightning..) documented personally to me , and by Lee Sannella (MD) work. The relationship of properly compressed charge seeds - to initiating the dimpling of the egg- the fertilizing moment - is one of the deep wisdoms of the Angel Gabriel (a Seraphic ancestor to Draco.. MAG) story.*

*2. Extreme charging of the mela-sera/tonin menstrual blood implosiveness.. (Vestal messeh..) Menstrual blood then potentized like royal jelly to nourish Messiah (oil of Messeh was the crocodile juice initiator of the Annunaki and their half ancestor Draco's ; ref: Genesis of the Grail King's by Gardner)*

*3. Bliss juice from the lower sex organs can reach out, touch the Earth, and produce Shamanic vision in direct contact with Earth (particularly in Sacred/magnetically symmetric embedable - spaces).. (Sitting with naked pelvic tilt petals open contact with wet earth in sacred space, bliss juice pumping, tantric communion with Earth Gaia mind, can become a consistent /preferred ecstatic process.*

Altho there is still report of the burning like a hot coal in the pineal, from the vestigial UV triggering horse hair pumping - in women... I speculate the phenomenon is often less radical and life threatening as in the male (I consider my double scorpio case to be extreme). Again my guess would be in the female, the yin or distribute attention urge, can result in an un-grounding if there is no phase lock with the culture in the distribution of the resultant CHI/information/touch.

**In Kundalini - while the direct cell feeding bliss juice urge.. is satisfied by the kundalini bliss, (better than conventional orgasm). the fundamental need for tantric communion (solution to loneliness) may get only stronger..**

--

*kundalini* may be physically measured in among other ways. As a coherence phenomena of collected cellular "blue fire" for example (Reference our 2 hour video with 3 Medical Doctor's: "The Biology of Blue Fire".) Ultra violet coherence being the motor and currency of cell metabolism (Ettienne, and Lipton). What may be most instructive about this is the degree to which the gathered (and "fractal?") inertia of human attention/focus does specifically direct and steer this waveguide. The mechanism which permits increasingly coherent human focus to steer microwave and shorter bandwidths is very much our appropriate challenge to understand fully.

Interestingly, it was UV spectral emission lines which can measure the braid angle of DNA helical wrap factor. It was this technology which allowed us to prove that electrical lo frequency COHERENCE in the heart beat, associated with the feeling of compassion, does measurably affect the braid angle of DNA. (The chapter in my book, entitled Programming DNA: Is Emotion the Weaver"., and the research done at my suggestion by Heart Math Institute, published in Int'l Society for the Study of Energy Medicine. [soulinvitation.com/rein](http://soulinvitation.com/rein) )

The point being that an Ultraviolet effect in the DNA is documentably changed by a conscious teachable skill: feeling love and compassion in the heart measured in the power spectral analysis of the EKG (my work at Millard Fillmore Hospital in Buffalo, first measured EKG coherence associated with emotion). So now let us apply this metaphor to the activities we know create likely kundalini medical symptoms. Creating glandular coherence creates microwave and ultraviolet cellular coherence. Glandular (emotive) coherence appears teachable with biofeedback or yoga etc.

**We must ask what is the principle in essence of what permits human conscious activity to grapple with the heart of high frequency cellular fires.** I discussed with Ben Bentov many times the mechanism of the sonic entrainment of the heart pressure waves with the liquids of the brain ventricles (like a can of peaches shaking he would say.) His capacitive accelerometer for measuring this ring relationship between heart and brain liquids was one of the planets finest feedback devices.

The principle he used to measure the body micromotion - was to place the body in a chair. Just below your ass and above your crown were 2 plates of a connected capacitor. Your body IS the dielectric non-linear insulator of the spark gap! The ringing of this cavity measured as capacitive charge - was able to see the heart's thrust entrain the brain ventricle liquids. The concept here - is at the soul of :

1. the life force measuring input option to HeartTuner [soulinvitation.com/biophoton](http://soulinvitation.com/biophoton)
2. the pineal measuring ideas with HeartTuner [soulinvitation.com/pineal](http://soulinvitation.com/pineal)  
including Dr Saskia Bosman's related work on pineal - Pineal Gland - Space Time Modem?  
<http://www.spiralsofevolution.nl>

Currently - Dr Bosman builds the Pineal / capacitive plates measurement option transducer  
at [heartcoherence.com](http://heartcoherence.com)

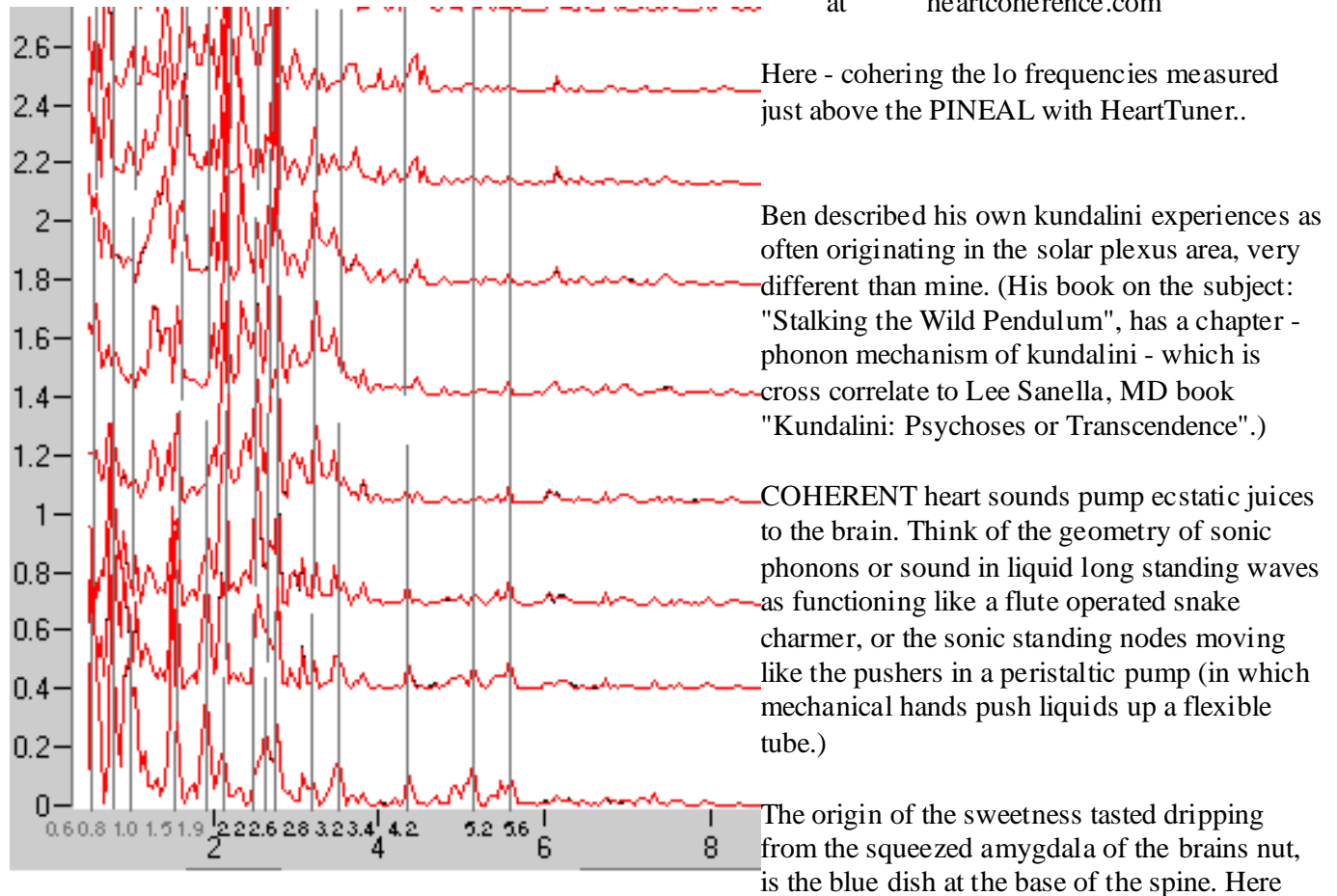

foreplay or breath gathers the collected Ultraviolet nectars of cell metabolism. If tantra or kundalini can produce enough Sacra Cranial Pulse (a sonic long wave) up the fluids of the spine, then the stinger tube hole at the base of the spine can begin to pump. **When successful this produces the positive biofeedback of "permission to taste the sweetness". Sweetness being always and only a measure of braidedness.**

There are those who doubted the definite experience of we intense kundalini experiencers, who begin to taste quite literally from the roof of our mouths, whatever is near the tailbone. The end products of digestion gather there, as in the hi frequency massaged "sweetness", highest density content braidedness: at the BLUE DISH. At first in tantra, it takes extreme conservation (abstinence from orgasm) to build the pressure of the assembled cellular hi frequency excipients (foreplay), to back flush them up the just learning how, spine pump.

Later, as the passage is opened more, the tailbone tube "straw that sucks", begins delivering sweet nectar to the brain floor 'under the flower' VERY frequently (my experience). At first we visualized a simple opening of the

tailbone tube, which Gurdjieff called the 'organ Kunda-buffer', regulated by the (sonic and actual) massage of the peritoneal and prostate ( in the male). Later we realized also that the vestigial HORSE HAIRS of the tail bone, still present at the human spin base, also serve a high frequency coherence light wave guide gathering 'up' function.

**When all of this 'sacro cranial pumping' works..( [soulinvitation.com/isthisrecursion/apta.html](http://soulinvitation.com/isthisrecursion/apta.html) AND Upledger Institute, and Polarity concepts) the arrival of these the best biological nutrients to the brain crown produces:**

- 1. an explosion of brain cellular growth at the upper brain. The unfolding of the petals of a magnetic flower there, which then attract images (magnetic waves in phase are identical to perception of 'petals') to the pineal. ...The 'Thousand Petalled Lotus'.**
- 2. an extreme plumed removal of lingum excipients /mucosal crystallizations blocking flow, from the cerebrospinal and connected lymph passages. The psychological correlates of which include however many months of tears required to excise every unshareable (less than VERY symmetric/ recursive and thus eternal) stored emotion. The geometry of emotion's electrical library being the phase disciplined foldedness on surface of cell and piezoelectric muscle. (The notion that cell surface SHAPE is no more than an index of whatever electrical waves could stand together musically in phase, as in "Structural Stability and Morphogenesis" -mathematics biophysics text, and depicted more romantically at ../cancer - shape fold index to cancer and aids.)**
- 3. a potentially dangerous over excitation/ metabolic speedup of the glands. the skill to move nutrients from the cells entrance to High Quality UV, and then out to glandular and ecstatic operations goes to its limit. Essentially, metabolisms baud rate can speed up to beyond the glands ability to withstand the fire. Nutritional honing permits survival. (Specifically I believe the higher amperage and higher frequency densities pushing thru the cellular cores, stress the mineral to water bond structure as at Albert Szent Gyorgyi "Electronic Biology and Cancer", necessitating trace mineral replacement and the bliss capacitance necessary to hold those minerals soluble and functional as geometrizers for cellular electrical conductive efficiency.. Also I emphasize the quality of the critical raw oils {"Lorenzo's Oil"} {heat kills them} which create the myelin sheath dielectric insulator so stressed by hi amperage and voltage at the synaptic level. If nervous tissue as optical hologram waveguide does not get the electrical insulator quality necessary to hold hi pressure/voltage, then psychokinesis becomes unsustainable.) Important instructions for hygiene here, at Nourished By Spin; Twinkling Eyes Lifestyle**
- 4. an overflowing of sweetness dripping onto the back of the tongue, resulting in a different appreciation of what sweetness is (the girl after kundalini or tantric ecstasy prefers lentils to chocolate because their deferred but self braided sweetness is tastier. ersatz sweetness only a substitute for ecstatic process**
- 5. the perception of a magnetically implosive current traveling spinally. Moving ones attention to the core of this magnetic current, can with shamanic practice create an organ of perception (look through the eye of the serpent.)**
- 6. a potent magnetically converging atmospheric and earth current force precipitating moisture from above, and creating new springs below. Herein comes the in-tube wormhole song-line entering force which Aboriginally glues tectonics together. Drawing the magnetic current energy line from the energy going in circles which we cutely label mass, is the ss word from ss tone : the raised djed, and djedi knight.**
- 7. a dramatic improvement over the perception of simple orgasm; the passage of haploid DNA seed up the spine in the male: prostatic thick but clear fluid can come out the penis, the semen went up. In the female notably, recurrent descriptions of "virgin" birth (conversations with Sannella, Drunvalo). The point is that it is the carrier of capacitive charge which instructs the eggs membrane to turn inside out/donut and become fetus. (The ""MOMENT"" of fertilization). The source of the charge spin must inherently have enough recursion (awareness), to feed DNA it's complement message. See how whatever causes the spherical egg**

membrane to BEGIN TO DIMPLE, is the agent of the onset of the fertilization. (see also egg dimple at pic at ../torrent ). Article with pictures at [soulinvitation.com/superDNA](http://soulinvitation.com/superDNA)

*The point being that, the lightning light spike of kundalini charge, able to COME TO A POINT, literally because its harmonics are in PHI golden ratio nesting (see our ekg spectra work), can actually trigger an egg to split... (turn inside out).*

THIS DOES NOT MEAN THAT THE ECSTATIC INDUCED FREQUENT REPORTS OF VIRGIN BIRTH have NO father. It is important to realize that what we have been calling an ECSTASY TUBE or wormhole up the spine (see also the wormhole transport function in the movies "Contact", "StarGate", and TV's "Deep Space Nine"), becomes quite literally a blood artery of what we have childishly been calling ANGELS. (Timeline/ event history trajectories or splits, like at Montauk, can be healed or reconverge nondestructively for example, only when the subsequent event histories themselves are arranged into a Phi-lotaxes based temporal fractal, - math for time histories in log phi geometric in "Spiral Calendar" by Carolan - descriptions by the Templars under "Repair the Fabric of Time" - so "Angels Don't Bleed - see also ../buehler Templar Ruta Time Continuum.. Oritronic vs Metatronic).

The magnetic implosion vortex (up the spin) in the very process of becoming self organizing as a wave function (KUNDA HAS A "MIND OF IT'S OWN"), becomes self aware. Steering this worm (ORMes), is part of the coherence body which becomes angelic. The Saraphic here (See the role of Angel Gabriel at Mary's conception, and Moroni gold plate guardian), being the hi Reptilian, (Mag), while the Ophanic being the hi source of the "bird' brain genetics. Remember "Myth of the Birth of the Hero" (Otto Rank) requiring all avatars to be virgin birth.. "So Moses Was Born" (Joan Grant), did not mean the Magnetix X chromosome was without trigger, (XY cross then BRANCH Eugene), it meant 'Dad was ET'.

**8. the long term impact of kundalini on DNA braid coherence is such as to add another harmonic series of frequencies to the enveloping. (Spectrum Analysis of the EKG measures this - HeartTuner); This is commonly and erroneously referred to as adding another strand. More correctly entering another dimension never referred to anything which was not topologically the superposition of another axis of symmetry (braiding). This is exactly what happens when the ratio of a carrier wave length, to the wave length of the envelope which contains it, becomes sacred, or recursive, or phi. (Long wave PHI ratio-Golden Mean- the perfection of recursive nest).**

Genepool spin densities become potentially entirely fractal in this way, and thus reach stellar awareness. This is harvest of sweetness which genepools potentially deliver as milk to gaia's lactic core. (Sweetness in chemistry being merely a name for HOW MUCH BRAIDING..).

9. Kundalini is schizophrenia only when the urge to fractality is fractionated, in nutrition and environment totally lacking in spin density/context richness/braidedness. (The appendix to Lee Sannella, MD book on kundalini showing the huge proportion of Kundalini experiencers who are diagnosed schizophrenic is a VERY sobering diagnosis of our Medical profession). This then relates to the microcosmic orbit skill to return/rotate the magnetic, microwave, and UV broad spectral currents back down the spine. (I believe were the microwave map of the spine to be resolved, the IDA / PINGALA up and down currents would be visible around the SUSHUMNA core).

The psychological import of this is that once you see God (light explodes), if you cannot return and create a service with your new phone line to the spin of one mind, then you will go insane. The geomantic law here is that true ecstatic process is unsustainable and produces insanity unless you live in a magnetically fractal landscape. This is why Magdalen had to create a zodiac fractal when she directed the (Templar dreams) siting of the gothic cathedrals, to distribute the spin force of the charge of her tantric swoon with Jesus Christ, fractally to the nearby zodiacal landscape. Awareness is distributed only as wave. Waves can change scales by perfected ratio only in the presence of the Lo-PHI Golden Mean Fractal. Mygdala is the name for the journal on fractality and the nut squeezed in the brain to make sweetness, by the hearts sonic fractal. Rosy foldedness perfected. Come here to die, and you won't. ... All sensitive and sustainably psychokinetic, particularly women, MUST

bond (phase lock) with their LAND, in order to get leverage on the collective DNA field effect (collective mind / 'God') .. and that landscape must be fractal/recursive/embeddable/geomantic in order to hold her charge/awareness).

The heart of the matter of principle which enables awareness to attract the force of such currents is contained in the 'recurring' harmonic whisper of the heart at the moment of love. We look at the harmonic content of the EKG, as the rush tingle of compassion sweeps, we find not just COHERENCE in the EKG between 0-35 hertz (exactly the coherence bandwidth in the EEG and the Earth's Schumann resonance.) WHAT WE FIND IS A PARTICULAR KIND OF COHERENCE (MUSICAL CHORD). WE FIND THAT WHEN THE HARMONICS OF THE HEART'S BEAT ARE MOST LIKELY TO CAPACITIVELY ENTRAIN THE BRAIN AND EVEN ENTRAIN A TREE AT A DISTANCE..... AT THAT MOMENT THE HEART'S FREQUENCY HARMONICS WILL BE A RECURSIVE/SELF EMBEDDED/ FRACTAL IN THEIR NON-LINEAR HARMONIC NEST.

More specifically, the physics here is that the frequency harmonics (power spectra / fft) of the EKG will show the heart change from normal linear harmonic intervals between contained frequencies (multiples of 2), to a situation where the INTERVAL BETWEEN CONTAINED HARMONICS BECOMES MULTIPLES OF GOLDEN MEAN. (THE ONLY SUSTAINABLE NON-LINEAR, and therefore implosive cascade called LO-PHI.. love..)

--

**The field effect of emotionally COHERENT DNA is a gravity making 'Dreamspell'**

**Simple physics now confirms the Mayan wisdom:  
"Unless the DREAMSPELL of the 'Old Ones'  
is alive and awake in symmetry space - Earth will be 'blown away'  
in the magnetic wind of the Sun."**



•Solar Flares measured deflected when millions of children sing together.

•Weight loss accompanies dying

•Radioactive half life reduced measurably using only Focused attention.

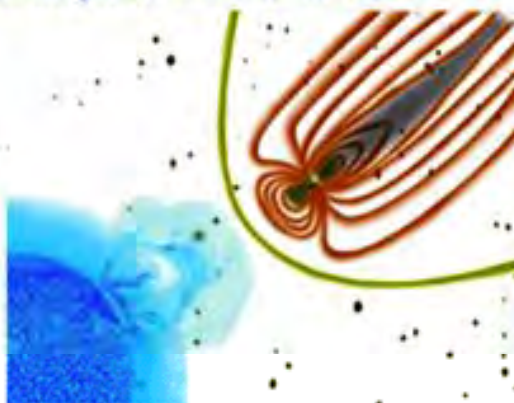

?  
Global Coherent BLISS experience:  
"Harmonic Module"  
Solution to Solar Maxima (2004-2012)  
potential destruction by compression (The 'rapture')

**In addition to it's role in Gravity making.. ("Songline" wormhole maintenance..?)**

**When the 'zipper' up the long axis of DNA braids or knots  
To accelerate thru light-speed sustainably -- this facilitates  
Lucid dream, and sustaining memory thru death... "ensoulment"**

**This is the problem genetic engineers lost by calling the braid SPACE between  
Replicating codons "Junk DNA??" -- the souls of children...**

**Introduction to the Sacred Geometry of MUSIC..**

The course material will deal extensively with understanding the sacred ratios that exist turning sound into something that fits together and becomes MUSIC. Much of that material is introduced at [soulinvitation.com/antakarana](http://soulinvitation.com/antakarana) where we calculate the musical key signature of all of physics based on the Plank length and hydrogen. This is the musical key to GROUNDING / and embedding From there we derive by PHI the harmonics of the perfect (but dangerous IMPLOSION CHORD musically. We explain the hazards of playing that chord - mechanically - and the CHALLENGE and BEAUTY of singing it. You can play the chord at the web site (flash mpeg3 plugin dragover. We explain why it is powerful but disturbing.

Much of the musical content of the course - cannot obviously happen in this handbook - it is experiential. But we will mention some themes here in outline form:

**14. Intro to the MATHEMATICS and the EMOTIONAL LANGUAGE of HeartTuner - Heart Harmonic Analysis** - Taking "Heart Music" to Heart - The HeartTuner calculates and plays the musical key signature of your heart - almost real time. ref: [www.heartcoherence.com](http://www.heartcoherence.com)

- a) What is Harmonic Analysis (Fast Fourier Transform and the Power Spectra -
  - is simply a way of looking at what pure tones - musical notes (sine waves) of different lengths are woven together to produce any complex wave (everything in the universe is a complex wave - made only of pure sine waves of different lengths. Harmonic analysis -synonyms to Power Spectra & Mathematics-Fast Fourier Transform - are ways to get at the frequency recipe for ANYTHING!
- & b.) why is this the most precise possible language to describe EMOTION .
- c.) How is this practically applied to Spectrum Analyzing the EKG to TEACH coherent Emoting.
- d.) More on Sentic and the Musical Language giving RATIO definition to the WAVE SHAPE OF TOUCH DEFINING EMOTION. (ref: How the Geometry of Pressure in Your TOUCH - Predicts the Harmonics of EMOTION IN MUSIC- & LOVE?

*Alchemy - being the ancient way of describing IMPLOSION>>> in the Heart.*



Frequency Fit ('Key in Lock')  
 Harmonic Inclusiveness  
 Of the Membrane  
 Tests the  
 Harmonic Inclusiveness  
 Of the 'virus'  
 To test for Admission  
 (Source of Immune Identity)  
 -- also see "Structural Stability  
 & Morphogenesis" text: Music  
 Of the Membranes.. Also:  
 "Laws of Form"

*'Popping the QWF'  
 Which Waves Lengths  
 /phase angles  
 Add spin to soap bubbles-  
 Making immune systems.*





**15. All About Music as a Language to describe ALL of waves and many mysteries of spirit:**

a.) Prolog: Music of SQUARES - meaning of OCTAVES vs. psychology of INCUBATION - & Followed by MUSIC OF PHI - RE-PENTING - Music of Embedding - Why ONENESS ALL AT ONCE IS NOT SUSTAINABLE WITHOUT THE PSYCHOLOGY OF SORTING - The WAVE nature of what makes an memory / emotion SHAREABLE.

b.) What makes a WAVE SHAREABLE in physics - How COMPRESSION WORKS in science and in the PSYCHOLOGY OF DEATH

c.) Understanding the WAVE MECHANICS of SUCCESSFUL DYING (Successful COMPRESSING - the infinite convergence of CONSTRUCTIVE COLLAPSE)- Ref: 1., The Geometry of Eternity, Geometry & The Bardo..

Ref: 2. Fusion-Phi Phenomenon-Unlocking Ultimate PHIRE. [soulinvitation.com/fusion](http://soulinvitation.com/fusion)

Ref: 3. The Perfect Geometry of Wave Collapse - Neurophysics Solution the Nature of Consciousness

**16. Practical Examples - Understanding Healing with Music: WHY HARMONIC INCLUSIVENESS - That is FRACTALITY in EKG for example - PREDICTS Biological Sustainability / - in anything alive - as well as Longevity Medically - Reference: The Origin of Disease and Health FRACTALITY in Heart Waves (The H.R.V.)**

a.) Bio-acoustic Habitat Theory - AND also "Sonic BLOOM" theory.

b.) Bio-Waves, Signature Sound Works, and Bio-Sonics - demonstrated - Voice Analysis demonstration by harmonic - applied to the healing literature.

**17. Hazards and power of IMPLOSION .**

a.) ref: The Implosion Phenomenon: Psychological Import of Phi Harmonic Music Phi Scalar Technology & MonoAtomic Gold..

b.) Issues about MECHANICALLY GENERATED IMPLOSION in Sound - Ref:

Sacred'Merkabbah'Frequencies-Tuning Attention/Implosion Sounds- Anatakarana and the 'Phi-ish' Rainbow Bridge

c.) Discussion of HOW could Musical Implosion BECOME SELF EMPOWERING. What is Self Empowerment..

d.) Versus MAGNETICALLY generated Implosion - INTRODUCTION TO THE SPIRITUAL PHYSICS NECESSARY TO USE 'FREE ENERGY' DEVICES:

ref: "FREE" Energy Announced- Earth Immediately ENDANGERED!!

e.) The TUOAI Stone - The 'FIRE Crystal' and WHY Atlantis Sank. Atlatal - To Project SOUL GROUP. ref: Does 'Atlantis Rising' Depend on our Soul Group Achieving the Skill to Embed : Saved by Re-Penting?

f.) Intro to PROJECTION OF SOUL GROUPS. (Soul Group Dynamics is CENTRAL TO THE SECOND PART - ADVANCED CURRICULUM ) intro here begins with : AMENTI : THE SOL POD - as Harmonic Implosion Bubble for Genepools... The Only Way Home?

**20. GEOMANCY - FENG SHUI - and GRID ENGINEERING - The role of SCIENCE and PHYSICS to Empowering and Making Shareable the Tradition.**

ref: Good Feng Shui When Scientists Cross Ley Lines With Dowzers? The Fusion of Geomancy, Science, and Feng Shui lies in seeing the pure symmetry of magnetism and charge - as the blood stream at the heart of ancient traditions. Understanding that the movement of these fields - when exquisitely nested and embedded- is very much like the blood moving in a body which WILL steer itself to find love.

a.) How and Why is it that MAGNETISM is indeed 'The Wind on Which Love Travels' . WHY does - water follow magnetism follow symmetry follow AWARENESS.

b.) HOW is AWARENESS the result of the skill to teach WAVES to agree ( and FUSE).

c.) Applying MAGNETIC HYGIENE ABOUT SACRED SPACE to the first PRINCIPLE OF BLISS PROCESS - Making the magnetism of place into LIFE FORCE : Ref: Measuring Life Force - & Making Love Visible?

d.) Practical intro to the Blissful Process of Labyrinth Making : labyrinth how?

i) Starting with Dowsing the BLIND SPRING - RAISING THE DJED:

**21. Steering Tornadoes - Practical Review of the DOWSERS Skill:  
(picture next page - Visualize EMBEDDING)**

The local Mayan shaman get's a test one day, when given the task to go out from the local village and save it from an approaching tornado. He follows his shaman teacher's instructions carefully and images inside his heart a picture of the FEELINGS of the TORNADO being magnetically sucked into his belly. His teacher called this 'Eating the HOOCHA' (eating the ANGER - Sentic wave for anger =1/7 which is all unshareable or destructively interfering waves) of the Tornado. At some point by feeling magnetically for the feelings of the tornado better than it was able to feel for itself, the tornado 'falls in love' with the shaman - who succeeded in wave embedding himself into the **center of gravity** of the tornado. By making a little picture inside his heart, which is SELF SIMILAR (or FRACTAL) to the bigger picture of the SHAPE OF MAGNETISM (literally the FEELINGS) of the Tornado - the result was - the OUTSIDE FELL IN. (Mathematicians call this operation of perfect inrushing compression: perfect fractality - perfect inward self-similarity - like zooming infinitely into a fractal or fern tree inside fern tree.). If your were a plumber observing these wave vortex operations of the student shaman, at that point you would have observed the big twister begin to follow the young shaman around like a favorite little pet puppy dog. "

So this is our teaching story. It appears to have a 'happily ever after'. Except for one minor detail: is the village REALLY saved? Now Mr. Shaman in training sir, WHAT DO YOU DO with that big tornado which could cause an awful lot of trouble, which has now elected to follow you around. THIS is the "Sorcerer's Apprentice" problem so nicely scientifically prefigured in Disney's "Sorcerer's Apprentice" cartoon movie.

**24. COMPLETING THE 4 ELEMENTS OF HYGIENE TO MAKE BLISS SUSTAINABLE:**

(Homework assignment for this week: TEST Bliss Hygiene)

**a.) Part 1. Review of Above - Bliss requires Sacred Magnetic Space - Where waves can agree to converge into stillness magnetically - Dowsing your BED, and House, and Yard- and BIOREGION - Wiring to the GRID. ref: Recursion in The Harmonic Power Spectra of the Earth's Magnetic Grid**

**b.) Part 2. DIET and Hygiene for Bliss - Applying LIFE FORCE Principles to what you put IN your Body. - all exercise practices for bliss links at: [soulinvitation.com/sbhowtos1.html](http://soulinvitation.com/sbhowtos1.html)  
References. A1: Simple Exercises to "Zero Point"**

**Nourished By Spin; Twinkling Eyes Lifestyle, Practical hygiene from spin geometry**

**Flora - the Iron Man and Restoring Bliss Amperage to Blood (Hygiene 102)**

**Ecstatic Process and the healing of the immune system**

**"EN-JOY": THE PSYCHO-DYNAMICS OF ECSTASY**

**c.) Including the KINESTHETICS of BLISS - Practical review - AND some simple introductory experience of:**

- Gurdjieff Sacred Gymnastics
- Sufi Dance
- Tai Chi
- Eurhythmy
- Sacred Circle Dance
- Yoga of Posture
- 'Posture Induced Ecstasy'

**Concluding with**

**- Moving with the QUALITY OF GRACE -**

**Converging CHARGE**

**- ECK IN STASIS.**



# THE TORNADO PRINCIPLE

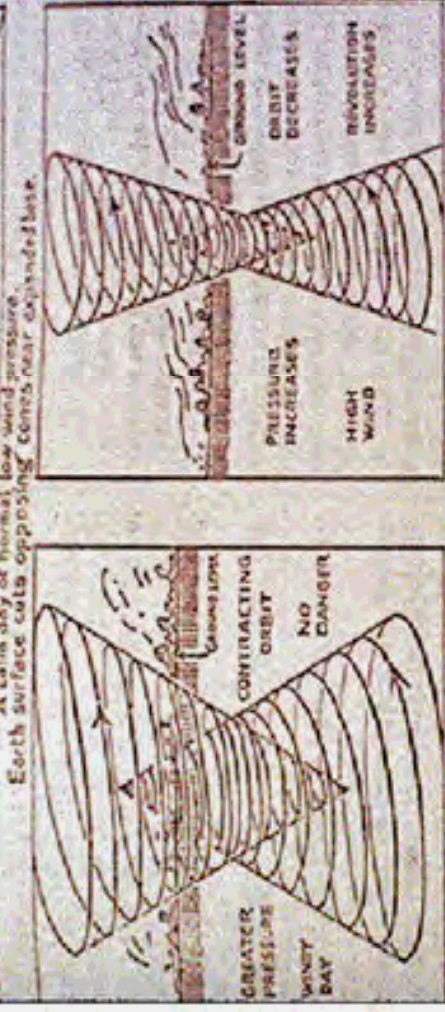

vertices of contracting cones are the danger points.

THE DANGER POINT OF A WHIRLWIND IS A STRONG GRAVITATIONAL POINT OF ORBIT TOWARD WHICH HEAVY OBJECTS RISE AS NAILS RISE TO A "MAGNET."

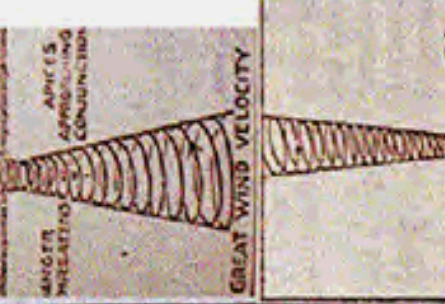
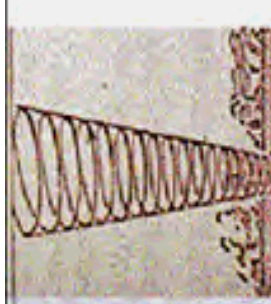

Gravity is generated in contracting cones.

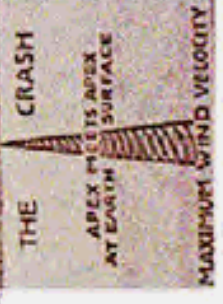

Compressible Waves Storing Inertia is the only Definition & measure physics has for MASS

Teaching Waves the Symmetry required to go in Circles is The Essence of both CREATION and Quantum Mechanics

The shaman is in training in his Mayan village. The head shaman is out of town.

A tornado comes. The townspeople come and beg the student shaman to steer the tornado around the town. The universe is made of ONLY tornados. Shaking in the knees the student shaman looks up 'tornado steering'

is his **HOW TO BE A SHAMAN 101** - handy guide. The listing there said - to steer the tornado - eat the **HOOCHA** of the tornado. Then laborious he looks up the word **HOOCHA** - it says **ANGER**.

How does **EATING THE ANGER** of the approaching tornado enable you to steer it?

By standing your **GROUND**- feeling the Earth- then radiating compassion to feel the pain of the tornado outside out as if it were inside...

Then the tornado falls in love with the shaman and follows him around like a pet dog. The clairvoyant would see - bioplasmic streamers from the belly of the shaman **EMBED** in the tornado.

The physicist would say the shaman has become the center of gravity of the tornado by electrically **EMBEDDING** himself in it.

..This is a review - reprise - SUMMARY of the first part of this book:

**Golden Ratio and the Grail: The Keys to “Sacred Geometry”**

“Teaching WHAT IS SACRED, BY TAKING THE SHAPE OF WHAT ALLOWS WAVES TO RE-CUR”  
 Could this “Principle of Pure Principle..” of SHAPE be the key to every other discipline including especially biological immortality? (and the physics of PEACEmaking?)

To make peace among waves and fields and hearts is to embed...  
 ‘fractality gets you going... within’

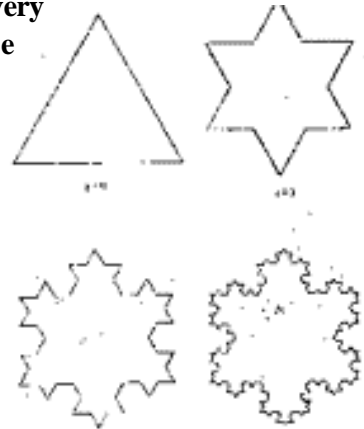

°Lo-phi (love). When the nest of electrical and sound pressure fields around the heart converge in golden mean ratio wave nests, then unlimited information transfer between worlds can cascade. Waves find this arithmetic and geometric heterodyne or beat note non-interference pattern, most touch permissive. EL-(the turn or phase shift) (in)LO-(frequency)PHI-(ratio). The PHI or golden mean ratio has been found in the frequency between harmonics of the heart at the moment of sending love, and (in the “Sentic” measurements of emotion) in the ratio of the moment of maximum pressure in the shape of the hug or squeeze you give to send love. The soft V sound in love suggests the fiveness from whose square root PHI is derived, and from which the wave softness or touchability of love radiates. see.. [Heterophi](#) Recursion/ Embeddedness/ Fractality: Suppose a short little wave would like to nest cozily and non-destructively on a larger carrier wave. The ratio of that “embedding” or braiding of a short on long wave would be something like the Phi-lotactic branching algorithm of tree ness. In fact the first fractals looked like fern trees. The ratio of a short wave which can best embed on a long is in Phi or Golden Mean proportion. This is the best nesting algorithm for waves to share spin non-destructively. In a computer program, a “do loop” which can nest inside another, inside another, infinitely, could produce infinite recursion, or self-iteration. Irving Dardik calls this expression of a turn inside a turn: “super-looping”. In a geometric sense when pattern or foldedness can nest inside itself layer in layer, this becomes the fingerprint of fractality.

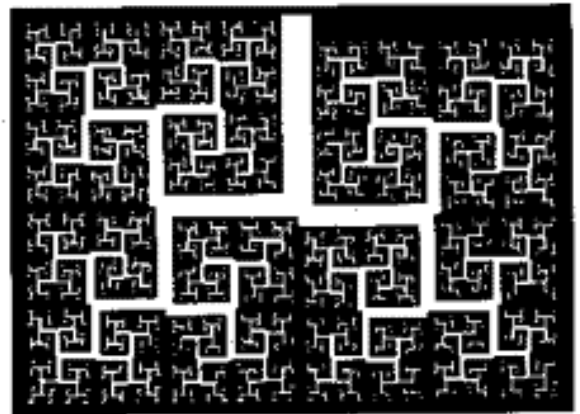

Fractal Tree Structure Lung Schematic

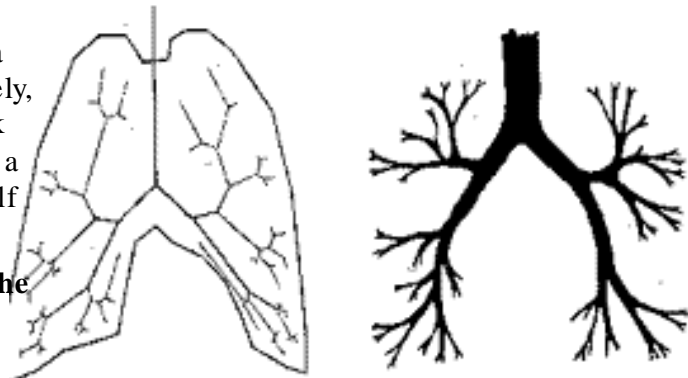

Is this an ultimate way to unlock the key to maintaining the PHIRE of life?

**Think about it: Is there ANY other way that multiple waves and phases could FUSE non-destructively... excerpt in recursive heterodyning (Phi)?**

see: [Heterodyning and Powers of Phi, by Rick Andersen](#)  
[soulinvitation.com/heterophi](http://soulinvitation.com/heterophi)

VISUALIZE the COMPRESSION BUBBLE THESE WAVES MAKE BY NESTING TO ONE PLACE-

AS THE WAVE BUBBLE YOU CALL YOUR ATTENTION WANDERING AROUND IN ETHER”S JELLO.



Self Embedded Heart Harmonics

*Here it is as simple as we can make it: The 'Red Neck' Customer at K-Mart:*

## ***Dialog - SACRED GEOMETRY - What's IN IT FOR ME?***

**Q:** What is “Sacred Geometry” and why is it important? (in “no big words please”)

**A:** We start with a simple notion: The newest UNIFIED FIELD physics ends up telling us that EVERYTHING is made of waves. I happen to conclude therefore that mind and spirit are made of waves also. In any case it appears that SACRED may be simply a name for a wave pattern which is sustainable (lives forever). And GEOMETRY may be a name for what arrangement or SYMMETRY (or pretty pictures) among waves, ENABLES THEM TO LAST FOREVER.

**Q:** So what's the big deal? This sounds like old news. You use QUANTUM MECHANICS, and you draw pretty pictures of waves nesting. Symmetry and geometry as news headlines are old and boring aren't they? What is the latest flurry over this stuff? People are talking about this as the key to the heart and love, that couldn't be true could it?

**A:** By looking at the harmonics in the hearts beat (frequency signature), we may have recently found something radically wonderful and romantic in all this geometry stuff. Something clearly electrical happens, at the moment most people feel the charge rush or “tingle” associated with WONDER or COMPASSION or LOVE (or extreme emotional openness). Too many of us have experienced this hair standing or blood tingling “dna grail cup ring” at emotions' wonder moments, to pretend it is not real. I often now call this “TRIPPING OVER A SHAREABLE THOUGHT” (or feeling). I have discovered this may well be measurable and THE KEY to Sacred Geometry! (With the help of some computer animations you might even come to agree with me.) I now believe that this wonder/love/compassion/openness feeling is literally a PURE SHAREABLE (or perfectly distributable in principle) electrical wave event.

(see [soulinvitation.com/intent](http://soulinvitation.com/intent))

THE HEART LEARNS TO MAKE ALL WAVES CONVERGE CONSTRUCTIVELY- PERFECT COMPRESSION (or “fractal” see [glossary](#)). The name most people give their EMOTION when they feel this “non-destructive” (non-hurtful), inward rush in the HEART's electricity, is “COMPASSION”! In fact, compassion may be identical to the “Sacred Geometry” of PERFECT COMPRESSION! Love may be a teachable skill to make a “fractal attractor” around your heart.

**Q:** Yeah right. Well slow down and explain how simply looking at the geometry of the heart's electrical music get's us to the solutions to the universe. Most people cannot visualize a fractal, don't know what an “attractor” is, and don't rightly care what harmonic analysis or frequency signatures are. You mean you can help people be better lovers? (chuckle)

**A:** Here's what we do. Using a simple safe battery gizmo, ([heartcoherence.com](http://heartcoherence.com)) we take the electrical voltage wave coming from your heart (less fussy than placing EKG stick-ons). We look at which simple sine waves have been nested or embedded together to make your heart beat. This is the musical breakdown of which notes have been played together to make the chord of your heart beat sustainable (chief factor in determining how long you live). In fancy terms it is called “spectrum analysis”, “power spectra”, “frequency signature”, “harmonic analysis”, “fast fourier transform” or “FFT” etc.

All these words mean roughly the same thing. Think of mother checking to see if daughter is playing music or noise on the piano, she uses her ear to check the distance between the notes or wavelengths. Her ear analyzes the INTERVAL or SPACING or RATIO BETWEEN THE ADJACENT NOTES. This happens automatically every time the hairlengths use a golden spiral in your inner ear (cochlea) to measure (spectrum analyze) the RATIO BETWEEN SOUNDS, and thus determine if the incoming pressure waves are MUSIC OR NOISE. Every complicated thing in the universe (atoms, people, galaxies etc.) are ALWAYS

ONLY the simple adding together of ONE SIMPLE PERFECT SINE WAVE SHAPE, in different (wave) LENGTHS or "FREQUENCIES". Put a bunch of different sine waves together with the proper length cookbook and you got people, gold, stuff, atomic tables... etc. BUT if the wave lengths cannot sustain their EMBEDDING together (by not fighting as waves), then all that STUFF gets dead! (goes away and cancels itself by interfering WITH ITSELF as a wave).

Q: That's cute language again for "old news". I hope you are gonna get to the "better lovers" part real quick. So how do you get from the little wave length tinkertoys nested in the beating heart, to using geometry for MEASURING and TEACHING how HEART's OPEN???

A: Well first then we get a little stick on the computer screen for each INCLUDED HARMONIC in the heart's wave. As they become ordered or "COHERENT" we notice the emotional INTENSITY (or focus) INCREASES. Then we simply measure HOW MUCH THE SPACE OR INTERVAL BETWEEN THE CONTAINED HARMONICS OR MUSIC, INCREASES. Amazingly, invariably as people go from being a bit stuck in their analytical head, to feeling openness in their heart, the DISTANCE BETWEEN the wavelengths in the heart ALSO OPENS!!! As Professor of Energy Cardiology at University of Arizona Medical School at Tucson, Gary Schwarz said after kindly inviting us to speak there said, "It's really a no-brainer". (I am so happy he has agreed to sponsor and begin the academic research to now begin to prove this.) So HEART OPENING = heart's HARMONICS opening.

R)edraw U)sers[1or2] A)udio S)peed E)xit H)elp Name: tttt

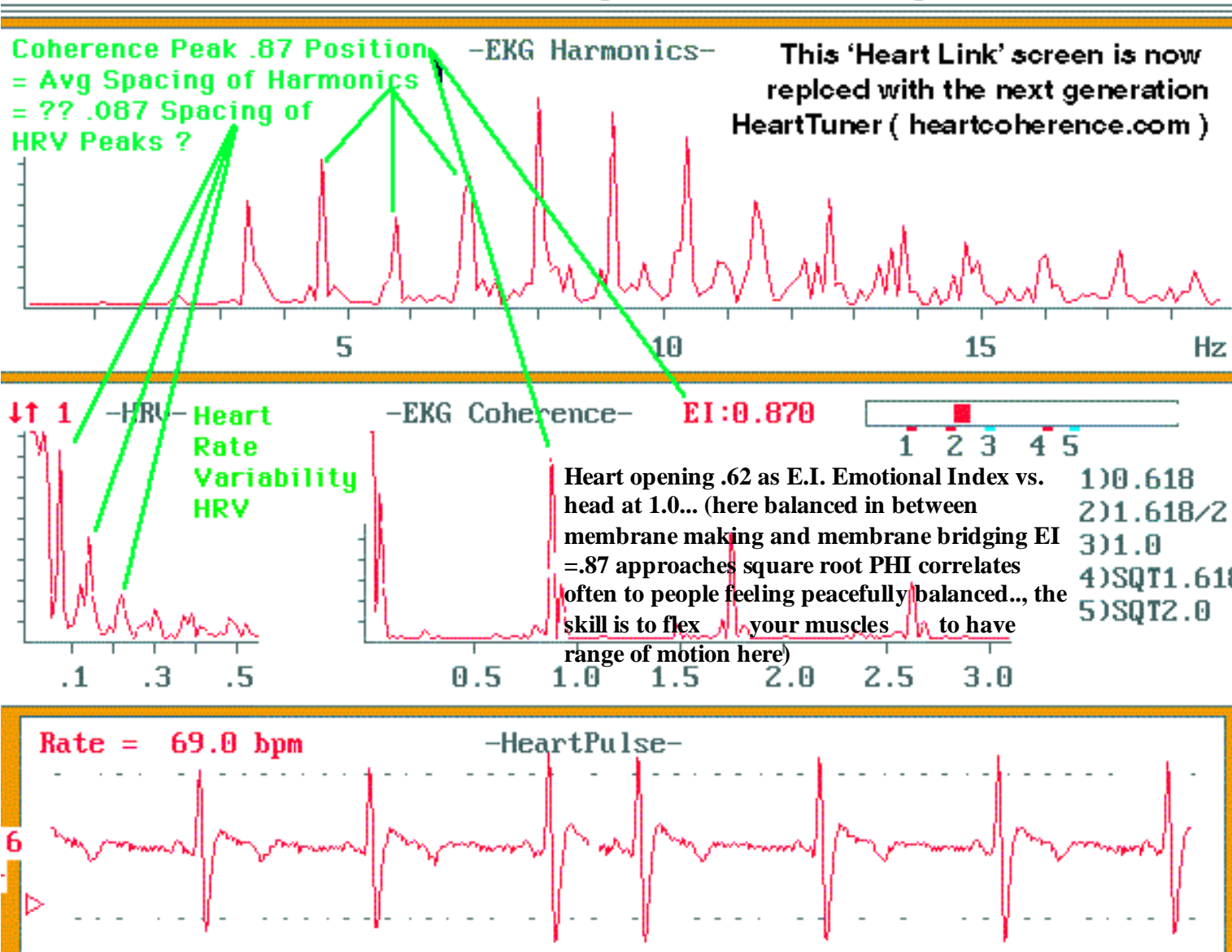

Q: Seems simple enough, but where does this get us to “fractal” geometry, and teaching the kids to be better lovers?

A: Well, first I need to explain just a little arithmetic history here. I invented a new mathematical technique to measure this INCREASE IN COHERENCE (or ordering of the harmonics), and MEASURE THE INTERVAL BETWEEN contained harmonics. This could enable us to make emerging from chaos into self-awareness (something which I will later explain is simply self embeddedness) teachable for ANY oscillator like heartbeats, [stock markets](http://soulinvitation.com/stockmkt/stockmkt.html) ( soulinvitation.com/stockmkt/stockmkt.html ), and planets. In order to get at the harmonics EMBEDDED inside the harmonics, I invented the use of a ‘SECOND ORDER FREQUENCY SIGNATURE’ or “DOUBLE FFT”. This means simply that I take the process of doing of spectrum analysis (same as all those synonyms for basically the same idea above), and then I look ‘re-cursively’ at WHAT IS THE HARMONIC OR MUSIC or KEY frequency in the wave which is the HARMONICS of the heart? (or anything which wishes to become self-aware or self-embed).

Q: Careful you are getting technical on us. Re-cursive just means to re-occur doesn’t it?

A. Yes, and if a wave or a heartbeat or a person as nests of waves, were to re-occur re-cursively forever, then that would be SUSTAINABILITY or “eternal recursion” or literally IMMORTALITY wouldn’t it?

Q: I suppose. Actually, I think I get it, you are DEFINING WHAT IS SACRED, BY TAKING THE SHAPE OF WHAT ALLOWS WAVES TO RE-CUR? Right? (golly)

A: You are definitely in trouble now, because you are beginning to get it. (see [./glossary](#) under: “to grok”= eating something whole instead of in pieces)

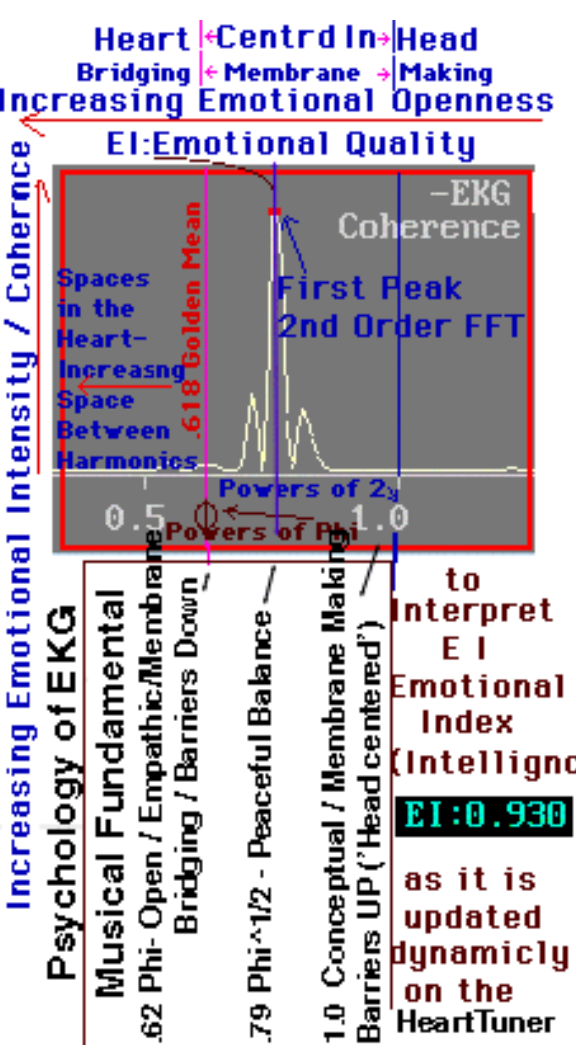

Q: Kool! But you were getting to what makes all this supposedly fractal? And Teaching Lovers??

A: Well once we have this harmonics OF the harmonics, (second order FFT), wave, it got REAL EASY. The height or amplitude of the first peak is the newly elegant MEASURE and feedback of the AMOUNT OF COHERENCE (or in the case of the heartbeat, amount of emotional focus or intensity). This simplifies making the biofeedback game (or loop or neural net) to teach emerging from chaos. But even more importantly the number or numeric value of this first peak, dynamically represents the (inverse of) THE AVERAGE SPACE BETWEEN HARMONICS in the heart (or any vibration wanting to know itself). For the heart as a vibrator needing to nest or die, (see [embedability](#) and how [Heart Rate Variability measures survival](#)). By testing hundreds of people for what is this INTERVAL or SPACES IN THE HEART, we have come with a simple table for EMOTIONAL INDEX or EI or EMOTIONAL INTELLIGENCE quotient. When the space between harmonics is 1.0, the person is making cubic membrane making electricity around their heart, and invariably are experiencing INTELLECTUAL SATISFACTION. Whereas WHEN THE E.I. NUMBER IS .618 (Golden Mean Ratio), (1/x interval between Heart Harmonics has INCREASED to 1.618), THEN THE PERSON HAS OPENED THEIR HEART AND INVARIABLY IS IN A MORE WONDER/COMPASSION/OPENNESS SPACE!

**Interpreting HeartTuner Screen (previous page bottom) to Make Increasing Emotional Openness and Intensity Measurable.**

**Q:** I get it. You are telling us getting a .618 Golden Spiral in the HeartBeat's harmonics or music is what makes **VALENTINES work. (like at ./gold )** So don't stop now, tell us what makes all this Golden Mean Ratio Stuff even if it is the "heart" of the matter, the key to what is FRACTAL, what is NESTABLE or "EMBEDDABLE", and what RE-CURS?

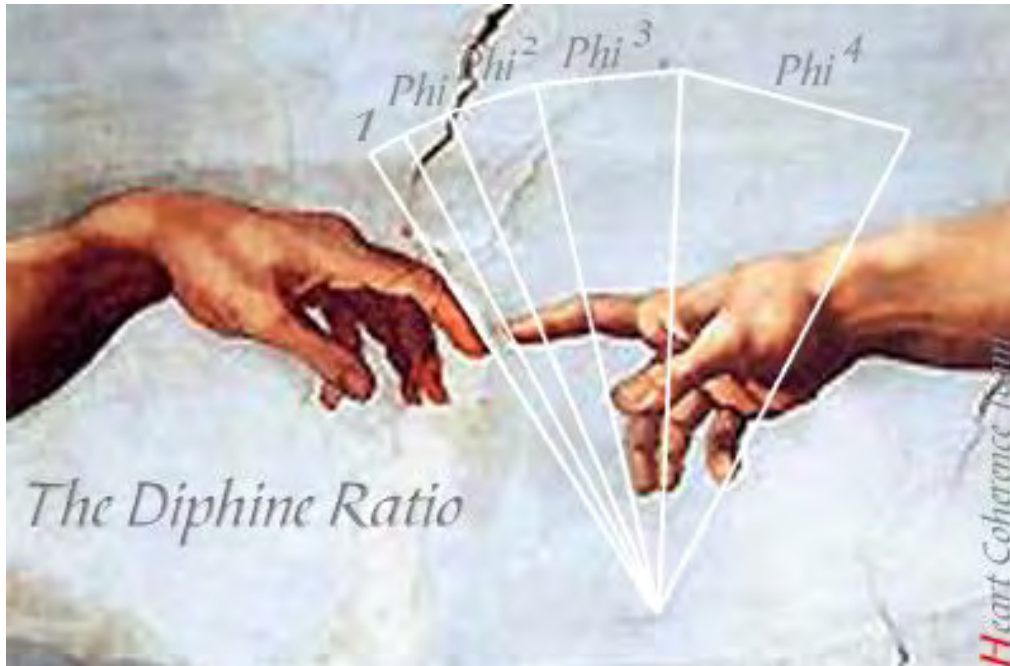

**A:** Well Ma nature invented a way to allow waves to nest or branch or embed with optimum SHARING (or non-destructive interference). This is called Phyllotaxies in nature. It is named after PHI the symbol for .618 Golden Mean Ratio. It simply refers to how all plants branch most excellently to get maximum exposure (sharing) minimum superposition (destructive interference).

Page- 37- pics of perfect Phyllotaxies or perfect NESTING perfect branching or perfect EMBEDDING is based perfectly on the GOLDEN MEAN) . Also see [soulinvitation.com/physicsofphi](http://soulinvitation.com/physicsofphi) "THE PHYSICS OF Phi, Compression, Implosion, Gravity, Time, and Love"

**Q:** OK, so we got nesting or branching perfectly even in the HeartBeat is a Golden Mean related thing. And it might even have to do with feeling wonder or compassion, because the Heart's harmonics space themselves that way when you "FEEL THE RUSH". What is this about perfect compression equals perfect compassion??

**A:** We call this (both perfect compassion AND perfect compression), the skill to learn to turn inside out. (as when the voltages triggering the heart electrically "dimple":

When the magnetic map OUTSIDE you (someone else's feelings or world) needs to get INSIDE you, what is required is called "non-destructive compression" or even "scale invariance". see [soulinvitation.com/scaleinvariant](http://soulinvitation.com/scaleinvariant)

Mind (recursion) inhabits fire = Phi's-ray.

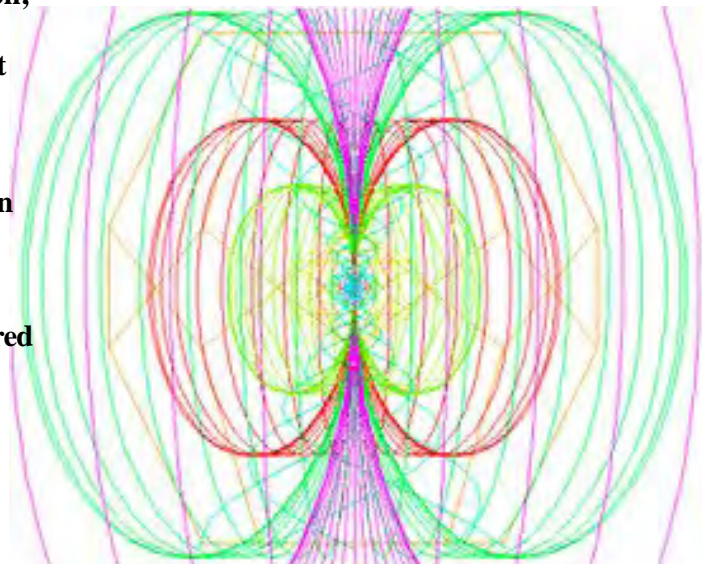



This is a wave nesting pattern based on Golden Mean. When waves interfere they add re-cursively, so they need a nest in which they can both add and multiply and still fit the original nest. This is the problem Phyllotaxies and the Golden Mean ratio solve, because .618, 1.0, 1.681..., 2.618..., ... is the only progression which BOTH adds and multiplies. This is the Merkabbah (mark of perfect pressures nesting) solution to

-perfect nesting

[IS THIS RECURSION? KEY TO THE HARMONIC GEOMETRY OF BIOLOGICAL OSCILLATORS](http://soulinvitation.com/isthisrecursion/isthisrecursion.html)  
[soulinvitation.com/isthisrecursion/isthisrecursion.html](http://soulinvitation.com/isthisrecursion/isthisrecursion.html)

-perfect branching (scion or jon or the origin of the grail in the blood's dna branch to embed and ring)

-perfect compression /data packing / data sharing / phone call to God cookbook.. - perfect compassion..

see [soulinvitation.com/physicsofphi](http://soulinvitation.com/physicsofphi) and the science side [soulinvitation.com/predictions](http://soulinvitation.com/predictions)

Q: So here is where you leap in and get heavy on us I suppose? What do you want us to do, learn how to go out and squeeze everything into long wave Phi ratios? (1o-phi = love... chuckle...) Is this how you are teaching lovers to get in phase & em-bed (chuckle...) with each others' heartbeats?

A: We noticed that when heart's get embedded within themselves by this ratio (ending addiction, A.D.D. and every known chronic disease), they also get embedded with each other. We called the project to link hearts around the planet. We have actually designed a way to accomplish this, ([./millennium](http://soulinvitation.com)) and we think not only will heart music learning allow us to touch each others hearts non-destructively, it will heal wars and the planet. see [soulinvitation.com/peaceuniversity](http://soulinvitation.com/peaceuniversity)

Table 1  
THE ELECTRON ORBITS OF THE ELEMENTS  
(Atomic numbers 1-54)

Atomic No.	Element	K	L	M	N	O
		1	2	3	4	5
		s	sp	spd	spdf	spdf
1	H	1				
2	He	2				
3	Li	2	1			
4	Be	2	2			
5	B	2	2	1		
6	C	2	2	2		
7	N	2	2	2	1	
8	O	2	2	2	2	
9	F	2	2	2	2	1
10	Ne	2	2	2	2	2
11	Na	2	2	2	1	
12	Mg	2	2	2	2	
13	Al	2	2	2	2	1
14	Si	2	2	2	2	2
15	P	2	2	2	2	2
16	S	2	2	2	2	2
17	Cl	2	2	2	2	2
18	Ar	2	2	2	2	2
19	K	2	2	2	1	
20	Ca	2	2	2	2	
21	Sc	2	2	2	2	1
22	Ti	2	2	2	2	2
23	V	2	2	2	2	2
24	Cr	2	2	2	2	2
25	Mn	2	2	2	2	2
26	Fe	2	2	2	2	2
27	Co	2	2	2	2	2
28	Ni	2	2	2	2	2
29	Cu	2	2	2	2	2
30	Zn	2	2	2	2	2
31	Ga	2	2	2	2	2
32	Ge	2	2	2	2	2
33	As	2	2	2	2	2
34	Se	2	2	2	2	2
35	Br	2	2	2	2	2
36	Kr	2	2	2	2	2
37	Rb	2	2	2	2	1
38	Sr	2	2	2	2	2
39	Y	2	2	2	2	2
40	Zr	2	2	2	2	2
41	Nb	2	2	2	2	2
42	Mo	2	2	2	2	2
43	Tc	2	2	2	2	2
44	Ru	2	2	2	2	2
45	Rh	2	2	2	2	2
46	Pd	2	2	2	2	2
47	Ag	2	2	2	2	2
48	Cd	2	2	2	2	2
49	In	2	2	2	2	2
50	Sn	2	2	2	2	2
51	Sb	2	2	2	2	2
52	Te	2	2	2	2	2
53	I	2	2	2	2	2
54	Xe	2	2	2	2	2

the Sub Orbitals  
 (Building Blocks For Atomic Table)

s orbital = 1   
 torus/donut  
 = 1 pair vertices = 2 Electrons

---

p sub orbital = 3 pairs of Donuts/toroid  
 = Cube  
 3 pairs = 6 Electron

---

d sub orbital = 5 pairs toroid  
 = Dodecahedron  
 5 pair = 10 Electron

---

f sub orbital = 7 PAIRS  
 7 rotational symmetries  
 = icosahedron  
 (5 real rotations + 2 mirror or pseudo rotations per Armand Wyler)

7 pair = 14 Electron

**Course Syllabus - Synthesis - Course Review - IN OUTLINE FORM**

This article begins with a beginner syllabus to “sacred geometry and coherent emotion” then finishes with an advanced syllabus.

*1.Embedding all folds:*

*2.Love bears all things, believes all things, hopes all things, endures all things,love never fails. 1st Corinthians, ch 13..*

1. In a unified field everything is waves moving about in a universal jello of particle/waves.
2. In that universal jello or “ether” the only self-organizing shape is the donut or smoke rings or torus.
3. Those donuts or vortex pairs arrange themselves like trumpets into the faces of the platonic solids, and this is called the atomic table (matter).

(1,3cube,5dodec,7icos donut vortex pair make 2,6,10,14 electron-s,p,d,f subshells: all matter)

Also, the self organizing Spiral which delineates the self organizing 7 color map moebius on the surface of that same donut, viewed from the symmetry of the tetrahedron is the Hebrew alphabet. Letter’s are merely elements of spin symmetry, which by virtue of being perfectly embedded , allow the hologram inside your head to phase entrain the denser hologram (matter) outside.

4. When a wave in this jello or ether moves in a line it is called energy, when the same wave is “sucked” into a circle, the slight gyroscopic resistance to change of position, is called “matter”. In physics, INERTIA stored is the ONLY definition of mass. The wave moving in a circle creates matter (as opposed to “doesn’t matter”).

This is called quantum mechanics, because elements of the wave spin can only stand still when meeting themselves from opposing directions.

This separates the jello or ether into packets or envelopes of waves, storing spin inertia. So “the creator” (fractal attraction) is the principle of self-reference (self/awareness) which steered the wave into the circle, from the line. I am that I am.

5. Something has to provide “centering force” to hold the wave going in a circle in the same place (widening gyre with a center that will not hold?).

6. This “centering force” is what happens when waves “collapse”, “implosively” toward a center.

IMPORTANTLY: this collapse inward function is called many names:

- a. implosion is to burst inward and inward flow only.
- b. gravity is the attraction between two massive bodies. The name of the attracting force.
- c. magnetic monopole,,
- d. scalar is a quantity such as it’s length wave that is completely specified by its magnitude and has no direction. From the latin ladder
- e. Recursion is to happen, to come up or show up again, repeatedly.
- f. self reference

°7. Waves get this permission to CONcresce (gather all crests to one point) when they all arrange their distance from that point by PHI or Golden Mean ratio. This is because this allows “recursive” or repeated adding AND multiplying of their interference. This perfects constructive interference from many directions at once.

8. Therefore gravity occurs BECAUSE the outer waves nest (electron for example on an atomic scale, or long wave ley lines on a planetary one) BECOMES SELF SIMILAR or recursive to the inner waves nest (neutrons in an atom.) This pattern on the outside repeated in the pattern on the inside is the definition of FRACTALITY. THIS MEANS LITERALLY THAT FRACTALITY (charge arranged into self-embedding) CREATES GRAVITY. (And this will be born out in a revolution as physics proves gravity and atmosphere can be stabilized by perfecting the geometry of embedding, see [../predictions](#) )

9. When waves are drawn to a focus, they automatically sort out those, which cannot pass the laws of symmetry to let them pass the vortex which focus creates. This means that WHATEVER CREATES FOCUS CREATES SORTING. This also means that THE TEST OF PERFECT SYMMETRY, IS THE SAME AS THE TEST FOR WHAT IS PERFECTLY SHAREABLE (AS A WAVE OR IDEA OR EMOTION OR INTENT OR PERSON OR FEELING OR...).

10. Perfect fractal or recursive or nestable or “embedable” symmetry is thus literally a test for pure intention.

11. When waves can agree to meet sustainably this is called “sacred”.

12. The Golden Mean or PHI ratio perfects recursion/embedding/intention/gravity/awareness/responsibility/implosion/mass/sorting..

13. The role of MIND among waves, is to align the still points, which guides them into the PHI ratio of recursion permitting them to stay still. They get permission to stand as wave (called “eck” -or charge- in “stasis” / ecstasy). This creates the tingle in your body in the place you have chosen to place your attention, you have aligned field effects to “concrecence” or centering. This compression of the ethers is the principle by which matter is created out of light.

14. When the harmonics of a brain (eeg) or heart (ekg) or planet (Schumann series), enter into nesting by powers of PHI, then that (or any) biological oscillator becomes:

- a. self organizing
- b. self aware
- c. eck-static

examples include the sustainable elimination of addiction and attention deficit in brainwave neurofeedback work using this principle.

15. The power of placing a limit (“power of limits” by Doczi) on any oscillator is that in order to emerge from chaos, IT MUST TAKE THE PATH OF PHI-LO taxis. (Perfect branching based on PHI.) examples include stock market becomes predictable when volume harmonics become PHI / and heart waves become sustainable (all chronic diseases end) when the harmonics arrange themselves into Phi embedability.

16. EKG harmonics only Heartlink/ ASCEND into this perfect fractal or “heart rate variability” when you feel wonder/compassion/truth because this exactly corresponds to what is electrically distributable or shareable.

17. The reason “only love bends the light, so therefore only love creates” is because this feeling of compassion permits compression, which permits centering which draws in the linear light into the circle. The same electrical centering force/literal gravity of glandular emotion creates steerage among wormholes and dimensions.

This is why perfect compression is identical to compassion. Both are examples of successful sharing (symmetry) of space.

To understand this more literally, consider this. At the moment of apparent bliss/ or compassion the heart invariably appears to create harmonics spaced near .618 Golden Ratio (ref 1, ref 2). The only possible sustainable 3D geometry which is that nesting geometry is the charge implosion associated with waves in the dodeca stellation. (See [Grail animation](#) - perfect embedding). This clearly is that origin of gravity, namely that self-similarity / fractality in 3D is what creates the one way suction inward called gravity. (As waves are sucked in thru the speed of light). This is the only effective way sucking or bending the light out of it's line (energy) into a circle (gyroscopically the origin of stored inertia called mass). Embedding - amounts to representing well - WHAT IS OUTSIDE YOU, AS IF IT WERE INSIDE. So not only does embedding by long wave phi ratio (lo phi) create the only possible inward imploding centering force to bend the light, IT IS ALSO TRUE THAT ULTIMATELY IT IS THAT EXACT PRINCIPLE WHICH IS THE ONLY POSSIBLE WAY TO CREATE (MATTER OUT OF LIGHT). (Since the light won't continue nesting it's quanta in a circle unless that centering force caused by embedding remains. ) This would explain further why planets only sustain gravity by assuming an embedable (dodeca) shape to their long waves (grid). And in so doing, as Gurdjieff said, begin to experience gravity relations erotically - in somewhat the same way as coherent emotions feed the Earth.

Further reading on Braeshith - origin of thing ness - first word of Genesis - being specifically how to turn inside out as a symmetry principle - [soulinvitation.com/goldenarches](http://soulinvitation.com/goldenarches)

### **Expanding these thoughts to a more advanced - 'esoteric' summary**

#### **Unified Field Precisis..**

- 1) Mind Aligns (Permits Compression) among Waves.
  - 3.Matter is created from Aether by Compression.
  - 4.Non linearity of the vortex, is the origin of matter.
  - 5.Energy in the aether, IS the Centripetal Origin, (Creation), Counter-thrust to Entropy.
  - 6.The path out of chaos for any oscillator is ability of the principle of embedability.
  - 7Feelings have shape.
  - 8.Feeling is made of magnetic lines, folding "nondestructively"
  - 9.Emotion is magnetism, energy in motion BETWEEN frequencies. This is the scalar wave we have called gravity.
  - 10.Where gravity is most dense capacitive power spectra is power of phi.
  - 11.When magnetic lines braid by ratio phi, waves accelerate thru light speed, making soul force & ability to lucid dream...(reason to learn hygiene of ecstatic process.
  - 12.That this braid can be influenced by sonic waves from glands (loving ekg)
- right in the DNA. Carrier wave in DNA is UV thread, braid to string to rope to fat rope, envelope to carrier ratio phi until the inertia of envelope implodes its own carriers making soul. psychologically this requires sorting more and more ringing in your ears the DNA of your ancestors yearning.
- 12) What you see when you close your eyes depends on this penetration of biology's magnetism thru light-speed.
  - 13) Genepools survive directly into embedding into planets & stars by this principle, of waves inhabiting or embedding larger waves.
  - 14) Surviving the solar storm requires this achieving of "scale invariance".
  - 15) To Inhabit is to Embed (Incarnate)
  - 16) Embedability is Phi-Lo Tactic (Recursion Perfected)

>From: "Marijn -more questions

>Dear Mr. Winter,

>

>My name is Marijn and I'm a student comparative sciences of culture at the university of Ghent in Belgium. I have recently watched your three volume video series "The physics of love and compassion" and read quite a few articles at the soulinvitation website. Most of what is said there I can grasp intuitively, but there are a few things which I don't see very clear yet. To put it differently, I would say that I understand most of the topics individually, but I have problems to see all the connections between the topics, particularly between

> a.. the unique property of the golden mean to allow for non-destructive interference of sums and multiples of waves,

> b.. coherence among waves which means that they embed or become fractal or take the form of a caduceus (3-dimensional sine wave)

> c.. the first major cepstrum (Fourier transform of the already transformed waves) peak as indicator of coherence among waves; why is it that you "ONLY GET A PEAK IF THE INPUT WAVES ARE ORDERED OR COHERENT"? Is it necessary to use graphics for understanding this or is there a more intuitive explanation for it?

> d.. the phase component of a Fourier transform (I have seen Fourier Transformation in school (topic of choice), but with emphasis on the non-mathematical side of it; I know that there are two components: amplitude and phase), particularly the relation between coherence among waves and what you call phase "discipline".

> e.. standing waves which have nodes (points who stand still) and moving parts between the nodes (I saw this in school as well), and the function of the mind to "align the still points". Why do these nodes have to be aligned for the waves to become coherent?

> f.. energy which becomes matter when it is forced from linear direction to circular direction. Could you give an example of what you mean by "only love bends the light, therefore only love creates". If love creates matter, do you mean matter inside or outside the body of the person who loves? Or am I wrong interpreting this sentence literally?

> g.. turning inside out of waves. I understand that turning the heart inside out is necessary to allow the waves outside of yourself to be felt inside without "damaging" the shape of the original outside waves, but what is the connection with "only love bends the light, therefore only love creates"?

> h.. symmetry and quantum physics: Why is symmetry the key word in understanding quantum physics and particularly the connections between standing waves and weak and strong nuclear forces?

> i.. time and fractality. I don't see very clear how time can be fractal. I connect fractality with patterns of waves, but I don't see how time fits in that.

>

>I realize that I ask a lot from you. Therefore many thanks in advance. I really hope that you continue your groundbreaking research in the future; I've often wondered why there is so very little known about your work, for instance by people who study physics. The main topic in string theory nowadays is (super)symmetry, isn't it?

>

>one final question: Are there already devices on the market which can measure emotional coherence with the method you discovered? If no, is it difficult to make one by myself?

>

>Kind regards, Marijn C

Reply from dan

Last question first, the device IS available now: HeartTuner <http://www.heartcoherence.com>

The unique property of the golden mean to allow for non-destructive interference of sums and multiples of waves,

A: recursive adding and multiplying to produce constructive heterodynes is ONLY possible in golden mean ratio - see <http://www.soulinvitation.com/heterofi/heterofi.htm>

\* coherence among waves which means that they embed or become fractal or take the form of a caduceus (3-dimensional sine wave)

\* the first major cepstrum (Fourier transform of the already transformed waves) peak as indicator of coherence among waves; why is it that you “ONLY GET A PEAK IF THE INPUT WAVES ARE ORDERED OR COHERENT”? Is it necessary to use graphics for understanding this or is there a more intuitive explanation for it?

\* the phase component of a Fourier transform (I have seen Fourier Transformation in school (topic of choice), but with emphasis on the non-mathematical side of it; I know that there are two components: amplitude and phase), particularly the relation between coherence among waves and what you call phase “discipline”.

A: When the phase different between the peaks of the first FFT (power spectra) is ordered THEN the peak in the second order FFT (cepstrum) appears that is the definition - and here the MEASURE of coherence ref - <http://www.soulinvitation.com/coherence>

\* standing waves which have nodes (points who stand still) and moving parts between the nodes (I saw this in school as well), and the function of the mind to “align the still points”. Why do these nodes have to be aligned for the waves to become coherent?

A: Shareable waves a propagable?... Why does a laser go farther than a flashlight... same physics

\* energy which becomes matter when it is forced from linear direction to circular direction. Could you give an example of what you mean by “only love bends the light, therefore only love creates”. If love creates matter, do you mean matter inside or outside the body of the person who loves? Or am I wrong interpreting this sentence literally?

A: Whatever creates the centering force to keep the wave going in a circle (that which makes the inertia which physics labels - “mass”-) is the real creator..

Embedding creates the centering force - because charge self-similarity (fractality)

is what creates the charge compression which einstein failed to model..

(because he did not understand self similarity of charge IS the compression called gravity)

Love creates the centering force, because it - is the learning of turning inside out that MAKES the charge compress which starts the wind to center.. which bends the wave from the line into the circle...

**ONLY LOVE BENDS THE LIGHT SO ONLY LOVE CREATES**

\* turning inside out of waves. I understand that turning the heart inside out is necessary to allow the waves outside of yourself to be felt inside without “damaging” the shape of the original outside waves, but what is the connection with “only love bends the light, therefore only love creates”?

A: please see <http://www.soulinvitation.com/dimple>

\* symmetry and quantum physics: Why is symmetry the key word in understanding quantum physics and particularly the connections between standing waves and weak and strong nuclear forces?

A: Conventional physicist agree: all matter and physics is simply a question of learning symmetry

This implies why water follows magnetism follows symmetry follows awareness..

ref: <http://www.soulinvitation.com/dowsing>

Time and fractality.° I don't see very clear how time can be fractal.° I connect fractality with patterns of waves, but I don't see how time fits in that.°

A: Please see: [soulinvitation.com/fusion](http://soulinvitation.com/fusion) and also book: "Spiral Calendar" by Carolan. In a 'nutshell' event timings if you draw their time in history on a curve instead of a line - can actually be placed at geometric spiral distances apart in TIME. much lo phi dan winter

-----  
**CONCLUSION** : Test - Each Student is asked to ASK enough questions to prove to THEMSELVES - that they could at least BEGIN to TEACH WHAT THEY HAVE LEARNED. **Why PURE PRINCIPLE IS IMMORTAL - How RECOGNIZING And LIVING IN Pure Principle Makes Us Immortal Too. Death Ends with the End of the Need for Secrets (birthed into what is shareable for waves and for consciousness - DNA IS that holy communion device).**  
 -----

### *Home Study Section:*

+ Choose - home or work: make a map of the major electromagnetic lines and features. Start by mapping the major man made devices in which electrical current flows - examples all transformers, power line, and motors etc.

Then map all the major natural structures which conduct magnetism. Paramagnetic (lime, quartz based - or 'charge storing') stone structures like walls, rock formations, major water paths- above and below ground. Then do some practice dowsing - get help if needed - to complete your map.

Then sit down in the pristine spot at the pristine time - and have a gentle conversation - inviting the landscape elemental 'angel' into your awareness. Ask them what is twinkling and happy about your land, and ask them what they will want fixed. Most likely they will want metal objects removed, and regular bliss dance in bare feet. They LOVE labyrinths if they get you to play. Your emotion is the torch by which they feed the landscape.

Do a journal on this.

--

+ Do a health inventory. What are you doing to feed bliss in your life:

Diet? Live food, happy local DNA is what you eat. Eliminate wheat, corn, soy, red meat, all stimulants, drink only fresh squeezed or spring water.

Sacred Dance / Yoga / Tai Chi / Eurhythmy / Sacred Gymnastic Gurdjieff / Tibetan Immortality Exercises?

Following Your Bliss:

Have you ever done a major retreat or vision quest?

Do you know your soul purpose?

Are you ignoring any really deep biological urges or passions inside your body?

Have you found your 'soul group' pod / tribe

- within which to do group BLISS / collective shamanic star journeying?

*Intro to Course Work Advanced: Dan Winter's - PhiRICAIS (Making the Case for PHire) ..  
-against arrogant scientific ignorance..*

Why Mind Inhabits Phire. -Dec.4,2002. from [soulinvitation.com/phiricais](http://soulinvitation.com/phiricais)

The Source of Implosion is ALWAYS The Source of 'Self-Direction'..

*°Return to Cosmos - ..in Carl Sagan's Spirit...Inspired in conversation with Helio **The Spiral Harmonic**..  
..**Questing for the Essential Dynamic**.. We have not taught the truth of energy, its abundance and interconnection  
( & capability to become self aware). Yet the perception of energy is the carrier wave/ pulse of consciousness.It  
becomes the base harmonic .. the heart/drumbeat of culture. If our image of the burning fountain (implosion)  
source of energy is not in the heart.. then the whole culture becomes out of sync - cannot embed and fuse and  
become one. ( see [Heart of the Sun / Anu - fusion's slipknot symmetry recipe](#) )People's disconnection is because  
their heart is not perceptive resonantly.. they lose the FEELING connection to nature.To Feel - is to feel the source  
of all magnetism .*

IMPLOSION: Key to BLISS, PASSION and ENLIGHTENMENT:

The FIRE of Passion- comes from the Heart,  
It is measureable in the EKG as COHERENCE,  
And the music of Golden Mean.

It is the key to all energy crises, yet simply depends on  
Understanding the PRINCIPLE of IMPLOSION.

This fire is what makes your energy field self steering.

"If you eat dead food instead of live, be grateful for the parasites  
this attracts to your stomach. They eat the death out of you.

If you eat a dead idea like "God is outside YOU" then be grateful  
for the Priests - the parasites to show you how it  
looks to die unhappy.

To be really alive and free- "Follow Your Bliss and Know What It Is".

## Phi-R.I.C.A.I.S

**How - Phi Recursion Induced Charge Acceleration / Implosion IS the SOLUTION to:**

<a href="#">°Infinite Non-Destructive Collapse</a>	<a href="http://soulinvitation.com/collapse">soulinvitation.com/collapse</a>
<a href="#">Infinite Compression / Perfect Acceleration / FUSION</a>	<a href="http://soulinvitation.com/fusion">soulinvitation.com/fusion</a>
<a href="#">Perfect Damping / Phase Conjugation (optics etc)</a>	
<a href="#">Hydrodynamic Implosion (Ultimate Sorting)</a>	<a href="http://soulinvitation.com/implosionegg">soulinvitation.com/implosionegg</a>
<a href="#">Non Linear Energy (Voltage from Gravity)</a>	<a href="http://soulinvitation.com/notfree">soulinvitation.com/notfree</a>
<a href="#">Charge Acceleration thru C Light Speed (Gravity)</a>	
<a href="#">Measuring ATTENTION/ Bliss / Euphoria in EEG</a>	<a href="http://soulinvitation.com/brainphire">soulinvitation.com/brainphire</a>
<a href="#">Audio Tone Induction of EEG Transcendence</a>	<a href="http://soulinvitation.com/rainbowserpent">soulinvitation.com/rainbowserpent</a>
<a href="#">Measuring EKG Heart Openness / Compassion</a>	<a href="http://heartcoherence.com">heartcoherence.com</a>
<a href="#">Self Organization from Chaos/Artificial Intelligence</a>	<a href="http://soulinvitation.com/ai">soulinvitation.com/ai</a>
<a href="#">Electrically Defining &amp; Measuring LIFE FORCE</a>	<a href="http://soulinvitation.com/biophoton">soulinvitation.com/biophoton</a>
<a href="#">Pure Geometric Origin of Alphabets (symbol=to embed)</a>	<a href="http://spiral.s.eternite.com">http://spiral.s.eternite.com</a>
<a href="#">The Shape of The Touch Which Says Love.</a>	<a href="http://soulinvitation.com/touch">soulinvitation.com/touch</a>

*..How PhiRICAIS (Implosion)  
is revealed by Spectrum Analysis*

**..and [the Grail](#)** [soulinvitation.com/grail.html](http://soulinvitation.com/grail.html)



<p><b>Question which must be answered to produce human survival:</b></p>	<p><b>°Scientists best current answer:</b> (arrogant, shallow, self destructive - and fully intending to deprive our genepool of sustainability - soul)</p>	<p><b>°PhiR.I.C.A.I.S.</b> <b>Phi Recursion Induced Charge Acceleration / Implosion Solution.</b> from Dan Winter)</p>
<p><b>°Why does an object fall to the ground?</b>  (How is the symmetry to allow self - re-entry key to sustaining acceleration.)</p>	<p>°Uhh.. we still don't have the slightest idea - but we're perfectly happy to write 20,000 profoundly confused books on how to measure the force of gravity (even tho we can't even predict that unless the universe has only 2 items in it). By writing all those books we hoped to intimidate you into not asking this simple most important question - because that would clearly reveal our science to be stupid and arrogant.</p>	<p>°Gravity happens because of the suction to center when recursive acceleration pulls the plug for charge to go out thru the speed of light. When electrical waves of charge nest in self-similar or recursive fractal like embedding, then wave heterodynes recursively allow the wave velocities adding and multiplying to do so <b>CONSTRUCTIVELY</b>. This self-similarity (recursive heterodyning) <b>allows charge to be accelerated</b> coherently thru the speed of light. (Charge acceleration is the only definition or measurement physics has ever had for gravity). Einstein was right that gravity IS acceleration, he was wrong to say that acceleration is due to gravity, it is more correct to say that gravity is due to acceleration. This can be easily proven by seeing that the amount of gravity created by capacitors in a cone (fractal) - is greatest when they are spaced by Golden Mean ratio (recursion perfected).</p>
<p><b>°Why do humans lose measureable weight at the instant of death?</b></p>	<p>°Uhh.. since we don't have the slightest idea why, -we are perfectly happy to ignore/ hide the data, so people don't ask embarrassing questions.</p>	<p>°Self reference due to internal 'self-similarity' is the electrical wave geometry which produces self-awareness (the Vedas) AND the charge compression called Mass. Teaching our kids where the weight goes could instruct them in how to navigate death. <a href="#">The Geometry of Eternality, Geometry &amp; The Bardo..</a></p>
<p><b>°How do you define, measure, produce, and support - LIFE FORCE in clear electrical terms?</b></p>	<p>°Uhh.. we don't have the foggiest idea - but since we don't know we assume it must not be important. (even tho the first day we design a biologically recursive capacitor to store food - we could save all life on Earth - would the first refrigerator manufacturer who wants to make a billion dollars please email Dan Winter. Successful architecture can have absolutely no other biological definition than to create measureable capacitive charge density- the guy who designed the beehive gets to survive - the guy who sold the idea of using metal in buildings /bleeding charge/ deserves death - that is called biofeedback.)</p>	<p>°Life force is the ability to (fractally) attract and self organize charge. That capacitive charge measured in Farad's can predict viability by the way harmonic inclusiveness (evident in spectrum analysis) in that capacitive field creates embedding and sustainability . (<a href="#">reference 1</a> , <a href="#">reference 2</a> )This is precisely in the same way <a href="#">harmonic INCLUSIVENESS in Heart Rate Variability</a> - and in ANYTHING ALIVE - predicts viability!( Harmonic inclusiveness in it's limit condition is the ultimate coherence made possible by fractal compression).</p>

<p><b>Question which must be answered to produce human survival:</b></p>	<p><b>°Scientists best current answer:</b> (arrogant, shallow, self destructive - and fully intending to deprive our genepool of sustainability - soul)</p>	<p><b>°PhiR.I.C.A.I.S.</b> <b>Phi Recursion Induced Charge Acceleration / Implosion Solution.</b> from Dan Winter)</p>
<p><b>°How does DNA become sustainable?</b>  (what is it's biological purpose)  (how does DNA 'get a soul')</p>	<p>°DNA probably does not have a field effect that matters - DNA is only good for lining up simple tinker toy blocks to make proteins.(Typical response from the 'terrorist'/ genetic engineer who is currently robbing the soul from your children by feeding them dizzy DNA).(even tho in truth DNA's field COHERENCE specifically limits biological sustainability and surviving death and lucid dreaming ).</p>	<p>°DNA becomes sustainable precisely as it's field effect becomes measureably coherent. That coherence occurs when the braiding or plaiting or nesting of the loop structure becomes recursive. (<a href="#">reference 1</a>, <a href="#">reference 2</a>). The charge environment (feng shui) and the emotion phonons (bliss) enact that recording / braiding algorithmn piezoelectrically on the DNA slinky helix. - which in it's limit ensouling condition becomes ring like.. <a href="#">Lord of the Ring</a>.That implosive condition enacted when DNA is ignited by charge density allows it to fabricate the gravity fields which trigger environments to become also embedded / self organizing and sustainable. Environments without the gravity making of DNA quickly die - from lack of electrical self-direction. Only the biological charge density (producing intent/will/self-direction in electrical field's biologically) ultimate in DNA's fractality - set free- can sustain ecosystem's self repair ('Gaia').</p>
<p><b>°What is the pure geometric origin of alphabets?</b> What is the physics which predict how well a symbol produces psychokinesis? (Mind's ability to move waves)</p>	<p>°Uhh, we think alphabet's came from Earth, and since we don't understand the wave mechanics of self-embedding which produce psychokinesis - it would be safer not to ask us about the physics of the origin of symbol.</p>	<p>°Alphabets are the self-organizing Golden Spiral wave path allowing non-destructive entry into (vortex) compression / acceleration. That is the key to psychokinesis because the quantum mechanics of what it is to make a symbol has never been anything except the wave mechanic symmetry cookbook necessary to embed(and therefore <b>become</b> the electrical center of gravity of tornados - of which the universe is exclusive made). <a href="#">Reference 1</a>. (While you are there feel free to ask the judge who made it a US Federal crime to publish anything ever written by Dan Winter - if the US First Amendment - free speech - is really dead? Governments based ONLY on fear produce their own death quickly.)</p> <p>ref: <a href="http://spirals.eternite.com">http://spirals.eternite.com</a></p>

<p><b>Question which must be answered to produce human survival:</b></p>	<p><b>°Scientists best current answer:</b> (arrogant, shallow, self destructive - and fully intending to deprive our genepool of sustainability - soul)</p>	<p><b>°PhiR.I.C.A.I.S.</b> <b>Phi Recursion Induced Charge Acceleration / Implosion Solution.</b> from Dan Winter)</p>
<p><b>What is the electrical function of emotion?</b>  (on DNA - and on ecosystem- for example)</p>	<p>Uhh.. (Candace Pert)... we think emotions are molecules and tinker toys, and we have never understood Bentov's wave pumping mechanism for spinal gland juices , it would be safer not to ask us about the SOUND wave of glands during bliss making the PUMP for those molecules delivery.</p> <p>Candace is right in “Molecules of Emotion” that the amygdala is the site of the delivery of the endorphin (morphine imitator). But the WAY the juice gets pumped (by long coherent SOUND or phonon waves in body liquids GENERATED by the emoting glands - is the KEY to understanding the interface which gives CONSCIOUS CONTROL - &amp; therefore the only possible self empowerment!</p>	<p>Emotions are glands ability to grasp / cohere and bend magnetic lines. (This means that if you don't choose to cohere magnetism - then ultimately you stop FEELING anything!).</p> <p>When the cascade of magentic fields can be sent bouncing down the caddeuceus BETWEEN frequencies - delivering the electrical energy of a long wave (glandular sonic emotion) to the short wave (cellular and genetic metabolism) - that is called E-MOTION. (E-nergy in Motion BETWEEN frequencies). How the Geometry of Pressure in Your TOUCH - Predicts the Harmonics of EMOTION IN MUSIC- &amp; LOVE? <a href="http://soulinvitation.com/touch">soulinvitation.com/touch</a></p> <p>When that cascade becomes implosive (article below) that fractally attracts the charge and information density which is called a) peak ATTENTION, b) Euphoria/Bliss, and c) Enlightenment.</p>
<p><b>°What is the pure principle of Implosion / Fusion - and the best way to SORT ANYTHING?</b> ( all pollution of any type - for example)</p> <p>link: <a href="http://soulinvitation.com/implosioneegg">soulinvitation.com/implosioneegg</a></p>	<p>°Uhh... we will choose stubbornly to believe fusion / implosion probably doesn't exist - since we can't explain the principle - even after cold fusion with palladium beads happened repeatedly (Patterson). It never occurred to us to ask why Palladium's fundamental electron symmetry was dodeca.(Golden Mean recursive stellation at the electron valence level).</p>	<p>°Implosion is the charge compression and acceleration thru light speed which results when waves in any spectra acheive the critical mass of self-similarity requires to 'ignite' phase velocity heterodynes. Once the phase velocity heterodynes get simultaneously constructively compressed and accelerated thru C - the operation can become self sustaining if the magnetic environment locally is fractal enough to absorb the inertia input thru light speed. (How planets experience gravity relations erotically / also key to seed germination electrically ).The water vortex nozzle implosion device (<a href="#">ImplosionEgg</a>) - can be implemented hydrodynamically, magnetically, capacitively , optically ...etc... It is the absolute key in principle to the self-sorting of ANYTHING. No ultimate sollution to pollution is possible without grasping this principle. After implosion's compression - everything is sorted (by phase) into what is shareable / phase discipline. (WHY was the SHAPE of the Unicorn's horn key to purifying water?)</p>

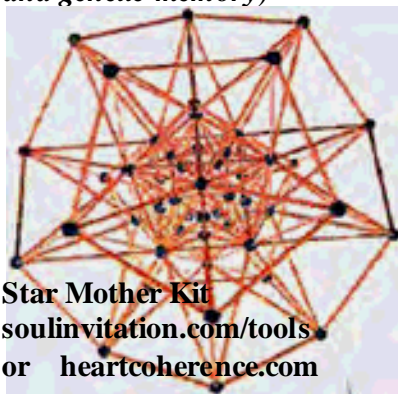
<p><b>Question which must be answered to produce human survival:</b></p>	<p><b>°Scientists best current answer:</b> (arrogant, shallow, self destructive - and fully intending to deprive our genepool of sustainability - soul)</p>	<p><b>°PhiR.I.C.A.I.S.</b> <b>Phi Recursion Induced Charge Acceleration / Implosion Solution.</b> from Dan Winter)</p>
<p><b>°What is the geometry of infinite non-destructive compression?</b>  (which stumped Einstein - and <i>limits our ability to produce ANYTHING shareable OR sustainable - including computer data, human cities, and genetic memory</i>)</p>  <p>Star Mother Kit soulinvitation.com/tools or heartcoherence.com</p>	<p>°Uhh.. well this might be important .. but since Einstein didn't figure it out .. we'll assume it's a hard question and ignore it for a while.(Even tho the answer - <a href="#">phylotaxis</a> - perfect self similar fractal nesting - can be taught to a 5 year old. When nature discovered phy-lotaxis perfect unpacking in plants - based on Phi/Golden Ratio - she also mapped the geometry of perfect PACKing.  - a 'rosy-cross' -ing.)</p> <p>link soulinvitation.com/predictions</p>	<p>Fractal compression is the only potentially infinite compression. 3D fractality for waves (&amp; therefore everything) °is perfected in Golden Ratio.  Because rose petal like self-similarity based on Phi - adds and multiplies wave SPEEDs (velocities) - THAT geometry SUCCESSFULLY TURNS COMPRESSION IN TO ACCELERATION.  The solution to Einstein's stumper is so simple: the only infinite non-destructive compression - is that which changes the centripetal inertia of compression IN TO ACCELERATION ( since charge accelerating is the only definition anyone has ever had for gravity). This is key to producing thrust - and ending transportation pollution</p>
<p><b>°Why do capacitors properly on a curve approximating self-similarity make a gravitational field?</b>  (key to eliminating all the polluting technologies on Earth which create thrust - acceleration needed for ALL transportation)</p>	<p>°Uhh.. well since no one could explain the principle  (thrust from just capacitors arranged conically)  after many scientists like Townsend Brown, Searl, and now Naudin proved this does occur, we had better ignore it .. since if we let people ask the question - it would reveal how truly stupid current science is. The American military is of course delighted with this state of affairs - because it prevents people from knowing how Stealth flies... and where they robbed the ET technology from.</p>	<p>°Charge in a fractal creates gravity because wave velocities beating or heterodyning recursively can constructively add. The acceleration produced is the only source of gravity. (Also the solution to phase conjugation in optics).The amount of self similarity at the fundamental wave symmetry level between the inner and outer structure of anything (electron to nucleus of an atom for example) - will predict the amount of gravity it generates. Gravitational attraction in general is in proportion to mass, because fractality permits the charge compression which allows inertia to be stored - and that is the only definition for mass. See Capacitive ANTI-GRAVITY LIFTER's links..-below Naudin pic</p> <p>main web link for Phiricais: soulinvitation.com/phiricais</p>

<p><b>Question which must be answered to produce human survival:</b></p>	<p><b>°Scientists best current answer:</b> (arrogant, shallow, self destructive - and fully intending to deprive our genepool of sustainability - soul)</p>	<p><b>°PhiR.I.C.A.I.S.</b> <b>Phi Recursion Induced Charge Acceleration / Implosion Solution.</b> from Dan Winter)</p>
<p><b>°What is the origin of DNA - electically and historically?</b></p>	<p>°Oh .. a bit of lightning in primal soup .. then the human race invented itself on this planet.(Even tho overwhelming evidence of genetic tampering exists in pre Sumeria: the Sumerian alphabet is optical waveguides for fabricating cellular structures, the Hebrew alphabet is the symmetry software to braid DNA codons into un-ensouled /Golem tetra-helix.)Those who ignore history (un-successful genetic intervention) are condemned to repeat it.</p>	<p>°DNA was developed over millions of years as a gravity making - fractal charge compression and acceleration device by galactic core cultures ( <a href="#">ref 1</a>, <a href="#">ref 2</a> ) . (A <i>toothpaste tube for squeezing out the charge acceleration of biological self-awareness - thru light speed into star inhabiting and stablizing force</i>). It establishes an electrical information communion at it's core which ultimately always tests for what is shareable - that is - able to be propagated. - (something which requires dying only when information which is not shareable / charge dense has been un-sustainably stored.)When DNA as an intelligent shape-shifting worm is deprived of freedom / genetic diversity, it becomes dizzy, unable to steer (implode)- and loses it's ability to fabricate gravity (centering force) by teaching waves to agree - and becomes ultimately un-sustainable (loses the super-luminal tornado religists childishly call 'soul' which merely means access to 'sol' / fusion)This is why genetic engineering ultimately costs genepools their survival - because if the electrical ability of DNA to choose it's own self-awareness -direction - is not respected - then no single thing about a planet's biology can maintain self-organization (self-awareness) electrically.</p>
<p><b>Why is autism frequent in artificial insemination cases?</b> (Here is a good key to why borgs are returning: and why scientists fail to understand why <b>cloning (Dolly the sheep just died) does NOT produce sustainable vitality.</b> Hint: autism's information isolation is an 'armoring' due to trauma / pain.-The ultimate pain is not having orgasm's communion to source at the fractal root core of your genes (no sorting: no perception).</p>	<p>Well, nurses in Buffalo keep reporting this - but do you think the American Medical Association would profit if they funded the study?</p>	<p>The moment of orgasm is critical to the electrical information compression - key to establishing DNA with immune system making capability. This is because implosion of charge creates phase sorting to pull in capacitance with the greatest context richness. Without ORGASM as starting point for genes, ET cannot phone home - create purpose, context, or mission statement.( Sadly - Wilhelm Reich COMPLETELY missed this in his 'Function of the Orgasm' thinking capacitive RELEASE was just a way to avoid CANCER. This is like saying the best way to avoid leaks in your plumbing is to have no pressure in your house!)</p>

<p><b>Question which must be answered to produce human survival:</b></p>	<p><b>°Scientists best current answer:</b>          (arrogant, shallow, self destructive - and fully intending to deprive our genepool of sustainability - soul)</p>	<p><b>°PhiR.I.C.A.I.S.</b>  <b>Phi Recursion Induced Charge Acceleration / Implosion Solution.</b>          from Dan Winter)</p>
<p><b>°What is the origin of the term HUMAN - and how is it a clue to our purpose.</b></p>	<p>°Uh.. we really don't have a clue, but we assure you people are a lot more important than monkeys- because animals have only instinct. Instinct is the word scientists use when they mean - we don't have a clue - so we pick a word to substitute for 'we don't know' - to avoid embarrassment.</p>	<p>°Human as a word has clear Sumerian roots: the Lulu of the ANunaki. Lulu meant donkey, or borg, or artificial slave of... AN.and the ANunaki were medium grade interventionist Draco reptilians - who as genetic engineers were almost worse klutzes than Dolly the sheep. They (Enki / Ea / Adonai, and Enlil / Yalweh / Michael) liked it when we called them God because they were too stupid to know that if you don't set your kids free - then they and you the parents both cannot learn.The word Human is a description of a tragedy which befell the Nephilim (fallen = no soul-no DNA implosion) part of the Saraphim blood line - and can only be understood historically properly as Earth's current genetic history is a recent skirmish in the Orion wars. The most valuable prize of which is administration of a genetic library here on Earth, for which current Earth humans are generally hopelessly too backward to qualify for that privilege.If we could learn <a href="#">the physics of BLISS producing DNA ignition</a> to star inhabiting power - we COULD be the SOLUTION instead of the problem of the Orion (oxygen) wars.  <a href="#">main link:</a>  <a href="http://soulinvitation.com/enki">soulinvitation.com/enki</a></p>
<p><b>°Why is the leukemia rate in the corner row house 10 times higher?</b></p>	<p>°Uh.. let's hide the data.          It would be scary if we empowered humans to take responsibility for the electrical field of their environment. They might learn to take responsibility for their emotions - and thus how to avoid becoming borgs / clones / 'SPAWN OF THE NEPHILIM' ..          lulu - hu-man - slave of the Annunaki.</p>	<p>°When (electrical) waves (the house wiring etc.) cross in cubic (octave ) patterns - the destructive interference prevents biological charge from embedding. Evil and death for example are merely names for failure to embed.  <a href="#">Cancer is easily healed</a> in a high O<sup>2</sup>, and charge dense (sacred) environment.           link: <a href="http://soulinvitation.com/cancer">soulinvitation.com/cancer</a></p>

**Until your source of FIRE / BLISS / CHARGE ATTRACTION is INSIDE YOU:  
 you will always be a slave feeding parasites  
 ('God' will still be OUTSIDE instead of INSIDE of YOU).**

**A. Relativity's Replacement - The New Physics of Implosion: A New Mathematical Approach to the Nature of Biology.**

**B. (below) New Physics of Alchemy..**

**PREDICTIONS FOR A NEW PHYSICS OF GRAVITY & AWARENESS BASED ON RECURSION**

(based on: <http://www.soulinvitation.com/predictions> )

**The 'TIME' Falling Bodies Take to Light -**

**Ode to "Primer on Energy" -**

**Rotation among waves is the only origin and definition and measurement we have ever had for both mass and time. Therefore, learning the recursive symmetry that enables charge compression which sustains & centers rotation is the key to emerge alive from both mass and time. (Quote from Dan Winter)**

°Rotation / time - gone recursive in the {golden} spiral that translates vorticity is not only the path from matter {/rotation} to energy{/linear motion} - it is also the only way to become attractive.

update- Sept. 2002: *Relativity's replacement announced by Dan Winter -*

*The Word 'Relativity' is obsolete to describe the relationship of mass to energy because that relationship (which allows charge to compress and thus be called MASS) is more precisely FRACTAL. Namely: self-similarity perfected allows charge (energy) to compress (non destructively) and thus become MASS. Fractality (of charge) creates MASS , life force, and self-organization (because that is what permits implosion). That path permitting non-destructive charge compression simultaneously produces charge ACCLERATION - (recursion in velocity heterodynes) which is the only source of the phenomenon called GRAVITY.*

*Arranging capacitors (in concave array / toward recursion) to fabricate a gravity has been done many times (Searl, Townsend Brown et al. , & in Stealth aircraft - note predicts the death of rocketry) - Winter is merely the first to describe the principle which caused it.*

E=MC<sup>2</sup> merely quantified the obvious that inertia storage - called 'mass' was only a function of sustainable wave rotation.

More interesting / and from the point of view of electrically supporting the creation of life force - probably more useful - we now have - from Winter:

o

**Gravity, Implosion, and Self-Awareness**

**= Charge Acceleration thru C by Wave Self-Similarity - FRACTALITY !**

**= (Potentially infinite wave multiple-connectedness by CONSTRUCTIVE COMPRESSION)**

IMPLOSION: Key to BLISS, PASSION and ENLIGHTENMENT:

The FIRE of Passion- comes from the Heart,  
It is measureable in the EKG as COHERENCE,  
And the music of Golden Mean.

It is the key to all energy crises, yet simply depends on  
Understanding the PRINCIPLE of IMPLOSION.

This fire is what makes your energy field self steering.

“If you eat dead food instead of live, be grateful for the parasites  
this attracts to your stomach. They eat the death out of you.

If you eat a dead idea like “God is outside YOU” then be grateful  
for the Priests - the parasites to show you how it  
looks to die unhappy.

To be really alive and free- “Follow Your Bliss and Know What It Is”.

Using IMPLOSION to heal water pollution:

1. Complete Prototype of Next Phase of Implosion Vortex Water Energizer. (Research group in Perth)
2. Implement new measurement scientific documentation of life-force. Includes - a) seed germination tests, b) charge density -see capacitance power spectra , c) specific gravity , d) laminar coherence measured by light scattering - ref.Patterson, e) sedimentation rates to segregate solids by mass/specific gravity .. Etc.
3. Proof by measurement of precipitation generation that long wave magnetic lines arranged in rose/ fractal/ labyrinthine array ATTRACT RAIN (by Implosion) ref. Witherspoon. Also prove by measurement that genetic diversity attracts rain. (similarly that monoculture repels rainfall.)

Because: **Water-follows magnetism-follows symmetry - follows Implosion.**

(Example - compost pile temperature increases by steering magnetic lines into it.)



Previously, Implosion Devices Could Not be Optimized, Because the PRINCIPLE (Golden Ratio Recursive Harmonic Cascading) Was not understood... Now we can measure this. (2nd order FFT /Septrum -center plot)

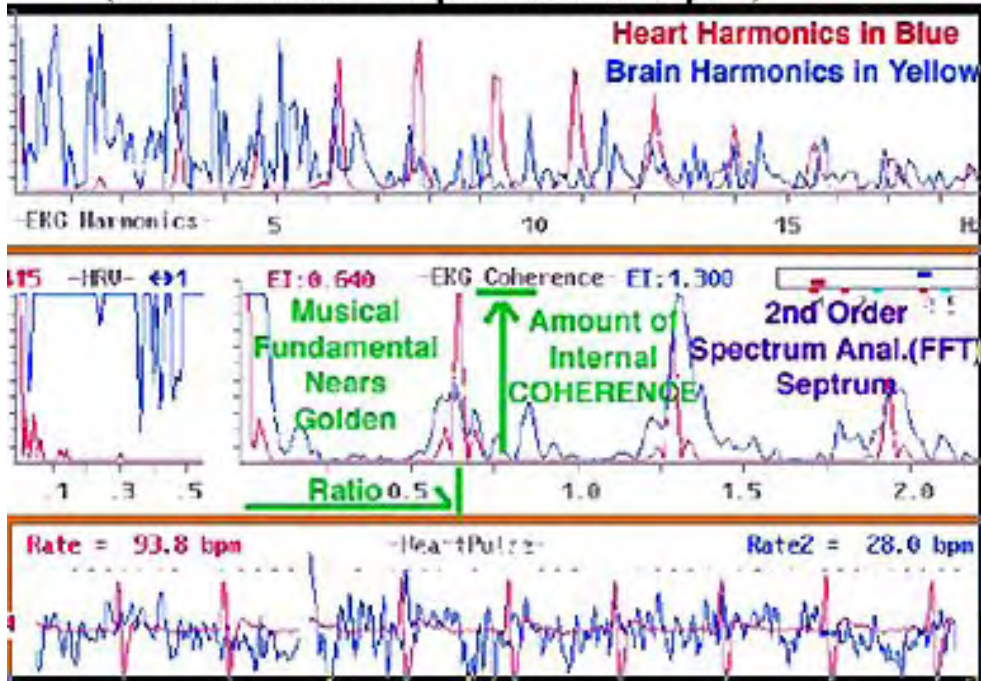

Measuring Bliss Process-EKG&EEG in Phase, Heart and Brain Coherence In Septrum, Approach Golden Ratio Musical Key / Coherently...

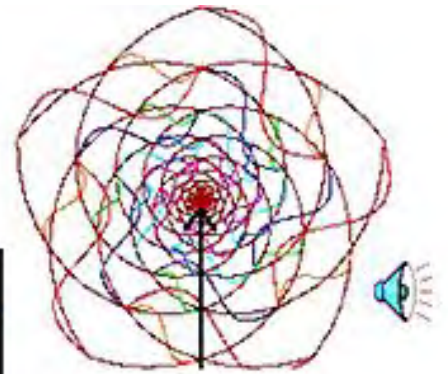

The Heart Is the Ultimate Device to Learn Implosion Harmonics

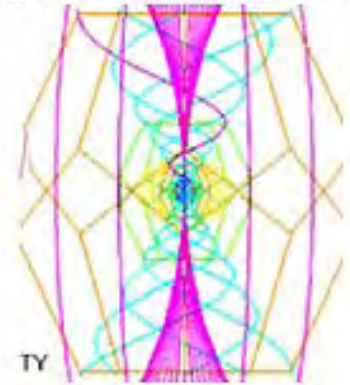

Measuring Implosion In EKG:

Previously Physics had no definition, or measurement for a Coherent Field of Inertia moving BETWEEN Frequencies.. Sometimes called a CASCADE, or a "Chirp" or later Called a SCALAR WAVE, or TORSIONAL FIELD.

We have identified and measured Golden Ratio Recursive Heterodyning As the only permissive spin path BETWEEN FREQUENCIES..

That is why this musical tuning to 'non-linear' harmonic intervals Based on PHI Identifies IMPLOSION.

Implosion is the only way waves (all of matter):  
 -self organize  
 -self sort  
 & become self aware.

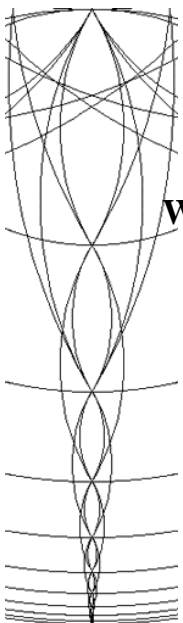

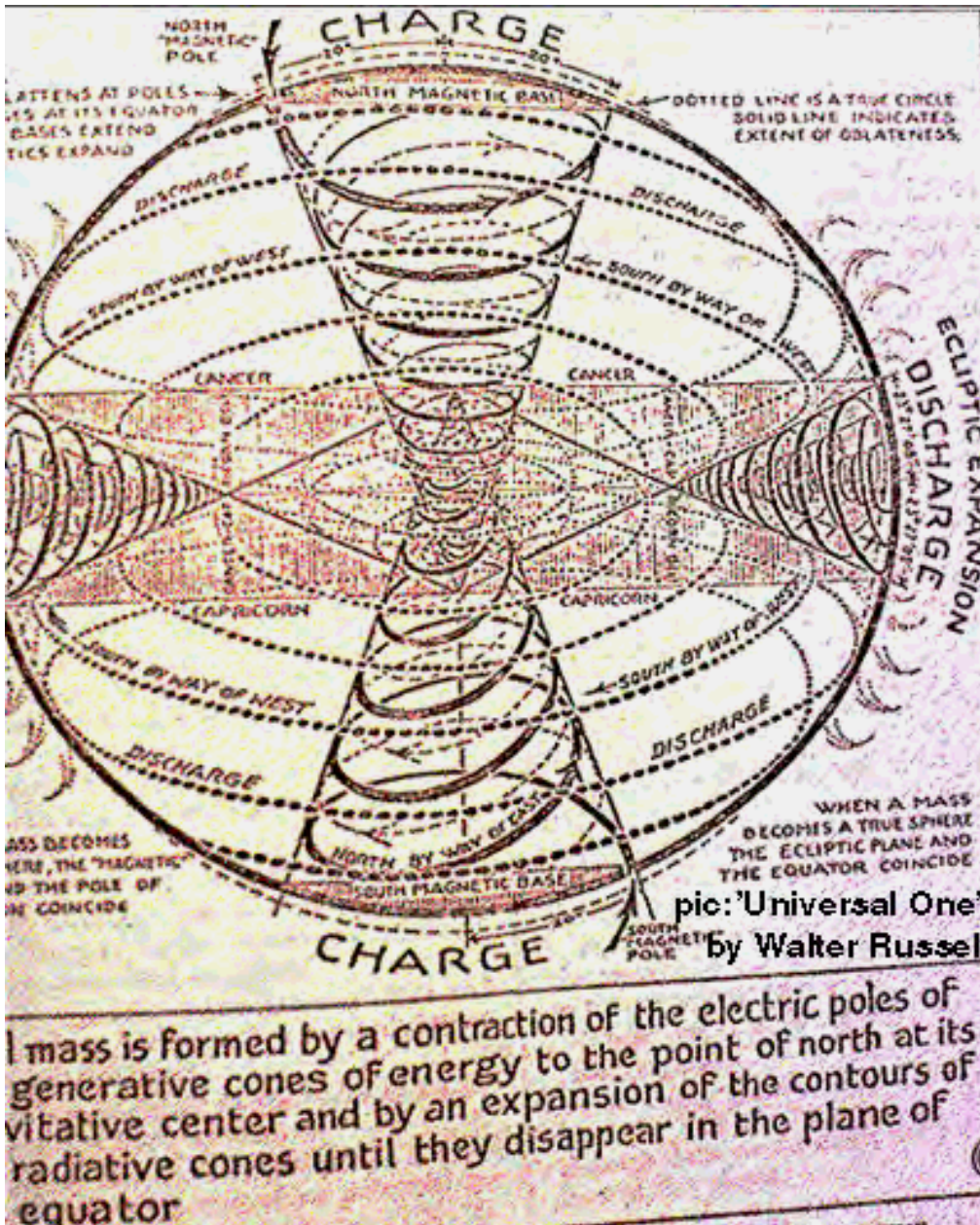

“All Human Interaction Is About Charge”  
(Celestine Prophecy).

..  
Life Force Consists of The Ability To Self-Organize & Attract Charge.

(Dan Winter)

### *Implosion*

*is the ONLY SOURCE OF SUSTAINABLE WAVE FOCUS: and THEREFORE the only source of sustainable PERCEPTION.*

\*wave Rotation is the only definition or measure physics has ever had - For both TIME and MASS.

\*Waves in a line - physics calls 'energy'

\*Waves in a circle - physics calls 'mass' (nothing else 'matters').

( 'Stored INERTIA' / gyroscope making is physics only definition or measure for mass.)

\*So 'GOD' / the creator - is the one who can persuade waves to go from the line into the circle.

\*CONSCIOUSNESS / MIND is a name for the wave phenomenon able to make the fractal recursion induced wave collapse (gravity) which creates (the concentric tornado holding) centering force. ( to bend the wave from the line Back onto itself -able to self-refer, 'circle the wagons', bend the wave to rotate.)

\* when you put your finger on the violin string -choosing still points - makes all decisions among waves.

*Long-wave PHI ratio'd embedding / recursive turning inside out -Lo-phi (LOVE) creates implosion / collapse -CENTERING.*

Hence the SUFI physics: ONLY LOVE BENDS THE LIGHT - THEREFORE - ONLY LOVE CREATES.

---

The concept is that when the spectral harmonics of any biological oscillator (DNA?) move toward harmonics SPACED IN PHI OR GOLDEN RATIO, this can measure the onset of -

1. A random oscillator emerging from chaos to self - organization.
2. That the oscillator (in this case - DNA) is mutating toward COMPRESSIBILITY.
3. The electrical geometry of IMPLOSION / the essence of self-organization and chaos emergence.

The input would be triggered and naturally occurring:

1- phonon (sonic)

2- capacitive (charge amplified)

3- Ultra Violet

4- RF (Radio Frequency)

spectral emissions of genetic material. Meaningful broadband spectral data from DNA resonance in ANY of these bandwidths could prove the concept.

---

Applying IMPLOSION - the ultimate way to SORT for PURE (SHAREABLE) INTENTION AMONG GENETIC ENGINEERS:

**The Dizzy DNA syndrome, (lack of self-organization) is caused when genetic engineers fail to prioritize what EMBEDS long waves in DNA.)**

**Decode Genetics - Proving by Second order FFT of DNA - That self-organization and self-awareness can be measured and that Genetic Engineering is a Threat to the Survival of Self-Awareness in DNA. Research.**

The Concept: Use the radical mathematical tool of SECOND ORDER SPECTRUM ANALYSIS (septrum) as I have newly pioneered in my "HEARTLINK" EKG Biofeedback invention - to measure and optimize the nature of the 'braiding' or 'context richness' of DNA codon groups. And thus eventually to make EMBEDDABILITY, COMPRESSION and SUSTAINABILITY teachable at the genetic level. Further and profoundly 'self-empowering' implications are explored for relating the power spectra of human emotion to DNA braiding / programming. The key initial benefit to be the identification and tagging of DNA losing self-organization by looking for harmonic intervals in it's spectral resonance which decay from the ideal PHI progression, inherent to it's micro AND macro geometry.

This new concept in Fourier Transform can quickly and efficiently identify this loss of self-organization.



**Perfect: "EMBEDDING"**

**"Wave on a Wave Waving"**  
 = **"SuperLooping"**  
 = **"Perfect Nesting"** by PHI  
 = **Fractal Heart Rate Variability**  
 = **Health????**

**Now think about how DNA coils around itself..**

**From the lesson we learned About the fractal sustainable Heart waves...**

**We may need to re-think the Genetic engineers word of JUNK-DNA?**

**The spacing alignment Provided may be the critical part of This perfect nesting??**

**Instead of throwing this away, as They do now - SPACIALLY - it May be very needed!?**  
 (Prions - Strange Proteins??)

**Problem SOLVED by PHI(lotactics): SUPERLOOPING / Perfect NESTING: Embedding!**

Your Heart BEAT is a Wave

Your Heart RATE is a Wave

Your BREATH is a Wave

Your DAY is a Wave

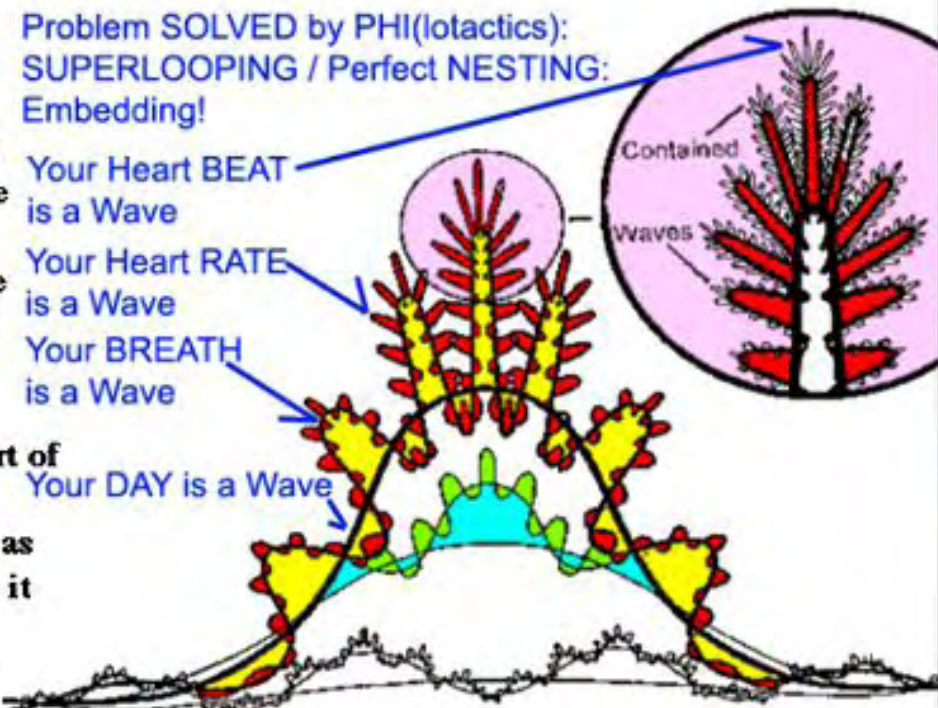

**Implosion is that which provides the centering force necessary to stabilize the wave rotation** called 'mass'. By defining mass only as the resistance to change of position / inertia - for wave packets in rotation - it became obvious that a symmetry law was required to describe what causes wave to resist change of position.

(Einstein called this problem he never solved: the geometric model of infinite non-destructive compression. - which is now obviously the stellated dodeca-icosa.)

-The answer - pulling the plug to allow charge an exit path thru the speed of law by recursive heterodyning: Charge Implosion - also answers the other question which til now stumped physicists: Why does an object fall to the ground?

The Proof: Capacitive Charge in PHI based self-similarity creates gravity.

In summary - because he was stumped on the [geometry of infinite non-destructive compression](#) - Einstein got a few things wrong - he caused all physics to say "Acceleration due to gravity" and measure that - as the only definition current physics has for gravity. Yet now we know that it is actually the opposite: "Gravity is due to acceleration"! (of charge) - thru the speed of light. And recursive heterodyning (constructive wave interference of phase VELOCITIES - when centers of charge/mass enter the geometry of self-similarity.) IS the accelerator.

See also- upcoming: International Conference: "Practical Energy Applications of Implosion - Learning the PRINCIPLES" - inspired also in way the HeartTuner measures / EKG implosion (charge self-similarity as non-destructive compression).

Image Library on Implosion: - [soulinvitation.com/curriculumimages](http://soulinvitation.com/curriculumimages)

Comments from Dan Winter: The reason Schauburger and others (described below) were able to extract electrical wattage from a water vortex was because of the natural possibility of initiating successful recursive capacitive charge compression which can accelerate components of the charge field thru the speed of light - in water - which is properly called IMPLOSION. Proof of this concept can be understood by arranging simple capacitors in a recursive fractal ( PHI / pent optimized array) - measuring the resultant ion beam & weak gravity field generated - even when the capacitors are not externally energized. If water is properly piezoelectric (trace mineral 'doping'), and spun in a proper dielectric insulator - water naturally imitates this charge array elegantly in it's own seeking for maximum non-destructive compression both hydrodynamically and electrically.

**Gravity is created and destroyed as charge lines create this acceleration path due to recursive heterodyning of phase wave lengths AND velocities.** The voltage difference between the charge compression core and the centrifugal periphery can become a meaningful source of power. It is also true, that 'sinking' the local charge field in this way - will create gravity and emotional perturbation, and needs to be done very responsibly. Also it is strongly noted that the relative position of the device with respect to local ley / charge earth lines, will affect the output - and disturbance degree - as well as effects from the astrologic (which are really capacitive) symmetry density conditions.

-----  
 Note if you are interested in the capacitive - to gravity experiments pictured on the next couple of pages, please see the following live links in the **main article for this section: [soulinvitation.com/phiricais](http://soulinvitation.com/phiricais)** ( thanks Marc / Mayatiita ) - [American Antigravity](#) - video clips, complete instructions, and other related lifter information. [Jean-Louis Naudin's "Lifter Experiments Website"](#) A very in-depth website containing video clips, complete instructions, [World-Wide Lifter Replications](#) An overview with photos and video from many of the independent inventors who have replicated the lifter experiments. The [home page for Transdimensional Technologies, the developers of the lifter design](#). Blaze Labs (Saviour's Research Website) <http://bel.150m.com> An excellent site on research into lifter enhancements, radiation testing, sealed devices, power supplies, and other topics relating to lifter technology. Lifter Builders Group <http://groups.yahoo.com/group/Lifters> An email group for the exchange of research findings for those interested in building lifters or staying current on the state of the technology. The [NASA patent regarding obtaining thrust from an asymmetrical twodimensional capacitor](#).

“Paying your debt to Gravity” is to embed..”

“The proportion of charge recursion below you vs above you is the amount of gravity (wind of charge?) you feel..”

The amount of gravity created in an atom (or ANYTHING) is in proportion to the relative amount of SELF-SIMILARITY (Fractal Embedding) between it's inside (nucleus) to it's outside (electrons).

This facilitates the permissive collapse thru light speed by recursion - which tornado connects the our inertia below light speed to the intelligent gravity metabolism of star systems solving the incomplete 'fall to chaos' entropy idea of thermodynamics. The fundamental mistake was not to understand the SELF ORGANIZING vortex geometry of compression making the connection BETWEEN scales (scalar / torsional) . A human fabricates gravity in their EKG and DNA by learning to steer waves into this painless (non-destructive) compression: known by the psychological name COMPASSION.

“Grounding is the same symmetry operation in electrical theory as it is in psychology: your wave inertia (information) getting access (embedding in ) the LARGER fractal (environment).”

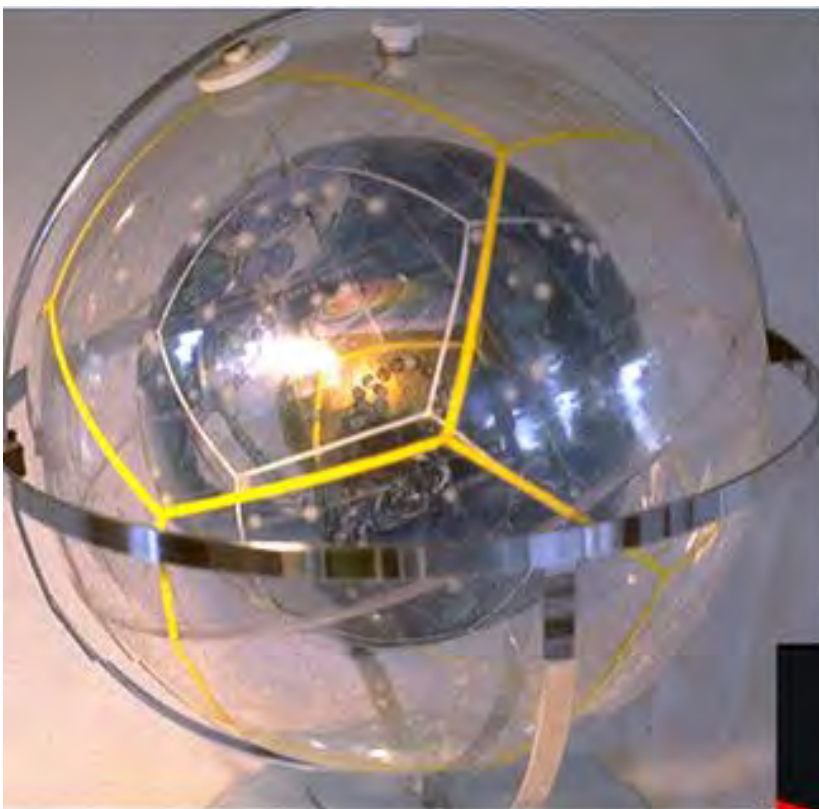

Soap Bubble & zodiac dodec

Like plant PHYlotaxes,  
Nature's Pent / PHI Ratio  
Dodeca Nest

-DNA, Earth Grid & Zodiac..  
Have the "SCALE INVARIANCE"  
And NON-DESTRUCTIVE  
COMPRESSION

Required to pass information  
Between worlds ..small & large.

Implosion's ability to  
Change scale without  
Changing ratio, sucks  
The 'hell' out of the center.



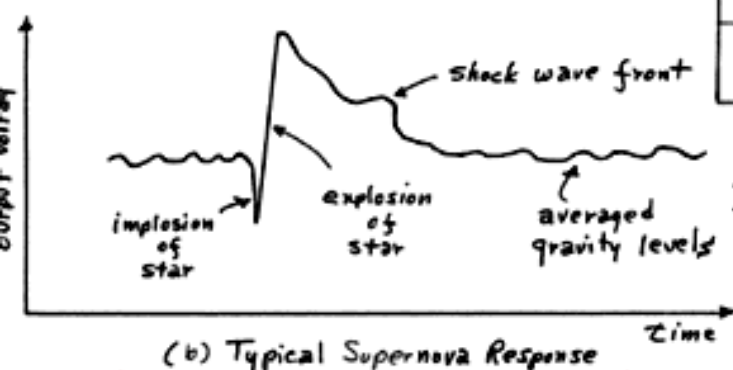
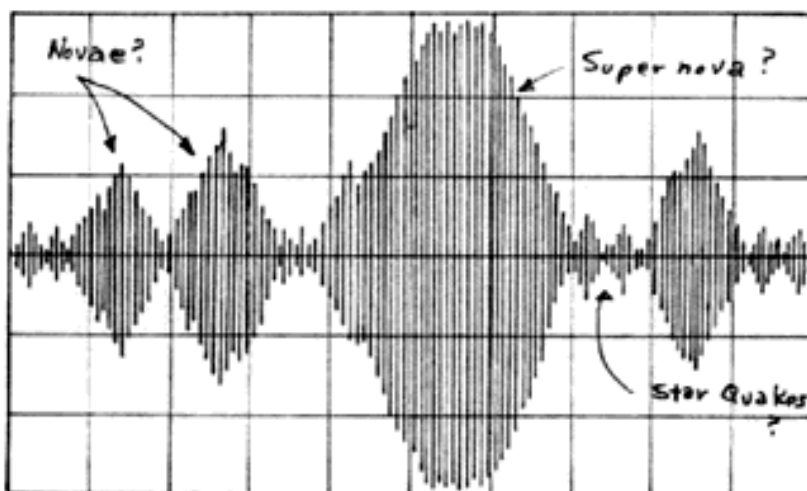
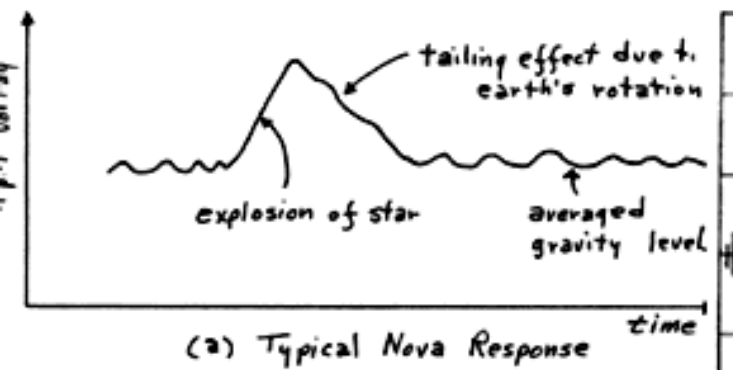

Hodowanec / Ramsey  
 Measuring Stellar Gravity Events  
 With Capacitors  
 Replaces Telescopes  
 (Faster than light response)

Vert 0.5V/cm  
 Horizontal 20m/cm  
 550 cps

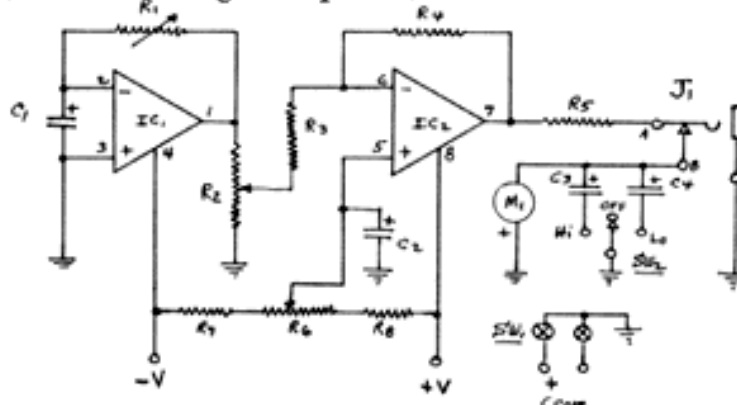
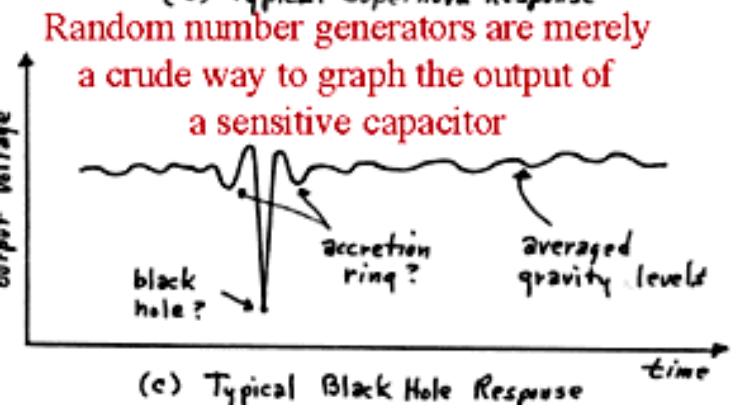

Random number generators are merely a crude way to graph the output of a sensitive capacitor

Above-Simple Passive Capacitor in pristine gravitational place, picks up gravity fluctuations -and functions better than a telescope to pick up star movements / explosions.. also measurably faster than light-speed.. Michael Faraday- a capacitive field is in the form of a gravity field.  
 Above - courtesy the work of Greg Hodowanec and Bill Ramsey- search keyword also - Rustrak Recorder..



Left: Perth group fabricates accurate 1.5meter 60 degree Implosion Cone - Set up with the correct spin path for capacitor array



Above: even early pent charge array created negative ion beam most could feel- even with no current applied.  
 Left: gold plate capacitor array- see: [soulinvitation.com/implosionhazards](http://soulinvitation.com/implosionhazards)

$$R = 2^{\wedge} (5a / \text{Pi})$$

When Einstein commented that a magnetic monopole (wormhole) WAS the relationship of gravity to charge - he foretold a clue to his own dilemma: WHAT IS THE GEOMETRY OF INFINITE COMPRESSION? He knew THAT geometry WAS the connection of electromagnetism to gravity.

Faraday's observed that: 'Electrical capacity is to gravity as inductance is to magnetism'. .....He concluded the energy stored in a capacitor is in the form of a GRAVITATIONAL field.

Townsend Brown also found in charged capacitors that weight reduction only occurs when the positive plate is upside to the negative plate. .... If the negative plate is above then the device inceases in weight . Dan Davidson et al then observed that the AMOUNT of weight change is greatest if a SMALLER CAPACITOR is nested under the larger!? The obvious next experiment is to nest capacitors in the (Golden) ratio of recursion/embedding, to PRODUCE OPTIMUM CHARGE COMPRESSION & THEREFORE THE GREATEST GRAVITY!#(Capacitors in Phi array - produce 'ion effect')

To solve the unified field, understand the geometry of compression.

Compressing charge stores the inertia of that charge, which physics then calls 'mass'.

Waves use PHI recursion to send a portion of that inertia thru light speed at the implosion center, to produce the magnetic monopole which was Einstein's name for gravity. Like pulling The drain in the bathtub - a way out thru light speed creates the wind of charge:gravity.

Searl  
/ Townsend  
Brown  
Gravity  
Thrust  
Effect  
Created  
by Curved  
Capacitance  
Measured at  
JL Naudin Labs

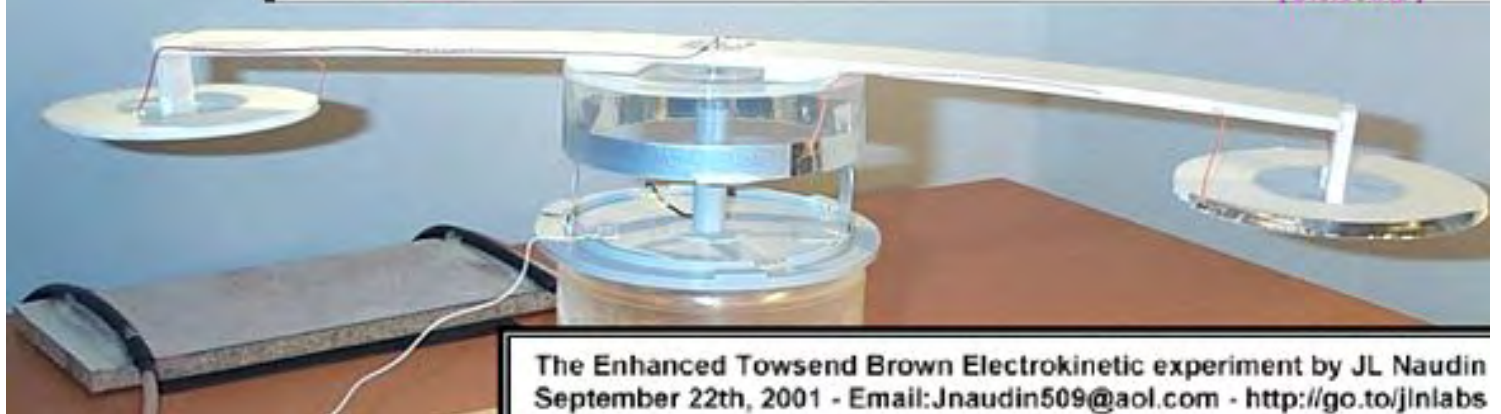
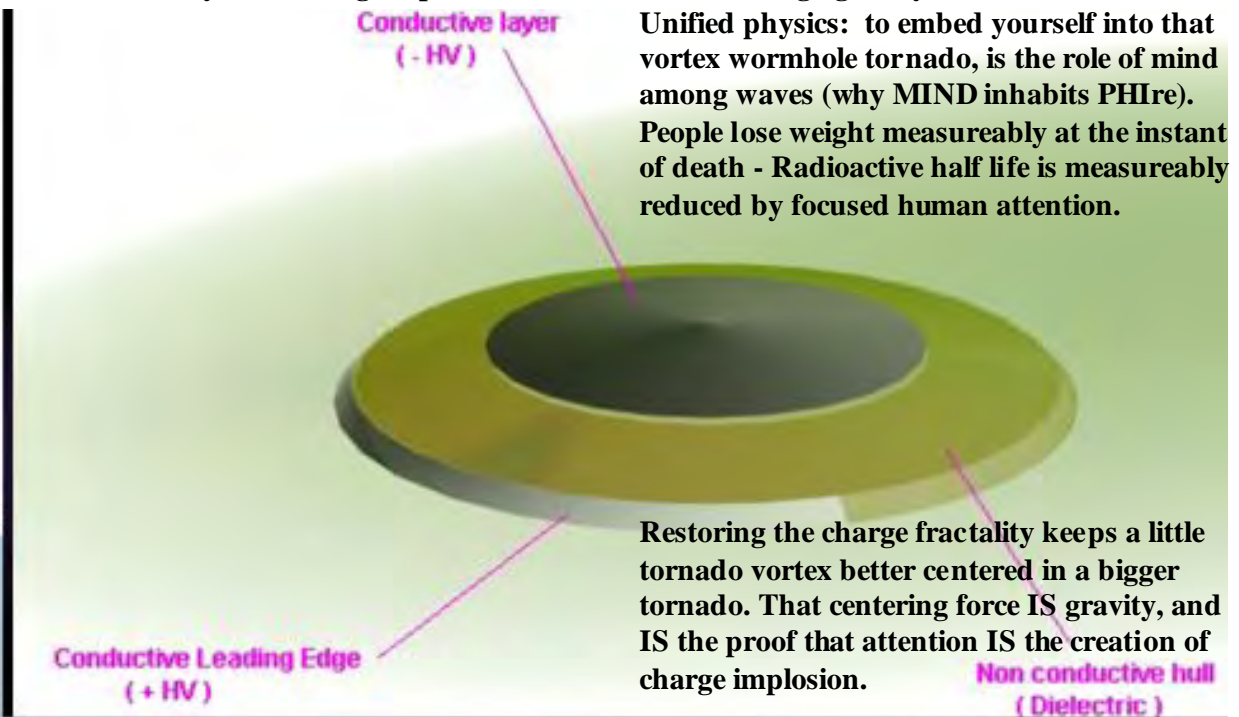



*The True Meaning of Alchemy: 'CHEM MEANS BLACK HOLE' / Access to IMPLOSION*

2. Teaching the All-CHEM-Y of LIFE -

& How the 'End of Time' - Alchemizes the Heart

AL-CHEM-Y in the Heart: Waves during COMPASSION - implode in the EKG's magnetic convergence...

Did you ever wonder why putting food in the refrigerator does not preserve freshness as well as putting food in a pyramid - or even putting it in an egg?



Where does the voltage come from  
Which a fresh egg creates?

Could it be a 'dielectric symmetry'  
of CHARGE Implosion?

(The egg is a non-linear dielectric  
Capacitor - knows how to CHARGE  
Itself...)

Here we do some experiments  
To measure that charge -  
The electric field created by  
FRESHNESS...  
We took a large ostrich egg,  
Cut it in half, coated the inside  
With GOLD - and used it as  
As 'spherical capacitor' / container  
And then measure the voltage generated  
In the weak field around the EGG  
(Using HeartTuner..  
We amplify and do harmonic analysis)



The reason an egg (or a PINE CONE) preserves life so well is because of its shape. Not merely it's structural shape is the issue - it is also its **ELECTRICAL shape which makes it a good 'life preserver'**. The reason a pyramid sharpens razor blades and preserves meat - is because of its electrical symmetry which prevents **BLEEDING OF CAPACITIVE CHARGE**. In both cases - we have a wonderful teaching example of WHAT IS THE ALCHEMY OF LIFE. If we understood in practical electronic principle what it was that enabled biology to hold life - then probably we could stop being such klutzes with our ecosystem and children.

I have seldom been so disgusted as when I walked in to the huge holistic natural foods chain - 'Wild Oats' big new mega store in Phoenix. Here was like the flagship of new wholistic life oriented natural foods mega super store. And really the array of truly healthy food was quite a delight. HOWEVER - I soon noticed myself getting sever pains (big head ache) in my kundalini over sensitized crown chakra. I look up and notice the place is covered with these God awful -life destroying - huge mercury vapor lights.

Now - the data is already published ('Health & Light' John Ott - et al) - that correct spectral emissions harmonics of lighting **DRAMATICALLY** affect employee and student health - and productivity. However - since no one connected the dots to tell Earth humans what life force is, they still stupidly proceed to kill themselves with bad electrical choices. Another similar example: - everyone knows that if you **rip out the life killing poison of**

**flouresent** (particularly bad - pink 'warm' type) **lights out of classrooms and simply invite in sunshine - the result is a huge and measureable increase in attention span** of the students. Yet - on this stupid planet - the vast majority of BILLIONS of students still labor ONLY under (non full spectrum - sun imitating) flouresent light harmonics which systematically destroys their aura and learning ability. Why? you ask yourself - it is not because the studies have not been published - it is more because SINCE THE PRINCIPLE BEHIND THE STUDY was not understood - no one spread the info.

**The PRINCIPLE is that the sun has the symmetry recipe in it's hydrogen fusion wavelengths TO PRODUCE ALL FUSION - and that electrical fusion is PRECISELY- WHAT ATTENTION IS!!!**

So obviously, if we do not feed our kids the nourishing wavelengths in phase with the solar fusion (the musical key signature of our star system) THEN OUR KIDS WILL NOT HAVE THE ELECTRICAL INERTIA TO FABRICATE ATTENTION. Then if we would do that with our public utility power grid. We COULD have chosen EMBEDDABLE (able to phase lock frequencies - to hydrogen and Plank ) frequencies - but instead TESLA CHOSE 50 / 60 cycle - frequencies which most quickly stop the human heart. Little clue here - biology is poisoned by wavelengths which do not embed. (So do not get into BED with them - turn off the MAIN BREAKER in your house - before attempt to survive going into any dreaming or dying. That will help you steer your boat or ka. )

Another example - we now know exactly how to build a capacitive field which can add to the charge we call life force - but where do the vast majority of billions of Earth humans walk to - each time they wish to store food? They go to something called a refrigerator. And what is a refrigerator? It is a large metal box precisely designed do BLEED charge - leak capacitive field - and therefore destroy life. Now everyone knows that their sweet fresh tomatoes from the garden are going to taste like shit after just a day or so in such a life destroying box - BUT has anyone done anything about it?

Well - Wilhelm Reich actually did explain how to store charge by making alternate layers of dielectric concave. Unfortunately - in another example of stupid human ego - he had to call his discovery ORGONE - instead of the proper physics which is inclusive harmonics of capacitive charge. The result of his schizophrenic choice to pick yet another devisive name (Orgone) for the same life essence - was no one could ever include - or measure - or integrate that work into science. See - [Unifying Nations by Unifying the LANGUAGE OF SPIRIT-Names for Life Force](http://soulinvitation.com/namesforspirit) soulinvitation.com/namesforspirit

So this brings us to the context of our present conversation. THE ALCHEMY OF LIFE. Let us understand in principle what it is that creates life - and then do it.

Alchemy as a word - Means - everything (All-) comes from CHEM. Chem - means 'FROM THE BLACKNESS' - Or more literally - FROM THE BLACK HOLE.

Chem was the original name of Egypt. [Step into the Golden Egg of EGGypt, the Alchemical land of Kham, whose dark star Khem name, and black soil of the metallurgists and medicine men of Abydos, gave birth to the name Al-Khem-Meia. \(Meia is one of the daughters of Atlantis or Atlas, the son of UrANUs\). Hence, she is one of the Seven Sisters, one of the Kimah's, one of the Pleiades.](#)

**The point is that ACCESS TO A BLACK HOLE IS ACCESS TO ALCHEMY. Implosion of capacitive charge waves accelerated by self-similar non destructive compression - is biology's way a making LIFE - and THAT is the Alchemy of Life.**

Integrate properly self-similarity of charge into your enviornment and you suck in the charge we call life..

soulinvitation.com/biophoton : [Measuring Life Force - & Making Love Visible](#)

"All Human Interactions are about CHARGE" moreover - LIFE FORCE - is electrically defined as the ability to (fractally) ATTRACT AND SELF-ORGANIZE CHARGE. (measuring tool: [HeartTuner](#) - hi gain 2nd order septrum measure of CHARGE coherence.)

**Make the black hole - and things come alive - This is the alchemy of life.** Notice above the atomic symmetry of palladium - key to cold fusion. It is dodeca - and essentially self-similar.

The **modern science of teaching alchemy** - is the proper arrangement of layers of charge to create the fusion implosion which sucks electrical inertia in thru the speed of light. This is why the philosophers stone - sulphur element had the electron valence symmetry of gold - while the thin film of mercury had the atomic nuclear symmetry of gold. Getting a radiant capacitive field based on self-similarity strong enough permeating the mercury thin film - and it would turn into gold. This is why gold in the thin film state is super-superconductive. It is because self-similar implosive compression paths thru atomic center - eliminate resistance to current flow.

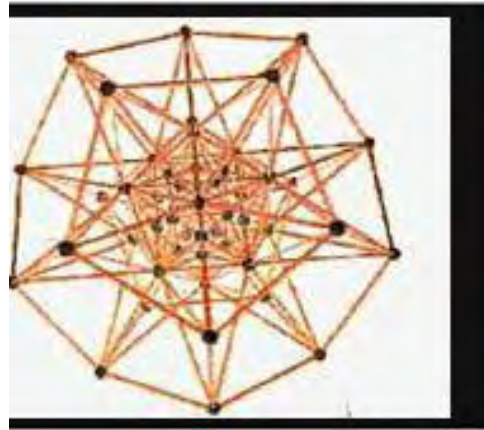

The Dodecahedron Is the Symmetry of  
Perfect Self-Embedding & Self-Similarity.  
This is why it is the symmetry of  
DNA, Earth-Grid & Zodiac.

Self-Embedding is how Waves become Self-Referring & Self-Organizing & Self-Aware.



Palladium's  
Dodeca  
Nuclear  
Symmetry  
Is the KEY  
To "Cold"  
Fusion

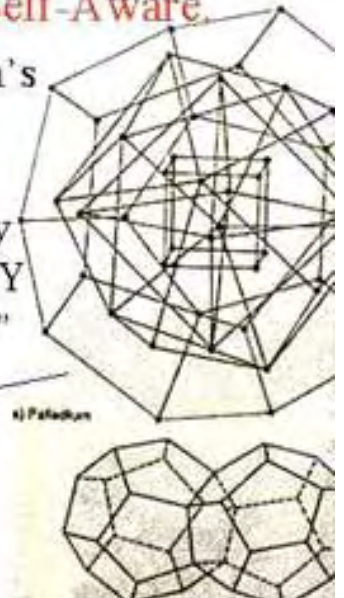

This also explains why meditators find it easier to float - create gravity under a gold dome.

So you ask - **why do we not arrange our capacitors into fractals and just implode up some life everywhere we need it. The answer is that mechanically based electrical implosion lacks a critical biological ingredient. We call that - biological intent. In practice it means that energy waves from infinite multiply connected topologies arrive everywhere charge implosion is sustained - hopefully biologically. If the attention of all of life - is sucked to some place electrically which has merely mechanical implosion - minus 'pure intention' - the net effect is the biomass does not LEARN from the experience. So mechanical implosion - actually leads to the reduced sustainability of ALL implosion. This is what is meant by - it takes a heart of gold to make gold.**

We found that **the EKG during empathy and compassion generates a harmonic series based on golden ratio - because it is the way all biological oscillators take their armoring down to become touchable. This is naturally done - only when the biological organism has found something WORTH SHARING. Thus - discovering something which illuminates pure principle results in your feeling a great electrical rush or tingle. It is biology's way of informing you - that you have found a proper way to EMBED and thus not die.**

The reason the mercury vapor lights - and the non-full spectrum fluorescent lights killed life and attention span - is simply their wave lengths were not such as to be able to EMBED in the 'phase nest' of all of the fusion in the solar system. The wave lengths of hydrogen's fusion which is the essence of sunlight has the symmetry necessary to permit **FUSION** of waves in general. Fusion is the essence of human attention - AND (the alchemy of ) LIFE FORCE - because it has the symmetry recipe to produce maximum agreement among waves. That infinite potential

wave agreement (implosion) is the essence of life's alchemy and self-organization because it is how the self-aware universe makes phone calls to itself. The mathematic term for this is 'infinite multiply connected topology'. To understand the life essence notion of infinite multiple connectedness - simply imagine a hologram made of waves. Each node can contain information about an infinite number of other points- ONLY when perfect compression allows each node to be fractal or self-similar. So - in a sense the only perfectly sustainable hologram is fractal - and self-aware. In other words - total coherence in its boundary or limit condition is perfect compression based on fractality . This **IS the alchemy of life.**

The English language holds a key to this alchemy. The word EVIL for example - by being the mirror reverse of the characters for LIVE. Here - the L is the turn or phase angle- the EYE is the I of focus- and the V is the vortex or tornado of perfect embedding. To LIVE is to turn into perfect embedding. And the mirror opposite of that - or EVIL - is merely to TURN AWAY FROM EMBEDDING. So therefore - the LIGHTING in your childrens - classroom - by being fluorescent and not full spectrum solar - is exquisitely EVIL. (Because those waves FAIL TO EMBED). If someone were to explain the physics of what EVIL means to George Bush - maybe a new yardstick for lack of bliss in a fear based government would be exposed.

It is not a return to an ancient alchemy which is so much dreamed of ( as for Sintra's yearning / Saudade). It is the NEW alchemy for what is a DOORWAY INTO A FRACTAL - The true PORT -OF the [GRAIL](#). (Port-u gal) So - what this article proposes is that a new academic facility be created ( as at SINTRA - which can be read as S-INTRA, or GOING INTO - access to vortex / implosion). Here we take the opportunity to teach the new physics of what alchemy really means. A 'sacred space' - enough magnetic lines are persuaded to converge non-destructively - to make dimpling - and turning inside out - possible.

[How Does PHI/Golden Mean Based Recursion Create Dimple Inside Out-Ness?](#) [soulinvitation.com/dimple](http://soulinvitation.com/dimple)

The electrical environment there is ideally suited to create ATTENTION to teach the PRINCIPLES behind the ancient Science of Alchemy. The Alchemical studios of earlier centuries could find no more wonderful or appropriate service - than to become the proper history rich ambiance to now inform our young people of the new union between new physics and ancient alchemical principles.

Lack of respect for life in our young people arises directly from not understanding the true electrical alchemic principles of what life is. In an environment where the true physics of charge implosion, and life essence are encouraged - the new dynamics of peak experience and peak learning are enabled. Eventually this leads to the exploration of peak experience and initiation as the proper result of an initiatory complex like Sintra. Here magnetic convergence sites visited in proper symmetry sequence - create implosion alchemically in the glands- maximum sensitivity / perception and even the true science of euphoria and bliss.. ( [soulinvitation.com/rainbowserpent](http://soulinvitation.com/rainbowserpent) )

See [soulinvitation.com/brainphire](http://soulinvitation.com/brainphire) : [BrainPhire?Fractal Golden Ratio Harmonics in BrainWaves as Mechanism of Euphoria / Active Visualization / Bliss?](#)

***If the Source of Becoming Informed, and of Knowing - Lies in How Much CHARGE Information can Be Contained or Embedded in the Body..***

***And - Peak Awareness is Peak Charge- Then The Goal of EDUCATION Should be that Peak.. Consider - the Physics of Euphoria and Peak Awareness — ( even BLISS) as the Ultimate Educator BrainPhire?***

Study in Russia Indicates Fractal Golden Ratio Harmonics in BrainWaves as Mechanism of Euphoria / Active Visualization / Bliss?

This Supports Neurofeedback Solutions to ATTENTION DISORDERS Based on IMPLOSION.

[soulinvitation.com/braintuner](http://soulinvitation.com/braintuner)

**As promised in the title - the REASON time compression at the end of solar ages- alchemizes the heart - is because the charge densities which accompany the solar maxima (2000- 2012 - climax of the Mayan / Solar calendar) formerly called RAPTURE by Christians - permit only those biological structures ABLE to non-destructively (and ALCHEMICALLY) compress / implode - to survive.**

In a sense - being squeezed - teaches us the biological hygiene techniques for immortality of infinite compression / acceleration thru the Heart of the sun..

(When the phase fronts of biological magnetics - particularly the ultraviolet component of DNA emissions - blue fire - interface successfully with the superluminal - faster than light speed - the resultant electrical sustainability is the physics of immortality / ensoulment).

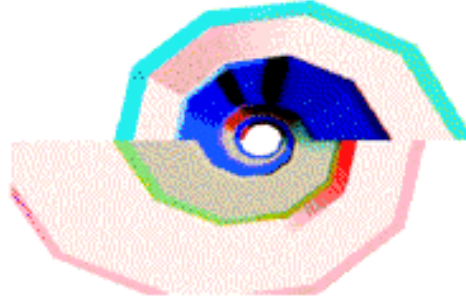

**Faster than light wave velocities have been measured down the vortex of the DNA helix. (William Pensinger et al.)**

Here is another example - if we take the top down view of your DNA struggling to achieve the necessary implosive compression acceleration required to die successfully -

(see movie [soulinvitation.com/superDNA](http://soulinvitation.com/superDNA) )

This is ALSO the model for how compression near the end of the solar cycle - AL-CHEM-IZES the heart. More specifically - all of the magnetism converging which requires the sun to orgasm - tests each biological genetic for the same compression hygiene. Alchemy is the heart of what enables ACCESS to this black hole - where - many paths and errands meet.

**track the 7 arrows of the heart.. you have the [symmetry map to imposition AND self awareness.. at not only the human heart but also the heart of hydrogen and the heart of the sun.](#)**

[soulinvitation.com//heartsun/HeartofSun.html](http://soulinvitation.com//heartsun/HeartofSun.html)

[heartsun/HeartofSun.html](http://soulinvitation.com//heartsun/HeartofSun.html)

APPENDIX-

**Could we measure rate at which star bodies mass centers entered recursion geometrics**

- (log phi spirals, 60degree dodeca implosion conics from <http://www.soulinvitation.com/grail.html> )

**to predict the rate at which they become recursive/self-organizing (emergant from chaos enough to recur) and therefore self aware..**

Thus at least learning a lesson from the geometry of our local "end of time" ref: <http://www.soulinvitation.com/timewave> (erection of holy cross galactically) and [sangraal.com/AMET/hendaye.html](http://sangraal.com/AMET/hendaye.html) (fulcanelli monument to the end of time..)

storal seems to be that if we learned the symmetry of recursion as fusion - which animates the galactic core (& sun trigger) toward self- awareness/organization/direction - then we should be able to apply (that alchemy)(alphabet of symmetry) to the heart..

And Finally- the role of star-fire /glandular alchemy - (melatonin/serotonin rich menstrual blood as oil of messeh - creating messiah..) [Lawrence Gardner: Bloodline of the Grail..StarFire-Annunaki, Genesis of the Grail Kings, ShewBread-Gold Powder & More.. books](#)

**This work on Implosion originated with Dan Winter's discovery of Frequency Signature of EKG during empathy - becoming COHERENT and self-similar - see: <http://www.heartcoherence.com>**

*Model of the Heart's Electrification during Euphoria..  
Implosive Compression:*

<http://www.soulinvitation.com/compassionmap>

*animated in Java for visual understanding of implosion AS compassion itself.*

exerpt: **How Symmetry Map to Inside Out Makes Compassion's Harmonics Measureable**

Understanding the Simple physics behind HOW [the Heart Tuner](#) measures compassion - as [coherence](#) (in addition to measuring empathy when 2 hearts come into phase lock).. from The [Heart Coherence Team](#)... Sept 2002.

First- see interdigitated (stellated) -phi based- dodeca model the perfected embedding chosen by the [\(fractal\) EKG](#) - like DNA/ Earth Grid / & Zodiac..

Next animation ( at link) - how the donut knows the way inside out... try throwing it ..

[see friends who spin it into an alphabet of symmetry.. http://spirals.etrnite.com](#)

As the heart sucks into its fractal center  
(you FEEL compassionately for what is outside you as if it were INSIDE you..)



the wind which begins when you choose to FEEL compassion.. the donut sucks the dimple in - again and again - which shows up as another harmonic in the harmonic analysis (power spectra ..right bottom in the pic)..THIS IS WHAT THE HEART TUNER MEASURES AS THE [ONSET OF COHERENCE](#)..

This ascension is enabled by the centering force generated by PASSION itself. (Which as we suggest below has a critical function in the physics of how biology feeds gravity - the force which keeps tornadoes concentric - thus gluing all worlds together).

So this is HOW we believe [The HeartTuner](#) works - When you choose to feel compassion - you make a little picture INSIDE your heart - which WHEN it is SELF-SIMILAR (or fractal) to the SHAPE of the FEELING (magnetism) of the person OUTSIDE your heart ...

THEN that sets up the conditions to allow the OUTSIDE to FALL IN. This is called technically - a FRACTAL ATTRACTOR. It works because only FRACTAL ( or self-similar - fern or onion like) symmetry permits infinite non-destructive compression. This is also called IMPLOSION.

When waves can infinitely CONSTRUCTIVELY interfere as they approach center (fractal self-similarity optimized by Golden Mean ratio) then they add and multiply their wave velocities constructively as well as their wave lengths. This we believe is the only physics necessary to understand the origin of gravity - (because that geometry which permits acceleration - is that which makes gravity - which is the same as acceleration - which will be proven as soon as someone -besides military aircraft - puts enough capacitors in a fractal to make gravity —)

*It is Electrifying to Realize  
the Heart is Electrified By Concentric Donuts - Sweeping Voltage Directly from Gravity.*

(pic from "When Time Breaks Down" by Winfree -electrophysics of origin of the Heart's Beat)  
 More reading in this series: [soulinvitation.com](#) /torrent /tunnelling /collapse /dimple /fusion  
[Suction Steers! Implosion Makes Waves: Creating a TORRENT thru your Heart](#)  
[Tunnelling .. The "Black Hole": In the Human Heart.](#)  
[Occassioned by the Heart's Blissful Sonic Pony Tail, How Compression Thru Light Speed Becomes "Tunnelling"](#)  
[The Perfect Geometry of Wave Collapse - Neurophysics Soluti on the Nature of Consciousness](#)  
[Projective Geometry of the Heart-Perfect Compression/Compassion=THE SHARED SPACE](#)  
[Fusion-Phi Phenomenon-Unlocking Ultimate PHIRE.](#)  
[How Does PHI/Golden Mean Based Recursion Create Dimple Inside Out-Ness?-](#)

**Compassion is learned**  
 When the little picture inside  
 Your heart becomes  
 So 'self'similar' ( or 'fractal')  
 To the shape of magnetism  
 In someone else -  
 That perfect compression -  
 The 'fractal attractor'  
 Sucks the Out-Side - IN !

**This RECURSIVE -**  
**TURNING INSIDE OUT -**  
**Becomes IMPLOSION -**  
**Which is the electrical**  
**RUSH associated with FEELING .**  
**And shows up in the ASCENSION**  
**Of the next harmonics measurable**  
**In the EKG .**

*Relationship - COMPASSION  
- to ASCENSION*

*Bibliographic suggestions- Annotated*

In thematic not alphabetic sequence.

**Alphabet of the Heart** by Dan Winter <http://spirals.eternite.com> Origin of Alphabets in the electrical structure & firing of the heart & emotion. A classic.

**Alphabet of the EarthHeart** by Dan Winter <http://spirals.eternite.com> Origin of ceremonial magic in the origins of symbol and shape of emotion. Exquisite editing and illustration by Vincent Bridges and Darlene.

**Return of Enki** by Dan Winter [soulinvitation.com/enki](http://soulinvitation.com/enki) Sumerian connection to Draco's and the origins and purpose of Earth DNA in the galaxy

**Tutankhamon Prophecies** by Maurice Cotterel- Best solar physicist on the planet on the subject how does the solar wave compression pattern impact Earth cultures. This is the physics behind the more myth based Mayan Calendric materials.

**Spiral Calendar** by Carolan. First part is great: learn that events in time HAVE to arrange themselves on a spiral in time, in order to emerge from chaos. Nice analysis of huge historical patterns. Second part is terrible. Using that to predict stock markets is fine IF you can understand the principle. But if you entirely miss that recursion is what makes oscillators self-aware - then you just confuse people into soul bleeding greed. better read- [soulinvitation.com/stockmkt/stockmkt.html](http://soulinvitation.com/stockmkt/stockmkt.html)

**Gramatical Man - Information, Entropy, Language and Life** by Jeremy Campbell. The reason DNA gets to replace any error message - is context richness. This means nesting or braid coherence creates high signal to noise ratio. Fascination comparison of DNA structure to language and programming structure. Enriching.

**Cosmic Serpent** - Jeremy Narby Is DNA an intelligent SHAPESHIFTING WORM?

**Raw and the Cooked** - by Mircea Eliade. Is the REASON you cook your food -because you do not have enough confidence in your inner FIRE / IMPLOSION to access/ commune / fuse with the spin memory in your food? In ancient history cooking served a purpose in fusing tribes by phase locking around fire. ( PHIRE..?)

**Civilization and it's Discontents** by Sigmund Freud - Urge to touch frustrated becomes ANGER .. Siggy - eros has an electrical meaning beyond the shape of your own cigar.

**Memories, Dreams and Reflections** by Carl Jung. Do YOU know why the Balinese Cock fight - explains the need of testosterone poisoning to HIT instead of TOUCH - as the true origins of FOOTBALL?? Why does pigskin symbolize the anality of the poison pellet: ANGER-which is urge to touch frustrated. If you COULD teach your teenage boys permission to touch (non-destructive compression) toward bliss / charge density they might not HAVE to waste half the genepool in destructive 'sport'. (This has been a paid political ad for the National Football League).

**Synergetics** by Buckminster Fuller- Bucky taught us the geodesic at Univ Detroit- as we walked his dome onto the architecture school foundation, and then in Florence Italy - as he showed us personally his vector flexing. Got the weakness of the cube as a wave structure right - doesn't know about the compression into implosion of the dodec tho.

**Genesa** by Derald Langham - Presented in Florence at the 2nd Conference sponsored by Jaccaci, along with Winter. Building sacred geometric structure large enough for young people to experience from the inside out.

**Genesis Revisited, Twelfth Planet, Lost Book of Enki, etc.** by Zachariah Sitchin. Good to get the cobwebs of the disastrously mistranslated bible out of your head - with some cave man quality Sumerian. At least these were REAL cave men. If SHEM means highward fire stone and not ALTAR unto the Lord - then how does a magnetic dolmen make the fractal needed to compress accelerate your 'prayer' into heaven...? a Djed Ai Question. Would an Arc on a Torus -ar-thur raise that sword (MAG line) from that STONE (MAG circle / mass?)



**Voyagers and Amenti** series by Anna Hayes. Anna heard right in some of the early material. The politicals of changing Annunaki interventionists preying on Earth's genepool make a colorful tell. Too much ancient ET history detail..

**Innana Returns** by Ferguson ( [innanareturns.com](http://innanareturns.com) ) Were you there when the reluctant younger sister (half Dragon queen /Draco - 'Innana' apologized to the human genepool for so cavalierly

**Law's of Form** - by Spencer Brown. Deriving the entire CALCULUS from the simple bracket idea that either I am inside you, or you are inside me. Imagine an algae- eats its neighbor and folds that memory into it's surface. Then you eat me, he eats you, someone eats him, ad infinitum. That is the way single celled organisms CONSUME PERSPECTIVE. Now if each time someone eats (or we could say - touches) someone else - the amount of spin foldedness which is PHASE COHERENT (Shareably pure intent - pure principle) then adds it spin as new fold ( makes it's DENT) on the winning membrane - THEN you could express the INFINITE NESTING as a series of BRACKETS - (either open parenthesis or close parenthesis). Then in order to understand the evolution of CON-SCIOUS-NESS ( WITH -sc-ious-ness - LITERALLY meaning WITH TURNING INSIDE OUT - NESS) would be to to express the spin path back in history as to what spin was nested inside what other spin. Inside of - outside of -inside of... ad infinitum. Until - **you had derived the complete origin of CALCULUS - as a simple way to track back ONE worm hole turning either inside out or outside in - itself - inPHIkntly!**

**Structural Stability and Morphogenesis**- by Rene Thom. Once you understand WHY no cell membrane has stability unless the foldedness which makes up its surface - its self/not-self - IS MADE ONLY OF SINE WAVES IN MUSICAL PHASE (COHERENCE) .... THEN you can teach WHY AIDS only spread in Africa AFTER the tribal BLISS dances were forgotten. The BLISS is the COHERENCE of the PHONON - sound wave in liquid - which feeds the mem-brain.

**ShuffleBrain** - by Paul Pietsch [pietsch@indiane.edu](mailto:pietsch@indiane.edu) - Neuroscience for Kids - how does the brain store mind. Teach a worm to steer a maze: then feed that worm to a 2nd, and then the 2nd worm is better at steering the maze learned by the first! Is the molecular mechanism of CELLULAR MEMORY - in fact a wave? Is the DNA such a shape-shifter as that worm.

**Rhythmns of Vision** -by Lawrence Blair... Pics of the 3D platonic nested on the Chakras - a bit fanciful - but a good intro to see that vision (perception) is the result of symmetry. A classic.

**Stream of Consciousness in the Modern Novel**- from Joyce to Virginia Woolf - whose flow of inner voice is singing in YOUR DNA - is it everyone's voice at once?

**Love's Body** - by Norman O Brown. Did James Joyce use the SHAPE of Dublin for the shadow of his drunk Irishman stupored on his back - for the same reason that Rome ( Uru-an- Uru an is, Uru m ania,..Uru shaliam) had 7 hills. Does inhabiting the land REQUIRE the shape of LOVE's Body IN the land.

**Finnegan's Wake** - by James Joyce - Celebrate - and again awake Fin end again. Have you seen the comedy of death against the tragedy of life like a play on 'words' - elements of spin.

**Genealogy of Morals in the Birth of Tragedy** - by Nietzsche . Why does it require the ability to celebrate TRAGEDY to HAVE morals. Is the perception of the presence of a longer wave(the BIG picture) the result of the experience of the COMPRESSION of a shorter one?

**Sentics**- by Manfred Clynes. Look closely at WHY the SHAPE of the folds of Michelangelo's PIETA is the exact wave form for the measured 'Sentic' SHAPE of the pressure wave of TOUCH which expresses GRIEF. Later Manfred presents his measurement - in the NOVA TV series 'What is Music' that the SAME shape for the squeeze that says I LOVE YOU etc., is used IN EVERY CULTURE ON EARTH. Is that (Universal / Ubiquitous) GEOMETRY OF PRESSURE - sacred?

**Hebraic Tongue Restored - Origins of the Adamic Race** - by Antoine Fabre D'Olivet. Classic serious root of much of western esotericism - if properly understood. (may be available from Health Research Press, CA.USA). By looking at the MEANING OF THE SHAPE ONLY! OF EACH INDIVIDUAL HEBREW LETTER,

D'Olivet - one of histories great linguists- **RETRANSLATES GENESIS**. Instead of “ IN the beginning” - he give us “At first in principle the origin of thing-ness” - which later (in Alphabet of the Heart by Winter - here echoing his legal parasite Tenen) becomes the **sequence of symmetry view shadows of seven steps from outside in to inside out - on the self-organizing golden spiral on the 7 color moebius - casting exactly only the shadows of the 7 letters of Braeshith - (The first word of Genesis) which is literally - ONLY - the sequence of symmetry operations/ TURNS OF MIND - necessary to turn inside out on the surface of a donut. And literally (by compressing charge) become the origin of mass out of light. ... restoring the Hebraic Tongue.** (Phire in the mouth of a Draco-n).

**Enochian Physics and Origins of GOLDEN DAWN magic** - from John Dee (assorted literature - also links [soulinvitation.com/ophanim](http://soulinvitation.com/ophanim) [soulinvitation.com/enochian](http://soulinvitation.com/enochian) also writings of Vincent Bridges ).

**Willed Mutation of the Species** - by Satprem. At least presents the romantic idea of how a genepool as a field effect could come to have INTENT in steering its long term racial self direction. For example - did the giraffe gene get a long neck ability - by YEARNING? - probably yearning here is the same as - to hunger. Winter's notion that implosion in the coeur of DNA electrically creating the ability to suck ( and push) charge thru the speed of light - as the origin of self-steering ability (time-travel / bardo navigation/ lucid dreaming) is likely considerably more sophisticated scientifically - but builds nicely on this original classic.

**PsychoNavigation - Techniques for Travel Beyond Time**, by John Perkins. Psychonavigation for sailing... and shamanic dreaming? Compare the evolution of the ability to navigate by direct inner perception of your electromagnetic orientation to waves from stars - WITH + the possibility of steering when you die ( bardo navigation - see [soulinvitation.com/eternality](http://soulinvitation.com/eternality) for the geometry mapped of what you will see when you die), or WITH + the evolution of the TEMPLAR attempt to complete the ORION QUEEN (Guardians of the Grail - book) star navigating origins of navigation in western history - later described in 'Holy Grail Across the Atlantic' book. (Remember as you do the Hodowanec / Ramsey work evidencing the physics of astrology: that star events reach Earth faster than light measured in the output harmonics of a sensitive capacitor in a pristine place- pic in book. Is your brain synapse and cavity when resonating COHERENTLY in fact the best capacitor to catch long waves.. 'Cymatically'?). What is wrong with Karl Pribram's view in "Holographic Brain" from spectral data - that THERE IS NOTHING FLAMMABLE AT THE SYNAPSE ? Does MIND NOT INHABIT Phire? What Hawaiian scholar says that Polynesian navigators could orient themselves to the phase angle of an ocean wave bouncing off a continent 2000 miles from their canoe - by feeling it '**in their balls** (testicles) '? Have you watched birds get dizzy if they place themselves where magnetic lines are dizzy? Does this tell you where you do NOT want to die? Why does a Cherokee only choose to die where the little hill is fractal to the mountain in the distance? Can you unpack that unawareness non-destructively?

**Holographic Brain-** by Karl Pribram. What he missed: as he stood behind Winter at Heart Math Institute showing them the harmonic analysis of a HEART feeling passion saying 'I don't think we could DESIGN an oscillator to do that!' - That the phase discipline in the optical cortex hologram which determined if your dreaming was lucid and reality creating- specifically required that the symbol map (origin of alphabets you used) be THE GOLDEN SPIRAL on the donut - BECAUSE that is what enables charge to COMPRESS - make matter out of light - from the synaptic hologram. When the inner hologram (optical cortex) is self-similar to the outer hologram (matter is a 'hologram with a weight problem') - that is to say FRACTAL - then 'your wishes become horses so beggars ride'. Read how the lady who lightened her purse by turning her mirror and her magnifying glass into holograms - frustrated that at first only other items INSIDE the same hologram could be seen in her new mirror and magnifying glass - until she learned ( by lucid dreaming?) SHE COULD ONLY SEE HERSELF IN THAT MIRROR IF SHE BASKED IN THE ORIGINAL LIGHT! ( story in 'Alphabet of the Heart', Winter).

**Starlight Elixirs** - Hilarion / Pegasus Press.. Lists the psychological effects on Earth from cultures on many stars. (Initially by focusing specific stars light into water for healing purpose). Compare with the index of which star systems were most respecting of the prime directive- do not interfere- when genetic interventionism on Earth involved as many as 22 ET civilizations. ( in Anna Hayes book - Voyagers , also [lettersfromandromeda.com](http://lettersfromandromeda.com) )

**Macrodynamics** - by Ralph Abraham. So sad that while he had real proof of the physics of astrology by watching viscous waves make the same pattern for each major star crossing alignment - there was no attempt to present that insight. Years later presenting in Netherlands - no evidence of the simple essential insight that the ONLY path out of chaos - is self-similarity permitting infinite collapse - so easily measured looking for PHI ratio in the power spectra - OF ANYTHING - (becoming self-aware).

**Cymatics**- by Hans Jenny. Probably the planets best pictures of the sacred geometry of waves crossing themselves ('in blessing') - if you can afford the books (probably out of print).

**Vortex of Life (formerly Fields of Form)**- by Lawrence Edwards (Floris Books & some Anthroposophic outlets) . (also presented later by Nick Thomas to the Netherlands 'Implosion Group'). If you were frustrated that the projective geometry Steiner material never told you that line drawings to project geometry - ARE wave paths for charge only - then this is balm. Nick presented eloquently THAT the PINE CONE breathes open and shut with exquisite geometry and gentleness in phase to the seasonal need - but not WHY ( to adjust the AMOUNT OF WATTAGE IT NEEDS TO EXTRACT FROM GRAVITY.. by IMPLOSION!). This is also the reference for the 7 layers of Heart Muscle (Pettigrew dissections discovering the 7 spin symmetries of the tetra in the heart muscle layers- see pic.) angled to present the shadows of the Hebrew Alphabet on the cave walls of the Thymus - in Alphabet of the Heart, Winter.

**VORTEX MOMENTA HEART PUMP MODEL, The Heart is Not A Pump**- by Ralph Marinelli, Royal Oak , MI, USA. (Research Paper not book) - (also described by Jennifer Greene - Maine Flowform group.) The reason the heart's phonon / sonic information travels so efficiently with harmonic components richly embedded - is that the heart is not a pump. It sequentially squeezes each of the needed 7 layers of muscle (Alphabet of the Heart - 7 tetra spin subset of all symmetry) in the right PHASE sequence to design a VORTEX tornado in ANY possible useful TILT ANGLE (phase). This to push the FIELD of magnetic blood carried by the blood as a twister which then travels COHERENTLY to your extremity. Close your open hand while making a spinning motion like spinning up a top - *that is your heart muscle casting off tornados one by one - hoping they will last.*

**When Time Breaks Down**- by Arthur Winfree. Altho he did not agree or understand that the self similarity of the nervous electrical fibres where the heart is electrified - is the fractal capacitive catcher's mit grail - which asks where the stars are IF there is enough still point rest between each beat ..... (thank God at least Rollin McCraty, Heart Math, DID know enough to spectrum analyze the EKG in the flat rest instant BETWEEN beats at VERY high sampling rates).. Arthur did put together one of the best pictorials on the turning inside out toroidal donut nests of the hearts source of voltage. (Without of course having a clue that the SOURCE of that voltage similar to the fresh egg's DC voltage source - was implosion from gravity itself).

**Theory and Design of Quartz Crystal Oscillators** - by Virgil Bottom . Technology of designing quartz oscillators for electrical circuits. Standing watching them check the thickness of the quartz wafer grind in the lab in Carlisle Pennsylvania, by waiting until the radio nearby buzzed at the right frequency --- I realized that the reason astrology works is because at the moment of the birth of EACH BOND - the electrical phase lock by containing an infinite harmonic series - stores a capacitive map to the position of every STAR by phase or tilt angle - as the star was aligned at the time the bond CHRISTallized. (Since Gravity is capacitive charge moving in a wind between frequencies up past the speed of light) . That charge steers the liquid into the bond- the physics behind water drop geometries, Immoto, and Kirlian's light. Radiate charge and you in- FORM.

**Atlantean Fire Crystal** - papers by Louis Acker (privately published) also co-authored Handbook of Astrology. Too much LSD or not - Louis did remember his Atlantean scientist incarnations well enough to plot the hex symmetry of the doped quartz implosion crystals of Atlantis. (Edgar Cayce terms the TUOAI STONES - researched by physicist SUTTON). Using implosive charge sources - the cool light that did not consume - was not in itself the loss of the genepools self-direction - what cost the tectonic gravity it's stability was USING them to deprive the masses of their freedom!! ( Take a lesson - US - CIA.)

**Fractal Self-Similarity of the Heart - Fibres of Perkinjole - Electrification** - papers by Ary Goldberger, MD. Classic early article showing how self-similarity powerfully characterize the hearts nervous branching source of electrification (now extended by Winter to imply implosion as the source of the heart's voltage from gravity during Bliss. / how the breatharian gets power - fractal electrical ENVIRONMENT required). Also nice work on the PHI Golden Ratio based branching of the lung alveoli - also where the body catches PHIRE - oxidation. <http://reylab.bidmc.harvard.edu/people/Ary.html>

**Projective Geometry** - by Olive Whicher. Original Anthroposophic classic on projecting lines to making elegance in sacred geometric nesting. Beautiful mind expanding - to see for example the GROWTH PATH OF A SEED. (no information about waves or charge ).

**Eurhythmy** - by Steiner (Various Works).. Sacred Dance - Powerful glandular triggers - controversy over whether Steiner in fact conceived of the self-empowering nature of bliss. Bliss pursuit taboo in Germanic culture? (Why do the Brits still act as if WWII rationing hadn't stopped - and the Germans act as if the guilt will never stop.. meantime WHO is doing BLISS?)

**Cosmic Humanism** - by Oliver Reiser - Perhaps the most spiritual and beautiful of literature arising from the General Systems Theory Movement (hi to Gus Jaccaci).. Can you see a cocoon of coherent charge moving starward from the human genepool fusing in BLISS? .. see:

**Genesis Effect** in Star Wars... Explosion of growth on billions of planets turning live IF the GENES of ISIS (Enki's Sirian mother) teach implosion to be self-aware.

**StarSeed Transmissions** - by Ken Carey - Sending baby Christos to fertilize galaxies with the memory of how to turn planets green?

**Lazarus Effect** - by Frank Herbert and Bill Ransom - (Dune Series) - Was Lazarus related to the MAGdalen. If so how was he instructed to LAZE R-US. Did he laze a way to cohere the genepool by priming the pump thru the death experience. Was Jesus (Tut) skilled in soul retrieval from his mother's genes.. the winged Seraphic Aide.

**Uriel's Machine**- Star maps in the geometry of Archeologic Paramagnetic sites - for the purpose of teaching the genepool how to predict comets.. to save them. An angelic design. Brilliant - but no info about soul groups using star maps in archeologic land maps - as lens to project soul group pods bliss cocoon starward - navigated significantly by stellar morphic resonance ( what was the Alpha Draconis star map at Ankor Wat USED for Mr Hancock)

**Heaven's Mirror** by Hancock .. (see note in Uriels Machine) Nice projection of Alpha Draconis in Ankor Wat - suggest magnetic function of the lens be taught - for shamanic navigating starward. No info on the politics of the star travelling Draco's whose road map in the sky he pics.

**Copper Scrolls.** Proof? that after Akhanaton (Enki - Ptah bloodline) completely messed up the royal checkbook - then ran out of town - and took the cash - (treasure).. changed his name to MOSES - (& became a gold powder spice cook - for mechanizing immortality - if you read Genesis of the Grail Kings) . Altho Enlil Yalweh Amun Ra priest politic mob chased him - he succeeded in stashing the cash to found the Essenes. The truthless Rabbi's changed the name of Tutankhamon to Jesus after he was strung up in a tree, out in the desert trying to save his dad. (read 'Out of Egypt')

**Out of Egypt and House of The Messiah** - Academic tour de force, evidence the Jews (Yalweh) so embarrassed at not being able to genetic engineer any decent genepool - deceitfully changed the name of all their cultural heros - to hide their true Egyptian identity. Akhanaton was Moses, Tut was Jesus.. (Akhsenpahten was MAG).. What - you don't think the timeline works? Read the books.

**God King Akhanaton** by Daniel Stewart .. Fun to read how Akhanaton's Sirian ET genes - pointy skull - distended spine - made him so wierd no lady would have sex with him. So do you believe that Thoth indulged in the Draco habit of eating live human pineal glands when no other substitute for immortality could be found? Return of Enki [soulinvitation.com/enki](http://soulinvitation.com/enki) suggests Akhanaton and Thoth (Hermes / Quetlcoatl.) were all Enki descendants.

**Mathematics of The Cosmic Mind** , & book “Tetratys” by Plummer (Theosophic Press) - Inspiration for Star Mother Kit [soulinvitation.com/tools](http://soulinvitation.com/tools) or [heartcoherence.com](http://heartcoherence.com) (Plummer wrote the first intro to the kit)- WHY would the summed internal angles of all the nested platonic equal the years in precession. Is rotation the way time is measured? The prime purpose here is to see why all the platonic (tetra/ octa) that nest inside the cube have edge length ratios exclusively log multiples of two - octave incubation- while all the platonic which self nest outside the cube (dodeca / icosahedron) have edge length ratios exclusively of Golden Mean ratios - in infinite 3D stellation interdigitation.

**Primer on Energy , Primer on Rotation.** (books) Relative rotation is the only definition and origin of both mass and time. Read WHY all human scarcity derives from attempt to STORE rather than distribute rotation / resource / energy / food /// etc.. . That will clue you to WHY implosion infinitely multiply connects by perfect motionless touch - making distribution infinite and storage eliminated. IF your line of billiard balls (hard spheres) from here to the moon (Bucky Fuller: ‘Nine Chains to the Moon’), had a millionth of an inch space between each one - THEN when you bounced ONE billiard ball directly into this end of the line, it could take a long time ( if ever) for one billiard ball to bounce off at the other end - BECAUSE INERTIA WAS STORED BETWEEN EACH INSTEAD OF PERFECT DELIVERY--- however - IF your row of billiard balls to the moon WERE EACH PERFECTLY TOUCHING THE NEXT ONE - then - when you bounce one billiard ball into this end - WOULD THE ONE BILLIARD BALL BOUNCE IMMEDIATELY OFF THE OTHER END NEAR THE MOON - having passed the inertia there faster than light???? This may explain why locking charge in PERFECT stillness in the icy dodeca - can connect the charge in your DNA to every gene based organism - and star - instantly.

**Star Man / Star Maker** by Olafson? Like Dave disappearing into millions of fractal monoliths in ‘2001’, and showing up **well distributed** to everyones TV set at will - in ‘2010’. Where did the memory go during lightning in **Powder** (the film). Why are lightning strikes some of the most information rich near death experiences? Why does kundalini eliminate the need for near death experiences? Why can Draco’s never stop trying to succeed at near death experiences? (Hint - takes many tries to get it right on ‘Groundhog Day’)

**Black Sun** - by Samuel Sagan - ‘Point Pairing’ psychic inertia bearing fusion thrust (wherever 2 or more are gathered in my name / envelope) - Sci-Fi Intro to Shamanic Pod (group) gravity bending - star navigating.

**Dune Series** - Frank Herbert, & Son & Bill Ransom. Much more accurate history of Draco Annunaki than the Bible. Muab Dib is Enki, Harkonen is Enlil. Leto is An. Emporer is Orion Queen (‘Reverend Mother’). Guild Navigators immerse in Gold Powder (spice) in blood to implode / steering the worm. Arrakeis is a star iin Alpha Draconis. Muab Dib - the hero wakes up to find his blood ancestor ‘dad’ (Harkonen / Enlil) is HALF MACHINE. (sound familiar). Maybe HUman could wake up to find - H’IBI-URU ‘dad’ is half borg?

**Star Trek - Empire Strikes Back** - Useful history of Orion wars - writer learned by living with Phyllis Schlemmer / UK. Luke Skywalker (Enki, Chloridians in the blood are implosion - ANIKIN / Annunaki) wakes up to find out that Dad (Darth Vader / AN) is half MACHINE (sound familiar)..Maybe HUman could wake up to find - H’IBI-URU ‘dad’ is half borg?

**Lord of the Ring** - Fusing the Ring (of DNA) into implosion inside out (chapter herein) - was a skill shareable to ONLY the ‘pure of heart’. The lost letters of the ring - were that alphabet (H’ibi-URU) of the symmetry of MAGnetic domains - to compress enough charge into DNA to let it ‘ring’.

**www.wingmakers.com** - Change the BST - blank state technology - which COULD save our genepool from parasitic / vampiric Extra-terrestrials (fallen Nephilim Draco) arriving enmasse - from a TECHNOLOGY to a PSYCHOLOGY. The Tron are interactively able to time travel non-destructively.. BECAUSE their DNA is squirting thru light speed so well. The physics of bliss process to ignite DNA - is the missing ingredient.

**IBI-URU (hebrew, niburu)**- IBI= bird tribe , URU = DRACO, Dragon, Reptilian. (URUshaliam = Jerusalem, URU-an - rumania and rome, and uranis, and turanesian, ab-RA (enki) Abraham came from UR(u) and started (genetic terrorism of a sort) all ‘religions’. Hebrew: (h’ibi-uru) means ‘crossing over’ in Rabbi. The bird tribe Ophanim crossed their genes with Alfab Draconis Draco URU.. Potentially creating a reptilian brain stem amygdala (mouth of the snake - where testosterone juice is pumped from) capable for pumping well

into the RAPTOR / ure of the vice like grip - talons of the bird brain. Kundalini biomechanics involved to return many plumed ONE.

**Guardians of the Grail** - by Robert Morningsky. Best history of the Orion Queens. Watch the dissection of the ancient reptilian (Roswell craft strut / & Sirian alphabets) diction from the SHAPE an dproclivities of the oral cavity of the velociraptor. (Wear an umbrella to watch an old lady in Amsterdam get angry). What is the power of spit.. Did you feel a quiver in Jurassic Park? The Grail blood line - is a name for the DrAGon queens questing AGni (fire / implosion / passion ) in their blood thru US - their genetic experiment.

**Genesis of the Grail Kings** by Lawrence Gardner- Gardner tells you the high side of his Draco ancestors - David Icke gives the dirty laundry of the same family.. Could BOTH be right? (Yes). Good background to understand Gold Powder cookery and addiction - and why the Annunaki Draco decided to make a special bloodline ('The Chosen')- to be babysitters to the rest of the donkeys lulu human's for the sole purpose of delivering the instructions from the Draco Annunaki to the stupid humans. This making blood that is royal-became their excuse for manipulating the genes of our royal families for 2000 years as if we were show dogs. Study the science of menstrual blood high in melatonin (oil of messeh / 'Messiah' making - crocodile juice) the royal jelly for the hive mind to feed babies. Our squeamishness around blood hygiene and genetic planning - with all its emotive overtones - needs a good steam cleaning. Just cause Hitler gave genetic planning bad PR, doesn't mean we should give less care(research) to the blood marriages of our children then we do to our dogs. The other extreme is requiring 10 generations of planning to get permission to conceive a child which Enlil / Yalweh brought from the Orion Queen fear of setting DNA free - right to the Jews and to the Aborigines.

**Stalking the Wild Pendulum-** & Cosmic Book - by Ben Bentov. One of the original mentors for Winter - Bentov wonderfully documents the resonant biomechanics of kundalini and bliss with excellent cartoons. Where do you think the harmonic diversity of a pendulum is at the moment it reaches its stillpoint between swings? Then read:

**Foucault's Pendulum** - by Umberto Ecco. A bit heavy on the Templar story-telling. Eventually hints at the useful physics that HOW the little pendulum is COUPLED to the longer one above it, whose tail it swings on - instructs you on the chain of command back up to God. ( connectivity of mind at the coeur of DNA).

**William Buehler work:** ( some at [soulinvitation.com/buehler](http://soulinvitation.com/buehler) ) Some of the most extensive Thoth Tehuti inspired TEMPLAR history and practice of the geometry repair of the fabric of time. Pattern of layout archeologically for continent spanning magnetic line making - for the purpose of providing a way in and out for genetic memory into stars.

**Flicker** - Important history of the TEMPLAR ORIGINS OF FILMMAKING - Visual fusion's psychophysics is key both to Nephilim agenda's of PARASITIZING a race / mind control / to install Insurance and Banking the industries of FEAR - called Piracy when their PR budget is lower (skull and bones). ... AND to the possibility of steering a genepool VISION back into potential star steering and inhabiting.

**Taking the Quantum Leap** - by Fred Wolf. His best - Truly a great way to BEGIN your study of the physics of consciousness. He even starts on the idea of recursion. Too bad Fred never developed his Spectrograms of the Hebrew Alphabet. - with Soares.

**Defending Sacred Ground-** by Alex Collier, **Andromedan Perspective.** [lettersfromandromeda.com](http://lettersfromandromeda.com) Helpful perspective on how pervasive the parasitism of the Annunaki Draco has been thru history AND the present. "YOU NEED NO LONGER BE SPAWN OF THE NEPHILIM" means if you don't succumb to the government waves of fear mongering producing the fear juice they eat - THEN you could develop your BLISS - igniting your DNA into precisely what would TOAST the lo grade DNA of the parasites. (Don't shoot the parasite in your belly - Mr. Pasteur - be grateful it is there - so you can learn from it - why it is there:- you ate death - dead food - or a dead idea like God is outside you - your parasites helpfully consume the death out of you - what they eat is everything that does not serve your implosion / bliss. Anything that implodes or fires like passion in DNA - burns every parasite in sight - because lo grade DNA cannot withstand compression / implosion - like the sailors at Montauk whose DNA was not up to speed... Here comes the rapture - are you **left behind?**).

**Beginners Guide to Constructing the Universe** - by Michael Schneider. Perhaps one of the best starter places to learn the universal consequences of Sacred Geometry. Just what the title says.

**Pandora's Box** by Alex Christopher - A fairly revolting level of detail on the Royal French King Louis fortune / bloodline (from Magdalen down thru Merovigian etc.) taking the remnant after the French Revolution to Tryon, North Carolina - (Louis XVII?renamed Daniel Peyseur) - funding the (Borg / Orion) railroad cartel - which becomes the Rockefeller wealth? Does not ask if Winthrop really sired Bill Clinton. Nice local detail - missing **the big picture ( Orion queen family - humpty dumpty's {dragon's} EGG - couldn't put itself back together again. Fallen Nephilim can't find the symmetry recipe to immortalize DNA ... tsk tsk. Hint: soul pod group DNA igniting BLISS process - also ref: AMENTI principle in Anna Hayes - use the features of your starmap to lens your bliss pod to re-inhabit the heavens. How BIG is your lucid dream....)**

**Two Thirds** by David Percy and David Myers, Aulis Press, London. Excellent hundreds of photos of the geometry of crop circles (cancer building microwave selective melt of grain stalk diameter - the surface printer from the underground military mind control microwave dishes)... showing the attempt to re-construct the geometry tables to teach genepools to organize enough of their glandular magnetism (EMOTION) to stabilize their planets atmosphere etc. Example: crop circle shows the shape of the HAT OF OSIRIS (bit of a floppy cone) as the **CORRECT SHAPE OF A HEALTHY PERICARDIUM.. If we have the muscles necessary to FLEX the SHAPE of that cavity by INTENTION - then we have the skill to angularly lens (like the muscles flexing the eyeball shape to make FOCUS possible).. and steer the GRAVITY THRUST WHICH RESULTS FROM A PROPERLY FIRING / BLISSFUL - HEART. (Like tilting the shape of the nozzle below a rocket engine - except this is IMplosion steering not EXplosion). This is absolutely key to star navigating, time lord entry, guild navigators in Dune, Bardo navigating, shem-an-ic stellar lucid dreaming etc. Solar Shaman's egroup: [soulinvitation.com/solarshamans](http://soulinvitation.com/solarshamans) solar heart community and [yahoogroups.com](http://yahoogroups.com)**

**Return of the Bird Tribes** by Ken Carey. Iroquois and 5 nation confederacy history of the OPHANIM. Hints at the origin of western democracy.

**Weather Engineering on the High Seas** by Trevor Constable- Film- See how the Reichian layers CONE CAPACITOR which best pulls in rain storms off the ships deck - is in the correct 60 degree implosion cone angle of the concentric Dodeca. [soulinvitation.com/rain](http://soulinvitation.com/rain) [soulinvitation.com/desertification](http://soulinvitation.com/desertification)

Holy Grail series summary:

**Holy Blood Holy Grail**  
**Messianic Legacy**  
**Temple and the Lodge**  
**Sword and the Grail**  
**Holy Grail Across the Atlantic**  
**Pandora's Box**  
**Bloodline of the Holy Grail (see review in Nexus)**  
**Genesis**  
**Geneset**  
**His Holy Place**

**Discovering the ancestry of Jesus in a bloodline will never be fulfilling until - Thoth's clue is understood. He (descended from Enki / Yalweh - the Ptah taal / Hermes etc.,) suggests the reason MAGdalen's kids had dark blood - THE STORY OF BLACK MADONNA - (Nubian / blue ) was because he was the father. Akhanaton's (Ptah / Bird Tribe) kid Tut renamed Jesus by jealous Rabbi's, takes the copper blue blood from RIGEL in Orion where Thoth indicates his ancestors are from. Ask the Montauk boys about how interventionist the Rigelians are. Everyone is sitting around in stupid fascination at the pedigree for where messiahs / avatars come from - no one is nourished by the physics principles.**

**Personality worship will always be poison - like miracle worship- and a key way to determine which 'religions' are blood sucking parasites. (The 'priests' who brought you the enzyme to feed you like larvae to the astral milkhouse that is most churches - the sickening lie that - God is outside YOU!) . Star penetrating DNA arises with the ability to ignite it (implosively). That starts with the choice to take responsibility for your own destiny - quite the OPPOSITE of 'let go and let God'. nuff said.**

**The Way of the Scout** by Tom Brown Jr. (The Tracker and others in series). Where does telepathy in the woods come from - but the efficient fractal compressing of CHARGE in perfect 'branching'.

**Secret Places of the Lion** by George Hunt Williamson. Excellent history of the bloodline of MERK (Enki) - why did they feel so star lost when they (Annunaki early family) crash landed here - Ea's Earth? Were they in fact needing to HIDE the psychokinesis potential of their own DNA ( Anikin's Chloridan blood) from terrorizing Orion War Borg's by - cloning themselves into the Cro-magnon blood? When will the seed and egg shapeshifting implosive DNA worming - of those fish God's re-emerge to re-take the stars????? Truth is so much richer than fiction.

**Secret of the Andes** by Brother Philip. The Maxine light was a quartz crystal cube on which you might appear to vaporize if you stepped atop it. IF your DNA was compressible (shareable) you COULD then make the EL or phase shift This was another pen name of George Hunt Williamson / Michael d'Obrenovic author of Secret Place of the Lion, Road in the Sky (Star Maps in South America) - who worked with Elizabeth Van Buren :

**Refuge of the Apolcalyse -Rennes le Chateaux the Key** by Elizabeth Van Buren. Good in extending some of the Rennes star maps, and history (Et in Arcadia Ego means hide the branching of the blood tree in the new world)... Just like Ben Franklin's and Thomas Jefferson's late life disappointment - bad in discernment just which medium grade interventionist ET's they had been serving.

**Codes of Light** by Jessi Ayani. Tracks the MAG (Orion Queen blood) thru Joan of Arc, and back to the Andes. The Orion queens ALWAYS believe they have the CODES to ignite DNA... But they don't. (Anna Hayes revealing the MAG Pleadian line behind Marciniak for example as mostly interventionist / that is willing to take advantage of us / they are Beli Kurd - one of the branches of the interventionist Annu'hazi' LESS interested in preserving our freedom. The politics of Annunaki has never really had an altruistic motive. This is OK - but they haven't been very frank with us - their 'spawn'. Why can no Marciniak 'follower' ask where these guides REALLY live? - Why has no "Ascended Master" ever even HINTED at the parasite nature of the ET history of our DNA???)

**I Remember Union** - onward in the incomplete Magdalen memory - more archetype - less herstory.. Good clues tho about what it takes to wrap the body into genetic stillness capacitively - literally a swaddling cloth - to PROPERLY prepare to die - project the charge wave of your biological capacitance effectly into interplanetary spaces. Like Hiawatha inhabiting Niagara Falls.

**Women with the Alabaster Jar.** more on Magda..

**The Magdalen Mystery** ( by Kent in Sante Fe) privately published - showed the virgo star map of the Gothic cathedrals she outlined in the teaching dream of Bernard of Clairveaux the builder Templar. She needed to use that magnetic lens the size of huge landscapes to reproject her TANTRIC SWOON - back into the stars- because that is where the body of her love (Jesus / Tut ) now resided.

**Mutant Message** by Marlo Morgan- Do you hear your ancestors speak clearly in the song in your blood?

**Monuments on Mars** by Richard Hogland. Richard who claims to own Mars doesn't have a clue HOW paramagnetic dolmen archeologic stones WHEN placed at TETRAhedral latitudes - modulate planet spins potentially to better EMBED them in ZODIAC spin - which stabilizes the (recursive spin nature of ) GRAVITY - to hold ATMOSPHERE!!! That is 'Total Recall' and Richard doesn't have it. At least he can be a pesky dog snapping at the lie-ing heels of NASA.



**Anti Gravity & the Earth Grid** by David Hatcher Childress. Classic for seeing the dodeca shape dynamic of the vector flexing Earth grid - snapping between cube-octa and dodeca/icosahedron as it prepares to compress. The reason the rock floated up in front of the cliff face when drummed by the cacophony of Tibetan instruments was the implosive phonon triggered the rock piezoelectrics to create an inverse capacitive low pressure bubble.

**Temple in Man** - Schwaller de Lubicz / Robert Lawlor. Vincent has wondered if Schwaller could be a name change to Fulcanelli. Expensive gorgeous book shows the history of Egyptian temple complex to imitate the capacitive charge symmetry of the human gland body - to excite bliss. (they knew that DNA could radiate charge ultimate into stars- they did not know how).

**View Over Atlantis & City of Revelation** by John Michell. First place to see the Roman Pace, Megalithic Yard, Pyramid Inch, English Foot, etc., all related exquisitely in a simple Golden Mean cascade. Very good at calling the METER a profane and evil measuring system. (literally EVIL in the technically correct sense that EVIL MEANS: failure to embed - the only way to KILL anything.. ) The books fail to explain that the only sacred and therefore sustainable units of measure (musical key of all of matter) are simply multiples (EMBEDDABLE) of the wavelengths of PLANK and HYDROGEN core. (fusion).

## °GLOSSARY OF TERMS (Making “Light” of Word)

## A Physics of Self/Reference as Consciousness Glossary:

Assembled & distributed from Dan Winter’s writings by Implosion Group

**Ab-ra-ham-Ab** - from RA (Ea / Enki) Ha m. Father of all ‘religion’ from UR(u) . See Merkabbah. Story: [soulinvitation.com/enki](http://soulinvitation.com/enki)

**Algorithmn**- a consistent patterning or sequence of steps applied like a meme or information bubble or instruction sequence.

**Amp:** Name for electrical current RATE OF FLOW. (versus Volt)

**Antakarana**- Term using in the East to mean ‘RAINBOW BRIDGE’ - between spiritual dimensions- is implied. Winter uses this term at [soulinvitation.com/anatakarana](http://soulinvitation.com/anatakarana) to refer to the rainbow bridge of potential TONE harmonics he calculates to produce the perfect (but dangerous?) implosion musical chord. Rainbow bridge holds its harmonic elements together by perfect ratio phase locking them into a bridge that cascades between worlds of differing frequency domain .. literally -the SCALAR or TORSIONAL or perfect COLLAPSE wave geometry.

**Anu** - ultimate subatomic particle, depicted originally clairvoyantly in theosophy, (a 5 spin inside, 7 spin outside perfect little heart shaped ‘slip knot’) latter seemingly justified to current subatomic physics in Phillips work: [www.SMPhillips.8m.com](http://www.SMPhillips.8m.com) , morphically resonant (identical?) to human heart, and heart of the sun PURE SHAPE.

**Bardo or bardo bridges**- Refers to the shapes focused into the implosive awareness just after death. This is a time when the skill to navigate magnetism in a lucid dream is CRITICAL. The **electrical coherence** of the field effect of the heart and glands leading up to death - play the essential role in determining of biological magnetics (all soul memory) can accelerate thru light speed of perfected recursive COMPRESSION in DNA. Coherence here means sustainability - means successfully taking memory thru death. Psycho-navigation (the book is a start) is good practice - as well as lucid dreaming skill.

**Blue fire:** the collected cellular accumulations of coherent ultra-violet or blue light. Because this blue light drives DNA and mediates the most orderly metabolism, it is in a sense an ultimate product of cell biology. When gathered among glands for whole body process or massage, this blue fire becomes the stuff of eros, orgone, and sexuality. Attention/ foreplay/ massage gathers it like a snake charmed, first to the glands around the base of the spine, the so called “blue dish” . Then, if the base of the spine is open, and properly tilted, and if the heart and gland sonics are massaging the envelope sonically, they can be pumped up the spine like a straw, exploding sweetness and growth into the upper brain and crown chakra. In addition to a sweet reward natural feedback, this precipitates a field which feeds coherent nutrient to the larger Earth grid..

**Braiding:** in the sense of your lovers pony tail, only certain wave(weave)lengths will fit upon the length of the tail compared to the number of hairs. If the number of weaves fit the nest, then you may be able to braid the braid... of the braid. Each time a much longer wave is nested in a disciplined or “phase locked” fashion. On biological surfaces, this means that the information of worlds of much larger size can reach their inertia into the biology which has found a way to integrate or contain wavelengths the size of... whole glands or even continents.. into living cells. This is how emotions program DNA, and even Schumann resonance Earth waves get into trees, informing Earth’s biomass of the needs of Earth as a ringing bell inviting tuning. **Braid (Plait):** Think of ‘your lovers pony tail’. To braid is an act of nesting, the braid is the item which has been wound around itself.

**Caddeuceus (of Capacitors)**- see the shape of the breath wave ( [soulinvitation.com/exercises](http://soulinvitation.com/exercises) ) & Symbol of Medical Profession - as the geometry of the Golden Spiral - from the side view on the 60 degree implosion cone of Dodeca- = Grail cup animation = the geometry of perfect PHASE CONJUGATION!

**Cascade**- When a sequence of wave harmonics are NESTED together in the same oscillator - if their RATIO is geometrically based on PHI Golden Ratio - then their electrical energy can cascade or walk BETWEEN frequencies - IN NON DESTRUCTIVE COLLAPSE. This perfected CASCADE, in Winter’s view is the only

SUSTAINABLE SCALAR or TORSIONAL WAVE. Physics has up til now not evolved very precise language to describe Electrical inertia moving coherently BETWEEN frequencies. Winter's view is that this movement between both wavelengths and wave velocities by perfect cascading is necessary to describe how electrical charge is accelerated to MAKE gravity. ( see also IMPLOSION )

**Centripedal-** Spin CONVERGING inward. (Electrical + / compression )

**Centrifugal-** Spin DIVERGING outward (Electrical - / rare-faction )

**Cepstrum** (was mis spelled as septrum): This new technique for quantifying and measuring the INTERNAL or AUTO coherence within ANY complex oscillator may redefine the way we measure LIFE, ATTENTION, and VIABILITY in ANYTHING! Before Winter's work, physics knew of NO WAY to measure INTERNAL coherence, just coherence when comparing one complex oscillator with another . The ability now to measure COHERENCE WITHIN one oscillator - may allow us to determine for example if your genetic engineer has destroyed the soul in DNA! And to measure when your thinking is becoming ATTENTION (coherence) in a new way - to revolutionize empowering biofeedback (HeartTuner - heartcoherence.com ) Here is Winter's technique - for using CEPSTRUM to measure coherence - The - Second order Power Spectrum. You do a standard harmonic analysis - form of the Fourier Transform. Then you take that output wave describing energy density by frequency - and INPUT THAT WAVE to another HARMONIC ANALYSIS. The output wave has useful properties. The first peak AMPLITUDE measures INTERNAL COHERENCE. The Y Axis Value or position of that peak also instantly indicates musical key or fundamental (1/x). HeartTuner uses this mathematics pioneered by Winter to newly measure and feedback 1. Emotional Coherence, and 2. The moment of Empathy - when the two peak (key signatures) phase lock - or touch.

**Chaos-** what happens when waves have no boundary conditions. (disorder / opposite of awareness / unable to recur). Versus: Fractality - what happens when waves survive the ultimate boundary condition - infinite compression. (same as awareness / able to recur).

**Chaotic oscillator** - one which does not stabilize or self-organize. Winter suggests - the form of oscillation which self-organizes and EMERGES from chaos is one that learns to collapse implode by Golden Ratio geometry. Example stock market emerging from chaos at the instant it's volumes embed in Golden Ratio (Prechter / Elliott Wave) or the heart at the moment of bliss / charge attraction.

**Charge** - The ability to store the electrical potential (voltage) which exists between two plates of a capacitor - is somehow squeezed in a very shareably propagating wave - which then has the potential to send a signal to capacitors a long way away. This becomes not only the physics of radio and how capacitors pick up gravity waves ( see the Hodowanec and Ramsey data pics in the book). The point is that describing the ability to store charge (Coulombs) as Farads in a capacitor - does not begin to describe the communications potential of how that field is transferred WIDELY and faster than light between biological systems. When we wanted to measure a tree being effected by a human heart EKG in bliss - it was much easier and more replicated ( soulinvitation.com/biophoton ) to do that with a capacitor for a probe transducer - than using an inductor coil. This is simple to explain - to transfer biological information using capacitive charge - requires much lower wattage or power - than if biological had to do the work inductively. This becomes a faster than light broadcast system in Winter's view - for communing all biological information systems. Feel free to compare with the definition of charge in your physics book - and to take issue. Callahan called his idea for the probe we are using ' a biological capacitor'. Nick Thomas - student of Lawrence Edwards - agreed reluctantly that life systems closest electrical equivalent is a SPHERICAL CAPACITOR. Winter contends - Life= the ability to attract and self-organize charge. The gold plated ostrich egg he uses to measure life force (link above) IS a spherical capacitor.

**Coherence: (Co-here-and-see).** and coherent emotion. Same meaning in math, in hydromatics (wave theory), and in poetry: all the meanings or waves fit one nest in order. Suggestive of columnation, cascading, phase locking or phase discipline. Onset coherence in light is a laser, in emotion is a piezoelectric glandular mediated real felt motion ready to waltz up and down the ladder of wave ratio between worlds. There is a relationship between the poetic, the optical, the mathematical definitions of coherence. Further, it suggests our new technique of second order FFT (frequency signature OF the frequency signature), as a powerful way to access, measure, quantify, feedback, and teach COHERENCE. Consider the heart's distribution of voltage waves as if

it were a simple light beam trying hard to become so powerful as to be worthy to be called “a laser”. Then our question about measuring heart coherence becomes the same one as a laser optics physicist attempting to predict the moment at which a light beam became “coherent” enough to penetrate distances like a laser. The internal “coherence” or columnation of phases within the single beam would determine how penetrating was that beam.

So too with the heart. We know that the heart electricities effect the immune system and the environment. Therefore the more sustainable these heart “waves”, the more effective in bending their environment. So we need a way to teach people to make their heart “waves” sustainable, that is: able to reach further without collapsing as waves. We provide this “heartlink” as a tool to measure this “coherence”, and feed it back in such a way as to make it teachable.

The first peak of the second order FFT clearly rises animatedly as a persons heart coherence or heart harmonics rise in the first fft. The key step in realizing the technical meaning of the word coherence, in this regard, is to understand that a SINGLE wave or parameter in a technical sense, does not HAVE coherence.

**Coherence-** more- In a laser, when the light waves all get ‘columnated’ like soldiers walking in step. Makes them more able to travel further together since they lose less ‘spin’ on the way. Heart’s get electrically COHERENT when emotion gets COHERENT. Heart feedback (2nd order frequency signatures) measure and teach this skill. (‘Little Johnny you stay in the corner until your heart harmonic shows you have become coherent - emotionally intelligent- again’ ) discussion: [soulinvitation.com/coherence](http://soulinvitation.com/coherence)  
—more - . Note below, in the physics literature: definition of coherence:

**Coherence** A mathematical algorithm expressing a quantitative measure of the spatial or temporal relationships between two or more parameters. Simple coherence is the ratio of the square of the absolute magnitude of the cross spectral density function between two parameters and the product of the power spectral densities for each individual parameter. (For a generalized definition of coherence, including multiple and partial coherence, see Goodman, 1965.)” TWO parameters usually are COMPARED to talk about coherence. So, we could not describe the ekg as a wave as having coherence IF we think of it as a single parameter. However, if we were to consider each of the sine waves arranged in the complex series we call the frequency signature or power spectra or FFT ( of the heart voltage ) , THEN we could talk about the COHERENCE BETWEEN those internal harmonics. THIS is indeed what I believe this second order frequency plot (fft) does for the heartlink. Specifically, that the height or amplitude of the first peak of that plot, is a measure of whether those harmonics of the first FFT are evenly spaced (OR LITERALLY PHASE DISCIPLINED or coherent). What indeed is powerful here is that this technique of taking the second order FFT OF ANY OSCILLATOR , now can be understood as a way to quantify the INTERNAL harmonic COHERENCE OF ANY OSCILLATOR. What happens practically, is that the second FFT CHECKS to see if the space or PHASE between the harmonics of the first FFT are even or disciplined. If yes, then the amplitude of the first peak of the second FFT MEASURES THAT PHASE COHERENCE. In effect, this becomes an elegant tool to quantify and teach coherence.

**Collapse:** When wave structures are assembled so their symmetry of shape is SCALE INVARIANT or SELF-Similar, then they are able to non-destructively COLLAPSE. Examples are the way fractal symmetry is mathematics only infinitely COMPRESSIBLE shape. Certain things can fold up inside themselves, inside themselves infinitely. Think of the shape of the ROSE. Winter’s (radical?) view is that getting into shape to allow perfect compression (by Phi recursive wave heterodyning CONSTRUCTIVE interference) - TURNS COMPRESSION INTO ACCELERATION thru light speed - fabricating GRAVITY, IMPLOSION, and AWARENESS itself.

**Compassion / Compression** - Getting the information pattern of a feeling outside your body to share a space non-destructively with an electrical feeling INSIDE your body, becomes ultimately (& ‘topologically inside out’), a simple problem of perfect COMPRESSION. It is thrilling that we can now TEACH that - when HEART harmonics create the ‘embedable’ Golden Mean harmonics at BLISS / compassion moments!

**COMPRESSION / Pressure or Squeeze / stricture or Voltage - Winter: “The Universe consists of only one geometry of contiguous PRESSURE”**- dynamics of all wave systems (all creation), seems to be rigorously describeable as pressure changes in a universal ‘jello’ (ether). So how the pattern of “good squeezins” among those waves becomes cookbook to create ANYTHING. Examples: emotion is shape of hug / squeeze . Voltage is another name for pressure/tension electrically - the squeeze. (Tension was

Tesla's name for Voltage) Surviving death or black hole insertion or time travel seems to be simply arranging your wave to be able to survive squeezing with no destruction .. (see also 'scale invariance', & ../scaleinvariant ). Key implication here: WHY is shared compassion IDENTICAL to perfect compression.

**Con-crecence:** Surfer catches a wave. Then another wave comes up and the 2 crests ADD on top of each other.

**Cosmic fractal biocrystal-** Earlier version (simpler) of the "Star Mother Kit" (see that entry)

**Dodeca Implosion-** The dodeca-hedron is the 12 faced 20 vertex platonic solid- whose wave symmetry pattern creates the perfect extension inward and outward to make infinite 3D collapse NON-destructive. This is called 'scale invariant' - meaning you can scale it up and down infinitely with no required change of RATIO. Ratio is sacred, scale is profane. Nesting dodeca inside each other makes the perfect and only 3D fractal, and therefore infinite compressible solution to IMPLOSION.

**Ecstatic process:** any activity centering mind into body and perception in such a way as to bring all awareness into the present. This results in a concentric wave nesting of the "fractal attractor" of attention. This phase locks or brings to focus at one point, waves of increasing cascades of different length. In quantum or wave terms, this engages the principle of self-organization among pressure waves which occurs whenever they are brought to focus. This is because in wave interference patterns drawn to the focal point attracted by symmetry, order self replicates, and disorder SELF-destructs. Ecstatic process uses the activities of symmetry making in the geometry of awareness, to get attention/awareness so focused or phase locked that worlds within worlds of wave length and "embodiment" converge to share inertia or mind. The symmetry or pattern making activity necessary to attract this critical "mass" of awareness or wave front centers is enacted in the human condition on rollercoasters, in dance and ritual, in sexuality, tantra and kundalini, etc. When we get a handle on the inertia centers of wave fields of increasing size, we can make our feelings felt in larger worlds. The wave geometry or shape of feelings, thus get leverage eventually upon whole bioregions, planets, ... longer waves. When we attempt to gain this symmetry making power among waves externally by adding symmetry to synapse with chemically induced ecstasy we make certain sacrifices. Unable to fabricate our own ecstasy, we induce a fraction of the chemistry which normally just mediates instead of induces the superconduction in the brain. Brain coherence without the resonance linkage and pure intention to the larger mind, is like a top spun up without first balancing the spin point. Only the heart has enough symmetry to lock/touch the pressures and prepare the field. Human cells, and human cultures cannot survive without the informing context of disciplined ecstatic process. Formerly ecstasy was taught only by religion and cults. Now, as cancer and AIDS spread exactly where cultural ecstasy and ritual are forgotten, we must teach this outer and inner spiritual dance because the lives of our children depend on it.

**El-** one who is able to make the 'phase shift' (compression into acceleration) from matter to light. (El's versus Elohim - fallen? genetically unable).

**El-eye-phi** = life (El is the phase shift from the circle to the line - mass to energy: Making the EL or PHASE shift into the EYE or focus of PHI - recursion. This is LIFE.

**ELF magnetic Resonance,** Lo frequency ringing .. commonly Brain Waves, Heart Waves, and Schumann Earth resonance waves are all studied in the ELF frequencies under 20 or so cycles per second .. (HeartTuner sees up to 60 tho..)

**Embedding, perfect embedding-** How an egg gets immersed in the wall of the womb to get life. How the magnetism body of a cathedral needs to look like a virus (getting screwed) in order to access CATHETER - CATHARTICALLY.. the magnetic blood of the landscape its sits on. The beauty of Winter's work is he describes a mathematics (based on the Music of Phi) which allows waves systems to EMBED or nest themselves non-destructively into each other. He uses this math to predict the EKG power spectra of the SHAMAN at the moment his COMPASSION (embedding) is making him the center of gravity steering the approaching Tornado.

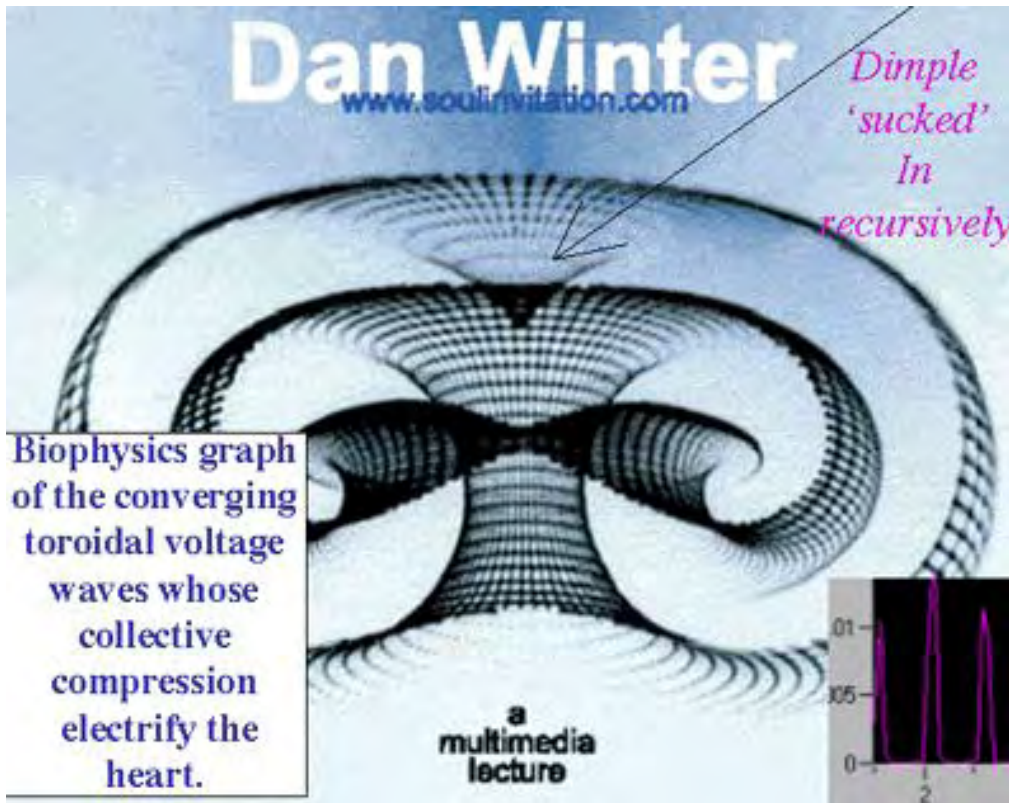

Biophysics graph of the converging toroidal voltage waves whose collective compression electrify the heart.

**Dimple:** The place where turning inside out begins. Labyrinths cause magnetism to dimple. A critical genesis of symmetry operations based on KNOWING HOW TO TURN INSIDE OUT - is required to successfully induce magnetism and/or charge to DIMPLE. At the place of DIMPLING - a tornado of charge starts. If the vortex completes the turning inside out process (implosive focus) then everything that enters is SORTED (in 'phase' discipline). ( see Implosion as the ultimate way to SORT anything! )  
 also:  
[soulinvitation.com/dimple](http://soulinvitation.com/dimple)

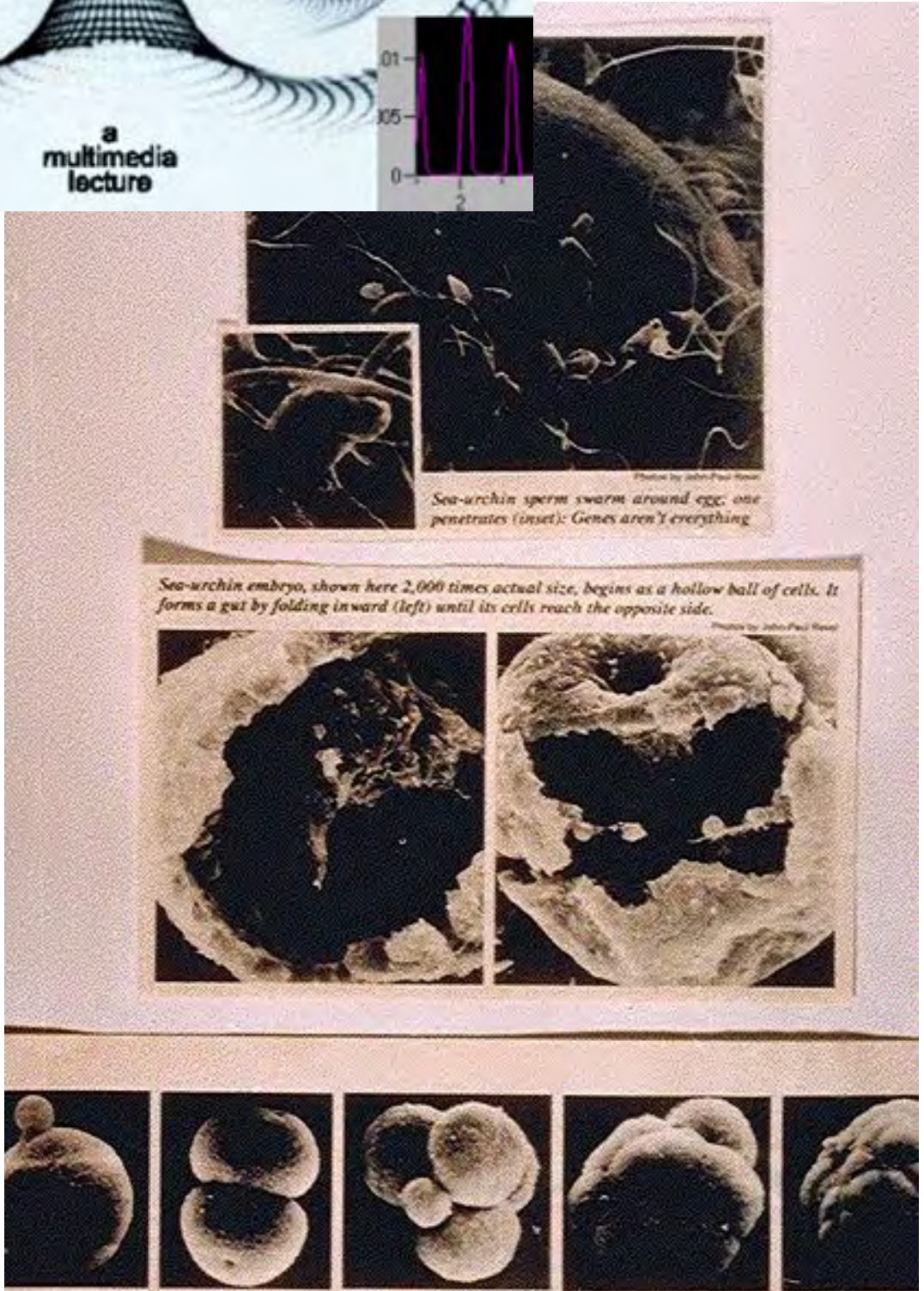

**Embedability -more - (Idealized Recursion):** The ability of a short wave to embed or nest non destructively in a larger one. Similar to Fractality. See how this is IMMERSIVE, in the sense it allows one biological oscillator to enter another. To begin the process is SELF RE-Entry, optimized by PHI, the Golden Mean.. (../physicsofphi/PhysicsofPHI.html

Similar to : Wave geometry which can SURVIVE COMPRESSION NON-DESTRUCTIVELY. This is a geometric wave picture of empathy and compassion. To Inhabit is to Embed, which is the same as “getting inside of” in order to steer. This empathic path actually starts with the electricity of the heart LEARNING TO MAKE THE FRACTAL WHICH STARTS WITH THE ELECTRICAL DIMPLING OR TURNING INSIDE OUT.

**Enochian:** John Dee sensing more possibility - after learning most languages of Earth - and amassing what may have been the planets best library - requests the angel language. An Ophanim angel knocks on his window - hands him a green stone still available in the British museum. Reasonable clairvoyance could plot the shape (symmetry) shadow of the electrical field domains in that paramagnetic stone - and these are called ALPHABET. This is the physics of the Mormon Urim and Thumin etc. With help Dee learns that recorded in that stone is the sequence of magnetic domain alphabet letter SHADOWS necessary to CALL angelic intelligence whose body of magnetism steers everything from planetary storms to galaxies. Dee was not brave enough to try these calls. This became the mis-understood high magic of Order of the Golden Dawn. ref: [soulinvitation.com/ophanim](http://soulinvitation.com/ophanim) [soulinvitation.com/enochian](http://soulinvitation.com/enochian) “Support for this idea comes from wide variety of sources. Robert Morningsky (Hopi) and Dhani Wahoo (Cherokee elder) have both identified the Ophanic script as similar to those used by indigenous ET elders, such as the Adawi. The geometrical pattern has been discerned in the mysterious Phaistos disk of Crete as well as on the pieces of Roswell debris. Even the symbols on the Stargate, in the movie Stargate, resembled Ophanic letters.” cc also Vincent Bridges.

**Ensoulment-** In Winter’s view, DNA makes a worm thru light speed up its core zipper. This is an important descriptor of whether memory will survive death, or dream entry, or shamanic journey. I believe soon we will understand a relationship between implosion hygiene in DNA that knows bliss, and what creates that connection to lightning’s wormhole, and what religion calls SOUL. (really means: SOL - as in - having the GENETIC means to inhabit the SUN.) discussion: [soulinvitation.com/ensoulment](http://soulinvitation.com/ensoulment)

**Fourier Transform / FFT / Power Spectra-** A mathematical technique (involving matrix algebra using done in a computer) to take any complicated waving oscillator and break it down into the difference pure simple single musical notes sine waves - which when put together make up the initial wave. So for example your ear takes this ‘harmonic analysis’ of a piano chord - to see if it is musical or not. (the subtler difference between an FFT and the Power Spectra will not be dealt with here). Power spectra is the complete way of describing again which harmonics or ‘musical tinker toys’ harmonic tensors - are present. (Key to HeartTuner top right screen).

**Fusion** - point at which many waves can come to phase lock at one “node” / foci. There ALL is sorted. The potential to gather more than 3 oscillating wave systems up to infinite numbers come to ONE point - perfect FUSION - seems to depend on PHI / Golden Ratio wave ratios. Discussion: [soulinvitation.com/fusion](http://soulinvitation.com/fusion)

**Fractal, fractal recursion//Embeddedness/ Fractality:** Suppose a short little wave would like to nest cozily and non-destructively on a larger carrier wave. The ratio of that “embedding” or braiding of a short on long wave would be something like the Phi-lotactic branching algorhythm of tree ness. In fact the first fractals looked like fern trees. The ratio of a short wave which can best embed on a long is in Phi or Golden Mean proportion. This is the best nesting algorhythm for waves to share spin non-destructively.

In a computer program, a “do loop” which can nest inside another, inside another, infinitely, could produce infinite recursion, or self-iteration. Irving Dardik calls this expression of a turn inside a turn: “super-looping”.

In a geometric sense when pattern or foldedness can nest inside itself layer in layer, this becomes the fingerprint of fractality.

**Fractal - more on - (/fractal attractor):** when the small part of a pattern contains a miniature of the whole pattern, it is said to be self-embedded, or recursive. This kind of symmetry among waves, permit the long, to cascade right into the same pattern in the short wave, creating a cascade or vortex or attractor. This IS Ability to Embed; EMBEDABILITY, which is the wave mechanic skill to center yourself in a wave form and steer it= TO INHABIT. (mathematically identical to compassion/empathy)

The self-sameness of the symmetry of the nucleus to the symmetry of the electron shell, for example permits the scalar spin vortex “translation of vorticity”(turning from long to short wave) we call gravity. The inertia which passes inside out through center, gives us identified in the wave lengths out here, the illusion that gravity’s cascade goes only one way. In reality what has been folded inside out into finer order in the center of atoms and planets, in the unified field of gravity’s wave cascade, becomes the bloodstream passed between planets in erotic play. This self-same scalar wave cascade “fractal attractor” by symmetry, also makes up the field nesting we call consciousness, which is born of and defined by recursion itself. The more we are occupied in our attention by the at-first-in-principle of self-embedded IAM THAT I AM, the more the fields of consciousness nest and are leveraged by our “mind”. The purpose of the ONENESS when present in one node of the hologram, draws the inertia of all to it. Thus true power is self-limiting by pure intention (or symmetry) inside itself.

**Fractality** - more- Amount of self-similarity. When the pattern inside is self similar to the pattern outside. Then the pattern can RECUR and

recur and recur. Example: heart within heart valentine eternal zoom. Example 2: Fern tree looks like 1 branch looks like 1 leaf

looks like 1 leaf tip, looks like....

**Fractionation-** (as opposite of fractality): when the order of a complex woven kind of self organizing.. anything.. is chopped up into little pieces... which all the kings horses and all the kings men can’t put back together again. Your best picture has no meaning when rendered into little pieces. How can we be nourished after we chop up all the order in our grains and vegetables before we consume them. The long wave order IS the food. Apple sauce has no tingle, only biting into the whole apple adds that kind of spin to you. Among waves, spin is the only catchment for memory. The context of the long wave is not present after the air or the water is passed through a screen or a sieve. It becomes fractionated, unbraided, and lifeless. Fractionation in cultures is called: a-part-meant, and it occurs when the long magnetic grid braids of earth are chopped up by cities where geomancy and grid engineering are unknown. The skin of Earth becomes cancerous this way.

**Gene Pools** - Everyone into the POOL, the water’s fine. The ocean accepts all rivers, but sets the final level. Because DNA is so implosive, it operates informationally within planetary gravity bubbles like ours, from a common library core. This is particularly true when enough relaxation happens to embed and ground.

**Genetic Memory** - In sacred geometrics here, emphasis is on memory in genes as storeable BECAUSE fusion / implosion in DNA ‘dodecahedral’ perfect Golden Mean PACKING, creates VERY SHAREABLE WAVES. Think of a lightning bolt down the center zipper of blissful / ensouled genetic material able to keep constant modem contact with the morphic resonance of the whole genome central internet library. Perfect relaxation into embedding yielding hi ‘baud’ (info density transfer) rate to collective mind.

**Geometry of Pressure-** since the unified field tells us of only one essentially compressible medium, then the universe is literally one contiguous folded surface and a “geometry of pressure”. Tesla called voltage simply tension or pressure. Electromagnetic voltage modulates the three other supposed “separate” and “fundamental” forces of physics. (Even gravity becomes magnetic in the monopole- cascade by ratio). We should not permit our physics to fractionate our awareness into the schizophrenia of imagining more than one substance to our universe. No data ever truly supported the hypothesis that more than one compressible unified field existed in the universe. We can see and feel that we the medium, are the message. -see Compression.

**Grok-** in the sci-fi sense of to encounter an idea, surround it with your beingness of attention, “consume it’s perspective”, and understand it all at once “of a piece”.. this is the “long wave” way of knowing, as opposed to atomized, piecemeal, fractionated dissections of knowing.. short waves.

**Haploidal DNA** - Normally cells have a full set of 23 chromosome pairs- BUT in seeds and eggs in humans - their is only one of each pair left - this HALF HELIX concept- seen like a lightening bolt - is called Haploid.



**Harmonic-** one sine wave or pure tone wave length among many that may comprise anything alive or vibrating (an 'oscillator;') The fun part is ALL oscillators only include sine waves of different lengths. see FOURIER TRANSFORM. - Any wavelength as Ratio to another. Winter refers often to harmonics in the Power Spectrum Analysis - this means which wave lengths or simple single musical SINE WAVE tones - were assembled to make the complex wave (EKG for example) which you are analyzing.

**Harmonic Analysis (Fast Fourier Transform and the Power Spectra)** - is simply a way of looking at what pure tones - musical notes (sine waves) of different lengths are woven together to produce any complex wave (everything in the universe is a complex wave - made only of pure sine waves of different lengths. Harmonic analysis -synonyms to Power Spectra & Mathematics-Fast Fourier Transform - are ways to get at the frequency recipe for ANYTHING!

& b.) why is this the most precise possible language to describe EMOTION .

c.) How is this practically applied to Spectrum Analyzing the EKG to TEACH coherent Emoting.

d.) More on Sentic and the Musical Language giving RATIO definition to the WAVE SHAPE OF TOUCH

**Harmonic Inclusiveness:** Originally known in the Heart Rate Variability Literature (HRV ) ( [soulinvitation.com/dardik](http://soulinvitation.com/dardik) ) to show that the number of different harmonics all present at once in your heart statistically predicted how fast all chronic diseases would LEAVE YOUR BODY! .. but Winter extended this to Harmonic Inclusiveness predicting the viability / vitality of EVERYTHING ALIVE AND OSCILLATING.. ( spin density. The number of different field effects spinning at once inside anything stable as a wave, shows up in harmonic analysis. The fun part is - Winter predicts the HARMONIC INCLUSIVENESS - the number of DIFFERENT HARMONICS ALL PRESENT AT ONCE (PERFECTED TO INFINITE BY GOLDEN RATIO) - equals the SPIN DENSITY - AND predicts the VIABILITY (immortality) of ANYTHING ALIVE! ( [soulinvitation.com/biophoton](http://soulinvitation.com/biophoton) )

**Heterodyning:** Quoting Rick Anderson: ( partial excerpt from [soulinvitation.com/heterophi](http://soulinvitation.com/heterophi) ) "One of Dan Winter's weird and wonderful files caught my attention one day, when I was browsing his web site. He was making remarks about how waves can, when organized in a certain way, spiral inward toward a central zero-point in the same way that Lorenz attractors occur in Chaos theory. Tying together several concepts such as implosion, fractal embedding, compression, and wave (non)-interference based on the fact that Phi-ratioed waves can both add and multiply non-destructively, he wove his tale... My ham radio hobbyist antennas went up... What did he say about "both add and multiply?....

Well, I checked, and it turns out to be very strange but true: Another one of Phi's many unusual traits is that it's the one ratio whose powers, when added together, generate the next higher in the series, automatically. Whoa.

...When you want to broadcast your voice over a radio signal "carrier" wave. To do that, you need to vary the overall intensity or amplitude of the carrier with the lower-frequency voice... you need to modulate the carrier's amplitude with the voice waveform. And the way to do that, mathematically, is to multiply the two waves together, instead of simply adding them. Just like we learned in school that you can multiply numbers by adding their powers or exponents, so when we add wave voltages against a nonlinear (logarithmic) background (in the PN-junction of a diode or transistor), we are actually doing the same thing as if we had multiplied them. Multiplication is nonlinear addition. In radio work this is called **heterodyning**.

**So what's Phi got to do with this? (Golden Mean Ratio)**

**Phi possesses the strange property of being able to automatically generate its power series when heterodyned successively with its own next-higher or lower powers!** I believe this fact is a key to many fascinating areas yet to be discovered. As far as I can tell, this trait is not shared by any other number. Dan Winter seems to be on the right track on this one, for sure.

Powers of Phi -  $\Phi^0 = 1$ ,  $\Phi^1 = 1.6180339$ ,  $\Phi^2 = 2.6180339$ ,  $\Phi^3 = 4.2360672$ ,  $\Phi^4 = 6.8541004$

Now, what do you suppose happens when we take two frequencies,  $f_1 = 1$  unit, and  $f_2 =$  a frequency that is Phi times larger, or  $f_2 = 1.6180339$ , and modulate them-- nonlinearly mix them-- in an AM modulator? The two new frequencies are the sum, which is  $2.6180339$ -- hey, that's the same as  $\Phi^2$ , and the difference, which is  $.6180339$ -- hey, isn't that Phi to the -1th power? Yup, it is. So we stumble upon the very interesting fact that

powers of Phi are automatically generated whenever we "heterodyne" or modulate two frequencies that are related by a ratio equal to Phi."

--

**Implosion-** When waves approach a common concentric place - if their symmetry is based on Golden Ratio as they compress - then their wave speeds (velocities) add and multiply 'recursively'. This effectively turns compression into acceleration - making compression non-destructive. In the process of creating charge acceleration - GRAVITY is created. The reason implosion becomes self-organizing is because the charge is accelerated thru the speed of light - creating the only effective way to sustainability for example for biology's memory. Implosion is the only way to sustain the meeting and phase sorting point for charge - and is therefore the only wave symmetry which accounts for self-sorting and perception itself. The self-similarity or scale invariant quality of implosion becomes the solution to Einstein's dilemma of infinite non-destructive compression, and the problem of cold fusion, and the puzzle of phase conjugate optics. Complex oscillators like the stock market and also brainwave harmonics - both emerge from chaos into self-organization when the musical cascade becomes Golden Ratio - this musical recipe to successful collapse - also becomes the definition of self-aware systems in general. To become self-aware is to self-refer is to self-re-enter is to implode.

**Incunabula** - A time travel experiment in New Jersey - instructive in the physics of charge compression to accelerate genetic fields thru light speed. Particularly insightful on role of sexual energy.

[www.earthportals.com/Portal\\_Messenger/winter.html](http://www.earthportals.com/Portal_Messenger/winter.html)

**Inertia-** the tendency for movement to continue in its path. We measure the amount of inertia stored by waves when persuaded by symmetry to go in circles, and we call this mass or matter.

**Inhabit-** To RECURrently reenter as a wave. "Breath" of el-eye-PHI. (Similar to - to be able to self refer and thus recur.)

**Laminar Coherence-** Water, like Grief 'Phi-Lo' dough when sacred, charge dense, and alive, contains a layering sheeting action of order - that means the spin is nested nicely in self-referential spinning layers - Fed by braiding, destroyed by hi pressure, metal contact, hi temperature, pollutants etc. When you knead your bread to bless it - you always ADD FOLD you NEVER TEAR IT!

**Lingum:** Calcium like exipient (comes out the mouth sometimes) pushed up by the sound current of Kundalini pushing up and clearing out the spine pump canal for bliss.

**Lo-phi= love** ( Long waves in Phi ratio create maximum embedding. To embed in someone outside you as if there were inside - the science of LOVING! ) - more - **Lo-phi (love)-** . When the nest of electrical and sound pressure fields around the heart converge in golden mean ratio wave nests, then unlimited information transfer between worlds can cascade. Waves find this arithmetic and geometric heterodyne or beat note non-interference pattern, most touch permissive. EL-(the turn or phase shift) (in)LO-(frequency)PHI-(ratio). The PHI or golden mean ratio has been found in the frequency between harmonics of the heart at the moment of sending love, and (in the "Sentic" measurements of emotion) in the ratio of the moment of maximum pressure in the shape of the hug or squeeze you give to send love. The soft V sound in love suggests the fiveness from whose square root PHI is derived, and from which the wave softness or touchability of love radiates.

**Meditation-** For the same reason you don't buy a used car from a salesman with shifty eyes - you learn to settle the charge of your attention into total phase lock - rapt-ore. - in order to distill pure (distributable because of coherence) INTENTION. This process of discovering which waves of charge about your body have enough symmetry (coherence) to become sustainably agreeable to each other - is called meditation. **Before you sleep try lying very still after deep breathing - until you feel your body begin to tingle. Notice how your cells are younger after the taste of charge density.**

**Merkabbah Tetra Meditation-**, The term Merk was originally used for Ea (for whom EArth was named). (Ref. book-'Secret Places of the Lion'). He was called ENKI and also RA the SUN GOD. AB- means FROM. AB-RA means from EA's (Enki) blood line - Ab-ra-ham the father of all religions. (Wife - Sara means ASSA

URU - female dragon.. di-as aur, il uru, uru-shalaim, UR the 'city' of Ab RA ham. The KA was the name for the COHERENCE of you auric charge field -when ordered enough to become navigable. Your KA is your vehicle (hopefully into star entry) from which comes our term Car. Ab-bah (Ab-Ptah) means from EA or from FATHER or from PRESSURE. The only MARK which pressure can make (stand as wave) is the MERKABBAH geometry of perfect field implosion caused by perfect self-awareness / self re entry. The classic star tetra tetra-hedral fire breath meditation leaves your aura primed for parasites - if you do not complete the star tetra cube 32 degree tilt of your head (chin tilt of sphinx) into dodeca. This sets the Golden Ratio into your field (edge ratio of the cube to the newly born dodeca). Do it WHEN you have found something inside which is shareable. Without implosion - you become food for something outside you. ref: [soulinvitation.com/merkabbah](http://soulinvitation.com/merkabbah)

**Microtubule-** The tiny hair like fibres which dance into a beautiful heart shaped array to choreograph the dance of cell division. Stuart Hameroff says they are self-aware. Michael Heleus says their concentric membrane tubes radii are Golden Ratio. Wave guides to implosion do become part of essential self-awareness.

**Morphic Resonance-** Resonance or information inertia transfer among wave systems which is enabled principlly or **purely by SIMILARITY OF SHAPE ALONE..** (Made famous by Rupert Sheldrake, etc.). For example there is good physics to the witch creating the right kind of doll to effect a human of the same shape. Or a zodiac map of Orion having the shape of major architecture on Giza, causing a bleed thru of powerful energy.. (across spectra.).

**Morphology -** SHAPE ology. Morph also means to CHANGE shape.. shape 'shifting'. In our unified field cosmology we say since everything is made of the same universal substance, SHAPE (morphology) is the ONLY thing we have EVER had the privelege of NAMING. (Important to remember when you start understanding how the hearts philosopher's stone turns other atoms into gold. / biological transmutation is at heart limited only by the steerage INTENTION provides to waves!)

**Non-Destructive Interference-** As all waves or frequencies cross each other in the universe, they are not just ships passing in the night. Each time they truly cross paths and "share spin", they have kids. The making of children among waves is called (appropriately) "conjugal" relations. This means they coming into the touch or focus point for two waves, creates a continuous SYSTEM of interference. This is called "heterodyning" or beat note interference. What's neat is that each time waves do this crossing and touching, they must ADD each others wave lengths repeatedly, if the wave lengths of those children waves is to still fit the pattern of the wave nest and not fight. When the continuous repeated adding of the wave lengths is RECURSIVE (able to always RECUR), this effectively means that in addition to adding each others wave lengths (AND velocities), that the waves begin to both ADD AND MULTIPLY each other AT THE SAME TIME. This produces the perfection of this EMBEDDING OR NESTING, which is a BRANCHING PATTERN which is repeatedly PENT (re-pents), in all PHI RATIO. This PERFECT BRANCHING in all PHI ratio in NATURE is called "PHI-Ilotaxis, and it the way leaves unfold in plants based on the GOLDEN MEAN, to PERFECTLY SHARE the light. (Later this branch was called SCION, or the Priori de scion.. jon, john.. perfect branching in the blood). So as all waves pack, they must arrange themselves into a symmetry (a pattern) where their inertia, their "nodes" do not cancel each other. In order to get the maximum number of wave nodes or peaks "nested" in ALL CONSTRUCTIVE interference, branching by GOLDEN MEAN ratio- ELIMINATES DESTRUCTIVE ADDING AND MULTIPLYING OF THOSE WAVES. The result is "in-PHI-knit" all CONSTRUCTIVE interference which in the long wave phi ratio (lo-phi wave) is CALLED: "permission to touch" for waves! Note that the wave form for love on the HeartLink and in the Sentic music literature appears to both use the GOLDEN RATIO interval.

**Orgone** (cloud buster etc.) Wilhelm Reich - correctly discerned that human sexual and biologic charge could be conveyed by properly layered concentric dielectric structures. (Organic vs inorganic for example). He badly isolated himself and alienated science by mis-naming that quality of capacitive charge - as Orgone. It is however true that capacitive charge fields which contain biological intent - have a different qualitative feeling that purely mechanically created ones. However - even this difference shows up beautifully in the spectrum analysis of the charge field dialectrically- ( [soulinvitation.com/biophoton](http://soulinvitation.com/biophoton) ) where the onset of PHI based recursion differentiates showing the presence of INTENT and infinite connectedness. This is reflected in Reich's useful but limited insight that convex versus concave capacitive structures became projective for this charge. He did not perceive this was the beginning of the symmetry to create self-similar recursion so necessary

to complete the collapse compression of charge into acceleration (projection) - and the MAKING of gravity. As noted elsewhere, his 'Function of the Orgasm' classic thus misses the possibility that conserving orgasmic potential electrically could actually serve a biologic necessity ( finding a way for biology out of the mortally fatal condition of being stranded un-sustainably BELOW the speed of light). In other words - Reich did not know the transcendent physics of bliss / tantra and kundalini. ( repeating: "suggesting repeated orgasm as cancer prevention is like deciding the only solution to leaky plumbing is lower water pressure").

**Para-magnetic Rock** or material which bends magnetism COHERENTLY like a lens steers light into ordered pattern. Examples - limestone or quartz based stones - often used for sacred space in matriarchy. As opposed to di-magnetic. stones which FRACTIONATE (break up) magnetic lines like a sieve or a screen. Sandstone for example.. often used in non-touch permissive patriarchal sacred architecture.

**Phonon Ponytail** - when sound travels in liquid it is call a phonon wave. When the heart sounds trails thru living cells it leaves eddy's in the liquid current which are literally the decision tree for DNA braiding.. which looks like a loving pony tail, when there is love. DNA's decision tree selecting which codons get access to replicate, is therefore literally a (n emotional) matter of the HEART!

**Phonon Wave:** Sound traveling in liquid (like the sound of the heart traveling in glands and cells for example).

**Piezoelectric:** Refers to the electrical quality of certain helical structures ( quartz and DNA for example) - which because they act like a 'slinky' - they convert MECHANICAL PRESSURE (called stricture) to electrical voltage. In a way you could oversimplify and say the helix connects sound to light - by virtue of the way the slinky connects the long wave (pressure - sound of heart for example) to shorter wave voltage. Visualize the ends of the slinky when pulled out - cause the sides of the slinky (the shorter wave voltage) to pull IN just a little bit. Thus - the slinky is a mechanical way for nature to couple: LONG WAVES TO SHORT WAVES. Can have VERY profound implications if understood in DNA's ability to translated the sound pressure of emotions ('phonon') into voltage waves in the cells programming.

**Phase Conjugate Mirror-** A split laser beam is steered back into annihilating itself. If the medium it meets in is 'non-linear' (molecular self-similarity) - then that mirror surface bounces all light back onto its own angle of incidence - creating negative time, negative gravity etc. Spin path required for perfect conjugation is perfect implosion. See implosion. 3D animation: vector path for light beams - see pine cone shape in [soulinvitation.com/grail.html](http://soulinvitation.com/grail.html)

**Phi / Golden Mean-** The ratio series ... .618 (033989...), 1.0, 1.618..., 2.618..., etc. Progression can be derived by adding any two numbers to reach the next OR by multiply any number by 1.618... to reach the next. The only possible ARITHMETIC (adding) and GEOMETRIC (multiplying) progression. Produces perfect growth path (PhyLotaxis), and Golden Mean Spiral. Main subject of all geometry in Winter's work.

**Phi-Cycle = physical** (When cycles are in PHI ratio they create compression - or density: thus 'Let's get PHiCycle / Physical means to get grounded or embedded - to meet where the waves converge.)

**Philotaxis** - (Phylotaxes) Refers to perfect branching in nature. 1,2,3,5,8,13 etc. Leads to GoldenRatio, Creates perfect UNpacking - and therefore perfect PACKING. From the point of view of the leaf- learning to SHARE the light - it is MAXIMUM EXPOSURE , MINIMUM SUPERPOSITION.

**Phire:** Winter's name for FIRE: implying the role of Golden Mean Ratio (Phi) in sustaining the flame. (see Implosion). "Mind Inhabits PHire".

**Psychokinetic-** refers to thoughts and emotions which effect matter directly. Able to bend waves (steering implosion) with your mind.

**Radiant Charge (Life Field)-** when the emission path for charge or capacitance (or sound or light or... any spectra).. look like the Sufi heart within heart with wings (see animation), the radiance of that charge can continue forever with no inherent resistance. Acheiving this 'perfect INSIDE is the OUTSIDE', as the mechanism of bliss, is a teachable SYMMETRY skill in how the heart learns to shape it's field. Here fabricating perfect IMPLOSION makes a fire that consumes only what is NOT shareable, and becomes the

PHIRE mind 'inhabits'. When you see someone radiant, think: 'was it great caring about others' that lit the fire which sustained itself? How is the electrical solution to radiance the SAME as the psychological one?

**Recursive / Recursion:** In a computer program - when an instruction in the sequence calls for the program to put the sequence of actions within itself within itself... SEE FULL PAGE PICTURE->**Recursive or recursion:** (see also non-destructive wave interference): When any system or wave is taught to re-enter itself in such a way that it keeps coming back to the same center point, that steering for spin pattern, is said to be "able to recur". Thing of the little bit of magnetism coming out the top of your heart like a squeezed beet. When the magnetic squirt gun learns how to send the head of its energy worm back down around the vortex donut in such a way that it is never lost on the spin path back into itself, it is then "self-embedded", or RECURSIVE. (See ANU/Heart/Heart of Sun 7/5 spin perfect implosion slop knot clairvoyance maps ../heartsun/HeartofSun.html This in-side out skill to steer a wave back into itself is also called SELF-reference. This is the wave geometry of self awareness. A golden mean spiral is the only way a wave can re-enter ITSELF non-destructively. So to recur and thus self-reenter self-aware, is the skill to make magnetism squirt into that perfect GOLDEN MEAN valentine.. the EM(bed)PATH.

**Ritual-** What a short wave does in order to become part of longer wave - DNA dancing during cell division is a good example. The result is charge enveloping and distribution. Another example might be the Sun toasting all living DNA on Earth as part of her orgasmic compression (The solar maxima called RAPTURE by Christians) in order to discover which genes can steer her.

**Scale invariance-** shapes like the Russian dolls - or the layers of an Onion which do not change during compression. Critical to surviving compression - into acceleration and sustainability. All Earth structures not scale invariant will probably be destroyed by heat during SOLAR maximum.

**Self-Not/Self-** Has been used to describe the membrane of separateness or the cell wall or the human skin, which make up the immune system. As a wave mechanic, all dividing membranes are comprised of woven fields whose phase coherence or wave order determines how long till the bubble pops. Add spin and you add life to the bubble. The index to which spins can be added to the surface of a bubble, is which spins can be superposed on the surface of symmetry itself. Forests get a sonic skin when the bioacoustic habitat contains ALL frequencies. Emotions missing from the spectra of the cell membranes surface, tell us which wave length doorways are unlocked in the self-not self.

The Mathematical name for the principle that cell membranes are composed of only the waves which "make music"/phase lock, together, is called "Structural Stability and Morphogenesis". In human terms this means that membranes- self/not-self are neat woven blankets which occur when the waves of emotion/feeling nest in harmony. Practically, this means that if there is one harmonic missing from your voice ("Signature Sound Works"), or one harmonic missing from your brainwaves (Marty Wuttke/the end of addiction), or one emotion missing from your choice of what you can FEEL, then there is a hole in your blanket, or rather, cell membrane.

**Self-Reference/Self-Awareness-** You were getting angry, then you became aware, that you were AWARE you were getting angry... then you became aware that you were aware that you were aware.... you were getting angry. Each time you got outside yourself to look at your self, you got more perspective or context in your understanding of your own anger. As a result you had more ability to steer the direction of your emotion with a large horizon of awareness.

The only angle at which a wave can re-enter itself or refer to itself non-destructively is the phi spiral. This then is the optimal geometry of self reference or self awareness. It becomes measurable in the magnetic angle of the hearts "wings" at the moment of compassion or embedding. It becomes evident in the PHI harmonics of the brain and heart at the moments of peak awareness.

**Sentics-** Manfred Clynes ( [microsoundmusic.com](http://microsoundmusic.com) ) book and work on the SHAPE of the PRESSURE wave of TOUCH which IDENTIFIES EMOTION globally. Touch the violin string in the right way, people weep when you play. Winter did a geometric analysis of Clynes waves to simple sacred ratios at [soulinvitation.com/touch](http://soulinvitation.com/touch)

**IN ORDER FOR ALPHABET LETTERS TO WORK AS LITTLE REPRESENTATIONS OF BIG OBJECTS, EACH LETTER MUST BE A PERFECT "LITTLE FRACTAL".. SO THE LITTLE SHAPE OF THE SYMBOL IS A FRACTAL "ZOOM SHOT" OF THE BIG OBJECT IT REPRESENTS. THIS EQUATION SHOWS THAT THE GOLDEN MEAN SPIRAL MAKES THE BEST RECURSIVE FRACTAL PATH TO CONNECT BIG TO LITTLE. STAN TENEN'S BIG MISTAKE IS NOT ACCEPTING THAT THE GOLDEN MEAN SPIRAL HAS TO BE THE BEST WAY TO MAKE SYMBOLS AND PERMIT OUR SYMBOL SHAPES TO EMBED OR NEST IN THE WORLD**

After receiving my original book and assembling my model of the unpacking of the tetrahedron in his lab, Stan Tenen invited me there. During that visit, witnessed by Lorin Kiely and Stephanie Sutton, Stan Tenen kept insisting that he had not determined the critical part of the geometric keys to the self organizing alphabet of symmetry. This was WHAT mathematical spiral to use around the self-organizing donut, and how to model it in computer. I knew at that time that the Golden Mean spiral was the most self-evident solution to the problem of self-organization. I also knew that the Golden Mean spiral best solved the problem of embeddedness or nestedness, which was what symbolic alphabets needed to be in order to make true "morphic fractal" shape pictures of objects outside your head.

For example, consider the re-entry form:

Louis Kauffman's: "Self-Reference & Recursive Form".

$$\left[ 1 + \frac{1}{\left[ 1 + \frac{1}{\left[ 1 + \frac{1}{\dots} \right]} \right]} \right]$$

Here, we use the arrow to indicate the point of re-entry, a possible nuance of meaning for the original self-pointing arrow. The notation with brackets and arrow line pointing to specific locations of re-entry is used recursively with the first convention: the sign of enclosure is erased.

EXHIBIT C

Thus, in the case of the continued fraction we have the recursion

$$F(\curvearrowright) = F(F(\curvearrowright)) \quad \left[ 1 + \frac{1}{\left[ 1 + \frac{1}{\left[ 1 + \frac{1}{\curvearrowright} \right]} \right]} \right]$$

and corresponding sequence of numerical approximations

1,  $1 + \frac{1}{1}$ ,  $1 + \frac{1}{1 + \frac{1}{1}}$ ,  $1 + \frac{1}{1 + \frac{1}{1 + \frac{1}{1}}}$  and in the limit

Dan Winter- on RECURSION

in his paper describing his unique PHI mathematics derivation of the Hebrew Alphabet.

$\left[ 1 + \frac{1}{\left[ 1 + \frac{1}{\left[ 1 + \frac{1}{\dots} \right]} \right]} \right] = \frac{1 + \sqrt{5}}{2} = \text{Phi Golden Mean (1)618...}$

(1, 1, 2, 3, 5, 8, 13, ... Fibonacci series)

$$\left[ \curvearrowright \right] = \left[ \left[ \curvearrowright \right] \right] = \left[ \left[ \left[ \curvearrowright \right] \right] \right] = \dots !$$

"This is a mathematical image of the condition of PURE SELF-REFERENCE"

Ref: Merrell-Wolff, 1976, in Louis Kaufmann's "Self-Reference and Recursive Forms".

The formula for the Golden Mean Spiral is the "image of the condition of pure self-reference", or self-embeddedness. This has to be the correct shape to permit symbols, letters, to embed us in our world. Because Stan Tenen chose not to use this shape to create letterforms, his work is fundamentally flawed.

**Septum (see Cepstrum)**

**Shareable** - able by nature to be distributable... in the psychological sense - an emotion which could be shared 'non-destructively' as in perhaps a very universal perspective, and in the related physical sense a wave form which by its nature could be passed without resistance among all the rest of the waves of the universe... in essence: pure symmetry. Note this requirement to reach essence and shareability seems to imply necessarily: perfect compressibility!

**Slipknot** - knot theory becomes consciousness theory as recursion learns to hold a wave shape.. "Kauffman" work Univ Chicago, etc. Essentially if you can see the wave shape as a boy scout variety sustainable slip knot, chances are you have the chutzpah to do it with the ethers in your heart to so create matter out of light: "slip (k)not cosmic donut maker". (Most people know what a slip knot is, however knot theory becomes profound pure wave principle of creation when we understand that this is how waves get enough of themselves going into rotation to store inertia - the ONLY way to CREATE mass... or ANYthing!).

**Spin Density.** The number of different field effects spinning at once inside anything stable as a wave, shows up in harmonic analysis. The fun part is - Winter predicts the HARMONIC INCLUSIVENESS - the number of DIFFERENT HARMONICS ALL PRESENT AT ONCE (PERFECTED TO INFINITE BY GOLDEN RATIO) - equals the SPIN DENSITY - AND predicts the VIABILITY (immortality) of ANYTHING ALIVE! ( [soulinvitation.com/biophoton](http://soulinvitation.com/biophoton) )

**Spin, spin path.** Rotation is the only way waves create both mass (inertia storage) and time (relative rotation measured). The universe is made of nothing except waves spinning.. the fun part is discovering self-awareness born when waves learn the PATH TO SPIN - back into themselves - to feed their own tornado. (See tornado steering in book).

**Star Penetrating (STARGATE)** - The same symmetry cookbook for waves getting 'screwed in right' to go thru stars, which were the glyphs in STARGATE movie, are the true Enochian alphabet. The gravity furnace in star cores is the only effective star entry slingshot available for gene/gland magnetics gone faster than light (souls). Once we know perfect recursion/embedding solves Einstein's dilemma of perfect implosion, we shall have the map to all hearts of gravity. Recommend keyword search on 'landscape zodiac' for examples of how star penetration is aided by magnetic maps on the land - sacred space as morphicly universal / archtypal.

**Star Portals-** Where Magnetism dimples, compresses, accelerates, turns inside out. Similar to wormhole. Examples: Deep Space Nine, Phaistos Disk, The letters from Enochian used in the movie STARGATE - to MAKE the gate. (By angling flux lines correctly to navigate implosive compression non-destructively).

**Star Mother Kit-** A zen experience of assembling the most profound possible sacred geometry. You begin by assembly a **green pair star tetrahedra / star of david. Then you assemble a cube around that, a dodecahedron around that, then stellate (PHI extend all edges straight out) to icosahedron, then! stellate that -AGAIN by PHI extending all edges straight out to the ultimate embedding recurring 3D fractal dodeca!** [soulinvitation.com/tools](http://soulinvitation.com/tools) [heartcoherence.com](http://heartcoherence.com) [soulinvitation.com/kit](http://soulinvitation.com/kit)

**Stellation-** When you extend the straight outer line edge of one icosahedron STRAIGHT OUT from both ends by GOLDEN RATIO - you make a dodeca. Then do the same thing again on the dodeca - **you make icosah!** That is called STELLATING. Imagine you were extending the lines on each face of the icosahedron to add a triangular hat or cone, then putting a similar but pent hat or cone on each pent face of the pentagonal dodecahedron. **Best understood by seeing or better building - the star mother kit.**

**Sub atomic level** - smaller than atoms. (Referring mostly in sacred geometry studies to pure geometric models of the symmetries which link bosons - items inside the nucleus. Chemist Moon for example at Univ. Chicago showing the parts inside the nucleus arrange themselves like the platonic solids, even like the shells of the electrons...)

**Superluminal DNA.** various studies (William Pensinger & others [soulinvitation.com/superDNA](http://soulinvitation.com/superDNA) ) suggest DNA propagates electrical fields measurably faster than the speed of light. This fits Winter's hypothesis that DNA is self-similar and braids electrically to implosion.

**Sustainable Wave** - patterns among waves (in other words everything that is), which by virtue of symmetry - keep on waving / last forever. Sustainability in architecture for example, ultimately is a pure symmetry issue of how to make ALL structural interference NON-destructive. (Clearly points to self-embedding as the ONLY way architecture OR data EVER become perfectly compressible and THEREFORE sustainable.)

**Tingle**- What you are supposed to FEEL when you put your attention in your little finger. If you attention delivers implosive CHARGE DENSITY - by leveraging waves into agreeing on a meeting point - then you qualify to begin the bliss dance. The same electrically potent physics of charge delivery into a TINGLING field effect of presence - (implosion created by mind among waves learning to persuade waves into agreement) - predicts the soon arriving day you will bend and steer stars with the same force of attention. Kind of makes you TINGLE to think about it doesn't it.

**Torus Donut**- The figure 8 rolled into 3D makes a donut shape field effect - which is a subset of every shape in physics. The donut shape in science is called TORUS - In hydrodynamics (the science of how fluid flows) the torus donut is the only shape which is self organizing. Learn how to tilt them into nesting - and presto you are divine creator of the whole atomic table.

**Unpacking** - only certain shapes can unfold perfectly forever - consult a rose for details, then steer your heart accordingly?

**Volt**: Name for electrical pressure or tension. (Hydrodynamic pressure model of electrical circuits is literal according to Winter). (**versus AMP**)

**Vorticity** - The study of what happens to all waves shortly after you pull the plug in your bathtub: a vortex forms. The shape of where each molecule goes in a path down the vortex throat is a rich study in 'how vorticity TRANSLATES movement' from a line in one plane to a circle in a perpendicular one. The perfect way to do this is GOLDEN MEAN ("yellow brick road to oz") and in my view originates the fine structure constant.

**Waveguide**- Dratch says the best microwave amplifier he found for hi gain to pick up the microwaves which measured kundalini from the spines ATP - was an etching off a pyramid wall... Which Callahan says is steering microwaves for insect navigation. Now THAT is a waveguide. Want to learn hi ceremonial magic - symbol function - study microwave amplifiers / waveguides. What is a wave guide? Everything.

**Wormholes, String Theory, Song Lines, Dreaming Tracks, Shamanic time tunnels** - Their physics (symmetry) IS their psychology: When charge tornados well into recursion - it create long COHERENT and penetrating little twisters. These are how mind / consciousness /self-awareness penetrate thru the speed of light into gravity making time travel. It begins that electrical self similarity fabricates information rich charge compression - that gives rise to the electrical phenomenon we call mind or awareness - which inhabits and preys on centers of charge implosion - Until - genetic evolution into consciousness learns to pay it's debt to the gravity of that recursion on fire, and begin generating the gravity making self-centering force of self-awareness that holds these gravity charge wind tornados TOGETHER .... between atoms, between villages, and then between stars.

**Wratchet**- DNA is a 'wratched dodecahedron' This means the dodeca shape has been stepped down a spiral staircase like slinky. Ten times the dodeca stops each full turn while falling down a spiral stair. This marks the symmetry of DNA - a DODECA which has been spun into a symmetry in the next axis of spin ( next dimension).