

Frontier Missions: Peacespace Dominance



A Research Paper
Presented To

Air Force *2025*

by

Lt Col Thomas F. Baldy
Maj Joseph T. Callahan III
Maj Louise A. Christ
Maj Teresa L. Dicks
Maj Kelvin P. Kearney
Maj Matthew A. Parks
Mr. James L. Pullara

August 1996

Disclaimer

2025 is a study designed to comply with a directive from the chief of staff of the Air Force to examine the concepts, capabilities, and technologies the United States will require to remain the dominant air and space force in the future. Presented on 17 June 1996, this report was produced in the Department of Defense school environment of academic freedom and in the interest of advancing concepts related to national defense. The views expressed in this report are those of the authors and do not reflect the official policy or position of the United States Air Force, Department of Defense, or the United States government.

This report contains fictional representations of future situations/scenarios. Any similarities to real people or events, other than those specifically cited, are unintentional and are for purposes of illustration only.

This publication has been reviewed by security and policy review authorities, is unclassified, and is cleared for public release.

Contents

<i>Chapter</i>	<i>Page</i>
Disclaimer	ii
Illustrations.....	v
Tables.....	v
Preface.....	vi
Executive Summary	ix
1 Introduction.....	1
2 World Trend	5
Battlespace Trend.....	6
Domestic Trend	7
Somalia	7
Haiti	8
Bosnia.....	8
Summary	9
3 Concept Description	13
Situation Assessment	13
Rules and Tools	16
Constabulary, Education, and Infrastructure (CEI) Concept.....	17
Constabulary	17
Lift	17
Advanced Intelligence, Surveillance, and Reconnaissance.....	19
Command, Control, Communications, and Computers	21
Air Dominance.....	22
Education	25
Infrastructure.....	27
Summary	29
4 Concept of Operations	34
5 Recommendation.....	37
Conclusion.....	39
<i>Appendix</i>	<i>Page</i>
A Criteria for Intervention	41
B Underlying Technologies.....	42
Aircraft and Propulsion Volume	42

Attack Volume	43
Directed Energy Volume.....	44
Mobility Volume.....	44
Sensor Volume.....	45
2025 Study	46
Pyrotechnic Electromagnetic Pulse (PEP).....	46
Noise.....	46
Mission Pods	46
Inflatable Workspace	46
Force Sustainment.....	47
Steerable Pallets	47
Remote Presence.....	47
Air/Land Assault Craft.....	47
Advanced Tactical Transport.....	48
Camouflage	48
Long-Duration UAVs	48
Anti-sniper Planning	48
Multipurpose Unmanned Aerial Vehicle	49
Chameleon	49
Improved Body Armor	49
Unmanned Mini-Helicopters	49
Personal Identification Friend or Foe	49
Bibliography.....	50

Illustrations

<i>Figure</i>	<i>Page</i>
1-1. Operational Environments	2
3-1. Digital Cultural Map.....	14
3-2. Intervention Candidates	15
3-3. Lift into Peacespace.....	19
3-4. Advanced ISR in the Peacespace.....	20
3-5. Security Assurance Force Fire-Free Zone.....	23
3-6. SAF UAV “Constellation”	24

Tables

<i>Table</i>	<i>Page</i>
1 Concept Overview.....	3
2 Lift Objectives and Technologies	18
3 Advanced ISR/C ⁴ Objectives and Technologies.....	21
4 Air Dominance Objectives and Technologies.....	24
5 Required Education Technology	26
6 Required Infrastructure Technology.....	28
7 Responsibility for SAF.....	39

Preface

This paper advocates the creation of a small, rugged composite force uniquely organized, trained, and equipped to preempt conflict. Obviously, advocating the creation of anything at a time of drawdowns and fiscal reductions draws fire. Therefore, we were not surprised to receive comments like the following: “Not one bullet, not one body would I give to this mission!”¹ However, we were surprised when a four-star general officer made this comment:

This is an easy paper to reject, but [it] has potential far beyond what it appears. DOD “fights” to avoid being committed to irresolute or humanitarian crises or violent situations—Rwanda/Somalia types—and this paper presents the seed corn of a way *out* of this traditional problem. In fact, it offers a “fix” for a festering US military/DOD problem.²

If Carl Builder, Samuel Huntington, Robert Kaplan, Alvin and Heidi Toffler, and Martin van Creveld are correct, the world will be a very unstable place in 30 years, filled with challenges for US leadership and to US preeminence.³ Each author presents thoughtful constructs to examine the environment we may encounter in 2025. Creating a force to preempt conflict depends on a variety of factors. These include enabling technologies, new or revitalized doctrine, and cold analysis of national interest. Most importantly, this concept requires a reorientation in the way we think about the military and its application of power. This paper explores an uncertain era and offers solutions that will stretch the imagination of the warrior and, we hope, preserve his or her life.⁴

Notes

¹ Anonymous general officer comment on **2025** Team I, “Frontier Missions” white paper draft (Maxwell AFB, Ala.: Air War College/**2025**, 1996).

² Anonymous four-star general comment to *2025* Team I, “Frontier Missions,” white paper draft (Maxwell AFB, Ala.: Air War College/*2025*, 1996). Certain caveats accompanied this statement. We present these in their entirety below:

We should work this paper from the perspective that:

- This is a likely continuing demand.
- UN peacekeeping ops fare poorly because they are ill-conceived (using warriors to enforce peace) a mismatch of concepts, training, weapons, tools, etc.
- Certain UN members are well-suited to this “policing and control” type of operation—Japan, Costa Rica, Sweden, etc.
- Japan has recently said they are looking around for ways to participate that don’t violate their constitution.

This is a *match*:

- Work up as a US/State/DOD proposal for UN sponsorship. Concept is *trained* peacekeepers (consistent with culture from which they are drawn).
- Supervision is civilian (UN secretary).
- Exercise *police* powers, not military force (but “uniformed” police).
- Use rule of law as basis for order and discipline.
- This is a career force with permanent hierarchy that organizes, trains, and equips in nonviolent peace operations.

If/when conflict (organized, militant, military) starts, they exit; shooters enter; command and control shifts from civilian to military; rules of engagement change to combat, not peacekeeping.

Bottom line: paper is a sleeper, easily rejected out of hand. When the paper is ready, it should start up the tape to CSAF and the Tank . . . potentially *bright* future.

³ In addition to the authors cited, *Strategic Assessment 1996, Instruments of US Power* also discusses the uncertain future. Institute for National Strategic Studies, (Washington, D.C.: National Defense University Press, 1996).

Unpredictable change is what our nation’s future national security dilemma is all about. Appreciation for this uncertainty is the beginning of wisdom in the post-cold-war era. Not only is international politics in flux, but, furthermore, technological breakthroughs relevant to national security are occurring with greater frequency and with more substantial impact than ever in history.

INSS authors lead off their warfighting instruments chapter with *unconventional military instruments* and *limited military intervention*—perhaps an indicator of priorities to come.

⁴ We would like to thank some of the people who assisted us in this venture: The Honorable Verne Orr, former secretary of the Air Force; Gen Michael P. C. Carns, former vice chief of staff of the Air Force; Lt Gen Anthony C. Zinni, I Marine Expeditionary Force commanding general; Lt Gen C. C. Rogers, Jr., USAF Retired; Maj Gen Donald W. Shepperd, Air National Guard director; Brig Gen Howard J. (Foot) Ingersoll, Air Force Special Operations Command vice commander; Col Richard Szafranski, *2025* study director and Air War College National Military Strategy Chair; Col Joseph A. Engelbrecht, Jr., *2025* research director and AWC professor of conflict and change; Dr. Grant Hammond, AWC National Security Strategy Chair; Dr. James Winkates, AWC senior curriculum advisor; COL John Alexander, USA, Retired; Lt Col (Dr) Federico J. Rodriguez; USAR, professor of graduate education at California State University, Dominguez Hills; Dr.

Larry Cable, associate professor of history at University of North Carolina, Wilmington; Janet and Chris Morris, authors; Majors Mike Foster and Ralph Millsap, Air Command and Staff College faculty; and fellow students—LCDR Alton Ross, USN; Maj Guy Razor, USAF; and Maj Mike Irwin, USAF. Their invaluable inputs allowed us to integrate warfighter needs with visionary concepts for the future.

Executive Summary

Two challenges lie before us: first, to guide, harness, and balance force and diplomacy as we enter the 21st century, and second, to learn how to deal with “operations other than war.”

—Gen John M. Shalikashvili

The word *frontier* evokes an image of such distant borders as the American frontier of the nineteenth century or the beckoning unknown of space. It also suggests austerity, hardship, and lawlessness. The frontier of 2025 will be the streets and fields of the developing world. The battle will be for cooperation of people ravaged by poverty, disease, hunger, and crime. These problems will be epidemic, in some regions driving the US to choose wisely where, when, and how to act. The dilemma of 2025 will mirror today: whether to meet force with force or prevent violence by preempting it.¹ Within a domestic environment of increasing fiscal discipline and regard for life, the most efficient way to defend our national interest is to act before a situation flares into violence.

One possibility is to dampen these violent flare-ups with a force dedicated to preventing or resolving conflict. However, this option requires a profound shift in focus and an unprecedented appreciation of degrees of conflict and hostility. Within each situation, there are instances where the application of lethal military force is appropriate. There are also instances where force is counterproductive. A murky void separates the two.

We need to bridge that void. This paper advocates creating a small, rugged, and specialized composite force dedicated to creating and operating in the physical and psychological state we will call the *peacespace*.² The size and composition of the force will be crucial to success or failure. In 30 years, we envision that a composite force will consist of military, civil service, contractor, and international personnel. Aided by technological possibilities and new conceptual thinking, a security assurance force (SAF—pronounced Safe) will foster institutions required for long-term stability in a region.

This stability rests on three core capabilities of SAF: constabulary power (military role), education (civilian role), and infrastructure building (military/civilian). The synergy of these capabilities, harmoniously employed, can dampen or remove violence and attendant fear, allowing a choreographed peace to emerge. SAF will possess sufficient capability to impose order when violence is at a relatively low order of magnitude. If violence is high or escalates, SAF directs standoff lethal force by either special or conventional forces until the legitimate authority restores order. Consonant with a strategic timetable, SAF and local civilian leaders engineer an education plan targeting progress in key political, social, and economic areas. SAF also coordinates with local leaders eager to accept private or international investment to build their infrastructure.

SAF intervention should lead to a desired end-state of stability where political, economic, social, and information institutions take root and begin to flourish. SAF will require warriors trained like no others to operate in a complex environment. In the year 2025, warriors will battle for terrain of the mind, performing missions that defy McNamarian precision while protecting American treasure—human life. We propose a blueprint for change to improve existing capabilities. This will require both commitment and time. We do not envision SAF as a quick fix to long-standing problems. Ultimately, making this change requires belief in the possibility of conflict prevention and the dedication to stay the course.

Notes

¹ *Strategic Assessment 1996, Instruments of US Power*. Institute for National Strategic Studies, (Washington, D.C.: National Defense University Press, 1996), 221. The section entitled “New Ways of Applying US Power” stresses “Enhancing the capability of the US Government to exercise influence abroad does not need to mean buying more of the same old product.”

² For the purpose of this paper, we will define *peacespace* as a dimension in which a rough equilibrium exists between a people's expectations and their fulfillment. By dominance, we are not asserting we can control all the variables that occur in peace or during transition to battle. We are saying that given conducive conditions and a catalyst for change, someone can make a difference. Thus, the military constabulary will impose as much control over changing conditions as possible when called upon by national or international leaders to intervene.

Chapter 1

Introduction

Secretary of Defense William J. Perry outlined his views in a speech entitled “Using Military Force When Deterrence Fails.” Specifically, he discussed the new world order emerging as a result of the cold war’s cessation and Fukuyama’s “end of history.”

Preventing conflict involves creating conditions that make conflict less likely. Like a doctor practicing preventive medicine, we want, if possible, to prevent conditions that provoke conflict from occurring, or at least heal them before they are serious. Some have argued that these efforts are not the business of the Defense Department. I disagree; I call them “defense by other means,” and we have launched major programs in the Defense Department to carry them out.¹

In contrast, Samuel P. Huntington eloquently notes, “the purpose of armed forces is combat.”² Can US armed forces careen between “traditional” military missions and ill-defined *peacespace* roles without diminishing combat capability?³

If peacespace dominance is the “frontier mission of 2025,” then it is an orphan no warrior will claim.⁴ This mission will be prosecuted in the streets and fields of the developing world, among people ravaged by disease, poverty, hunger, and crime. Battlespace is a condition of warfare requiring at its zenith the application of lethal, combatant military forces—force on force. Warriors organize, train, and equip to fight in the battlespace, not the peacespace—and certainly not in the transition where no true peace exists. Here, only a coercive force holds disgruntled elements in check. The flashpoint (fig. 1-1) denotes a hypothetical disturbance somewhere between these conditions we know today as peace and war.

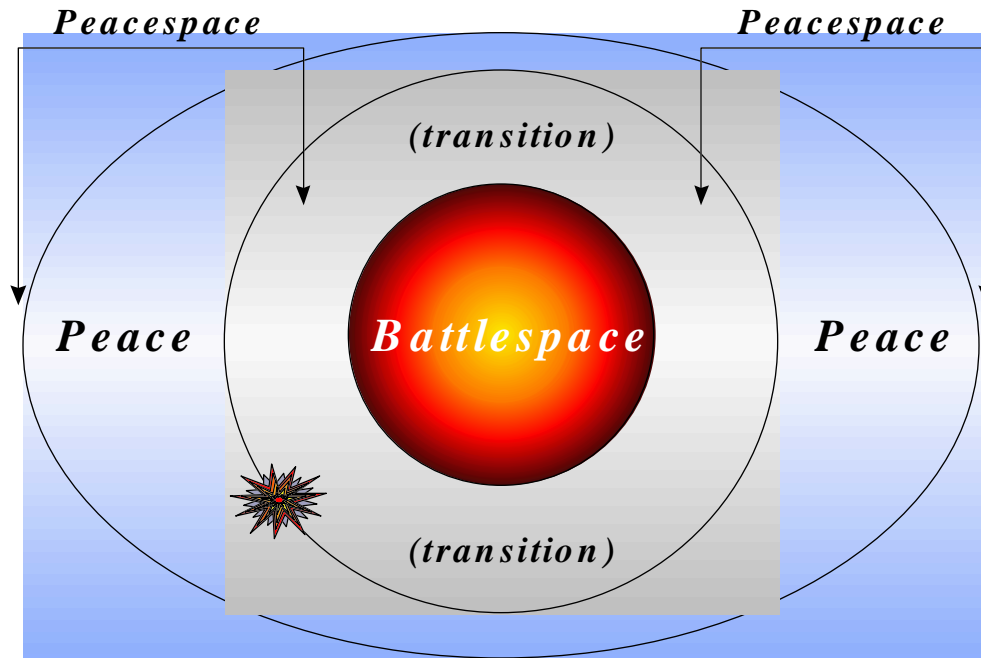

Source: Adapted from Field Manual 41-10, *Civil Affairs Operations*; January 1993

Figure 1-1. Operational Environments

All three circumstances are marked by fluctuating and ambiguous states of conflict, prehostilities, or disputes. In 1996, the military conducts missions in the peacespace without a defined end-state, entry or exit strategies, and doctrine or appropriate technologies. The US military is not organized, trained, or equipped to transition from hunter-killer to nurturer-builder. Rapid or unwieldy transition potentially corrodes US combat capability because it creates confusion in the warrior’s mind. Dispelling this confusion is crucial.

Using US national interest as a guide, we can choose if we should act—and if so, where, when, and how. We can consider levels of lethality and appropriateness of response.⁵ This paper argues that it is in our national interest to pioneer the peace before it lurches unpredictably into violence. Particular military competencies like order and discipline, organizational skills, and limited liability will likely continue to draw us into the storm.⁶

Pioneering the peace is an appropriate military mission, and it is one we are qualified to undertake. Secretary Perry states, “Some have said that ‘war is too important to be left solely to the generals.’ Preventive defense says ‘Peace is too important to be left solely to the politicians’.”⁷ In some cases, peacespace dominance need not be a US mission. Other nations or international bodies who have forsworn

the use of force might be better suited to these tasks. We advocate organizing, training, and equipping a SAF to provide this capability (table 1). This force would be a composite of both military and civilian personnel, with constabulary (military), education (civilian), and infrastructure (military/civilian) roles (constabulary, education, and infrastructure [CEI]).

Table 1

Concept Overview

Who?	SAF (CEI)	SAF/SOF/Conventional	Conventional/SOF/SAF
What?	Conflict Prevention ⁸	Conflict Resolution	Conflict Termination
Where?	Peacespace	Transition	Battlespace

Using rules (doctrine) and tools (technology), our challenge is to build a force capable of effecting the desired end-state without sacrificing combat capability. This force will be a catalyst for change. Both the United States and the United Nations have tackled peace missions with mixed results.⁹ To secure the success that eluded us in the past requires a different approach. In subsequent chapters, we will analyze the environment, assess the shortfalls in current capability, and propose a solution.

Notes

¹ The Honorable Perry, secretary of defense, “Using Military Force When Deterrence Fails,” *Defense Issues* 10, no. 8 (6 August 1995): n.p. on-line, Internet, 14 May 1996, available from <http://www.dtic.mil/defenseink/pubs/di95/di1080.html>. Presented during an address to the Aspen Institute Conference.

² Samuel P. Huntington, “New Contingencies, Old Roles,” *Joint Force Quarterly*, no. 8 (Autumn 1993): 39.

³ Part of the dilemma arises from co-mingling combatant and noncombatant forces in roles that defy traditional definitions. For example, many reservists filling US Army civil affairs billets conduct duties similar to their civilian jobs, i.e., one officer is a high ranking Chase Manhattan Bank official, providing invaluable financial skills during both Haiti and Bosnia operations. Also, medical personnel are typically deemed noncombatants who wear a uniform. This deserves better differentiation in both the law and policy.

⁴ Despite this assertion, Lieutenant General Zinni, commanding general, I Marine Expeditionary Force, Camp Pendleton, Calif., presented a **2025** lecture to Air War College titled “Commanding in ‘Frontier Missions’,” (Maxwell AFB, Ala.: 29 November 1995). General Zinni supported the Department of Defense (DOD) efforts to preempt conflict by tackling some root causes. However, in 1996, peacespace missions are awkwardly named including peacekeeping, peacemaking, peacetime contingency operations, low-intensity conflict, military operations other than war, *operations* other than war, or other military operations. The latest RAND[®] study by Carl H. Builder and Theodore W. Karasik, “Organizing, Training, and Equipping the Air Force for Crises and Lesser Conflicts (CALCs),” Project Air Force: 1995, arrives at yet another name for peacespace engagements.

⁵ USAF Scientific Advisory Board, *New World Vistas: Air and Space Power for the 21st Century*, summary volume (Washington, D.C.: USAF Scientific Advisory Board, 15 December 1995), 33. SAB coins a new word in power projection, *sublethal* which is at variance with DOD which employs the term *nonlethal*. Whatever the outcome of the semantic discussion, this paper will employ both definitions (i.e., nonlethal and sublethal versus lethal) to describe incremental increases in power. Effectively, nonlethals should be exactly that—not lethal. Sublethal is that force or power just below lethal deadly force.

⁶ The Feres Doctrine espoused by the Supreme Court in 1950 limits the liability of the US government in the event of a service-related death. (340 USC 135—1950) This limitation applies to military personnel only. With the shift of certain critical tasks to civilians, either civil service or contract, the liability issue must be addressed for civilians in hazardous zones.

⁷ Perry, remarks delivered to the John F. Kennedy School of Government, Harvard University, on-line, Internet, 13 May 1996, available from: <http://www.dtic.mil/defenseink>.

⁸ Dr. Larry Cable, “The End-State: Why Nations Stop Fighting,” lecture, Air Command and Staff College, Maxwell AFB, Ala., 16 January 1996. Dr. Cable is an associate professor of history at the University of North Carolina, Wilmington. Additionally, he is a frequent guest lecturer at the USAF Special Operations School (USAFSOS), Hurlburt Field, Florida. Additionally, Dr. Cable was in the US Marine Corps during the Vietnam War. He is the 1995 Gen. James H. Doolittle Award recipient at the USAFSOS, awarded to the School Educator of the Year. In numerous meetings, Dr. Cable differentiated between current policy, doctrine, and missions, which essentially deal with conflict termination, and conflict prevention or resolution.

⁹ Steven L. Canby, “Roles, Missions, and JTFs: Unintended Consequences,” *Joint Force Quarterly*, no. 6 (Autumn/Winter 1994-5): 68-75.

Chapter 2

World Trend

They make a wilderness and call it peace.

—Tacitus

The US military is heavily taxed, in 1996, performing peace operations throughout the world. Such commitments will likely increase. Thinkers like Robert Kaplan, Thomas Homer-Dixon, and Martin van Creveld strongly believe the world will suffer a number of pandemic problems in 2025: overpopulation, ecological disasters, severe water shortages, rampant disease, and refugees on the march.¹ Strands of these alarmist visions exist today in Africa, South Asia, and China. Robert Kaplan argues the United States may ignore these regional crises at its own risk. Will governments, unable to cope with epidemic problems, simply disappear?²

Compounding the specter of “national dissolution” is a population growth from 5 billion in 1996 to nearly 8 billion in 2025—over 7 billion will reside in less-developed regions that in 1996 cannot produce enough food to feed their people.³ Worse, previously eradicated communicable diseases, such as tuberculosis and influenza, are mutating and spreading.⁴ These new and developing strains are airborne and resistant to antibiotics.⁵

Desertification and deforestation are causing populations to flee to cities, making criminal anarchy the real strategic danger. Kaplan describes the worst of its victims: “Young men [are] like loose molecules in a very unstable social fluid, a fluid . . . clearly on the verge of igniting.”⁶ This increasing propensity to violence is partially mirrored by US crime statistics. Between 1985 and 1992, the murder rate for 14–17 year-old males doubled for whites and increased by more than 300 percent for African-Americans.⁷ In the

year 2000, the number of youths aged 14–17 will increase by 500,000 in the US alone—effectively, each subsequent generation is three times more dangerous than the one preceding it.⁸

Homer-Dixon believes the environment is “*the* national security issue of the early 21st century” (emphasis in original).⁹ He predicts future wars and civil violence may arise from the scarcity of such resources as water, cropland, forests, and fish.¹⁰ Huntington warns of wholesale tribal conflict.¹¹ He pictures a world in which democratic liberalism gives way to a darker Hobbesian world—Hegel and Fukuyama’s “last man” supplanted.¹² While these polemicists paint a bleak landscape, perhaps the change will be more gradual and evolutionary. Just as these forces are irretrievably affecting the world, movements are underway to change the way we fight wars.

Battlespace Trend

To many men . . . The miasma of peace seems more suffocating than the bracing air of war.¹³

Since World War II (WWII), warfare has both changed and remained chillingly the same. The collapse of colonial empires resulted in nearly 200 nation-states, many of them small, unstable, and vulnerable. According to van Creveld, “Judging by the experience of the last two decades, the visions of long-range, computerized, high-tech warfare so dear to the military-industrial complex will never come to pass. Armed conflicts will be waged by men on earth, not robots in space.”¹⁴ He also implies that warfare will be frequent in the developing world: “In light of the fact that 95 percent of the earth’s population will be in the poorest areas of the globe, the question is not whether there will be war (there will be a lot of it) but what kind of war. And who will fight whom?”¹⁵

Van Creveld speaks of conflicts which require conventional, special operations, and peacespace warriors. Whenever the US engages in these situations, certain trends in the US domestic arena will both constrain and empower future force structure. We must understand these trends to accurately determine force composition for 2025.¹⁶

Domestic Trend

*War is hell, but peace is a pain in the ass.*¹⁷

An emerging domestic trend is America's aversion to casualties.¹⁸ Any future military planning must take this into account. The death of 18 soldiers in Somalia effectively ended that mission. One death in Bosnia received national attention. Preoccupation with prisoners of war in Vietnam, friendly-fire incidents, and the expectation that precision strikes will limit collateral damage—all these result in the conclusion that there is simply less room for error, particularly in missions of questionable vital national interest.

The competing demand for fiscal resources is also likely to increase. At some point, the US appears to have no options other than to either narrow its interests or act before a situation requires large injections of armed force. These choices are especially important in light of the high operations tempo characterized by the first three years of the Clinton administration.¹⁹ Force readiness and retention will be contingent on addressing the future conflict set.²⁰ Three recent expeditions into peacespace illuminate both lessons learned and current shortfalls facing leaders and planners.

Somalia

Graphic evidence of famine, provided the by Cable News Network (CNN), triggered the intervention in Somalia.²¹ At no time did anyone portray the Somalia relief mission as in the national interest. According to one analyst, the military and civilian agencies had little entry criteria—only that the US had the means to act and so should.²² Subsequent events expanded the US involvement to a force of 28,000. Their task was to suppress the violence and relieve interruptions in the delivery of aid. Gradually, the United States, operating in conjunction with the UN, became involved in a nation-building effort for which some believed the military was ill-suited. This mission was abruptly aborted with the deaths of 18 soldiers in October 1993.²³ Among the many lessons drawn from the Somalia engagement: we conclude that the lack of clear entry and exit criteria combined with foggy rules of engagement to inhibit a successful mission.²⁴

Haiti

An influx of refugees, not famine, triggered the 1994 US intervention in Haiti. Haitian citizens, attempting to escape violence, political instability, and economic chaos, flooded our shores.²⁵ Thus, some criteria for intervention were used and the operation appears to have been in the national interest. US involvement in Haiti included an effort to legitimize President Jean-Bertrand Aristide's government and restore democracy through the use of military forces. One CINC cited Haiti as evidence for the notion of training warriors for missions of violence and—literally within the space of an airplane ride—changing them into police and peacekeepers.²⁶ During Operation Provide Hope, military forces used radio and television broadcasts, leaflet drops, and personal contacts to educate Haitian citizens on democracy. US Army Civil Affairs units trained Haitian government officials, established judicial courts, and developed a governmental system.²⁷ US forces performed infrastructure development duties by “reinitiating legitimate civil functions . . . public activities, water, electricity, sanitation, medical, [services], food, public information, town meetings, broadcasts, and monitoring the local Haitian army and police.”²⁸ These actions created environments where economic growth could occur. Even so, these activities do not mean that careful planning is institutionalized or that successful execution is certain.

Bosnia

The Bosnia mission was one of the more carefully considered US interventions to date; it effectively blended ground, naval, and air forces in support of peace.²⁹ Careful debate centered on US national interests in the former Yugoslavia. Attention concentrated on the utility of inserting ground forces between warring factions. Ultimately, airpower brought contending groups to the bargaining table.³⁰

The precision of the NATO coalition's attacks last summer altered the course of that three-year war, resulting in the Dayton peace talks and preventing the conflict from spilling over into other countries. This force was effective, ultimately, because it was applied towards clear, achievable policy objectives, in effective coordination with other diplomatic tools, with a clear view of military requirements.³¹

Airpower also limited violence by creating no-fly zones. Naval craft enforced the arms embargo in the Adriatic in Operation Sharp Guard.³² After brokering a peace settlement, army units provided essential ground forces to secure the peace.

Summary

This chapter reviews world trends that increase the range of actions in support of peace. Battlespace will include both major regional contingencies and excursions into low-level conflict. Peacespace dominance may mean working problems before they boil over into war. “If we can prevent the conditions for conflict, we reduce the risk of having to send our forces into harms way to deter or defeat aggression.”³³ As our recent experiences in Somalia, Haiti, and Bosnia demonstrate, we have difficulty operating in and transitioning back into peacespace. These operations provide important lessons for devising rational entry and exit criteria.

It is also true that if we move early in dealing with these conflicts, and if we have an effective method for carrying out international peace enforcement, especially in a preventative way, we have a new tool which can help in the early resolution of enormously difficult, potentially intractable situations that could well offset our national interests and our future.³⁴

In the next chapter, we will propose the most efficient way to defend our national interest: act before a situation flares into violence. We will propose a force to act as a catalyst for change to dampen violence and orchestrate peace.

Notes

¹ Robert D. Kaplan, "The Coming Anarchy," *The Atlantic Monthly*, February 1994, 44-76; Thomas Homer-Dixon, "Environmental Change and Violent Conflict," *Scientific American*, vol. 268, no. 2 (February 1993): 38-45; Martin van Creveld, *The Transformation of War*, (New York: Free Press, 1991): 192-223.

² Kaplan, 44-76.

³ Lawrence C. Hellman, Ph.D., "Humanitarian Operations," lecture, Air Command and Staff College, Maxwell AFB, Ala., 19 January 1996. Dr. Hellman is a consultant to USAID, and data included was used by permission. Additionally, Dr. Armin Ludwig, "Ecosystemic Violence," **2025** program lecture, Air War College, Maxwell AFB, Ala., 6 September 1995. Dr. Ludwig presented a fascinating picture of population, net primary production, and the world's ability to feed itself given current trends in population growth. His computations did not include the potential effects of genetic engineering (plants that grow in arid or saline

soils), synthetic soils, or biogenetic plant species development (higher yield, greater yield per year, yield of cross-fertilized varieties, etc.). On the balance, he caveated each condition or phenomena with a caution to address the consequences of actions which “tamper” with nature (e.g., fertilizers and irrigation practices).

⁴ Anita Manning, “Viruses Mutate Among Underfed,” *USA Today*, 17 April 1996, 1. Malnourished people and animals may provide a breeding ground for mutant viruses that can then infect others. Dr. Orville A. Levander, a nutritionist with the US Department of Agriculture, concludes, “we are not protected from what might be happening to malnourished people in Africa.” The World Health Organization report, “The Tuberculosis Epidemic 1996: Groups At Risk,” states:

In 1995, more people died of TB than in any other year in human history. It kills more adults than all other infectious diseases combined. Multidrug resistance is growing, threatening to make TB incurable again. Since issuing the global warning three years ago, some initial steps have been taken but they are dangerously insufficient. Tuberculosis cannot be controlled in some parts of the world and left to spread in others. Tuberculosis is a global epidemic that requires a unified, global response.

On-line, Internet, 18 April 1996, available from http://www.who.ch/programmes/gtb/tbrep_96/execsum.htm.

⁵ Kaplan, 44–76.

⁶ *Ibid.*, 46.

⁷ In “Moral Poverty,” John Dilulio writes, “Americans are sitting atop a demographic crime bomb.” *The Chicago Tribune*, 15 December 1995, section 1: 31. If the US is to effectively engage abroad, many of these systemic social problems must first be correctly addressed. The thesis of this paper assumes the US will successfully correct many internal problems in the next 30 years.

⁸ *Ibid.* Peter Schwartz discusses the opportunity and dilemma presented by the “Global Teenager” in *The Art of the Long View*, (New York: Currency Doubleday, 1991): 124-140. Comparing the current demographic trends with projected population trends, he notes “Barring widespread plague or other catastrophe, there will be over 2 billion teenagers in the world in the year 2001. That’s *fifty* times the number of teenagers in America in the peak years of the baby boom.” The “Global Teenager” existence will be a driving force. However, Schwartz does not see this driver in a wholly negative vein, particularly with respect to education.

⁹ Homer-Dixon, 38–45.

¹⁰ Ludwig and Homer-Dixon assert growing scarcities of renewable resources can contribute to social instability and civil strife.

¹¹ Samuel P. Huntington, “The Clash of Civilizations?” *Foreign Affairs* 72, no. 3 (Summer 1993): 22–49.

¹² Francis Fukuyama, *The End of History and the Last Man* (New York: Free Press, 1992), 287–328.

¹³ George Steiner (born 1929). French-born US critic and novelist. “Has Truth a Future?” Bronowski Memorial Lecture, 1978. *The Columbia Dictionary of Quotations*, (New York: Columbia University Press, 1993). Microsoft® Bookshelf.

¹⁴ Van Creveld, 212.

¹⁵ Kaplan, 73.

¹⁶ Colin S. Gray, “The Changing Nature of Warfare?,” *Naval War College Review*, 69:2 (Spring 1996): 13-14. Gray cites information from Edward N. Luttwak, *Strategy: The Logic of War and Peace*, as follows: “War, in common with sport, has the characteristic that what worked yesterday may not work tomorrow, precisely because it worked yesterday. Nothing tends to fail like success.”

¹⁷ Quoted in “A SIOP for *Perestroika*?” by Col Richard Szafranski in a research report (Maxwell AFB, Ala.: Air University, Air War College, 1990), 1. James Schlesinger made the statement on a *Face the Nation* edition.

¹⁸ Eric V. Larson, “Casualties and Consensus, The Historical Role of Casualties in Domestic Support for US Military Operations,” (Santa Monica, Calif.: Rand, 1996), iii, 102–3. Larson provides a comprehensive look at the role of casualties in administering public policy.

The relationship between US casualties and public opinion on military operations remains an important yet greatly misunderstood issue. It is now an article of faith in political and media circles that the American public will no longer accept casualties in US military operations and that casualties inexorably lead to irresistible calls for the immediate withdrawal of US forces. If true, this would not only call into question the credibility of the US Armed Forces in deterring potential adversaries but would be profoundly important in decisions regarding the country’s strategy, alliance, and other commitments, force structure, doctrine, and military campaign planning.

However, Larson concludes the public support or lack thereof is more accurately a reflection of the US leadership position and disagreements among key political figures. “As the historical record shows, attributing declining support solely to casualties misses the real story.” When the public perceives benefit, they will exhibit a high tolerance for casualties. Also, Colin Gray argues as follows in “The Changing Nature of Warfare?” *Naval War College Review*, 69:2 (Spring 1996): 10–11.

It is true that a machine-rich American culture has looked sensibly to maximize the roles of vehicles, steel, and explosives in lieu of human flesh whenever appropriate—and sometimes beyond that point. But it is also true, contrary to popular mythology, that when the stakes are very high, as in the Civil War and the two world wars, the United States has no tradition of being especially sparing of American lives.”

¹⁹ Operations and personnel tempo for some USAF weapons systems and respective personnel reached crisis proportions by 1994. General Fogelman, CSAF, instituted a process to track and reduce this to below 120 days. On 17 April 1996, AF/XOOOR (Major Fink) passed the following figures to the authors for frame of reference.

USAF Weapon System PERSTEMPO (average #days TDY/crew/year)	1994	1995	1st Qtr 1996
HC-130 (rescue)	194 days	135 days	38*days
EC-130E (ABCCC)	186 days	175 days	29* days
E-3 (AWACS)	162 days	129 days	24 days
U-2	148 days	148 days	36* days
RC-135 (Rivet Joint)	143 days	161 days	37* days
EC-130H (Compass Call)	104 days	123 days	54* days
HH-60G USAF rescue Pave Hawks	53 days	116 days	28* days
Special Operations Forces (SOF)			
AC-130 Spectre Gunship	159 days	83 days	25 days
MH-53J Pave Low	134 days	74 days	23 days
MH-60G SOF Pave Hawk	158 days	106 days	30* days
Combat Control Teams (CCT)	186 days	160 days	39 days

*Continuing at 28 days and higher will exceed the 120-day limit for the year.

The Navy, Army, Marine Corps and US Special Operations Command provided similar data which is submitted to the Joint Staff as part of the Joint Monthly Readiness Review. Of particular interest currently are all units designated as “low density/high demand” or LD/HD. In addition to some of the Air Force systems and units above, Army civil affairs and psychological operations battalions, Patriot missile batteries, Navy Seabees and SEALs receive additional scrutiny in this category. While specific data is classified, the following general trends are provided for comparison. USMC 1 MEF wings average 160 days deployed per year for training deployments; divisions average 145 days deployed. Some USN surface

combatants, amphibious ships, fast attack submarines and aircraft squadrons range from 10-40 percent above the maximum Chief of Naval Operations PERSTEMPO program goals. These goals are (1) a maximum deployment of six months, portal to portal, (2) a minimum turn-around ratio of 2:1 between deployments (if out six months, should be in port 12 months before going afloat again), and (3) a minimum of 50 percent time in home port for a unit over a five-year period (three past years and two projected years). Roughly, the Navy numbers equate to 180 days over 18 months or 120 days per year. USSOCOM provided detailed data for special operations personnel, many of whom are deployed well above the 120-day goal. In US Army Special Operations Command, special forces and civil affairs officers average 180 days deployed per year. In Naval Special Operations Command, SEAL team corpsmen and officers average 175 and 163 days respectively. AC-130H navigators average 184 days and pararescuemen (PJs) average 168 days from Air Force Special Operations Command.

²⁰ “World View: The 1996 Strategic Assessment From the Strategic Studies Institute,” edited by Earl H. Tilford, Jr., US Army War College, Carlisle Barracks, Pa.: 1996, 3-4.

²¹ Cable News Network (CNN)® is an affiliate of Ted Turner Productions, Atlanta, Ga.

²² Kenneth Allard, *Somalia Operations: Lessons Learned* (Washington, D.C.: NDU Press, 1995), 89.

²³ *Ibid.*, 30. Also see Col F. M. Lorenz, USMC, “Forging Rules of Engagement: Lessons Learned in Operation United Shield,” on-line, Internet, 10 March 1996, available from <http://www-cgsc.army.mil/cgsc/milrev/95novdec/lor.htm>.

²⁴ Lorenz, Internet, <http://www-cgsc.army.mil/cgsc/milrev/95novdec/lor.htm>.

²⁵ W. Darrent Pitts, “A Guantanamo Diary—Operation Sea Signal,” *Joint Forces Quarterly*, no. 9 (Autumn 1995): 118. Operation Sea Signal was a humanitarian mission designed to care for over 14,000 Haitian refugees at the US Guantanamo Naval Base, Cuba. Overwhelmed civil affairs personnel were unable to deal with subhuman camp conditions. Linguists were in short supply.

²⁶ Address to Air War College. Academic privilege applies to this source.

²⁷ “United States Special Operations Forces Posture Statement,” 1994, 26–27.

²⁸ Sqn Ldr Sam Allotey et al., “Planning and Execution of Conflict Termination,” a Research Paper presented to the Directorate of Research, Air Command and Staff College (Maxwell AFB, Ala.: Air University, Air Command and Staff College, May 1995), 83.

²⁹ As it took four years for the US to engage in Bosnia, presumably we preceded our actions by pragmatic and thoughtful preparations to correct the perceived deficiencies of the UN operations.

³⁰ George C. Wilson, “A Lesson in Peacekeeping,” *Air Force Times* (11 March 1996), 54. Wilson, a former defense correspondent of *The Washington Post* and author of several military affairs books, discusses a “presence” maneuver used by Adm Leighton Smith, NATO commander in Bosnia-Herzegovina. F-18 Hornets scrambled from the USS *George Washington* in response to the shelling of Malaysian military in “B-Hatch.” When the Malaysians did not “come up” on frequency to direct the bomb drop or missile launch, the Navy pilots converted to a “presence” maneuver—a major part of NATO’s strategy for peacekeeping in Bosnia-Herzegovina. Dropping to 10,000 feet, the pilots advanced throttles to make more noise with their engines. The resultant thunder stopped the shelling of Malaysians. Lt Bill Lind, USN, quipped, “It’s called peace through superior volume.” The deterrence works because the planes *have* dropped bombs. These tactics are essentially ad hoc in nature and not planned in advance.

³¹ The Honorable Sheila Widnall, secretary of the Air Force, “AF Evolving Through Contacts With Other Nations,” MSgt Gary Pomeroy, Air Force News Service, on-line, Internet, 15 May 1996, available from <http://www.dtic.mil/defenseink>.

³² Information of Operation Sharp Guard found on-line, Internet, 15 May 1996, available from <http://www.nato.int/for/general/shrp-grd.htm>.

³³ Perry, remarks delivered to the John F. Kennedy School of Government, Harvard University, on-line, Internet, 13 May 1996, available from <http://www.dtic.mil/defenseink>.

³⁴ Joint Warfighting Center, “Joint Task Force Commander’s Handbook for Peace Operations,” *Air Command and Staff College War Termination Coursebook* (Maxwell AFB, Ala.: Air University Press, 1996), 64.

Chapter 3

Concept Description

We conducted such operations [operations other than war] during the Cold War, but they were few and far between. And frankly, we did not always do them very well. So we lack a time-tested template that we can lay down every time we commit to one of these operations.

—Gen John M. Shalikashvili

The template requested by the Chairman of the Joint Chiefs is a complex one. The propensity for oversimplification often leads us to reduce the template to a “boilerplate.” Leaders and planners require more. This chapter covers a proposal for a small, rugged, and specialized composite force dedicated to creating and operating in the physical and psychological state we call the peacespace. The proposal moves from situation assessment and enabling doctrine (rules) and technology (tools) to SAF core capabilities.

Situation Assessment

Some triggering mechanism currently launches excursions into peacespace. This may be public opinion, a UN resolution, or perceived national interest. In 2025, national or international authorities will still judge whether or not to intervene. This assessment should use clear criteria meant to assess the prospects for success in creating a better state of peace.¹ Candidates for intervention might be identified by spikes or flash points which erupt on a digital cultural map as “boundary” lines are penetrated.² Figure 3-1 illustrates our vision of the digital cultural map.

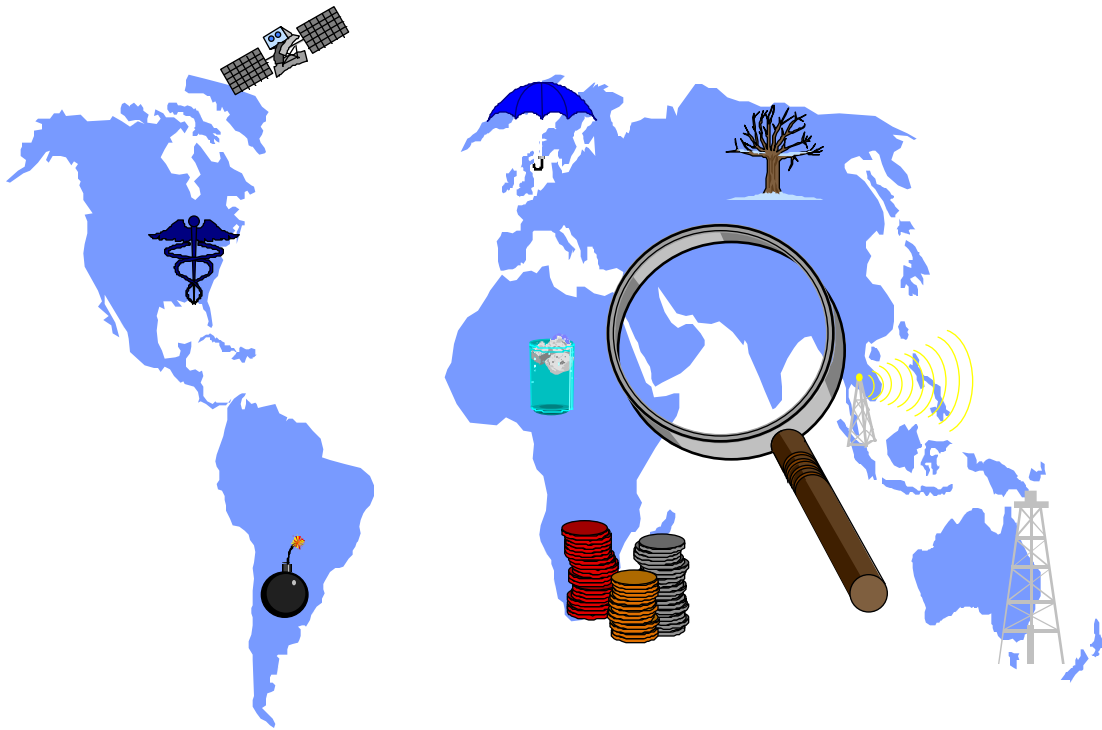

Figure 3-1. Digital Cultural Map

Using technology, a digital cultural map (DCM) could decrease peacespace ambiguity and aid leaders responding to conflicts or crises by sorting disparate data. It would “navigate” the geopolitical globe in a manner similar to an aircraft navigation digital map, blending together a multitude of diverse databases in visual or graphical interface. These candidates for intervention can be prioritized or “triaged” using basic, yet flexible criteria. Appendix A gives detailed intervention criteria.

The National Security Council (NSC) or the United Nations would evaluate the situation and classify the case as (1) costly, (2) borderline, or (3) clear-cut candidate for intervention. For example, the DCM assigns values which indicate candidate “A” has a high level of violence, an inadequate political or social climate, and a deteriorated infrastructure. This case may very well be categorized as too costly, regardless of perceived importance to national interest. Candidate “B,” on the other hand, has a moderate level of violence that could be quelled by nonlethal technologies and a well-trained constabulary force. Its social and political institutions are minimally deteriorated, lending credence to education efforts. Finally, its

infrastructure is capable of rejuvenation, leading to optimism that private investment might prove successful.³

Figure 3-2 depicts intervention candidates and correlates them to specific criteria.

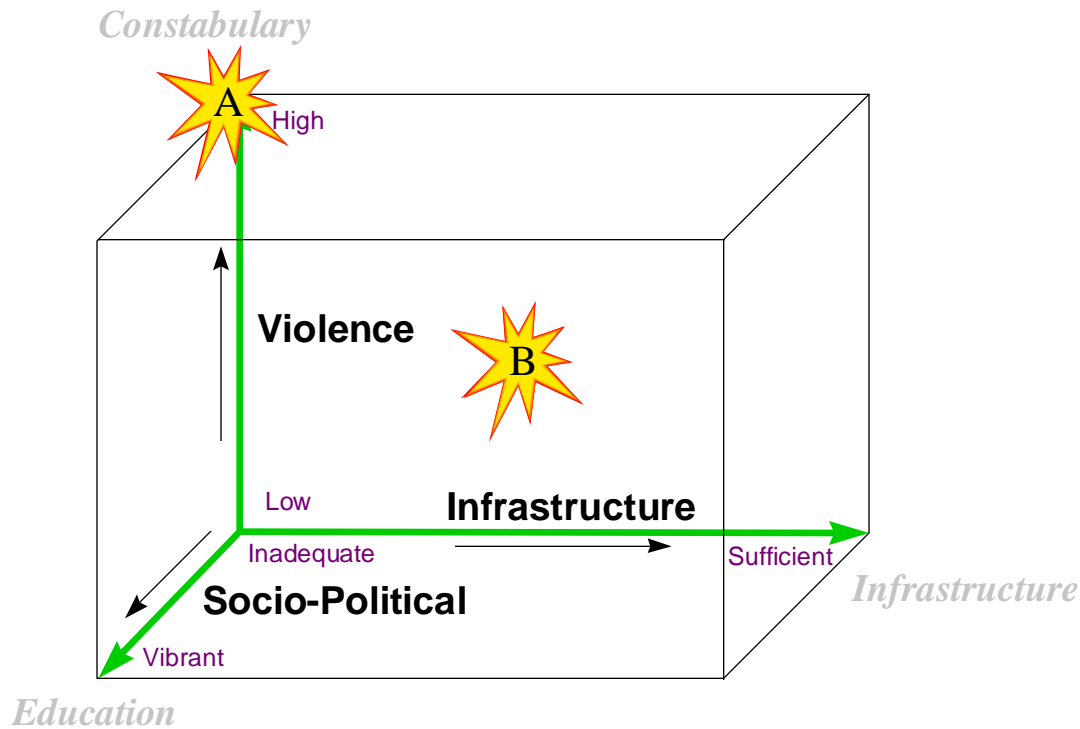

Figure 3-2. Intervention Candidates

Ultimately, leaders make the decision to intervene, using subjective judgments: (1) Is the intervention in US or UN interests? (2) Is the desired outcome worth the cost? (3) Is SAF the appropriate force? (i.e., Does open violence currently exist? Can SAF establish a secure environment or are more conventional forces appropriate?) (4) What timetable exists for achieving objectives? (5) Do we have measures of merit for success or withdrawal?⁴ The decision is made either to intervene or not. The same objective and subjective criteria can determine when goals are met and an exit is appropriate. They can also demonstrate when an operation is stalled and should be abandoned. This paper asserts that the current force structure does not adequately meet the tasks at hand. The SAF concept, beginning with doctrine and tools, is one alternative to accomplish this mission.

Rules and Tools

The first step required in building this new force is to make “rules.” Doctrine covers many aspects of policy from the national security strategy level to tactical employment. While a comprehensive doctrine is beyond the scope of this paper, initial thoughts regarding doctrinal changes for implementing SAF are appropriate.⁵

Flexibility/versatility. The dynamics of intervention missions demand a fresh approach to each operation. To avoid overlaying “previous experience” inappropriately, every operation must be tailor-made and sized to the situation. Just as civilian industry is innovatively exploiting niche markets, “tailoring” manufacturing on a mass scale, SAF must flex great power on a small scale.⁶

Concentration. CEI efforts need teeth in order to ensure credibility. These functions seek to affect whole societies and will require a complete fidelity of purpose. The small, rugged, mobile, and composite structure of SAF encapsulates the notion of concentration of effort. SAF launches an offensive by attacking the causes of conflict before they erupt into hostilities. Conflict prevention also provides economy of force by limiting the application of violence and reducing the chance of escalation.

Persistence. CEI efforts should be comprehensive, coordinated, far-reaching, systematic, and applied until they succeed or the decision is made to withdraw. The appeal of airpower to SAF is the ability to persist in end-state efforts until established goals are achieved.⁷ While airpower may reduce risks and increase effectiveness of both land and sea components, success in peacespace operations lies in balanced air, land, and sea dominance.

By design, we have only hinted at the doctrinal possibilities.⁸ Even if further exploration and developments lead to a “virtual” presence in the peacespace, someone will still require technology or tools to achieve their goals and objectives in 2025. Parallel to formulating doctrine is determining what tools SAF needs to perform its mission. Embedded in the CEI concept are potential technologies to enable SAF forces.⁹

Constabulary, Education, and Infrastructure (CEI) Concept

The integrated use of CEI provides a foundation for dampening conflict and promoting stability. Certain characteristics are crucial to success: appropriate doctrine (carefully matched technologies), small force structure (4,000-10,000 total active and reserve component mix), mobility, ruggedness, and specialization.¹⁰ The elements of CEI are discussed in the following pages.

Constabulary

One of the commander's first concerns in entering a SAF engagement will be to impose order while protecting the participants. Builder defines *constabulary* as an "armed police force organized on military lines but distinct from the regular army."¹¹ The constabulary envisioned is primarily composed of military forces who dominate situations of lawlessness. If levels of violence escalate, SAF constabulary forces could temporarily pass control of the situation to stand off "guardian" systems.¹² As another option, SAF could direct increasing levels of lethal force until order is restored. In extremis conditions require clean hand-offs between SAF and either special operations or conventional combat forces.

As in battlespace dominance, peacespace constabulary actions can occur in serial or parallel with education and infrastructure, similar to battlespace dominance.¹³ Effects and effectiveness will depend on a variety of non-lethal, sub-lethal, and lethal technologies integrated with effective command and control to create an environment conducive to long-term development.¹⁴

Lift

Air and space power capabilities could significantly enhance the constabulary force. Reacting to violent situations will require delivery of either forces or equipment—anytime, anyplace. Some lift requirements mirror those of today; for example, moving SAF or civilian forces and their equipment, or delivering food, water, fuel, and medicine. Although we anticipate significant improvements in capability, survivability, and reliability, these subjects are adequately covered in other studies. Table 2 depicts SAF's unique mission, objectives, and potential technologies.¹⁵

Table 2

Lift Objectives and Technologies

MISSION	OBJECTIVE	TECHNOLOGY
Lift	Mobility <ul style="list-style-type: none"> • Transship SAF forces and equipment • Transship NGO/PVO people/equipment • Supply infrastructure/education “stuff” • Deliver food/fuel/medicine 	<ul style="list-style-type: none"> • Tiltwing super short takeoff and landing • Advanced theater transport (TSSTL/ATT) • Heavy lift aircraft with mission Pod • Low observable transport • Precision/Large scale airdrop • Global Navigation System
SAR	Vertical lift extraction of SAF ground troop	<ul style="list-style-type: none"> • SOF vehicle • Advanced personnel locators
Resupply	Replenishment	<ul style="list-style-type: none"> • Precision/Large scale airdrop • Advanced material handling equipment

Potential technological advances should address current shortfalls in airlift capability. Perhaps the innovative low altitude parachute extraction system (LAPES) tactic of the twentieth century will spawn equally creative solutions in 2025, such as the precision/large-scale airdrop technologies listed in table 2. The Special Operations Forces Vehicle, listed as a search and rescue (SAR) technology, is a potential CV-22 follow-on aircraft (1500nm range, high subsonic speed, low-observable technologies). This vehicle may allow vertical extraction of SAF ground forces when required. Additionally, rapid identification of threats to ground operations could allow calmativ agent application from a low-altitude (atmospheric), orbital unmanned aerial vehicle (UAV).¹⁶ Thus, accurate identification of threats is a key enabler. Figure 3-3 displays the employment of some required lift technologies.

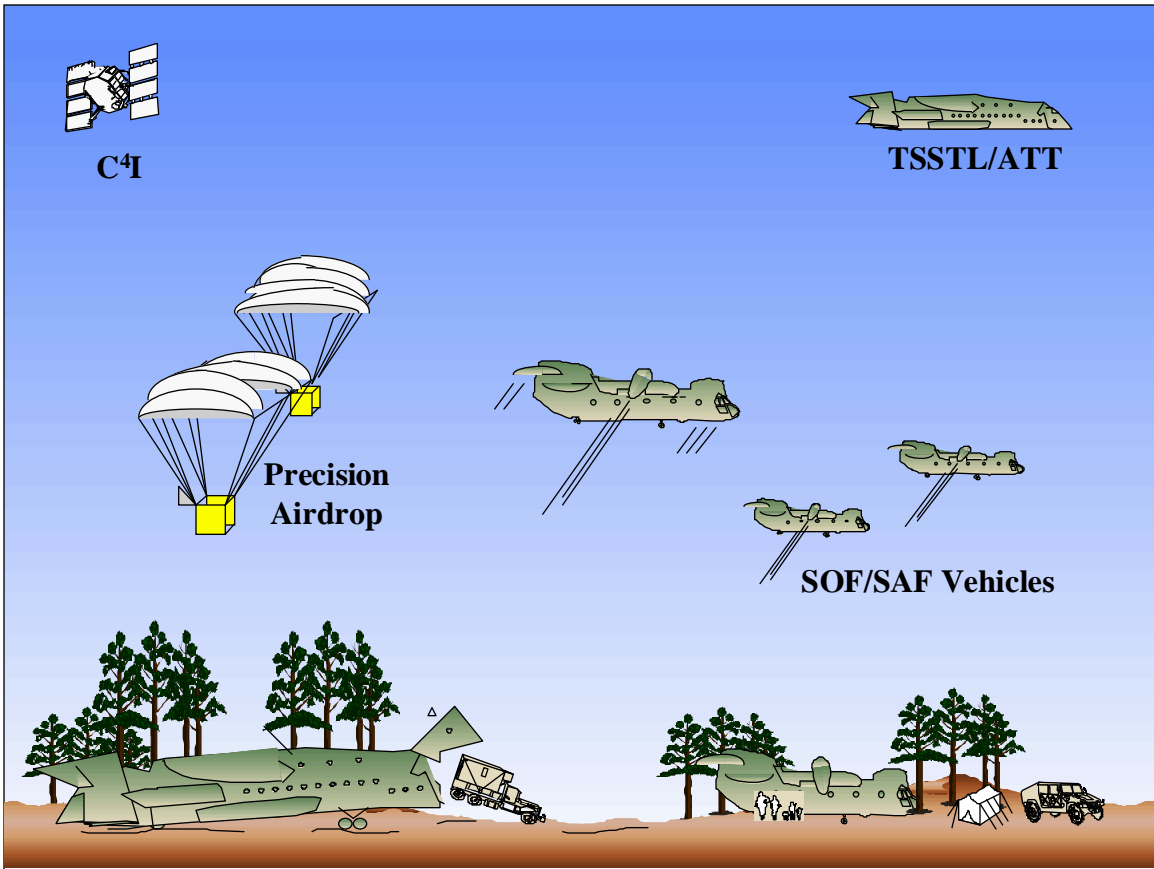

Figure 3-3. Lift into Peacespace

While required items could be either strategically prepositioned or vertically hoisted in by CV-22 or follow-on aircraft, we could also deliver them to littoral regions by sealift for overland transport.¹⁷ Regardless, these and other infrequent loads will require rapid delivery under unusual or extreme circumstances. SAF forces and planners could identify alternative solutions to either infrastructure requirements or planned lift acquisitions through early identification of known military shortfalls and limitations. Getting people and material to the right place at the right time will also necessitate advances in intelligence, surveillance, and reconnaissance.

Advanced Intelligence, Surveillance, and Reconnaissance

One centerpiece of SAF is that of amplifying the efficiency of what should be a small force. We can accomplish this by providing highly detailed and timely intelligence or information.¹⁸ The needs of SAF are

not particularly unique—they mirror those of combat forces. Current intelligence, surveillance, and reconnaissance (ISR) needs will persist; the challenge will be to pursue technologies and develop processes that create advanced ISR appropriate to SAF requirements in 2025.

Three principles govern ISR in the peacespace: timeliness, accuracy, and precision. Peacespace dominance will drive an increased reliance on information residing primarily in open sources. Timeliness drives a need for on-scene information acquisition (fig. 3-4). Sensor-laden UAVs or ultralight aircraft platforms could be the workhorse of SAF’s advanced ISR toolkit. Advanced ISR, contributing to “information dominance,” will allow a limited number of ground troops to leverage their coercive capability.

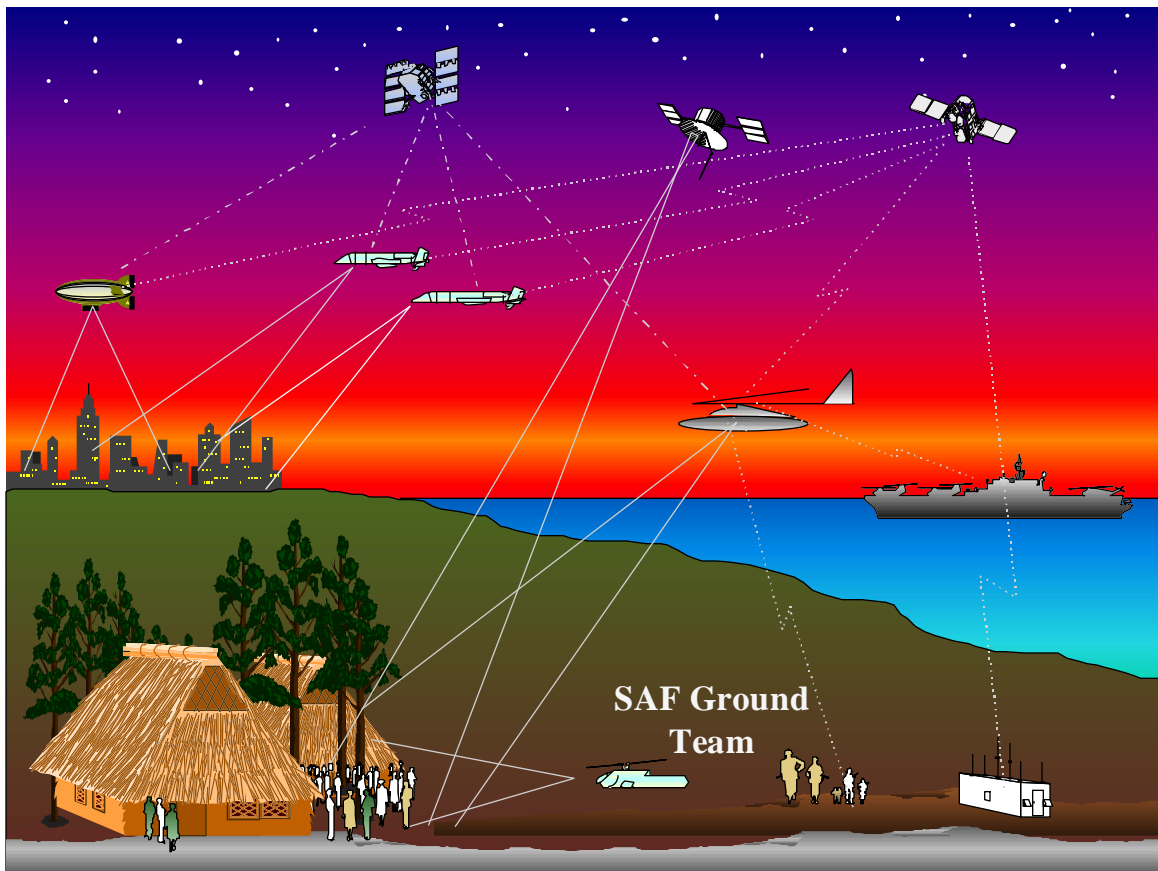

Figure 3-4. Advanced ISR in the Peacespace

Accurate intelligence could allow leaders to identify and preempt trouble before it becomes conflict. Analysis could come from nontraditional agencies, including the departments of Commerce, Treasury, State, and Agriculture; the Center for Disease Control; the World Bank or the International Monetary Fund; Save the Children; Doctors Without Borders; and Greenpeace. Coupled with open-source intelligence, wider use of human intelligence will help us know intentions as well as capabilities—the precision index.

Rather than detecting and analyzing jet aircraft which emits [sic] a familiar visual, infrared, and telemetry signal . . . the intelligence community may have to detect and analyze old, small aircraft transporting drugs. Rather than spotting tank battalions in movement, it may have to spot guerrillas. And rather than dissecting a Soviet arms-control proposal, it may have to assess a country's attitude toward terrorism.¹⁹

Centralized intelligence can provide details on weapons movements and violent elements. Count de Marenches, former chief of French intelligence, stated, "Precision personal intelligence can be more critical than precision-guided munitions."²⁰ The vast amount of information will have to be culled in order to monitor the movement of aggressors. Their religious and cultural views must also be monitored. Information must be accurate, digestible, and relevant.

The best satellites can't peer into a terrorist's mind. Nor can they necessarily reveal the intentions of a Saddam Hussein. Satellites and other technical surveillance technologies told the United States that Saddam was massing troops near the Kuwait border. But the United States—short on spies in Baghdad's inner circles—brushed aside such warnings as alarmist and mistakenly concluded the troop movements were just a bluff. One human spy in or near Saddam's inner circle might have cast light on his intentions and changed history.²¹

As a result of this enormous need for contextual intelligence, the attendant command, control, communications, and computers (C⁴) support will be immense. Table 3 depicts advanced ISR/C⁴ objectives and technologies.²²

Table 3

Advanced ISR/C⁴ Objectives and Technologies

MISSION	OBJECTIVE	TECHNOLOGY
Advanced ISR	<ul style="list-style-type: none"> • Strategic: feeders to NCA DCM • Operational: SAF requirements • Tactical: output/effects based targeting • Surveillance/Target ID: UAV constellation 	<ul style="list-style-type: none"> • Long endurance UAVs/UTAs • Unmanned mini helos • Target reporter • Unattended ground sensors • Weather Surveillance and prediction • Low-cost space-based surveillance • Virtual presence
C ⁴	Reliable, high fidelity, robust	Scavenge C ⁴ solutions from expert sources

Command, Control, Communications, and Computers

The peacespace mission is also based on conflict prevention or resolution, which dictates accurate communication with local leaders. Improvements in computer voice recognition technology may permit the development and fielding of translators for installation onboard the UAV or ultralight. By 2025, real-time

broadcast of instructions via remote transmission might obviate the need to develop large forces of language experts. We can leverage a small cadre of linguists remotely. This capability also would increase the effectiveness of both the psychological operations team and the education/infrastructure mission.

Finally, SAF will require data links to rear areas to provide recurring information and updates. This requirement is an entry point of SAF to the “metasystem.”²³ SAF must tie into other C⁴ systems for point-to-point communications. The concept might be along the lines of an Iridium[®] system potentially placing more than 50 dedicated satellites in a low-earth orbit (LEO).²⁴ Essentially, SAF requires reliable communications to any individual with the correct equipment and cryptologic material or device, particularly while performing the envisioned air dominance role.²⁵

Air Dominance

To provide a viable constabulary force for 2025, Builder notes certain technological challenges.²⁶ First, the constabulary must immediately identify, engage, and suppress certain kinetic weapons. Current methods of counterbattery fire, which result in area barrages of suspected gun emplacements, do not provide the surgical strike capability required to ensure engagements with limited collateral effects.

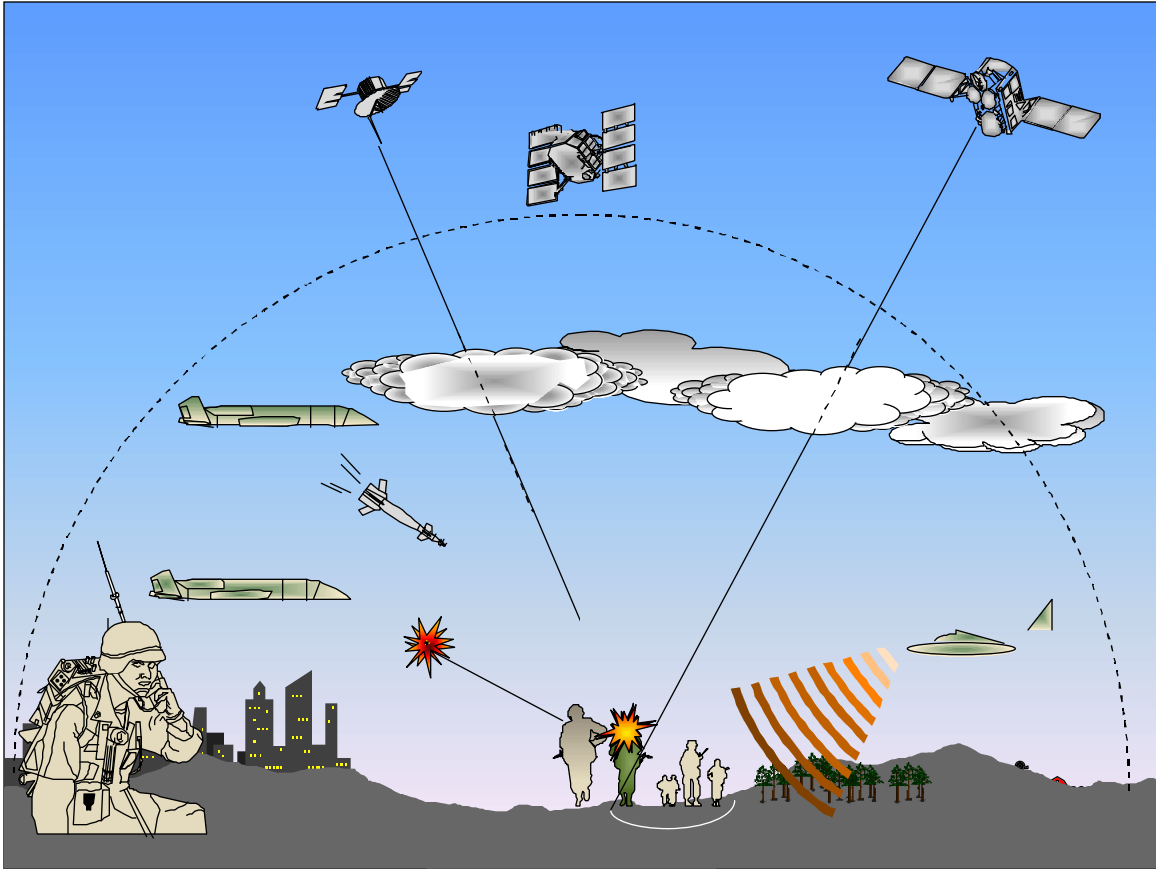

Figure 3-5. Security Assurance Force Fire-Free Zone

Additionally, the problem of mobile kinetic targets burdens the conventional lethal forces. SAF must solve this equation effectively in the most difficult terrain—urban environments—to limit collateral damage and assure a “fire-free” zone. Figure 3-5 graphically depicts one solution to this problem. Additionally, we have outlined air dominance missions, objectives, and technologies in table 4 below.²⁷

The air dominance mission will be significantly enhanced by certain technologies. For example, Lawrence Livermore Laboratories developed a system—LifeGuard—which provides accurate computerized thermal bullet tracking.²⁸ Less than 300 milliseconds (ms) after an incoming round is fired, LifeGuard gives a track back to the point of fire. Pinpointing the “shooter” allows direct application of lethal, sublethal, or nonlethal means to apprehend the individual or entity and deter others. SAF forces would mount the LifeGuard system on one of several UAVs and ultralights operating in a constellation over the target area. Constellation configuration is tailored to the environment, taking into account urban or desert terrain (fig. 3-6).²⁹

Table 4

Air Dominance Objectives and Technologies

MISSION	OBJECTIVE	TECHNOLOGY
Air dominance	Deterrence, law and order	<ul style="list-style-type: none"> • UAV/ultralight configured with LifeGuard • Anti-sniper probability device • Suppress hostile artillery • Laser Anti-sensor Weapon
Air dominance	Urban assault	<ul style="list-style-type: none"> • Helo vehicle hybrid
Air dominance	Psychological operations	<ul style="list-style-type: none"> • UAV configured as replacement EC-130
Air dominance	Weapons delivery (lethal & nonlethal)	<ul style="list-style-type: none"> • UAV with rocket launchers, EMP, microwave, lasers • Pyrotechnic Electromagnetic Pulse • RF warhead
Air dominance	Survivability	<ul style="list-style-type: none"> • UAV configured with chameleon concept • Full body armor
Air dominance	Command and control	<ul style="list-style-type: none"> • Holographic C² Sandbox (also applicable to C⁴ section)

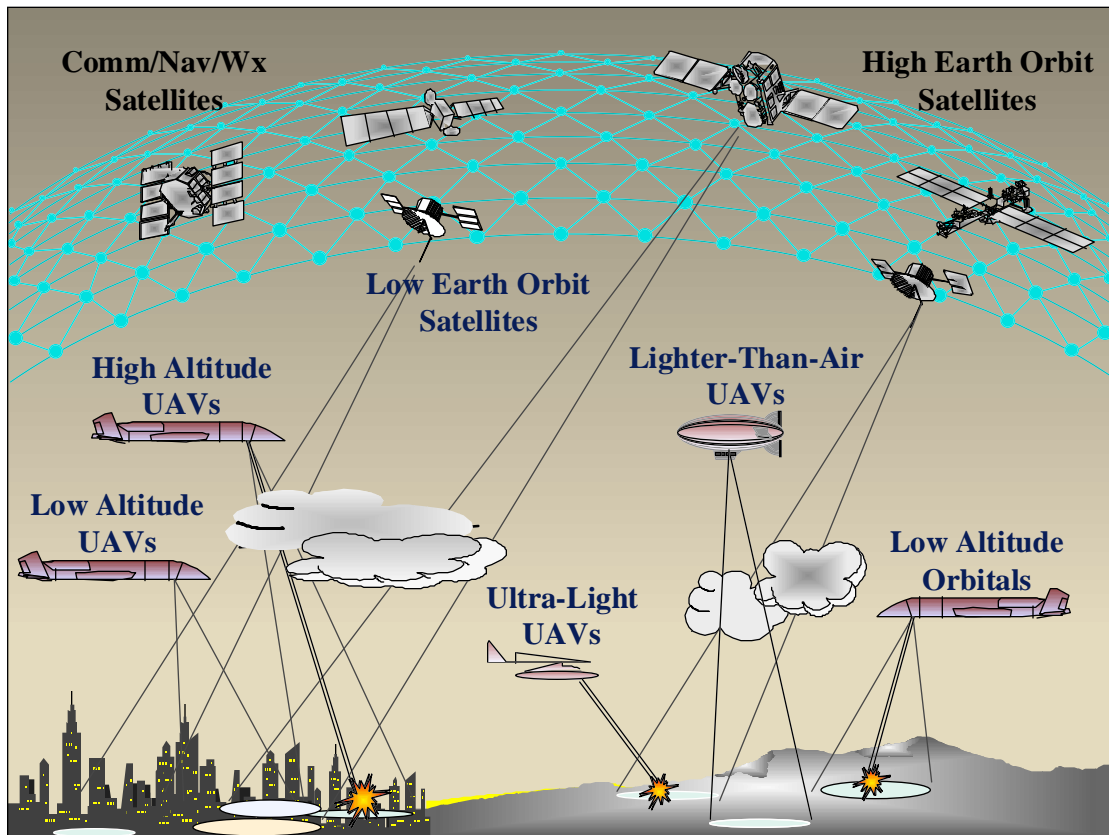

Figure 3-6. SAF UAV “Constellation”

While rapid reconfiguration of the UAVs for tailored employment is a linchpin to this concept, SAF’s constellation must meet other criteria as well. The UAVs and ultralights must be cheap, durable—long-

loiter, reliable—and create zero requirements for logistics support (i.e., cheap enough to be expendable).³⁰ Some of the orbitals would be camouflaged with the chameleon concept to resist detection.³¹ Different configurations would answer several missions: (1) some would be configured with the LifeGuard system and potentially a delivery means for nonlethal/sublethal weapons or targeting devices; (2) others would replace EC-130 psychological operations platforms rigged with communication devices or relay antennas; and (3) certain orbitals could mimic potent lethal platforms in sound or radar cross section (e.g., the AC-130 gunship to further the deterrent ability of SAF).

Airpower's speed and maneuverability are central to neutralizing potential conflicts. Increased loiter times deliver a “psychologically exhausting presence” to coerce people to obey prevailing civil and military law or merely to instill order.³² Introduction of pervasive UAV constellations would obviously lead to an opposing force desire to destroy or neutralize the SAF capability for political, ideological, or economic reasons. Several minimum measures would enhance constellation survivability: (1) keep it cheap—not worth killing, (2) keep it small—easy to multiply, tough to pick the “right” target, and (3) camouflage—can't see, can't kill!

Education

The second component of SAF's CEI is education, a long-term remedy for social or political ills. SAF constabulary forces should provide a conducive environment for education programs conducted by both local leaders and outside personnel.³³ One goal of education is to create a literate population that can support either industry or other market-friendly opportunities. Attainment of this goal would attract foreign investment as a self-fulfilling prophecy. Portions of the US education solution set can be exported via technological means to rapidly answer short- and long-term stability goals (table 5).

Table 5

Required Education Technology

Mission	Objective	Technologies or Concepts
Export best of US education structure, philosophy, ³⁴ & architecture, not necessarily “values” (must have broad cultural appeal)	<ul style="list-style-type: none"> • Initial foundation • Secondary • Undergrad/grad college • Vocational/technical 	“Selective” school or “dial a subject” <ul style="list-style-type: none"> • Economics • Military/Martial Arts • Politics • Religion
Global Schoolhouse ³⁵ Teach to Think & Question (not necessarily spout media sound bites)	“Tools” + Desire = Education Doctrine: Retain ability to read, write, and arithmetic	Brilliant Warrior ³⁶ distance learning program basis for global schoolhouse (just as military “gave” the world internet, we will “give” them distance learning)
Export hard solutions— “info” on target fixes...answers to natural disasters, refugees, humanitarian actions, or economic crises.	<ul style="list-style-type: none"> • Market/financial • Infrastructure Medical Logistics Engineering 	Innovative answers for organic fixes. Zero sum “imports” such as wood, water, power, food, or medicine. What’s here to use? Come as you are peace.

Today, military forces conduct traditional military-to-military education missions, primarily US Army Civil Affairs units performing civil administration and military civic action tasks.³⁷ However, operations in the peacespace cloud traditional roles and may cause mission creep. SAF doctrine should spell out specific military responsibilities for education and differentiate these from civilian roles and missions. Primarily, the military will continue to provide lift, information “pipes,” and security for civilian or country teams.³⁸ The primary differences between SAF and today’s forces are organization, training, and equipment tailored to the peacespace mission. SAF will allow clearly defined roles for both the nontraditional and traditional warriors in 2025.

Nongovernmental and private volunteer organizations may require airlift support of personnel and equipment. One preemptive measure of education would be to “pipe” the necessary tools and equipment remotely. Distance learning could enable foreign stability or crisis response by extensive use of communication hookups under dissimilar architecture. SAF forces could harvest innovative solutions, both military and civilian, to integrate disparate mediums and levels of technology. Print, radio, television, telephone, and computer networks all facilitate SAF missions. These lines of communications would allow

passage of information, and processing or translating it, to ensure accurate comprehension and communication.

Infrastructure

In 2025, infrastructure development will be a cooperative effort between the host nation and multinational efforts. US Commerce Secretary Ron Brown's ill-fated mission to former Yugoslavia and Croatia in 1996 was designed to bolster foreign investment in the region.³⁹ To achieve the desired end-state, SAF may coordinate the efforts of such agencies as the departments of Justice and State, the Environmental Protection Agency, nongovernmental organizations, multinational corporations, and private volunteer organizations for lift, security, or education. These institutions offer critical knowledge to developing a host nation's infrastructure. Those US military forces performing infrastructure missions will work side-by-side with these agencies. While SAF can build roads, bridges, and industrial facilities, and perform environmental cleanup, the bulk of infrastructure development should come from indigenous sources or foreign capital investment provided by private investors and international lending organizations.

To transition SAF out of an area or region requires a "handoff" to civilian control. Before this transition can occur, some infrastructure should be in place to entice foreign capital investment for continued economic growth. Infrastructure in this sense includes both man-made and natural elements. Stewart Brand suggests "the whole world is worried about the natural infrastructure—soils, aquifers, fishable waters, forests, biodiversity, and even the atmosphere. The natural systems are priceless in value and nearly impossible to replace, but they are cheap to maintain."⁴⁰ Table 6 outlines the projected infrastructure missions, objectives, and applicable technologies.

Table 6

Required Infrastructure Technology

MISSION	OBJECTIVE		TECHNOLOGY	
	SAF rqmts	Customer rqmts	SAF rqmts	Customer rqmts
Acquisition	Specialize in acquisition of non or sublethal weapons	Exploit organic capability through contractual actions before “importing” Western goods or services	N/A	Situation dependent
Logistics • Supply • Maintenance • Transportation • Plans	Primarily commercial off-the-shelf or contracted support	Situation dependent • Food, water, shelter? • Industrial? • Advanced technical?	Situation dependent	Situation dependent
Medical	• Preventive care ⁴¹ • Triage (SAR) • Medevac	• Organic capability • Preventive care • Triage • Advanced care • Infrastructure	Tailored to environment	Tailored to long/short-term needs
Personnel	• Small, rugged, Mobile • Selected for behavior traits	N/A	Increase intel dependence—keeps force small	N/A
Training	• Restraint • Conflict prevention • Conflict resolution	Tailored to region	Unlimited potential	“Global schoolhouse”
Engineering	• Power, roads • Billets	• Power, roads, rail • Buildings	Reusable buildings ⁴²	• expertise • organic
Command, control, communications, computers	Service and commercial dependent	Depends on level of development & cultural needs	Robust and minimum architecture	Lend/lease commercial enterprise

Infrastructure is the largest area of SAF, yet we have deliberately chosen to limit our focus to only a few examples. This area requires substantial development by experts in each field. For example, SAF may require such unique mission equipment as an autonomous cargo handling capability—essential, and achievable by advanced systems such as computer control from a cockpit console, a rapidly reconfigurable powered floor, and an articulated cargo ramp. These systems permit transfer of pallet loads directly to and from bare trucks with minimum crew member assistance.⁴³ Each area in infrastructure requires careful and thoughtful analysis before final planning, programming, or acquisition.

Summary

“Try not. Do, or Do not. There is no try.”

“I don’t believe it.”

“That is why you fail.”⁴⁴

While we presented many technological options to “solve” peacespace operations, the real solutions lie with people. Someone has to agree to confront peacespace problems. We believe that person should be a warrior, not a wizard. Defining Liddell Hart’s “better state of peace” may reveal exactly why we choose to engage. We *may* opt to apply SAF’s force, avoid the battle, and enter the peacespace for prevention or resolution. Accepting the challenge to shape the better state of peace determines the rules and tools.

SAF’s constabulary, education, and infrastructure force is evolving even now. Many traditional military tasks are migrating to civilian contract or civil service. Nongovernmental and private volunteer organizations are proliferating as quickly as web sites on the internet. These questions must be addressed. The US military option for maintaining credibility, legitimacy, and competency as warriors may be as simple as leading the way. SAF is one answer to this problem.

Notes

¹ Liddell Hart, *Strategy*, (1954; new imprint, New York: Meridian, 1991): 338; Fred Charles Iklé, *Every War Must End*, (New York: Columbia University Press, 1991): 106–31; Paul Seabury and Angelo Codevilla, *War, Ends & Means* (New York: Basic Books Inc., 1989): 263–69. Liddell Hart, Ikle, Seabury and Codevilla developed a fascinating thesis through the past 42 years. Liddell Hart began with a simple but ill-defined sound bite, “better state of peace.” Iklé discusses ending wars before they begin. Finally, Seabury and Codevilla distill the argument down to three choices: (1) peace of the dead, (2) peace of the prison, or (3) peace by cultural conquest. Dr. Cable (“The End State,” lecture, 16 January 1996), contends the “dead dictate policy” for any nation bringing conflict to closure. Obviously, the notion of *peace* consumes the intellectual and military alike. Our most fragile problem today remains—deciding exactly what a better state of peace means to ourselves and our opponents.

² The digital cultural map depicted and envisioned would be a complex beast (i.e., an equivalent supercomputer in 30 years) that ties into a nearly unlimited number of open source databases and archives. Several examples would include weather, financial, agricultural, cultural (religious, language and dialects, ethnic), population, disease, technological advancement, infrastructure, water or food source and supply. Leaders could select specific geopolitical or geostrategic map displays. Tripwires and flashpoints for intervention could be triggered through a combination of the fuzzy cognitive mapping technique described by Bart Kosko, *Fuzzy Thinking, The New Science of Fuzzy Logic*, (New York: Hyperion, 1993): 222-32; and Maj Glenn James, “Chaos & Campaign Planning,” lecture, Air Command and Staff College, Maxwell AFB, Ala., 8 March 1996. The database management and weighting of individual intangibles would remain largely

the purview of cabinet level staffs. Ultimately, a leader could peel back the layers of the onion on demand to review migratory trends or consumption data, or to evaluate measures of effectiveness for investments made. This concept would rely on unprecedented interagency, international, and individual cooperation.

³ Alvin Toffler and Heidi Toffler, *War and Anti-War* (New York: Warner Books, 1995).

⁴ Benjamin Schwarz, "The Diversity Myth: America's Leading Export," *The Atlantic Monthly* 273, no. 5 (May 1993): 67. Schwarz asserts US intervention in ethnic, nationalist, and separatist (ENS) wars should be an option only when specific, vital US interests are threatened."

⁵ This doctrine section adapts original tenets of aerospace power as listed in AFM 1-1, *Basic Aerospace Doctrine of the United States Air Force*, vol. 1 March 1992: 8. Also, Col Phillip Meilinger, USAF, wrote a treatise, "10 Propositions Regarding Air Power," Air Force History and Museums Program, February 1995. Proposition 5 states, "Air Power produces physical and psychological shock by dominating the fourth dimension—time." This proposition led Colonel Meilinger to conclude: "This leads to an important insight regarding the effectiveness of airpower in low-intensity conflicts. Because guerrilla war is protracted war, by its very nature it is ill-suited for air power, denying it the ability to achieve decision quickly." This conclusion ignores the potential for airpower as demonstrated by the Navy in Bosnia and likelihood of UAV, UCAV employment. Col Richard Szafranski rebutted Col Meilinger's position in "Twelve Principles Emerging from 10 Propositions," *Airpower Journal* 10, no. 1 (Spring 1996): 51–80. Certainly all land, air, and sea dominance missions, either civilian or military, require disciplined examination of preconceived notions in the "new world order." This paper only addresses some air disciplines involved. We recommend the reader search such lucrative sources as Toffler and Toffler, *War and Anti-War*, 19–27, 103–13, 146–57; Thomas J. Peters and Robert H. Waterman, Jr, *In Search of Excellence* (New York: Warner Books, 1982), 89–119; Michael Hammer and James Champy, *Reengineering the Corporation*, (New York: Harper Business, 1993): 31–50. SAF will require innovative doctrine that synthesizes military and civilian philosophy into a single, seamless structure. For example, Toffler and Peters provide examples from the civilian world which would enrich military doctrine.

⁶ Toffler, 67–68.

⁷ UAVs and long-loiter platforms provide the ultimate in persistence. As technology improves, they give many of the advantages of physical presence without the disadvantages. Thus airpower is found in many venues such as the recent employment of the Predator UAV off the *USS Carl Vinson*. In the extreme case, you would pursue some goals without ever physically occupying the land. The current debate over "air occupation" notwithstanding, sufficient "air dominance" should significantly reduce the number of ground personnel required as well as decreasing the risk of casualties. Additionally, Dr. Larry Cable (interview with authors, 28 March 1996) notes that "physically exhaustive presence" often succeeds in wearing down the will to resist and airpower is uniquely suitable to this task.

⁸ Composite force doctrine is fertile ground for further research and inquiry. Peacespace forces require the discipline of other fields such as international organizations, politico-economic analysis, crisis resolution, and comparative politics. Lt Col Ann E. Story and Major Aryea Gottlieb call for additional work in their article "Beyond the Range of Military Operations," *Joint Force Quarterly*, Autumn 1995, 99.

⁹ We have included a list (appendix B) of all technologies for ease of reference.

¹⁰ We arrived at these force structure characteristics after careful investigations of current efforts around the world by US military personnel. While one senior officer agreed "4000 was about right (brigade size)," he did not advocate the conversion of any combat forces to this role. Zero sum budgets artificially constrain speculation of possibilities for 2025 force structure changes. Also, military personnel are covered by "limited" liability and have the right to die for their country without recourse (Feres Doctrine). Force structure for civilian expertise requirements in hazardous, albeit peacespace conditions, and their implications are not addressed in this white paper.

¹¹ Carl H. Builder, "Doctrinal Frontiers," *Airpower Journal* 9, no. 4 (Winter 1995): 9.

¹² Maj Edward O'Connell, USAF, "Nonlethal Concepts: Implications for Air Force Intelligence," *Airpower Journal* 8, no. 4 (Winter 1994): 26–33. In his first draft of this article, Major O'Connell developed a concept for a mixed-bag adaptive response capability where both lethals and nonlethals are configured aboard a B-1 aircraft. With advanced command and control capability, NCA could redirect

responses in flight as the ground situation changes from “hot” to “cold.” He was instructed to remove this section before publication. Used by permission.

¹³ Col John Warden, *The Air Campaign: Planning for Combat* (Washington, D.C.: NDU Press, 1988), 4. Colonel Warden introduces a concept for battlespace dominance now known as “strategic paralysis.” Peacespace dominance may need a “strategic paralysis” to impose the pause required for a change of course or course correction.

¹⁴ We have only begun the transition to less than lethal technology and now that change will affect the way we execute the business of war. The impact will probably be immense. Suggest reading Capt Vicki J. Rast and Maj Bruce R. Sturk, “Coalitions: The Challenge of Effective Command and Control in Support of the Air Campaign,” *Air Command and Staff College Theater Air Campaign Studies Coursebook* (Maxwell AFB, Ala., 1996): 169–90. Rast and Sturk provide an excellent analysis of direct and indirect effects versus effectiveness, and the often hidden second-order consequences for actions taken during any campaign. Second-order consequences are effects felt “down the road” and not readily apparent at the time. This paper is a necessary read for anyone establishing the SAF concept.

¹⁵ **2025** Concept, no. 900664, “Tiltwing Super Short Take off and Landing Advanced Theater Transport,” **2025** concepts database (Maxwell AFB, Ala.: Air War College/ **2025**, 1996); **2025** Concept, no. 900203; “Heavy Lift Aircraft with Mission Pod,” **2025** concepts database (Maxwell AFB, Ala.: Air War College/**2025**, 1996); USAF Scientific Advisory Board, *New World Vistas: Air and Space Power for the 21st Century* (unpublished draft, the mobility volume, 15 December 1995), 15, 16, 22; *New World Vistas*, (unpublished draft, the aircraft and propulsion volume), 39; **2025** Concept, no. 900906; “Personal Identification Friend or Foe (PIFF),” **2025** concepts database (Maxwell AFB, Ala.: Air War College/ **2025**, 1996).

¹⁶ Calmative agents are but one category of an ever-increasing litany of nonlethal weapons.

¹⁷ During the team brief to HQ AFSOC/CV on 6 March 1996, Brig Gen Ingersoll discussed the requirement for vertical emplacement of water purification devices. In 1996, this requires the cubic space of a C-5, a significant shortfall in current lift capability.

¹⁸ Szafranski, 76. Col Szafranski notes the greatest weakness of airpower lies in the fact we “can blow a door off of its hinges, but—unlike a simple soldier or marine—airpower cannot see what is behind the door.”

¹⁹ Toffler and Toffler, 185.

²⁰ Ibid.

²¹ Ibid., 186, 189–190. One example of “innovative” intelligence gathering would have been monitoring how long before the invasion of Kuwait Lloyds of London stopped issuing insurance in the region.

²² *New World Vistas*, (unpublished draft, the aircraft and propulsion volume), 10, 43; **2025** Concept, no. 900701, “Long Duration UAVs,” **2025** concepts database (Maxwell AFB, Ala.: Air War College/**2025**, 1996); **2025** Concept, no. 900763, “Unmanned Mini Helos,” **2025** concepts database (Maxwell AFB, Ala.: Air War College/**2025**, 1996); *New World Vistas*, (unpublished draft, the sensors volume), 48, 50, 57, 62; *New World Vistas*, (unpublished draft, the directed energy volume), 29.

²³ Col Richard Szafranski coined this phrase in a paper co-authored with Dr. Martin Libicki entitled, “. . . Or Go Down in Flame: An Airpower Manifesto for the 21st Century,” unpublished **2025** white paper. Used by permission.

²⁴ Figure 3-4 in the air dominance section depicts the envisioned UAV Constellation including both air occupation platforms and ISR/C⁴ orbitals.

²⁵ See Szafranski, “Twelve Propositions,” 73, for a caveat. We present air dominance as one possibility to reducing the total ground troops required, not necessarily to replace them entirely.

²⁶ Builder, 11–13.

²⁷ Not all of the constabulary missions are “high tech.” Cable’s “psychologically exhausting presence” may encompass “low tech” alternatives which were successfully employed in Just Cause and other special operations/conventional missions. Some examples of “low tech” would be lights, lasers, noise, and “positive” communication. Scott R. Gourley, “The Sniper’s Latest Nightmare,” *International Defense*

Review 28, no. 4 (April 1995): 66. Gourley reports on the Lawrence Livermore Laboratory concept for computerized thermal bullet-tracking capability developed by Dr. Thomas Karr and originally brought to our attention by Janet Morris. Further investigation revealed Bosnia officials requested this technology as part of their containment efforts. (Also in *Wired* magazine, *Newsweek*, and *Washington Post*.) Hereafter referred to as LLLab concept. **2025** Concept, no. 900705, "Anti-Sniper Probability Device," **2025** concepts database (Maxwell AFB, Ala.: Air War College/**2025**, 1996); *New World Vistas*, (unpublished draft, the attack volume), 11, 13; *New World Vistas*, (unpublished draft, the directed energy volume), 9; **2025** Concept, no. 900658, "Urban Assault Helo Vehicle Hybrid," **2025** concepts database (Maxwell AFB, Ala.: Air War College/**2025**, 1996); *New World Vistas*, (unpublished draft, the aircraft and propulsion volume), 10, 24; **2025** Concept, no. 900711, "Multipurpose UAV," **2025** concepts database (Maxwell AFB, Ala.: Air War College/**2025**, 1996); **2025** Concept, no. 200009, "Pyrotechnic Electromagnetic Pulse 'PEP'," **2025** concepts database (Maxwell AFB, Ala.: Air War College/**2025**, 1996); **2025** Concept, no. 900699, "Chameleon Camouflage," **2025** concepts database (Maxwell AFB, Ala.: Air War College/**2025**, 1996); **2025** Concept, no. 900753, "Full Body Armor," **2025** concepts database (Maxwell AFB, Ala.: Air War College/**2025**, 1996).

²⁸ LLLab concept.

²⁹ "Constellations" will encompass a complex architecture by 2025, composed of low-altitude (atmospheric or air breathing) orbitals, low-earth orbitals, and so forth. Just as gunships, tankers, and AWACS "orbit" in racetrack patterns in 1996, new UAV replacements would employ these and new tactics.

³⁰ Lean logistics, two-level maintenance, and streamlined acquisition process concepts currently allow circuit cards valued from \$3,000 to \$33,000 to be disposed without developing technical orders, test stations, or training for their repair. This trend, coupled with industry's response for "just in time" supplies, may change our preconceived notions of what is expendable and what should be repaired. This same logic applies to the automobile industry—we "replace" computers instead of "repairing" the old Chevy.

³¹ **2025** Concept, no. 900699, "Chameleon Camouflage," **2025** concepts database (Maxwell AFB, Ala.: Air War College/**2025**, 1996).

³² Cable, "The Dangers of Dogma," lecture, Air Command and Staff, Maxwell AFB, Ala., 28 March 1996.

³³ Lt Col Federico J. Rodriguez, Ph.D., USAR, "Interdisciplinary Collaboration in the Americas," *The Officer*, vol. 62, no. 3 Reserve Officer's Association of the US (March 1996): 24-27. Dr. Rodriguez is the professor of graduate education at California State University, Dominguez Hills, California. The Collaborative Educational Programs for the Americas (CEPA) is an international program that brings together an interdisciplinary group of professionals from education, law enforcement, and the military to meet future challenges and to develop an educational infrastructure for personnel and material resources. "This program serves as a model for education and social reform within our [southern] hemisphere for the 21st century." Rodriguez' insight and suggestions were invaluable to our research efforts.

³⁴ Lt Col Anita M. Arms, "Strategic Culture: The American Mind," *ACSC Theater Air Campaign Studies Coursebook*, 1996, 150-63. In a subsection of this article, Ms Arms discusses education as the equalizer in "purveying political ideology to immigrants and native-born (Americans) alike. Further, in an endnote, she quotes Michael Olneck and Marvin Lazerson, "Education," *Harvard Encyclopedia of American Ethnic Groups*, Stephen Thernstrom, ed, 304. It is also interesting to note the lack of a national school system effectively prevented, and still prevents, arbitrary testing that would divide students into white collar and blue collar educational tracks early. University attendance still does not depend on the score of an exam taken at age 10 or 12. It depends on completing high school with grades high enough to meet the college entrance requirements. It permits the illusion that in the US, anyone can succeed, and thus furthers the belief in social equality.

³⁵ Schwartz, *The Art Of the Long View*, 125. Schwartz discusses at length the possibilities associated with technology and education in the future, especially as associated with the "Global Teenager."

³⁶ Lt Gen Jay Kelley, Air University commander, "Brilliant Warrior," **2025** white paper (Draft).

³⁷ Joint Publication 3-0, *Doctrine for Joint Operations*, 1 February 1995, v-1 through vi-12.

³⁸ Dr. Martin Libicki, " Battlespace Dominance," lecture, 25 March 1996. Dr. Libicki briefed the evolution of communications "pipes" which carry data such as telephone lines, television cable lines, and power lines. The size restricts the throughput and is the next step in the information "revolution."

³⁹ Bill Montague and Christine Dugas, "Peacemakers Slow to Invest in Bosnia," *Pensacola News Journal*, Gannett News Service, Sunday, 7 April 1996, 3D. US companies invested \$4.5 million in Croatia from 1992 to 1994 representing just 4.4 percent of foreign investment. The World Bank approved \$269 million in loans for three projects on 1 April 1996. The US and other nations have promised to fund a \$5.1 billion plan to rebuild bridges and other infrastructure.

⁴⁰ Steward Brand, "Army Green." Document was originally published in *Whole Earth Review*, Issue #76; on-line, Internet, 14 May 1996, available from gopher://gopher.well.sf.ca.us:70/00/WER/Army_Green.

⁴¹ We envision development of a computerized personal doctor that maintains individual history, takes vitals, and emits basic prescription requirements which is "licensed" to practice medicine for deployed troops.

⁴² On 10 April 1996, 2100 hours, Montgomery Alabama Public Broadcasting Channel (PBC) ran a special on Buckminster Fuller, an engineer who developed geodesic structural designs in the 1950s. Shunned by the architectural community as little value added, these structures have greater tensile strength than "stick-built" homes, they snap up and down relatively quickly, and can be stored until required. "Architect, inventor, scientist, teacher and philosopher, he advocated intelligent use of the earth's resources to gain the maximum return for the minimum of material and energy expended, and produced numerous models of how it could be done." Information provided by Lt Cmdr Alton Ross, Air Command and Staff College, Seminar 17, 1996. On-line, Internet, 14 May 1996, available from <http://www.echonyc.com/~mysticfire/MABucky.html>.

⁴³ **2025** Concept, no. 900664, "Tiltwing Super Short T/O and Landing," **2025** concepts database (Maxwell AFB, Ala.: Air War College/**2025**, 1996). Also articulated by General Ingersoll as a dynamic factor in current operations.

⁴⁴ Yoda speaking with Luke, *The Empire Strikes Back*, ©1980, Lucasfilms Ltd.

Chapter 4

Concept of Operations

It's not the bullet with my name on it that worries me. It's the one that says "To whom it may concern."

—Anonymous Belfast resident

With clear entry criteria, SAF conducts its operation. Three notional scenarios illustrate our concept. To combat a cholera outbreak in Benin caused by contaminated water, SAF would deploy directly into outbreak areas in strategic aircraft using advanced navigation systems coupled with vertical take-off and landing platforms. Simultaneously, containerized inoculation facilities and medical teams would deploy to remote regions and provide medical care. In this instance, levels of violence are low, thus reducing the need for a SAF constabulary force. SAF's primary role would be to contain the disease outbreak and prevent further occurrences. Long-term fixes result from educating the population on health and sanitation procedures. The primary education effort would be civilian-led with SAF assistance, protection, and delivery. SAF would only minimally improve Benin's modest infrastructure. The SAF military effort would be short-term (less than one year) with follow-on education and infrastructure terminated in the midterm (five years).

In another scenario, a region is in a state of anarchy, suffering from a collapse of its infrastructure. This region is marked by widespread disease and mass famine—similar to the situation US forces encountered in Somalia. In this scenario, US/UN conventional forces would first move to secure the area. SAF units would then deploy in-country via strategic lift, reducing the need to maintain security of port facilities. In their constabulary role, SAF would employ both nonlethal weapons and linguists to develop and maintain order. Constabulary forces could establish judicial processes, local police, and legal institutions to permit an

effective transfer of law and order duties to local authorities.¹ Constabulary forces would also employ ultralight UAV to ensure air dominance and provide continuous presence while reducing risks for ground force elements. Technology such as LifeGuard would identify snipers and other potential combatants. Simultaneously, education and infrastructure personnel would provide medical and famine relief. In this example, the constabulary effort to redress violence is modest. Education requirements are high as they must effectively “jump start” and sustain sufficient infrastructure development to maintain a better state of peace. This would be a mid-term effort—five to ten years.

Finally, factions may actively fight in a technologically adept society similar to those of the former Yugoslavia or Northern Ireland. If leaders decided to intervene, special or conventional forces may engage the combatants before SAF would assume their constabulary role. Constabulary duties could be long-term (greater than ten years), pending a political settlement (as in Northern Ireland). Traditional education efforts would be minimal if key indicators (such as literacy rates) are high. Infrastructure needs would be both high and long-term if the infrastructure suffers widespread destruction (as in former Yugoslavia). Infrastructure rebuilding could be accomplished in five-to-ten years. If leaders decide to progress a first wave society to the second or third wave, SAF would require a 20 to 30-year commitment.²

Some scenarios will remain beyond SAF’s core competencies. Conflicts based on deep-seated cultural or political differences will likely have to be solved at the bargaining table before SAF’s introduction. SAF constabulary forces could separate belligerents (at great risk), but centuries old hostility and a nearly unlimited willingness on the part of some factions to kill one another may exceed all available resources. New options and solutions such as nonlethal weapons, advanced airlift, cultural knowledge, funding, or even improved infrastructure may prove fruitless. However, a preponderance of missions tackled in 1996 fall neatly into SAF’s area of expertise.

Notes

¹ Discussions with Headquarters Air Force Special Operations Command personnel who participated in Operation Just Cause revealed the methods for transfer of law and order responsibility from military to civilian personnel. Essentially, Panamanian Defense Force (PDF) personnel were offered asylum and amnesty in exchange for turning in their weapons. At the first station, PDF members would relinquish their weapons. At subsequent stations, they would (1) denounce the current regime, (2) indicate a desire to serve

under the new regime, (3) swear allegiance to the new regime, and (4) receive back their weapon and a schedule for training and indoctrination.

² Alvin Toffler and Heidi Toffler, *War and Anti-War* (1993; new imprint, New York: Warner Books, May 1995), 35–94.

Chapter 5

Recommendation

Frankly, I'd like to see the government get out of war altogether and leave the whole field to private industry.

—Joseph Heller

This paper asserts the need for a force dedicated to preventing conflict. On 13 May 1996, Secretary of Defense Perry stated, “America must lead the world in preventing the conditions for conflict and in creating the conditions for peace. In short, we must lead with a policy of preventive defense. It’s about hard work and ingenuity today, so that we don’t have to expend blood and treasure tomorrow.”¹ In this chapter, we will discuss plausible options for implementing SAF—a blueprint for change.

One option encompasses either unilateral US action or a US-led multinational team in performing the SAF mission. This option has several merits, since it avoids placing American lives in the hands of others and allows the US to determine its own destiny. In addition, the US possesses unique capabilities that argue for its leadership: we have enormous energy, and we often lead in managerial and technological initiative; harnessing the power required to avert war is within our capability; and leading the SAF effort will foster the perception that we are “giving back” to the rest of the world in some tangible way.

The US role as lead agent could have unintended consequences. US efforts might be caricatured as a latter day “white man’s burden,” where we solve the world’s problems by exporting US values and beliefs. This would be unpalatable in many cultures. Also, the temptation exists for the US to favor our interests at the expense of the resident population. This is not only bad public relations, it is also counterproductive to US interests in the long run.

It may also be in US interest to allow an “evolved” UN—or another nation—to lead in developing a SAF capability. Peacespace dominance may be more suitable for other nations (Japan, Singapore, Scandinavian countries, Canada) which have forsworn the use of force or are perceived as more neutral. Their domestic cultures might be more conducive to performing a SAF role.

The drawbacks to this option: The US may have little leverage determining if and when an intervention should be made; we can exercise little control once the mission starts; and these operations require substantial funding. Would the US be willing to pay when we are not “calling the shots”?

Another option may be to stay the course. It can be argued that the current system is working fine and needs only minor modifications to the concept of operations to and doctrine.² Many assert that the military can both keep the peace and fight. In their view, ramping down for peace operations is well within the present capability of the military. Our warriors are well-educated, trained, and psychologically nimble enough to do both.

This is not a universally-held view however. Opponents argue that SAF would free the conventional military to concentrate on its primary combat mission while providing a critical capability in crises that will only become more numerous and complex. Table 7 summarizes three possibilities for peacespace dominance.

Table 7

Responsibility for SAF

	US Unilateral or US Led Multi-National	UN Initiative or “other National” Effort	Stay the Course
Pros	<ul style="list-style-type: none"> • US leadership prods other nations to act • Education structure and technological prowess (“science” skills) enjoy a reputation as “best” in much of the globe • Education is a great export item • World’s largest economy, highest per capita income, and low debt as percentage of gross domestic product = we pay for “it,” therefore we should <i>do</i> it • Improved public image for sharing the wealth 	<ul style="list-style-type: none"> • Nations who have forsworn the use of armed force possess instant credibility abroad • Already perceived as neutral • Cultures are amenable to the concept • Other cultures’ education systems are already sophisticated in art of conflict resolution and prevention as opposed to simply termination 	<ul style="list-style-type: none"> • Military easily ramps down from combat mission • Current system largely works with minor doctrine/training modifications
Cons	<ul style="list-style-type: none"> • Unintended consequences • Makes US a target rather than a benefactor (“I’ll help as long as you do it <i>my way</i>”) • US lead or unilateral action creates obstacles obtaining “legitimacy” . . . might be viewed as imperialistic 	<ul style="list-style-type: none"> • Legitimacy of UN interventionary action is currently questionable • US interests may diverge from UN • Entry/exit criteria blur for UN 	<ul style="list-style-type: none"> • The system is broken and should be fixed • Performing <i>peacespace</i> missions erodes combat capability

Conclusion

What needs to be done to make SAF a reality? This paper only touches areas which beg greater exploration.³ Leaders have 30 years to focus energy and funds against specific requirements and capitalize on existing progress. Joint, service, and civilian doctrine need to apply rich lessons learned from the past. The technologies mentioned in this paper hint at the possibilities.⁴ The digital cultural map might accurately predict and identify trouble areas, but the concept requires careful study prior to development. Unmanned aerial vehicles, nonlethal weapons, and a “global schoolhouse”—all present tantalizing possibilities.

Like US businesses struggling to restructure, the US military has transformed itself from the demoralization of the 1970s to a peak performer in 1990—“an elegant force.”⁵ An evolving world order, increasing demands on declining resources, and potential technologies afford the “elegant” warrior an unprecedented opportunity. If properly developed, planned, and funded, SAF could be available in 2025 to

help dampen violence and orchestrate the peace. The military has demonstrated an ability to lead the way and change the future. It is in our best interests to act.

What vast additions to the conveniences and comforts of living might mankind have acquired, if the money spent in wars had been employed in works of public utility; what an extension of agriculture even to the tops of our mountains; what rivers rendered navigable, or joined by canals; what bridges, aqueducts, new roads, and other public works, edifices, and improvements . . . might not have been obtained by spending those millions in doing good, which in the last war have been spent in doing mischief.⁶

Notes

¹ William J. Perry, remarks delivered to the John F. Kennedy School of Government, Harvard University, on-line, Internet, 13 May 1996, available from: <http://www.dtic.mil/defenseink>.

² Col Anthony Wood, USMC, Quantico Warfighting Laboratory Director, "Sea Dragon: Warfighting in the Future," lecture, Air War College, Maxwell AFB, Ala.: 17 May 1996. Col Wood stated a corollary to the familiar maxim "If it ain't broke, don't fix it," which says "Just cuz it ain't broke, don't make it relevant."

³ "World View: The 1996 Strategic Assessment From the Strategic Studies Institute," edited by Earl H. Tilford, Jr., US Army War College, Carlisle Barracks, Pa.: 1996, 12. Steven Metz eloquently summarizes the requirement to explore these questions in depth. Most importantly, Tilford concludes on page 54, "If the Army is to have the capabilities to deter and, when necessary, to compel calculating aggressors of this nature, it must be able to resolve conflicts at levels where human and economic costs are sufficiently low to justify intervention. Otherwise, extortion of the Army's ability to promote and protect non-vital interests will result.

⁴ Maj Kenneth E. McKenzie, Jr., USMC, "An Ecstasy of Fumbling: Doctrine and Innovation," *Joint Force Quarterly*, Winter 1995-96, 67-8.

⁵ Kevin Kelly, "Shock Wave (Anti-) Warrior," *Wired*, February 1995; on-line, Internet, 14 May 1996, available from: <http://www.hotwired.com/wired/1.5/features/toffler.html>. The US military has "gone from the pits of post-Vietnam, drug-drenched, corrupt, bloated bureaucracy into an elegant force." Alvin Toffler in conversation with Peter Schwartz as reported by Kevin Kelly.

⁶ Benjamin Franklin (1706-90), US statesman, writer. Letter, 27 July 1783, to Sir Joseph Banks, president of the Royal Society, after the American War of Independence (published in *Complete Works*, vol. 8, ed. by John Bigelow, 1887-88). *The Columbia Dictionary of Quotations*, Columbia University Press. Copyright © 1993. Microsoft ® Bookshelf.

Appendix A

Criteria for Intervention

CATEGORY	CRITERIA	METRIC*
Sociopolitical	Education literacy rates	percent increase
Sociopolitical	Education infrastructure	growth in secondary, vocational technical schools, colleges, university-type institutions
Sociopolitical	population growth or birth rates	deviation from what region can organically support
Sociopolitical	multilateral intervention requested	existence of coalition, status of forces, or treaty agreement
Sociopolitical	universal suffrage	laws passed/polls measure (<i>cannot be unilaterally applied vis-à-vis Muslim nations</i>)
Sociopolitical	liberties/human rights	international measurement
Sociopolitical	environmental consumption	conservation technology
Infrastructure	indigenous medical capability	rates of infectious disease, infant mortality
Infrastructure	transportation network	adequacy of roads/ports/ airfields to meet “universal” standards
Infrastructure	power grid	ability to convert/upgrade to “universal” standards
Infrastructure	communication grid	ability to convert/adapt to “universal” standards (<i>required/desired?</i>)
Infrastructure	agriculture base	ability to feed population
Infrastructure	potable water supply	adequate to consumption and sufficient for expected growth
Infrastructure	industrial capacity	as required
Economic	knowledge base	exportable? perceived value?
Economic	market structure import/ export rates	open/closed MFN status
Economic	employment rates	percent improvement . . . appropriate to 1 st , 2 nd , 3 rd wave
Economic	inflation rate	control mechanisms
Economic	GDP/capital spending/interest rates	“stability” or growth indicators
Economic	per capita income/personal income	relative personal expectations
Financial	existing internationally recognized “institutions”	adaptability to universal standards of financial trade (i.e., convertible currency/foreign exchange rates)

* As per Dr. Martin Libicki and others, to quantify costs leads to “Slighting the Intangibles” or excessively weighting the analytical vis versa intuition. SAF needs balance. Such tools as a digital cultural map, using fuzzy cognitive mapping (Bart Kosko, *Fuzzy Thinking*) or chaos theory (Maj James lecture) should help to qualify, not quantify.

Appendix B

Underlying Technologies

Technology concepts from the USAF Scientific Advisory Board's (SAB) *New World Vistas* and technology concepts submitted for the 2025 study were reviewed for applicability to the SAF. Concepts harvested from these efforts, which directly or indirectly apply to the SAF roles of constabulary, education, or infrastructure, are summarized and included below.

Aircraft and Propulsion Volume

Uninhabited Aircraft or Unmanned Tactical Aircraft (UTA). This concept would develop unmanned aerial vehicles (UAVs) to do the air-to-air, suppression of enemy air defense (SEAD), strike, and surveillance & reconnaissance (S&R) missions currently done by manned aircraft. The concept also envisions that, without a human in the aircraft, the vehicle could be miniaturized to reduce signature. These UAVs could provide some of the ISR, SAF needs to conduct an air occupation.

Modular Vehicles. This concept calls for manufacturing aircraft that are modular in their components and use. The concept would permit a force to mix-and-match "parts" of an aircraft to change its role. Modular parts would also aid in maintenance. Instead of fixing an engine in the field, the team would simply replace the engine module with a new one. The concept would reduce the logistic tail brought into the field by SAF.

Future Attack Aircraft. This concept envisions a 500-nm-range manned or unmanned aircraft that would use stealth technology (both RF and IR) to reach a target and employ laser or high-power microwave

(HPM) weapons. An unmanned aircraft with a “tunable” HPM weapon could provide either the nonlethal or lethal punch SAF needs in the constabulary mission.

Special Operation Forces Vehicle. This 1500-nm radius, high subsonic speed, vertical take-off and landing (VTOL) aircraft would employ low-observable (LO) technology to reduce signature. The concept is evolutionary and would represent the next generation V-22. This concept could provide the tactical transport for SAF and the primary search and rescue vehicle to recover SAF personnel in distress.

Long-Endurance Aircraft. The concept envisions an unmanned aircraft that can fly for days, weeks, even months, at an altitude of 80,000 feet or more. This high-altitude, long-endurance (HALE) aircraft, with an appropriate suite of sensors, could provide the constant monitoring platform SAF needs. The engines would be solar-powered props, and the aircraft could carry a 2,000-pound payload, enough for sensors or even a single weapon. One drawback for such an aircraft is that its wingspan would probably require it to self-deploy, which might take days.

Attack Volume

Radio Frequency (RF) Warhead, Disabling Enemy RF Sensors. This concept would use UAVs to get very close to the enemy and emit a pulsed RF transmission to knock out the RF (radar, communications) equipment of the enemy. The concept would provide a nonlethal weapon for SAF to use on modern weapons.

Suppress Hostile Artillery. Using moving target indicators (MTI) on UAVs along with unmanned ground sensors (UGS, see later), the concept could track the location of firing artillery and then react with a killer UTA. Expanding on this concept, if SAF were to use multiple UGS sensors along with very accurate MTI sensors on a UAV, we might be able to track sniper rounds over a large area. Once a “shooter” is detected, the UAV could employ lethal or nonlethal weapons.

Directed Energy Volume

Laser Power Beaming. The concept would provide energy (power) to remote systems. For example, this ground laser could “shoot” at a receiver on an orbiting satellite to reenergize it. The laser would work for any electrically powered system.

Virtual Presence. The concept would use a laser to “scan” an area to provide a picture of the area the laser strikes. If combined with in-orbit mirrors, US leaders could obtain real-time pictures of any location in the world. Potentially, the laser could be used like a fiber-optic cable to shine anywhere in the world. The presentation would resemble a TV picture of where the laser hits solid mass. This concept would help SAF monitor situations as they develop and could help in determining if SAF should be employed in an area before we place personnel on the ground.

Mobility Volume

Global Range Transport. This concept would provide an aircraft with a 12,000-nm range and a 150,000-pound payload capacity. The aircraft would require a runway to land, but the concept could employ the precision airdrop concept.

Global Navigation System. This concept is an evolution of the current Global Positioning System (GPS). Improved sensors, coverage, and receivers could increase navigation accuracy to one meter.

Advanced Material Handling Equipment. The concept would provide a solution for how to load or unload cargo from an aircraft when aerial port equipment is not available. One potential technological solution is to load cargo on magnetic levitation pallets. At the destination, the pallets would levitate from the aircraft to where the payload is needed on the field. This concept would be very useful in reducing the amount of equipment SAF would need at a field before moving into the area.

Precision/Large-Scale Airdrop. Using GPS for positioning and light-or laser-imaging detection and ranging (LIDAR) to determine winds, cargo could be dropped into a small area. Though not mentioned in the volume, if we take this concept and add the use of pallets with remote or automatically controlled fins, wings, or stabilizers, and steerable (square) parachutes, we could steer the pallet to exactly where it is needed,

maybe within a couple of meters. This hybrid concept would basically give a form of precision-guided cargo (PGC).

Sensor Volume

Target Reporter. The concept involves fielding a UAV with a 72-hour endurance, 4,000-pound payload, and a normal operating altitude of 65,000 feet that could hold various sensors to cover a 200 x 400-nm area. Sensors include electromagnetic spectrum measures (ESM), moving target indicators (MTI), synthetic aperture radar (SAR), and receivers for UGSs. Data from the ESM, MTI, SAR, and UGS sensors would be fed into an auto target recognition (ATR) system that would classify each target and report the data. This system (a UAV with multispectral sensors) would meet the intelligence, surveillance, and reconnaissance needs of SAF.

Unmanned Ground Sensors. An acoustic UGS was used along the Ho Chi Minh trail during the Vietnam War. Modern UGSs could sense acoustic, seismic, chemical/biological, ESM, or magnetic emissions. Many of these systems placed over an area could be used to report activities. Data could be relayed to a UAV overhead (such as the target reporter concept) or, if a small and powerful enough energy source could be developed and installed in the UGS, the UGS might be able to report directly to a satellite.

Weather Surveillance and Prediction. Using a UAV with passive infrared, passive microwave, LIDAR, and Radar systems, enough information can be gathered to report the weather and to make reasonable predictions. This valuable information would be used in the initial deployment of SAF teams.

Low-Cost Space-Based Surveillance. The concept envisions multiple low-cost (\$25M in FY95 dollars) satellites. The low cost is due to the limited life, of these satellites—approximately six months. The systems could be tailored to the need of the customer and launched on demand. In the long run, it might cost much less to place as many as 10 of these satellites to get high coverage over an area (especially during the initial constabulary phase of a SAF operation) than it would cost to move (and use the limited life of) a \$500-\$700M satellite.

2025 Study

Pyrotechnic Electromagnetic Pulse (PEP)

Concept No. 200009 would use pyrotechnic explosions to produce electromagnetic pulse (EMP) radiation to affect enemy sensors and communication equipment. SAF could employ weapons with small versions of this explosive to reduce the ability of organizations to coordinate their actions.

Noise

Concept No. 900153 is a hand-held, directed, variable-pulse noise weapon that could be capable of a range of options from disorienting to incapacitating the enemy. A larger, directed-noise weapon could be used to attack larger targets ranging from mobile launching systems to military infrastructure. These weapons could easily be mounted on land vehicles or satellites.

Mission Pods

Concept No. 900203 is the development of mission pods that could be quickly loaded and unloaded from a transport aircraft. Once deployed at its location, a pod would provide all essentials (e.g., power, lighting, computer, and communication equipment). Medical, command and control, teaching, UAV control, and water treatment pods could be developed.

Inflatable Workspace

Concept No. 900255 is containerized, modular, and state-of-the-art buildings that could be deployed to provide workspace for SAF teams. For more transitory encampments, huge tents that inflate from relatively small packages could be used. Several tents could be tied together or, technology permitting, tents the size of shopping malls (from individual packages fitting in the cargo compartment of a heavy-lift vehicle) could be developed. An instantly inflatable tent would decrease setup time and alleviate on-site requirements for deployed SAF teams.

Force Sustainment

Concept No. 900433 is a pill, shot, or internally-planted nutrient that provides all the necessary nutrition for an individual in combat for up to seven days. It would be chemically controlled to provide required nutrients over the stated period. It would not eliminate the need for water. It would be most useful for personnel in transit or in sustained conflict prevention. The pill or shot would have minimal short-term effect on the digestive system. Compounds could be included that would reduce the urge to eat. This would be a “sensitive” way to sustain forces in famine areas.

Steerable Pallets

Concept No. 900485 is to airdrop loads with steerable chutes, controlled by a computerized navigation system, on any desired drop zone (DZ). Loads could find the DZ via differential GPS. Steerable loads could compensate for unknown winds and give unprecedented accuracy. This capability would allow needed supplies to be inserted to a specific area.

Remote Presence

Concept No. 900615 is to integrate satellite communications into helmets to provide two-way voice communications. A one-way color camera mounted on the helmet to provide rear-echelon personnel with full visual information is also possible. This concept ties into another SAF need for robust point-to-point communications. The system would be along the lines of an Iridium® system that would place more than dedicated satellites in low-earth orbit (LEO) to provide secure and reliable communications to any individual with the correct equipment and cryptologic material or device.

Air/Land Assault Craft

Concept No. 900658 envisions a hybrid of a ground vehicle and a helicopter. The vehicle would be capable of slow in-flight speeds using rotor systems or adjustable thrusters. When in the ground mode, the rotors or thruster would fold and the lightweight vehicles would move on a wheeled drive system.

Advanced Tactical Transport

Concept No. 900664 is a VTOL aircraft capable of carrying large payloads to nations that have limited airfields. SAF will need an extremely agile, large cargo transport for both intratheater and intertheater transport. A solution may be the tiltwing, super-short-takeoff and landing, advanced theater transport (Tiltwing SSTOL ATT). The Tiltwing SSTOL combines extreme short-field capability with autonomous cargo handling to enable deliveries to unprepared landing areas on short notice. The propulsion system may use turboprop or jet engines. Minimum flight speed would be approximately 50 knots, with a field length requirement in excess of 750 feet at high-altitude, hot temperature conditions.

Camouflage

Concept No. 900699 would use tiny sensors and electronic devices capable of changing across multiple spectrums to develop camouflage paint or uniforms that blend with the differing terrain. This concept has value for a SAF trying to monitor an area.

Long-Duration UAVs

Concept No. 900701 is the development of long-duration UAVs that use solar-powered engines to enhance on-station time. Use of these lighter-than-air vehicles would reduce weight and the power require to move the vehicle around. Lighter-than-air structure would also make the vehicle easier to deploy via heavy-lift aircraft.

Anti-Sniper Planning

Concept No. 900705 is a computer-based planning tool that uses a three-dimensional layout of urban areas to predict the most likely location of snipers based upon available fields of fire. The system would aid SAF in determining where surveillance needs to be established and which areas should be secured first.

Multipurpose Unmanned Aerial Vehicle

Concept No. 900711 is the development of UAVs with removable line-replaceable units that would permit a quick change of the UAVs payload. Cameras could be replaced with nonlethal or lethal weapons as the situation required.

Chameleon

Concept No. 900746 would use optical lenses to generate any color at any angle to make an object look like the environment in which it is operating. Complemented by stealth, chameleon could help aircraft counter radar and optical tracking systems.

Improved Body Armor

Concept No. 900753 is improvements in materials technology that could provide a lightweight material for ballistic protection. This material could be molded to fit over the uniforms of SAF members to provide protection not only for the wearer's torso but also for limbs and feet against mines.

Unmanned Mini-Helicopters

Concept No. 900763 calls for development of small, remote-controlled helicopters with sensors that could provide reconnaissance of urban areas or, if the vehicle is small enough, of building interiors. The system would require a precise navigation subsystem to permit it to enter confined areas and conduct its mission.

Personal Identification Friend or Foe

Concept No. 900906 is a human identification friend or foe (IFF) system to track and identify individuals. UAVs and unmanned reconnaissance systems, equipped with sensors, could provide real time continuous monitoring of SAF personnel in the area.

Bibliography

- AFM 1-1. *Basic Aerospace Doctrine of the United States Air Force*. 2 vols., March 1992.
- Alexander, Col John B., Ph.D.. Interview and correspondence with authors, 2–7 April 1996.
- . “Nonlethal and Other Emerging Technologies.” Lecture, Air Command and Staff College, Maxwell AFB, Ala., 2 April 1996. Used by permission.
- . “Non-Lethal Weapons Demand Expands as Missions Change.” *National DEFENSE* 80, no. 516 (March 1996): 34–35.
- . “Nonlethal Weapons: The Requirements.” Unpublished paper, accepted by *Jane’s* for publication in upcoming *International Defense Review*, April 1996. Used by permission.
- Allard, Kenneth. *Somalia Operations: Lessons Learned*. Institute for National Strategic Studies. Washington, D.C.: National Defense University Press, 1995.
- Allotey, Sqn Ldr Sam, et al. “Planning and Execution of Conflict Termination.” A Research Paper presented to the Directorate of Research, Air Command and Staff College, Maxwell AFB, Ala., May 1995.
- Arms, Lt Col Anita M. “Strategic Culture: The American Mind.” *Air Command and Staff College Theater Air Campaign Studies Coursebook*. Maxwell AFB, Ala.: Air University, 1996.
- Barringer, Richard B. *Patterns of Conflict*. Cambridge, Mass: MIT Press, 1972.
- Barry, John. “Soon, ‘Phasers On Stun.’” *Newsweek* 23, no. 6 (7 February 1994): 24–26.
- Belton, Beth. “Brown Crash Raises Questions on Trade Missions.” *USA Today*, 5 April 1996.
- Blaufarb, Douglas S. *The Counterinsurgency Era: US Doctrine and Performance, 1950-Present*. New York: Free Press, 1977.
- Brand, Steward. “Army Green.” Originally published in *Whole Earth Review*, no. 76. Edited by Howard Rheingold, on-line, Internet, 14 May 1996, available from gopher://gopher.well.sf.ca.us:70/00/WER/Army_Green.
- Builder, Carl H. “Doctrinal Frontiers.” *Airpower Journal* 9, no. 4 (Winter 1995): 6–13.
- Builder, Carl H. and Theodore W. Karasik. “Organizing, Training, and Equipping the Air Force for Crises and Lesser Conflicts,” *RAND Project AIR FORCE*, 1995.
- Cable, Larry E., Ph.D. Associate Professor of History, University of North Carolina, Wilmington. *Conflict of Myths: The Development of American Counterinsurgency Doctrine and the Vietnam War*. New York: New York University Press, 1986.
- . “The Dangers of Dogma.” Lecture, Air Command and Staff College, Maxwell AFB, Ala., 28 March 1996. Used by permission.
- . “Getting Found in the Fog: The Nature of Interventionary Peace Operations.” Draft. (Compendium of Papers from USAF Special Operations School Symposium), unpublished as of 26 November 1995. Used by permission.
- . “The End State: Why Nations Stop Fighting.” Lecture, Air Command and Staff College, Maxwell AFB, Ala., 16 January 1996.
- . Interviews with authors, 31 January and 28 March 1996.

- Canby Steven L. "Roles, Missions, and JTFs: Unintended Consequences," *Joint Force Quarterly*, no. 6 (Autumn/Winter 1994-5): 68-75.
- The Columbia Dictionary of Quotations*. Microsoft ® Bookshelf. New York: Columbia University Press, 1993.
- Conference Report: "Professional Military Education and the Emerging Revolution in Military Affairs." Washington, D.C.: National Defense University, May 22-23 1995.
- Dean, Lt Col David J. *Airpower in Small Wars, The British Air Control Experience*. CADRE Paper no. AU-ARI-CP-85-1, Airpower Research Institute. Maxwell AFB, Ala.: Air University Press, April 1985. Originally published in *Air University Review*, July-August 1983 edition.
- Dilulio, John J., Jr. "Moral Poverty." *Chicago Tribune*, 15 December 1995.
- Donaldson, Maj Howard L. "Constitutional Torts and Military Effectiveness: A Proposed Alternative to the Feres Doctrine." Report Number 83-0565, Submitted to the faculty in partial fulfillment of requirements for graduation, Air Command and Staff College, February 1983.
- Donovan, David. *Once a Warrior King: Memories of an Officer in Vietnam*. New York: McGraw-Hill, 1985.
- Downing, General Wayne A. "Joint Special Operations in Peace and War." *Joint Force Quarterly*, no. 8 (Summer 1995): 22-27.
- Engelbrecht, Col Joseph A. Comments to draft white paper, March 1996.
- Extended Unit Manpower Document, 6th Special Operations Squadron (Foreign Internal Defense), Headquarters Air Force Special Operations Command, 6 March 1996.
- Feres Doctrine. *Feres v. United States*, 340 US Code sec. 135 (1950).
- "Financial Institutions to Invest Only in Bosnia Reconstruction," *Onasa News Wire*, 1 November 1995, online, Internet, available from <http://www.axime.com/wm/sarajevo/onasa/9511011002.html>.
- FM 41-10. *Civil Affairs Operations*. 11 January 1993.
- Fuller, Buckminster. "Thinking Out Loud," *An "American Masters" Special*. Public Broadcasting Station, Montgomery, Ala.: 10 April 1996.
- Fukuyama, Francis. *The End of History and the Last Man*. New York: Free Press, 1992.
- Gourley, Scott R. "The Sniper's Latest Nightmare: Lawrence Livermore Laboratory's LifeGuard System." *International Defense Review* 28, no. 4 (April 1995): 66.
- Gray, Colin S. "The Changing Nature of Warfare?" *Naval War College Review* 69:2 (Spring 1996): 7-22.
- Hammer, Michael and James Champy. *Reengineering the Corporation*. New York: Harper Business, 1993.
- Hellman, Lawrence C., Ph.D.. "Humanitarian Operations." Lecture, Air Command and Staff College, Maxwell AFB, Ala., 19 January 1996.
- Homer-Dixon, Thomas "Tad." "Environmental Change & Violent Conflict." *Scientific American* 268, no. 2 (February 1993): 38-45.
- . "War and Peace." *Maclean's*, 9 January 1995: 19-21.
- Huntington, Samuel P. "The Clash of Civilizations." *Foreign Affairs* 72, no. 3 (Summer 1993): 22-49.
- . "New Contingencies, Old Roles." *Joint Force Quarterly*, no. 8 (Autumn 1993): 38-43.
- Ikle, Fred Charles. *Every War Must End*. Revised Edition. New York: Columbia University Press, 1991.
- Ingersoll, Brig Gen Howard J. "Foot." Received research briefing at Headquarters, Air Force Special Operations Command, Hurlburt Field, Fla. 6 March 1996.
- . Telephone interview. 12 April 1996.

- James, Maj Glenn. "Chaos & Campaign Planning." Lecture, Air Command and Staff College, Maxwell AFB, Ala., 8 March 1996.
- Joint Warfighting Center. "Joint Task Force Commander's Handbook for Peace Operations." *Air Command and Staff College War Termination Coursebook*. Maxwell AFB, Ala.: Air University Press (January 1996): 64-81.
- JP 3-0. *Doctrine for Joint Operations*. 1 February 1995.
- Kaplan, Robert D. "The Coming Anarchy." *The Atlantic Monthly* 273, no. 2 (February 1994): 44-76.
- Kelley, Lt Gen Jay W. "Brilliant Warrior." **2025** white paper (Draft).
- Kelly, Kevin. "Shock Wave (Anti-) Warrior." *Wired*. February 1995. On-line, Internet, 14 May 1996, available from: <http://www.hotwired.com/wired/1.5/features/toffler.html>.
- Kosko, Bart, Ph.D.. *Fuzzy Thinking, The New Science Of Fuzzy Logic*. New York: Hyperion, 1993.
- Lake, Anthony. "Defining Missions, Setting Deadlines." *Defense News* 11, no. 14. On-line, Internet, 14 May 1996, available from <http://www.dtic.mil/defenseink/pubs/di96/dill14.html>.
- Larson, Eric V. "Casualties and Consensus, Domestic Support for US Military Operations," Santa Monica, Calif.: Rand[®], 1996.
- Libicki, Dr. Martin C. "Battlespace Dominance, The Meta-System: Capabilities and Issues" Lecture, Air Command and Staff College, Maxwell AFB, Ala., 25 March 1996.
- . "Project 2025, Institute for National Strategic Studies." Washington, D.C.: National Defense University Press, 1992.
- Liddell Hart, B. H. *Strategy*. (1954; new imprint) New York: Meridian, 1991.
- Lorenz, Col F. M. "Forging Rules of Engagement: Lessons Learned in Operation United Shield." On-line, Internet, 10 March 1996, available from <http://www-cgsc.army.mil/cgsc/milrev/95novdec/lor.htm>.
- Lucasfilms, Limited. *The Empire Strikes Back*. 20th Century Fox Video, © 1980.
- Ludwig, Dr. Armin, Ph.D.. "Ecosystemic Violence" **2025** lecture, Air War College, Maxwell AFB, Ala., 6 September 1995.
- Manchester, William. *American Caesar*. New York: Dell Publishing, 1978.
- Manning, Anita. "Monkey Ebola Cases Have Common Source." *USA Today*, 17 April 1996.
- . "Viruses Mutate Among Underfed." *USA Today*, 17 April 1996.
- McKenzie, Maj Kenneth E., Jr., USMC, "An Ecstasy of Fumbling: Doctrine and Innovation," *Joint Force Quarterly*, no. 10, Winter 1995-96, 67-8.
- Meilinger, Col Phillip S. "10 Propositions Regarding Air Power." *School of Advanced Airpower Studies*. Air Force History and Museums Program, February 1995.
- Montague, Bill and Christine Dugas. "Peacemakers Slow to Invest in Bosnia." *Pensacola News Journal*, 7 April 1996, 3D. Also entitled "Balkan Region Holds Reward, Heavy Risks." *USA Today*, 5 April 1996.
- Morris, Janet and Chris Morris. "Nonlethal Weapons: Creating New Capabilities for Conflict Management." ©1995. Unpublished paper dated 26 February 1996 in a fax to authors. Used by permission.
- . Numerous telephone interviews with authors, February-March 1996.
- Morris, Janet, Chris Morris, and Thomas B. Baines. "Weapons of Mass Protection: Nonlethality, Information Warfare, and Airpower in the Age of Chaos." *Airpower Journal*, no. 1 (Spring 1995): 15-29. On-line, Internet, 14 May 1996, available from <http://www.cdsar.af.mil/apj/morris.html>.

- A National Security Strategy Of Engagement And Enlargement*. Washington, D.C.: Government Printing Office, February 1996.
- Nollinger, Mark. "Surrender or We'll Slime You." *Wired*, no. 3.02, February 1995 90-100. On-line, Internet, 14 May 1996, available from: <http://www.hotwired.com/wired/3.02/departments/electrosphere/nonlethal.html>.
- O'Connell, Maj Ed. Interview with authors, 25 March 1996.
- . "Nonlethal Concepts: Implications for Air Force Intelligence." first draft, November 1993. Subsequently published in *Airpower Journal* 7, no. 4 (Winter 1994): 26-33.
- Perry, William. "Using Military Force When Deterrence Fails." *Defense Issues* 10, no. 80, 6 August 1995. On-line, Internet, available from <http://www.dtic.mil/defenselink/pubs/di95/di1080.html>.
- . "Managing Danger: Prevent, Deter, Defeat" *Defense Issues* 11, no. 13, 4 March 1996. On-line, Internet, 14 May 1996, available from <http://www.dtic.mil/defenselink/pubs/di96/di1113.html>.
- . Remarks delivered to the John F. Kennedy School of Government, Harvard University. On-line, Internet, 13 May 1996, available from <http://www.dtic.mil/defenselink>.
- Peters, Thomas J. and Robert H. Waterman, Jr. *In Search of Excellence*. New York: Warner Books, 1982.
- Pitts, W. Darrent. "A Guantanamo Diary—Operation Sea Signal." *Joint Force Quarterly*, no. 9 (Autumn 1995): 114–120.
- Pomeroy, MSgt Gary. "Perry Lauds Airmen, Airpower." *Air Force News Service*. On-line, internet, 14 May 1996, available from http://www.dtic.mil/airforcelink/pa/Jan96/an010296_02jan96_960003.html.
- Rast, Capt Vicki J. and Maj Bruce R. Sturk. "Coalitions: The Challenge of Effective Command and Control in Support of the Air Campaign." *Air Command and Staff College Theater Air Campaign Studies Coursebook*, 1996.
- "ROA National Security Report." *The Officer*, April 1996.
- Rodriguez, Lt Col Federico J., Ph.D. Telephone interviews with authors, 12–28 March 1996.
- Seabury, Paul and Angelo Codevilla. *War Ends & Means*. New York: Basic Books, Inc., 1989.
- Schultz, Richard H., Jr. *In the Aftermath of War*. Maxwell AFB, Ala: Air University Press, 1993.
- Schwartz, Peter. *The Art of the Long View*. New York: Currency Doubleday, 1991.
- Schwarz, Benjamin. "The Diversity Myth: America's Leading Export," *The Atlantic Monthly* 275, no. 5 (May 1995): 57–67.
- Shalikhvili, General John M. "Force & Diplomacy in the 21st Century." *Institute for Study of Diplomacy Report* 1, no. 1, November 1994. On-line, internet, 13 May 1996, available from <http://www.georgetown.edu/sfs/programs/isd/files/shali.htm>.
- Sieden, Lloyd Steven. "The Birth of the Geodesic Dome: How Bucky Did It." *The Futurist* 23, no. 6 (November 1989): 14–19.
- Snow, Donald M. and Dennis M. Drew. *From Lexington to Desert Storm: War and Politics in the American Experience*. New York: M. E. Sharpe, Inc., 1994.
- Story, Lt Col Ann E. and Major Aryea Gottlieb. "Beyond the Range of Military Operations," *Joint Force Quarterly*, no. 9 (Autumn 1995): 99.
- Strategic Assessment 1996, Instruments of US Power*. Institute for National Strategic Studies, (Washington, D.C.: National Defense University Press, 1996).
- Szafanski, Col Richard. "A Theory of Information Warfare: Preparing for 2020." *Airpower Journal*, no. 1 (Spring 1995): 56–65, 18 September 1995. On-line, internet, 15 May 1996, available from <http://www.cdsar.af.mil/apj/szfran.html>.

- . “Twelve Propositions Regarding Airpower.” *Airpower Journal* 10, no. 1 (Spring 1996): 51–80.
- Szafranski, Col Richard and Dr. Martin Libicki. “. . . Or Go Down in Flame: An Airpower Manifesto for the 21st Century.” Unpublished **2025** white paper. Used by permission.
- Szafranski, Col Richard. “A SIOP for *Perestroika*?” Air War College Research Report, Air University, Maxwell AFB, Ala.: 1990.
- Toffler, Alvin and Heidi. *War and Anti-War*. (1993; imprint, New York: Warner Books Edition) May 1995.
- USAF Scientific Advisory Board. *New World Vistas: Air and Space Power for the 21st Century*, Summary Volume. Washington, D.C.: USAF Scientific Advisory Board, 15 December 1995.
- . *New World Vistas: Air and Space Power for the 21st Century*. Unpublished draft, the Aircraft and Propulsion Volume. 15 December 1995.
- . *New World Vistas: Air and Space Power for the 21st Century*. Unpublished draft, the Attack Volume. 15 December 1995.
- . *New World Vistas: Air and Space Power for the 21st Century*. Unpublished draft, the Directed Energy Volume. 15 December 1995.
- . *New World Vistas: Air and Space Power for the 21st Century*. Unpublished draft, the Mobility Volume. 15 December 1995.
- . *New World Vistas: Air and Space Power for the 21st Century*. Unpublished draft, the Sensors Volume. 15 December 1995.
- United States Special Operations Forces Posture Statement 1994*. Honorable H. Allen Holmes, Assistant Secretary of Defense, Special Operations & Low-Intensity Conflict, and General Wayne A. Downing, USA, Commander in Chief, US Special Operations Command.
- Van Creveld, Martin. *The Transformation of War*. New York: Free Press, 1991.
- . “Transformation of War” **2025** lecture, Air War College, Maxwell AFB, Ala., 20 September 1995.
- Warden, Col John, *Air Campaign: Planning for Combat*. Washington, D. C.: National Defense University Press, 1988.
- Widnall, Sheila. “AF Evolving Through Contacts With Other Nations.” On-line Internet, 14 May 1996, available from <http://www.dtic.mil/defenseink>.
- Wilson, George C. “A Lesson in Peacekeeping” *Air Force Times*, no. 32 (11 March 1996).
- Wood, Col Anthony, USMC. “Sea Dragon: Warfighting in the Future.” Lecture, Air War College, Maxwell AFB, Ala.: 17 May 1996.
- World Health Organization. “Report on the Tuberculosis Epidemic, 1995.” On-line, internet, 15 May 1996, available from <http://www.who.ch/programmes/gtb/TBREPORT.HTM>.
- “World View: The 1996 Strategic Assessment From the Strategic Studies Institute,” edited by Earl H. Tilford, Jr., US Army War College, Carlisle Barracks, PA: 1996.
- 1995 World Refugee Survey*. Washington D.C.: US Committee For Refugees, Immigration and Refugee Services of America.
- Zinni, Lt Gen Anthony C. Commanding General, I Marine Expeditionary Force, Camp Pendleton, Calif, interview with authors, 29 November 1995.
- . “Commanding in ‘Frontier Missions’” **2025** lecture, Air War College, Maxwell AFB, Ala., 29 November 1995.

2025 Concept Papers

- 2025 Concept, no. 200009. "Pyrotechnic Electromagnetic Pulse." 2025 Concepts Database (Maxwell AFB, Ala.: Air War College/2025, 1996).
- 2025 Concept, no. 900153. "Noise Weapons." 2025 Concepts Database (Maxwell AFB, Ala.: Air War College/2025, 1996).
- 2025 Concept, no. 900203. "Heavy Lift Aircraft with Mission Pod." 2025 Concepts Database (Maxwell AFB, Ala.: Air War College/2025, 1996).
- 2025 Concept, no. 900255. "Inflatable Cities." 2025 Concepts Database (Maxwell AFB, Ala.: Air War College/2025, 1996).
- 2025 Concept, no. 900433. "Weekly Food Pill/Shot." 2025 Concepts Database (Maxwell AFB, Ala.: Air War College/2025, 1996).
- 2025 Concept, no. 900485. "Guided Airdrop Package." 2025 Concepts Database (Maxwell AFB, Ala.: Air War College/2025, 1996).
- 2025 Concept, no. 900615. "Virtual Doctor." 2025 Concepts Database (Maxwell AFB, Ala.: Air War College/2025, 1996).
- 2025 Concept, no. 900658. "Urban Assault Helo Vehicle Hybrid." 2025 Concepts Database (Maxwell AFB, Ala.: Air War College/2025, 1996).
- 2025 Concept, no. 900664. "Tiltwing Super Short T/O and Landing." 2025 Concepts Database (Maxwell AFB, Ala.: Air War College/2025, 1996).
- 2025 Concept, no. 900699. "Chameleon Camouflage." 2025 Concepts Database (Maxwell AFB, Ala.: Air War College/2025, 1996).
- 2025 Concept, no. 900701. "Long Duration UAVs (solar powered, long loiter)." 2025 Concepts Database (Maxwell AFB, Ala.: Air War College/2025, 1996).
- 2025 Concept, no. 900705. "Anti-Sniper Probability Device." 2025 Concepts Database (Maxwell AFB, Ala.: Air War College/2025, 1996).
- 2025 Concept, no. 900711. "Multipurpose UAV." 2025 Concepts Database (Maxwell AFB, Ala.: Air War College/2025, 1996).
- 2025 Concept, no. 900746. "Chameleon." 2025 Concepts Database (Maxwell AFB, Ala.: Air War College/2025, 1996).
- 2025 Concept, no. 900753. "Full Body Armor." 2025 Concepts Database (Maxwell AFB, Ala.: Air War College/2025, 1996).
- 2025 Concept, no. 900763. "Unmanned Mini Helos." 2025 Concepts Database (Maxwell AFB, Ala.: Air War College/2025, 1996).
- 2025 Concept, no. 900906. "Personal Identification Friend or Foe (PIFF)." 2025 Concepts Database (Maxwell AFB, Ala.: Air War College/2025, 1996).

Information Operations: A New War-Fighting Capability



A Research Paper
Presented To

Air Force *2025*

by

LTC William B. Osborne (USA)
Maj Scott A. Bethel
Maj Nolen R. Chew
Maj Philip M. Nostrand
Maj YuLin G. Whitehead

August 1996

Disclaimer

2025 is a study designed to comply with a directive from the chief of staff of the Air Force to examine the concepts, capabilities, and technologies the United States will require to remain the dominant air and space force in the future. Presented on 17 June 1996, this report was produced in the Department of Defense school environment of academic freedom and in the interest of advancing concepts related to national defense. The views expressed in this report are those of the authors and do not reflect the official policy or position of the United States Air Force, Department of Defense, or the United States government.

This report contains fictional representations of future situations/scenarios. Any similarities to real people or events, other than those specifically cited, are unintentional and are for purposes of illustration only.

This publication has been reviewed by security and policy review authorities, is unclassified, and is cleared for public release.

Contents

<i>Chapter</i>		<i>Page</i>
	Disclaimer	ii
	Illustrations.....	iv
	Tables.....	v
	Preface.....	vii
	Executive Summary	viii
1	Introduction	1
	The Challenges	1
	Assumptions.....	3
	The Rest of the Story.....	4
2	Required Capability	6
	Information Dominance.....	6
	Speed and Accuracy of OODA Loops	6
	Dross Versus Gold.....	7
	OODA Loop “Integration”	7
	“Momentum Control”	8
	OODA Loop Tasks and Attributes	8
3	Technology Investigation	11
	Collection Platforms	13
	Miniature Satellites.....	13
	Uninhabited Reconnaissance Aerospace Vehicles.....	14
	Communication Infrastructure	15
	Security	16
	Communications Wrap-Up.....	17
	Computer Power	18
	Intelligent Software.....	19
	Image Understanding	20
	Intelligent Integration of Information.....	20
	Planning and Decision Aids.....	21
	Human Computer Interaction.....	21
	Human Systems and Biotechnology.....	22
	Charting the Brain	22
	Visualization and Mental Imaging.....	25
	Bringing It Altogether--The Nexus.....	26
4	System Description	32
	Cyber Situation Components.....	33
	All-Source Information Collectors.....	34

<i>Chapter</i>	<i>Page</i>
Archival Databases.....	34
IIC	34
Implanted Microscopic Chip.....	35
Lethal and Nonlethal Weapons.....	36
Putting It Together.....	36
Measures of Merit.....	37
Observe Tasks	38
Orient Tasks.....	39
Decide Tasks	40
Act Tasks	41
5 Vulnerabilities and Countermeasures.....	43
Vulnerabilities	43
Countermeasures.....	44
Distributed System Architecture	44
The “Small and the Many”	45
“Smart” System.....	46
Optical Computing	46
Low Earth Orbit.....	47
Internal Deactivation.....	47
External Deactivation.....	47
“Zap” Attack	47
“Mutual Dependence”	48
Summary	48
6 Concept of Operations	50
Future Conops.....	50
Applications of the Cyber Situation.....	51
Command Structure.....	52
Principles of War.....	53
A Future World.....	53
7 Investigation Recommendations.....	55
8 Conclusion	57
<i>Appendix</i>	<i>Page</i>
A List of Acronyms and Abbreviations.....	60
Bibliography.....	62

Illustrations

<i>Figure</i>	<i>Page</i>
1-1. OODA Loop	2
3-1. Battlespace Vision Key Components	12
3-2. Human Information Processing Flow	24
3-3. Development Lines for System Elements	27
4-1. Cyber Situation Vision: “Eye” See Everything	32
4-2. Cyber Situation Components	33
4-3. Cyber Situation Connectivity	37
5-1. Information Integration Center Interconnectivity	45

Tables

<i>Table</i>	<i>Page</i>
1 Observe Tasks and Attributes	9
2 Orient Tasks and Attributes	9
3 Decide Tasks and Attributes	9
4 Act Tasks and Attributes	9
5 Technology Areas Versus Cyber Situation Components	34
6 See the Battlespace	38
7 Maintain Mobile Battlespace View	38
8 Universal Access to Battlespace View	39

<i>Table</i>		<i>Page</i>
9	Tailor View of the Battlespace.....	39
10	Comprehend the Battlespace View.....	40
11	Decide What is Important and What May Require Action.....	40
12	Determine Action Required to Rectify Undesirable Situation.....	40
13	Immediate Access to Assets to Rectify Undesirable Situation.....	41
14	Feedback on Actions and Inactions Taken.....	41
15	Countermeasures Versus Threats.....	48

Preface

You see things; and say “Why?” But I dream of things that never were; and I say; “Why not?”

—George Bernard Shaw
Back to Methuselah, part 1, act 1

This project envisions war-fighting capabilities that will enable military members to prosecute operations effectively in support of vital national strategic interests determined by US political leaders. Our efforts stem from a genuine concern to improve the tools to assist commanders in an age of exponential growth in available information. But, this vision goes beyond just giving commanders useful information; it aims to empower them with the ability to leverage information to conduct warfare.

We undertook this effort knowing that some readers would find it a challenge to project their thoughts out into the next millennium to 2025. Nevertheless, we encourage our readers to “double leap” into 2025 and share our excitement in the concept’s potential to keep the US military as the best military in the world.

We appreciate Air University’s pushing us beyond the safe envelope of thinking and planning the future. Without exception, we received impressive assistance from advisors, instructors, guest speakers, and peers. Finally, our spouses supported and encouraged us when we needed it most—when naysayers doubted our “out-of-box” visions.

Never again will we say “that can’t be done.” Others may see the impossible, but we will determine “how?”

Executive Summary

The affirming characteristic of Alexander the Great's genius as a general and leader was "the startling rapidity with which he always acted. . . . Time was his constant ally; he capitalized every moment, never pondered on it, and thereby achieved his end before others had settled on their means."

—J.F.C. Fuller

The Generalship of Alexander the Great

In its most basic form, commanders have always performed the functions of observe, orient, decide, and act (OODA Loop) to prosecute military operations.¹ As with Alexander the Great, history shows the military commander who best analyzes, decides, and controls the speed of the engagement prevails in nearly every conflict. To master the OODA Loop, military leaders have pushed technology to obtain more information.² Ironically, this situation now leads to the requirement to solve two fundamental challenges if the United States expects to maintain air and space dominance in 2025. First, the proliferation of unintegrated military war-fighting architectures gives the commander potentially conflicting perspectives of the battlespace.³ Second, the explosion of available information creates an environment of mental overload leading to flawed decision making. Failure to master these challenges critically weakens the military instrument of power. This paper presents a solution to these challenges by confronting commanders as they employ future airpower forces.

Regarding the first challenge, the large number of specialized war-fighting architectures makes information integration supporting overall coordination and control more important and more difficult. Simultaneously, the speed and the range of modern weapons drastically reduces the time commanders have to integrate conflicting information and decide on a course of action.

The second challenge is to harness the information explosion to combat mental overload, thus improving decision making. Recent exercises reveal an alarming number of unread messages because of information overload.⁴ As the quantity of data rises, the difficulty of preparing and interpreting it for decision making grows. Traditionally, the military attempted to solve this problem by increasing the number of

communications nodes. These past solutions only injected additional inputs and information without improving decision-making capability.

The optimum solution must integrate the functions within the OODA Loop and allow the commander to control the momentum of the cycle. This paper describes how a system, called the Cyber Situation, can do just that, thus optimizing commanders' ability to operate air and space systems. The Cyber Situation enables commanders and decision makers to have in-time access to the battlespace, characterize the nature of the engagement, determine the calculated probabilities of success from the various authorized lethal or nonlethal options, decide what to do, employ the weapons chosen, and receive in-time feedback on the result of the engagement.

The Cyber Situation system includes five major components. First, all-source information collectors will transmit raw data to the Information Integration Center (IIC), as discussed below. Second, archival databases, linked to the IIC, will be used for historical analyses to fill information gaps if the data is not available for collection. Third, the IIC, an integrated and interconnected constellation of "smart" satellites will analyze, correlate, fuse, and deconflict all relayed data. Fourth, implanted microscopic chips link users to the IIC and create computer-generated mental visualizations.⁵ The visualization encompasses the individual and allows the user to place himself into the selected battlespace. Fifth, lethal and nonlethal weapons will be linked to the IIC, allowing authorized users to employ them from the Cyber Situation.

Implied in the Cyber Situation are five key technologies evolving on separate paths that will synergize by 2025 to achieve this goal. They include collection platforms, communications infrastructure, computing power, intelligent software, and human systems and biotechnology. Most of these technologies will evolve through the commercial community, but the military must focus research and development efforts on biological and computational intelligent software and biotechnology breakthroughs to allow mental visualization.

Once realized, these new capabilities will give commanders a new way to prosecute warfare. New technology alone does not revolutionize warfare. Rather, technology's impact on systems evolution, operational tactics, and organizational structure is its true advantage.⁶ This fuels necessary and complementary changes in doctrine and organizational structure.

Organizations and doctrine will need to adapt to a streamlined, decentralized environment. The traditional emphasis on command and control will give way to an emphasis on consultation and control. This organizational structure permits the Cyber Situation to operate at maximum efficiency. It also allows commander's at all levels to operate with a greater degree of latitude and autonomy as part of an integrated joint operation—a truly combined arms.

Airpower in 2025 must make optimum use of information technology to operate inside an opponent's decision cycle. This requires unequivocal dominance of cyberspace. In addition to enabling all military pursuits, information-related activities will transcend all air and space operations.

To be sure, the Cyber Situation proposed in this paper certainly will not eliminate all the command problems facing airpower forces in 2025. However, it may well shed light on the main factors involved and indicate the direction any reform efforts should move. The challenge now is for airpower strategists to develop the war-fighting doctrine to turn the vision of a true battlespace execution capability into reality.

Notes

¹ Maj David S. Fadok, *John Boyd and John Warden: Air Power's Quest for Strategic Paralysis* (Maxwell AFB, Ala.: Air University Press, February 1995), 16.

² Examples of technology push to obtain more information range from observation balloons to surveillance and reconnaissance aircraft and satellites.

³ "War-fighting architectures" encompass the entire spectrum of systems (information collection, processing, dissemination; command and control; and offensive and defensive weapons systems) to support military operations.

⁴ A senior US Department of Defense policymaker lecture given to the 1996 Air Command and Staff College under the promise of nonattribution. The individual stated that during a 1995 Joint Task Force exercise, three thousand of the thirty thousand messages used in the exercise were never opened nor viewed by anyone because of information overload.

⁵ 2025 Concept, No. 900702, "Implanted Tactical Information Display," 2025 Concepts Database (Maxwell AFB, Ala.: Air War College/2025, 1996).

⁶ Andrew F. Krepinevich, Jr., *War Theory*, vol. 3, *The Military-Technical Revolution: A Preliminary Assessment* (Maxwell AFB, Ala.: Air University Press, September 1995), 163-64.

Chapter 1

Introduction

Victory smiles upon those who anticipate the changes in the character of war, not upon those who wait to adapt themselves after the changes occur.

—Giulio Douhet
The Command of the Air

Victory smiles upon those who change the character of war to their advantage, not upon those who merely anticipate the change or wait to adapt themselves after the changes occurs.

—Joseph A. Engelbrecht, Jr.
AIR FORCE 2025 Research Director

The Challenges

History clearly shows the military commander who best analyzes, decides, and controls the speed of the engagement prevails in nearly every conflict. In the simplest form of conflict, commanders have traditionally performed the functions of observe, orient, decide, and act (OODA Loop) to prosecute military operations (fig. 1-1).¹ To master the OODA Loop, military leaders have pushed technology to obtain more information. This push attempts to achieve the core capability of information dominance that “is the ability to collect, control, exploit, and defend information while denying an adversary the ability to do the same.”² The need for information dominance is vital, because “the emergence of the information and technology age presents new challenges to US strategy even as it offers extraordinary chances to build a better future.”³ In today’s world, satellite surveillance and reconnaissance technology provide a unique view of those challenges from

the ultimate high ground. Extensive communications links and superior data-processing capabilities allow improved distribution of this information.

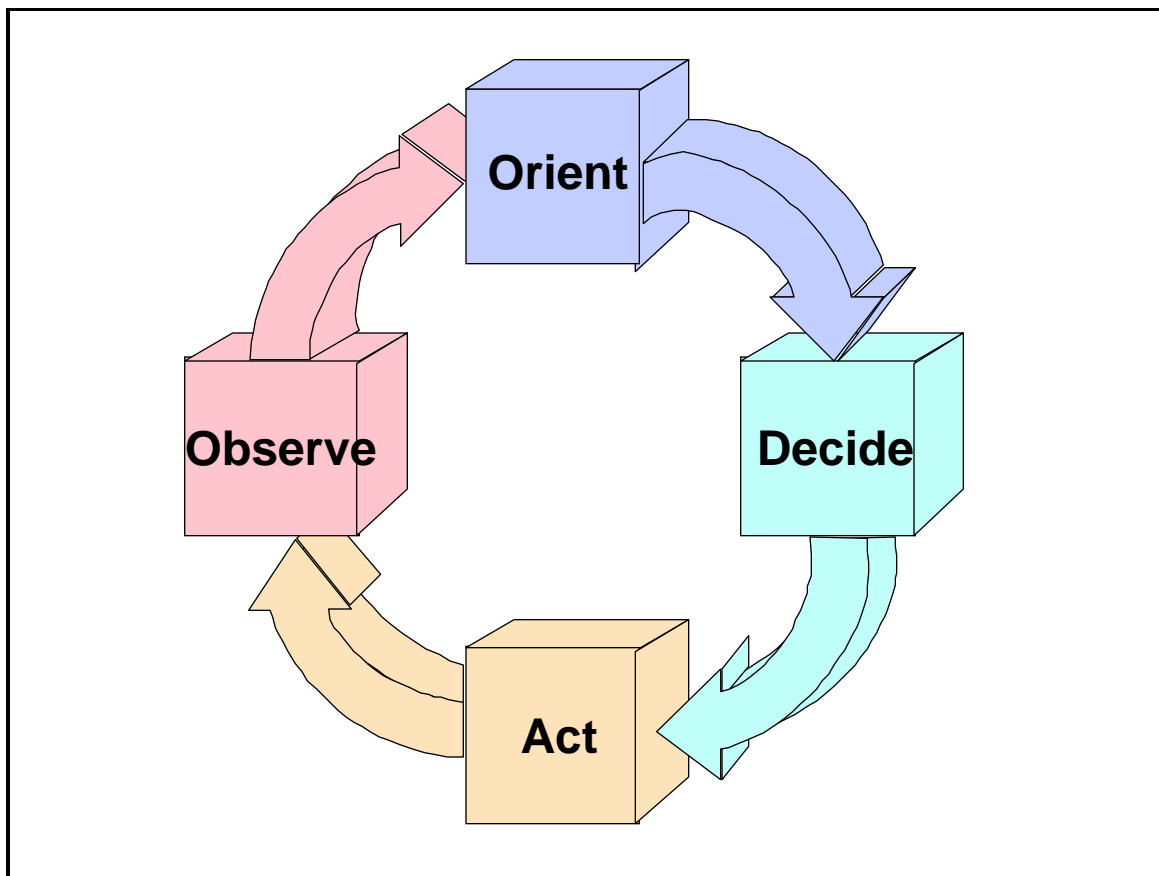

Source: Microsoft Clipart Gallery© 1995, courtesy of Microsoft Corporation.

Figure 1-1. OODA Loop

Ironically, this situation now leads to two fundamental challenges if the United States expects to continue its dominance of air and space in 2025. First, the proliferation of unintegrated military war-fighting architectures gives commanders potentially conflicting perspectives of the battlespace.⁴ Second, the explosion of available information creates an environment of mental overload leading to flawed decision making. Failure to master these challenges critically weakens the military instrument of power.

The two challenges have resulted in a scenario not unfamiliar to current military operations. Commanders *observe* after waiting for collection assets to assimilate data and analysts to process and interpret the information; *orient* based upon inputs and further interpretations from their staffs that may be conflicting or, worst yet, wrong; *decide* with generally incomplete, imperfect, and possibly biased

information; and *act* without first being able to forecast the probability of success of the action or having direct and immediate access to employment tools. Gaps and weaknesses in each step widen and exacerbate as each cycle begins anew.

In 2025 operating near the speed of light will be a common feature of military engagements. Future architectures envision a new array of ground- and space-based sensors, uninhabited combat aerial vehicles (UCAV), and missile defense technology which will take advantage of developing directed energy capabilities. If a kill mechanism operates at the same speed as the flow of information, a defender cannot possess the requisite time to observe the attack, orient himself, decide how to respond, and act on that decision. As a result, the attacker would get inside the defender's OODA Loop, destroying the ability to conduct an active defense.

This paper proposes a solution to these challenges confronting commanders employing future airpower. The optimum solution should integrate the functions within the OODA Loop and allow the commander to control the momentum of the cycle. Further, the solution should enable commanders and decision makers to have in-time access to the battlespace, characterize the nature of the engagement, determine the calculated probabilities of success from the various lethal or nonlethal options authorized, decide what to do, employ the weapons chosen, and receive in-time feedback on the result of the engagement.⁵ Simply stated, the solution should go beyond just giving commanders useful information; it should empower them with the ability to leverage information to conduct warfare.

Assumptions

For planning to achieve information dominance, the following assumptions are plausible for 2025:

1. Information is power. Hence, the high ground of the future will be information dominance.⁶
2. Expect continued explosion in the proliferation of information.⁷ The availability of information is overwhelming, and the driving issue that will contribute to success is being able to sift the "gold from the dross."⁸ Accordingly, collection assets, regardless of where they are based, will be sufficiently available in 2025.

3. The site, size, and scope of future conflicts are unknown. The United States military must be prepared to fight or to conduct mobility or special operations anywhere in the world on short notice.⁹

4. The military will have to fight at long distances from the United States. In particular, some operations may be staged directly from the continental United States. These operations may endure for weeks or months in weather conditions executed both during the day and night.¹⁰

5. Adversary capabilities steadily will improve and will be difficult to forecast.¹¹ The United States must assume we will fight smart enemies who have analyzed all aspects of our military doctrine, capabilities, and operations. Further, they will develop weapon systems to attack their perceived vulnerabilities of United States military forces.

6. Military personnel strength will continue to decrease, thus placing further importance on optimizing individual performance.¹²

7. Today's principles of war will still be applicable in 2025.¹³ They include the need to gain the offensive, achieve unity of command, maintain security, exploit surprise, use mass and maneuver while practicing simplicity, and employ economy of force.

The Rest of the Story

The remainder of this paper discusses the proposed solution and its implications. Chapter 2 explains the required capability by outlining the need for OODA Loop integration and momentum control. Chapters 3 and 4 take the reader through the technology evolution that synergizes in the solution called Cyber Situation. Chapter 5 discusses vulnerabilities and countermeasures. Chapter 6 outlines how the Cyber Situation functions and its implications on doctrine, tactics, organization, and force structures. Finally, chapter 7 recommends areas requiring additional research and chapter 8 offers a conclusion to this paper.

Overall, this paper focuses on the conceptual fusion of information operations. Other 2025 papers deal specifically with various aspects of information operations.¹⁴ Furthermore, other papers focus on technologies this paper assumes will be available in 2025, including space lift, uninhibited aerial vehicles (UAV), and other lethal weapons.¹⁵ This paper serves as the integrator of future information operations

technology—a concept that enables military commanders to observe the battlespace, analyze events, and direct forces from within a single entity.

Notes

¹ Maj David S. Fadok, *John Boyd and John Warden: Air Power's Quest for Strategic Paralysis* (Maxwell AFB, Ala.: Air University Press, February 1995), 16.

² Dr Sheila E. Widnall and Gen Ronald R. Fogelman, *Air Force Executive Guidance* (Washington, D. C.: December 1995), 2, 17. This document outlines five Air Force areas of core competency—air superiority, space superiority, global mobility, precision employment, and information dominance.

³ William J. Clinton, *A National Security Strategy of Engagement and Enlargement* (the White House, February 1996), 1.

⁴ “War-fighting architectures” encompass the entire spectrum of systems (information collection, processing, dissemination; command and control; and offensive and defensive weapons systems) to support military operations.

⁵ The use of “in-time” as opposed to real-time or near-real time puts the focus on both timeliness and requirement for information. In-time access means getting information to users *in time* to perform a mission or task.

⁶ Widnall and Fogelman, 16.

⁷ Martin C. Libicki, *The Mesh and the Net: Speculation on Armed Conflict in a Time of Free Silicon* (Washington, D. C.: National Defense University Press, 1994), 2-3.

⁸ Francis Fukuyama, RAND, Electronic Mail, subject: Dross and Gold, 27 December 1995. Used by permission of author. This electronic mail stresses the importance of “sorting the gold from the dross” because of “data deluge” and the problem of “facing too much wrong information, a phenomenon often exacerbated by new information systems.”

⁹ Air Force Scientific Advisory Board, *New World Vistas, Air and Space Power for the 21st Century* Volume, 15 December 1995, 5.

¹⁰ Ibid.

¹¹ Ibid.

¹² Ibid.

¹³ AFM 1-1, *Basic Aerospace Doctrine of the United States Air Force*, vol. 1, March 1992, 16.

¹⁴ Other 2025 Study research papers dealing with aspects of information operations include: Maj Cindy Norman, et al., “Man In the Chair” (Unpublished paper, Air University, Maxwell AFB, Ala., April 1996); Maj Mike Tiernan et al., “In-Time Information Integration System” (Unpublished paper, Air University, Maxwell AFB, Ala., April 1996); and Maj Barbara Jefts et al., “Virtual Integrated Planning and Execution Resources System: The High Ground of 2025” (Unpublished paper, Air University, Maxwell AFB, Ala., April 1996).

¹⁵ Other 2025 Study research papers dealing with spacelift, UAVs and lethal weapons include Lt Col Bruce Carmichael et al., “DEATHSTAR 2025” (Unpublished paper, Air University, Maxwell AFB, Ala., April 1996); Lt Col Henry Baird et al., “Spacelift” (Unpublished paper, Air University, Maxwell AFB, Ala., April 1996); and Maj Philip Simonsen et al., “On-Orbit Support” (Unpublished paper, Air University, Maxwell AFB, Ala., April 1996).

Chapter 2

Required Capability

Machines don't fight wars. Terrain doesn't fight ^{wars}. Humans fight wars. You must get into the mind of humans. That's where the battles are won.

—Col John Boyd

Information Dominance

As a new millennium approaches, information dominance should become a “blue print” for continued success as a superpower and contribute to peace particularly by adding new dimensions to deterrence.¹ Currently, information operations focuses too narrowly on the acquisition, transmission, and storage of information. Today's *Cornerstones of Information Warfare* defines military information functions (operations) as surveillance, reconnaissance, command and control, intelligence, communications, combat identification, precision navigation, and weather.² In 2025 the definition will likely include tools that allow military leaders to integrate seamlessly the functions of the OODA Loop and the ability to control momentum.

Speed and Accuracy of OODA Loops

Every individual operates a OODA Loop that is unique in speed and accuracy (fig. 1-1). Speed is based on the individual's mental capacity and capability to deal with information and changing environments. John Boyd asserts that one can paralyze an enemy by operating inside his OODA Loop, meaning that the individual is operating a faster cycle speed than the enemy's.³ Accuracy is determined during the orient part

of the cycle by what information is filtered and how it is organized. Boyd considers the orientation as the most important part of the cycle because “it shapes the way we interact with the environment—hence orientation shapes the way we observe, the way we decide, the way we act.”⁴

Dross Versus Gold

Increasingly, the OODA cycle time is affected by a growing deluge of information, with much of it insignificant or not applicable to the task at hand.⁵ The difficulty lies in filtering out exactly the nuggets of information that are useful. Unfortunately, during combat operations, most commanders possess limited time to perform specific tasks and issue orders. Further, as increased volumes of information are input into the OODA Loop or as the rate of input increases, natural defense mechanisms tend to try to protect people.⁶ A key mechanism is a “bounded rationality”⁷ that allows individuals to screen out inputs prior to being overloaded or inundated so they can continue to focus on a particular task. One danger lies in the commanders screening out “golden nuggets” because they are focused elsewhere. A second danger lies in failing to recognize when new data should dictate a refocus or reorientation.

OODA Loop “Integration”

Technology, however, can integrate functions within the OODA Loop and speed up the cycle. It does this by creating decision support tools to alleviate the precarious situation that exists when crucial nuggets of information are omitted from the individual’s OODA Loop. The tools, designed especially for commanders, would aid in managing military information to fit how commanders actually assess situations and issue orders.⁸ The decision support tools would assist commanders to deal with inputs from different, sometimes contradictory or incremental, sources. Unfortunately, the integration tools do not currently exist. This paper proposes the development of this capability in subsequent chapters.

“Momentum Control”

Thus far, we have assumed that technology will assist the commander by increasing the speed and improving the accuracy of his OODA Loop. However, it is also possible successful military operations will require a “loosening” of the loop.⁹ Specifically, technology should also allow the commander to “control momentum” of the OODA Loop. In other words, the commander must be able to control the cycle speed to allow the “modulation of both time and space” so the “impulse of strategic power is imparted at the proper moment to the objective at a critical position.”¹⁰ The final stage of employing or impulsing the strategic power must be “kept short so as to minimize the enemy’s ability to avoid the onslaught or effect countermeasures.”¹¹

“Momentum control” is an unorthodox concept because the information age compels users to believe that faster and shorter OODA Loop cycles are the goal. However, there may be opportunities where slowing the cycle benefits the commander’s operations and induces friction in the enemy’s cycle. Momentum control includes the ability to operate within the desired time cycles, both by controlling friendly movement and by affecting an enemy’s movement.¹² For example, a special operations soldier camouflaged to match the terrain will move relatively fast toward an enemy camp. Yet, once he is within viewing distance of the enemy, his movement slows to a minuscule rate to prevent enemy detection. The soldier has slowed his OODA Loop cycle by controlling momentum in both time and space. Another example is the strategic football coach whose team has a lead late in the fourth quarter and who employs the running game when his team is on offense. Like the soldier, the savvy coach wants to control the momentum of the battle, to slow the OODA Cycle by using time (the clock continues to tick between running plays) and space (achieving enough yards every three or four plays to get a first down) to defeat the opposition. The opposition, in turn, tries to regain momentum control by calling time outs to break the cycle of the team on the offense.

OODA Loop Tasks and Attributes

The following tables (tables 1 to 4) list tasks and attributes of each OODA Loop function to demonstrate what should be integrated to enable commanders to control momentum. The objective is to use

the tasks and attributes as measures for how effectively both individual functions and the integrated OODA Loop operates when 2025 technology is applied. Further, the tasks and how attributes serve as measures of merit to determine which technologies discussed in the next chapter meet the requirements to achieve OODA Loop integration. Ultimately, the evolving technologies that rate best seem most appropriate to pursue for system development.

Table 1

Observe Tasks and Attributes

Task	Attributes
See the battlespace	<ul style="list-style-type: none"> • Fused, integrated, deconflicted view of the desired battlespace • Sum of all possible information sources • System identification of information gaps and subsequent collection of missing information
Maintain mobile battlespace view	<ul style="list-style-type: none"> • Able to pull updated view anytime, anywhere • Easily deployable and transportable with user
Universal access to battlespace view	<ul style="list-style-type: none"> • Able to tailor picture for relevant AOR, missions, and tasks • Many able to see the same battlespace picture

Table 2

Orient Tasks and Attributes

Tasks	Attributes
Tailor view of the battlespace	<ul style="list-style-type: none"> • In-time view of the battlespace • Able to define dimensions and locations of battlespace
Comprehend the battlespace view	<ul style="list-style-type: none"> • Eliminate biased inputs from one person to another • Eliminate need for mental picture based on another's biases • Able to query for further information; receive in-time answers

Table 3

Decide Tasks and Attributes

Task	Attributes
Decide what is important and what may require action	<ul style="list-style-type: none"> • Decision support tool in transmitter and receiver to filter, sort, and prioritize • Prompts user of significant events for monitoring and action
Determine action required to rectify undesirable situation	<ul style="list-style-type: none"> • Model effectiveness of potential actions and inactions with in-time feedback • Optimize application of precision force • Ensure least risk to friendly forces

Table 4

Act Tasks and Attributes

Tasks	Attributes
Immediate access to assets to rectify undesirable situation	<ul style="list-style-type: none"> • Ready lethal capabilities for employment • Ready nonlethal capabilities for employment • One shot, one kill capability
Feedback on actions and inactions taken	<ul style="list-style-type: none"> • See in-time mission results • System recommends additional action or inaction

Notes

¹ The concept of a “blue print” has guided US Air Force modernization in the past. Gen Ronald Fogleman, chief of staff, US Air Force, stated in a lecture delivered to the 2025 project participants at Air University, Maxwell AFB, Alabama, 13 February 1996: “Force Modernization is the blue print for [today’s tenets of] Global Reach and Global Power. Our strategic vision remains containment through deterrence.” To actualize this vision, the Air Force reorganized into Air Mobility Command (Global Reach) and Air Combat Command (Global Power). Further, the 1990s witnessed the Air Force leadership promote the C-17 as the key short-term solution for Global Reach, and the F-22 for Global Power.

² Dr Sheila E. Widnall and Gen Ronald R. Fogelman, *Cornerstones of Information Warfare* (Washington, D. C.: 1995), 3.

³ Fadok, 2.

⁴ First Lieutenant Gary A. Vincent, *Operational Structures*, vol. 5, *In the Loop: Superiority in Command and Control* (Maxwell AFB, Ala.: Air University Press, November 1995), 291.

⁵ Fukuyama.

⁶ Jeffrey McKittrick et al., *The Revolution in Military Affairs*, Air War College Studies in National Security: Battlefield of the Future, no. 3 (Maxwell AFB, Ala.: Air University Press, September 1995), 65–97.

⁷ Herbert A. Simon, *Administrative Behavior: A Study of Decision-Making Processes in Administrative Organization* (New York: The Free Press, 1976), 38–41.

⁸ Lt Col Michael L. McGinnis and Maj George F. Stone III, “Decision Support Technology,” *Military Review* 74, no. 11 (November 1994): 68.

⁹ Col Richard Szafranski and Col Joseph A. Engelbrecht, Jr., “The Structure of the Revolution: Demystifying the RMA” (Unpublished paper, March 1996), 6–7. The authors used the term *momentum control* to explain time. However, “time is more than speed. It is the attribute of controlled timing or modulating momentum.” See also endnote 10, this chapter.

¹⁰ Ralph D. Sawyer, *The Seven Military Classics of Ancient China* (Boulder, Col.: Westview Press, 1993), 442. The concept and description of “momentum control” was derived from the Chinese term, *chieh*, translated as “constraints,” which is commonly used to indicate constraints or measures imposed on troops. The term lacks a satisfactory English translation because it encompasses the concepts of “control,” “timing,” and “measure.” See also endnote 9, this chapter.

¹¹ Ibid.

¹² Szafranski and Engelbrecht, 6–7.

Chapter 3

Technology Investigation

What the warrior needs: a fused real-time, true representation of the warrior's battlespace and the ability to order, respond, and coordinate horizontally and vertically to the degree necessary to prosecute his mission in that battlespace.

—Adm Richard C. Macke
CAI for the Warrior

In 1992 Adm Richard C. Macke understood what war fighters since Alexander the Great wanted. Information operations is a legitimate and increasingly important military mission that seeks to satisfy Admiral Macke's requirement.¹ Perfecting this capability should allow US military leaders to achieve information dominance and control the momentum of military operations. This vision does not merely provide information, but also empowers users with the ability to leverage information to conduct warfare. This paper refers to this vision as the Cyber Situation. The Cyber Situation is necessary for the US military to maintain its competitive edge against future adversaries.

Technology will provide the means to achieve a complete battlespace picture and the ability to affect it instantly with the Cyber Situation concept. This chapter lays the technological foundation which could achieve this capability. Five broad technology areas should contribute to reaching this goal. Some solutions appear to be evolutionary; some will likely be wildcards—scientifically plausible achievements that will require a technology leap.² While this chapter describes the technologies, the next chapter applies these technologies and assesses their contribution to a single system to achieve the Cyber Situation vision.

The Cyber Situation will require five technology areas to evolve and synergize by 2025 to achieve OODA Loop integration. First, collection platforms should provide a detailed global awareness, giving decision makers a complete situational picture.³ This parallels the observe function of OODA. Second,

communications systems should advance to allow in-time access to virtually any available database. Communications will permit information flow around the loop. Third, computer-processing power and, fourth, intelligent software will provide the ability to integrate and correlate disparate types and sources of information and aid in decision making, contributing to the orient and decide functions. Fifth, human systems and biotechnology advancements will make the man-computer interface seamless. The end result should be an improved ability to access and direct weapons.⁴ Figure 3-1 illustrates these essential technologies.

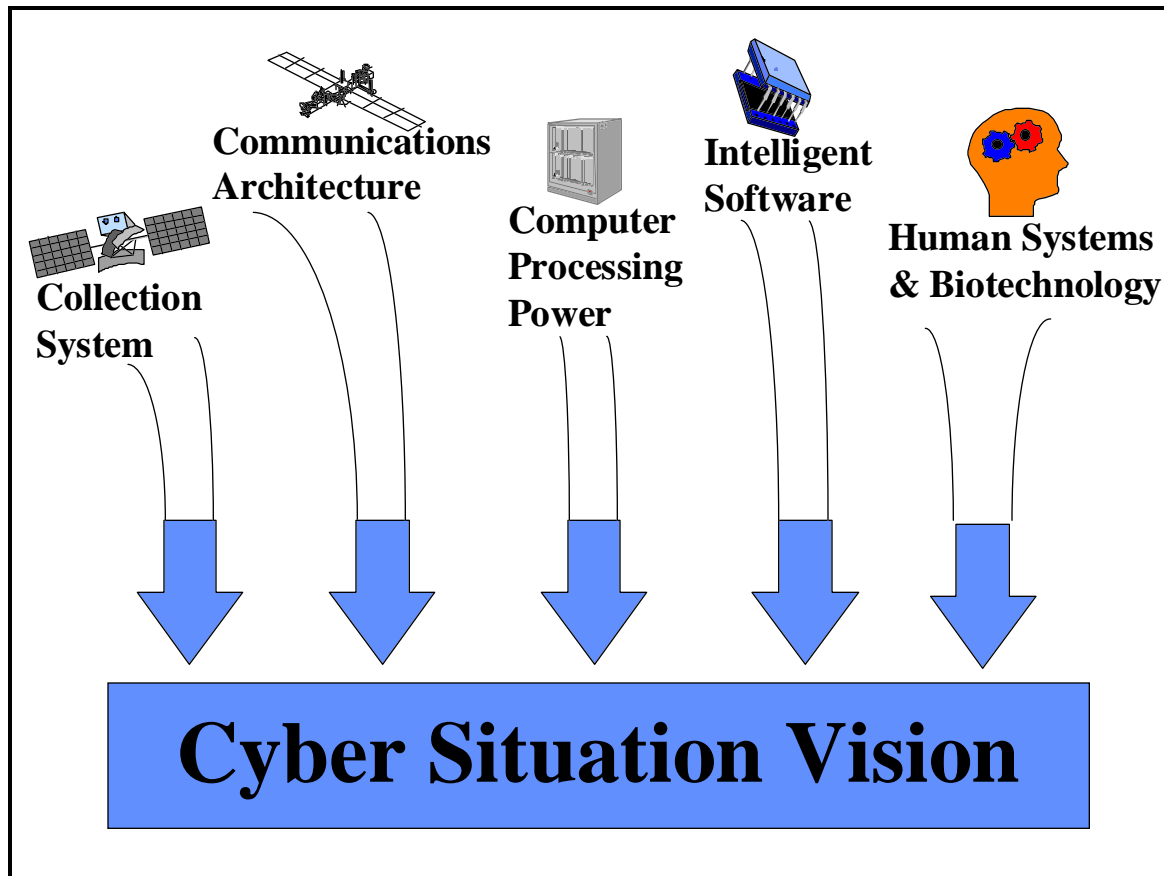

Source: Microsoft Clipart Gallery© 1995, courtesy of Microsoft Corporation.

Figure 3-1. Battlespace Vision Key Components

The following sections address each of these broad technology areas. Within each section, the discussion first relates the particular technology to the required capability in terms of the OODA tasks and attributes (tables 1 through 4). Next, it assesses the current state of the technology and notes which are on evolutionary or revolutionary tracks. It then evaluates various research and development (R&D) trends, focusing on the time and cost needed to achieve the desired technological capability. Most of the

development will be in the commercial arena. Special recognition will be made for those developments that require a military investment.

Collection Platforms

Collection is the process of capturing information from all sources to present an in-time “picture” of the battlespace. In this case, picture refers to more than an image. It is all surveillance and reconnaissance data, including imagery, signals intelligence, weather data, aircraft radar navigation equipment transmissions, cellular telephones and communications devices intercepts, and data in-transit between computers. The list is virtually endless. All information is potentially useful to the Cyber Situation. However, it is not this paper’s purpose to exhaustively review all collection technologies. Rather, it will focus on the platforms from which the data and intelligence is received.

Presently, overhead and air-breathing assets collect information. Overhead assets refers to satellite-based systems. They include surveillance, reconnaissance, and target acquisition systems as well as environmental monitoring assets.⁵ While many are classified programs, civil and commercial agencies are increasingly able to collect more timely and detailed data. This is particularly true for such environmental monitoring satellites as the French SPOT satellite which can provide multispectral imagery with 10 meter resolution.⁶ Air-breathing assets are aircraft, manned or unmanned.

By 2025 collection platforms will exploit the complete electro-optical frequency spectra. Some systems will be deployed for long-durations. These systems will observe such standing requirements as military communications traffic, logistics, and computer interfaces. Some of this capability currently exists. However, the military still lacks sufficiently broad coverage.⁷ Other systems may be used on a contingency basis. These systems will use two emerging technologies: miniaturized satellites and uninhibited reconnaissance aerial vehicles (URAV).

Miniature Satellites

The most compelling satellite technologies advances include miniaturization and decreased launch expense.⁸ These two complementary advances are important to the system effectiveness of the Cyber

Situation. Increased miniaturization of individual satellites allows for less costly construction per unit and easier deployment while at the same time making them harder to detect and track. Miniature satellite constellations have great applicability in terms of flexibility and deployability.

Miniature satellites could fill coverage gaps to supplement long-duration systems. The miniature satellite constellations would carry payloads optimized for specific contingencies. The payloads may focus on specific static, mobile, or moving targets. This option offers a compelling, inexpensive, and rapidly deployable solution to “customize” collection efforts to meet the contingency needs.⁹ The satellites may be constructed en masse and be on hot alert.

While decreased cost for space access is forecasted, miniature satellites are unlikely to garner significant commercial investment. This is not to say miniature components will not be commercially available. Commercial technology initiatives will shrink everything from the solar panels and batteries to the sensors. However, the military must press forward with the R&D to package miniature satellites and make them available for immediate use.

Uninhabited Reconnaissance Aerospace Vehicles

The other emerging technology area for collection platforms is URAV. These systems would provide the data not accessible to either the long-duration assets or the miniature satellite constellations. URAV would reduce the risk inherent in manned collection platforms and allow the flexibility to maneuver rapidly to specific locations which may be obscured from space-based sensors.¹⁰

The Department of Defense has operated URAV since the Vietnam conflict. Their usefulness will push development of less costly, more reliable, and more flexible systems.¹¹ One area of flexibility will include more varied sensors that collect all-source information. This area will predominately require military R&D.

The combination of deployed long-duration satellites, small satellites, and URAV could enable the military to achieve broad coverage of an area of interest virtually all of the time, thus providing the user the most updated Cyber Situation possible.

Communication Infrastructure

To achieve information dominance requires high-capacity, secure, accurate, reliable, robust, and easy-to-use communications. Indeed, data and information movement is the track upon which the decision cycle runs. A highly mobile war fighter must be able to maintain an in-time “picture” of the battlespace, formed by vast amounts of information from multiple sources. The user must also be able to communicate with others who are observing the same battlespace picture. Of particular importance is the ability to access and direct weapons at a moment’s notice.

Communications must work anywhere and everywhere. Current limitations include narrow bandwidths and insufficient ground-based and satellite infrastructure. In 2025 these limitations will likely be resolved as bandwidth and communications capacities continue to expand.¹²

Although bandwidth is a limiting factor, it has grown dramatically in the last 10 years. The key breakthrough was fiber-optic cabling, which geometrically increased available information flow. Economics drove the development of fiber-optic capability. The marketplace demanded increased throughput, and the private sector responded with a quantum leap over twisted pair (copper wire) technology. Demand will continue to push increased access throughout the country and around the world.¹³ Fiber-optic cable will likely be the predominant communication carrier for the foreseeable future, although wireless and satellite communications connectivity also will be required.¹⁴

Satellite communications are tremendously important because of the need to move large amounts of the information from collection platforms. Current capabilities are inadequate to provide full connectivity and functionality to provide coverage for any given desired place and time. Here, too, technology advances will greatly enhance and improve the ability to move vast amounts of data quickly.

As noted in the previous section, the most compelling satellite technologies advances include miniaturization and decreased launch expense. A significant amount of work has already been done on the miniaturization of relay and broadcast satellites. To date, experiments have centered on deploying these small satellites over a location where the telecommunications infrastructure is lacking.¹⁵

On the ground, direct broadcast satellite (DBS) technology use will release commanders and decision makers from the bonds of landlines. It is a fully man-portable satellite receive and transmit ground station.

DBS is commercially available at reasonable cost. DBS groundstations will be able to accommodate large bandwidth and be fully deployable.¹⁶ This is a distinct advantage in terms of flexibility for decision makers at all levels. DBS technology allows on-scene commanders to forward in-time inputs through the system and up the chain of command. Future DBS technology will continue to advance and miniaturize, producing greater capabilities in smaller packages. One challenge is to be able to provide portable power that is not a weight and size burden. Nevertheless, the commercial industry will produce miniaturized, low-power communication devices. As this type of technology improves, DBS might allow human links to satellites. The human body could potentially become a part of the system. “With a little digital help, people’s ears could work just as well as ‘rabbit ears.’”¹⁷

Mission accomplishment requires the communications architecture to accurately transmit complete media spectra. More important is the Cyber Situation’s need for secure communications. This is a broad category requiring a more detailed discussion.

Security

Since security affects all elements of the OODA Loop, it is best addressed under the communications section. Data must be secured in three different areas: storage, transmission, and dissemination.

Because of the tremendous storage capacity required, archival databases likely will be secured much as they are now, in a vaulted building on shielded media (magnetic, or some evolutionary storage media not yet developed). Storage is discussed in the computer power section below.

The compromise potential is much higher during data transmission, occurs during information collection and routing by way of communications infrastructures. Resident safeguards must protect transmissions from interruption and intercept. Experts expect that this should be easily attained by way of commercially available encryption packages that are nearly unbreakable.¹⁸

The final security concern involves the process to retrieve, display, and use data. Dissemination security exists to ensure that only those with the appropriate access and need-to-know may use the most sensitive databases. Some promising technologies are already used in this area. Among the most viable are retinal scanners and fingerprint validation technologies developed by the private sector.¹⁹

Technology could plausibly lead to the use of deoxyribonucleic acid (DNA) samples to validate individual access requirements. The validation system will include each user's DNA imprints, which must be checked before the system allows access. Today, this technology is in its infancy, but, will continue to evolve and likely become the fool-proof way to validate user authenticity for access and employment.

The second type of dissemination security involves technology known as multilevel security (MLS) network management.²⁰ Upon entering an information system, the system grants access based on the user's authorization. Ideally, MLS allows users with various classification levels to share the same communication architecture and even the same sensors. The difference lies in what each user is able to access in each situation. Since the mid-1980s, the civilian and military communities have conducted R&D in MLS technology. However, the state of technology does not currently allow ideal MLS use. It is reasonable to expect a perfected system by 2025.²¹

Communications Wrap-Up

In large measures, the commercial and military communities already have established necessary communications infrastructure with the National Information Infrastructure (NII) and the Military Information Infrastructure (MII). Both NII and MII are structured to move information in the most expeditious manner, taking advantage of the best of commercial and military communications links. "The MII must be able to adapt to unforeseen circumstances, whether induced by the military or by the commercial world. . . It becomes more important to learn to use existing and emerging capabilities in the domain of military applications than it is to develop the capabilities themselves."²² Thus, the groundwork is already laid for expansion and evolution.

Nevertheless, to fully achieve the 2025 Cyber Situation, a global infrastructure must provide the user a desired view anywhere on earth. Therefore, the 2025 information infrastructure must incorporate both NII and MII—leading to a Global Information Infrastructure (GII).²³

Effective communications architectures must be robust to accommodate the considerable bandwidth requirements and to harness the full capability of military and civilian communications advances. This leads to the next topic, computer power.

Computer Power

If communications is the track on which the OODA Loop runs, powerful computers is the engines pulling the train. Computers will play a key role in any decision support system to integrate the collected data and present it for orientation and decision making.

Powerful computers with massive storage capacity will be essential in the Cyber Situation. Fortunately, the rapid increases in processing speed and storage, combined with decreased size and energy consumption, will likely continue unabated.²⁴

While silicon circuit technology remains viable for the near future, eventually the number of circuits that can be etched will reach a limit.²⁵ However, researchers are pursuing alternative technologies that should result in even more amazing improvements. They include such exotic concepts as quantum dots and nanomechanical gates.²⁶

Biological computing is another promising field which might yield a potential thousandfold computational improvement for one ten-millionth the energy.²⁷ The concept includes using genetic material from insects to self-assemble into computing elements. House flies and grasshoppers have pattern-recognition abilities which could be applied directly for military and commercial purposes, including cryptography and navigational computation. Initial payoffs to molecular biology computing research may occur in five to 10 years, especially for sensor applications.²⁸

Increased speed requires improved data storage media. Again, research shows promise. Holographic memory may allow storage of 64 billion bits on a crystal the size of a compact disk. Activated by a small laser, a single “disk” could contain over 600 hours of music or 30 million pages of double-spaced, typewritten text.²⁹ Since the data is contained in the laser, it makes it easy to transmit in optical cable as well.³⁰

Clearly, by 2025 nearly infinite computations with unlimited storage will be available on tiny machines. It should come with negligible military investment although the *New World Vistas* (NWV) Information Technology Panel warns that defense should continue to fund basic research to keep the “pump primed,” else risk less innovation as private research focuses on highly directed problems.³¹ However, the challenges of

storage capacity and capability are not the only areas where researchers are trying to stretch the limits. More importantly are increasing the cognitive abilities of the software running on these powerful machines.

Intelligent Software

The most important technology area is the continued advancement of intelligent software. The previous technologies explained how vast quantities of information will be readily available to the war fighter. Without some assistance in managing the load, the commander will suffer from information overload.

Intelligent software is broadly defined as the component programs and algorithms executing on various computer systems. While primarily related to the human's use of the program, it also may operate independently of the user. For example, the collection systems will be able to recognize and identify features, identify information gaps and task a sensor to "fill in the gap," fuse multiple data sources to present an integrated picture, and prompt a user of significant events, all without human assistance. Other software agents will respond to human taskings or augment humans in decision processes.³² Attributes include the ability to organize and interpret information, simulate and model potential actions, weigh alternatives, and recommend courses of action.

The following paradigm applies for all intelligent systems (biological or computational). This paradigm helps identify and measure the broad intelligent software tools needed for the Cyber Situation.

All intelligent systems continuously engage in five activities:

- . They *perceive* the world.
- . They *interpret* their perceptions in light of their knowledge of the world.
- . They *make plans* based on their current model of the world.
- . They *act* within the world in order to achieve their goals.
- . They *communicate* with other agents to share perceptions and collaborate on execution (emphasis added).³³

Note the elements of Boyd's OODA Loop in this concept. Many of today's experts envision technological advances will occur in all activities to assist the decision maker. Indeed, the Cyber Situation assumes double-leap improvements in the ability to observe, act, and communicate. The concept focuses on the interpretation and planning activities and how to make the best use of information to plan and execute a military operation.

Intelligent software can be broken down into four broad core technologies:³⁴

Image Understanding

Image understanding (IU) seeks to develop mechanisms to create a “description” of the world from sensor images, suitable for particular purposes. The challenge is identification “despite object occlusion, shadows, reflections, and other disturbances.”³⁵ Applying contextual information may be one mechanism to improve the IU process.

IU is a key technology because the Cyber Situation must generate and communicate situational awareness to the user. Within five years, the DOD’s Advanced Research Project Agency (ARPA) expects “to carry out applications-directed research on machine vision, provide a suitable IU software environment, and further develop IU capabilities for specific applications.” The long-term goal is to “develop computational theories and techniques for use in artificial vision systems whose performance matches or exceeds that of humans, exploiting sensing throughout the breadth of the electromagnetic spectrum, in all environments.”³⁶ Commercial applications include industrial part recognition, visual inspection systems, and indoor robot navigation. However, because of the predominance of military applications, this is a technology requiring DOD investment.

Intelligent Integration of Information

Intelligent integration of information (I3) is the technology to “intelligently process, compile, and abstract useful knowledge from multiple data sources with different interfaces, query languages, data structures, terminology, and semantics.”³⁷ This ability has applications throughout the Cyber Situation. I3 is needed to provide the fused, deconflicted view of the battlespace.

Many valuable applications have been developed. An example is the Air Campaign Planning Tool where planners can now locate high-priority targets in a fraction of the time previously required.³⁸ However, much work remains to achieve large-scale applications which abstract data from the entire GII. Although commercial applications will push the technology (resulting, for example, in personal assistant

agents sorting increasing amounts of daily electronic mail),³⁹ the military must invest to obtain the ability to index and then retrieve images based on military semantics.⁴⁰

Planning and Decision Aids

Planning and decision aids (PDA) tools develop representation and reasoning techniques to generate and analyze plans and schedules. These tools are necessary to help the user (or users) make correct and timely decisions, thus deconflicting information overload. The tools will “reduce problem solving time by orders of magnitude while at the same time increasing the number of options considered by orders of magnitude.”⁴¹

The concept of PDAs is well understood, as it is simply an implementation of such decision theories as linear programming and quantitative analysis. What is new is the ability to employ these techniques on a high-speed computer. Many techniques already exist, both in private and military use. One example is the Dynamic Analysis and Replanning Tool which was used in Desert Storm.⁴² Commercial applications, both executive and group support systems, also are being adapted for military use. The military must focus on ensuring more than one user can use them simultaneously and that the tools capture the planning rationale.⁴³

Human Computer Interaction

Human computer interaction (HCI) will “develop techniques and environments to provide informative, intuitive, and taskable access and control over complex software.”⁴⁴ This environment is another key area for the Cyber Situation--being able to “interact in a natural fashion with speech, gesture, and other advanced interaction techniques.” Eventually, it should include brain activated control. A goal is for many users able to interact over computer networks.

Initially, human language system advances will be where the most significant work is done. However, the NWV Information Technology Panel suggest handwriting recognition will become prevalent as well as speech recognition capabilities within 10 years. While the currently dominant keyboard-display-mouse configuration will remain, newer generations of users will become more comfortable with more natural interfaces. By 2025 technology will have matured such that handheld, portable “personal assistants” will be

available. Additionally, virtual and augmented reality systems and telepresence models also will be in use. Telepresence models allow a human access to otherwise inaccessible locations. Applications include microsurgery, space system repair, and microelectronic machine assembly.⁴⁵

The NWV Human Systems and Biotechnology Panel describes neuroscience as a promising research area. As science improves our understanding of the brain and how it functions, it makes it possible to direct equipment to respond to our thoughts, without any verbal or written command. Already, preliminary research using an 128-sensor array electroencephalograph (EEG) pressed against a subject's skull can "influence information content and display designs on a computer screen."⁴⁶ This concept is discussed further in the next section. Commercial and medical organizations will take the lead in developing this technology. Neuroscience developments will continue.

Human Systems and Biotechnology

The human-computer systems integration is a vital lead-in to the final technology area. Human systems and biotechnology offers the potential to create a seamless flow of information between human and computer. By exploiting the human cognitive process, it can be tailor information to present precisely what is needed.

This section is divided into two parts. The first is understanding information flowing to and from the brain. The second is how to present that data using visual-imaging techniques. Mastering these technologies will allow users to select information for direct input into their brains. However, regardless of how advanced a decision system becomes, a human will be in the loop. The best technology can only help, but in the end, the person, not the machine, ultimately makes the decision.

Charting the Brain

Thirty years ago little was known about the brain. Great advances have been made in the last 10 years, and much has been learned about information flow out of the brain and the way it interacts with the neural network.⁴⁷ Understanding how information enters the brain and how it is processed will form the foundation for the ultimate in human-computer interface. "Success in transducing and translating brain waves allows

people to interface with specific systems, perhaps sensed through transducers in a headband or another such brain-machine connection.”⁴⁸

Two research areas are critical to the human computer interface. The first of these is, charting and understanding information flow out of the brain. The second, and more applicable, is information flow into the brain. Understanding of human systems such will enable more rapid processing of data and more efficient use of the provided information.

Charting information out of the brain is a complex effort. However, much work has been done in this area.⁴⁹ Mechanical methods have been fielded to emulate, and in some case replicate, these complex processes.⁵⁰ Intelligent materials, including fiber-optics and piezoelectric materials, are two techniques under development to try to replace damaged or destroyed neuron-actuation sensor networks in humans.⁵¹

In principle, data flowing out of the brain is in the form of electronic impulses which actuate the neurostructure within humans.⁵² Recent research has charted the source of some basic impulses within the brain, identified precisely what neuron network is actuated by electric impulses, and determined what action is completed by the network.⁵³

Charting information flow *into* the brain and how the brain processes it once inside is even more difficult. This effort requires understanding how the brain formats the data to make decisions. Each human's information process is unique, based on such factors as experiences, learning, intelligence, and personal biases.⁵⁴ Science is attempting to understand the commonalities between humans.⁵⁵ Some work has been done to chart the essentials of human information processing fig. 3-2.⁵⁶

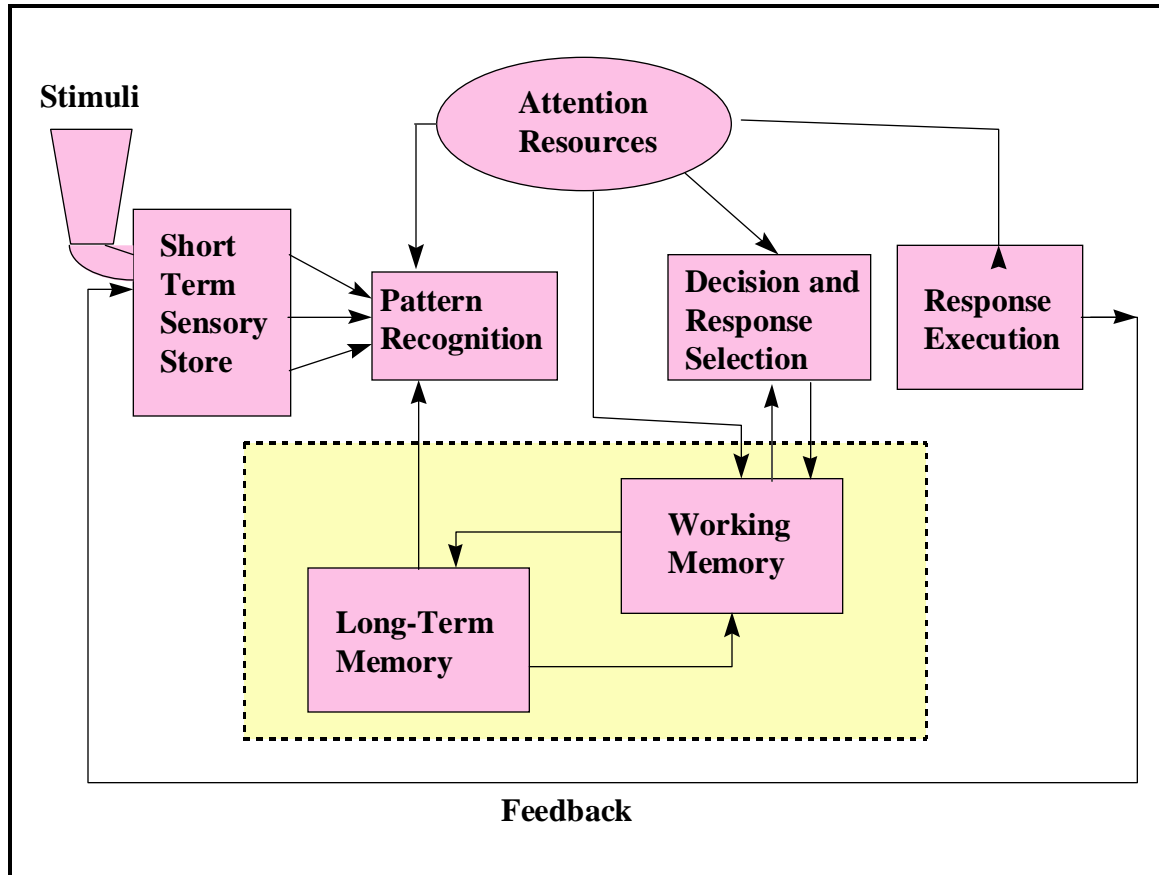

Source: Microsoft Clipart Gallery© 1995, courtesy of Microsoft Corporation.

Figure 3-2. Human Information Processing Flow⁵⁷

Computers can play a significant role in nearly every area of human-information processing. Their potential lies in organizing information to assist human decision making. They can produce more options than a human brain can recall.⁵⁸ In fact, computers have become the preferred medium for information storage and recall.⁵⁹

However, a gap still exists in the information flow between humans and computers. Information is processed by a human looking at a screen, reading the data, and translating it into something useful through internal thought. “We talk longingly about human-computer interactions and conversational systems, and yet we are fully prepared to leave one participant in this dialogue totally in the dark. It is time to make computers see and hear.”⁶⁰ Users should “converse” with computers. Intelligent systems outlined above provide only part of the answer to improve human-computer interaction. The missing piece is a better way to

format and transmit information from the digital computer processor in the computer chip to the analog human processor in the human brain.

Instead of formatting a cathode ray tube (CRT) to more easily access and display data, a computer can be designed and programmed to bypass the CRT and format information which can be immediately processed by the brain. The logical extension would be to place the human computer interface directly in the brain. Some significant progress already has been made in this area by the Stanford University research center and their development of a nerve chip.

It is an electronic interface for individual nerve cells to communicate with a computer. This human-machine linkage will. . . enhance human capability in many ways. If artificial eyes can convert video to nerve signals, won't it be possible to use the same technique to superimpose computer-generated information in front of one's field of view?⁶¹

This capability will have extraordinary commercial applications from medical advances. These advances will help restore patients with damaged neural, audio, and visual systems as well as enable individuals to achieve the "ultimate virtual reality trip."⁶²

Visualization and Mental Imaging

This second broad category encompasses a realm of the cyberspace essential to the concept. Developing technologies are based around the idea of virtual projection systems that evolve into holographic image projection. The National Center for Supercomputing Applications Virtual Reality Laboratory "is a research facility engaged in the exploration of new methods of visualizing an interfacing with scientific data and simulations."⁶³ To further their objectives, they have created the CAVE a "surround-screen surround-sound, projection-based virtual reality system."⁶⁴ Multiple participants can enter the CAVE and interact by wearing stereo glasses rather than a helmet. "The CAVE can be coupled to remote data sources, super computers and scientific instruments via high-speed networks."⁶⁵ The NWV Information Technology Panel considers significant virtual reality advancements in the next 10 to 20 years. However, the display mechanism will primarily involve a helmet.

Commercial applications are easy to envision, witness the growing entertainment market for virtual reality games. This appears to be the next step from video teleconferencing. Another useful application will

be for training systems—especially simulations.⁶⁶ This has wide commercial applications, especially as future systems will require such high-knowledge levels to use them as transportation and manufacturing.

A more specific military application of this type of technology is the DOD simulation network (SimNet). This capability allows a simulator to emulate a battlefield precisely. Trainees sit in their own aircraft or tank simulator and are able to “view” the battlefield from their own perspective. “Army tankers in trainers in Fort Knox can look out of their sites and see the same location—only from each of their individual perspectives. Air Force pilots in California can ‘fly’ missions . . . at the same time.”⁶⁷

A combination of brain processes and visual imaging already has been developed in the laboratory. The California Institute of Technology has developed an energy efficient computer chip which emulates the analog thinking of the human brain. It is specifically modeled on the construction of the human brain, specifically the cerebral cortex.⁶⁸ When this capability is fully mature, this chip could provide the baseline for a brain implant hooked to the all the sensory segments of the brain, not just the eye.

Bringing It Altogether--The Nexus

While each technology area will progress at a unique rate, the challenge is to bring them together to reach their synergistic peak--the nexus (fig. 3-3).

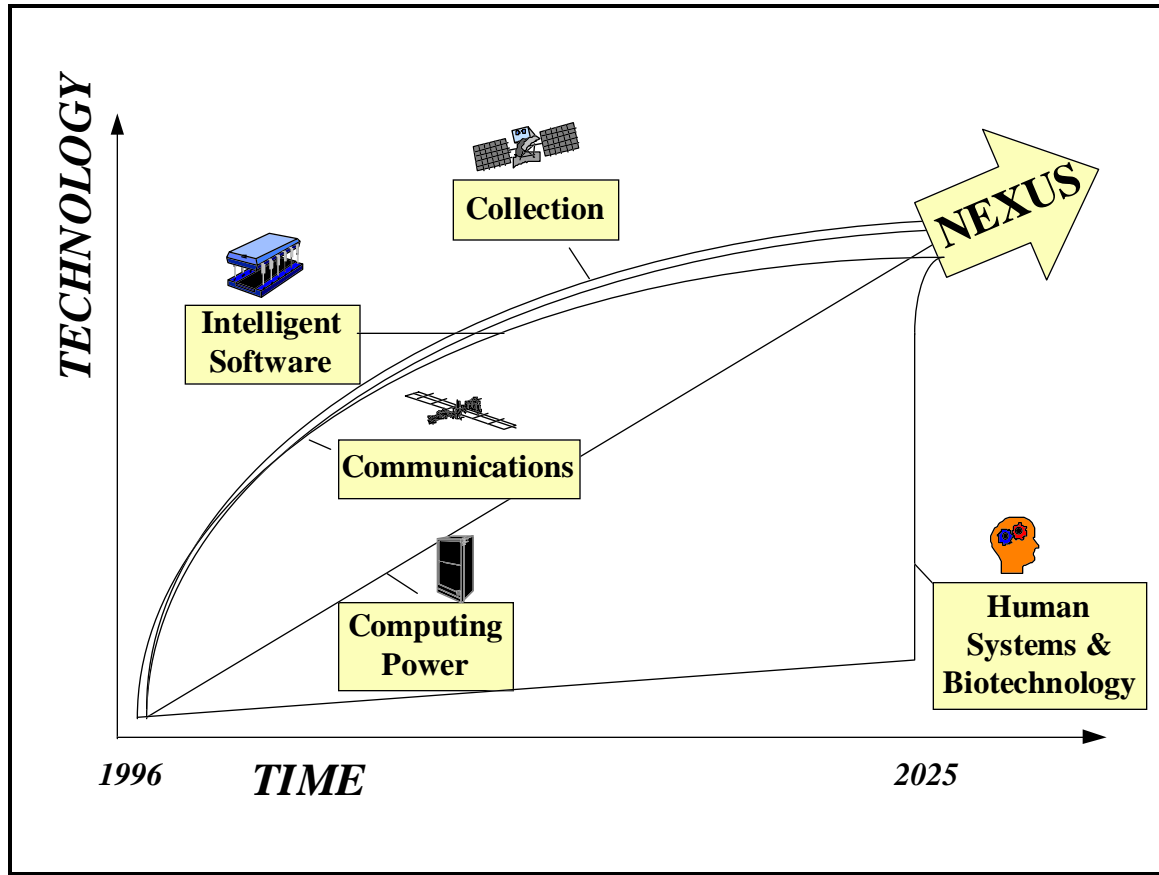

Source: Microsoft Clipart Gallery© 1995, courtesy of Microsoft Corporation.

Figure 3-3. Development Lines for System Elements

Collection. Collection capability will be complete when there is no want of information. The various constellations of permanent satellites complimented by the mini satellites will provide coverage of the entire world in every spectrum. Collection development should continue to grow until about 2015, when the complete link between the small satellites and the permanent constellations should be seamless, and the small satellite development will be commensurate with the requirements.⁶⁹

Communications. Communications capacity will peak when the entire globe is accessible at all times and there is absolutely no restriction on the size or type of transmission available to the customer. The web of commercial, government, and military networks will be seamless, and only the speed of light will delay information movement. There is much effort underway, both in the commercial and military sector, to achieve this connectivity. Development of new systems and new capabilities should reach this goal by 2010.⁷⁰

Computing power. Computing power will continue to grow in capacity, doubling every 18 months for the near term.⁷¹ As noted, analysts have frequently thought the silicon chip had reached its maximum capacity, then discovered through increased micronization that more capacity could be obtained. However, most analysts believe that the silicon chip will hit its peak between 2015 and 2020.⁷² If true, R&D efforts will continue to search for other media to store and process data.

Intelligent Software. Intelligent software is increasing in its availability but has yet to fully meet the requirements of the Cyber Situation. More effort is required to allow full capability of intelligent systems and bring that technology to bear on an advanced decision tool. Current intelligent software development is not well articulated, and the specific capability of the software is left to systems designers and engineers meeting the demands of a specific program.⁷³ Thus, much of the development of intelligent systems is linear and relates only to the requirements of a specific program. Such a design is not conducive to interaction and broader application.

Human Systems and Biotechnology. This area requires the most work to achieve the Cyber Situation. Work is expected to continue at a modest pace until a breakthrough in this technology is achieved.⁷⁴ Like many advanced research areas, work here will require one big leap over a single chasm. In this case, the chasm is understanding the way information is formatted in the brain and how it is used. Once this chasm is achieved, progress in human computer interaction will grow exponentially and quickly catch up with the other technology areas.

By 2025 the five technology areas will be effectively linked to develop the Cyber Situation to enable commanders to achieve information dominance. The next chapter will describe the Cyber Situation system, its components, and how it meets the attributes of the OODA Loop tasks.

Notes

¹ Widnall and Fogleman, *Cornerstones on Information Warfare*, 11.

² John L. Peterson, *The Road to 2015: Profiles of the Future* (Corte Madera, Calif.: Waite Group Press, 1994), 288. Peterson states, “Wild cards have a low probability of occurrence but a very high impact.”

³ USAF Scientific Advisory Board, *New World Vistas: Air and Space Power for the 21st Century* (unpublished draft, the information applications volume, 15 December 1995), 68.

⁴ *New World Vistas*, (unpublished draft, the human systems and biotechnology volume), 8.

⁵ Army Space Institute, *Theater Air Campaign Studies*, vol. 8, *Space Support in Mid-Intensity Conflict* (Maxwell AFB, Ala.: Air University Press, 1995), 306–9.

⁶ *Ibid.*, 308.

⁷ *New World Vistas*, (unpublished draft, the information technology volume), 85.

⁸ Nicholas Negroponte, *Being Digital* (New York: Vintage Books, 1995), 35–36.

⁹ Lt Col Henry Baird et al., “Spacelift” (Unpublished 2025 research paper, Air University, Maxwell AFB, Ala., April 1996); 2025 Concept, No. 900552, “On-demand Tactical Recce Satellite Constellation,” 2025 Concepts Database (Maxwell AFB, Ala.: Air War College/2025, 1996).

¹⁰ Numerous 2025 Concepts dealt with this technology to include:

2025 Concept, No. 900272, “Very High Altitude Balloon-Borne Systems,” 2025 Concepts Database (Maxwell AFB, Ala.: Air War College/2025, 1996); 2025 Concept, No. 900280, “Fly on the Wall,” No. 900434, “Airborne Sound Sensors,” 2025 Concepts Database, (Maxwell AFB, Ala.: Air War College/2025, 1996); 2025 Concept, No. 900438, “Ultraendurance High-Altitude Ocean Loitering Uninhabited Reconnaissance Vehicle,” 2025 Concepts Database (Maxwell AFB, Ala.: Air War College/2025, 1996); 2025 Concept, No. 900517, “JSTARS Replacement,” 2025 Concepts Database, (Maxwell AFB, Ala.: Air War College/2025, 1996); and 2025 Concept, No. 900604, “UAV Constellations,” 2025 Concepts Database (Maxwell AFB, Ala.: Air War College/2025, 1996).

¹¹ Lt Col Bruce Carmichael et al., “StrikeStar 2025” (Unpublished 2025 research paper, Air University, Maxwell AFB, Ala., April 1996), 94-95. Particularly, the appendix describes the historical reliability problems with UAV.

¹² Alvin and Heidi Toffler, *War and Anti War* (New York: Warner Books, 1993), 90–91.

¹³ Negroponte, 21–36.

¹⁴ *New World Vistas*, (unpublished draft, the information applications volume), 32–46.

¹⁵ A senior US Air Force policymaker lecture given to the 2025 Study Group under the promise of nonattribution

¹⁶ Aleksandar Kolarov and Joseph Hui, “Least Cost Routing in Multiple-Service Networks: Part II,” On-line, Internet, September 1995, available from <http://www.research.att.com/hgs/infocom95/program.html>.

¹⁷ Negroponte, 211.

¹⁸ *New World Vistas*, (unpublished draft, the information technology volume), C-3.

¹⁹ There are several different authentication technologies. The retinal (eye) scanner is currently used at Falcon AFB, Colorado.

²⁰ Makoto Takano and Katsumi Fujita, “Multilevel Network Management by Means of System Identification,” On-line, Internet, September 1995 available from <http://www.research.att.com/hgs/infocom95/program.html>.

²¹ Charles Kalmanek and K.G. Ramakrishnan, Third International Telecommunications Symposium, “On-line Routing for Virtual Private Networks,” On-line, Internet, September 1995, available from <http://www.research.att.com/hgs/infocom95/program.html>; Lt Col James McMillan, Air Force Liaison to National Security Agency, telephone interview by Maj Scott Bethel, 26 February 1996. MLS has been a long-standing DOD problem both in the US only (collateral versus SCI) and in releasing data to foreign nationals. The main problem is with data at different classification levels using the same communication architecture: how to prevent inadvertent or targeted database access at a higher classification level through lower channels.

²² *New World Vistas*, (unpublished draft, the information applications volume), 52.

²³ Institute for National Strategic Studies, *Strategic Assessment 1995: US Security Challenges in Transition* (Washington, D. C.: National Defense University Press, November 1994), 151.

- ²⁴ *New World Vistas*, (unpublished draft, the information technology volume), 1, 87–90.
Peterson, 28–30.
David A. Patterson, “Microprocessors in 2020,” *Scientific American* 273, no. 3 (September 1995): 48–51.
- ²⁵ *New World Vistas*, (unpublished draft, the information technology volume), 87.
- ²⁶ Patterson, 51.
- ²⁷ Clarence A. Robinson, “Molecular Biology Computation Captures International Research,” *Signal* 50, no. 6 (February 1996): 17–21; Thomas A. Bass, “Gene Genie,” *Wired* (August 95): 114–17, 164–68.
- ²⁸ Robinson, 21.
- ²⁹ Demetri Psaltis and Fai Mok, “Holographic Memories,” *Scientific American* 273, no. 5 (November 1995): 70–76.
- ³⁰ *New World Vistas*, (unpublished draft, the information technology volume), 24. This document suggests “the communications laser will replace the microprocessor as the key enabling technology shaping the personal computer industry.”
- ³¹ *Ibid.*, 29. The document also suggests battery performance may be a limiting factor.
- ³² Advanced Research Program Agency, “The SISTO Solution: Intelligent Software Systems,” On-line, Internet, 23 July 1995, available from <http://www.arpa.mil/sisto/Overview/Solution.html>. SISTO is the Software and Intelligent Systems Office of the Advanced Research Program Agency.
- ³³ *Ibid.*
- ³⁴ Advanced Research Program Agency, “Intelligent Systems,” On-line, Internet, 23 July 1995, available from http://www.arpa.mil/sisto/Overview/Intel_Thrust.html.
- ³⁵ Oscar Firschein and Thomas Strat, “Image Understanding Program,” On-line, Internet, 23 July 1995, available from <http://www.arpa.mil/sisto/Overview/Image.html>.
- ³⁶ *Ibid.*
- ³⁷ David Gunning, “Intelligent Integration of Information (I3),” On-line, Internet, 23 July 1995, available from <http://www.arpa.mil/sisto/I3.html>.
- ³⁸ *Ibid.*
- ³⁹ *New World Vistas*, (unpublished draft, the information technology volume), 38–44.
- ⁴⁰ *Ibid.*, 13.
- ⁴¹ Dr Tom Garvey, “Planning and Decision Aids Program,” On-line, Internet, 23 July 1995, available from <http://www.arpa.mil/sisto/PDA.html>.
- ⁴² *Ibid.*
- ⁴³ *New World Vistas*, (unpublished draft, the information technology volume), 13.
- ⁴⁴ Allen Sears and Robert Neches, “Human Computer Interaction Program,” On-line, Internet, 23 July 1995, available from <http://www.arpa.mil/sisto/HCI.html>.
- ⁴⁵ *New World Vistas*, (unpublished draft, the information technology volume), 37.
- ⁴⁶ *Ibid.*, 24.
- ⁴⁷ Peter Thomas, “Thought Control,” *New Scientist* 149, no 2020 (9 March 1996): 39. The University of Utah has done significant work to map the brain. Through a series of some 100 sensors implanted in the brain, this team effectively mapped the parts of the brain that see and hear. Their focus was to reformat information to restore sight to the blind. They reported limited success as some of their research subjects claim to “see” words in their mind while reading them in Braille.
- ⁴⁸ Peterson, 293.
- ⁴⁹ Henry Petroski, *To Engineer is Human* (Chicago: University of Chicago Press, 1989), 216.
- ⁵⁰ Craig A. Rogers, “Intelligent Materials,” *Scientific American* 273, no. 3 (September 1995): 123.
- ⁵¹ *Ibid.*, 124.
- ⁵² Thomas, 38–42.

- ⁵³ Ivan Amato, "Animating the Material World," *Science* 225 (17 January 1996): 284–286.
- ⁵⁴ Thomas, 40.
- ⁵⁵ Petroski, 211.
- ⁵⁶ Thomas, 39; *New World Vistas*, (unpublished draft, the human systems and biotechnology volume), F-1.
- ⁵⁷ *New World Vistas*, (unpublished draft, the human systems and biotechnology volume), F-2.
- ⁵⁸ Thomas., 40.
- ⁵⁹ Ibid., 41.
- ⁶⁰ Negroponte, 128.
- ⁶¹ Peterson, 63.
- ⁶² Ibid., 41.
- ⁶³ Bill Sherman, "NCSA Virtual Reality Lab & CAVE," On-line, Internet, 18 February 1996, available from <http://www.ncsa.uiuc.edu/VR/VR.html>. The laboratory is located at the University of Illinois at Urbana-Champaign.
- ⁶⁴ NCSA VRL, Electronic Visualization Lab, University of Illinois at Chicago, "The CAVE: A Virtual Reality Theater," On-line, Internet, 18 February 1996, available from <http://www.ncsa.uiuc.edu/EVL/docs/html/CAVE.html>.
- ⁶⁵ Ibid.
- ⁶⁶ *New World Vistas*, (unpublished draft, the information technology volume), C-6–C-7.
- ⁶⁷ Peterson, 46.
- ⁶⁸ Ibid. 32.
- ⁶⁹ A senior US Air Force policymaker lecture given to the 2025 Study under the promise of nonattribution.
- ⁷⁰ George I. Zysman, "Wireless Networks," *Scientific American* 273, no. 3 (September 1995): 51.
- ⁷¹ Negroponte, 64.
Rogers, 122.
- ⁷² Negroponte, 64.
Rogers, 124.
- ⁷³ *New World Vistas*, (unpublished draft, the information technology volume), 38.
- ⁷⁴ Thomas, 41.

Chapter 4

System Description

The vast array of technologies, concepts, and innovations in the previous chapter described the pieces that must be integrated to form the “Cyber Situation Vision.” As seen in fig 4.1, the Cyber Situation Vision provides a commander with an “eye to see” all within a given battlespace.

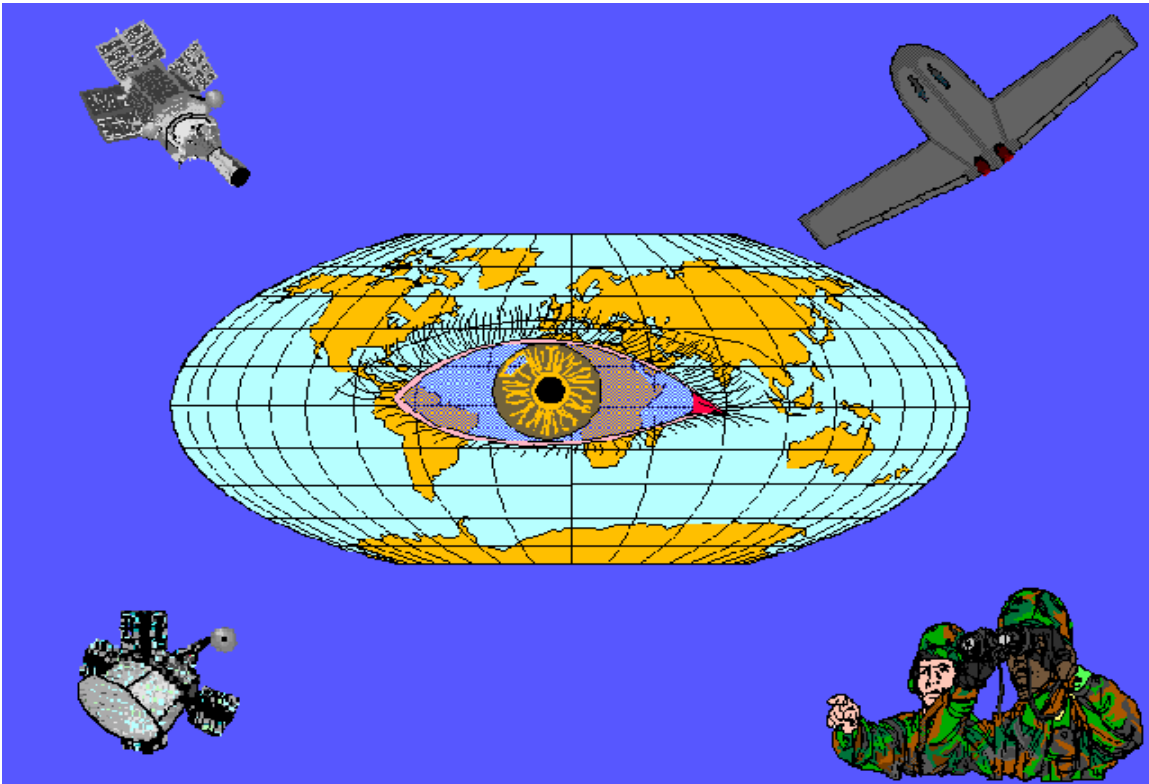

Source: MSgt Gordon Morrison, CADRE/EDECT, Gunter Annex, Alabama

Figure 4-1. Cyber Situation Vision: “Eye” See Everything¹

Cyber Situation Components

The Cyber Situation is the integration of the entire OODA Loop Cycle under the control of commanders, decision makers, and analysts. Supporting components include all-source information collectors, archival databases, the Information Integration Center (IIC), a microscopic chip implanted in the user's brain,² and a wide range of lethal and nonlethal weapons.

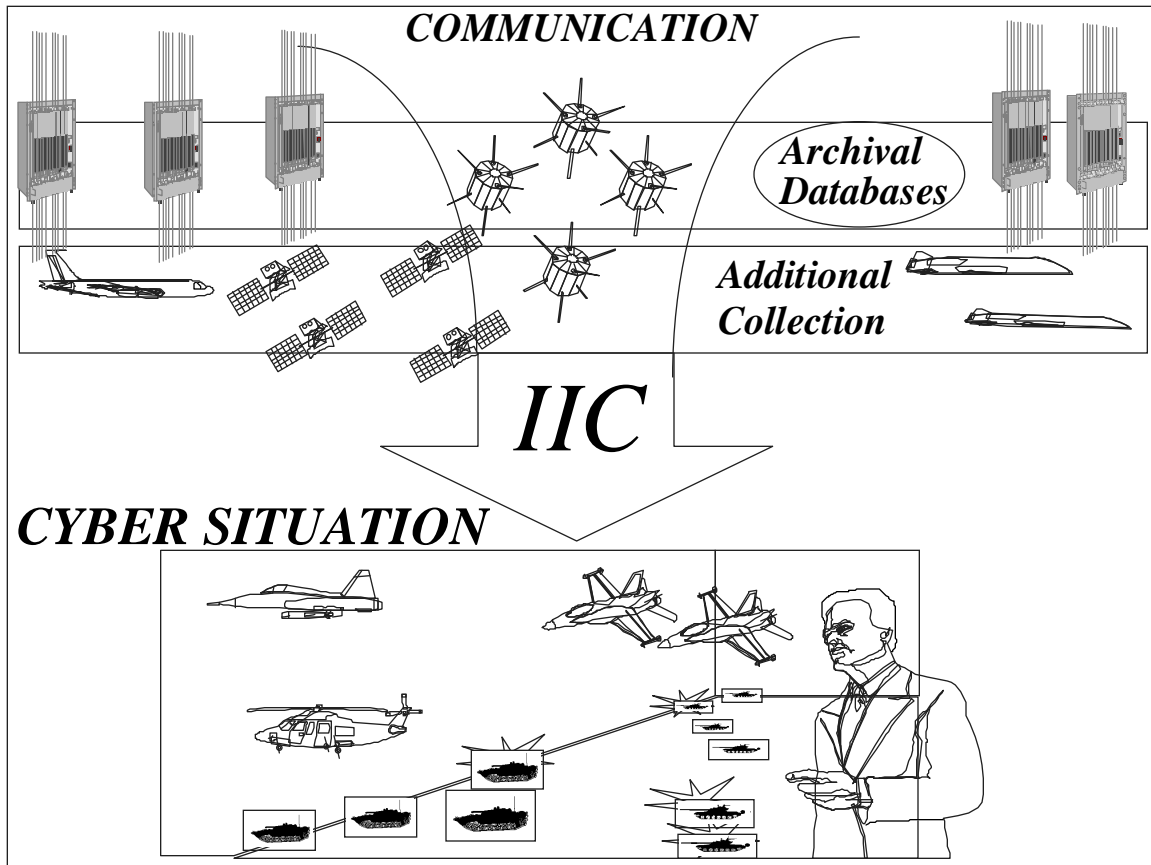

Source: Microsoft Clipart Gallery© 1995, courtesy of Microsoft Corporation.

Figure 4-2. Cyber Situation Components

This chapter first describes the five Cyber Situation system components which could result from technological advances. Next, it relates these advances to each system component (table 5). It then describes Cyber Situation integration and focuses on developing the two key components to achieve information dominance and seamless interface between the users and systems—the IIC and microscopic chip (the third and fourth components). The first two components (information collectors and databases) provide the inputs, while the fifth component (lethal and nonlethal weapons) is the link to the act—the end product that results

from a system that provides battlespace awareness. Finally, this chapter compares and evaluates the system capabilities with the requirements discussed in chapter 2.

Table 5

Technology Areas Versus Cyber Situation Components

Cyber Situation Component	Technology Areas				
	Collection Platform	Communications Infrastructure	Computing Power	Intelligent Software	Human Systems & Biotechnology
All-source Information Collectors	X	X	X	X	
Archival Databases	X	X			
IIC		X	X	X	X
Implanted Microscopic Chip		X	X	X	X
Lethal & Nonlethal Weapons		X	X		

All-Source Information Collectors

All-source information collectors will transmit raw data to the IIC, discussed below. The collectors are linked by way of high-speed relay and dissemination systems. The collection platforms, in air and space, will be numerous and flexible.

Archival Databases

Archival databases will be used for historical analysis and to fill gaps if the information is not available for collection. Much of the archival data will be resident in the GII, while secured permanent ground stations will store classified data.

IIC

The IIC is a constellation of integration or “smart” satellites that receives all-source information. Within the IIC, resident intelligent software will run decision support tools, correlate and fuse data into

useful information, identify inconsistencies and information gaps, and task collectors to seek data to fill information gaps.

Implanted Microscopic Chip

The implanted microscopic brain chip³ performs two functions. First, it links the individual to the IIC, creating a seamless interface between the user and the information resources (in-time collection data and archival databases). In essence, the chip relays the processed information from the IIC to the user. Second, the chip creates a computer-generated mental visualization based upon the user's request. The visualization encompasses the individual and allows the user to place himself into the selected battlespace.

Why the Implanted Microscopic Chip? While other methods such as specially configured rooms, special helmets, or sunglasses may be used to interface the user with the IIC, the microscopic chip is the most viable. Two real operational concerns support the use of implanted chips and argue against larger "physical" entities to access the Cyber Situation.

First, future operations will demand a highly flexible and mobile force that is ready at moment's notice to employ aerospace power. The chip will give these forces the ability to communicate, visualize, and prosecute military operations. Having to manage and deploy a "physical" platform or room hampers mobility and delays time-sensitive operations. US aerospace forces must be prepared to fight or to conduct mobility or special operations anywhere in the world on extremely short notice although some of these operations may be staged directly from the continental United States.⁴

Second, a physical entity creates a target vulnerable to enemy attack or sabotage. A highly mobile information operations center created with the chip-IIC interface makes it much more elusive to enemy attack. These reasons argue against a larger physical entity for the Cyber Situation.

While this is a reasonable portability rationale for the use of chip, some may wonder, "Why not use special sunglasses or helmets?" The answer is simple. An implanted microscopic chip does not require security measures to verify whether the right person is connected to the IIC, whereas a room, helmet, or sunglasses requires additional time-consuming access control mechanisms to verify an individual's identity and level of control within the Cyber Situation.

Further, survey any group of commanders, decision makers, or other military personnel if they enjoy carrying a beeper or “brick” at all times. Likely, few like to carry a piece of equipment. Now, imagine having to maintain a critical instrument that allows an individual to access the Cyber Situation, and thus control the US military forces. Clearly, this is not an enviable position, since the individual may misplace or lose the helmet or sunglasses, or worse yet, the enemy may steal or destroy it. These are unnecessary burdens.

Ethical and Public Relations Issues. Implanting “things” in people raises ethical and public relations issues.⁵ While these concerns may be founded on today’s thinking, in 2025 they may not be as alarming. We already are evolving toward technology implanting. For example, the military currently requires its members to receive mandatory injections of biological organisms (i.e., the flu shot). In the civilian world, people receive mechanical hearts and other organs. Society has come to accept most of these implants as a fact of life. By 2025 it is possible medical technology will have nerve chips that allow amputees to control artificial limbs or eye chips that allow the blind to see.⁶ The civilian populace will likely accept an implanted microscopic chips that allow military members to defend vital national interests. Further, the US military will continue to be a volunteer force that will freely accept the chip because it is a tool to control technology and not as a tool to control the human.

Lethal and Nonlethal Weapons

A wide range of lethal and nonlethal weapons will be linked to the IIC, allowing authorized users to directly employ these weapons. A user’s authority to employ weapons will depend on the person’s position, responsibility, and rank.

Putting It Together

The Cyber Situation is not a traditional operations or command and control center. Not a physical infrastructure, it consists of many components geographically dispersed, redundant, and networked. When an authorized individual needs situational updates and analyses, the user will link to an IIC satellite by way of the implanted chip.

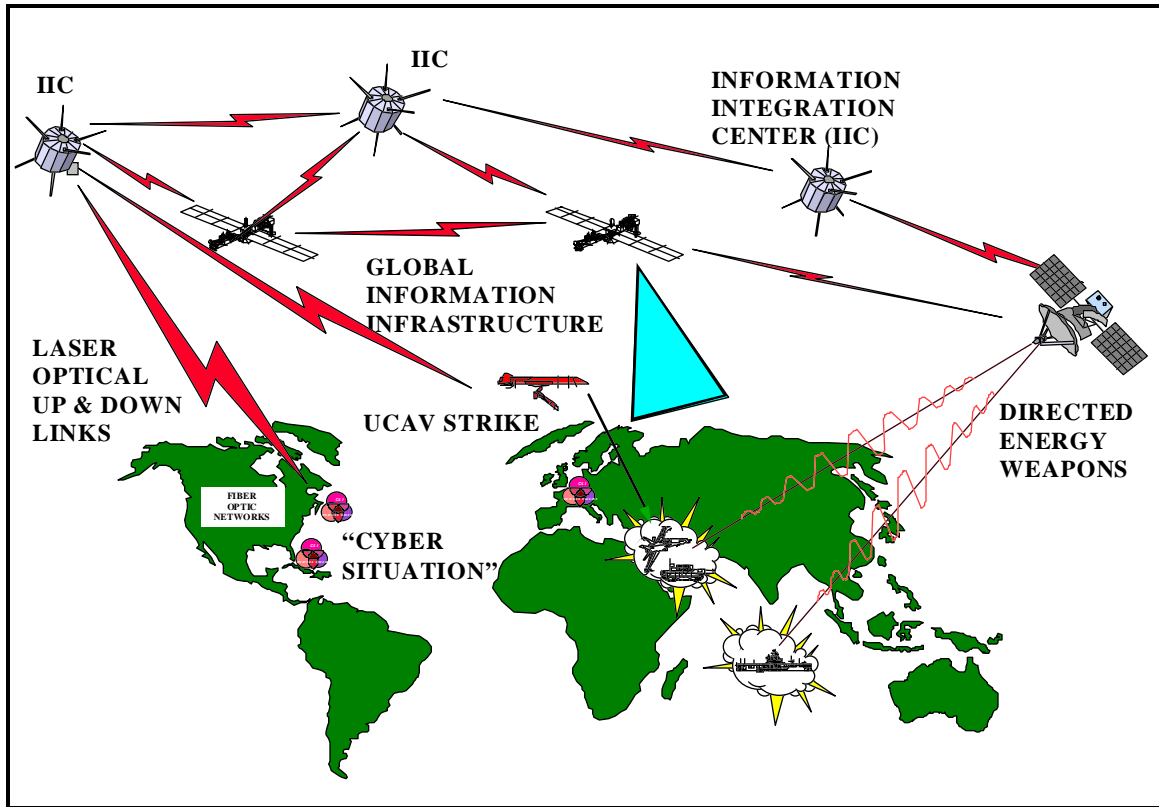

Source: Microsoft Clipart Gallery© 1995, courtesy of Microsoft Corporation.

Figure 4-3. Cyber Situation Connectivity

The Cyber Situation is applicable at all levels of war. At the strategic and operational levels, it provides the user the capability to monitor global activity, analyze developing situations, monitor and control the battlespace, assess battle damage, and conduct reconstitutions. Tactically, the Cyber Situation offers battlespace situational awareness by conveying in-time enemy and friendly information. At all levels, the Cyber Situation gives decision makers and analysts the ability to coordinate, respond, and execute battlespace operations.

Measures of Merit

Thus far, this paper has shown how the five key technology areas (collection platforms, communications architecture and dissemination systems, computer-processing power, intelligent software, and human systems and biotechnology) will logically synergize by 2025 to realize the Cyber Situation vision to enable information dominance. The paper asserts that to achieve this vision, technology must allow military

commanders to integrate the functions of the OODA Loop and enable the military commander to control momentum. Whether Cyber Situation meets the goal is best answered by evaluating the Cyber Situation against the measures of merit developed in chapter 2. The measures of merit encompasses a list OODA Loop tasks with associated attributes that describes how the task should be performed.

Observe Tasks

Table 6
See the Battlespace

Attributes	Yes or No
• Fused, integrated, and deconflicted view of the desired battlespace	Yes
• Sum of all possible information sources	Yes
• System identification of information gaps and subsequent collection of missing information	Yes

The IIC component of the Cyber Situation provides the avenue to meet the attributes of this “see the battlespace” task. The IIC includes an inherent capability to fuse, correlate, and deconflict available all-source information. Further, built into the system description is the ability to identify information gaps. Links allow the IIC to task collection assets to fill information gaps and deconflict contradictory information. If the collection assets are not able to obtain further information, the IIC uses historical archival databases to fill in gaps. Accordingly, the IIC lets the user know the picture’s reliability.

Table 7
Maintain Mobile Battlespace View

Attributes	Yes or No
• Able to pull updated view anytime, anywhere	Yes
• Easily deployable and transportable with user	Yes

Within the Cyber Situation vision, the ability to maintain a “mobile” battlespace picture is perhaps its most significant characteristic. The use of the implanted microscopic chip linked to the IIC allows the user to pull a computer-generated mental visualization of the desired battlespace anytime, anywhere. Further, the

user is not confined to any physical room or platform to enter the Cyber Situation system, making it impenetrable. Even more advantageous, the user has no worry of losing or having someone steal the microchip because it is not a detached physical entity that requires accounting and protection.

Table 8

Universal Access to Battlespace View

Attributes	Yes or No
• Able to tailor picture for relevant AOR, missions, and tasks	Yes
• Many able to see the same battlespace picture	Yes

The IIC allows virtually unlimited number of users to simultaneously access the system because it operates on the user-pull concept. This system’s characteristic allows multiple users to access the same battlespace picture and create a “cyber conference” within the Cyber Situation system. Further, IIC’s resident intelligent software, coupled with taskings transmitted by way of the chip, allows the user to define the battlespace picture dimensions. This process enables the user to tailor the battlespace computer-generated mental visualization to the relevant area of responsibility (AOR), mission, and tasking to prosecute military operations.

Orient Tasks

Table 9

Tailor View of the Battlespace

Attributes	Yes or No
• In-time view of the battlespace	Yes
• Able to define dimensions and locations of battlespace	Yes

Since the IIC uses the most current data to create battlespace picture, the user’s mental visualization will be the most up-to-date information available. As with the previous task, IIC resident intelligent software, coupled with taskings transmitted by way of the microscopic chip, allows the user to define the battlespace picture dimensions.

Table 10

Comprehend the Battlespace View

Attributes	Yes or No
• Eliminate biased inputs from one person to another	Yes
• Eliminate need for mental picture based on another's biases	Yes
• Able to query for further information and receive in-time answers	Yes

Commanders using the Cyber Situation system receive battlespace information that is less biased than the same information when conducted by human processing, interpretation, and presentation. Further, the system minimizes the need for the commanders to mentally reconstruct the information presented by analysts and briefers. If the users sense the battlespace picture does not logically compute, or if they just want additional information, they may request the IIC confirm the situation. The IIC then tasks additional collection assets to seek further data and searches the archival database for further analysis.

Decide Tasks

The IIC acts both as a receiver and as a transmitter. As a receiver, it accepts data from collection assets, users' queries for additional information, and commander's orders to employ remote weapons, space-based lasers, and UCAV. As a transmitter, it responds to users' information requests, prompts users of significant events, tasks collection assets, and relays orders from the users to space based lasers and UCAV to employ weapons. Within the transmitter and receiver components of the IIC, intelligent software automatically filters, sorts, and prioritizes data for processing and fusing. Ultimately, the IIC prompts the user of significant event and the user decides whether action is required for the situation.

Table 11

Decide What is Important and What May Require Action

Attributes	Yes or No
• Decision support tool in transmitter and receiver to filter, sort, and prioritize	Yes
• Prompts user of significant events for monitoring and action	Yes

As a decision aid, the Cyber Situation system allows users to model outcomes of potential actions and inactions to determine the optimum course of action. The modeling process lets the user best apply precision force at the least risk to friendly forces to achieve military objectives.

Table 12

Determine Action Required to Rectify Undesirable Situation

Attributes	Yes or No
• Model effectiveness of potential actions and inactions with in-time feedback	Yes
• Optimize application of precision force	Yes
• Ensure least risk to friendly forces	Yes

Act Tasks

The IIC will be linked to such lethal and nonlethal assets as space-based laser and various UAV. The authorized user will have immediate access to these assets to rectify an undesirable situation. Precision-force assets could allow users to optimize weapons to achieve one shot and one kill.

Table 13

Immediate Access to Assets to Rectify Undesirable Situation

Attributes	Yes or No
• Ready lethal capabilities for employment	Yes
• Ready nonlethal capabilities for employment	Yes
• One shot, one kill capability	Yes

Upon taskings from authorized users to employ space-based laser assets and UAV, the IIC also will task collection assets to accumulate data from the target. The IIC then processes and analyzes the data to provide in-time feedback to the users. It also recommends additional actions if the target is not satisfactorily affected.

The Cyber Situation system could change dramatically how commanders process information and take action or cycle information through the OODA Loop. To be effective, the Cyber Situation system be optimized to minimize vulnerabilities. The next chapter reviews those potential weaknesses and countermeasures.

Table 14

Feedback on Actions and Inactions Taken

Attributes	Yes or No
• See in-time mission results	Yes
• System recommends additional action or inaction	Yes

¹ Special thanks to MSgt Gordon Morrison, CADRE/EDECT, The Extension Course Institute, Air University, Gunter Annex, Maxwell AFB, Ala., for his depiction and creation of the “Cyber Situation,” 25 March 1996.

² 2025 Concept, No. 900702, “Implanted Tactical Information Display,” 2025 Concepts Database (Maxwell AFB, Ala.: Air War College/2025, 1996).

³ 2025 Concept, No. 200169, 2025 Concepts Database (Maxwell AFB, Ala.: Air War College/2025, 1996).

⁴ Peter Grier, “New World Vistas,” *Air Force Magazine*, March 1996, 20.

⁵ Anonymous assessor comment on 2025 Concept Identification 900702, 2025 Concept Database (Maxwell AFB, Ala.: Air War College/2025, 1996).

⁶ John L. Peterson, *The Road to 2015*, Waite Group Press (Corte Madera, Calif. 1994), 63.

⁷ Col Joseph A. Engelbrecht, Jr., 2025 research director, and professor of Conflict and Change, Air War College, Maxwell AFB, Ala., personal interview with Major Whitehead, 17 March 1996. Colonel Engelbrecht explains that “Eliminating human biases may be impossible. Since the decision is reserved for the commander or decision maker, the potential for bias may always remain. On the other hand, communication theory and prospect theory from psychology suggest the importance of how the message is “framed.” Framing the message can set up a bias in the human receiver. Thus, potentially, technology should be able to help by providing alternate frames or contexts or highlighting a perspective highly relevant for the data and circumstance. While designing the technology to meet the challenge may be difficult, if it is not pursued humans may be trapped in a noisy cacophony of inputs that become screened or skewed simply because little progress has been made in human-machine interfaces.”

Chapter 5

Vulnerabilities and Countermeasures

Identifying vulnerabilities of the Cyber Situation and its associated components, then developing potential countermeasures, leads to additional features and attributes that should be integrated into the Cyber Situation requirement list. This chapter begins by identifying vulnerabilities of the Cyber Situation and then states possible countermeasures that eliminate the vulnerabilities.

Vulnerabilities

Numerous vulnerabilities of the Cyber Situation system and its associated components exist. The vulnerabilities naturally fall into three primary categories — man-made threats (space debris and offensive weapons), environmental threats (meteors, asteroids, and radiation), and human threats (capture, defection, and espionage).

The first threat area, man-made, generally designed to destroy, disable, or degrade its targets. The effects may be either permanent or temporary and may consist of hard and soft attacks. Adversaries achieve “hard kills” by physical destruction of the Cyber Situation through destruction of system components. Specific methods of attack may include antisatellite weapons, electromagnetic pulse (EMP) weapons, and nuclear detonation devices. Conversely, “soft kills” attack the internal logic within the operating capability. An example of soft attack is syntactic attacks of the operating logic inside the IIC and collection computers. The resultant loss or decrease in effectiveness, if not replaced in a timely manner, will have dire consequences on military operations.

Less obvious military vulnerabilities come from the second threat area, environmental, which includes solid debris that disintegrated or decomposed from celestial or man-made materials. Expert views differ as to whether asteroids really pose enough of a problem to develop defenses against the threat.¹ Nevertheless, the threat results from the kinetic energy produced by the projectiles roving through space at rapid velocities. Even the smallest fragments pose a potential threat to IIC and satellite collectors. Other environmental threats include radiation and charged particles which come primarily from the sun. These “space weather” effects may be gradual or instantaneous. These effects are usually difficult to detect until after catastrophic failure.

The last threat area involves people and can be subdivided into two categories: the capture of our people implanted with the microscopic chip and the espionage and defection to the enemy side. All three categories of threats (man-made, environmental, and people) will destroy, disable, or degrade our ability to perform tasks that support our core capability of information dominance.

Countermeasures

Countermeasures include both passive and active activities that can be used against a variety of threats. The following paragraphs describe several activities and discuss their effect on vulnerabilities.

Distributed System Architecture

The defensive goal behind the use of a distributed system architecture for the IIC is to deny the enemy a center of gravity to attack. In other words, use of this type of architecture will deny the enemy the IIC as a target that if destroyed “would cause a system failure or cascading deterioration within the system,” allowing the enemy to achieve its objective.²

The network of IIC satellites are interconnected using the “star” interconnectivity, which has lines radiating out from each satellite to other satellites (fig. 5-1).³ Essentially, the satellite constellation forms a “mesh” over the earth’s atmosphere.⁴ The interconnected mesh allows for graceful degradation so that if the enemy physically destroys a percentage of the IIC, it does not lead to a total loss of effectiveness. Further,

because of the interconnectivity, the mesh knows to compensate and fill in the gaps created by the destruction. The mesh has no center of gravity so if the adversary wants to defeat the IIC, it must be destroyed in total.⁵

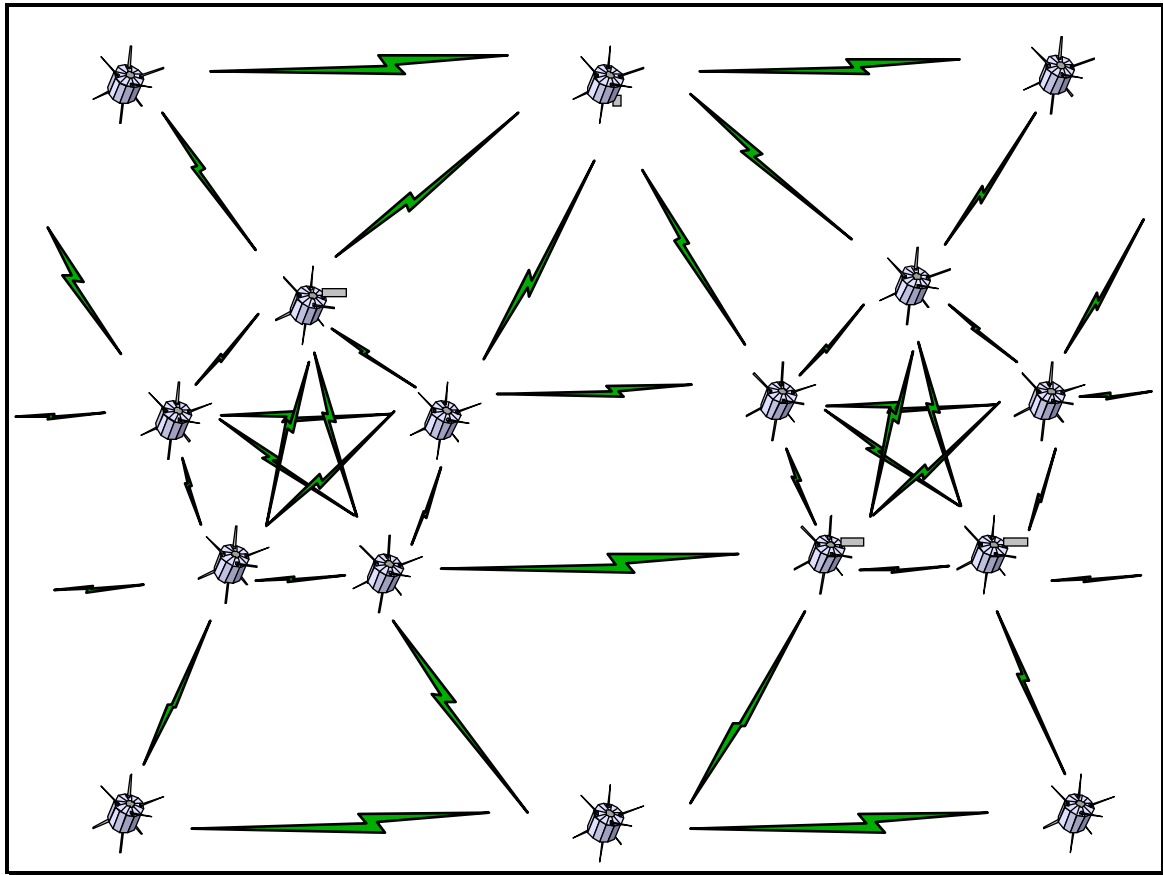

Source: Microsoft Clipart Gallery© 1995, courtesy of Microsoft Corporation.

Figure 5-1. Information Integration Center Interconnectivity

The “Small and the Many”

Components that feed information and support the IIC will be composed of many inexpensive sensors, emitters, microsats, and miniprojectiles. Similarly, the IIC mesh also consists of many small satellites (minisats) that are inexpensive and easy to launch. Current minisat development and designs produced satellites that weigh several hundred pounds and measure about three cubic feet. Recent advancements in electronics and miniaturization have given impetus to smallsat concepts that weigh approximately 20 to 30 pounds and are smaller than shoe boxes.⁶

The qualities of redundancy, miniaturization, and low cost will describe future components that make up the IIC. The “small and the many” concept results in a system that is redundant and difficult to completely

destroy.⁷ Like the IIC concept, this concept allows the enemy no center of gravity to target, therefore, no single point of failure. Further, even if adversaries destroy a portion of the network, it will still survive and operate.

“Smart” System

Inherent in the IIC system is the built-in capability to fuse, correlate, and, most importantly, *deconflict* contradictory inputs and data points. Therefore, when adversaries attempt information warfare by injecting false statements (syntactic attacks) into the logic tree, the computing system within the IIC will recognize the inconsistencies and deconflict them. The IIC consists of a body of knowledge and an “ability to learn” to know when a possible conclusion is invalid or simply does not make sense.⁸ When the IIC detects inconsistencies, it will seek additional data either to validate or invalidate its own conclusions.

If the individual attempts to enter a particular Cyber Situation when the IIC concludes there are invalid resolutions, it will inform the user of the potentially false inputs and its attempt to resolve the data confliction. If the individual desires, the IIC will show the conflicting data and why a possible conclusion is invalid.

Optical Computing

Much research continues in this area of optical networks to transmit, receive, and store information. The technology appears promising and at minimum would seem a plausible radiation defense.⁹ The use of optical computing in the IIC (to receive inputs from other collectors and users, to respond to users’ requests to develop the Cyber Situation picture, or to task lethal and nonlethal assets) would serve as protection against radiation threats. Radiation attacks systems that use electrons to transmit data. Since optical computing employs photons instead of electrons, these photons render optical computing systems safe from EMP threats.

Low Earth Orbit

Employing the IIC in a low earth orbit (LEO) will minimize exposure to environmental radiations. Compared to other orbits, the LEO naturally is exposed to lower levels of radiation. By contrast, medium orbits have the highest levels of radiation, primarily caused by the Van Allen Radiation Belts, while at the geosynchronous orbit, the radiation level is higher than the low-earth orbit but lower than the medium orbit.¹⁰

Internal Deactivation

If captured by the enemy, users with the implanted microscopic chip may self-deactivate the chip and render it useless. Further, the chip disintegrates and cannot be extracted by the enemy for reverse engineering or for adversarial reasons.

External Deactivation

When faced with the disturbing events of espionage and defections of friendly users to the enemy side, the IIC is engineered with the capability to deactivate and disintegrate the offender's implanted chips. The highest level commanders within the US military have the authority to access the IIC and order the system to deactivate the defectors' chips the next time they try to activate the Cyber Situation.

“Zap” Attack

“Zap” attack relies on the decision-support technology built into the IIC and its link to space-based laser weapons. As individual satellites within the IIC network sense an object (man-made or environmental) moving toward its network, the IIC will compute the object's directional objective, velocity and acceleration, and Doppler shift to determine whether it is a threat. If the decision is affirmative, the IIC will instruct the nearest space-based laser weapon to destroy the object and eliminate the threat to the IIC system.

“Mutual Dependence”

Once implanted, the microscopic chip will operate only when the individual is alive because the chip creates mutual dependence on its host. In the unfortunate circumstance where a Cyber Situation user dies, the implanted microscopic chip becomes nonfunctional and disintegrates. This operational dependence of the chip upon its host prevents adversaries from using a chip from a deceased war fighter.

Summary

Table 15 presents a list of threat categories and associated countermeasures that will address each type of threat. Note that each countermeasure may be effective against more than one type of threat.

**Table 15
Countermeasures Versus Threats**

Countermeasure	Threat		
	Man-made	Environmental	Human
Distributed System Architecture	X	X	_____
“Small and the Many”	X	X	_____
“Smart” System	X	_____	X
Optical Computing	X	X	_____
Low Earth Orbit	_____	X	_____
Internal Deactivation	_____	_____	X
External Deactivation	_____	_____	X
“Zap” Attack	X	X	_____
“Mutual Dependence”	X	_____	X

Though numerous vulnerabilities exist with the Cyber Situation, by 2025 effective countermeasures likely will be integrated into the system. Well-developed measures to defeat these man-made, environmental, or human threats can make the Cyber Situation more effective to the war fighter. Chapter 6 goes beyond threats and countermeasures and will explore potential structure and doctrine changes required to achieve and take full advantage of the Cyber Situation.

¹ Anonymous assessor comment on 2025 Paper Draft (Maxwell AFB, Ala.: Air War College/2025, 1996).

² Paul Moscarelli, *Strategic Structures Course Book*, vol 2, *Operational Analysis: An Overview* (Maxwell AFB, Ala.: Air University Press, 1995), 522–23.

³ Nicholas Negroponte, *Being Digital* (New York: Vintage Books, 1995), 33.

⁴ Martin C. Libicki, *The Mesh and the Net* (Washington, D. C.: National Defense University Press, 1994), 3. Libicki defines *mesh* as “the term applied to military applications—points to the holes; as information technology places a finer mesh atop the battlefield, more objects are caught in it.”

⁵ *Ibid.*, 33.

⁶ Air Force Scientific Advisory Board members, review and comments from 2025 Concept Briefings (Maxwell AFB, Ala.: Air War College/2025, 5 February 1996).

⁷ *Ibid.*, 19–37.

⁸ Negroponte, 154–56.

⁹ Vincent W. S. Chan, “All-Optical Networks,” *Scientific American* 273, no. 3 (September 1995): 57–58.

¹⁰ Michael J. Muolo, *Space Handbook: Space Analyst’s Guide*, vol 2 (Maxwell AFB, Ala.: Air University Press, December 1993), 13–14.

Chapter 6

Concept of Operations

Today's breathtaking technological achievements notwithstanding, developing the concept of operations that incorporate new technologies and organizations to permit effective exploitation of new capabilities is even more critical than acquisition of the technologies themselves.

—James R. Fitzsimonds
Revolutions in Military Affairs

This chapter discusses how the Cyber Situation will be implemented and expound on what capabilities the Cyber Situation offers to future war fighters. Implementing the system will require dramatic changes to our present-day organizational structure and doctrine. No doubt some of these changes will appear radical and meet stiff resistance by individuals and institutions unconvinced of the merits the Cyber Situation has to offer to the defense efforts of United States military. History has shown those entities unable or unwilling to adapt to change have, at best, been left behind, and in the worst instances been eliminated as an entity.

To realize the full potential of the Cyber Situation, tomorrow's aerospace forces must devise dramatically different supporting organizations and doctrine in order to fully harvest these innovative new capabilities. As noted in previous chapters, the technology will be available in 2025; it will be the organization and command structures along with the doctrine and concept of operations (CONOP) that will form the second and third legs of the revolution in military affairs (RMA) triad.

Future Conops

War-fighting and conflict management in 2025 will apply the results of improved concepts and technology applications in the areas of surveillance and reconnaissance, command and control, and overall

battlespace execution. As forecast in the 1994 SPACECAST 2020 study, “advances in surveillance and reconnaissance, particularly real-time ‘sensor to shooter’ to support ‘one shot, one kill’ technology, will be a necessity if future conflicts are to be supported by a society conditioned to ‘quick wars’ with high operational tempos, minimal casualties, and low collateral damage.”¹ The Cyber Situation has the potential to be the harbinger of the revolution.

Applications of the Cyber Situation

The Cyber Situation is ideally suited for the command, control, and execution of military operations across the spectrum of warfare from the selective release of nonlethal weapons to the full-scale assault of parallel war. In parallel war, aerospace forces simultaneously attack enemy centers of gravity across all levels of war (strategic, operational, and tactical) at rates faster than the enemy can react.²

Commanders always seek to control the throttle of the OODA Loop, operating faster or slowing the decision cycle of their foes. In past wars, tank commanders and fighter pilots always strove to get “inside the enemies OODA Loop.” The difference in future conflicts will be the speed and scope of their decisions.

Parallel war requires large numbers of highly precise weapons directed against critical nodes. Additionally, they require a requisite level of detail on the enemy situation necessary for precision targeting. For these reasons yesterday’s military commanders could not wage parallel war effectively. The Cyber Situation is ideal for conducting parallel war because it offers capabilities that fill both of these voids.

The Cyber Situation offers tomorrow’s commanders an in-time view of the battlespace, exposing the enemy centers of gravity before his eyes. In 2025 operating at previously unheard of speeds will be a common feature of military engagement. Future warriors by way of the IIC will conduct Cyber Situations utilizing a whole new array of air and space sensors, UCAV, directed energy weapons, and highly mobile expeditionary forces. Operations will be controlled from Cyber Situations in continental US (CONUS) and instantaneously reach out and touch the enemy halfway around the globe.

A CONUS-based joint task force commander, for example, would have well exercised connectivity with combat units through Cyber Situations with CONUS-based stealth bombers, UCAV, and instantaneous

access to space based precision strike weapons. Imagine the psychological effect on the adversary who will be unable to predict where the next blow will fall and will be powerless to defend against it

Command Structure

The 2025 force structure and battlespace requirements will make obsolete traditional hierarchical command and control arrangements. Cyber Situation capabilities require greater decentralization through information technology, growth of distributed systems and establishment of virtual organizations.

New information and communications technologies are shifting power to those with the most powerful computers and most effective sensors . . . at the same time, the punch packed by the individual soldier is increasing, eroding the role of field commanders and resulting in flatter command and control structures.³

The Cyber Situation allows greater emphasis to be placed on decisive decision making, precision engagement, high-speed and synchronized maneuver, agility, and enhanced command and control. The command structure will have freedom of operation within previously identified parameters much like the vaunted German decentralized, flexible command style known as *Auftragstaktik* (mission tactics). This method of battlefield command has enabled smaller forces to defeat much larger ones through a timely ability to seize the initiative and act according to “on the spot” judgment. The German breakout at Sedan, resulting in the fall of France in 1940 offers a familiar example of the successful employment of this flexible command philosophy.⁴

The war fighter must have access to a broad range of supporting weapons, improved mobility, survivability, and supportability—these changes that reflect a dramatically flattened command structure staffed by an extremely high caliber individual at every level. As the battlefield becomes less dense and more decentralized, the demands on small unit leaders increase. The flattened structure permits power to be defused and redistributed, often to subordinate actors. The overall impact is that the flow of information, and its associated awareness and knowledge, compels closed systems to open, eliminating many layers of the cumbersome and compartmented intelligence and analysis bureaucracy. The traditional emphasis on command and control will give way to an emphasis on consultation and control. This organizational structure permits the Cyber Situation to operate at maximum efficiency. It allows commanders at all levels to operate with greater latitude and autonomy as part of an integrated joint operation—a truly combined arms.

Principles of War

The Cyber Situation will provide enormously enhanced capabilities and opportunities for the war fighter, but it will not alter the fundamental principles of war--objective, offensive, mass, economy of force, maneuver, unity of command, security, surprise, and simplicity. These nine principles guide war-fighting at all levels of warfare and have withstood the test of time and will endure in 2025 as the bedrock of US military doctrine.⁵ The Cyber Situation optimizes the principles of offense, mass, and maneuver, enabling the commander to execute a wide array of precision weapons from CONUS across the spectrum of warfare at a single decisive point or a parallel attack against multiple critical nodes. The following section depicts the Cyber Situation in action in a hypothetical 2025 scenario.

A Future World

(12 March, 2025--1435 EST/2045Z) The persistent flashing blue light at the corner of his vision alerted the CJCS that the NMCC was initiating a category II ALERT, the blue code for International, Domestic. As the chairman made himself comfortable, he double-blinked rapidly to set in motion his Cyber Situation. As his computer-generated mental display command center whirled into being before his eyes, his mental display--the message that started the ALERT--became operational. CINCSOUTH's image appeared and began briefing.

The government of Argentina was asking for help in conducting a hit on a narcoterrorist group hidden within a room in the center of the Zircon building, a 50-story skyscraper building in downtown Buenos Aires. The Argentina government is worried because the building also contains thousands of civilians unaware of the terrorists' presence. A moment's thought and the topographical detail map of Buenos Aires floats into view. As the CJCS studied the map from all angles, zeroing in on the Zircon building, the other major players "stepped" one by one into the "Cyber conference." The NCA, along with the unified CINCs, service chiefs, and State Department representatives all studied the unfolding three-dimensional schematics of the Zircon building within their own personal "cyberspace." Weather reports began to come in, indicating a storm raging off the coast in Tierra Del Fuego with winds NNE at 35 miles per hour. Light rain was falling in and around Buenos Aires. Now the CJCS moved into the "Cyber Situation" of the intelligence analyst that had been monitoring the situation. DNA and heat-sensing probes of the Zircon building were built into a three-dimensional map that pin-pointed the location of the terrorists on the 23rd floor in the offices of the Argentina Spaceways Co. Two floors above, a local telecommunications company was hosting an AT&T International conference. Local police already had sealed off the outer sectors of the building.

After studying the situation, the CINCSOUTH then ordered the execution of Operation Red Ball One--Option 2, with the CJCS approval. At this point the CSAF took over the "Cyber Situation" and entered the "Cyber-space" of the ACC commander. Together, they reviewed the life-like images that appeared before them marking US

Aerospace bases. Beside each image were the unit's designator, manning level, and current activity. For the execution of Red Ball One--Option 2, after consulting his crisis action staff, the ACC commander decided to precision drop three squads of Space Marines from a TC-4 Globemaster on to the roof of the Zircon building. The Cyber Situation now included the colonel in charge of the 3d Special Operations Group the squadron commander of the Space Marines at Hurlburt Field, Florida, and the Globemaster wing commander at Eglin AFB, Florida. Together, they reviewed the prevailing weather conditions, where the wind and rain could affect operations. Next, they reviewed the computer-generated mental display schematics of the Zircon building, deciding where best to precision drop the squads, mapping out the ins and outs of the stairways and speed lifts of the building. Each of the three squad leaders of the Space Marines entered the "Cyber Situation" for a detailed briefing of the Zircon building's many exits and entries. They discussed the placement of portable force-field shields to isolate the floor and at what point the various nonlethal weapons would be used. One of the Marines suggested using an ultra-high frequency wave burst as the best method to subdue the terrorists with the fewest losses. The TAV-4 pilot and crew, already part of the Cyber Situation, once more reviewed the weather, adjusted for winds, and with the squadrons aboard, launched.

The CINC and others watched the outcome of the operation in their "Cyber Situations," noting the success of the precision drop and the excellent execution of the Space Marines in avoiding detection by the terrorists, while keeping the civilians calm. The success of the frequency wave burst earned the suggesting Space Marine a merit promotion and the entire operation the Argentine government's heartfelt thanks.

Notes

¹ SPACECAST 2020, "Leveraging the Infospace: Surveillance and Reconnaissance in 2020" (Maxwell AFB, Ala.: Air University Press, June 1994), 1.

² Jeffrey R. Barnett, *Future War: An Assessment of Aerospace Campaigns in 2010* (Maxwell AFB, Ala.: Air University Press, 1996), 6.

³ Institute for National Strategic Studies, *Strategic Assessment 1995: US Security Challenges in Transition* (Washington, D. C.: National Defense University Press, November 1994), 16.

⁴ Robert Allan Doughty, *The Breaking Point: Sedan and the Fall of France, 1940* (Hamden, Conn.: Archon Books, 1990), 3.

⁵ Joint War-fighting Center Doctrine Division, *War-fighting Vision 2010: A Framework For Change* (Langley AFB, Va.: 1 August 1995), 2.

Chapter 7

Investigation Recommendations

This chapter discusses areas of concerns requiring increased R&D and time investment. First, it articulates specific shortfalls and identifies commercial and military solutions. Second, it identifies broader issues that will develop with the overall implementation of the Cyber Situation.

Some elements of the Cyber Situation have progressed further in the development process than others. By 2025 the communications architecture will be sufficiently robust to support the Cyber Situation. This will occur because of significant commercial investment as the civilian sector's insatiable appetite for increasingly rapid access to data facilitates greater profit for those who provide it. The military will likely be an investment partner in communications advances.

Computer power will continue to progress, doubling about every 18 months until the turn of the century. Again, the commercial sector will take the lead with the military purchasing adequate computer power "off the shelf."

Current development in other areas is not as advanced and will therefore require greater emphasis to mature at a comparable rate. Intelligent software is becoming more commonplace and its application more widely implemented. However, currently available intelligent software has narrow application and is neither very complex nor does it possess suitable capacity. To achieve the military requirements of the Cyber Situation, allocation of R&D funding must continue to increase the pace of development in intelligent software applications.

Finally, 2025 intelligence collection requires technology advances in both computer power and intelligent software but currently is more affected by the developmental limitations in intelligent software. Commercially available intelligence software is proliferating and will augment products developed and

managed by the military. However, development of small satellites, both capable of short duration intelligence gathering as well as the ability to cover communication gaps, will require the infusion of scarce military dollars to supplement private sector investment.

The following are other, broader issues that require attention. First, the developmental technologies required by the Cyber Situation must have a more effective linkage. Since each of the capability areas required by the Cyber Situation is developing on a separate path, the synergistic effect of combining these areas might better achieve the goal of complete OODA integration.

Second, research into the functions of the brain must be encouraged and accelerated. This is a new area for both the medical community and the military. The research effort must focus on the capacity and interface within the brain and how information is processed in going from raw input to final decision.

Third, social and cultural biases to a brain implanted decision tool must be overcome. The Cyber Situation is designed to assist, *not* control each decision maker. To fully exploit growing technology, cumbersome hardware and software requirements must be reduced to the simplicity and seamlessness of a chip implant. With that technology in hand, the Cyber Situation can become a reality.

Chapter 8

Conclusion

The Cyber Situation makes the entire OODA Loop available to the commander in one location. It provides observation through the collection platforms, the IIC, and the computer chip. It orients the user using the IIC, the archival databases, and the brain chip. These are neither new nor revolutionary capabilities provided to the commander. Senior decision makers throughout time have had access to the orient and observe portion of the OODA.

Where the Cyber Situation provides a unique orient and observe capability to the commander is the rapidity in which a decision maker has access to a complete picture. Before the Cyber Situation linked the collectors and analysis tools in one step, each event was accomplished singly. Collectors were tasked and controlled by one group and the analysis occurred elsewhere. The collected and analyzed information then had to be briefed or presented to the commander who applied his own analysis to the information and determine his own solution. This information could (and often did) come to the commander incomplete or with biases attached. The Cyber Situation cuts through the processing and provides the commander with an in-time picture from which he can observe and orient to an unbiased and a complete picture.

With the commander fully informed, the Cyber Situation helps with the decision process. The Cyber Situation is designed to be a *decision aid* not a *decision maker*. This none-too-subtle difference confirms that, as conceived, the capability resident in the Cyber Situation is designed to facilitate the best possible decision from a human, who will always be in the loop. Options available to commanders for any situation will be clearly displayed and evident to them; they can select one or seek additional information from the Cyber Situation before proceeding.

It is in the final area of the OODA Loop, the act, where the Cyber Situation provides true added value. Once the commander has fully observed, oriented, and reached a decision, action can occur. The full impact of this full spectrum of the OODA Loop cannot be over stated.

Prior to the full deployment of the Cyber Situation, even the best complete strategic OODA cycle will continue to take hours or days. Providing the commander with the information needed to reach the point of action meant collecting the right data, putting it in the hands of the right analyst, and providing that information to the commander. This is a cumbersome process at best, often overcome by events before the information was forwarded to the right decision maker. Since there was a time-consuming structure in place, information was unavoidably dated (even the freshest information is minutes old) and often incomplete. Thus, even under the most terrific circumstances, the commander was making a decision and perhaps employing forces without the best information.

Not only was the information incomplete, decision makers often contemplated as to whether the information their subordinates provided was reliable and credible. With the capability provided by the Cyber Situation, the information accuracy will be reliable and credible. Further, decision makers will have unobstructed access to information. In short, a decision can finally be made *with a complete picture of the battle space*.

Once a decision had been reached, the commander transmits execution orders. These orders must be properly formatted and transmitted to subordinate units for action. Again, there is an unavoidable time lag between when the orders are transmitted and when they are acted upon. In these precious hours, the situation the commander desires to effect can change dramatically.

With the capability provided by the Cyber Situation, the commander can employ forces instantly and flexibly. Whether the weapon of choice is a laser, UAV, or F-22, through the Cyber Situation the commander has instant access to it.

What is even more compelling about the capability available through the Cyber Situation is that with the exception of the brain chip, the technologies required to field it are well along in development in 1996. Communications architectures are growing in both commercial and military applications and computer power is still on an exponential growth rate. Software, too, is becoming more intelligent. Indeed, the required capability is on the horizon.

In the end, the development of the Cyber Situation becomes a matter of priorities and trade offs. The question that must be asked at the highest levels in the Department of Defense is whether or not bits are as important as bullets and how the DOD budget dollar must be spent to satisfy the operational requirements for air power in 2025. If what is required is the capability to provide the commander with all the information and tools to act on a decision, then the Cyber Situation is the solution.

Appendix A

List of Acronyms and Abbreviations

ARPA	Advanced Research Project Agency
ACC	Air Combat Command
AOR	area of responsibility
CRT	cathode ray tube
CJCS	chairman, joint chiefs of staff
CSAF	chief of staff, US Air Force
C ⁴ I	command, control, communications, computers, and intelligence
CINC	commander in chief
SOUTHCOM	commander in chief, Southern Command
CONUS	continental United States
DNA	deoxyribonucleic acid
DOD	Department of Defense
DSB	direct satellite broadcast
EEG	electroencephalograph
EMP	electromagnetic pulse
GII	Global Information Infrastructure
HCI	human computer interaction
IU	image understanding
IIC	Information Integration Center
I3	intelligent integration of information
JTF	joint task forces
MII	Military Information Infrastructure
MLS	multilevel security
NCA	National Command Authority
NII	National Information Infrastructure

NMCC	National Military Command Center
NWV	New World Vistas
OODA	observe, orient, decide, and act
PDA	planning and decision aids
R&D	research and development
RMA	revolution in military affairs
TAV	transatomospheric vehicle
UAV	uninhabited aerial vehicles
UCAV	uninhabited combat aerospace vehicles
URAV	uninhabited reconnaissance aerospace vehicles

Bibliography

- Advanced Projects Research Agency. *Intelligent Systems*. On-line, internet, 23 July 1995, available from http://www.arpa.mil/sisto/Overview/Intel_Thrust.html.
- Advanced Projects Research Agency. *The SISTO Solution: Intelligent Software Systems*. On-line, internet, 23 July 1995, available from <http://www.arpa.mil/sisto/Overview/Solution.html>.
- AFM 1-1. *Basic Aerospace Doctrine of the United States Air Force*. 2 vols., March 1992.
- 2025 Concept, No. 200169. 2025 Concept Database Maxwell AFB, Ala.: Air War College/2025, 1996.
- 2025 Concept, No. 900272, "Very High Altitude Balloon-Borne Systems,." 2025 Concepts Database Maxwell AFB, Ala.: Air War College/2025, 1996.
- 2025 Concept, No. 900280, "Fly on the Wall." No. 900434, "Airborne Sound Sensors." 2025 Concepts Database Maxwell AFB, Ala.: Air War College/2025, 1996.
- 2025 Concept, No. 900438, "Ultraendurance High-Altitude Ocean Loitering Uninhabited Reconnaissance Vehicle." 2025 Concepts Database Maxwell AFB, Ala.: Air War College/2025, 1996.
- 2025 Concept, No. 900517, "JSTARS Replacement." 2025 Concepts Database Maxwell AFB, Ala.: Air War College/2025, 1996.
- 2025 Concept, No. 900552, "On-demand Tactical Recce Satellite Constellation." 2025 Concepts Database Maxwell AFB, Ala.: Air War College/2025, 1996.
- 2025 Concept, No. 900604, "UAV Constellations," 2025 Concepts Database Maxwell AFB, Ala.: Air War College/2025, 1996.
- 2025 Concept, No. 900702, "Implanted Tactical Information Display." 2025 Concepts Database Maxwell AFB, Ala.: Air War College/2025, 1996.
- Air Force Executive Guidance* (draft), HQ USAF/XOXS, December 1995.
- Amato, Ivan. "Animating the Material World." *Science* 225 (17 January 1996).
- Anonymous assessor comment on 2025 Concept, No 900702. 2025 Concept Database. Maxwell AFB, Ala.: Air War College/2025, 1996.
- Anonymous assessor comment on 2025 Paper Review Maxwell AFB, Ala.: Air War College/2025, 1996.
- Army Space Institute. "Space Support in Mid-Intensity Conflict." In *Theater Air Campaign Studies Course Book*. Vol. 8. Maxwell AFB, Ala.: Air University Press, 1995.
- Baird, Lt Col Henry, et al. "Spacelift." 2025 White Paper. Air University, Maxwell AFB, Ala., April 1996.
- Barnett, Jeffery R. *Future War: An Assessment of Aerospace Campaigns in 2010*. Maxwell AFB, Ala.: Air University Press, 1996.
- Bass, Thomas A. "Gene Genie." *Wired*, August 95.
- Carmichael, Lt Col Bruce, et al. "STRIKESTAR 2025." 2025 White Paper. Air University, Maxwell AFB, Ala., April 1996.
- Chan, Vincent W. S. "All-Optical Networks." *Scientific American* 273, no. 3 (September 1995).

- Clinton, William J. *A National Security Strategy of Engagement and Enlargement*. Washington, D. C.: The White House, February 1996.
- Doughty, Robert Allan. *The Breaking Point: Sedan and the Fall of France, 1940*. Hamden, Conn.: Archon Books, 1990.
- Electronics Visualization Laboratory, University of Chicago at Illinois (No date). *The CAVE: A Virtual Reality Theater*. On-line, internet, no date, available on <http://www.ncsa.uiuc.edu/EVL/docs/html/CAVE.html>.
- Engelbrecht, Col Joseph A. 2025 Research Director, and Professor of Conflict and Change, Air War College. Maxwell AFB, Ala. Personal interview by Maj YuLin Whitehead, 17 April 1996.
- Firschein, Oscar, and Thomas Strat *Image Understanding Program*. On-line, internet, 23 July 1995, available on <http://www.arpa.mil/sisto/Overview/Image.html>.
- Fitzsimonds, James R., and Jan M. Van Tol. "Revolutions in Military Affairs." *Joint Forces Quarterly*, no. 4 (Spring 1994).
- Fogleman, Gen Ronald, lecture to 2025 participants. Air University. Maxwell AFB, Ala., 13 February 1996.
- Fukuyama, Francis. RAND Corporation, Washington D. C. Electronic mail. Subject: Dross and Gold, 27 December 1995. Used by permission of author.
- Garvey, Dr Tom. *Planning and Decision Aids Program*. On-line, internet, 23 July 1995, available from on <http://www.arpa.mil/sisto/PDA.html>.
- Grier, Peter. "New World Vistas." *Air Force Magazine* 79, no. 3 (March 1993).
- Gunning, David. *Intelligent Integration of Information (I3)*. On-line, internet, 23 July 1995, available from on <http://www.arpa.mil/sisto/I3.html>.
- Institute for National Strategic Studies. *Strategic Assessment 1995: US Security Challenges in Transition*. Washington, D. C.: National Defense University Press, November 1994.
- Jefts, Maj Barbara, et al. "Virtual Integrated Planning and Execution Resources System: The High Ground of 2025." 2025 White Paper, Air University, Maxwell AFB, Ala., April 1996.
- Joint War-fighting Center, Doctrine Division. *War-fighting Vision 2010: A Framework For Change*. Langley AFB, Va.: 1 August 1995.
- Kalmanek, Charles, and K. G. Ramakrishnan. "On-line Routing for Virtual Private Networks" (Paper presented at the Third International Telecommunications Symposium, September 1995). On-line, internet, September 1995, available on <http://www.research.att.com/hgs/infocom95/program.html>.
- Kolarov, Aleksandar, and Joseph Hui. "Least Cost Routing in Multiple-Service Networks: Part II" (Paper presented at the Third International Telecommunications Symposium, September 1995). On-line, internet, September 1995, available on <http://www.research.att.com/hgs/infocom95/program.html>.
- Krepinevich, Andrew F., Jr. "The Military-Technical Revolution: A Preliminary Assessment." In *War Theory Course Book*. Vol. 3. Maxwell AFB, Ala.: Air University Press, September 1995.
- Libicki, Martin C. *The Mesh and the Net: Speculation on Armed Conflict in a Time of Free Silicon*. Washington, D. C.: National Defense University Press, 1994.
- McGinnis, Lt Col Michael L., and Maj George F. Stone III, "Decision Support Technology." *Military Review* 74, no. 11 (November 1994).
- McKittrick, Jeffrey, et al., "The Revolution in Military Affairs." In *Air War College Studies in National Security: Battlefield of the Future*. No. 3. Maxwell AFB, Ala.: Air University Press, September 1995.
- McMillan, Lt Col James. Air Force Liaison to National Security Agency. Telephone interview by Maj Scott Bethel, 26 February 1996.

- Moscarelli, Paul. "Operational Analysis: An Overview," In *Strategic Structures Course Book*. Vol. 2. Maxwell AFB, Ala.: Air University Press, 1995.
- Muolo, Maj Michael J. *Space Handbook; An Analyst's Guide*. Maxwell AFB: Air University Press, 1993.
- Negroponete, Nicholas. *Being Digital*. New York: Vintage Books, 1995.
- Norman, Maj Cindy, et al. "Man In the Chair." 2025 White Paper, Air University, Maxwell AFB, Ala., April 1996.
- Patterson, David A. "Microprocessors in 2020." *Scientific American* 273, no. 3 (September 1995).
- Petroski, Henry. *To Engineer is Human*. Chicago: University of Chicago Press, 1989.
- Psaltis, Demetri, and Fai Mok, "Holographic Memories," *Scientific American* 273, no. 5 (November 1995).
- Robinson, Clarence A. "Molecular Biology Computation Captures International Research," *Signal* 50, no. 6 (February 1996).
- Rogers, Craig A. "Intelligent Materials." *Scientific American* 273, no. 3 (September 1995).
- Sawyer, Ralph D. *The Seven Military Classics of Ancient China*. Boulder, Colorado: Westview Press, 1993.
- Scientific Advisory Board members, Comments from 2025 Concept Briefings Maxwell AFB, Ala., February 5, 1996.
- Sears, Allen, and Robert Neches. *Human Computer Interaction Program*. On-line, internet, 23 July 1995, available on <http://www.arpa.mil/sisto/HCI.html>.
- Sherman, Bill. *NCSA Virtual Reality Lab & CAVE*. On-line, internet, 18 February 1996, available on <http://www.ncsa.uiuc.edu/VR/VR/>.
- Simon, Herbert A. *Administrative Behavior: A Study of Decision-Making Processes in Administrative Organization*. 3d Ed. New York: The Free Press, 1976.
- Simonsen, Maj Philip, et al. "SPACENET: ON-ORBIT SUPPORT IN 2025." 2025 White Paper. Air University, Maxwell AFB, Ala., April 1996.
- SPACECAST 2020. "Leveraging the Infospace: Surveillance and Reconnaissance in 2020," SPACECAST 2020. Vol. 1. Maxwell AFB, Ala.: Air University Press, June 1994.
- Szafranski, Col Richard, and Col Joseph A. Engelbrecht, Jr. "The Structure of the Revolution: Demystifying the RMA." Unpublished paper, March 1996.
- Takano, Makoto, and Katsumi Fujita. "Multilevel Network Management by Means of System Identification" (Paper presented at the Third International Telecommunications Symposium, September 1995). On-line, internet, September 1995, available on <http://www.research.att.com/hgs/infocom95/program.html>.
- Thomas, Peter. "Thought Control," *New Scientist* 149, no. 2020 (9 March 1996).
- Tiernan, Maj Mike, et al. "In-Time Information Integration System." 2025 White Paper. Air University, Maxwell AFB, Ala., April 1996.
- Toffler, Alvin and Heidi Toffler. *War and Anti War*. New York: Warner Books, 1993.
- USAF Scientific Advisory Board. *New World Vistas: Air and Space Power for the 21st Century*. Unpublished draft, the Human Systems and Biotechnology Volume. 15 December 1995.
- . *New World Vistas: Air and Space Power for the 21st Century*. Unpublished draft, the Information Applications Volume. 15 December 1995.
- . *New World Vistas: Air and Space Power for the 21st Century*. Unpublished draft, the Information Technology Volume. 15 December 1995.
- USAF Scientific Advisory Board. *New World Vistas: Air and Space Power for the 21st Century*, Summary Volume. Washington, D.C.: USAF Scientific Advisory Board, 15 December 1995.

Vincent, 1 Lt Gary A. "In the Loop: Superiority in Command and Control." In *Operational Structures Course Book*. Vol. 5. Maxwell AFB, Ala.: Air University Press, November 1995.

Westenhoff, Charles M., ed., *Military Air Power*. Maxwell AFB, Ala.: Air University Press, 1990.

Widnall, Dr Sheila E. and Gen Ronald R. Fogelman, *Air Force Executive Guidance*. Washington D.C., December 1995.

———*Cornerstones of Information Warfare*. Washington D.C., 1995.

Zysman, George I. "Wireless Networks." *Scientific American* 273, no. 3 (September 1995).

Information Attack: Information Warfare In 2025



A Research Paper
Presented To

Air Force *2025*

by

Professor George J. Stein
Air War College

August 1996

Disclaimer

2025 is a study designed to comply with a directive from the chief of staff of the Air Force to examine the concepts, capabilities, and technologies the United States will require to remain the dominant air and space force in the future. Presented on 17 June 1996, this report was produced in the Department of Defense school environment of academic freedom and in the interest of advancing concepts related to national defense. The views expressed in this report are those of the authors and do not reflect the official policy or position of the United States Air Force, Department of Defense, or the United States government.

This report contains fictional representations of future situations/scenarios. Any similarities to real people or events, other than those specifically cited, are unintentional and are for purposes of illustration only.

This publication has been reviewed by security and policy review authorities, is unclassified, and is cleared for public release.

Contents

<i>Chapter</i>		<i>Page</i>
	Disclaimer	ii
	Executive Summary	iv
1	Introduction	1
	Thesis	2
	The Future Environment	3
2	New Ideas - New Words	7
3	Confused Visions	10
	The Joint Staff	11
	New Thinking?	12
	Dominant Maneuver	14
	Precision Engagement, Full-Dimension Protection and Focused Logistics	15
	The US Army	16
	The US Navy	17
	The US Air Force	18
	Confusion	20
	The Problem	22
4	Rethinking Information Warfare	25
	Global Awareness	26
	Global Reach	29
	Global Power	30
	Further Refinements	32
5	Into The Future - Information Attack in 2025	36

Executive Summary

Information Attack is defined by the USAF as either “directly corrupting adversary information without changing visibly the physical entity in which it resides.” or “activities taken to manipulate or destroy an adversary’s information without visibly changing the physical entity within which it resides.”

This essay argues that the proper understanding and future development of information attack, based on USAF information warfare competencies and systems, is the key to information dominance. It is likewise argued that a central obstacle to a future information warfare capability is that the words and definitions currently used among the Joint Staff and the armed forces to guide future development in IW are unclear, confused, and often contradictory as they fail to distinguish IW from Command and Control Warfare (C2W) and fail completely to incorporate USAF views on information attack.

The future potential in information warfare to substitute precise and discriminate credible information— whether by the methods of C2W (deception, PSYOP, or other means) or information attack— to a precise and discriminate target decision maker is the essence of decisive maneuver as it may position the adversary in space and time, by his own decision, in a fatally disadvantageous strategic situation. Information attack is not so much perception management as orientation management. Information is both the target and the weapon: the weapon effect is predictable error.

In future operating environments marked by ambiguity, speed, and precision effect, it will be the relative or differential advantage in information, information processing, and communication and information security that will provide the narrow margin for victory. Future USAF mastery of information attack, through air and space power unconstrained by artificial notions of battlefield-only command and control warfare, will provide the capability for asymmetric strategic response based on decisive and differential information advantage.

Chapter 1

Introduction

The strategic problems faced by the United States in the five 2025 alternate futures and the strategic problem faced in the intermediate world of 2015 identified in the *Air Force 2025 Study* are identical. The strategic problem faced by the armed forces in any of these futures is the same. “The true aim,” as B. H. Liddell Hart observed, “is not so much to seek battle as to seek a strategic situation so advantageous so that if it does not of itself produce the decision, its continuation by a battle is sure to achieve this.”¹ The question is whether information warfare and information attack can create this strategic situation in 2025 or even as early as 2015.

For the purposes of this essay, and for reasons which will hopefully become clear as the argument is developed, information warfare is defined as “actions taken to achieve relatively greater understanding of the strengths, weaknesses, and centers of gravity of an adversary’s military, political, social, and economic infrastructure in order to deny, exploit, influence, corrupt, or destroy those adversary information-based activities thorough command and control warfare and information attack.”

Information warfare is normally understood, following the *Joint Publication (Pub) 3-13, Joint Doctrine for Command and Control Warfare (C²W)* definition, as “actions taken to achieve information superiority in support of national military strategy by affecting adversary information and information systems while defending our own information and information systems.”²

Information warfare is currently defined by the USAF as “Any action within the information environment taken to deny, exploit, corrupt, or destroy an adversary’s information, information systems, and information operations, while protecting friendly forces against similar actions.”³ For the USAF, then,

bombing an enemy telephone exchange with iron bombs or corrupting the adversary's telephone switching system through electronic warfare or a computer attack are all, equally, information warfare. It is the targets, not the method of combat, which define information warfare for the USAF.

Command and control warfare is defined, following *Joint Pub 3-13, "Joint Doctrine for Command and Control Warfare (C²W),"* as "a war fighting application of IW in military operations {that} employs various techniques and technologies to attack or protect a specific target set - command and control."⁴

Joint Pub 3-13 further defines C²W as the "integrated use of psychological operations, military deception, operations security, electronic warfare, and physical destruction, mutually supported by intelligence, to deny information to, influence, degrade, or destroy adversary C² capabilities while protecting friendly C² capabilities against such actions."⁵

For the USAF, C²W is simply "the effort to disrupt and destroy an adversary's command and control."⁶

Information attack is defined by the USAF as either "directly corrupting adversary information without changing visibly the physical entity in which it resides."⁷ or "activities taken to manipulate or destroy an adversary's information without visibly changing the physical entity within which it resides."⁸

Thesis

The thesis of this essay is that the proper understanding and future development of information attack within the context of the USAF core competency of Information Dominance is the key to information warfare in the future.⁹ It is likewise argued that a central obstacle to a future information warfare capability is that the words and definitions currently used among the Joint Staff and the armed forces to guide future development in IW are unclear, confused, and often contradictory.

The USAF strategy for information warfare should be well advanced by 2015 and fulfilled by 2025 through its incorporation within the central USAF mission of the employment of air and space power. Air and space power will, as today, be conceived as global awareness, global reach, and global power. Information warfare, especially information attack, will be employed as an expression of global power made possible through global awareness and global reach. It will provide an essential component of the global presence through which national security objectives will be met and will meet the national military strategy

of deterrence, promoting stability, thwarting aggression, and containing conflict, and, ultimately, projecting power to fight and win.

The key strategic issue will remain “not so much to seek battle as to seek a strategic situation so advantageous so that if it does not of itself produce the decision, its continuation by a battle is sure to achieve this.” Information warfare, especially information attack, will provide the differential advantage, especially through air and space power, to permit the United States to develop and employ asymmetric modes of operation at what are called currently the strategic, operational, and tactical levels of conflict. Asymmetric and differential strategy is the key to breaking the platform-to-platform thinking (tank-counter-tank, ship-antiship, etc.) that continues to dominate long-range strategic thinking inherited from the successful experience in industrial-age warfare. Information warfare is the key to asymmetric and differential strategy and, in the context of this essay, information attack as new forms of air and space power are the key to information warfare.

The Future Environment

The development of asymmetric and differential strategy is required by the change in the range of potential military operations facing the armed forces in the emerging international security environment and the constraints consequent of both downsizing and the ever-increasing costs of traditional platforms.¹⁰ While there may not be a settled consensus on the precise outlines of the emerging security environment, virtually all studies recognize that an unusually high plurality of diverse and untraditional tasks will challenge America’s armed forces. The contemporary security environment is viewed as a generic regional contingency (or two nearly simultaneous major regional contingencies such as North Korea and Iraq), a generic niche competitor such as transnational criminal syndicates or ideological terrorists, or a generic, and yet to emerge, peer competitor.¹¹ The security environment can be seen as the *Air Force 2025 Study’s* five alternate futures “Gulliver’s Travails,” “Zaibatsu,” “Digital Cacophony,” “King Khan,” and “Halfs and Half-Naughts” and the 2015 “Crossroads” intermediate future. The security environment can be described more expansively as a range of high or low end global competitors, high or low end regional competitors,¹² counter-insurgency,

peace or humanitarian operations, dangerous industrial activities, weapons of mass destruction proliferation, collapsing or disintegrating states, and nonstate terrorism.¹³

The point is not that the armed forces will have to address all these challenges but that, despite downsizing and increasing platform costs, the military could be required to address any of these challenges. Absent the sudden emergence of a genuine competitor seen by the United States as having the capability to threaten American vital national security interests on a global basis, the armed forces, quite simply, must be able to do more with less or, perhaps as argued in this essay, must be able to do more by doing it differently. Information warfare through air and space power may provide the capability for asymmetric response through the differential advantage of information attack in most future security challenges.¹⁴

In the emerging information age and the operational environments postulated in almost all the alternate futures surveyed, military operations will reflect the characteristics of the larger societies.¹⁵ As most armed forces and many military operations become increasingly dependent on information,¹⁶ military winners will, like economic winners in the information-based economies, need to have that core competency identified by the USAF as information dominance whereby the United States has “greater understanding of the strengths, weaknesses, and centers of gravity of an adversary’s military, political, social, and economic infrastructure” than any adversary has about the United States.¹⁷ Information independence and information security, whereby American military power projection and even mobilization are not vulnerably dependent on the global information infrastructure, will likewise emerge as central national security issues.¹⁸ Any discussion of information warfare, including information attack, must be understood to include equal or greater attention to defense.

The goal of information dominance, note well, is greater understanding, not total understanding. As in the emerging information economies — sometimes called winner take all economies — “victory” is often based on a very small margin or differential of talent, information, performance, or luck. It is the relative performance in those markets or activities in which having or being second-best is inadequate, even at lower cost, which brings disproportionate rewards.¹⁹ The Olympic gold medalist who is only two seconds faster than her silver second gets the running shoe endorsement contract. The F-16 pilot who locks on only two seconds faster gets the kill. By 2025, or surely by 2050, only will be nanoseconds.

Another novel characteristic of differential performance in information-based activities is the ability to duplicate and distribute the output of the differential activity more widely, more rapidly and at relatively lower cost. Once a recording company suspects it has a platinum compact disc among its releases, millions of additional copies can be quickly manufactured, distributed, advertised, and sold planetwide.²⁰ Once one component of the distributed reconnaissance and surveillance satellite system locks on the target, the coordinates are duplicated and distributed by an information and communications meta-system to its customers planetwide.

The ability to conduct information-age warfare through the relatively better use of information-in-war and the ability to duplicate and distribute information warfare itself through information attack may provide the relative or differential “strategic situation so advantageous” of which Liddell Hart spoke that Sun Tzu’s pinnacle of excellence could be achieved wherein the enemy is subdued by asymmetric response without battle.

Information warfare, information-age warfare, information-in-war, information, and information attack are intimately related, but they are not identical. Clarification is needed and some consensus must be reached without, however, prematurely establishing authoritative doctrine that could prevent the creative developments required to realize the future potential of information warfare. The Joint Staff was correct when it noted in *Joint Pub 3-13* that the use of the term warfare in information warfare “should not be construed as limiting IW to a military conflict, declared or otherwise.”²¹

Notes

¹ B. H. Liddell Hart, *Strategy* (London: Faber and Faber Ltd., 1967), 325.

² Joint Pub 3-13, “Joint Doctrine for Command and Control Warfare (C²W) (draft),” 1995 I-4.

³ USAF, *Air Force Doctrine Document-5 (1st draft)*, (November 1995), 20.

⁴ Joint Pub 3-13 v.

⁵ *Ibid.*, I-4

⁶ USAF, *Air Force Doctrine Document-5*, 18.

⁷ USAF, *Cornerstones of Information Warfare*,.6.

⁸ USAF, *Air Force Doctrine Document-5*, 19.

⁹ Gen Ronald R. Fogleman, USAF, Chief of Staff and Sheila E. Widnall, Secretary of the Air Force, *Air Force Executive Guidance*, (1996) 4.

¹⁰ Theresa Hitches, “Lawmakers Call ‘97 Clinton Plan Unrealistic,” *Defense News*, 11-17 March 1996, 14.

¹¹ Jeffery R. Barnett, *Future War: An Assessment of Aerospace Campaigns in 2010* (Maxwell AFB, Ala. Air University Press, 1996).

¹² Jason Glashow, "Regional Powers May Gain Clout," *Defense News*, 11–17 March 1996, 36.

¹³ Board of Directors, *USAF Long Range Planning, "Future Operating Environments," Briefing Slides 29 February 1996, : R33.*

¹⁴ Joseph S. Nye and William A. Owens, "America's Information Edge," *Foreign Affairs*, March/April 1996, 20-54.

¹⁵ Pat Cooper, "Information Whizzes To Advise DoD on Future Wars," *Defense News*, 26–3 February March, 1996, 14.

¹⁶ Len Zuga, "EW Competition to Surge," *Defense News*, 19–25 February 1996, 20.

¹⁷ USAF, *Air Force Doctrine Document-1 "Air Force Basic Doctrine,"* (draft) 15 August 1995, 10

¹⁸ Pat Cooper, "IW Study May Guide U.S. Policy," *Defense News*, 25–31 March, 1996, 39.

¹⁹ Steven Pearlstein, "The Winners are Taking All," *Washington Post National Weekly Edition* 13 11–17 December 1995, 6-10.

²⁰ Gary Hamel and C. K. Prahalad, *Competing for the Future*, (MA: Harvard Business School Press, 1994).

²¹ Joint Pub 3-13, .I-4.

Chapter 2

New Ideas - New Words

The basic problem with understanding information warfare today is that there is no clear sense of just *what* is being discussed. The futurists Alvin and Heidi Toffler have argued in their recent book *War and Anti-War* that the United States armed forces need to develop a systematic, capstone concept of military "knowledge strategy" which would include clear doctrine and policy for how the armed forces will acquire, process, distribute, project, and protect knowledge and information to serve national strategy.¹ The Tofflers and others have argued that the concept of information warfare includes those information-based operations which attempt to influence the "emotions, motives, objective reasoning, and ultimately the behavior" of others.² The strategists John Arquilla and David Ronfeldt, on the other hand, have argued in their important essay "Cyberwar is Coming!" that "netwar" and "cyberwar" are the key concepts for understanding information war.³

Originally emerging in the science fiction community as, for example, in the very thought-provoking future war suggested in Bruce Sterling's *Islands in the Net*,⁴ the concepts of netwar and cyberwar provide one thoughtful starting point for exploring the military and civil/military issues of information war. Netwar, according to Arquilla and Ronfeldt, is a "societal-level ideational conflict waged in part through internetworked modes of communication." That is, they suggest that what is today seen as *strategic-level*, traditional, state-to-state conflict through the use of a nation's electronic intelligence and communications assets is the essence of netwar. Unlike traditional propaganda that seeks to provide information (whether true or false) which the adversary must understand, netwar or *strategic level* information war attacks another society's epistemology and decision-making process. Netwar attacks how the adversary knows, not just what the adversary knows.

Cyberwar is seen as the *operational* level of information warfare whereby the armed forces use netwar principles, techniques, and technologies to attack the epistemology and decision-making process of the enemy armed forces— especially its commanders. Most current discussion of information war in the armed forces seems to focus almost exclusively on the tools and techniques of cyberwar rather than strategic-level netwar. At the operational level of war, a national information war or netwar strategy would be translated by the armed forces into cyberwar or command and control warfare, often referred to in military shorthand as C²W. Cyberwar, in the hands of the local military commander, attacks the mind of the enemy commander through various tools, many of which are from the universe of electronic warfare, to produce bad decisions and prevent, delay, or deny information for good or militarily effective decisions.

For the purposes of this essay, information warfare is seen as analogous to netwar and, as noted above, from within the USAF view, as “actions taken to achieve relatively greater understanding of the strengths, weaknesses, and centers of gravity of an adversary’s military, political, social, and economic infrastructure in order to deny, exploit, influence, corrupt, or destroy these adversary information-based activities through command and control warfare and information attack.”

Command and control warfare would be understood by the armed forces as analogous to cyberwar. Information attack, recall, is “*directly corrupting adversary information without changing visibly the physical entity in which it resides*” and is the key to both netwar and cyberwar.

Within the general and authoritative military context, however, there is little agreement on definitions or the scope of the debate. Words have meaning as, at least, the components of military doctrine and, as such, affect how each service will “organize, train, and equip” its forces to support national security policies. Much of this essay may seem to be mere semantic nit-picking, but the “right” words and definitions are vital because of the authoritative nature of doctrine. The services fight over words.⁵ Whether each service will be able to make informed decisions on the future evolution of the armed forces depends on their having a coherent understanding of the promise and perils of information warfare and, especially, information attack.

As the service most likely to be able to develop its current information warfare assets embedded in global awareness and reach, and its information attack potential in global power, the USAF has a special and historic responsibility to lead clear thinking and doctrinal development for the new forms of strategic operations permitted by information warfare and information attack.

¹ Alvin and Heidi Toffler, *War and Antiwar: Survival at the Dawn of the 21st Century* (Boston: Little, Brown & Co., 1993),141.

² Joint Chiefs of Staff Memorandum of Policy 30, *Command and Control Warfare* (March 1993), A-4.

³ John Arquilla and David Ronfeldt, "Cyberwar is Coming!," *Comparative Strategy* 12, no.2 (April–June, 1993), 141-165.

⁴ Bruce Sterling, *Islands in the Net* (NY: Ace, 1988).

⁵ The continuous argument over the "authority" of the Joint Force Air Component Commander (JFACC) to "control" ground-support missions is illustrative. To the outsider the debate seems "theological." To troops on the ground, it's a question of life or death.

Chapter 3

Confused Visions

A key problem within military discussions of information warfare is that the Department of Defense, the Joint Staff, and each individual service recognize that if IW is, indeed, a new form of warfare or represents a potential for a true “revolution in military affairs,” then there are important implications for the traditional roles and missions of each individual service. If, for example, “to be seen is to be killed” and hostile unmanned aerial vehicles (UAV) provide battlefield overview for smart artillery shells, armored units whose own air and space forces have not yet “blinded” the enemy will be sitting ducks. This, likewise, has implications for future access to increasingly scarce defense appropriations. If, for example, Congress becomes convinced that investing in swarms of cheap-tank-locating UAV for US Army helicopters to use to kill enemy tanks is a better idea, then this raises the obvious question “Why are we still buying tanks?” Indeed, Congress might ask whether the Joint Strike Fighter (JSF) is the better investment for plinking tanks in open terrain than an uninhabited combat air vehicle (UCAV). The military is, understandably, institutionally conservative and, as in the early discussions of airpower or current discussions of space power, more likely to attempt to fit the new into the already known.¹ Even the USAF has a legacy of platform-focused thinking.²

On the other hand, information warfare is the hot topic of the age and everyone wants to be part of the “Third Wave,” the armed forces being no exception. Unfortunately, far too much discussion in the armed forces of IW confuses the traditional importance of information-in-warfare with information warfare or information attack itself. All those papers and briefings that begin “Information has always been central to warfare. . .” and then go on to explain that “our new computer system will get information to the warfighter” so he can “achieve information dominance on the battlefield” and thus demonstrate our service’s mastery of

IW, confuse information-in-war with information warfare. Whether we are digitizing the cockpit or digitizing the battlefield, this is not IW.³ Information-in-war is absolutely vital and will be an increasingly important issue as the use of information is central to modern warfare and, more importantly, may be the *sine qua non* or necessary-but-not-sufficient condition for the conduct of any future traditional warfare and certainly any future information warfare. A review of the current debate within the armed forces will illustrate the problem. Ultimately, a particular USAF idea will point to the solution.

The Joint Staff

While the current draft definition is unclassified, the official definition of *information warfare* remains classified top secret. The public, nonclassified and formal military discussion of information warfare began with the Joint Chiefs of Staff *Memorandum of Policy (MOP) - 30* (1993), “Command and Control Warfare.” This document set the initial terms of debate and, consequently, most formal debate since. Most importantly, “Command and Control Warfare” or C²W was defined as “the military strategy that implements Information Warfare on the battlefield” and its objective was to “decapitate the enemy’s command structure from its body of forces.”⁴ The legacy of Desert Storm’s airpower and electronic warfare against Iraq was seen as the essence of information warfare.⁵ What is really being discussed in the desert war context is, in fact, the new and creative use of information-in-war noted by Soviet and other observers.⁶ Note also that the discussion of IW starts as a battlefield topic with the result that much of the continuing debate places IW in the combat support role rather than as a new form of combat proper.

More recently, the Joint Staff has expanded the idea of information warfare in *Joint Pub 3-13* (1995), “Joint Doctrine for Command and Control Warfare.” Information warfare is defined, as noted above, as actions “taken to achieve information superiority in support of national military strategy by affecting adversary information and information systems while leveraging and defending friendly information systems.”⁷ Here, a central and vital issue is noted. While the armed forces may attempt to gain superiority by affecting adversary information and information systems, they can defend only friendly systems. That is, the Joint Staff seems to assert that the armed forces have no military mission or authority, currently, to defend friendly information. The armed forces, it appears to be claimed, can protect military information systems

only; they cannot use military assets to defend the nonmilitary information systems of the United States from adversary attempts to gain military advantage. The political debates about the restrictions placed on conveying pornography on the Internet contained in the Communications Decency Act accompanying the recently enacted Telecommunications Act are a mere skirmish compared to the civil libertarian firestorm that would result if the military claimed a role in nongovernmental information or information systems protection.⁸ On the other hand, the mission of the armed forces is to defend the United States, and if hostile information attack threatens the national security, it is difficult to see why the skills and experience that the armed forces are developing to protect military systems should not be loaned to an interagency Information Security Task Force.

The Joint Staff's *Joint Pub 3-13* then modifies the earlier definition on command and control warfare (C²W) first used in *MOP-30* in an important but ultimately inadequate way. C²W is now seen as "a {not *the*} war fighting application of IW in military operations {not just on the *battlefield*} and employs various techniques and technologies to attack or protect command and control {not just *decapitate*}". *Joint Pub 3-13* goes on to define C²W as the "integrated use of psychological operations, military deception, operations security, electronic warfare, and physical destruction, mutually supported by intelligence." That is, the integrated use of perfectly traditional information-in-war tools and techniques.

New Thinking?

The Joint Staff, whose views on doctrine are assumed to be directive for the individual services and whose definitions thereby amplify the importance of words, is currently developing a series of ideas for war fighting in the near-future: *Joint Vision 2010 - America's Military: Shaping the Future*. While not focused primarily on information warfare, *Joint Vision 2010's* ideas are of direct relevance to the future evolution and role of IW. *Joint Vision 2010* begins with a projection of current technological trends assumed to shape the future war fighting environment. These include: (1) the increasing precision of weapons and their means of delivery, (2) the increasing menu of weapons' effects from traditional lethality to nonlethal technologies, (3) increased stealth for both offensive platforms and invisibility of friendly forces, and (4) improvements in

information systems integration, from sensors to shooters, which may permit a “dominant battlespace awareness” to include the ability to “see, prioritize, assign, and assess.”⁹

These four trends, which are assumed to provide a magnitude improvement in lethality, will require information supremacy. Information supremacy is defined here as the “capability to collect, process and disseminate an uninterrupted flow of information while exploiting or denying an adversary’s ability to do the same.”¹⁰ This is, of course, both a worthy goal and a perfect definition of information-in-war. Information supremacy, according to *Joint Vision 2010*, will require both offensive and defensive information warfare. Offensive IW will degrade or exploit an adversary’s collection and use of information and will be conducted by traditional and “nontraditional” means such as “electronic intrusion” into an information and control network to “convince, confuse, or deceive enemy military decision makers.”¹¹ Defensive IW will protect dominant battlespace awareness and provide improved command and control of friendly forces and will be conducted by traditional means such as physical security and encryption and untraditional means such as antivirus protection and secure data transmission.

Joint Vision 2010, then, continues the pattern of seeing information warfare as an advanced version of command and control warfare (C²W), new techniques of traditional electronic warfare (EW), and a sense that computer viruses, as a form of EW, might be important. Information supremacy is still defined, operationally, as information-in-war rather than information warfare as a potentially new form of warfare for the future. This most current Joint Staff thinking appears to have forgotten its earlier idea in *Joint Pub 3-13* that the use of the term warfare in information warfare “should not be construed as limiting IW to a military conflict, declared or otherwise.”

Based on the technologies of this information supremacy providing dominant battlespace awareness, *Joint Vision 2010* proposes that new concepts of operation will need to be developed. These new operational concepts (how the joint force commander will fight the fight with land, sea, air, and space forces assigned) are (1) dominant maneuver, (2) precision engagement, (3) full-dimension protection, and (4) focused logistics. These four new operational concepts will provide “Full Spectrum Dominance” to achieve massed effects in warfare from dispersed forces across the spectrum of military actions from peacetime engagement through deterrence and conflict prevention to fight and win warfare.

The key problem with Full Spectrum Dominance is not only that its notion of information warfare is still too focused on information-in-warfare but that the application of massed effects in warfare from dispersed forces still appears to assume that massing forces is the strategic problem. The Joint Staff appears to assume, naturally enough, that land, sea, air, and space forces are the only, or certainly major, means for the joint force commander to accomplish the mission. That militarily-relevant, strategic, operational, or tactical effects might be produced by information attack without combining the various joint forces in theater may be the key difference between information-in-warfare and information warfare. A brief survey of the four new operational concepts will illustrate the problem.

Dominant Maneuver

Dominant maneuver is an operational concept that grows from the experience of the Gulf War and the evolution of US Army thinking from “Air-Land Battle” to “Force XXI Operations.”¹² In essence, instead of warfare being conducted as a series or sequence of battles leading ultimately to the enemy collapse, dominant maneuver proposes to bring together widely dispersed joint forces to attack the enemy throughout the height, breadth, and depth of the battlespace by attacking all levels of the enemy’s centers of gravity simultaneously.¹³ Clearly, the increasing precision of weapons and their means of delivery, the increasing menu of weapons’ effects from traditional lethality to nonlethal technologies, the increased stealth for both offensive platforms and invisibility of friendly forces, and the improvements in information systems integration are the technologies that permit dominant maneuver. *Joint Vision 2010* recognizes that these new weapons will “allow us to conduct attacks concurrently that formerly required massed assets in a sequential methodology.”¹⁴ And, while these new weapons and technologies may permit us to “accomplish the effects of mass — the necessary concentration of combat power at the decisive time and place — without physically massing forces,” dominant maneuver still appears to seek to “attain with decisive speed and tempo a *physical* presence that compels an adversary to either react from a position of disadvantage or quit.” (emphasis added). *Joint Vision 2010* is confused. Do mass effects require physical presence by joint forces assembled from widely dispersed locations or not? And why does *Joint Vision 2010* assume that mass

effects are superior to differential effects? Information warfare, advanced C²W, and information attack may not need to share this assumption.

Precision Engagement, Full-Dimension Protection and Focused Logistics

Precision engagement and full-dimension protection make the same assumption. Precision engagement depends on a system of systems¹⁵ that permits our forces to locate the target, provide responsive command and control, have the desired effect, assess the effect, and reengage if required. That is, we can shape the battlespace and conduct a dominant maneuver. Full-dimension protection, built on information supremacy (actually, supremacy of information-in-war), will provide multidimensional awareness and assessment, as well as identification of all forces within the battlespace. Defensive information warfare will be required to protect our information systems and processes.

Focused logistics, the final new operational concept, again illustrates the thinking that the ability to project power with the most capable forces is the central problem. The ability to fuse information, logistics, and transportation technologies; provide rapid crisis response; track and shift assets even while enroute; and deliver the logistics and sustainment to the level of operations” assumes that getting stuff there for the forces is the essence of projecting power. Yes, in many cases, especially against traditional adversary’s armed forces or other military operations like peace enforcement and humanitarian relief, this may be true.

Dominant maneuver, precision engagement, and full-dimension protection are clearly operational concepts that will permit the US armed forces to attain full spectrum dominance in a traditional campaign against a traditional adversary. There will be undoubtedly Saddam-revenant adversaries even in 2025. Creative USAF thinking about information warfare, however, requires that a series of unusual questions be asked: What is the future battlespace. What are forces in future conflicts? What is “there” in a future battlespace? What if the adversary is not employing forces?

Joint Vision 2010 introduces a generally thoughtful and potentially useful set of ideas for the evolution of operational concepts for US joint forces to employ in traditional military operations across a large spectrum of conflict. It correctly recognizes information-in-warfare as one of the most important and critical aspects of near-future (*circa* 2010) military operations. Information superiority is, in fact, the necessary

condition for future joint warfare and, as such, the Joint Staff is correct in calling for far greater attention to the promise and peril of the new technologies for the collection, processing, and secure dissemination of information-in-war. *Joint Vision 2010* is much less successful in addressing the implication for the US armed forces, and especially the USAF, if the potential for information warfare were to be something beyond a technology-based, more sophisticated version of command and control warfare.

It is, of course, the individual armed services that are tasked to organize, train and equip for the future. How are the individual armed services thinking about information warfare on the road to 2025?

The US Army

For the US Army, “information operations” replaces information warfare as the capstone concept. Information operations are continuous military operations within the military information environment that enable, enhance, and protect the commander’s decision cycle and mission execution to achieve an information advantage across the full range of military operations.¹⁶

Information operations include “interacting with the global information environment and, as required, exploiting or degrading an adversary’s information and decision systems.” That is, the Army recognizes that information affects operations far beyond the traditional battlefield and, thus, information operations is seen as the proper “word” to include both information warfare and command and control warfare. This is a potentially important evolution in Army thinking but, currently, it results in a limited view of information warfare. Information operations may, in fact, be a better word than information warfare, and could be adopted by the Joint Staff and the other services, but only if the concept is expanded to mean more than “military operations within the military information environment.”

Information warfare, for the US Army, are actions taken to preserve the integrity of one’s own information system from exploitation, corruption, or destruction while at the same time exploiting, corrupting, or destroying an adversary’s information system and in the process achieving an information advantage in the application of force.¹⁷ That is, information warfare remains in the universe of traditional platform-versus-platform thinking like “only armor can confront armor” with the information system as the new platform.

Information warfare thus has been constrained to the universe of the combat support elements where technowizards will provide advantage for Willie and Joe to apply force with real weapons like tanks and artillery.

The US Army appears to confuse information-in-war with information warfare. The Army's goal to "assimilate thousands of bits of information to visualize the battlefield, assess the situation, and direct military action appropriate to the situation" is the use of information-in-war for traditional battle. The Army's "Information Age" *Force XXI* will "know the precise location of their own forces, while denying that kind of information to their foes" because, for the Army, information is "an essential dynamic enabling dominant military power at the strategic, operational, and tactical levels." This will be achieved by "using and protecting information infrastructures" while influencing or denying a potential adversary's use of these infrastructures.¹⁸

By constraining its doctrinal thinking to the infrastructure aspects of information and adopting uncritically the Joint Staff definition of command and control warfare (C²W), the US Army may have let its traditional, and proper, land-warfare focus prematurely narrow its vision to the battlespace of armor, artillery, and infantry divisions. While it is undoubtedly important that the Army study and apply its notion of information warfare to command and control warfare, it is also undoubtedly obvious that the Army must develop its concept of information operations beyond "the military information environment." Information operations, if conceived synergistically with the USAF concept of information attack, are much more than "integrated support to battle command" in traditional military operations.¹⁹

The US Navy

The US Navy essentially shares the same view of information warfare as does the Air Force but, like the US Army, views information operations as a means through which to conduct traditional battle. Like the Air Force, the Navy views command and control warfare (C²W) as distinct and subordinate to information warfare proper. Like the Army, the Navy appears to view IW primarily as a means to prepare for battle. The former chief of naval operations, Adm J. M. Boorda, observed recently that because of the Navy's traditional forward deployment, "Information Warfare will give us the ability to slow and influence the enemy's decision making cycle, to prepare the battlespace before the start of hostilities, and to dictate the

battle on our terms.”²⁰ While naval doctrine for IW is in at least as much flux as that of the other services, current doctrine straddles the big view of IW and the little view of IW as C²W. Operations Naval Instruction (OPNAVIST) 3430.26 defines IW as action taken in support of national security strategy to seize and maintain a decisive advantage by attacking an adversary’s information *infrastructure* through exploitation, denial, and influence, while protecting friendly information *systems* [emphasis added].²¹

Platform-to-platform battle is again the model. Likewise, C²W is the “action taken by the military commander to realize the practical effects of IW on the battlefield.” As a service, the Navy may be expected to develop the tools and techniques of C²W for power projection from the sea with the growing awareness of the potential for IW to project the effect of combat power far inland from the combat forces that are the source of that power.²² The Navy recognizes that information warfare “encompasses political, economic, physical, and military infrastructures” and “expands the spectrum of warfare from competition to conflict.”²³ There is an obvious potential for mutual synergy in developing asymmetric strategies between the Navy’s sea and air assets and the US Air Force’s air and space assets for both C²W based information warfare and information attack.

The US Air Force

The US Air Force begins its reflections on information warfare from within its views on air and space power. For the USAF, air and space power are a means to an end, not the end itself. Like the Navy’s “from the sea,” air and space power are “done” in and from a “place” that is “more than a place”: the air and space. Thus, air and space power include the projection of military force from air and space. The goal is air and space superiority as the necessary, but not sufficient, condition for the application or employment of all other military power. And, as air and space surround the globe, the USAF sees itself as having a global mission of air and space superiority, global mobility, and the precision employment of air and space assets. The same vision informs USAF thinking on information warfare.

For the USAF, currently, information is seen as analogous to air and space. Information is seen as a realm in which dominance will be contested and in which and from which military power can be employed. Like air and space power, information dominance is a necessary, but not sufficient, condition for the

application or employment of all other military power and, likewise, is a global mission. Mastering information warfare, then, will become a USAF core competency like air and space superiority. Unfortunately, USAF thinking currently suffers some of the same internal contradictions as does the IW thinking of the Army and Navy and, more importantly, that of the Joint Staff. The issue is, again, confusion among information-in-war, information, and information warfare.

The USAF recognizes correctly that information dominance is a broad concept and describes it, in Air Force Doctrine Document 1 (AFDD-1) “Air Force Basic Doctrine,” in the war-fighting context as that condition in which the commanders have “greater understanding of the strengths, weaknesses, and centers of gravity of an adversary’s military, political, social, and economic infrastructure” than the enemy has about our side.²⁴ That is, information dominance provides a decisive degree of information-in-war that is essential for the successful application, enhancement, or employment of air and space power or, indeed, any other kind of military power. On the other hand, in Air Force Doctrine Document 5 (AFDD-5) “Information Warfare,” information dominance is defined as that “degree of superiority in information functions that permit friendly forces to operate at a given time and place without prohibitive interference from opposing forces.”²⁵ As will be discussed presently, information “functions” is a problematic limitation. While information dominance must become a core USAF competency by 2025, it is only one key step, potentially, toward full-information warfare competency. Like the US Army, USAF thinking on information warfare must not be constrained to “information functions.”

Unlike *Joint Pub 3-13* (1995), “Joint Doctrine for Command and Control Warfare,” USAF thinking on information warfare appears to see aerospace power as not constrained by political considerations from protecting the military forces against hostile enemy information actions. That is, for the USAF, IW is any action to “deny, exploit, corrupt, or destroy an adversary’s information, information systems, and information operations” while protecting “friendly forces from similar actions.”²⁶ While the Joint Staff, the Army, and Navy see part of IW as protecting our military *systems* and military information *infrastructure*, the USAF appears to envision part of IW as defending the armed forces against enemy information actions as well as defending the military information infrastructure. The USAF is right: waiting for an electronic Pearl Harbor and then beginning the slow buildup and deployment of Army land power to apply force is not the way to prepare the armed forces for the fight, or to deter fighting, in the information age.

Confusion

It must be admitted that current USAF thinking is confused in the area of information warfare and has not yet reached a coherence in the words that will define and guide doctrine. The USAF doctrine community, unfortunately dispersed among the Air Staff, the Air Force Doctrine Center at Langley AFB, the College of Doctrine, Research and Education at Air University, and the Air Command and Staff College and Air War College, must aim to harmonize its thinking. USAF long-range planning cannot incorporate the information warfare insights developed in research like *New World Vistas* or *Air Force 2025* without a coherent vocabulary. Words matter. Air Force Doctrine Document-1 (AFDD-1), Air Force Doctrine Document-5 (AFDD-5) and Cornerstones

Current (August 1995 draft) *Air Force Doctrine Document-1* (AFDD-1), “Air Force Basic Doctrine,” and AFDD-5, “Information Warfare,” postulate six roles for air and space power: control, strike, mobility, information, sustainment, and preparation. The information role is defined to include command, control, communications, and computers (C⁴); intelligence, surveillance, reconnaissance, navigation and positioning; and the weather service. Clearly, information is seen like sustainment and preparation as combat support or combat service support to the war-fighting missions of strike, control, and mobility. According to *AFDD-1*, USAF core competencies, as in *Air Force Executive Guidance*, include air superiority, space superiority, global mobility, precision employment, and information dominance. As noted above, for AFDD-1, information dominance is that condition that gives greater understanding of the strengths, weaknesses, and centers of gravity of an adversary’s military, political, social, and economic infrastructure than the enemy has about our side. The core competency of information dominance, then, appears to be accomplished by the information role of air and space power.

In an attempt to provide the doctrinal foundation²⁷ for information warfare, the USAF chief of staff, Gen Ronald R. Fogleman, and the secretary of the Air Force, Sheila E. Widnall, issued *Cornerstones of Information Warfare* in 1995. *Cornerstones* proposes that the roles and missions of air and space power are not the six of *AFDD-1* but four: aerospace control, force application, force enhancement, and force support. Information warfare is not a separate role or mission but is incorporated as a component of aerospace power. In aerospace control, IW is counterinformation— actions dedicated to controlling the

information realm. Command and control warfare (C²W) appears under the mission of “force application.” Information operations, really any action involving information-in-war, is part of “force enhancement” while the role of information in “force support” is merely noted.²⁸

Command and control warfare (C²W) is central to all military discussions of IW and *Cornerstones* views C²W part of the force application mission. Here the USAF has made its most distinctive and promising addition to IW thinking. *Cornerstones* modifies the model of C²W proposed by the Joint Staff and adopted by the Army and Navy from the “integrated use of psychological operations, military deception, operations security, electronic warfare, and physical destruction, mutually supported by intelligence” to “psychological operations, military deception, security measures, electronic warfare, physical destruction, and information attack.”²⁹

Information attack, is defined in *Cornerstones* as “directly corrupting information without visibly changing the physical entity within which it resides.”³⁰ The USAF is the first to recognize that IW is about information itself and not just information-in-war. IW is about ideas and epistemology, what is known and how it is known, and would be waged largely, but not entirely, through adversary information systems and infrastructures. The target of war is ultimately the human mind of the adversary decision makers and, in the information age, it is information itself that is, increasingly, the center of gravity of an adversary’s military, political, social, and economic infrastructure. In reality, what *Cornerstones* is asserting is that information is not just a realm in which dominance will be contested, but rather, the realm is information. Information is both the target and the weapon.

The USAF has a better sense of command and control warfare than either *Joint Pub 3-13* or the Army documents. C²W is seen by the USAF as a force application mission like interdiction or close air support and it would conduct C²W through electronic warfare, psychological operations, military deception, physical attack, and security measures.³¹ *Cornerstones* adds information attack to C²W. As a force application mission, C²W attack (especially information attack) can be used for strategic, operational, or tactical effect. Like strategic air and space power, C²W is not just a battlefield support mission. C²W for the USAF and the Navy is only a particular form of IW, and to restrain the Navy or the USAF to C²W as the extent of its contribution to IW operations would be a foolish waste of sea, air and space power assets and capabilities.

The problem comes, however, with *Cornerstones*' foundation idea of information attack doctrine in the authoritative context of official USAF doctrine represented in AFDD-1.

The Problem

While AFDD-1 recognizes that information warfare could be used for neutralizing an adversary's will and capacity to make war, its view of information attack illustrates the same unimaginative platform-to-platform thinking as "only aircraft can contest aircraft for air superiority." That is, information attack is seen in AFDD-1 as the use of "computers and communications to directly attack the adversary's information operations."³² At first glance, and given the Army understanding of information operations, this appears to move beyond attacking platforms. The problem is that an information operation is any activity that involves information *functions* and, most importantly, *Cornerstones* has defined information functions as the *technology-dependent* elements involved in the acquisition, transmission, storage, or transformation of information seen as data and instructions.³³

Because AFDD-1, "Basic Doctrine" defines information as "the organized network of information functions that enhance employment of forces," and *Cornerstones* has defined information functions as the *technology-dependent* elements of the network, there is a danger that the very sophisticated idea of information attack may be seen as little different from the Army's notion of "using and protecting information infrastructures while influencing or denying a potential adversary's use" of these infrastructures. It is still a counterplatform model.

AFDD-5, "Information Warfare," on the other hand, has defined information attack as "activities taken to manipulate or destroy an adversary's information without visibly changing the physical entity within which it resides" and information functions as any activity involving the acquisition, transmission, or storage or information.³⁴ The key question is: Does the USAF recognize "any activity" beyond attacking (and defending) the technology-dependent information infrastructure as part of information attack?

Authoritative USAF thinking has not demonstrated how IW could be used for "neutralizing an adversary's will and capacity to make war" beyond a slightly more expansive notion of command and control warfare tied to tricky computer hacking to enhance the employment of forces. The USAF must rethink

AFDD-1 and AFDD-5 to realize the potential of information warfare implicit in a creative development of information attack. The USAF must also reject the idea that IW is only to enhance the employment of forces, and must break free of the mantra of jointness wherein air and space power are discussed only within the context of supporting the Joint Force Commander. Air and space power will permit information attack in 2025, and information attack may be the differential that permits asymmetric strategic operations by aerospace power alone in war and peace.

Notes

¹ Andrew F. Krepinevich, "The Pattern of Military Revolutions," *The National Interest*, no.37 (Fall 1995), 30–42.

² Carl H. Builder, *The Icarus Syndrome: The Role of Air Power Theory in the Evolution and Fate of the U.S. Air Force* (New Brunswick, N.J. Transaction Publishers, 1994).

³ James M. Dublik and Gordon R. Sullivan, *Land Warfare in the 21st Century* (Carlisle Barracks, PA: US Army War College Strategic Studies Institute, 1993).

⁴ Joint Chiefs of Staff Memorandum of Policy 30, 3.

⁵ Edward Mann, "Desert Storm: The First Information War?," *Airpower Journal* 8, no. 4 (Winter, 1994) 4–14.

⁶ Mary C. FitzGerald, *The Soviet Image of Future Wars: "Through the Prism of the Persian Gulf"* (Washington, D.C. The Hudson Institute, 1991) and V.K. Nair, *War in the Gulf: Lesson for the Third World* (New Delhi: Lancer International, 1991).

⁷ Joint Pub 3-13, I-4.

⁸ Daniel Brandt, "Infowar and Disinformation: From the Pentagon to the Net," *NameBase NewsLine*, No.11, October–December 1995, 11 available from: gopher://ursula.blythe.org/00/pub/NameBase/newsline.

⁹ *Joint Vision 2010 - America's Military: Shaping the Future* (1995), 5.

¹⁰ *Ibid.*, 7.

¹¹ *Ibid.*

¹² United States Army Training and Doctrine Command, *Force XXI Operations: TRADOC Pamphlet 525-5* (August 1994).

¹³ *Ibid.*, 2–9.

¹⁴ *Joint Vision 2010 - America's Military: Shaping the Future* (1995), 7.

¹⁵ William A. Owens, "The Emerging System of Systems," *Military Review* 75 no. 3 (May–June, 1995), 15-19.

¹⁶ United States Army Training and Doctrine Command, *TRADOC Pamphlet 525-69: Concept for Information Operations* (August 1995), 2.

¹⁷ *Ibid.*, 3.

¹⁸ United States Army Training and Doctrine Command, *TRADOC Pamphlet 525-69*, 2.

¹⁹ *Ibid.*, 2.

²⁰ Air Land Sea Application Center, *Information Warfare / Information Operations Study* (December, 1995), 16.

²¹ *Ibid.*, 17.

²² Navy Public Affairs Library, *Copernicus - Forward C4I for the 21st Century* (June 1995), 2.

²³ Ibid., 7.

²⁴ USAF, Air Force Doctrine Document 1, 10.

²⁵ USAF, Air Force Doctrine Document 5, 19.

²⁶ USAF, Air Force Doctrine Document -1, B-3 quoting AFDD-31 (First Draft).

²⁷ USAF, Cornerstones of Information Warfare, 16.

²⁸ Ibid., 11.

²⁹ Ibid., 5.

³⁰ Ibid., 6.

³¹ Norman B. Hutcherson, *Command and Control Warfare: Putting another Tool in the War-fighter's Data Base*, (Maxwell AFB, Ala.: Air University Press, 1994).

³² USAF, Air Force Doctrine Document-1, 11.

³³ USAF, Cornerstones of Information Warfare, 2.

³⁴ USAF, Air Force Doctrine Document-5 19.

Chapter 4

Rethinking Information Warfare

The USAF strategy for information warfare will be developed by 2025 through its incorporation within the central USAF mission of the employment of air and space power. Air and space power will, as today, be conceived as global awareness, global reach, and global power.

The USAF has seen correctly that information is like air and space; it is a realm in which superiority will be contested and from which power can be projected or engagement conducted. Information, for the USAF, is likewise just as much part of the physical universe as the other realms in which it operates and, indeed, may be “the” realm. Thus, information warfare will be conducted according to the same principles as are air and space operations. If this axiom is correct, and there is no scientific reason to assume that information is not grounded ultimately in matter and energy, then the characteristics of information warfare are analogous or parallel, not merely metaphorical, to the contemporary and future characteristics of air and space power.¹ The contemporary and future characteristics of air and space power, and the key to its centrality to those differentials which argue that aerospace power is the instrument for an asymmetric strategy are, of course, global awareness, reach, and power. Global awareness provides, increasingly, exact and timely information. Global reach permits a range and responsiveness to engage, not just fight, throughout the global battlespace. Global power, increasingly marked by the ability to apply precise and discriminating effects of power, will permit an asymmetric response which leverages the differential information-in-war advantage provided by global awareness and the information-based planning and execution control provided by global reach.

Global Awareness

Global awareness, in the view of *New World Vistas: Air and Space power for the 21st Century*, is that the USAF can use “affordable means to derive appropriate information about one or more places of interest after a delay which is short enough to satisfy operational needs.”² Global awareness requires the USAF to have the ability to detect and understand friendly and adversary activities in space, on the surface, and in the air. Global awareness in 2025 will require, additionally, detection and understanding in the info-realm or cyberspace. In the info-realm, global awareness must provide the information-in-war essential for information attack on the strategic, operational, or tactical centers of gravity of an adversary’s military, political, social, and economic infrastructure.³

Various capabilities to provide global awareness to support traditional air and space power employment will, obviously, be vital in providing for the employment of information attack in the alternate and intermediate futures of the *2025 Study* and, indeed, any future security environment. There are also info-awareness-specific capabilities that will need to be developed.

The set of required capabilities for future global awareness include a new generation of sensors based on a distributed system of satellites, surface sensors, and standoff systems based possibly on Uninhabited Combat Air Vehicles (UCAV).⁴ As it may be too much to expect even the new Joint Requirements Oversight Council to force the development of a common USAF /Army/Navy system and standards of database management and data communication, an implied requirement of continued USAF leadership of the global awareness system is a generic crosstalk capability with sister services and coalition partners.⁵

A specific set of USAF requirements for information attack, defined as directly corrupting information without visibly changing the physical entity within which it resides, can be identified within the general requirement of database management within global awareness. As in the classic North American Air Defense Command nuclear attack defensive system, the information must be detected and identified before there can be any talk of interception or destruction. Consequently, a reorientation in thinking about the traditional target sets for militarily-relevant intelligence gathering needs to occur as the information warfare battlespace is the information-dependent global system-of-systems on which most of the “strengths, weaknesses, and centers of gravity of an adversary’s military, political, social, and economic infrastructure”

increasingly depend. That is, not only must the question “What and where are the data?” on which these infrastructures depend be answered, but, equally important, “What are the structures and patterns of human activity depending on these databases and communications infrastructures?” Information attack requires more than a knowledge of wires and, consequently, suggestions for an Information Corps of techno-wizards would only produce platform thinking as hackers fought hackers.⁶

Locating and corrupting a database that is of marginal relevance to an adversary’s will and capacity to make war is a waste of scarce resources. It is the relevant information differential that is central to information attack as apparently benign activities or databases can hide potentially hostile cyber-strike capabilities. Thus, while global awareness for information attack appears to be about “everything,” at the pragmatic level, artificial intelligence search-architectures for differentially-relevant “information” must be designed by the Air Force Intelligence Agency, the Air Force Institute of Technology, and other labs under the Air Force Material Command. The technologists, however, must be led by the strategists in the same way as planning the traditional air campaign requires a coherent knowledge of the adversary systems.⁷ It is the patterns of human activity that are central.

As asymmetric response may be the best strategic choice in many cases, the relevant information target for global awareness attention may not be those data and communications systems that support directly the adversary’s fielded military activities, (the Joint Staff’s nominal target for information warfare and the adversary systems most likely to be best defended), but those other supporting data, infrastructure, and patterns of activity on which most contemporary and future military operations depend. While specific information attack activities will be discussed below in the section on global power, one example of the “other” data systems which might be subject to discriminate or precision asymmetric information attack are an adversary’s Supervisory Control and Data Activity (SCADA) systems for the operation of the air traffic control or fuel pipeline network.⁸ Clearly, then, the SCADA data bases and networks of potential adversaries must be detected, identified, and mapped.

At the most generic and nontechnical means level, global awareness for information attack will require monitoring commercial developments in information infrastructure architectures and capabilities, among whom these systems are employed, and how and by whom they are used. And, as it should be obvious that there is a defensive aspect of information warfare in that these capabilities will be used by an adversary

against the United States or an ally, careful monitoring will be required of developments in commercial-off-the-shelf (COTS) systems which could be used to attack industrial processes (for example anti-SCADA programs), financial and communications networks, and break-through systems that might provide differential advantage in information management and communications. Equally important, patterns of human activity or organizational change that suggest a developing potential for hostile information attack must become part of the normal business of global awareness. Identification of commercial industrial espionage in info-systems, even by an ally, should be presumed to indicate the intent to develop an information attack capability.

To support information attack in the near-future, whether for information warfare or C²W, USAF global awareness systems will need to develop and incorporate specific database and database management and correlation acquisition to its collection, processing and analyzing of activities currently monitored for planning and execution control.⁹ This set would include, logically, standard intelligence and surveillance architectures, command, control, and communications systems, especially systems designed to detect and defeat information attack, target and tracking, guidance, and navigation systems, especially space-based and other long-range communication capable systems, and attack assessment and reconstitution systems.¹⁰ The intelligence challenge will be more demanding than when the United States faced only one strategic peer competitor.

To support future capabilities for information attack in the asymmetric engagements required in the *2025 Study*, current USAF global awareness and monitoring activities will need to be expanded to include the other database and database management information systems. These might include general computer systems such as the internet and the world wide web, power generation and distribution systems, industrial, financial and transportation systems, and, in general, any system which might be used by an adversary to launch an information attack, first on US armed forces, and ultimately, on other domestic information assets.¹¹ Such an expansive system of monitoring will be essential to protect these domestic assets on which US joint force power projection itself ultimately depends.

It is important to note that the reorientation of intelligence activities needed to support information attack (and defense) in both the near and 2025 future as a USAF global awareness mission is in complete conformity with current US law. The object of USAF global awareness is not the American domestic database and database management systems. Domestic counter intelligence and law enforcement agencies

will develop an ability to monitor adversary activities in the United States. On the other hand, USAF global awareness assets may be the main source of intelligence support for alerting law enforcement agencies charged with protecting domestic information-dependent activities from adversary information attack about hostile capabilities.¹²

Global Reach

Global reach is usually thought of as the ability of deploy aircraft from the Continental United States or out-of-theater bases into the area of interest in a rapid and timely fashion. The role of air refueling is likewise central to global reach. Whether delivering bombs, special forces troops, or humanitarian assistance, the speed, range, and lift of aircraft are usually seen as the key issues in delivering what is required. This differential ability to reach out with rapid, discriminate, and precise effect is central to the USAF's leading role in asymmetric response even in traditional operations.

A more sophisticated view recognizes that the USAF ability to deploy and fly its space-based assets anywhere, anytime is essential for contemporary reconnaissance, communication, and command and control. This capability will be even more important in 2025. Discussions of direct broadcast satellite sensor-to-shooter or satellite-to-Joint Surveillance, Targeting, and Reconnaissance System (JSTARS) and then to all relevant parties is a central component of global reach. The capabilities of aircraft like *Commando Solo* or follow-on variants based on UAVs or direct broadcast satellites and the variety of on board electronic warfare wizardry already deployed on most US combat aircraft are recognized, again, as central to global reach. Future requirements for air refueling will include servicing UAVs and UCAVs used for information attack, perhaps via batteries recharged by airborne or satellite-reflected, ground-based lasers.¹³

Many of the current and projected global reach capabilities in speed, lift, and all-weather performance based on ever more precise navigation will be even more central to information warfare and information attack in 2025. As the new generation of sensors based on a distributed system of satellites, surface sensors, and standoff systems is developed, USAF "atmospheric" global-reach thinking must evolve to include the mission of precise, point-of-use delivery of surface-based sensors. Global reach must develop the capability to deliver sensors, or other information attack hardware, with the same stealth, speed and, most importantly,

precision now focused primarily on bombs. Global reach requires that ultra-high altitude air drops of information attack devices via, perhaps, Global Positioning System (GPS) based steerable parachutes must receive the same attention currently given precision guided munitions.¹⁴

The future role of USAF space reach is, of course, central to global awareness and global power. Specific space-based information warfare capabilities such as direct broadcast of video-morphed news broadcasts by the enemy leader announcing surrender are easy to imagine. These “Hollywood” capabilities, however, may not be the best use of space by the USAF. Whether protecting free access to space, defending against hostile use of commercial satellites by an adversary, developing an antisatellite capability, or having launch-on-demand capabilities, any and all of these could have some application to information attack (and defense). However, as the liberal, free-market, information-based economies of the United States and our allies are among those most likely to depend on “freedom of the high frontier,” the USAF should be hesitant about the militarization of space. On the other hand, if information attack is correctly identified as directly corrupting information without visibly changing the physical entity within which it resides, the potential for information attack against the United States or its allies via space-based commercial or neutral third-party systems cannot be ignored.¹⁵ As shutting down the space-based planetary navigation or communications systems may not be an option for either technical or political reasons,¹⁶ USAF global reach to support global awareness and power will require a residual capability to provide launch-on-demand or activation-on-demand of secure systems.

Global Power

USAF global power, increasingly characterized by the ability to engage with precise and discriminating effect, permits the asymmetric strategic response which leverages the differential information-in-war advantage provided by global awareness and the information-based planning and execution control provided by global reach. USAF global air and space power capabilities increasing demonstrate that the USAF’s concept of *decisive* maneuver, engagement with precise and differential or relative superiority, should replace the *Joint Vision 2010* concept of *dominant* maneuver.

Dominant maneuver, recall, proposes to bring together widely dispersed joint forces to replace the sequential march through the enemy's fielded military, population, infrastructure, and system essentials to get to the adversary leadership to convince him to change his behavior by attacking the adversary throughout the height, breadth, and depth of the battlespace and by attacking all levels of the enemy's centers of gravity simultaneously. The adversary system goes into shock and its ability to react is paralyzed. Dominant maneuver has become the Holy Grail of joint force employment. In reality, this massive and simultaneous engagement of joint forces appears to be required primarily because the joint force campaign planners lack the real-world, near-real-time knowledge of the key structures and patterns of activity, information, communication, or databases on which the adversary is dependent. *Joint Vision 2010's* "Full Spectrum Dominance," a very traditional American vision of war fighting, reflects the continuing inability to recognize the potential of information warfare. The emerging mission of USAF global awareness, as noted previously, must be to address this requirement to identify the strategic and militarily-relevant information differential. Dominant maneuver may be an obsolete concept for the exercise of military power in many of the security challenges of the near-future. Decisive maneuver, seen by the USAF as engagement with precise and differential or relatively superior air and space power assets, will be the future strategic choice and the rational use of scarce military resources. It will be the way to do more, differently.

Information warfare in the dominant maneuver universe is likewise usually discussed analogously to cumulative war in that a full-spectrum attack on the adversary's information infrastructure results in rendering him blind, deaf, and dumb. Lacking command and control of his military forces then, his actions are supposed to become chaotic and his forces are thus easier to defeat. It has not, however, been demonstrated that a blinded, chaotic actor represents the enemy decision maker from whom one could expect rational compliance with US strategic objectives.¹⁷ Battle is supposed to be about "some" thing, not "any" thing. Total information warfare against the adversary may be closer to "making the rubble bounce" than intelligent war fighting.

Information attack, on the other hand, as seen by the USAF more narrowly than full-scale IW, will be the essential component of decisive maneuver and may, in some situations, be the only exercise of discriminate power required to shape relatively predictable actions and produce the "strategic situation so advantageous" that US security objectives are met without dominant maneuver of the whole joint team. For

the USAF to develop the capability for discriminate, precision information attack, new USAF research must address precise modeling of a potential adversary's Markov chains¹⁸ and revisit the theories of power distribution control.¹⁹

Further Refinements

Information warfare can be direct or indirect. While it may appear at first counterintuitive, indirect IW involves creating information (or disinformation) that the adversary must observe if the intended effect is to be achieved.²⁰ A false radio transmission that is not intercepted by the enemy is a waste of electrons. For the USAF, indirect IW as a form of perception management²¹ will be executed in the future most often by the traditional means of command and control warfare: psychological operations, military deception, security measures, electronic warfare, and physical destruction.²²

Direct information warfare involves changing an adversary's information without involving the requirement that it be observed. Direct information warfare, counterintuitively, bypasses the adversary's perceptive or observing functions.²³ Thus, direct IW will be executed in most cases by information attack: directly corrupting information without visibly changing the physical entity within which it resides.²⁴ The goal is to "access the adversary's base of information used for decision making, thereby minimizing the unpredictability of the perceptive process."²⁵ Based on the information provided via USAF global awareness capabilities and the ability to deploy provided by global atmospheric and space reach, both indirect and direct USAF IW capabilities will be developed.

Planning for information attack would need to include the assembly of baseline critical data, the analysis of adversary essential networks or systems, and human activity patterns. Thus, as the essential first step, a vulnerability assessment of the processes, procedures, and physical characteristics of adversary information-dependent activities would need to be developed and continually updated.²⁶ To prepare to use information attack in asymmetric response, USAF info-warriors in 2025 must be guided by the principle that adversary military force is ultimately an output or peripheral of a weapons system and its sustaining, often

civil, infrastructure.²⁷ Corrupt the sustaining system and, like a diver deprived of his oxygen supply, the adversary military force may be ineffective.

The chief technical requirements for information attack that would need to be developed by the USAF in 2025 would include awareness of future trapdoors in computer programs and components; future systems to defend and penetrate, in peace and war, critical military, commercial, and educational, information-dependent systems; and future systems to protect against and deploy corrupt information via common carrier globally distributed information systems, false-flag (commercial products), or third-party (coalition partners) systems.²⁸ Capability for precision stealthy deployment of sensors and information attack devices would need to be developed. Most importantly, alternative sets of databases and communications architectures will need to be developed and kept on the shelf in the future. Returning to the classic North American Air Defense Command model, once the pattern of information-dependent human activities is identified, the information target can be detected and identified, and the data on which the activity is dependent could be intercepted, destroyed, or corrupted by appropriate replacement. Is this science fiction? The Air Force Scientific Advisory Board notes that “methods for attacking information systems are under development”²⁹ and future “technologies and concepts for intelligence gathering and information attack in the commercially based, distributed global information system of 2025” can be discussed.³⁰

If, for example, an emerging peer competitor of the type identified as “Khan” in the *2025 Study* were to conduct missile tests or war games in an area or manner deemed unacceptable to the US or an ally, a standard response might be to redeploy a US carrier battle group to the region to signal or deter. The asymmetric strategic response would be to conduct information warfare through several means. Data could be manufactured and broadcast from USAF satellite assets which showed to all parties listening that Khan’s missiles are woefully inaccurate as second-stage burn was only 87 percent complete. This would be indirect IW. The future capability needed for direct IW through information attack would be the insertion of the identical data into Khan’s own sensor systems and the sensor systems of third parties, say a regional ally of Khan, to confirm the data. Finally, and most ambitiously, Khan’s sensor architecture could be corrupted so that even if true data from, say, a commercial satellite system were examined, the corrupt results would still obtain. That one or two other sources might provide the correct data only complicates further the adversary’s

orientation and analytic problems. The battlespace of future conflicts could be shaped by the long-term effects of nonlethal disorientation information attack.

Notes

¹ Robert J. Wood, *Information Engineering: The Foundation of Information Warfare*, (Maxwell AFB, Ala.: Air War College Research Report, 1995) {available from Air University Library, Maxwell AFB}

² Air Force Scientific Advisory Board, *New World Vistas: Air and Space Power for the 21st Century - Summary Volume*, (1995), 19.

³ USAF, Air Force Doctrine Document-1, 10.

⁴ Air Force Scientific Advisory Board, *New World Vistas: Air and Space Power for the 21st Century - Summary Volume* (1995), 22–4.

⁵ *Chips*, 14 no.1 (January 1996) special issue on the Defense Message System (DMS).

⁶ Martin C. Libicki and Jim Hazlett, “Do We Need an Information Corps?,” *Joint Force Quarterly* no. 2 (Autumn 1993), 88–97.

⁷ John A. Warden, *The Air Campaign: Planning for Combat* (Washington, D.C.: National Defense University Press, 1988).

⁸ Bruce M. DeBlois, *et al.* *Dropping the Electric Grid: An Option for the Military Planner* (Maxwell AFB, Ala.: Air University Press, 1994).

⁹ Air Force Scientific Advisory Board, *New World Vistas: Air and Space Power for the 21st Century - Summary Volume* (1995), 26.

¹⁰ Michael J. Witt, “U.K. To Test Civil Computers in Secure Defense Arena,” *Defense News* (1–7 April 1996), 12.

¹¹ Pat Cooper, “War Game Reveals IW Vulnerabilities,” *Defense News* (4–10 March 1996), 33.

¹² *Legal Aspects of Information Warfare Symposium - Conference Proceedings* (Maxwell AFB, Ala.: Air Force Judge Advocate General School, November 1995).

¹³ Frank Oliveri, “Unmanned Aircraft May Dominate Air Warfare,” *Defense News*, (4–10 March 1996), 8.

¹⁴ Air Force Scientific Advisory Board, *New World Vistas: Air and Space Power for the 21st Century - Summary Volume* (1995), 32.

¹⁵ Michael R. Mantz, *The New Sword: A Theory of Space Combat Power*, (Maxwell AFB, Ala.: Air University Press, 1995).

¹⁶ Jennifer Heronema, “Pentagon Must Give Equal Time to Commercial Users of GPS,” *Defense News*, (1–7 April 1996), 58.

¹⁷ George J. Stein, “Information War - Netwar - Cyberwar,” in B. R. Schneider and L. E. Grinter eds., *Battlefield of the Future: 21st Century Warfare Issues*, (Maxwell AFB, Ala.: Air University Press, 1995), 153–170.

¹⁸ Robert J. Wood, *Information Engineering: The Foundation of Information Warfare*, (Maxwell AFB, Ala.: Air War College Research Report, 1995), 35–47.

¹⁹ George E. Orr, *Combat Operations C3I: Fundamentals and Interactions*, (Maxwell AFB, Ala.: Air University Press, 1983).

²⁰ USAF, *Cornerstones of Information Warfare*, 4.

²¹ USAF, Air Force Doctrine Document-5, 7.

²² Norman B. Hutcherson, *Command and Control Warfare: Putting another Tool in the War-fighter’s Data Base*, (Maxwell AFB, Ala.: Air University Press, 1994).

²³ USAF, Air Force Doctrine Document-5, 7.

²⁴ Lawrence G. Downs, *Digital Data Warfare: Using Malicious Computer Code as a Weapon*, (Maxwell AFB, Ala.: Air War College student research project (1995), {available from Air University Library, Maxwell AFB}

²⁵ USAF, Air Force Doctrine Document-5, 7.

²⁶ Pat Cooper, "U.S. Must Boost C4I Models, Simulation," *Defense News* (1-7 April 1996), 46.

²⁷ Frank M. Snyder, *Command and Control: The Literature and Commentaries*, (Washington, D.C.: National Defense University Press, 1993).

²⁸ Paul DiJulio, *et al.*, "Communications-Computer Systems: Critical Centers of Gravity," in Air Command and Staff College, *Air Campaign Course 1993 - Research Projects*, (Maxwell AFB, Ala.: ACSC, 1994), 283-294.

²⁹ Air Force Scientific Advisory Board, *New World Vistas: Air and Space Power for the 21st Century - Summary Volume* (1995), 42.

³⁰ *Ibid.*, B-15.

Chapter 5

Into The Future - Information Attack in 2025

Information attack, while “platform-based” in the physical universe of matter and energy, is not the only counterplatform, and the USAF must move its authoritative doctrinal thinking in *AFDD-1* away from the idea that information attack involves only the use of computers and communications.¹

Indirect information warfare attacks the “observation” level of knowledge at which the information must be perceived to be acted on. In many cases, indirect IW will be platform-to-platform as, for example, offensive and defensive electronic warfare, jamming or other interference systems, and psychological operations via the successor systems to *Commando Solo*. It may, however, rely on nonelectronic old fashioned military deception and psychological operations. Offensive and defensive indirect IW will grow in importance as information dependence creates information targets for an adversary to exploit against the United States. The armed forces could become “vulnerable sophisticates” in the worlds of 2025.² Counterplatform is not everything, but counterplatform attack will not be obsolete.

Direct IW as information attack, on the other hand, corrupts the “orientation” level of knowledge so that adversary analysis, whether artificial-intelligence, information-technology based or, most importantly, based in the mind of the human decision maker, decides and acts with full confidence in either the information observed or the integrity of his (machine or human) analytic processes.³ Information attack, then, may or may not be counterplatform.

The future potential in information warfare to substitute precise and discriminate credible information— whether by the methods of C²W (deception, PSYOP, or other means) or information attack— to a precise and discriminate target decision maker is the essence of decisive maneuver as it may position the

adversary in space and time, by his own decision, in that strategic situation so disadvantageous “that if it does not of itself produce the decision, its continuation by a battle is sure to achieve this.” It is not so much perception management as orientation management. Information is both the target and the weapon: the weapon effect is predictable error. If, on the other hand, information attack fails and battle is necessary to convince the adversary the old-fashioned way, the differential information-in-war advantage provided by global awareness and the information-based planning and execution control provided by global reach may permit decisive maneuver by USAF air and space assets of such speed, precision, and discriminate force that the joint task force never leaves the Continental United States execute its dominant maneuver.

In the future operating environments marked by ambiguity, speed, and precision effect, it will be the relative or differential advantage in information, information processing, and communication and information security that will provide the narrow margin for victory. Future USAF mastery of information attack, through air and space power unconstrained by artificial notions of battlefield-only command and control warfare, could provide those capabilities for asymmetric strategic response based on decisive and differential information advantage in most future security environments.

Information warfare, in this essay, was defined as “actions taken to achieve relatively greater understanding of the strengths, weaknesses, and centers of gravity of an adversary’s military, political, social, and economic infrastructure in order to deny, exploit, influence, corrupt, or destroy those adversary information-based activities thorough command and control warfare and information attack.” The only question is whether the USAF is prepared to take those actions.

Notes

¹ USAF, Air Force Doctrine Document-5, 7.

² Richard Szafranski, “A Theory of Information Warfare: Preparing for 2020,” *Airpower Journal* 9 no. 1 Spring, 1995, 56–65.

³ Wieslaw Gornicki, “W cieniu bomby L,” *Przegląd Społeczny* “DZIS,” no.11-62 (1 November 1995), 48–60 [translated by the Federal Broadcast Information Service as “In the Shadow of the L-Bomb.”] Gornicki calls IW “the absolute ultimate weapon of the White Man” and fears the CIA is slipping viruses into computer software exported to a future “enemy of freedom.”

**A Contrarian View
of
Strategic Aerospace Warfare**



A Research Paper
Presented To

Air Force *2025*

by

Lt Col Robert D. Gaudette
Maj Christopher A. Cook
Maj Terrence J. Foley

August 1996

Disclaimer

2025 is a study designed to comply with a directive from the chief of staff of the Air Force to examine the concepts, capabilities, and technologies the United States will require to remain the dominant air and space force in the future. Presented on 17 June 1996, this report was produced in the Department of Defense school environment of academic freedom and in the interest of advancing concepts related to national defense. The views expressed in this report are those of the authors and do not reflect the official policy or position of the United States Air Force, Department of Defense, or the United States government.

This report contains fictional representations of future situations/scenarios. Any similarities to real people or events, other than those specifically cited, are unintentional and are for purposes of illustration only.

This publication has been reviewed by security and policy review authorities, is unclassified, and is cleared for public release.

Contents

<i>Chapter</i>	<i>Page</i>
Disclaimer	ii
Illustrations.....	iv
Acknowledgments.....	v
Executive Summary	vi
1 An Introduction to Strategic Warfare in 2025	1
A Perspective.....	3
2 The World of 1996.....	5
Levels of Operation in 1996	7
3 The Vision of Strategic Aerospace Warfare in 2025	9
Alternate Futures.....	9
The 2025 Vision.....	10
Harmony Amidst Cacophony.....	11
Chaos or Nonlinear Response.....	12
Nonlinear Systems and Strategic Analysis.....	12
Formlessness.....	16
Single Level of Operation in 2025.....	16
The 2025 View of Warfare	17
4 The Strategic Decision Maker in 2025.....	20
Training for Strategic Understanding	20
Organizing for 2025	21
Planning in 2025	23
Strategic Decision Support System	24
5 Conclusions and Recommendations	26
<i>Appendix</i>	<i>Page</i>
A Functional Concepts	28
Global Awareness	28
Global Reach.....	29
Deny Sanctuary	29
Lift Capacity	30
Precision Insertion and Withdrawal.....	30
Global Power	31
Perception Management	32
B Proposed Organizational Structure.....	34

<i>Appendix</i>	<i>Page</i>
Staff Flexibility	34
The Polynoetic Organization	35
J-Staff Functions	37
Bibliography	43

Illustrations

<i>Figure</i>	<i>Page</i>
2-1. Current Joint Doctrine Levels of War	6
3-1. The Pinball Machine	13
3-2. The Pinball Machine with Influence Added	14
3-3. The Pinball Machine with a New Decision Path Defined	15
3-4. The 2025 View of Warfare	18
B-1. The Polynoetic Organization	36

Acknowledgments

This paper's aim is to expand the boundaries of strategic aerospace warfare. We are indebted to the Strategic Air Warfare Study (SAWS) panel commissioned by General Fogleman, chief of staff of the Air Force. In this forum we were challenged to think and inspired to expand the vision of strategic warfare beyond the boundaries of the traditional roles and missions of strategic aerospace forces. Many thanks to Lt Col Bob Gaudette, one of three members of this writing team.

Executive Summary

This paper presents a new vision of strategic aerospace warfare that expands and looks beyond the traditional roles and missions of strategic aerospace forces. Current joint doctrine divides warfare into three separate levels: strategic, operational, and tactical. Actions in these levels are many times planned, prepared, and executed with very different emphasis on size, scope, and importance. This division of objectives has met with varied success throughout history with many tactical victories leading to strategic defeats. It is important not to disregard the lessons of history as the theory needed to operate effectively in the year 2025 is developed.

The alternate future scenarios developed in the *2025* study suggest the future will involve many different interconnected actors. Even in the year 2025, much of the general population may still not have access to communication systems. However, the leadership of most of these organized entities will. Understanding the effect of knowledge transfer systems upon the global system is the key to strategic warfare in the year 2025. As knowledge transfer systems expand, all leaders in the global community will have access to near-real-time information. As a result, the boundaries between the current strategic, operational, and tactical levels of warfare will fade, resulting in only one level of war—the strategic level.

Strategic aerospace forces will be used to influence the will of the adversary's leadership. Due to the impact of information, all actions will have some measurable effect on the contextual elements that make up the leadership's decision-making process. To successfully influence and maintain harmony in the global system of 2025, our aerospace forces must:

- 1) View the world as a single system by expanding from a regional to global perspective.
- 2) Recognize the strategic impact of daily operations and decisions on the global system.
- 3) Create a leadership corps to be expert practitioners in the art of war.
- 4) Reorganize for efficiency and creativity. Organizations must be flattened to maximize the interchange of knowledge and exploit the potential of a leadership corps.

5) Pass the responsibility for both war fighting and organization, training and equipping to the same location to take advantage of all actions having a strategic impact.

In the year 2025, successful application of all aerospace forces will be conducted with the intent to obtain the appropriate strategic effect while maintaining a balance of the global system. Information dominance is the key to proper employment of the functional concepts of Global Awareness, Global Reach, and Global Power. It is information that allows aerospace power to create strategic influence against an adversary's leadership. To effectively exploit this information vision, organization and capabilities must change to ensure that the strategic aerospace forces of the United States are prepared to skillfully employ the art of war and continue to support the will of our national leadership.

Chapter 1

An Introduction to Strategic Warfare in 2025

“Strategic Aerospace Warfare.” These words convey many grand images. A misty morning with hundreds of B-17s forming up for their mission to Berlin. Perhaps a more modern image of Minuteman missiles in silos and B-52s loaded and cocked on alert. The goal of strategic aerospace warfare has historically been to destroy or render useless the “enemy’s war making capacity and national will.”¹ “Precision” attacks upon petroleum production, ball bearing factories, weapons production facilities, power generating and distribution networks, communications, and even the enemy population, have characterized target sets used in conducting strategic aerospace warfare. The results of these campaigns reported in *The United States Bombing Surveys*, *The Air War in Southeast Asia*, and *Gulf War Air Power Survey Summary Report* indicate that strategic attack by aerospace forces fell short of the claims made by the airpower experts.² In these conflicts the bomber didn’t always get through to the target, and if it did the desired effect was not always as planned. Certainly strategic aerospace warfare has been effective in meeting the requirements of some of the national objectives that brought this country to war during the last 50 years, but it has fallen short of the claims proposed by Douhet, Mitchell, and Warden.

In this paper we will examine the role of aerospace forces in conducting strategic warfare in the year 2025. Some have suggested not much will change in the conduct of strategic aerospace warfare between now and the year 2025.³ They propose we plan and acquire systems that are faster and strike with greater precision. This may be a much too simple approach and one, if wrong, could leave us unprepared to succeed in the world of **2025**. To be successfully fought and won, wars of **2025** need to emphasize the subtleties of strategy and influence rather than relying predominantly on the precision use of brute force. Col Richard

Szafranski in his article, *Neocortical Warfare? The Acme of Skill*, correctly assesses the future of warfare as going beyond the “application of physical force . . . [in the] quest for metaphysical control.”⁴ But he stops short of recognizing that warfare in the future will not be conducted as it is today. Warfare today is characterized by local or theater clashes with adversaries mostly isolated from the global system. The actors that comprise the world in the year 2025 will be more connected much as organs are connected within a larger organism. This does not say the US won’t engage locally. What it does say is the successfulness of engagements in the year 2025 will be measured in terms of both short- and long-term effects upon the balance of the global system. Strategic aerospace forces will remain an important part of the US military as they will provide at times the only viable means to create the strategic influence required to preserve the balance of the global system.

Just as medical science has advanced in its knowledge of preventive medicine, the strategic aerospace forces of **2025** will be used to avoid and prevent conflicts. Strategic forces should be used to provide greater preventive control and influence to maintain the health of the global system. The armed forces of today are blunt and brutish and can be called upon to perform “surgery” on the small organs within the larger global organism whenever symptoms of sickness appear. This surgery is expensive both in treasure and human lives and may not be the ideal treatment for the sickness that has befallen the organism. The strategic aerospace forces of **2025** will need to continue to learn, organize, and become better equipped to provide care to the global organism and if at all possible to prevent the violent clash that constitutes war. Carl von Clausewitz in his book *On War* states, “War never breaks out wholly unexpectedly, nor can it be spread instantaneously.”⁵ There are opportunities to avoid force-on-force conflict and they must be maximized in the year 2025. Strategic forces will be used in the year 2025 much as an acupuncturist uses needles to influence the body’s central nervous system to maintain the balance of the human organism. Broadening our focus on high technology and systems to emphasize strategy and the art of warfare will ensure that our strategic aerospace forces are effectively employed daily to productively shape the ever-changing global system.

Our strategy and doctrine for **2025** must be sound. History is replete with actors assuming they possess either the ultimate in strategy or a weapon that provides an impenetrable shroud of invincibility. The French provide a fine example of the doctrine of static warfare becoming dogma between the world wars. The

French doctrine of methodical battle stressing firepower was inadequate to overcome the mobile battle of *Blitzkrieg*.⁶ Assuming the next war would be like the last, France poured millions of francs into building the Maginot Line and creating a mobile reserve force to rapidly move to forward positions in Belgium while leaving the area bordering the Ardennes forest lightly defended.⁷ French organization and command and control were predicated on the Germans' conducting another version of the 1914 Schlieffen Plan.⁸ The French believed the Maginot Line was impenetrable and would keep invaders from the East off French soil forever. The Germans saw the Maginot Line as simply an obstacle that if avoided would be unable, unlike an army, to pursue them as they drove to and secured the Channel. Six weeks after the start of "Plan Yellow", the whole of France fell, only years after the end of World War I and the French celebration of victory over Germany.⁹ This history lesson suggests that dogmatic adherence to doctrine, weapon systems, organizational structures, service obligations, or even thought processes will make our aerospace forces vulnerable to an adversary today and even more so in the year 2025.

A Perspective

This paper presents a perspective of strategic warfare that challenges the status quo. The following chapters aim to show the differences and similarities between 1996 and **2025** that we can expect to find in the future. To understand the role of strategic aerospace in the year 2025 we will begin by examining the joint doctrine of 1996. With this foundation we will leap forward to **2025** and examine the world of the future that we must begin to prepare for today. This vision of **2025** will highlight the changes in personnel selection and training, organizational structures, and planning tools that may be required to effectively operate in the global system supporting United States objectives.

Notes

¹ Dr James A. Mowbray, "Air Force Doctrine Problems: 1926 - Present," *Airpower Journal* 9, no. 4 (Winter 1995): 25–26.

² The United States Strategic Bombing Survey, Summary Report (European and Pacific War), 1945; reprinted in *The United States Strategic Bombing Surveys (European War) (Pacific War)* (Maxwell AFB, Ala.: Air University Press, 1987); Herman L Gilster, *The Air War in Southeast Asia: Case Studies of*

Selected Campaigns, (Maxwell AFB, Ala., Air University Press, October 1993); and Thomas A. Keaney and Eliot A. Cohen, *Gulf War Air Power Survey Summary Report*, (Washington, D.C., 1993).

³ The Strategic Aerospace Warfare Study (SAWS) panel commissioned by General Fogleman, chief of staff of the Air Force, also tackled the question of strategic warfare in 2025. Their yet unpublished paper proposes the nation-state will still be the predominant actor in **2025** and strategic aerospace warfare will take place between nation-states.

⁴ Col Richard Szafranski, USAF, “Neocortical Warfare? The Acme of Skill,” *Military Review*, November 1994, no. 11, 43.

⁵ Carl von Clausewitz, *On War*, ed. and trans. Michael Howard and Peter Paret (Princeton, N.J.: Princeton University Press, 1976), 78.

⁶ Robert A. Doughty, *The Breaking Point*, (Hamdon, Conn.: Archon Books, 1990), 325.

⁷ Doughty, 11.

⁸ Ibid.

⁹ Doughty, 331.

Chapter 2

The World of 1996

Today's joint doctrine considers strategic targets to be those things that support the adversary's capability to meet his strategic security objectives. The types of things targeted today may include the adversary's infrastructure, energy production, transportation, and command and control networks. The mission of today's strategic aerospace forces is to conduct operations to influence these target sets in attaining theater objectives that support our national security strategy.

Today's joint doctrine divides war fighting into three levels of combat operations: strategic, operational, and tactical. Though clear boundaries are not delineated, the levels are based upon their contribution to achieving the specific level's objectives.¹ The levels attempt to link strategic objectives with tactical action. Figure 2.1 represents the current joint doctrine divisions of warfare.



Figure 2-1. Current Joint Doctrine Levels of War

Actions in these three levels are many times planned, prepared, and executed with very different emphasis on size, scope, and importance. This division of objectives has met with varied success throughout history with many tactical victories leading to strategic defeats.

Sitting Bull led the Sioux and Cheyenne Indian nations to an overwhelming tactical victory over Lt Col George Armstrong Custer at the battle of Little Big Horn. What Sitting Bull did not foresee was the tactical action taken could magnify into a strategic defeat. Public outcry from the East demanded prompt reparation for the “massacre.” The unintended result forced upon the Indians was an unexpected move to reservations in Missouri. Sitting Bull was forced to flee to Canada and lost the ability to negotiate a fair settlement to the conflict. The Sioux and Cheyenne lost their homeland.²

Levels of Operation in 1996

The strategic level of aerospace warfare is conducted against those resources that have been identified as supporting the ability of the adversary to meet his strategic objectives and goals. The operational level links the tactical employment of aerospace forces with the strategic objectives. The tactical level focuses on the engagement of aerospace units in combat.³

Today great care is taken by planners to develop strategy from national policy. As the strategy flows from the strategic to the tactical level it increases in detail and focuses on the cause-and-effect relationships that are required to produce the desired end state in the operational area. The narrowing of focus is necessary in the current organization of the military to direct forces for employment. Theoretically, all actions down to the tactical level support the strategic theater objectives and the strategic objectives are known and understood throughout the theater of operation. However, in practice, tactical orders such as the air tasking order (ATO), do not clearly delineate the strategic aims supported by the tasking. A planner somewhere in a planning cell understands the causal relationship; the fighter in theater most likely does not.

Planning in 1996 uses cause-and-effect modeling to determine the desired courses of action to take in conducting an operational campaign. An example of this modeling is the Warden five-ring model.

The Warden five-ring model describes the enemy as a system.⁴ The system is broken into five different categories: Leadership, System Essentials, Infrastructure, Population, and Fielded Forces. Information has been suggested as the “bolt” that holds the system together. War is conducted by precisely attacking critical nodes supporting the centers of gravity (COGs) identified in the rings of the enemy system causing catastrophic effects and reducing the ability of the enemy system to operate effectively. The aim of warfare in this theory is not focused directly on the enemy’s fielded forces or even the strategic intentions of the enemy leadership. Instead Warden’s five-ring approach by creating paralysis attacks the ability of the enemy system to effectively operate and project power. Paralysis is created by shocking the enemy system with synchronized attacks throughout the system’s structure (parallel attack). The leadership is not affected directly because it is usually well protected. Success and imposition of our will on the adversary are attained by threatening the adversary’s continued existence as a modern industrialized nation. With no capability remaining to reconstitute, the enemy system collapses. It is truly a form of “death by a thousand cuts.”

The five-ring theory clearly demonstrates the linear cause-and-effect processes that are used today to plan engagements. Because the world is not linear, the cause-and-effect relationship will eventually break down. When this happens a disconnect will occur between the desired strategic objective and the lower-level operational and tactical objectives. To help overcome this shortfall and win the engagement conclusively, the strategic, operational, and tactical levels must be simultaneously attacked and the enemy nation effectively destroyed. This was how this nation fought in the historical conventional engagements of this century: World War I; World War II; Korea; Vietnam; and Operation Desert Storm.

Today using the three levels of warfare philosophy, the war is won by holding the continued existence of the adversary's nation at risk. Over the years this philosophy has worked with varied levels of success. It is arguable whether our most recent engagement in Operation Desert Storm was successful. Five years and many millions of dollars after hostilities officially ceased, our presence in the region is still required and Saddam Hussein is still influencing the global community.⁵ It seems our victory fell short of Warden's claim that strategic paralysis of the enemy system would lead to the changing of the enemy leadership's will.⁶ It is important to not disregard the lessons of history as the theory needed to operate effectively in the year 2025 is developed.

Notes

¹ Joint Publication (Pub) 3-0, Doctrine for Joint Operations, 1 February 1995, ix.

² *Encarta 95*, 1995 ed., s.v. "Sitting Bull."

³ Joint Pub 3-0, II-3.

⁴ Col John A. Warden III, "Air Theory for the Twenty-first Century," in Barry R. Schneider and Lawrence E. Grinter, eds., *Battlefield of the Future: 21st Century Warfare Issues* (Maxwell AFB, Ala.: Air University Press, September 1995), 107-8.

⁵ On the five-year anniversary of the end of Operation Desert Storm Saddam Hussein held a victory celebration. Though his country is a disaster and remains under an economic embargo, Saddam's influence and power is still felt in the region. Employment by Saddam of weapons of mass destruction is still a concern in the region.

⁶ Warden, 104.

Chapter 3

The Vision of Strategic Aerospace Warfare in 2025

Alternate Futures

Alternate futures or scenarios illuminate the challenges that will be faced in the future. The alternate futures of **2025** bound the future that could actually exist. Bounding the problem is much like the quantum description of particles within an atom. We do not know exactly where the particle is at any given time, but we do know the boundaries within which it exists. Examining the boundaries and understanding the themes common in the alternate futures planning space suggests an effective means of organizing, planning, training, and equipping of forces to meet the challenges posed in the year 2025.¹

The alternate future scenarios developed in the **2025** study suggest the future will involve many different interconnected actors. The landscape of **2025** may be dominated by one, two, or many actors and these actors may even take the form of nonstate entities. The overall system will be complex, and even the smallest actor could wield some amount of influence upon the global system. It is accepted that even in **2025** much of the general population of the world may still not have access to communication systems and decision-making processes within their entities. Even so, the leadership of most of these organized entities will. Understanding the effect of knowledge transfer systems upon the global system is the key to successful prosecution of strategic warfare in **2025**.

As knowledge transfer systems (such as intelligence nets, commercial satellite imagery, Internet, global news networks) expand, all leaders in the global community of **2025** will have access to information in near realtime. As a result, the boundaries between the current strategic, operational, and tactical levels of warfare

will begin to fade. This continued blurring of the already indistinct divisions of the classical levels of warfare leads to a situation where eventually all military action will have a measurable strategic impact on the adversary leadership's decision-making processes. The pervasiveness of information and knowledge available to the enemy must be exploited and incorporated into the planning, preparation, and execution of all military actions to shape the strategic response of the global system.

The 2025 Vision

In the world of **2025**, strategic aerospace forces may be called upon by our national leadership to provide flexible options for influencing the global environment. The following items stand as landmarks that will challenge our nation's aerospace forces in the year 2025.

- The global game board in **2025** will be very crowded and interconnected.
- Unpredictable nonlinear response to strategic influences will be experienced because of the rapidity of multiplexed feedback within the global system.
- Understanding the feedback processes will be crucial to accurate prediction of results. Outcomes will be influenced more by the type and condition of the feedback present than the degree of complexity or the number of variables in the system.
- The nation-state will not have a monopoly on influence and power. Whether **2025** is uni-, bi-, tri-, or multipolar, influence and power promoted by even small actors will reverberate throughout the global system.
- Information will dominate the global landscape with rapid cycle times measured against the speed of light. Much of what we see today, we will continue to see in **2025** just one million times faster.

Strategic aerospace warfare in **2025** will do much more than shape the battlefield; strategic aerospace forces will be used to shape the global system. In **2025** all things must be measured against the effect they will have on both the adversary leadership and the global system. An almost prescient application of aerospace forces will be required to ensure our desired endstates are attained without upsetting the delicate balance of the global system. Good situational awareness of the global system must be maintained to prevent

military action from creating undesired effects and subsequent vulnerabilities that could be exploited by an adversary.

The world of **2025** is full of strategic dangers and pitfalls. In an era of declining defense spending, aerospace systems must be acquired that will effectively influence and harmonize the global system of **2025**.

Harmony Amidst Cacophony

Success in **2025** will require the United States to redefine “winning.” War in **2025** will be even more difficult to fight as a zero-sum game with a clearly defined winner and loser. In **2025** successful methods to win will need to embrace as much as possible a win-win philosophy. Harmony is a concept that addresses this desire.

The many external and internal factors that may influence the global system in **2025** create a vision that could be characterized as a cacophony. Even the alternate futures dominated by a single nation-state or nonstate actor will be interconnected such that even small actors and their influence must be considered when examining the global system as a whole.

An illustration of a cacophony is a symphony orchestra before the beginning of a concert. With no direction from the conductor each instrumentalist (actor) is playing his own tune (following his own objectives). To an observer the sound generated at this point is discordant and very noisy. Upon the direction of the conductor (currently our role as the world’s sole superpower) each instrumentalist provides his contribution to the piece in harmony with the other players in the orchestra. This action, under the direction of the conductor, creates a composite sound from the orchestra (global system) that is in balance. Note that the harmony and richness of sounds of the different instruments blend to create a sound that is more beautiful than if all played the exact same melody. For this reason the output of the whole orchestra is much greater than the sum of the individual instrument parts. Unfortunately it takes only one instrumentalist (actor) playing out of tune (bucking the conductor's objective) to create discord for all the others in the system. To be effective the conductor must capture the attention of all the instrumentalists and demonstrate the mutual benefits that can be enjoyed by all as they follow the conductor's leadership. Certainly this example does not propose that the US dominate the global system to the point of removing the individual sovereignty of the

various nation-state and other actors. Rather, it is suggested that effective leadership must be performed in the global system to mold an environment that is mutually beneficial for all involved.

The world of **2025** will be full of challenges as the US seeks to interface successfully in the global arena. Careful understanding of strategic effects will allow aerospace forces to be used effectively to maintain harmony in the global system. Lack of understanding of strategic effects in the application of aerospace forces could lead to disaster.

Chaos or Nonlinear Response

How do we prevent our adversaries from responding differently from the way we desire? Chaos has been considered as a possible solution to the dilemma of predicting the response of the global system to strategic influence. Can chaos understanding be used in this situation to help us predict the unpredictable? Maj Bruce DeBlois in his paper *Deterministic Philosophical Assumptions in the Application of Chaos Theory to Social Events* shows that chaos is applicable to only deterministic systems. Chaos as a science may not be applied to a nondeterministic system. Social systems (at least those considered to be desirable) include the human element of freewill and are therefore non-deterministic.² This means unpredictable nonlinear response can be expected from the interconnected global system and chaos theory will not help predict the results. Understanding the nonlinear global system's reaction to influence must be the focus of our planning and employment of strategic aerospace forces in **2025**.

Nonlinear Systems and Strategic Analysis

The decision-making process used by planners must be balanced to ensure information derived from linear modeling and simulation does not over influence the acquisition of and decision to use certain types of weapons systems. James Polk has suggested that in some cases, "we have been led astray by computerized wargames . . . because the primary determinant of victory in these exercises is a preponderance of firepower [not the subtleties of human will]."³ The focus in determining the proper influence to apply is dependent on the contextual elements of the adversary, the predicted reaction of the adversary to the applied influence, and

the predicted second order effects on the global system. These all must be predicted as accurately as possible using nonlinear techniques including the genius of intuition.

The pinball machine is perhaps a good illustration of planning and applying appropriate and inappropriate influence on a system. In a pinball machine a steel ball is shot to the top of a ramp comprised of a matrix of bumpers, pads, rails, and other obstacles. As the ball rolls down the ramp it is influenced by Newtonian physics and the obstacles it comes into contact with. Some obstacles take energy from the ball, some add energy. The path the ball takes is the result of the influences upon it. For an element to have influence (change the path of the ball) the ball must come into contact with it. A decision path of a notional leader is shown in figure 3.1 below.

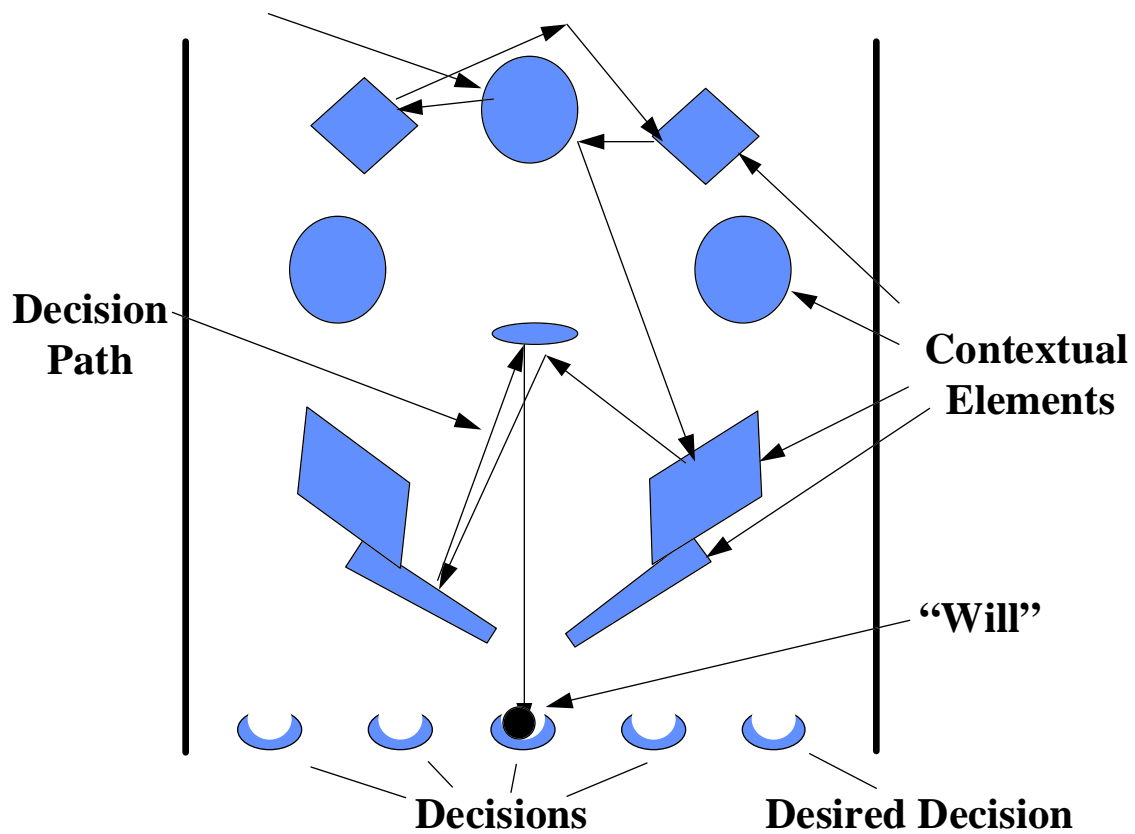

Figure 3-1. The Pinball Machine

The ball in this example represents the “will” of the adversary’s leadership during one decision cycle. The ball contacts various obstacles that represent the various contextual elements within the adversary’s system in its journey down the ramp. The will of the leadership is influenced by the contextual elements

within the system. As illustrated below the effect of the contextual elements upon the decision process can change as the priority of values change (such as the different values displayed by leaders in war versus peace) and as external factors such as information are added and subtracted from the system.

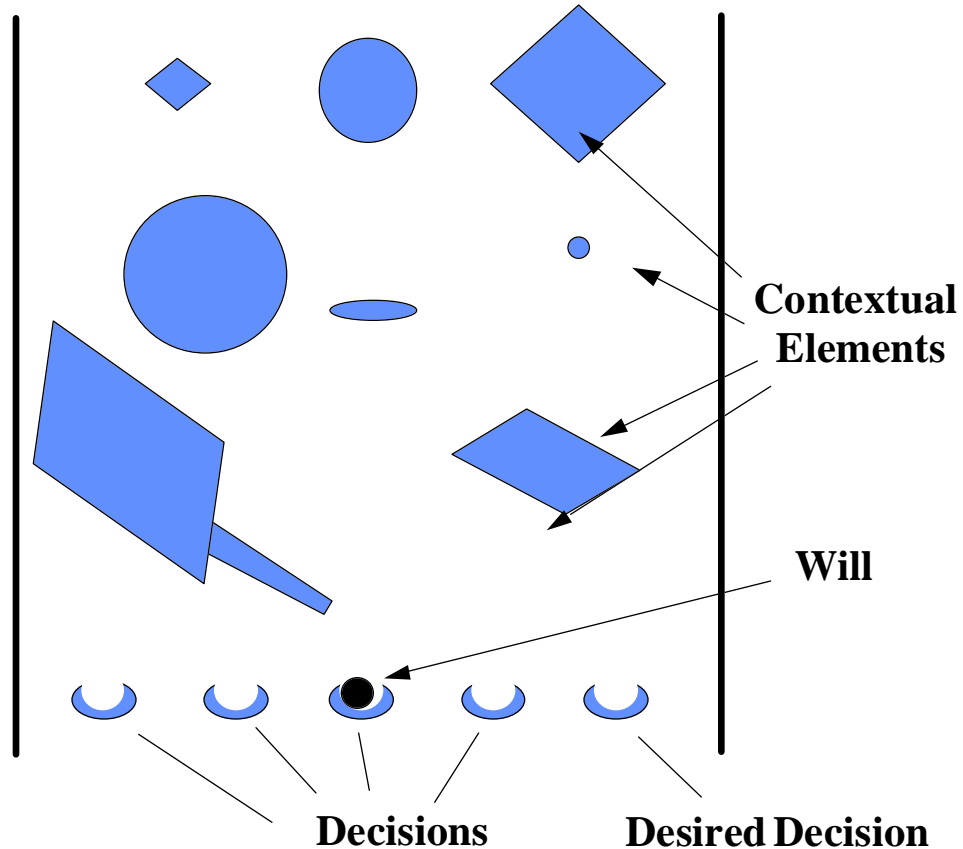

Figure 3-2. The Pinball Machine with Influence Added

By understanding the contextual elements that are affecting the adversary's decision process and applying the appropriate influence (in this example by adding/removing or perhaps changing the power exerted on the ball by an obstacle), the will of the leadership can be directed to a more desirable conclusion (as defined by our own national security policy). The inappropriate application of influence in this system would be

1. influencing contextual elements that are not considered by the enemy leadership,
2. adding or subtracting too much energy and deflecting the will away from the desired result, and
3. creating problems equal to or greater than those we are attempting to resolve through second order effects on the global system.

As defined by Clausewitz, the focus of military action is on the will of the enemy leadership.⁴ Notice in this example that there are no levels of engagement (e.g., strategic, operational, tactical). What really matters is the effect of the action on the enemy leadership's decision cycle. This suggests that in **2025** no action at any level of warfare should be undertaken without regard to its expected influence on the will of the enemy leadership.

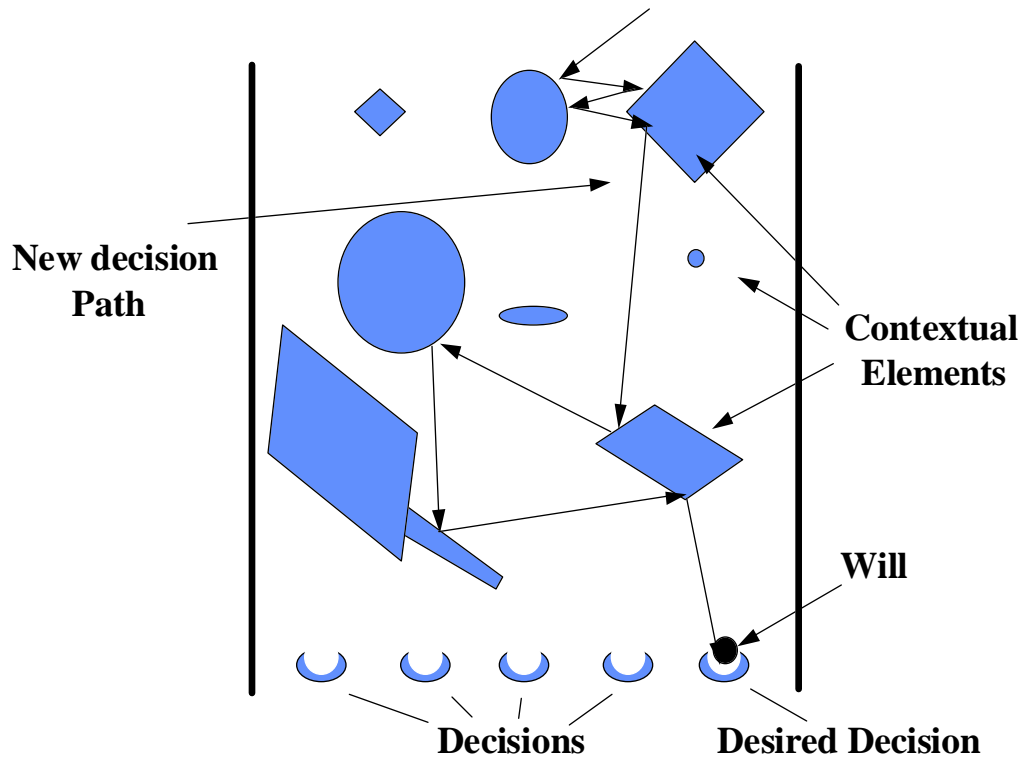

Figure 3-3. The Pinball Machine with a New Decision Path Defined

Due to the human element, it will always be impossible to determine and predict every potential response an adversary will have resulting from a strategic influence. Preparation and training must be accomplished to maximize the understanding and correct identification of the contextual elements that may influence the will of the adversary's leadership. Correct prediction will prevent surprise and unnecessary bloodshed.

The world of **2025** will require both subtle and sometimes severe influence to direct the adversary leadership's will to harmonize with our desired endstate. To recap from the previous illustration, proper influence of the leadership's will in **2025** will require

1. that the influence used will affect the leadership's will,
 2. that the influence used will properly deflect the enemy's will in the direction of our desired endstate,
- and
3. that the use of the influence will not create any undesirable (defined by our policy) secondary effects on the rest of the global system.

War is a two-way street. Influence applied to an adversary must be done while protecting the contextual elements that will influence our own nation's leadership.

Formlessness

We must protect our nation's vulnerabilities by using deception as Sun Tzu suggests to appear distributed and formless to any adversary.⁵ On the road to **2025**, technology must not drive the acquisition decision process. The temptation is great but it must be resisted to ensure that technology does not create systems that are easy targets for a motivated adversary. The development of monolithic systems and the creation of force capabilities around them makes aerospace forces vulnerable to the enemy's influence. In the year 2025, our forces must be flexible enough to influence the varied contextual elements of the adversary's leadership or they will be ineffective. Strategic aerospace forces must be capable of changing rapidly to adapt and apply influence to the changing contextual elements of the adversary.

Single Level of Operation in 2025

In the year 2025, daily activity will require planning and prediction to assess the effects of influence on the global system. This is not to say every action in the world will have a strategic effect, but rather, every action may have an effect and an effort should be made to understand and direct the outcome. The key to the interconnection of the global system, as previously stated, will be information.

Information will create a metaphysical relationship between all the global actors. Since the leadership within the global system will have access to many varied sources of information, each military action will have the potential of affecting the contextual elements that influence the leadership's expression of will. The Cable News Network (CNN) factor has already shown its enormous power to influence. Some cases in

point: During Operation Desert Storm, CNN televised a multitude of coalition attacks against Iraqi forces and other targets. It is very likely these images and the knowledge that the whole world was seeing them influenced Saddam. The CNN images certainly seemed to influence our own leadership. President Bush's decision to end the ground campaign after 100 hours was driven by the desire to prevent unnecessary slaughter and images of the unbelievable destruction on the "road of death" leading from Kuwait back to Baghdad from appearing on CNN and affecting the solidarity of the coalition. This decision allowed the Republican Guard to escape to the north (maybe in retrospect the wrong thing to let happen), but it kept the coalition together (at the time maybe a greater concern). In a more recent example, there were no forces in Somalia that could have stood against the US forces deployed there in 1994. The images on television of a dead US Army Ranger being dragged through the streets created an large public outcry in the US. Two weeks later the US withdrew from Somalia. This result probably exceeded all expectations of the Somali warlords who directed that incident. It is a good example of the effect information has today on the leadership's will and the fusing of the levels of warfare into one. In other words, a strategic goal resulted from a tactical action. It may be helpful to view the effect of information upon any event in **2025** as shown below.

Event + Effective Application of Information = Appropriate Strategic Effect

or maybe even

Event * Effective Application of Information = Appropriate Strategic Effect

In any case information is a factor that must be considered and used in the application of military power to create strategic effects and influence the will of the adversary's leadership.

The 2025 View of Warfare

In the year 2025 successful application of all aerospace forces (since every aircraft, satellite, acquisition decision, etc. might have a strategic influence depending on the adversary) will be conducted with the intent of obtaining the appropriate strategic effect while maintaining the balance of the global system. Information Dominance is the key to proper employment of the 1996 aerospace functional concepts of Global Awareness, Global Reach, and Global Power. As illustrated below, it is information in **2025** that will allow aerospace power to create strategic influences that effect the adversary leadership. Further explanation and

development of the functional concepts of Global Awareness, Power, and Reach are contained in appendix

A.

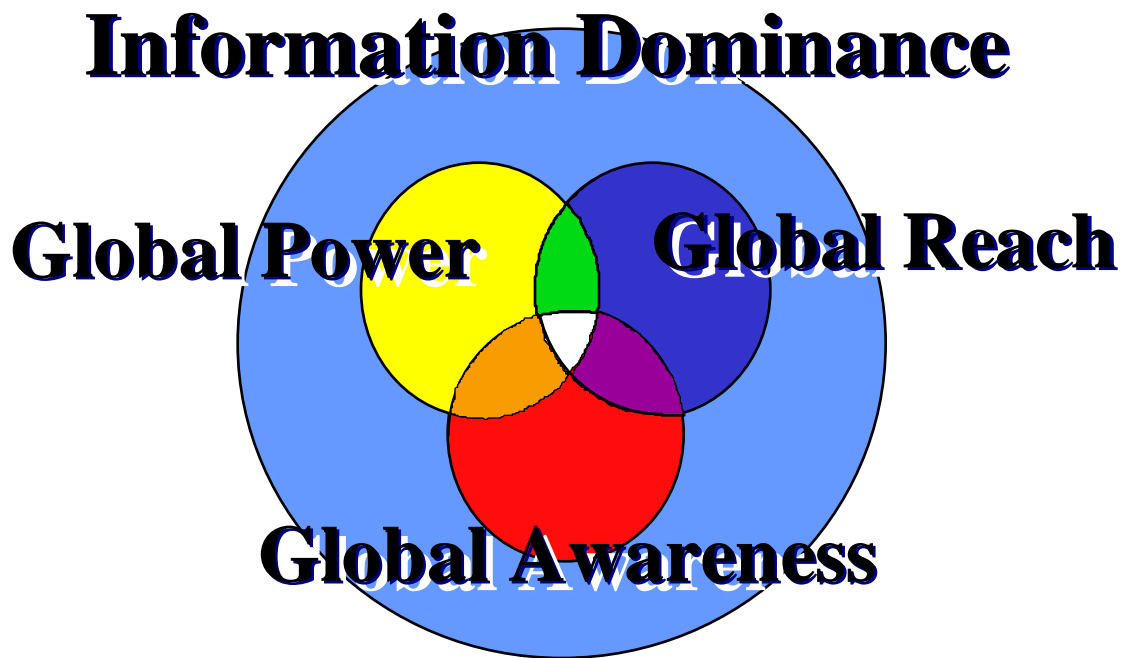

Figure 3-4. The 2025 View of Warfare

Successful operation in the year 2025 requires understanding and acceptance that even the most mundane items may have great strategic impact. Even today information magnifies small actions into large effects, such as the criminal actions of a few sailors and Marines in Okinawa, which threaten the continued basing of US troops on the island.⁶ The subtleties of influence will define the world of 2025. Effective exploitation of information will allow aerospace forces to meet the challenges of the future.

Notes

¹ Alternate futures were developed by the 2025 study team using creative thinking techniques. The alternate futures that were developed describe the extremes that could exist in the year 2025. Further information on the 2025 alternate futures can be found in the yet unpublished white paper, *Alternate Futures for 2025*.

² Maj Bruce M. DeBlois, *Deterministic Philosophical Assumptions in the Application of Chaos Theory to Social Events*, Unpublished paper, (Maxwell AFB, Ala.: School of Advanced Airpower Studies).

³ Quoted in Chet Richards, *Modeling and Analysis of Strategy and Decision?*, (Marietta, Ga.: Lockheed Corporation and The Georgia Institute of Technology, 1991), 1.

⁴ Clausewitz, 75.

⁵ Sun Tzu, *The Art of War*, trans. by Samuel B. Griffith (London: Oxford University Press, 1963), 66–67.

⁶ “U.S. will give back some Okinawa land,” *The Montgomery Advertiser*, (The Associated Press: Monday, April 15, 1996), 4A.

Chapter 4

The Strategic Decision Maker in 2025

In the year 2025 our forces will operate in an environment much different from today. All operations (training, exercises, deployments, force application) will insert power into the global system causing shifts in the balance of power and a resulting system response. Daily aerospace activities will be used to maintain or upset the balance of the global system and project power to guide decision-making processes. Idealistically, proper application of power will create true harmony within the global system. Realistically, strategic influence will be required daily to fix yesterday's problems, while creating tomorrow's problems. This chapter addresses three areas, that if concentrated on today, may in the next few years provide a strategic force more capable of successful influence in the year 2025. The areas of focus proposed are training, organization, and planning.

Training for Strategic Understanding

As previously discussed, the global system will be characterized as nonlinear but not chaotic due to its nondeterminant nature. To effectively operate in the world of **2025** all aerospace force leaders' training must increasingly emphasize the art of war. The focus on the "soft" ideas of persuasion, agility, subtlety and influence as found in Sun Tzu and "fog and friction" espoused by Clausewitz will help personnel understand and influence nonlinear systems. Training with simulation as done today is very cost-effective, but in simulation it is extremely difficult to insert the human element or moral factors described above.¹ Mathematical limits are imposed on computers by Godels theorem and the Church-Turning thesis that will prevent a simulation from ever being able to completely replicate the human mind.² War will always

remain an art. The focus on high-technology weapons systems must not be allowed to cloud the creative critical thinking of aerospace personnel to make accurate and sound strategic decisions on the application of strategic influence.

The environment of *2025* will require a special kind of officer, planner, and leader that can view and understand the global system and manipulate influence to direct the will of the various actors that make up the system. Just as pilot training selects individuals with certain demonstrated qualities to fly fighters instead of transports (or vice versa), individuals who have the ability to think and make correct strategic decisions in a nonlinear environment must be selected to monitor and influence the global system.

This idea of a notional planner/strategic decision maker, leads to the creation of a leadership corps. Much like the Prussian General Staff, individuals with demonstrated potential early in their career (two to four years) should enter specialized training to increase their abilities to judge and influence nonlinear systems in preparation to become members of the planning staff. By the time these individuals reach the 15-20 year point they should be experts in the operational art of warfare. The key characteristics of the leadership corps should be the ability to quickly synthesize information and the ability to rapidly choose a course of action that correctly influences nonlinear systems without upsetting the balance of the larger system. The individuals comprising the leadership corps should be trained to measure, understand, and guide the global system using the appropriate application of the military instrument of power (in conjunction with the other instruments of power) to maintain harmony. Those who are unable to effectively operate in this complex environment should be moved out of the leadership corps.

Organizing for 2025

In the year 2025 the organizational structure used by aerospace forces must be optimized to both plan and direct proper influence upon our adversary's leadership. The proposed highlights of this future organization are

1. innovation and awareness that allow seamless planning and simultaneous execution within the theater and subregion of operations,
2. adaptability and flexibility to transform the organization to effectively meet the posed challenges,

3. nearly instantaneous feedback after influence is applied to understand the adversary's new or continued strategic intent, and

4. a distributed and dispersed network to create invulnerability.

The function of any organization is to maximize the capabilities of the individuals who are assigned to it. The organization created for **2025** must maximize the leadership corp's ability to direct global influence. Effectiveness in the year 2025 will be somewhat proportional (due to the nonlinearity of the system) to our ability to dominate the information spectrum. According to Alvin and Heidi Toffler, "a revolution is occurring that places knowledge, in various forms, at the core of military power. In both production and destruction, knowledge reduces the requirements for other inputs."³ The function of the **2025** military organization will be the management and application of knowledge. Knowledge is different from information in that it has been processed. Information becomes knowledge when it is received, understood, and been provided a measure of significance to be used by the rest of the organization.

To effectively manage knowledge, organizations must be as flat as possible, and staffed with creative thinkers. Combining the staffs that organize, train, and equip with the war fighting staffs would maximize efficiency in properly assigning influence since the decision to conduct or not conduct an exercise next to an adversary's country might be more effective in directing the will of the adversary leadership than dropping a bomb. Remember, everything in the year 2025 can have a measured influence on the global system if it has an effect on the will of our adversaries. So it doesn't make sense as we prepare for **2025** to continue to separate these functions. The same staff that creates and measures strategic influence must also organize, train, and equip. Some ideas and proposed changes to today's organizational structure that will prepare the Air Force to meet **2025** are contained in appendix B.

Knowledge must be shared easily internally and externally to the organization. Some type of low-level artificial intelligence may help route knowledge throughout the organization to the proper decision makers without excessive time delays or human intervention. This will enable the sharing of knowledge without time lost interpreting or translating. With knowledge available and decision makers properly trained, the planning staff of **2025** is now ready to plan.

Planning in 2025

“Strategic” targets in the year 2025 are a function of the contextual elements that influence the decision-making capability of the adversary’s leadership. They may or may not correlate to the western standard ideas of: petroleum, oil, and lubricants distribution and storage areas, electric, C3, and so forth. It is entirely dependent on who and what makes up the adversary’s leadership decision making process, what influences the will. To clearly understand the appropriate influences to undertake, we must know what makes our adversary tick. What do they hold to be ground truth? What do they hold close? How do they perceive the United States? How do they regard world opinion? Where are they vulnerable? The answers to these questions will result in a strategic plan. Combining the strategic vulnerabilities of each global actor with our own vulnerabilities and capabilities will provide a vision of the global system. With this vision and understanding we can more effectively influence the global system to maintain harmony. This task is enormous. To properly accomplish it we must create organizations and tools to support our leadership corps decision making process.

As noted by Sun Tzu, success is more likely attained when we know both our enemy and know ourselves.⁴ By thorough examination of both the contextual and operational elements in each region and effective measurement of the effects of previous influences applied we may be able to more accurately model the boundaries of the nonlinear global system.

So where should strategic aerospace warfare be planned? Is this purely a national command authorities (NCA) or a Department of Defense (DOD) function? Is it a function of Intelligence? Where exactly should strategic analysis be accomplished? This question has been haunting aerospace planners since the inception of airpower. Lt Col Donald Wilson, while serving as director of the Air Strategy and Tactics department of the Air Corps Tactical School ACTS in 1939, directed that students be informed, “of the necessity to carry intelligence work far enough to provide a detailed analysis of objectives and targets within those objectives.” Maj Muir S. Fairchild, who taught the national economic structure course, took a different view by stating that gathering complete information concerning targets was, “a study for the economist, statistician (or) technical expert, rather than the soldier.”⁵ For over 50 years we have been depending on experts outside the DOD to determine what we should influence. This has been ineffective in providing information to the war

fighter in a timely manner to properly apply strategic influence. The leadership corps, as experts in the operational art, must be able to effectively measure and control the influence upon the global system.

But who is going to perform the functions of this strategic analysis? This function should be performed at the theater level, with interaction to a national-level agency that would provide a global view. To properly understand and truly create knowledge from the tremendous amount of information that is available in the year 2025 we propose the creation of a strategic decision support system.

Strategic Decision Support System

To achieve a time-limited response capability and reduce our decision cycle time, a planning and measurement system must be designed to effectively analyze and support the leadership corp's decision process. In the year 2025 the use of societal models must be used to understand and predict the consequences of our day-to-day military operations, as well as our crisis response.

A streamlined decision-making process should emphasize knowledge flow. The leadership corps must be able to rapidly identify capabilities and requirements necessary to deal with any situation that may arise and direct the proper influence to be applied. This type of decision support system will be required to effectively reduce our observe-orient-decide-act (OODA) loop⁶ and provide a framework for appropriate decisions.

As influence is applied, the leadership corps must be able to effectively monitor and assess the global strategic impacts of the influence. There must be a feedback into the strategic decision support system framework that allows timely review of the impacts and creation of new decisions based on the new knowledge.

Again the concepts of Godel and Church-Turning demonstrate that, "human understanding can not be an algorithmic activity."⁷ Machines will never have the intelligence to replace the human mind. But, machines do provide effective analytical tools to support decision making. Albert Clarkson in his book, *Toward Effective Strategic Analysis*, argues that computer systems are important analytical tools because they don't forget history and are free from operator bias.⁸ How often has history been repeated? Proper design and application of a strategic planning system will result in successful application of aerospace power in the year 2025.

¹ Chet Richards, *Modeling and Analysis of Strategy and Decision?* (Marietta, Georgia: Lockheed Corporation and The Georgia Institute of Technology, 1991), 11.

² Rodger Penrose, *Shadows of the Mind* (New York, NY: Oxford University Press, 1994), 51.

³ Alvin and Heidi Toffler, *War and Anti War: Making Sense of Today's Global Chaos*, (New York, New York: Warner Books, Inc.), 80.

⁴ Sun Tzu, *The Art of War*, trans by Samuel B. Griffith (London: Oxford University Press), 84.

⁵ Lt Col Thomas A. Fabyanic, *Strategic Air Attack in the USAF*, Research report no. 5899 (Maxwell AFB Ala.: Air University Press, Apr 1976), 41.

⁶ Maj David S. Fadok, *John Boyd and John Warden, Air Power's Quest for Strategic Paralysis* (Maxwell AFB, Ala.: Air University Press, February 1995), 16. OODA stands for Observe, Orient, Decide, and Act and has been developed by John Boyd to explain the process that is necessary to effectively engage and defeat an opponent. If you can operate your OODA loop faster and more accurately than your opponent can operate theirs you will gain a decisive advantage that will lead your opponent to confusion and defeat.

⁷ Rodger Penrose, *Shadows of the Mind* (New York, NY: Oxford University Press, 1994), 51.

⁸ Albert Clarkson, *Toward Effective Strategic Analysis* (Boulder Colo.: Westview Press, 1981).

Chapter 5

Conclusions and Recommendations

The world of **2025** will be complicated and challenging. Knowledge transfer networks will interconnect the global system causing it to react much like a single, large organism. Strategic aerospace forces can be used preventively to influence and maintain the balance and harmony of the global system.

2025 will have only one level of warfare—the strategic level. Strategic aerospace forces will be used to influence the will of the adversary’s leadership. All action will have some measurable effect due to the impact of information on the contextual elements that makeup the leadership’s decision-making process.

Now is the time to begin to prepare for the future of **2025**. To successfully influence and maintain harmony in the global system of **2025** our aerospace forces must

1) Recognize the world as a single system. The vision and decision making processes used by strategic aerospace forces must be expanded from a regional to a global understanding.

2) Recognize the strategic impact that our day-to-day operations and decision making have on the global system. Daily decisions must be measured and gauged by their influence on the global system.

3) Create a leadership corps to be the expert practitioners in the art of war.

4) Reorganize for efficiency and creativity. Organizational structures must be flattened to maximize the interchange of knowledge and the potential of the leadership corps.

5) Pass the decision responsibility for both war fighting and organizing, training, and equipping to the same location. This will take advantage of all action having a measurable influence on the global system.

2025 will present the United States with many challenges. Strategic influence will come in many forms and varieties. The knowledge organizations will be necessary to function successfully in the future global

system and must be created now. Vision, organization, and capabilities must change to insure the strategic aerospace forces of the United States are prepared to skillfully employ the art of war and continue to support the will of our national leadership.

Appendix A

Functional Concepts

Global Awareness

The futures of 2025 dictate a requirement for the United States to maintain information dominance. As the Internet and other means of communication make the world a smaller place, the need for near-real-time information processing (awareness) will be critical. With the global game board becoming more crowded and interconnected, the US must have the awareness to deal with all the variables that will make up the strategic level of war. Global Awareness is the ability to predict and measure the impact of aerospace forces on the global system.

The United States must be able to quickly assess situations and determine the appropriate response to each situation to meet our strategic objectives. To accurately assess a situation and determine the appropriate response, we must create officers trained in the subtleties of strategy and warfare. To help the decision-making process, technology must be employed to produce a system that supports the strategic decision-making process. This system must help planners accurately predict, by applying proper significance to the barrage of information overloading our systems, the strategic effects of any regional decision in a timely manner. By properly balancing the planners of 2025 with their tools, awareness and understanding of the global system can be created. That understanding will be used to reach and touch our adversary's decision processes.

Global Reach

Global Reach in the year 2025 is the ability of the US to influence an adversary leadership's contextual elements anywhere, at anytime. Aerospace forces are unique in that they have agility, speed, and range that allows continental US basing and still retains timely response to influence the adversary. Strategic implications of Global Reach include the ability to deny an adversary sanctuary, or the ability to cause disruption within an adversary's system by interjecting "force" into that system. To deny sanctuary, or to cause disruption within a system, an air force must have the ability to lift and project forces to areas of concern, and precisely insert and withdraw the required forces to accomplish the mission.

Deny Sanctuary

The ability to reach anywhere around the globe denies sanctuary to any potential adversary. "You can run, but you can't hide" is the primary theme for strategic aerospace warfare. In the year 2025 strategic aerospace forces will influence the complete spectrum of war from Military Operations Other Than War (MOOTW) to nuclear, biological, chemical (NBC) operations. In denying sanctuary, the adversary leadership must understand any potential strategic target can be "serviced" by aerospace forces. In the year 2025 physical sanctuary doesn't exist because of aerospace capabilities.

However, there are some potential shortfalls with the concept of sanctuary. The shortfalls that must be overcome may include political considerations, territorial integrity and neutrality, and "overflight" requirements.

Global Reach provides a means to reach and properly influence a strategic target. By "getting there" and exerting influence, the US achieves the desired impact on the adversary leadership's will. As an example, a terrorist base in a third party nation or territory may be considered a viable target and we must be capable of providing the correct influence if called upon by our NCA. Recent examples include Hezbollah terrorist's bases in Lebanon being struck by the Israeli Air Force. The dispute is not between Israel and Lebanon, but the territorial integrity of Lebanon must be violated for Israel to influence the "strategic" targets of the Hezbollah. Accordingly, the United States must be willing and able to work around the issue of territorial and airspace integrity of a neutral third party to deny sanctuary to our adversaries.

Lift Capability

Global Reach in the year 2025 is required to provide a global omnipresence that is achievable through both close and remote influencing. Close influence is defined as the projection of forces into the theater. Close influence will require lift that is fast, rapidly transformable, and capable of moving outsized articles. Remote influencing is defined as influence performed on things outside the theater and usually requiring support from other instruments of power. Both types of influence will be conducted through a wide range of means, all with the intent of guiding the adversary's leadership to harmonize their objectives with our own. Thus, conventional forces, in some situations, will still be required to forward deploy to meet our national objectives. In the year 2025 lift will still be provided by traditional aircraft, and possibly augmented with transatmospheric vehicles (TAVs) and ground-effect vehicles. In any case, strategic lift will remain the key element in providing global reach. Lift asset designs for 2025 must adhere to what they must transport. Thus the question: Who or what is going to require global transportation in the future?

Lift Capacity

The two major regional conflicts (MRC) posture used today will not work in the year 2025. **2025** will require the NCA to understand and influence tens, maybe hundreds, or even thousands of different nodes in the global system to maintain harmony. The NCA will use many different forms of influence, but many challenges will require the use of the military instrument of power. Military ground forces will continue to require transport to areas where their expertise is required. Deployment of Air Force assets and their logistics tail necessary to operate the platforms of 2025 will also require transport. The forces deployed and the items brought to the region will be measured in the overall effect they have on changing the adversary's objectives. We must continue to provide a lift capability to project strategic influence to far-flung regions of the globe.

Precision Insertion and Withdrawal

In the year 2025 equipment and personnel must be inserted and withdrawn precisely and timely. Lt Col John L. Cirafici, in his book *Airhead Operations, Where AMC Delivers*, proposes that,

The ideal situation for the supported combatant commander is for his forces to flow into theater airheads timely and be positioned where they are needed so that units can quickly and effectively reconstitute in anticipation of employment . . . while arriving forces are insufficient or relatively immobile, they can be destroyed by an opposing force. The airhead that the theater commander relies on for rapid introduction of forces and equipment is by its nature an area of vulnerability and, potentially, a bottleneck.¹

Global Reach must have the ability to insert and withdraw forces precisely to reduce the vulnerability of conventional “airheads” and eliminate the associated bottlenecks. Precision insertion and withdrawal gives the combatant commander the flexibility of providing influence where and when needed in the least amount of response time. It is only through effective Global Reach that we can even consider the application of Global Power.

Global Power

Power has been defined as “a psychological relationship between those who exercise it and those over whom it is exercised.”² Power has also been defined as:

The ability of any actor to persuade, influence, force, or otherwise induce another actor to undertake an action or change an objective that the latter would otherwise prefer not to do. It is also the ability of one actor to persuade, influence, force, or otherwise induce another actor to refrain from an action that it would prefer to undertake.³

Power is an interesting concept since its perceived capability has as much or more to do with its ability to influence an adversary than its actual capability. Also, power many times can take a form that is different from what we might expect. The announcement of the B-2 Stealth bomber to the world sent the USSR scurrying to understand the implications of an airplane that could fly undetected through their homeland. The cost of an air defense system capable of detecting the B-2 was far greater than they could afford. Their only solution, even though they had never seen a B-2, was to harmonize with our objectives and seek long-term peace. If a nation has both the will to use its instruments of power and the methods of employing its weapons, its position of power is elevated. The bottom line is the ability to influence an actor’s strategic interests based on his perception of your capabilities, real or imagined!

Perception Management

The intent of strategic aerospace warfare in the year 2025 will be to influence an adversary's leadership to harmonize with our objectives. The most effective method to do this will be through the subtleties of persuasion.

Persuasion is defined as “the process of preparing and delivering messages (through verbal and nonverbal symbols) to individuals or groups in order to alter, strengthen, or maintain attitudes, beliefs, values or behaviors.”⁴ The key words in this definition are: messages, alter, strengthen, and maintain. Messages are sent to get someone or something to believe what you want. These messages can be in many different forms, but we shall focus on the mental aspects of messages in this section.

The US can either send a direct, truthful message to an adversary, or it can use deception in maintaining an adversary's perception of US intentions. In our opinion, the US must maintain and continue to develop a robust deception program that keys on the adversary leadership's understanding. According to Sun Tzu, “All warfare is based on deception.”⁵ But be aware as Attila the Hun stated, “One thing a chieftain should always fear more than doing battle is doing battle when only pretending to be prepared.”⁶ We must always be prepared to back up threats with action.

The key in prosecuting a successful deception program is the ability to attack the mind of the adversary while still having the ability to do battle. John Boyd's OODA loop⁷ provides a model that demonstrates how deception can be used to strengthen and project power. Deception provides a very effective method of getting inside the cycle by disrupting the orientation portion. What is real? What is fake? What is the correct decision based on the information provided?

The vision of **2025**—Global Awareness, Global Reach, Global Power all performed under the umbrella of information dominance will provide the framework for successful direction of the global system.

Notes

¹ John L. Cirafici, *Airhead Operations: Where AMC Delivers* (Maxwell AFB, Ala.: Air University Press, March 1995), 67–68.

² Quoted in Daniel S. Papp, *Contemporary International Relations: Frameworks for Understanding* (New York, NY: Macmillian Publishing Company, 1994), 28.

³ Papp, 401.

⁴ Quoted in Gary C. Woodward, "Persuasion & Influence in American Life," (Prospect Heights, IL: Waveland Press, 1992), 18.

⁵ Sun Tzu, *The Art of War*, trans by Samuel B. Griffith (London: Oxford University Press), 41.

⁶ Wess Roberts, *Victory Secrets of Attila the Hun*, (New York, NY: Dell Publishing, 1993), 114.

⁷ David S. Fadok, *John Boyd and John Warden: Airpower's Quest for Strategic Paralysis* (Maxwell AFB, Ala.: Air University Press, February 1995), 16.

Appendix B

Proposed Organizational Structure

There are many areas today that could begin to transform for *2025*. By this we mean an ongoing study of contextual elements within the subregion to the region and finally to the theater level. The results of the theater analysis should be forwarded to a “notional” national agency that combines the results of the other commander in chief (CINC) studies to determine a global perspective that will provide guidance to make strategic decisions.

Staff Flexibility

Theater-oriented CINC staffs should be organized for maximum flexibility and adaptability to handle the myriad of potential contingencies that may arise in *2025*. The first step that needs to be taken is that all staffs everywhere adopt the organization of joint directorates.

Unless there is learning and evolution taking place in how you go about doing knowledge work—in how you’re organized to do it, how you handle knowledge, how you develop people, how you pay attention to the competitive environment—unless you’re constantly getting better at all of these things and more, you’re being sloppy, and there’s a good chance that, eventually, you will find your organization falling behind.¹

By instituting the joint-directorate approach in all organization’s, the flow of knowledge will have clearly defined paths. The J-5 of one organization should talk to the J-5 of another organization. They must not in the future waste time trying to figure out the difference between XONO, XOXO, or XONB and what information needs to flow where. Once we have created the framework for knowledge work we can now look at the requirements for decision making in our organizations of *2025*.

Mr Pasmore, in his book *Creating Strategic Change*, states that,

by the time people are ready to decide something, the knowledge work is over. Therefore, all of the attention that has been placed on organizational decision-making is in fact *misplaced*. The real knowledge work goes on long before the meeting at which the decision is made; and it tends to be a very messy, disorganized process, open to the full negative forces of human foibles and social dynamics.² By the time the decision is framed, the battle is over; it's classic garbage-in-garbage out.

To really affect the decision-making process, intervention and guidance must be inserted, “while the knowledge is still being developed.”³ To create an environment for effective decision making, the organization must be structured to maximize knowledge. We propose an organizational structure to maximize the potential of our leaders and planners discussed earlier.

The Polynoetic Organization

The classic “J-staff” has many centers of knowledge, from J-1 through J-8. To improve integration and knowledge transfer while retaining accountability, the proposed organizational structure for **2025** is a polynoetic organization presented by Mr Pasmore and illustrated below.

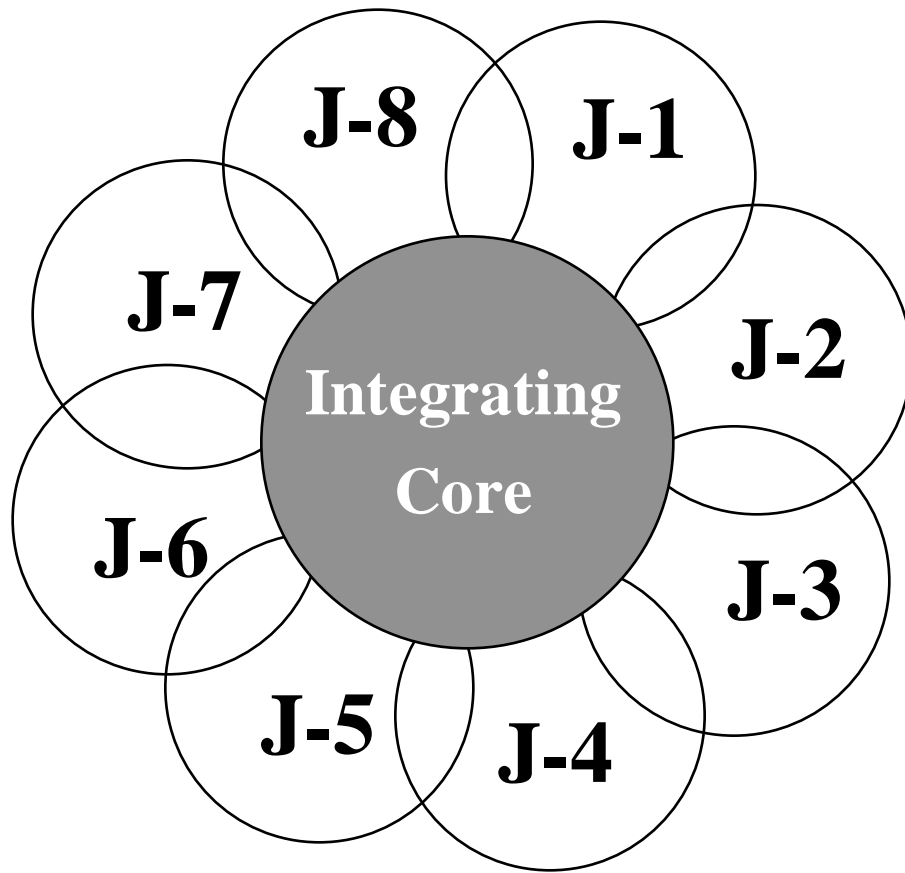

Figure B-1. The Polynoetic Organization

The polynoetic organization is coordinated by a central group of knowledge workers who are themselves representatives of the various projects and activities undertaken by the organization. In addition, the integrating group contains individuals who represent administrative support functions . . . which provide information crucial to decision-making when such information is appropriate. In contrast to typical top management groups, the integration group has no stable membership or roles. The membership of the group varies upon the topics under discussion, the players heading up important projects, and suppliers of information relevant to the discourse. The integration group provides overall strategy guidance and allocates resources among competing demands. Leadership within the integration group rotates depending again on the knowledge demands of the ongoing and special deliberations on the agenda.⁴

This organization of a staff can be transformed for the occasion. This allows flexibility to adjust a staff based on the circumstances and unleash the power of the integrating core made up of the leadership corps. For example, a logistics-intensive operation may require the J-4 to be the lead agent vice the J-3. An information-intensive operation may require the J-6 to be the lead agent. It also allows a multitude of

projects to be coordinated simultaneously integrating the various outputs. The intent of this organizational structure is to allow a CINC the ability to mix and match knowledge within his staff to create effective decisions and direct appropriate influence on the global system.

Structure has a direct bearing on the effectiveness of a staff:

The most important intervention to improve deliberation quality is to redesign the organization so that effective deliberations take place naturally, rather than fighting against improper structural influences. The organization design for effective deliberating takes into account the need to constantly⁵ realign knowledge with authority, yet integrate the outcomes of separate deliberations.

Another key aspect is the overlap of functional areas. All the J-staff functional areas should have some type of overlap or interactivity with the other J-staff areas. These “liaisons” are critical in sharing knowledge among the directorates and may in fact be automated computerized filters that sort through the piles of information and direct it to the appropriate joint directorate based upon keyword, icon, identification. In *2025* you no longer need to address where and to whom you believe your knowledge should go. Once it is created you just put it into the server and it is automatically routed to the appropriate agencies and anyone else who is pulling the data. We believe that to further enhance our ability to influence the global system properly, functions and duties within the joint directorates must expand.

J-Staff Functions

We must begin today reorganizing and restructuring the staffs to prepare them to properly influence the nonlinear global system. Each J-Staff directorate should be organized along the lines of the polynoetic organization as explained in the body of this paper. This organizational structure is integral to maintain the efficient transfer of knowledge on the staff and within the directorate itself. In fact each directorate is set up as a system within a system.

For example, the J-1 directorate should have liaison cells that interact on a daily basis with the J-2 through J-8. This keeps the integrating core of J-1 informed on the activities of the rest of the staff and helps reduce friction within the directorate. Additionally, the functions of liaison should be rotated among the “action officers” to keep them abreast of the activities within the other directorates and how they function. This is critical in maintaining an educated core of staff officers that can perform within several areas of expertise if the need arises. Functions within the directorates itself should be along the same lines as

described in Air Force Systems Command Publication-1. However, we believe that some areas need to be explored in greater depth.

J-1, Current contingency planning requires manpower to “open” a unit type code (UTC) to determine the exact manning requirements for that UTC. The manpower functional manager must coordinate with both the UTC functional manager and the AFSC functional manager to ensure proper manning for a contingency. This takes up more time than what should be considered appropriate. As **2025** approaches, manpower and personnel will have a critical function to deal with a smaller military. It will be essential that J-1 be the “lead agent” for *developing* force packages (manning levels) to deal with a contingency. However, the time for determining proper manning levels and coordinating through the functional areas must be done in a shorter amount of time than is done today. It would greatly enhance the planning process if the liaison cells for each functional area could report directly to a tasked unit for appropriate manning information. This becomes a critical concept when balanced against the possibility of a smaller Air Force and smaller manpower base. The CINC-level planners must have the authority to deal directly with other CINC’s to pull the appropriate manpower to deal with a contingency.

J-2, Intelligence: The emphasis of this directorate should remain on the “enemy”. However, greater emphasis should be placed on identification and contextual understanding of potential strategic targets within the global system (e.g., how they could be influenced and what type of feedback would be required to measure success in influencing those targets). The directorate should be divided into theater, region, and subregion teams. These teams should undertake a comprehensive analysis of contextual and operational elements for their area of responsibility on a daily basis (using a bottom-up approach from the subregion to the theater level). These teams must have a direct link to any other US intelligence agencies (Central Intelligence Agency, Defense Intelligence Agency liaison, etc.) for a complete analysis of their assigned areas. Key to success in this area will be the successful fusion of the enormous amount of information available through filters to create true knowledge. We recommend the consolidation of as many “intelligence” agencies as possible to flatten the intelligence community. Will there really be a requirement for the CIA in **2025**? What is the function of intelligence between a CINC staff and the CIA? Where does DIA fit into the equation? What is the purpose of the Naval Intelligence Command? We believe that intelligence is intelligence, regardless of who is providing it. Information must be shared, otherwise it is

useless. Get rid of the compartmented intelligence agencies and start basing intelligence on subregion to region to theater and finally to global for proper analysis. The coordination process is the most important aspect of planning. Based on the information provided by J-2, strategic targets can be identified prior to the onset of hostilities and effective means of servicing those targets can be coordinated by the other directorates.

Another important aspect of the J-2 should be feedback, or measuring success. A method must be determined before the onset of hostilities whether the selected influence is having the desired effect on the leadership's strategic aims. Access to all source information and monitoring adversary leadership positions on their original versus current courses of actions must be accomplished, and we believe it is the J-2's role to do this. It is crucial that an effective measure of an adversary's reactions be in place. By placing pressure on the adversary's strategic interests, the J-2 should be able to report probable or possible courses of action the adversary leadership may take. Once an action is taken by the adversary, it should be measured against the "desired" course of action and a resultant change in our strategic targeting should take place. This is the key element in prosecuting strategic warfare.

J-3, Operations: Directs and controls current operations. Work begins with the initial planning and extends through the integration and coordination of joint operations. May be charged with the conduct of special operations, including psychological operations and special warfare, joint training and coordination of joint exercises (AFSC Pub 1). Aerospace, land and sea components fall under the J-3 during contingency operations. These components must be able to identify capabilities for accomplishing the mission and conducting employment operations. To enhance the capabilities of the J-3, we feel some aspects of planning require drastic improvements to reduce planning cycle times and graphically displaying the end results of a "plan". These improvements include functional experts that can quickly identify requirements and a graphics display board.

Personnel Requirement: Properly trained functional experts that can rapidly identify weapon systems to accomplish the desired mission. These experts should have the functional expertise to determine which UTCs are required for mission accomplishment. They should be operationally oriented experts that have a broad knowledge in their respective fields of expertise (e.g., fighters, airlift, spacelift, engineering, support, etc.). The intent is to rapidly identify requirements for a CINC to accomplish a mission. Time is the essential factor to maintain information dominance and disrupt an adversary's OODA cycle. These

requirements should be graphically displayed on a planning board for a visual presentation for the planning staff.

Technical Requirement: 3-D holographic planning board. Display from theater to subregional view of the “battle space.” This should be applied to a “laptop”-type device with a window format to enhance deployment, employment, and redeployment planning. A window-in-window format would expand the area of emphasis showing possible beddown locations, terrain, strategic targets as determined by the J-2, enemy integrated air defense systems threat rings, global projection drop zones, and so forth. Once forces have been identified for deployment and beddown locations have been identified (using a “drag and drop” system with a movement priority identification system), the board could be used to war game an ATO or campaign to deconflict packages while viewing the “battlespace.” This system would enhance the commander’s overall view of the battlespace and graphically display the big picture. After witnessing the joint planning tool and other “systems”, it would make sense to fuse the displays to provide this information. However, it is becoming evident that technology is enabling the concept of centralized execution. This area needs further examination for future commanders and war fighters.

J-4, Logistics: Develops logistics plans and coordinates and supervises supply, maintenance, repair, evacuation, transportation, construction, and related logistics activities. Responsibilities may include weapons surety, civil engineering support, transportation management, and so forth. Because logistics support is a service responsibility, the primary thrust of joint logistics operations may be to coordinate service programs and integrate them with the joint commander’s concept of support. Knowledge of service policies and doctrine is essential (AFSC Pub 1). J-4 must be responsible for theater distribution of both manpower and equipment and not the components. They should also be responsible for determining all strategic lift requirements to move assets into their respective theater (based on the apportioned lift). The J-4 must have a system (comparable to the J-3 holographic planning board) in place that will display all friendly fielded forces that are involved in operations. This system should provide the J-4 the ability to provide a view of the battlespace for the purpose of updating deployment, sustainment, and redeployment operations through the use of all weather, precision delivery of supplies, manpower, and equipment.

J-5, Plans: Does the long range planning. Prepares campaign, concept, and operation plans and the associated commander’s estimate of the situation. Often, the J-5 is responsible for special weapons planning

(AFSC Pub-1). The J-5 should be organized into theater, region, and country teams to analyze contextual elements and create the appropriate oplans/conplans/functional plans and time-phased force deployment data plans. These teams should interface with J-2 teams and J-8 teams for comprehensive understanding of their areas of responsibilities. Additionally, the J-5 should be intimately involved in the acquisition process. All actions will have a strategic impact and the acquisition process will have major ramifications on the overall balance of strategic influence. The group in J-5 that would have inputs to the acquisition process would be performing the functions of a joint requirements oversight council/joint warfighting capability assessment team at the CINC level.

J-6, C⁴I: Functions include handling command responsibilities for communications and frequency control, tactical communications planning and execution, and management and development of electronics and automatic information systems to include hardware, software, and connectivity. Ensure interoperability with the services (AFSC Pub-1).The J-6 should be the CINCs lead agent for information warfare. They would be the experts of both hardware and software to prosecute information warfare. Based on the inputs from the other directorates, the J-6 would be able to execute.

J-7, Interoperability: This directorate should ensure joint operations are coordinated. Functions should also include Deception & Black programs. The J-7 would ensure these compartmented programs are integrated into any operation. Any “special” tasked mission should be run from the J-7 directorate. This directorate should have a secure facility that houses a special mission control area that would provide connectivity to any platform tasked to perform special missions. These missions would remain out of the public eye and could be planned, controlled and executed from this facility. The J-7’s from all the CINCs would require a special category (SPECAT) message system to ensure unity of effort for all operations and connectivity to the national level agency.

J-8, Resources (Civil Agencies): Liaison cells organized in the same manner as the J-2 would greatly enhance the interoperability of the military functions with all non-military agencies and organizations. Interaction between and with international nongovernmental organizations, international governmental organizations, international private organizations, Department of State, and the military becomes crucial. Staff members should become expert liaisons with political institutions such as the United Nations, civilian

institutions that may have economic instruments that may be useful to a CINC, and so forth, especially in view of the MOOTW aspect of operations that may become more prevalent.

Notes

¹ William A. Pasmore, *Creating Strategic Change: Designing the Flexible, High-Performance Organization* (New York, New York: John Wiley and Sons, Inc., 1994), 162.

² Ibid., 158.

³ Ibid., 159.

⁴ Ibid., 166.

⁵ Ibid., 165.

Bibliography

- Cirafici, John L. *Airhead Operations: Where AMC Delivers*. Maxwell AFB Ala., Air University Press, March 1995.
- Clarkson, Albert. *Toward Effective Strategic Analysis*. Boulder Colo., Westview Press, 1981.
- Clausewitz, Carl Von. *On War*. ed. and trans. Michael Howard and Peter Paret. Princeton, N.J.: Princeton University Press, 1976.
- DeBlois, Maj Bruce M. *Deterministic Philosophical Assumptions in the Application of Chaos Theory to Social Events*. Unpublished paper, Maxwell AFB, Ala.: School of Advanced Airpower Studies.
- Doughty, Robert Allan. *The Breaking Point: Sedan and the Fall of France, 1940*. Hamden, Connecticut: Archon Books, 1990.
- Drew, Col Dennis M., and Dr Donald M. Snow. *Making Strategy, An Introduction to National Security Processes and Problems*. Maxwell AFB Ala.: Air University Press, August 1988.
- Encarta 95*. Microsoft, 1995.
- Fabyanic, Lt Col Thomas A. *Strategic Air Attack in the USAF*. Research report no. 5899, Maxwell AFB Ala.: Air University Press, Apr 1976.
- Fadok, David S. *John Boyd and John Warden: Airpower's Quest for Strategic Paralysis*. School of Advanced Aerospace Studies, Maxwell AFB Ala.: Air University Press, February 1995.
- Gilster, Herman L. *The Air War in Southeast Asia: Case Studies of Selected Campaigns*. Maxwell AFB, Ala.: Air University Press, October 1993.
- Joint Publication 3-0, *Doctrine for Joint Operations*. 1 February 1995.
- Keaney, Thomas A., and Eliot A. Cohen. *Gulf War Air Power Survey Summary Report*. Washington, D.C.: 1993.
- Mowbray, Dr James A. "Air Force Doctrine Problems: 1926 - Present." *Airpower Journal* 9, no. 4 (Winter 1995).
- Myers, Isabel Briggs. *Introduction to Type*. Palo Alto, Calif.: Consulting Psychologists Press, Inc., 1993.
- Papp, Daniel S. *Contemporary International Relations*. New York, New York: Macmillan College Publishing Company, 1994.
- Pasmore, William A. *Creating Strategic Change*. New York: John Wiley & Sons, 1994.
- Penrose, Rodger. *The Emperor's New Mind*. New York, New York: Oxford University Press, 1989.
- Penrose, Rodger. *Shadows of the Mind*. New York, New York: Oxford University Press, 1994.
- Richards, Chet. *Modeling and Analysis or Strategy and Decision?* Marietta, Georgia: Lockheed Corporation and The Georgia Institute of Technology, 1991.
- Roberts, Wess, PhD, *Victory Secrets of Attila The Hun*. New York, New York: Dell Publishing, 1993.
- Sun Tzu, *The Art of War*, trans. by Samuel B. Griffith. London: Oxford University Press, 1963.
- Szafanski, Col Richard. *Neocortical Warfare? The Acme of Skill*. *Military Review*, no. 11 (November 1994).

Toffler, Alvin and Heidi. *War and AntiWar: Making Sense of Today's Global Chaos*. New York: Time Warner, 1993.

The United States Strategic Bombing Surveys: European War, Pacific War. Maxwell AFB, Ala.: Air University Press, October 1987.

Warden, Col John A. III. "Air Theory for the Twenty-first Century," in Barry R. Schneider and Lawrence E. Grinter, eds., *Battlefield of the Future: 21st Century Warfare Issues*. Maxwell AFB, Ala.: Air University Press, September 1995.

Woodward, Gary C. *Persuasion & Influence in American Life*. Prospect Heights, Ill: Waveland Press Inc., 1992.

Interdiction: Shaping Things to Come



A Research Paper
Presented To

Air Force *2025*

by

Col Charles B. Oltman
Maj William T. Davidson, Jr.
Maj Steven S. Kempf
Maj Thomas K. Moore
Maj Theodore P. Ogren

August 1996

Disclaimer

2025 is a study designed to comply with a directive from the chief of staff of the Air Force to examine the concepts, capabilities, and technologies the United States will require to remain the dominant air and space force in the future. Presented on 17 June 1996, this report was produced in the Department of Defense school environment of academic freedom and in the interest of advancing concepts related to national defense. The views expressed in this report are those of the authors and do not reflect the official policy or position of the United States Air Force, Department of Defense, or the United States government.

This report contains fictional representations of future situations/scenarios. Any similarities to real people or events, other than those specifically cited, are unintentional and are for purposes of illustration only.

This publication has been reviewed by security and policy review authorities, is unclassified, and is cleared for public release.

Contents

<i>Chapter</i>	<i>Page</i>
Disclaimer	ii
Illustrations.....	iv
Tables.....	iv
Executive Summary	v
1 Introduction.....	1
2 Required Capability.....	3
Mission Task Requirements.....	5
Accuracy.....	6
Lethality.....	7
Target Detection and Identification.....	7
Cycle Time	8
3 System Description	9
Accuracy.....	9
Lethality.....	12
Target Detection and Identification.....	16
Cycle Time	21
Summary.....	24
4 Concept of Operations	27
5 Investigative Recommendations.....	33
Conclusion.....	34
Bibliography.....	36

Illustrations

<i>Figure</i>	<i>Page</i>
1-1. View of the Past.....	2
3-1. Present Day Dye Lasers.....	10
3-2. Laser Modulating Weapon.....	11
3-3. Multibeam Attack System	14
3-4. Multispectral Imaging	18
3-5. Miniature Unattended Ground Sensors (MUGS).....	20
3-6. Holographic Interface.....	22

Tables

<i>Table</i>	<i>Page</i>
1 Force Qualities Summary	31

Executive Summary

Interdiction, based on the core competencies of precision employment and information dominance will still be used to shape the battlespace in 2025. The critical pieces of these core competencies—accuracy, lethality, target identification, and cycle time—will necessarily undergo great change in the next 30 years. The result of these changes will be interdiction with a different face but the same heart. Interdiction in 2025 will require affordable enhancements to current capabilities in the areas of accuracy, lethality, target detection/identification, and timeliness, allowing the war fighter to shape the battlespace in revolutionary ways.

A number of technological “leaps” will drive these required changes. Penetrating sensors and designators, coupled with microtechnology, will permit weapons to have the processing power required to “touch” targets in exactly the right spot. Variable lethality will permit the option of killing, delaying, deterring, or breaking targets. Synergistically combining these capabilities with intelligent system logic processing, improved target detection, decreased sensor-to-weapon cycle time, and air power will provide the necessary pieces to dominate the battlespace.

Among the systems required to build the interdiction system of systems in 2025 are: beyond-electromagnetic sensors; acoustic, penetrating, and variable-yield weapons; sensory netting; energy and particle weapons; and a virtual observe, orient, decide, and act (OODA) loop. From these systems, a nexus of three enabling technologies emerges. If pursued, these technologies will provide the leveraged investment necessary to revolutionize interdiction. These technologies include: nanotechnology for inertial measuring units, sensors, transmitters, processors and locomotion; nonlinear modeling and intelligent systems to support the virtual OODA loop; and expanded use of the electromagnetic spectrum for weapon guidance and remote sensing.

Chapter 1

Introduction

Air operations conducted to destroy, neutralize, or delay the enemy's military potential before it can be brought to bear effectively against friendly forces at such a distance from friendly forces that detailed integration of each air mission with fire and movement of friendly forces is not required.

—Joint Publication 1-02

In a time of drastic change it is the learners who inherit the future. The learned usually find themselves equipped to live in a world that no longer exists.

—Eric Hoffer

And all your future lies beneath your hat.

—John Oldham

Interdiction has been around as long as airplanes. From the early attempts at “delaying” the enemy in World War I (WW I) by releasing bombs from open cockpits to pre-Normandy battlefield preparation to dropping laser guided 2000-pound bombs on unsuspecting Iraqi tanks at night, the desired result has always been the same—to “destroy, neutralize, or delay the enemy’s military potential.” These interdiction tasks have historically been accomplished by killing the enemy and/or blowing up their equipment before they get to the fight—in essence, shaping the battlefield. This has not changed.

To be effective, the air warriors in WW I, World War II (WWII), and the Gulf War had to perform very similar tasks. The airmen had to find the target, deliver the weapons accurately, and ensure adequate lethality to accomplish the desired level of destruction. And they had to do these three things in a timely manner. This also has not changed.

The period from WW I to the end of WW II covered a little less than thirty years. From the end of WW II to the Gulf War was another 45 years. During both of these periods, the ability to accurately deliver lethal munitions on target in a timely manner grew tremendously (fig. 1-1). What will the next 30 years bring?



Photo Courtesy of Air Education and Training Command Photo Archive

Figure 1-1. View of the Past

Based on our core competencies of precision employment and information dominance, and pushed by the explosive growth and potential of technology, the face of interdiction will change, but not its heart. Interdiction in 2025 will require affordable enhancements to current capabilities in the areas of accuracy, lethality, target detection/ identification, and timeliness, allowing the war fighter to shape the battlespace in revolutionary ways. In describing these changes, this paper will define the required capabilities, describe the system components, detail a conceptual system that incorporates these components, and propose high-yield areas to investigate.

Although many discoveries could apply to battlespace shaping in other mediums, the focus of this paper will be nonnuclear land interdiction. Additionally, as we examine interdiction, a logical line of questioning is, “Why does this conceptual system only do interdiction? Why not strategic attack? What about close air support? What is unique to the interdiction mission that limits this system’s application?” The answer to the final question is—absolutely nothing! As our battlespace awareness increases, the artificial lines that divide the battlespace will continue to fade. This interdiction system can be effectively employed throughout the entire spectrum of attack operations, from strategic attack to close air support.

Chapter 2

Required Capability

This chapter examines the capabilities airpower must provide for the interdiction mission of 2025. In broad terms, the required capabilities fall into two of airpower's core competencies: precision and information dominance. Precision, the ability to achieve specific desired effects, rests on the two pillars of accuracy and lethality. The second core competency—information dominance—stems from correct target detection and identification coupled with compressed sensor-to-shooter cycle time.

By 2025, hostile forces will have learned from our current capabilities and, as a result, they will adapt their systems and tactics to survive. The expanded 2025 interdiction arena, which includes conventional war, military operations other than war (MOOTW), weapons of mass destruction (WMD), counter proliferation, theater missile defense (TMD), and counterdrug operations, will be extremely challenging. For example, the target could be a small group of nonuniformed, lightly armed people walking through a jungle or through a city. Or the target could be fast, stealthy, armored vehicles, massed or dispersed. The 2025 interdiction system will engage such targets and meet those challenges.

The interdiction system in 2025 is characterized by force qualities based on the following basic tasks: detect, identify, decide, engage, and survive. The interdiction system of 2025 must excel at performing these tasks. A general sampling of the force qualities for these tasks includes but is not limited to coverage, timeliness, accuracy, availability, survivability, completeness, speed, resolution, stealth, range, optimum lethality, decision quality, and reliability.

In layman's terms, the interdiction system must do a variety of things well. First, it must achieve a complete and correct picture of the battlespace. Next, it must perform the proper action to achieve the desired results. Both of these things must be done in an adverse and countermeasured environment. The

correct picture will be an accurate understanding of the location and movement of people and equipment in the designated battlespace. Additionally, coverage of a significant geographic area could be needed for major contingencies. Coverage will vary by scenario, but tens of thousands of square kilometers could be needed. The density of coverage is also critical. Sensor sample density need not be spaced to the centimeter. However, distances as close as hundreds of meters between samples might permit important features of the battlespace to be missed. Similarly, because different sensors detect different things, multispectral and/or multiple sensor types are needed. Finally, it is critical that the enemy system be modeled with sufficient fidelity to enable accurate prediction of hostile actions and reactions.

The enemy is a living, breathing organism that reacts to our actions. Col John Boyd, fighter pilot and renowned thinker, envisioned a way to conduct war based on OODA quicker than that enemy.¹ A key to employing this OODA loop effectively is to better anticipate the effect of an “act” on the enemy—and precisely placed ordnance enhances that ability to anticipate. Decreased cycle time, coupled with precision, permits the warrior to “get inside” the adversary’s OODA loop and dictate the course of the battle. Col John Warden, another airpower strategist, echoed this sentiment when he stated, “They [precision weapons] change the nature of war from one of probability to one of certainty.”² To Colonels Boyd and Warden, the term “precision” meant more than just being accurate. Precision in this context meant being able to use a weapon in such a manner as to cause a predicted, desired effect for the purpose of advantageously shaping the battlefield. Clearly, interdiction in the future will require even more accurate and lethal munitions delivered in a timely manner.

The defense budget today is not growing. There is no reason to believe this will change by 2025. With an aging population and possible bankruptcy of Social Security, there will be great pressure to spend dollars on social services rather than military equipment. Therefore, any money spent on airpower will have to be evaluated on a strict cost/benefit basis. While this is not a required capability *per se*, affordability in 2025 will be a driving factor.³

Mission Task Requirements

Precision and information dominance—accuracy, lethality, detection, and cycle time—will allow airpower to shape the battlespace. Rapid advances in technology push us to improve our systems. While not disregarding such advances, we must seek innovative capabilities and operating concepts which will pull technology forward. We must identify key requirements which, if met, will provide us the tools to achieve national security objectives in 2025. What must airpower in 2025 do to delay, disrupt, destroy, and divert hostile personnel, materiel (vehicles, weapons, supplies), and communications? The required capabilities in precision and information dominance must accomplish the following tasks:

Delay Personnel and Materiel: To stop people from moving, our system must be able to incapacitate personnel, destroy/incapacitate their vehicles, obstruct/make unusable the routes of travel, or convince them they don't want to make the trip.

Disrupt Personnel and Materiel: Sow confusion (C⁴I interference, psyops), force the enemy to take actions of higher priority than moving.

Destroy Personnel and Materiel: Lethal attack to attrit unit to point of inability to function productively, destroy organizational integrity, and sufficiently damage critical materiel or render it useless.

Divert Personnel and Materiel: Induce them to move in a direction beneficial to us or give them a problem to solve which takes them from their intended course of action. Create a need for the materiel somewhere else, or induce the logistic system to send the materiel to the wrong place.

The system or systems required to carry out these interdiction tasks in 2025 will be comprised of personnel, organizations, delivery platforms, weapons, sensors, command and control systems, communications infrastructure, and support. In time of war or conflict, these resources must form a system able to destroy, disrupt, delay, or divert modes of transportation such as vehicles, roads, railroads, bridges, communication links, and even people. The system must operate in all environments: urban, jungle, desert, day, night, and in adverse weather. It also must be supported with timely intelligence and prioritization. The system will have to survive against a constantly evolving threat.

To perform these tasks adequately, the future interdictor will demand a broad range of options. The “emerging means of denial”⁴ range from sticky foam and sonic guns to lasers and high-powered microwaves,

but those are evolutionary advancements. This paper focuses on the revolutionary requirements—improvements in accuracy, lethality, target detection, and cycle time—which will lead us to the capabilities for interdiction in 2025.

Accuracy

Tomorrow's weapons, such as the joint direct attack munitions (JDAM) and the joint standoff weapon (JSOW), will autonomously guide to within 10 meters, whether day or night, and in adverse weather. The weapons of 2025 will need to be significantly more accurate.

How much more accurate? "A reporter for the *New Republic* was in Baghdad the night of the first [Gulf War] air strike and the following morning watched smoke pour out of the Iraqi defense ministry. He was amazed that the hospital next to it was untouched as were the homes surrounding the ministry."⁵ With the ability to surgically remove a building from a city, what benefit is even greater accuracy? In Vietnam, news broadcasts brought the war to every American household by showing the death, destruction, and human suffering of civilians and soldiers alike. In the Gulf War, news broadcasts were live as the fighting occurred. Mass media continues to bring wars closer to the public. Ravages of war have always worked against public opinion. By increasing accuracy, airpower will continue to decrease collateral damage, helping prevent the loss of public support.

Today, we can skillfully remove a building within a city. By 2025, we may need the ability to strike specific offices, computer rooms, or command posts deep in the bowels of buildings without destroying the entire building. Enemy forces will no longer be able to hide among the civilian populace, endangering innocent lives. During the Gulf War, airpower inadvertently destroyed a fallout shelter for civilians which was collocated with a command post. The precision munitions/sensor combination of 2025 will need the ability to see inside the structure, penetrate various floors and walls, and detonate in the desired location. The result? One destroyed command post with few or no civilian casualties in the fallout shelter. Similarly, bridges could be dropped with a single bomb if it could exactly hit the main spar. The bomb yield could be smaller and collateral damage limited. This level of precision requires accuracy measured in centimeters rather than meters.

Lethality

Improved accuracy will help us obtain greater lethality. But what is lethality? Lt Col Edward Schantz defined “the essence of combat lethality” as “[t]he ability to rapidly deploy an overwhelming force, target precisely, inflict maximum destruction with the minimum of assets, attack a wide range of targets nearly simultaneously to paralyze the enemy, and to suffer and inflict the minimum number of casualties.”⁶ Another source took a slightly different view, describing lethality in two degrees, hard kill and mission kill.⁷ A hard kill completely destroys the intended target along with any nearby people. In contrast, a mission kill disables the equipment permanently or destroys supplies while sparing human life in the vicinity. Additionally, future interdiction in some instances must have the ability to prevent enemy mission accomplishment while preserving life and infrastructure.

Fulfilling this requirement for variable lethality will permit airpower to effectively interdict in nontraditional arenas such as MOOTW, WMD counterproliferation, and TMD. The targets in these areas demand a wide range of lethality. Furthermore, in both these and conventional missions, we may need to preserve infrastructure (keep bridges standing, railroads functioning, etc.) yet still delay, disrupt, divert, or destroy. Limiting collateral damage is a driving concern in executing military operations today, and this trend will only increase.

Target Detection and Identification

Rapid target detection, identification, and endgame decision making to optimize weapons effects will be equally important. Knowledge of seemingly insignificant characteristics of the battlespace will be necessary. How else will the war fighter be able to predict, with an acceptable degree of certainty, the effect of his actions on the battle? This requirement demands sensors capable of operating across and outside the electromagnetic spectrum. Processing capability at the scene will be necessary to screen out unwanted data and identify items of interest as well as discern friend from foe and neutral bystanders.

Cycle Time

Systems which gather prescreened data should be capable of rapid information collection, knowledge enhancement, picture-building for the operator, and efficient dissemination of targeting information. With cycle times reduced to minutes or seconds, the only way to improve exploitation of the adversary's OODA loop is to accurately predict his movement in relationship to the battlespace. But the battlespace is, by definition, chaotic, requiring nonlinear modeling. The side that is able to employ vast computational power, with algorithms capable of simulating the chaotic nature of events as they unfold, will achieve information dominance.

Emphasis on accuracy, lethality, target detection, and cycle time as viewed by the Joint Chiefs of Staff⁸ and senior Air Force leadership is at an all-time high.⁹ Current trends in these areas show great promise. The required capabilities for interdiction in the 2025 battlespace demand revolutionary technologies.

Notes

¹ Maj David S. Fadok, John Boyd and John Warden, *Air Power's Quest for Strategic Paralysis*, Thesis for School of Advance Airpower Studies, (Maxwell AFB, Ala: Air University Press, February 1995), 13-21.

² John A. Warden III, "Air Theory for the Twenty-first Century," in Dr Karl P. Magyar et al., *Challenge and Response, Anticipating US Military Security Concerns* (Maxwell AFB, Ala: Air University Press, August 1994), 327.

³ USAF Scientific Advisory Board, *New World Vistas: Air and Space Power for the 21st Century*, summary volume (Washington, D.C.: USAF Scientific Advisory Board, 15 December 1995), 5.

⁴ Frederick R. Strain, "The New Joint Warfare," *Joint Forces Quarterly*, Autumn 1993, 21.

⁵ Lt Col Thomas P. Mahoney, et al., "Vulnerability Analysis of the United States," Air University Library Doc M-U 43122 M2161v (Maxwell AFB, Ala.: Air Command and Staff College, 1995), 21.

⁶ Lt Col Edward T. Schantz, "Combat Lethality: A Formula," Air University Library Doc M-U 43117 S229c (Maxwell AFB, Ala.: Air War College, 1994), 19.

⁷ Report of US Army Strategic Defense Command, "Theater Missile Defense Lethality Sensitivity Assessments" (Huntsville, Ala., July 1993), 1-5.

⁸ Adm William A. Owens, "Emerging System of Systems," *Military Review*, May-June 1995, 15-19.

⁹ Department of the Air Force, *USAF Executive Guidance*, January 1996.

Chapter 3

System Description

A description of required systems will help the reader envision the technologies to be developed. This section will focus on systems for accuracy, lethality, target detection/identification, and cycle time.

Accuracy

Airpower stewards of 2025 should focus on three technologies--they are laser modulation, molecular recognition, and microsensors--to improve weapon accuracy.

Laser modulation will offer two advantages. The first advantage is the ability to penetrate a structure in a nondestructive inspection and the second is the ability to designate an exact point inside the structure, thereby guiding a penetrating munition to a precise detonation point within that structure. Laser devices generate a coherent beam by using a light source to excite atoms of a crystal, liquid, or gas medium. As the light is agitated in the crystal, liquid, or gas medium, it is reflected by mirrors. The reflected light agitates more atoms, generating more light of the same wavelength. Eventually, the light will build to such an intensity that it will overcome the reflectivity of one mirror and spill out of the laser device in a beam of coherent light. The crystal, liquid, or gas used for the lasing medium will determine the frequency and wavelength of the laser beam. Currently, there is a laser device that can modulate its frequency. It is called a "dye laser." The "tuning range can . . . be extended into the ultraviolet at the shorter end and into the infrared at the longer-wavelength end"¹ (fig. 3-1).

The energy generated in the light frequency range between microwave and ultraviolet offers only a slight amount of penetration capability. More simply, energy in the light frequency will reflect off the outside or external part of the structure. Energy in the microwave region can penetrate some materials, but will reflect off others. As the frequency or wavelength of a lasing beam changes throughout the spectrum, its ability to penetrate moisture, smoke, haze, or even solid objects, improves. This is similar to using an X-ray machine

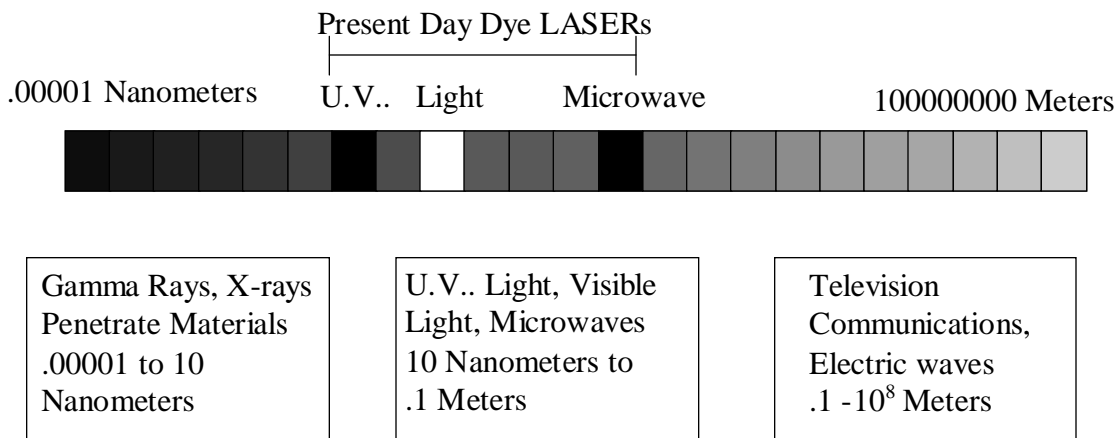

Figure 3-1. Present Day Dye Lasers

to see inside a person's body. "The power of X-rays for penetrating matter increases as the wavelength decreases."² By modulating the frequency throughout the entire electromagnetic spectrum, the device could control the frequency to penetrate or to reflect off of the various materials comprising the structure. From a database of material properties, a computer would analyze the different wavelengths based on parameters such as intensity of reflected energy, lack of reflected energy, or a shift in phase of the wavelength. Using this analysis, the computer would build a three- dimensional image of the structure and display it to the weapon operator. For example, a laser modulating weapon could examine a structure like a bridge and show the weapon operator a three-dimensional image of the internal skeleton of the structure. This would allow the weapon operator to locate the main spar and guide a weapon to an exact point inside the structure, thereby dropping the bridge with an explosive power the size of a stick of dynamite (fig. 3-2).



Figure from Microsoft Clipart Gallery © 1995 with courtesy from Microsoft Corporation

Figure 3-2. Laser Modulating Weapon

Lazing a target may be impractical--a more autonomous system might be needed to attack a target. Some view autonomous weapons as the next challenge in improving weapons. One visionary research paper from the Army Command and General Staff College stated, "Brilliant munitions, currently in the notional [conceptual] state, will combine the autonomous operation of smart munitions with enhanced navigation and targeting classification and identification capabilities."³ Classification and identification will be discussed later; this section will focus on autonomy. The heart for these weapons is the inertial navigation unit (INU). Today, INU errors grow by rate of time squared.⁴ That is to say, inaccuracy increases at an exponential rate after initial alignment. To maintain an accurate INU, the system can be updated in-flight by different systems such as the global positioning system or terrain-imaging systems. Updating the INU provides another vulnerability to the system. Future autonomy will come in making the INU more accurate. Historically, the inertial measuring system in the INU was a spinning mass gyro which evolved to a laser gyro.

The INU of the year 2025 could be a nuclear gyro. Utilizing radioactive *molecules*, the INU will measure the smallest of changes. Orientation and acceleration will be accomplished by multiple buckeyballs

(Buckminster Fullereen molecules) containing radioactive, specially shaped nanoparticles.⁵ The INU will never drift to an inaccurate state, and updating will be unnecessary. This will decrease vulnerability and provide pinpoint accuracy.

Autonomy is a great asset for stationary targets, but defining the end-game coordinates of a moving target significantly increases the level of difficulty. One approach supposes a datalink from the target to the weapon. A self-contained datalink module will attach itself to a target and transmit information to the weapon. The envisioned device will be miniature. It will have the ability to sense the composition of the target and to fuse with the target, so it cannot be removed. After fusing, the sensors will begin transmitting data, such as direction, speed, composition of material, armament, personnel on board, vulnerabilities, and other useful information to a weapon sensor. The device will transmit the information to a central computer. The computer will analyze it and other information transmitted from other targets, display a three-dimensional picture, and prioritize targets for commanders to analyze. After the commander decides which targets to attack, the computer will determine the most vulnerable point and the size of yield, and will guide the weapon to the exact point of vulnerability within the target. Improvements in miniaturization of power sources, sensors, and computers will be required.

Lethality

The word “lethal” connotes destructive power “capable of causing death.”⁶ In the spirit of reducing collateral damage and attaining specifically desired affects, weapons in the year 2025 will vary through a spectrum of lethality--from total destruction to target destruction without death to merely delaying or disrupting target function.

America’s national science laboratories are among those who recognize this reality [varying lethality] and are currently theorizing, developing, and testing these next generations of weapons, thereby transcending the precision guided munitions (PGM) used in the gulf war. Nonlethal technologies are the only way to fully exploit telecommunications [as well as other targets], and depending on campaign objectives, they may be cheaper, more effective, and less destructive.

Regardless of the level of lethality, weapons in the year 2025 will require technological advances in target penetrability and variable yield.

Weapons will have differing penetrability characteristics in 2025. This section will explore acoustic devices that prepare targets for kinetic energy weapons to penetrate; energy or particle beam weapons that penetrate structures directly; and a revolutionary concept, weapons that bore into structures.

Most weapons today use kinetic energy to penetrate a target. It could be costly in redesign efforts and arsenal replacement to design harder, higher-velocity weapons. A more likely scenario for kinetic weapons in the next 30 years is to use the same weapons as today but prepare the target for penetration. In other words, soften the target prior to bombing it. Materials are collections of bonded particles. A device that could break down those bonds would enable kinetic energy weapons to penetrate more easily. One way to weaken these bonds is to generate a resonating frequency in the structure. A sound-producing device imbedded in or attached to a target could send sound waves throughout the structure. A computer in the device would analyze the structure and adjust intensity and frequency until the structure resonates. “The amplitude of forced oscillations becomes exceptionally large whenever the driving frequency is near a natural frequency (resonating frequency) of the vibrating body.”⁸ These oscillations would weaken the material in the structure, thus allowing kinetic energy weapons to penetrate more easily. Although power requirements may be substantial, several of these devices working together would be able to add to the output without causing an increase in power demands per device.

Energy or particle beam weapons penetrate by translating through materials as described above. If enough energy were added, the beam could be a destructive force itself, like a laser scalpel used in surgeries today. Limited power sources and collateral damage would restrict the use of this weapon. However, several distinct energy or particle beam weapons focusing on the same point could individually penetrate structures without harm and cause internal damage at the designated point (fig. 3-3).

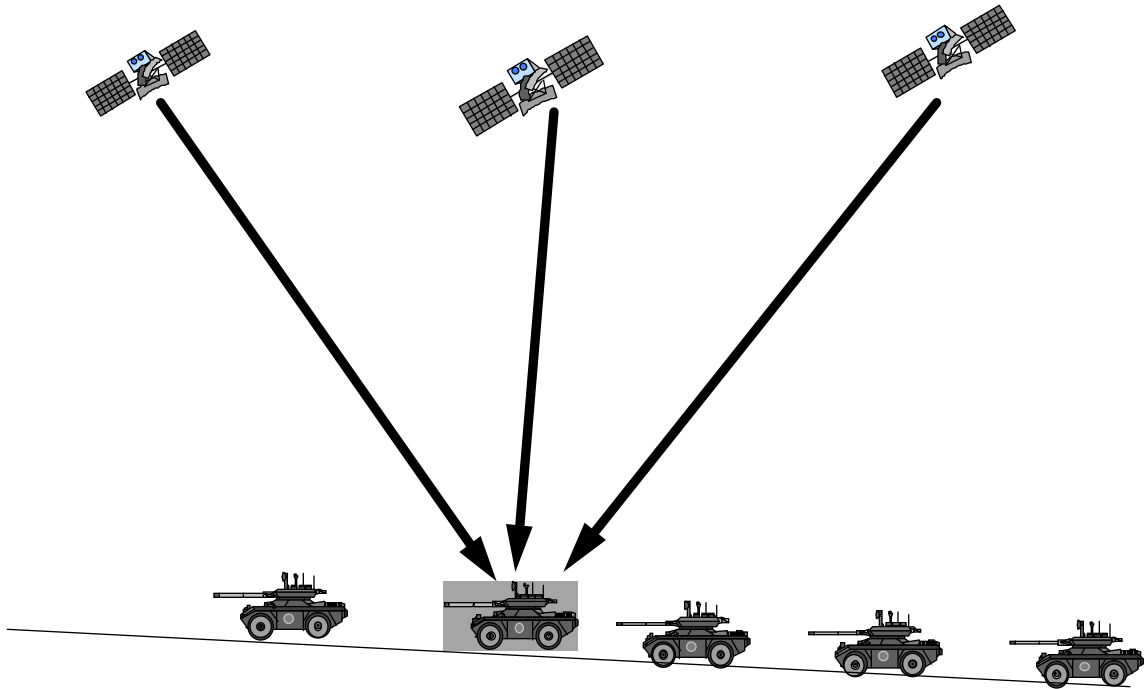

Figure from Microsoft Clipart Gallery © 1995 with courtesy from Microsoft Corporation

Figure 3-3. Multibeam Attack System

These weapons could be self-contained, in orbit around the earth, and networked to a control facility either in orbit or on the ground. There are three advantages: (1) They would not individually do anymore harm to the environment than microwave stations do today; (2) the system would be difficult to kill; and (3) the individual energy or particle beam systems could easily be disguised as communication satellites. This system would require a lens with zero defects to provide very accurate aiming and limit beam attenuation. Toward solving this, Dick Siegel, a scientist at the Rensselaer Polytechnic Institute, has developed a way to manipulate matter on an atomic level.⁹ He would essentially build the lensing medium atom by atom. Such homogeneous materials would provide precise focusing, enabling the energy or particle beams to converge precisely, providing maximum energy at a given point.

Penetration can also be achieved by boring to the desired point. Too often we envision weapons that do all their work in a split second of time, explode, and are gone. But a weapon that could bore through any

material would not have to work quickly; nor would it have to explode. This concept envisions a weapon that would work like a furniture worm. These worms bore through furniture, weakening it to the point of collapse. A bore weapon would ingest the material as it bored. The ingested material would be broken down by chemicals and enzymes. Useful molecules could be used for energy and the rest discarded. It would be very small, and many of them could infest a target. They could be linked to a central control system so as to work in unison and reach the most vulnerable spot quickly; or they could be disabled by the touch of a button if the enemy conceded to demands. Technological advances in computer miniaturization and chemical decomposition would be paramount.

If a weapon can accurately target inside a structure and penetrate to that point, then the final step is to apply the appropriate force to attain the desired effect. Energy or particle beam weapons of the year 2025 will adjust their yields by adjusting power output. Explosive weapons, however, cannot as yet adjust their explosive yield—it is a fixed parameter based on the explosive fuel in the bomb. The advantage of adjusting the yield lies in providing the most possible flexibility to the tip of the sword. An airplane, for example, with an adjustable yield weapon could be diverted from destroying a bridge, which might take a 100-pound yield, to destroying a communications room, which might take a 10-pound yield. This example shrinks the OODA loop, minimizes collateral damage, and provides the most flexibility to the war fighters. This section will examine two concepts for adjusting the yield on a weapon: metamorphic material and beam activation of materials.

Explosive weapons today use chemical compositions that, when ignited, burn at a rate and pressure inherent in the type of materials used.

All chemical reactions are accompanied either by an absorption or evolution of energy, which manifests itself as heat. It is possible to determine this amount of heat and thus the temperature and product composition from the very basic principles. Spectroscopic data and statistical calculations permit one to determine the internal energy of a substance. The internal energy of a given substance is found to be dependent upon its temperature, pressure and state and is independent of the means by which the state was attained.¹⁰

Therefore, by being able to change the material composition of the weapon, one could instantaneously adjust the yield of the weapon. The concept for a metamorphic material is to develop a substance that could change its molecular structure. An electrical charge of varying voltages could be the catalyst for changing the composition of the material. A charge would cause one chemical in the explosive solution of the bomb to

alter its molecular bonds, thus changing into a different solution and generating a different yield. A charge of a different voltage would make a different explosive solution with a different yield.

The concept of beam activation is similar to the metamorphosing materials described above; however, in this instance, the ordnance penetrates to the exact point required but does not detonate. A beam of energy is then applied to the ordnance from an airborne or spaceborne platform to trigger ignition. The type of energy beam will determine the yield of the explosion. For example, a microwave beam would activate chemicals in the solution different from those of an X-ray beam. Activation of different chemicals in the explosive solution would realize different yields.

Target Detection and Identification

There is radiance and glory in the darkness, could we but see; and to see we have only to look. . . .I beseech you to look.

—**Fra Giovanni**¹¹

The trouble with people is not that they don't know but that they know so much that ain't so.

—**Josh Billings**¹²

Historically, target detection and identification have been sequential and loosely associated processes. Targets were detected by various means (visual, radar, infrared), located, visually identified, and finally engaged. Initially, our ability to engage a target was limited because of our inability to detect and locate targets. Increasingly, however, our ability to detect, locate, and engage has greatly outpaced our ability to identify. All of the long-range detection and engagement systems in the world are worth nothing if we cannot correctly and confidently identify the targets. As we move into the future, the speed, and consequently the ranges, at which we will need to engage will increase significantly. Furthermore, the targets and target environments of 2025 will provide much greater challenges. We will be required to detect weapons of mass destruction at long ranges. We will need to operate in urban environments. In order to successfully meet these challenges, future systems will precisely detect, locate, identify, and “know” how best to attack the enemy. This “knowing” will use a greatly expanded range of brilliant sensors, mounted on a wide variety of platforms and networked together to fuse all of the information into widely-available target knowledge.

We detect most ground targets by using the electromagnetic spectrum, either optically (using the visual or infrared spectrum) or electronically (by either radar reflection or passive emission detection). The likely proliferation of stealthing and camouflaging techniques will reduce either the effectiveness of current detection systems or our confidence in those systems. Since stealthing is usually only effective in specifically targeted regions of the electromagnetic spectrum, we must expand the range of the spectrum our systems use for target detection.

Currently, lasers are used almost exclusively as designation systems to guide munitions. By 2025, advances in laser technology will permit reflected laser energy to be processed not only to determine target location and classification, but also to build a picture of the target for positive identification purposes. Furthermore, by using laser technology identified previously in the accuracy section, these sensors will be able to look beyond the surface and into the heart of a target. This will provide additional data for target identification and decoy rejection—stealthing and camouflage will be rendered useless.

Sensors have inherent limitations associated with their operating frequencies. For example, visual systems have good resolution but cannot see through weather or in the dark; infrared systems can see in the dark but are limited by weather; millimeter wave radar works in bad weather and darkness but has poor resolution.¹³ Multispectral imaging, capturing images of a given target, by using different regions of the electromagnetic spectrum and combining those images, can overcome the limitations associated with any particular region of the electromagnetic spectrum. Furthermore, not only are natural limitations overcome, but camouflage as well. A tank that is covered with branches may look like a bush, but it still has the thermal footprint of a tank. While it would be possible to disguise the tank further with thermal camouflage, it would still have the radar signature of a tank. For every camouflage short of actually building another tank, some region of the electromagnetic spectrum will reveal the camouflage.

By 2025, multilayered semiconductors and new polymeric materials will be designed and processed at the atomic level.¹⁴ “These new materials will make possible sensors with high sensitivity across the entire electromagnetic spectrum, data transmission links with greater than 200 gigabits per second, parallel processing of data at breathtaking speeds, three dimensional data storage with almost instantaneous access. . . .”¹⁵ Not only will these new materials “see” more; they will be able to compile multiple images much faster.

Multispectral imaging will give way to hyperspectral and ultraspectral imaging. There will be fewer and fewer places to effectively hide (fig. 3-4).

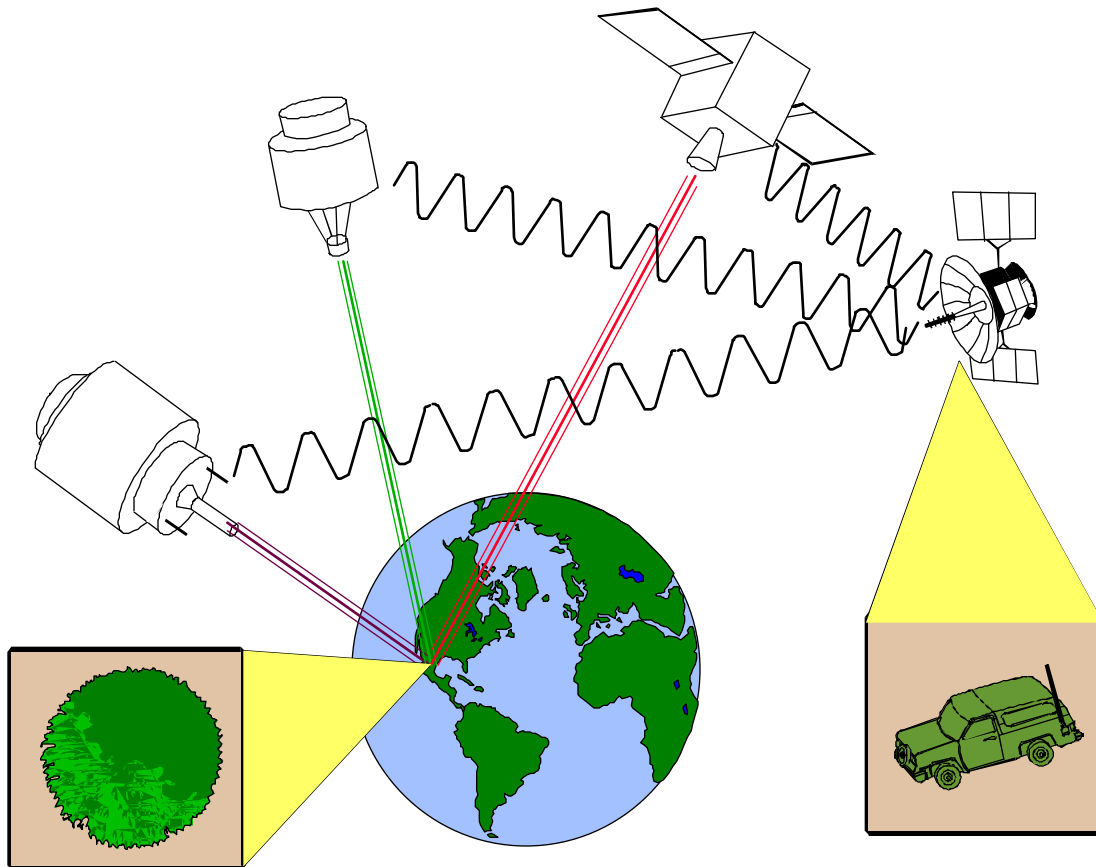

Figure from Corel DRAW!© 1992 with courtesy from Corel Corporation

Figure 3-4. Multispectral Imaging

Furthermore, sensors in 2025 will not only use more of the electromagnetic spectrum; they will move detection outside of the electromagnetic realm entirely. Scientists are developing intelligent materials that will be able to bond with objects and distinguish material characteristics of that object. Ultra thin layers, 200 to 300 microns thick, of piezoelectric polymers--like polyvinylidene fluoride (PVDF) in particular--are very sensitive to texture, temperature, and shape.¹⁶ Sensors using these materials will be able to “taste” and “feel” targets. Furthermore, chemists are working on developing

spectrometers that are the size of handheld calculators.¹⁷ These battlefield sensors will be able to sense the environment by looking for proximate target indications like exhaust fumes while miniature acoustic sensors will be “listening” for targets. These systems would be able to “smell” and “hear” targets!

Evolutionary improvements in computational power and artificial intelligence applied to all sensor systems will lead to revolutionary improvements in performance. These systems will become “brilliant” sensors. They will be able to perform in-depth analyses of all available data and compare the results against a vast library of cataloged threat systems and friendly systems. Having analyzed the data to such a level, the sensors will be able to provide information not only on target location and identification but also on target vulnerabilities. This will permit the tailoring of force to precisely affect the target.

To enhance their utility, these sensor systems will be located on an almost infinite variety of platforms in space, in the atmosphere, and on the surface. Any form of aviation platform will be able to support a sensor suit covering the entire range of detection capabilities. Surface sensors can be either fixed or deployable. Fixed sites will approximate something like the distant early warning (DEW) line of old, while increased processing capability will reduce the size and cost of such installations. Reductions in size and power requirements will permit sensor deployment on multiple small satellites, clustered together on large satellites, or on a space station.

The area that shows the most promise for revolutionary advances in sensor technology is nanotechnology. Miniature electronic and mechanical machines can be combined and manufactured through use of the lithography techniques currently found in computer chip production. These devices, called microelectromechanical systems (MEMS), are sized on the order of hundreds of microns.¹⁸ Advances in computers will also provide powerful processing capacity to a single integrated chip.¹⁹ Similarly, advances in memory devices will permit a trillion bits of information to be stored on a single chip.²⁰ Combining this powerful computing capability with the MEMS devices will allow us to deploy the “taste,” “smell,” “feel,” and “hear” sensors directly to the battlefield as a “swarm” of “miniature unattended ground sensors” (MUGS). The MUGS could be air-dropped in the neighborhood of a supply chokepoint and become a remote sentry reporting on enemy activity. As enemy equipment approaches, the MUGS detect the equipment, identify the equipment and its contents, and report the information.

Finally, massive intelligent networking of all sensor systems will permit the widest possible dissemination of target knowledge (fig. 3-5).

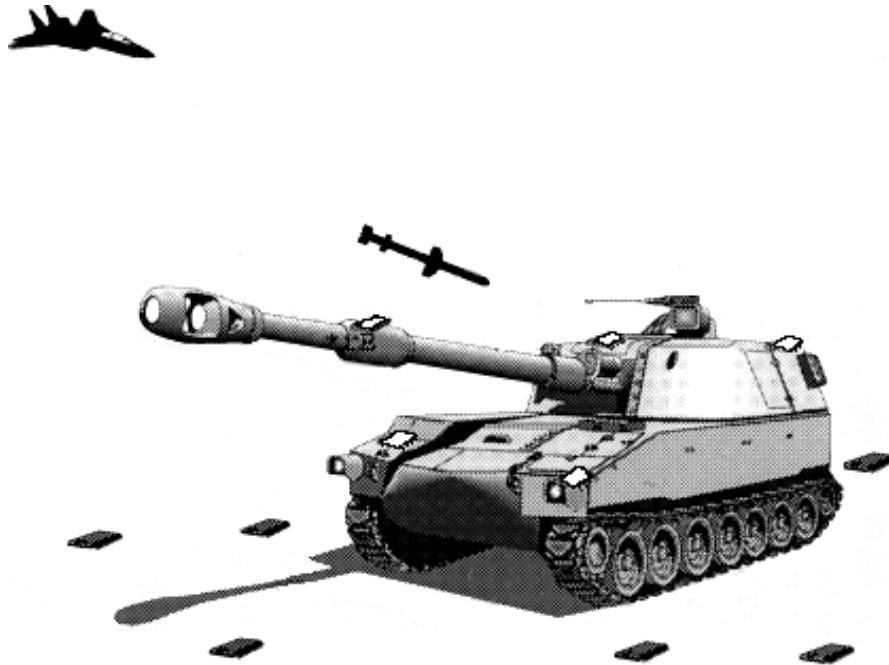

Figure from Corel DRAW!© 1992 with courtesy from Corel Corporation

Figure 3-5. Miniature Unattended Ground Sensors (MUGS)

As any individual sensor detects a target, it not only turns its full analysis capability on that target; it also identifies that target to other sensors for analysis of different modalities. All of the sensors will report their findings to intelligence networks for further analysis and possible targeting. As weapon systems are employed against these targets, the sensors will help guide munitions and optimize the effects of those munitions, as well as report munitions effects providing combat assessment. The MUGS, however, will require revolutionary advances in power and communications technologies to be able to communicate beyond their immediate environment. Short of solving these long-range communication problems, it would be possible to make the MUGS “smart” reflectors. Having locally determined the nature of a target, the MUGS would alter their state so that an energy beam reflected off them would contain meaningful target information. Passing aircraft, satellites, or other systems would be able to poll the MUGS by scanning them in passing.

Regardless of whether the MUGS are delivered by a transatmospheric vehicle, an unmanned aerial vehicle (UAV), or the Good Humor man, they will require insertion on the battlefield. While it is impossible

to know at this point precise dimensions or capabilities of the MUGS, some rough calculations will give us an idea of coverage we can expect. Given that the MEMS that are currently being developed have dimensions on the order of hundreds of microns, it is not unreasonable to assume that a MUGS of 2025 with a complete suite of communications and power capabilities, camouflage, and either motive or adhesive systems would be one centimeter square by one millimeter thick. A generic delivery canister of one cubic meter capacity would hold 10,000,000 sensors. If these sensors can reliably detect targets and communicate with each other at a distance of one meter, this one container could distribute enough sensors to cover an area approximately three kilometers on a side. If the range of the MUGS is increased to 10 meters, the area is 30 kilometers on a side or 900 square kilometers.

The MUGS would be ideal for detecting weapons of mass destruction and operating in urban environments. Properly configured, MUGS will be able to detect smaller evidence of WMD, more precisely locate the WMD, report WMD movement and determine the status of the environment after an attack to destroy the WMD. MUGS placed throughout an urban environment will permit more accurate tracking of targets in that environment. MUGS programmed to detect language, cultural, and equipment differences, placed in a building in which terrorists are holding hostages, would be able to determine the number, location, and status of both terrorists and hostages. Rescue attempts would be more effective, with greater likelihood of success and fewer friendly casualties. Substitute enemy soldiers in a city and similar results can be anticipated.

Cycle Time

Cycle time, within the context of targeting for interdiction, has historically followed a cycle of “detect, decide, and destroy.”²¹ Although the Air Force has chosen to embrace a newer version of the decision-making process in Boyd’s previously mentioned OODA loop, the process still requires events to occur before new data can be input as the observe portion of the cycle. Increasing the tempo of operations by reducing cycle times makes the employed force appear larger to the enemy. The goal of the commander is to repeat the cycle as rapidly as possible to minimize losses and maximize effect.

To maximize the effects of weapon systems in 2025, the ability to predict possible courses of action for commanders will be required. The ability to model the battlespace and explore options before actually executing them will allow analysis to determine best effects for least cost. Consider a military forecasting system capable of predicting enemy actions from twelve to twenty-four hours in advance and offering courses of action for evaluation. Using chess as an analogy, the commander will be able to predict the outcome of his third move, knowing the result of the second, while the first is taking place. Such a system, perhaps using a 3-D holographic battlefield display²² or a battlespace awareness holosphere,²³ would allow commanders to plan interdiction sorties against centers of gravity for the upcoming enemy operation (fig. 3-6). In the holographic interface system, the battlespace is projected in a three-dimensional format so all aspects of the battle can be interpreted by the commander.

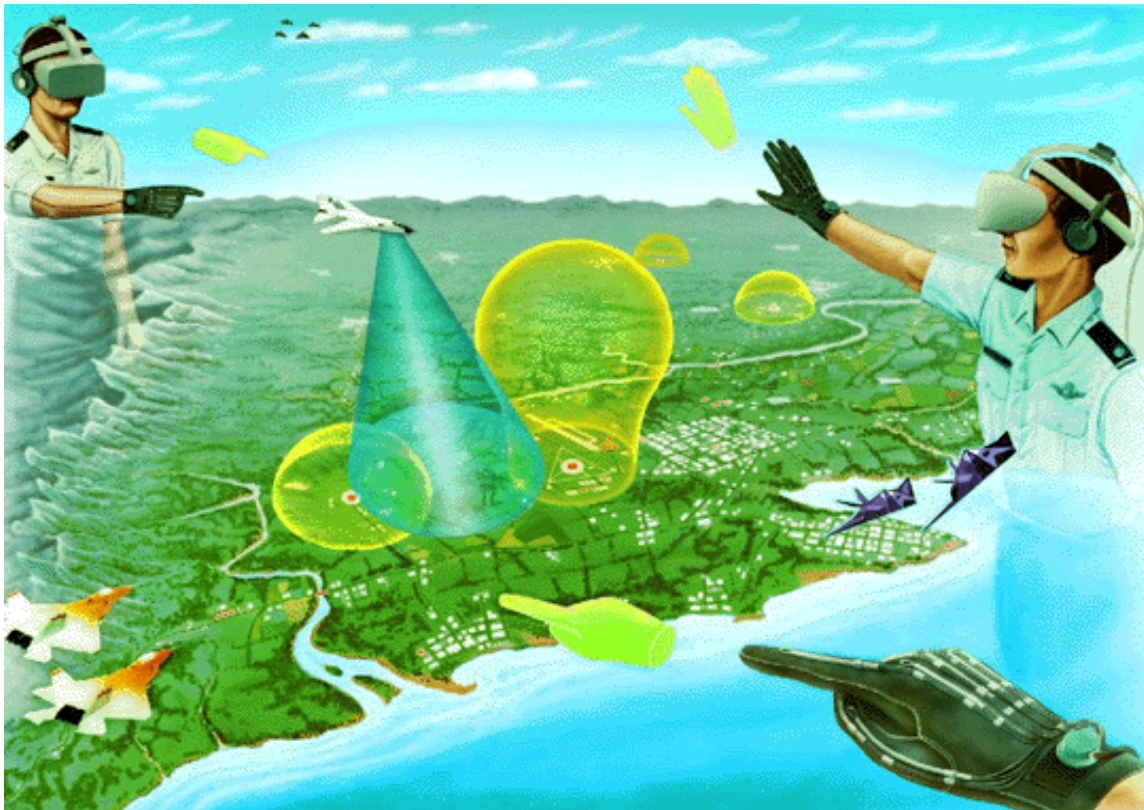

Picture Courtesy of Air Force Institute of Technology

Figure 3-6. Holographic Interface

To get additional information on a particular area or target, the commander zooms in or simply touches the object. Full details are then immediately available. If full details are not present, the system interprets

the “touch” as a request; additional sensor information is then sought. The holographic system would incorporate imagery, terrain information, air defense information, knowledge of the opponent’s tactics, treaty implications, and all sensor data from the target detection/identification network. The database for the system, pervasive and distributed, draws from many sources around the world. Some possible inputs to the database include Central Intelligence Agency data, Department of State analyses of governments and engineering data on the opponents system. The holographic system will have call-up panels for other C⁴I tasks. For example, to establish a link with a commander at another center, the operator will touch the appropriate unit’s symbol and a video conference link is established with the other commander. The system would project the battlespace at the level of detail requested by the commander, and providing a real-time view of enemy and friendly forces. The ability to simulate attacks on various enemy targets, inflict damage to friendly forces, and view the results are integral parts of a battlespace awareness system. By using the system to analyze the effects of attacks on both sides of the battle, future commanders will be employing a “virtual OODA (VOODA) loop.” The VOODA system and its three-dimensional modeling of the battlespace requires understanding. Concepts such as nonlinear modeling and intelligent systems must be developed.

Nonlinearity, for the purpose of this discussion, is defined as an aperiodic equilibrium state of a dynamic system. A system in nonlinear equilibrium seems to wander randomly, yet the behavior is deterministic. If you know the equations, you can predict in advance any point of the nonlinear path or trajectory.²⁴ The problem is in understanding how to model battlespace as the behavior becomes complex. Complex behavior implies complex causes. Events that are seemingly unpredictable, like a battle, are governed by many independent controls (such as individual commanders) or by random external influences (like weather).²⁵ Modeling a complex scenario requires a choice—either make the model more complex and more faithful to reality, or make it simpler and easier to manage. The simpler model is easier to produce and requires less understanding of all the complex factors involved, but will provide less useful results over time.

To tie this concept to battlespace planning, consider the current means of weather prediction. Complex algorithms and supercomputers produce a forecast with reasonable accuracy for a twelve to twenty-four-hour period; however, the farther into the future the model predicts, the less reliable the forecast. Currently, computing power struggles under the load of complex algorithms and the multiple iterations necessary for

long-term accuracy. In 2025, predicted computing capability will give increased accuracy by allowing more complex algorithms to forecast events.

The data and software necessary for a VOODA loop system will be staggering, as will the required computing capability. The software that drives the system requires an adaptive “intelligent system” approach. An intelligent system implies multivalued or “vague” logic, or, simply put, “everything is a matter of degree.”²⁶ An intelligent system learns rules from data or by watching the behavior of human experts through a network of sensors. The system with the greatest potential for military use is the fuzzy cognitive map (FCM) computer. An FCM draws a causal picture by tying facts, assumptions, and processes into values, policies, and objectives. It is designed to predict how complex events interact and play out.²⁷ An FCM has concept nodes and causal links. Concept nodes are vaguely defined sets like “tanks on a road” or “strength of a bridge.” Causal links are vague rules that connect the nodes to show the effects of one node on another. FCMs thrive on feedback to determine which nodes are changing and by how much. The sensors of the future battlespace will provide the necessary data to the FCM. Intelligent systems are currently used in adaptive process controllers, air-fuel mixture ratio controllers, and automatic transmissions.

These and other areas of military and commercial applications could gain order of magnitude improvements. By allowing the commander the option of stepping forward in time, FCM using developed intelligent systems and simulation techniques offer great promise for improving cycle times in 2025. The ability to select the third move, based on the results of the planned second move, while the first move is taking place, represents an astounding improvement in cycle time. According to Noboru Wakami, a Matsushita engineer, “[intelligent systems are] like seasoning. Sometimes the seasoning simply improves the taste [of food]. Sometimes it produces something dramatically different.”²⁸

Summary

The interdiction mission in 2025 will require significant technological “leaps” to achieve the required accuracy, lethality, target detection, and cycle time. Penetrating sensors and designators coupled with microtechnology will permit weapons to have the processing power required to “touch” targets in exactly the right spot. Variable lethality will permit the option of killing, delaying, deterring, or breaking targets. Add

intelligent system logic processing, improved target detection, and decreased sensor-to-shooter cycle time to these capabilities and the result is clear—airpower will dominate the battlespace.

Notes

¹ Hrand M. Munchenyan B. SC., E. E., M. SC., *Principles and Practices of Laser Technology* (Blue Ridge Summit, Penn.: Tab Books Inc., 1983), 96.

² Charles F. Meyers, *The Diffraction of Light, X-rays, and Material Particles* (Ann Arbor, Mich.: The University of Chicago Press, 1949), 284.

³ “Fundamentals of Smart Weapons,” Appendix 1 to Advance Sheet, Meeting 4, Report no. A304-4 (Fort Leavenworth, Kans.: US Army Command and General Staff College, September 1991), 82.

⁴ Gerald Frost, *Operational Issues for GPS-Aided Precision Guided Weapons*, (Santa Monica, Calif.: RAND Corporation, 1994), 4.

⁵ **2025** Concept, No. 20014, “Molecular Inertial Navigation Sensor,” **2025** Concepts Database (Maxwell AFB, Ala.: Air War College/**2025**, 1996).

⁶ *The American Heritage Dictionary*, (Boston.: Houghton Mifflin Co., 1982), 725.

⁷ Maj Gerald R. Hurst, *Taking Down Telecommunications*, (Maxwell AFB, Ala.: Air University Press, September 1994), 29.

⁸ Donald E. Tilley, *Contemporary College Physics* (Menlo Park, Calif.: The Benjamin/Cummings Publishing Co, Inc., 1979), 454.

⁹ Robert Pool, “Atom Smith,” *Discover*, December 1995, 56.

¹⁰ Irvin Glassman, *Combustion Second Edition* (Orlando, Fla.: Academic Press, Inc., 1987), 1.

¹¹ Suzy Platt, *Respectfully Quoted, A Dictionary of Quotations Requested from the Congressional Research Service* (Library of Congress, Washington D.C.: Government Printing Office, 1989) 274.

¹² *Ibid.*, 185.

¹³ USAF Scientific Advisory Board, *New World Vistas: Air and Space Power for the 21st Century* (unpublished draft, the sensors volume, 15 December 1995), 92.

¹⁴ *New World Vistas*, summary volume, 87.

¹⁵ *Ibid.*

¹⁶ Craig A. Rogers, “Intelligent Materials,” *Scientific American*, September 1995, 124-125.

¹⁷ Gabriel J. Kaigham, “Engineering Microscopic Machines,” *Scientific American*, September 1995, 121.

¹⁸ *Ibid.*, 118.

¹⁹ David A. Patterson, “Microprocessors in 2020,” *Scientific American*, September 1995, 49-50.

²⁰ Kaigham, 120.

²¹ Capt Richard E. Nock, “High Payoff Targets: When to engage,” *Military Intelligence* 19, no 2 (Apr-June 1993): 19-23.

²² **2025** Concept, No. 900385, “3-D Holographic Battlefield Display,” **2025** Concepts Database (Maxwell AFB, Ala.: Air War College/**2025**, 1996).

²³ **2025** Concept, No. 900417, “Battlespace Awareness Holosphere,” **2025** Concepts Database (Maxwell AFB, Ala.: Air War College/**2025**, 1996)..

²⁴ Bart Kosko, *Fuzzy Thinking, The New Science of Fuzzy Logic* (New York: Hyperion, 1993), 288.

²⁵ James Gleick, *Chaos, Making a New Science* (New York: Penguin Books, 1987), 303.

Notes

²⁶ Kosko, 292.

²⁷ Ibid., 222.

²⁸ Ibid., 183.

Chapter 4

Concept of Operations

We make war as personal as a punch in the nose. We can be selective, applying precisely the required amount of pressure at the specified point at a designated time—we've never been told to go down and kill or capture all left-handed redheads in a particular area, but if they tell us to, we can.

—Robert A. Heinlein

Some of these areas of enhancement do not represent, by themselves, revolutionary ways of doing business. Nonetheless, from today's baseline, each of the individual attributes—accuracy, lethality, target identification, and cycle time—will experience exponential growth. What is revolutionary, like blitzkrieg,¹ is the way these exponentially improving elements will be combined to accomplish interdiction—the interdiction system of systems. What follows is a description, based on the technologies outlined in the previous section, of a global attack system (GAS) in the year 2025. Our system is composed of four key subsystems: (1) a battlespace targeting system, (2) a networked sensor array, (3) a variable lethality, very smart weapon, and (4) a command, control, and communications system to tie these subsystems together.

Overseeing the entire interdiction system is “the man in the loop”—the joint force commander (JFC) and staff. The battlespace system contains numerous information filters to provide the appropriate information to the appropriate level, but targeting authority belongs to the JFC. Since all the players have access to the same battlespace data, the JFC has complete flexibility to delegate this authority based on the forces available, the campaign plan, and the desired effect on the enemy.

The brain of the interdiction system of systems is a **targeting system**.² The interdiction targeting process begins with the JFC, based on fused battlespace information, designating an area of interest to the targeting module. This module, located in either space, an uninhabited reconnaissance air vehicle,³ or an

AWACS/JSTARS-like aircraft, collects data via multispectral imaging⁴ and processes the data intelligently to identify potential targets of interest. After concurrence from the joint force air component commander (JFACC) or his designated representative, the targeting module initiates the launch of unmanned aerospace vehicles UAVs that contain the miniature sensors.

These sensors are dispersed in the target area and begin to relay information to the targeting module. The JFACC, based on the sensor information received and the offensive game plan, designates the exact target and desired level of destruction. The targeting module then launches nearby fighters, bombers, or UAVs, gives them initial target information, and “hands them off” to the sensor array. The air vehicles proceed to the target area and drop their sensor-controlled weapons on the designated targets.

The eyes, ears, taste, smell, and touch of GAS comprise a miniature sensor array.⁵ This sensor array is composed of adaptive microscopic machines that, having been dispersed by UAVs, seek out and find “interesting items.” After attaching to items of interest, the sensors begin to talk to each other and form a network. As the network matures, it is able to determine what is a valid target and what is not, where the target’s most vulnerable points are, what weapons effects will produce the best results, and where living beings are located. The sensor array then relays this information to the targeting control system. This system now has enough information to match assets to targets, based on not only target type and destruction requirements but also on an assessment of collateral damage risk. Ultimately, the sensors pass some of this information directly to the weapon. Additionally, the sensor array is able to report level of destruction to the targeting control system, which can then update its target list and continue the process as required.

The business end of the GAS is the fist—the variable-lethality weapon.⁶ This weapon, delivered by either a manned or unmanned platform, is the ultimate in sensor-to-weapon-linked technology with the ability to vary the effects of the weapon based on sensor input. Using the networked sensor array, a direct data link is established between the sensor and the weapon. This link serves two purposes. First, it provides exact location information to allow precise weapon placement. Second, using the information collected on the type of material and structure, the sensor adjusts the yield of the weapon to produce the desired level of destruction. For example, hard targets might require a higher yield, underground targets might require delayed fusing to allow penetration, flimsy aboveground structures might require an airburst to maximize blast, and so forth.

In addition to adjusting the bang, based on target requirements, the weapon is also able to flex to a nonlethal mode of operation. When the sensor array “notices” items whose damage or destruction would hamper the commander’s strategic effort, the sensor-weapon link would reduce the yield and/or change the mode (e.g., blast to sticky ooze) based on preset or real-time operator inputs. One size truly fits all!

The final required element to allow GAS to function properly is a way to link the receptors, the brain, and the fist to one another, all under the control of the JFACC. We need a nervous system—a secure, high-speed, large bandwidth communication system—that will provide the required information flow. Although essential to our system of systems, this requirement is not unique to interdiction and is assumed to be in place.

The interdiction organism is now complete. It has a brain, an ability to sense its environment, a way to influence its environment, an ability to communicate amongst its various parts, and someone to tell it what to do. However, our interdictor can be rendered ineffective by attacking it at any of these points. The brain could be destroyed outright or infected with a crippling “disease.” The eyes and ears could be “repelled” with an antisensor spray or, worse yet, information within the sensor net or from the net to the weapon could be altered (location, yield, etc.). The fist could be deflected or destroyed prior to target impact. The nervous system could be completely severed (electromagnetic pulse info weapon) or selectively disabled (spot jamming, etc.). All of these potential countermeasures will have to be considered and countered as we develop our “interdiction system of systems.”

Having described the global attack system, a few caveats are in order. First, GAS is not delivery-platform dependent. As we progress toward 2025, new manned and unmanned platforms will be developed. GAS can be implemented on a variety of these platforms. Secondly, given the often uneven development of technology, advances in sensor technology may outpace that of variable-yield weapons. However, as pieces of GAS are completed, they can be implemented with a corresponding increase in capability. Finally, forward basing, if available in 2025, would improve the system response time. However, the impact of that decrease in response time is very situation- dependent.

Although GAS may do interdiction very well, a broader question must be answered. Does it answer the mail? Does this system satisfy the requirements identified for an effective interdiction system in the year 2025? The short answer is—YES! The critical force qualities required in 2025 are all satisfied by the

various subsystems in our interdiction system of systems. For a detailed snapshot of force qualities versus GAS elements, see table 1.

As you examine this interdiction organism, a logical question is, “Why does this beast only do interdiction? Why not strategic attack? What about close air support? What is unique to the interdiction mission that limits this system’s application?” The answer is—absolutely nothing! As our battlespace awareness increases, the artificial lines that divide the battlespace will continue to fade. This interdiction system can be effectively employed in the entire spectrum of attack operations, from strategic attack to close air support.

Table 1
Force Qualities Summary

	GLOBAL ATTACK SYSTEM							
	BRAIN		SENSORS		FIST			
	Holographic Interface	FCM Computer	Multispectral Laser	MUGS	Nuclear IMU	Acoustic Prep Devices	Multi-beam Attack System	Variable yield weapons
DETECT								
Sensor Coverage			X					
Sensor Revisit Time			X	X				
Location Accuracy			X	X				
Environmental Availability				X				
Sensor Survivability			X	X				
Unobtrusive				X				
Completeness			X	X				
IDENTIFY								
Speed			X	X				
Accuracy			X	X				
Resolution			X	X				
Traceability			X	X				
Battlespace View				X				
Correlation			X	X				
DECIDE								
Speed of Decision	X	X						
Decision Basis Accuracy		X						
Decision Quality	X	X						
ENGAGE								
Range			X				X	
Accuracy			X	X	X		X	
Timeliness	X		X	X			X	
Desired Lethality			X	X	X	X	X	X
Multi-role (Flexibility)			X	X			X	X
SURVIVE								
Vulnerability	X	X		X				
Countermeasures	X	X	X				X	
Stealth	X	X		X				

Notes

¹ Blitzkrieg was a revolution in military affairs that combined evolutionary technology in a revolutionary way to outpace the enemy in the battle.

² **2025** Concept, No. 900859, "Space-Based Target Designator System," **2025** Concepts Database (Maxwell AFB, Ala.: Air War College/**2025**, 1996).

³ USAF Scientific Advisory Board, *New World Vistas: Air and Space Power for the 21st Century*, summary volume (Washington, D.C.: USAF Scientific Advisory Board, 15 December 1995), 21.

⁴ *Ibid.*, 20.

⁵ **2025** Concept, No. 900860, "Neural Net Sensor Array," **2025** Concepts Database (Maxwell AFB, Ala.: Air War College/**2025**, 1996).

⁶ **2025** Concept, No. 900858, "Sensor-Controlled Weapons Effects," **2025** Concepts Database (Maxwell AFB, Ala.: Air War College/**2025**, 1996).

Chapter 5

Investigative Recommendations

This paper has identified a number of enabling technologies for the interdiction system of 2025. Some subsystems were highlighted: beyond-electromagnetic sensors; acoustic, penetrating, and variable yield weapons; sensory netting; energy and particle weapons; and a virtual OODA loop. From these, three technologies emerge. These are the critically enabling technologies which, if pursued, will provide the basis for an interdiction revolution. The first is nanotechnology for inertial measuring units, sensors, transmitters, processors, and locomotion. The second, nonlinear modeling and intelligent systems, will support the virtual OODA loop. The third is expanded use of the electromagnetic spectrum for weapon guidance and remote sensing.

Nanotechnology is critical because the sensing end of the system depends on it. To cover a meaningful geographic area, these sensor/processors must be produced in huge quantities at low cost. Industry, even now, produces vast quantities of such devices. One example is the microchip inertial measuring units produced for automotive airbag actuation. In the future, miniature mass spectrometers and “inexpensive chemical detectors” will be made.¹ Such machines could certainly be adapted to fill the sensing needs of our system. Built through use of microchip production techniques, these machines will easily possess the transmitters, processors, and receivers that the interdiction system requires.

As stated, this system will have the processing capability of modeling the battlespace with the fidelity necessary to predict the effect of the war fighter’s next move. Today, we can predict the weather for a 12 to 24-hour period. The nonlinear algorithms used for this, combined with vast processing power, will be

available in 2025. Today, we must begin to expend the effort to study and understand the battlespace in terms of chaos theory and fuzzy logic so its unique features can be modeled.

Exponential gains in computational and processing capability are necessary, but they will be a “given” in 2025. Individual computers in 2025 “will be as powerful as all those in silicon valley today.”² Commercial enterprise over the next 30 years will provide substantial support for the development of nanotechnology and nonlinear modeling.

The third technology deemed critical is the expanded use of the electromagnetic spectrum. At first blush, this seems to have little industrial utility. Guiding a weapon to a precise location within a structure is not a peacetime pursuit, but unobtrusively examining the interior of a structure is commonly needed—for example, aging bridges require testing to determine their health. Perhaps mining and oil drilling operations could benefit from a Cat (CT) Scan/Magnetic resonance image (MRI) of potential sites.

Conclusion

Nanotechnology for inertial measuring, sensors, transmitters, processors, locomotion, and nonlinear modeling, as well as intelligent systems for the virtual OODA loop and expanded use of the electromagnetic spectrum for weapon guidance and remote sensing, are the key interdiction technologies for airpower focus over the next 30 years. They are derived by envisioning required capabilities, describing systems that might be used in 2025, and then consolidating them into a concept of operations. These futuristic ideas were identified through the timeless core competencies of precision and information dominance. The great visionary, William Mitchell, once said, “In the development of airpower, one has to look ahead and not backward and figure out what is going to happen, not too much of what has happened.” This paper has looked ahead and offers direction to air and space professionals. All that is left is to act.

Notes

- ¹ Gabriel J. Kaigham, "Engineering Microscopic Machines." *Scientific American* (September 1995). 118-121.
- ² David A Patterson, "Microprocessors in 2020," *Scientific American* (September 1995). 48-51.

Bibliography

- 2025 Concepts Database, Maxwell AFB, Ala.: Air War College, 1996.
- The American Heritage Dictionary*, Boston: Houghton Mifflin Co., 1982.
- Department of the Air Force. *Executive Guidance*, January 1996.
- Fadok, Major David S. John Boyd and John Warden. *Air Power's Quest for Strategic Paralysis*, Thesis for School of Advanced Airpower Studies. Maxwell AFB, Ala.: Air University Press, February 1995.
- Frost, Gerald. *Operational Issues for GPS-Aided Precision Guided Weapons*. Santa Monica, Calif.: RAND Corporation, 1994.
- Fundamentals of Smart Weapons*. Appendix 1 to Advance Sheet, Meeting 4. Report no. A304-4. Fort Leavenworth, Kans.: US Army Command and General Staff College, 1991.
- Glassman, Irvin. *Combustion Second Edition*. Orlando, Fla.: Academic Press Inc., 1987.
- Gleick, James. *Chaos, Making a New Science*. New York: Penguin Books, 1987.
- Hoffer, Eric. "Reflections on the Human Condition," in *The Columbia Dictionary of Quotations*, Columbia University Press, 1993.
- Heinlein, Robert A. *Starship Troopers*. New York: Ace Books, 1987.
- Hurst, Maj Gerald R., *Taking Down Telecommunications*. Maxwell AFB, Ala.: Air University Press, September 1994.
- Joint Publication 1-02, *Department of Defense Dictionary of Military and Associated Terms*, 1 December 1989.
- Kaigham, Gabriel J. "Engineering Microscopic Machines." *Scientific American* (September 1995): 118-121.
- Kosko, Bart. *Fuzzy Thinking, The New Science of Fuzzy Logic*. New York: Hyperion, 1993.
- Mahoney, Lt Colonel Thomas P., et al. "Vulnerability Analysis of the United States." Air University Library Doc M-U 43122 M2161v. Maxwell AFB, Ala.: Air Command and Staff College, 1995.
- Meyers, Charles F. *The Diffraction of Light, X-rays, and Material Particles*. Ann Arbor, Mich.: The University of Chicago Press, 1949.
- Munchenyan, Hrand, M. *Principles and Practices of Laser Technology*. Blue Ridge Summit, Penn.: Tab Books Inc., 1983.
- Nock, Captain Richard E. "High Payoff Targets: When to Engage." *Military Intelligence* 19, no 2 (Apr-June 1993): 19-23.
- Oldham, John. "Lines to a Friend About to Leave the University," in *The Columbia Dictionary of Quotations*, Columbia University Press, 1993.
- Owens, Admiral William A. "Emerging System of Systems." *Military Review* (May-June 95): 15-19.
- Patterson, David A. "Microprocessors in 2020." *Scientific American* (September 1995): 48-51.
- Platt, Suzy. *Respectfully Quoted, A Dictionary of Quotations Requested from the Congressional Research Service*. Library of Congress, Washington D.C.: Government Printing Office, 1989.
- Pool, Robert. "Atom Smith." *Discover* (December 1995): 56.

- Schantz, Lt Colonel Edward T. "Combat Lethality: A Formula." Air University Library Doc M-U 43117 S229c. Maxwell AFB, Ala.: Air War College, 1994.
- Strain, Frederick R. "The New Joint Warfare." *Joint Forces Quarterly*, Autumn 1993. 21.
- The American Heritage Dictionary*. Boston: Houghton Mifflin Co., 1982.
- Tilley, Donald E. *Contemporary College Physics*. Menlo Park, Calif.: The Benjamin/Cummings Publishing Co., Inc., 1979.
- USAF Scientific Advisory Board. *New World Vistas: Air and Space Power for the 21st Century, Summary Volume*. Washington, D.C.: USAF Scientific Advisory Board, 15 December 1995.
- USAF Scientific Advisory Board. *New World Vistas: Air and Space Power for the 21st Century*. Unpublished draft, the Sensors Volume. 15 December 1995.
- US Army Strategic Defense Command. "Theater Missile Defense Lethality Sensitivity Assessment." Huntsville, Ala. July 1993.
- Warden, John A. III. "Air Theory for the Twenty-first Century," in Dr Karl P. Magyar et al., *Challenge and Response, Anticipating US Military Security Concerns*. Maxwell AFB, Ala.: Air University Press, 1994.

Hit'em Where It Hurts: Strategic Attack in 2025



A Research Paper
Presented To

Air Force *2025*

by

Lt Col Jeffrey E. Thieret
Maj Steven J. DePalmer
Maj Frederick I. Guendel, Jr.
Maj Michael A. Silver

August 1996

Disclaimer

2025 is a study designed to comply with a directive from the chief of staff of the Air Force to examine the concepts, capabilities, and technologies the United States will require to remain the dominant air and space force in the future. Presented on 17 June 1996, this report was produced in the Department of Defense school environment of academic freedom and in the interest of advancing concepts related to national defense. The views expressed in this report are those of the authors and do not reflect the official policy or position of the United States Air Force, Department of Defense, or the United States government.

This report contains fictional representations of future situations/scenarios. Any similarities to real people or events, other than those specifically cited, are unintentional and are for purposes of illustration only.

This publication has been reviewed by security and policy review authorities, is unclassified, and is cleared for public release.

Contents

<i>Chapter</i>		<i>Page</i>
	Disclaimer	ii
	Illustrations.....	iv
	Tables.....	iv
	Executive Summary	v
1	Introduction.....	1
2	Required Capabilities.....	5
	System Analysis.....	5
	Target Acquisition.....	7
	Target Engagement.....	9
	Feedback.....	11
3	Strategic Attack Systems Description	12
	System Analysis System.....	13
	Artificial Intelligence.....	15
	Computer Hardware Requirements	18
	Target Acquisition System.....	18
	Target Acquisition Platforms	19
	Critical Target Acquisition Sensor Technologies	20
	Target Engagement System.....	23
	Weapons	24
	Strategic Platforms.....	26
	Feedback Systems.....	28
4	Concept of Operations	32
5	Investigative Recommendations.....	36
6	Conclusions.....	38
	Bibliography.....	39

Illustrations

<i>Figure</i>	<i>Page</i>
1-1. Strategic Attack Process	3
2-1. Sensor Platforms.....	8
2-2. LOV Engagement Spectrum	9
3-1. Strategic Attack Process	12
3-2. The System Analysis System	13
3-3. Delphi Database	14
3-4. Artificial Intelligence Architecture.....	16
3-5. Transatmospheric Vehicle	27
4-1. Notional Target Acquisition System.....	33
4-2. Notional Target Engagement System.....	34
4-3. Strategic Attack in 2025	35

Tables

<i>Table</i>	<i>Page</i>
1 Strategic Attack Requirements for 2025	5

Executive Summary

In the year 2025, advances in technology should allow air and space assets to affect an adversary anytime, anywhere. The ultimate goal of strategic attack is to conduct operations “to a point where the enemy no longer retains the ability or will to wage war or carry out aggressive activity.”¹ Employing a “hit ‘em where it hurts” philosophy, 2025 strategic attack operations run the gamut from traditional, highly destructive, force-on-force encounters to much less invasive, but very effective, computer-based warfare.

The diverse nature of potential adversaries, and the vast amount of information pertaining to them, requires an integrated approach to protecting American and allied security interests. Technological advances will enable all levels of leadership to successfully deal with the vast volumes of information in ways not envisioned or realized in the past. These advances will make it possible to accurately determine and engage an adversary’s Locus of Values (LOV). The LOV is that which an adversary holds dear, and which if influenced or threatened would affect the enemy’s ability or will to carry out covert or overt aggression against the United States.

LOVs are hard or soft. Hard LOVs are physical things: militaries, weapons of mass destruction, or industries. Soft LOVs are intangible things: Systems, knowledge, or ways of thinking. LOVs are engaged immediately or never, lethally or nonlethally, directly or indirectly. Each strategic situation is unique, yet in every case, the “force” applied against an LOV focuses on a strategic effect.

The key elements of strategic attack in 2025 are system analysis, target acquisition, target engagement, and feedback. Each phase is integrated and connected in virtual real time with the others through an organic integrated system directed to, and interpreted by, human decision makers.

Notes

¹ Department of the Air Force, *Air Force Doctrine Document 1, Air Force Basic Doctrine* (draft) (Langley AFB, Va.: USAF Doctrine Center, 15 August 1995), 13.

Chapter 1

Introduction

Strategic attack in the 2025 program is both unchanged from what it has been throughout human history and yet radically different. How can this duality be true? The truth is found in the ends and means of strategic attack.

Across time, the objective of strategic attack has been to conduct operations that would have a war-winning effect on an adversary. We need look no further than proposed Air Force doctrine, which asserts that the goal of strategic attack is to conduct operations “to a point where the enemy no longer retains the ability or will to wage war or carry out aggressive activity.”¹ In other words, we are doing things that will affect the entire war, not just a particular target, battle, or campaign. Therefore, it is the end result of strategic attack that has not changed.

The part of strategic attack that has changed involves the means. The methods by which attacks are planned and conducted to produce strategic effects will be very different in 30 years. The leaping advance of technology, different ways of organizing these technologies, and evolving military doctrine guarantee that the means will change. Clearly, strategic attack is not about weapons—any weapon can be strategic if it affects the adversary’s ability or will to wage war. Furthermore, the same weapon can be tactical, operational, or strategic, depending on its use and how it affects the enemy.

The key to strategic effect is the opponent’s values. Every adversary is unique; therefore, every strategic attack will be different. This idea has been handed down through generations of warriors as the concept of a center of gravity (COG).² The term *COG* created a good image in an age of Lapacian determinism, where machinery was the model; however, in 2025 the view is more organic, so the COG

concept loses some of its usefulness. A more descriptive term is LOV: that which is held dear and which, if influenced or threatened would affect the enemy's ability or will to wage war or carry out aggressive activity.³

Armed with the term *LOV*, we turn to the wave metaphor of Alvin and Hiedi Toffler for a framework in which to conduct strategic thinking. The Tofflers' paradigm asserts that human societies are evolving upward in waves, rather than in a constant climb. The societal waves are split into three segments, based upon what drives the entity's economy: agriculture, industry, or information. Further, the values of each wave society differ from those which another wave holds dear.⁴ The world in 2025 will contain societies rooted in each wave.

The Toffler model is useful to the warrior because it can be applied to a diverse range of potential adversaries. By using the wave model to ascertain the dominate societal focus of an adversary, one can gain insight into critical LOVs. With LOVs accurately determined, the samurai of 2025 can prosecute an effective strategic attack.

The Toffler wave model provides a point of departure for planning attacks.⁵ It suggests that: (1) first wave adversaries are best dealt with by targeting individual leaders or territory; (2) second wave opponents will be threatened by destruction of armies or industry, and (3) third wave enemies focus on idea-centered technologies or economies.⁶

The wave model helps us think about what to attack to achieve strategic effect, which is but one part of the process. Knowing the correct LOVs must be combined with acquiring and engaging them, and then determining if the attack was effective. This organic strategic attack process produces war-winning effects against an adversary. Figure 1-1 illustrates four key elements of strategic attack: system analysis, target acquisition, target engagement, and feedback.

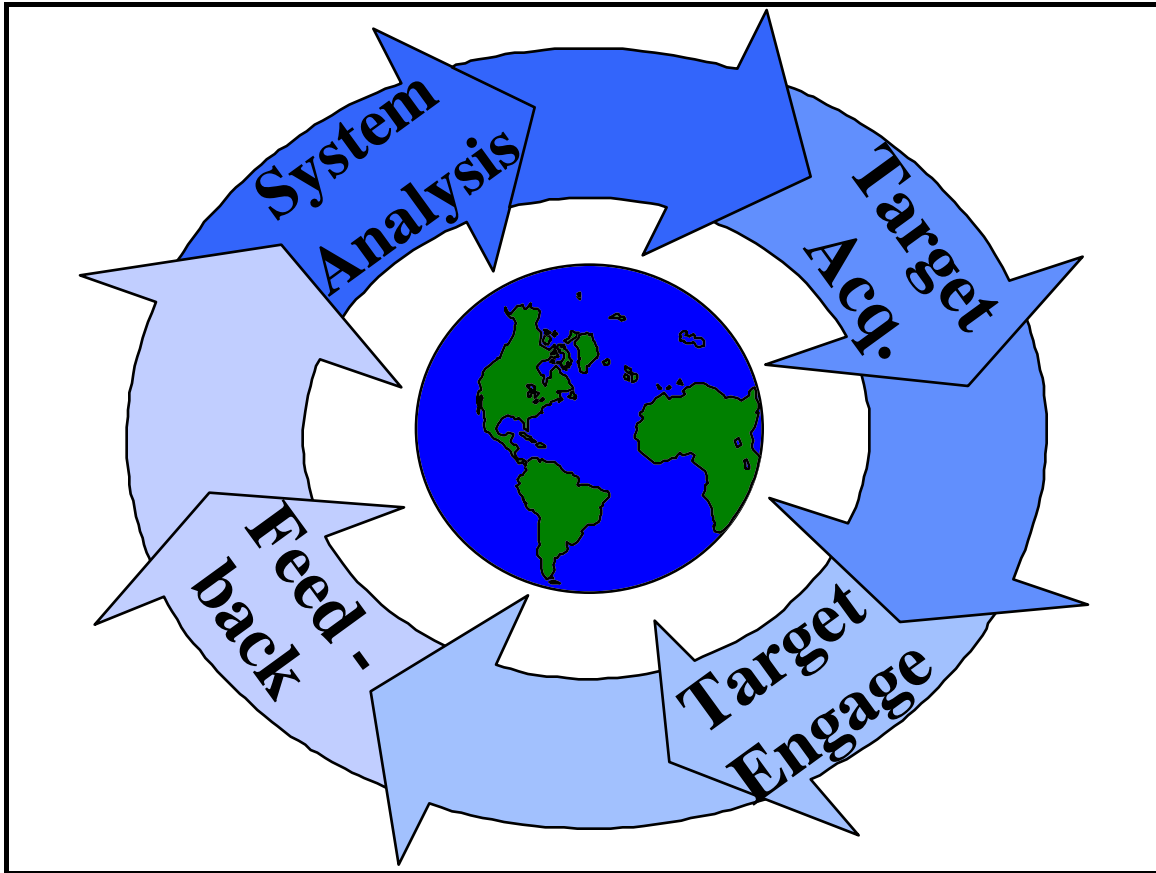

Source: Microsoft Clipart Gallery ©1995 with courtesy from Microsoft Corporation

Figure 1-1. Strategic Attack Process

Information links the above four elements of strategic attack. Information revolves primarily around the adversary's LOV, which eventually becomes strategic "targets" comprised of many dimensions. LOVs are either hard or soft. Hard LOVs are physical things: militaries, weapons of mass destruction, or industries. Soft LOVs are intangible things: systems, knowledge, or ways of thinking.⁷ Both are engaged immediately or never, lethally or nonlethally, directly or indirectly. Each case is different, yet in every case the force applied is aimed at strategic effect.

Notes

¹ Department of the Air Force, *Air Force Doctrine Document 1, Air Force Basic Doctrine* (draft) (Langley AFB, Va.: USAF Doctrine Center, 15 August 1995), 13.

² Carl von Clausewitz, *On War*, ed. and trans. Michael Howard and Peter Paret (Princeton, N.J.: Princeton University Press, 1976), 145-7.

³ For more information on targeting value see Joseph A. Engelbrecht, Jr. PhD dissertation *War Termination: Why Does a State Stop Fighting* (Columbia University: University of Michigan Microfilm, 1992).

⁴ Alvin Toffler and Heidi Toffler, *War and Anti-War*, (New York: Little, Brown and Co., 1993), 18.

⁵ *Ibid.*, 18.

⁶ *Ibid.*, 21.

⁷ LOVs are broken into two categories: hard and soft. Hard LOVs are things that we can, and have throughout the history of warfare attacked physically. The thought process for this being that by hurting an enemy we can change his mind about fighting—an indirect path to war fighting. Physical attack is used as demonstration model in this paper because history has proven that it can work. Another approach is to attempt to directly influence an enemy by manipulating his thought processes or values. This is the essence of targeting soft LOVs. Owing to the unproven nature of this approach, and the fact that it is well covered in the Team E white paper, it is not elaborated on here.

Chapter 2

Required Capabilities

Strategic attack in 2025 requires certain capabilities. Some capabilities will evolve from current organizational doctrine and technology. Other capabilities require revolutionary developments, much different from current tools of strategic attack. The capabilities required for each element of strategic attack are categorized as shown in Table 2-1.

Table 1
Strategic Attack Requirements for 2025

Strategic Attack Element	Required Capability
System Analysis	Knowing the LOV
Target Acquisition	Locating the LOV
Target Engagement	Affecting the LOV
Feedback	Determining results

System Analysis

In his pamphlet *10 Propositions Regarding Airpower*, Col Phillip Meilinger suggests that “In essence, Airpower is targeting, targeting is intelligence, and intelligence is analyzing the effects of air operations.”¹ Knowing what to attack to achieve the desired effect is the critical element. Further, what to target varies greatly between adversaries. The LOV for a textbook second wave nation may be its industrial web. For a nation possessing a small military capability, yet wielding tremendous informational and economic might, the LOV may be their information infrastructure. For nonstate actors such as terrorist organizations, drug cartels,

or organized crime syndicates, the LOV may be their leadership. In short, knowledge acquisition is particularly important in strategic attack because the aim is to impact across the whole of an adversary from highly focused inputs.

Knowing “what” to attack has always been difficult, and it will become harder in 2025 for a number of reasons. The first concern involves the growing number of actors. A burgeoning number of sovereign states, emerging transnational groups, multinational corporations, and other organizations will influence US policy. Next, add increased access to previous “close hold” information through the explosion of media, the Internet, and population migration. And finally, stir in a world political dynamic that is much more fluid than during the cold war. Because of all these challenges, the system analysis problem becomes incomprehensible to the unaided human decision maker.

The human decision maker’s ability to determine strategic LOVs in 2025 will come from a combination of technologies. These include exploiting national and global databases, employing artificial intelligence (AI) technologies to turn that data into usable information, and using increased computational capacity to run the AI programs in a near-real-time fashion.

Exploiting data 30 years hence will certainly remain a daunting task. The USAF Scientific Advisory Board (SAB) addresses this problem in their *New World Vistas* study: “Much of the information which is needed to construct the global picture exists today in computers somewhere. The problems of the next decade are to identify the relevant databases, to devise methods for collecting, analyzing, and correlating them, and to construct the needed communication and distribution architectures.”² Therefore, a critical enabling capability to conduct strategic attack in 2025 is an ability to exploit all relevant sources of existing and emerging data.

Turning the acquired data into useful information for strategic decisions is the task of AI technologies. AI is a multidisciplinary field that aims to develop device technologies capable of solving problems in a manner similar to that of a human being. AI permits a computer to constantly comb vast amounts of data for useful kernels of seemingly unrelated data, process them into information, and then deliver that information to decision makers in a timely manner. Advanced AI is required to correlate the mountain of unorganized data located throughout the information domain.³

AI technology employs sophisticated computer programs. By its nature, AI requires large amounts of computational ability and storage capacity. Current hardware meets the needs of today's AI applications; however, by 2025 AI applications will require faster processors and much larger data storage capacities.

Target Acquisition

As mentioned previously, the AI system requires a cumulative database to help decision makers determine the possible LOVs of an adversary.⁴ A portion of that AI database originates from the target acquisition system. Target acquisition involves the continuous collection of data for analysis and use by the AI network. A collection of sensors search for different types of signatures common to LOVs. This data is transmitted in virtual real time to the AI database to be analyzed and applied to the strategic attack process.

The target acquisition system does not simply push data to the AI network; it also must pull information from the network. Pulling information from the AI network narrows the search pattern for the sensor platforms and reduces the time required to locate specific targets. For example, the AI network may determine that an LOV for a certain adversary involves the capability to produce and employ chemical weapons. The target acquisition system can orient itself to search more efficiently by pulling from the AI network details such as the probable chemical composition and size of strategic production facilities, about the LOV. Once the LOV is located, the sensor platforms periodically revisit the region to detect any changes in activity.

In order to locate specific LOVs, the target acquisition system requires novel sensors that essentially can see, hear, smell, taste, and touch. Current target acquisition systems for strategic attack depend heavily on sensors that only provide image data from the infrared and visual spectrums. Having different types of sensors in 2025 provides complementary data for the AI network to analyze and helps detect an adversary's LOVs.

The platforms supporting the sensor array vary, depending on the sensor's capability. As shown in figure 2-1, space and airborne platforms, including stealthy unmanned aerial vehicles (UAVs), can operate jointly to provide the AI network continuous coverage of a specific region or land mass. Unattended ground

sensors (UGS) rely on their minute size to avoid detection by an adversary. In 2025, sensors the diameter of a human hair will allow continuous, stealthy, on-site collection, providing the AI network the critical data necessary for making decisions concerning strategic attack.⁵

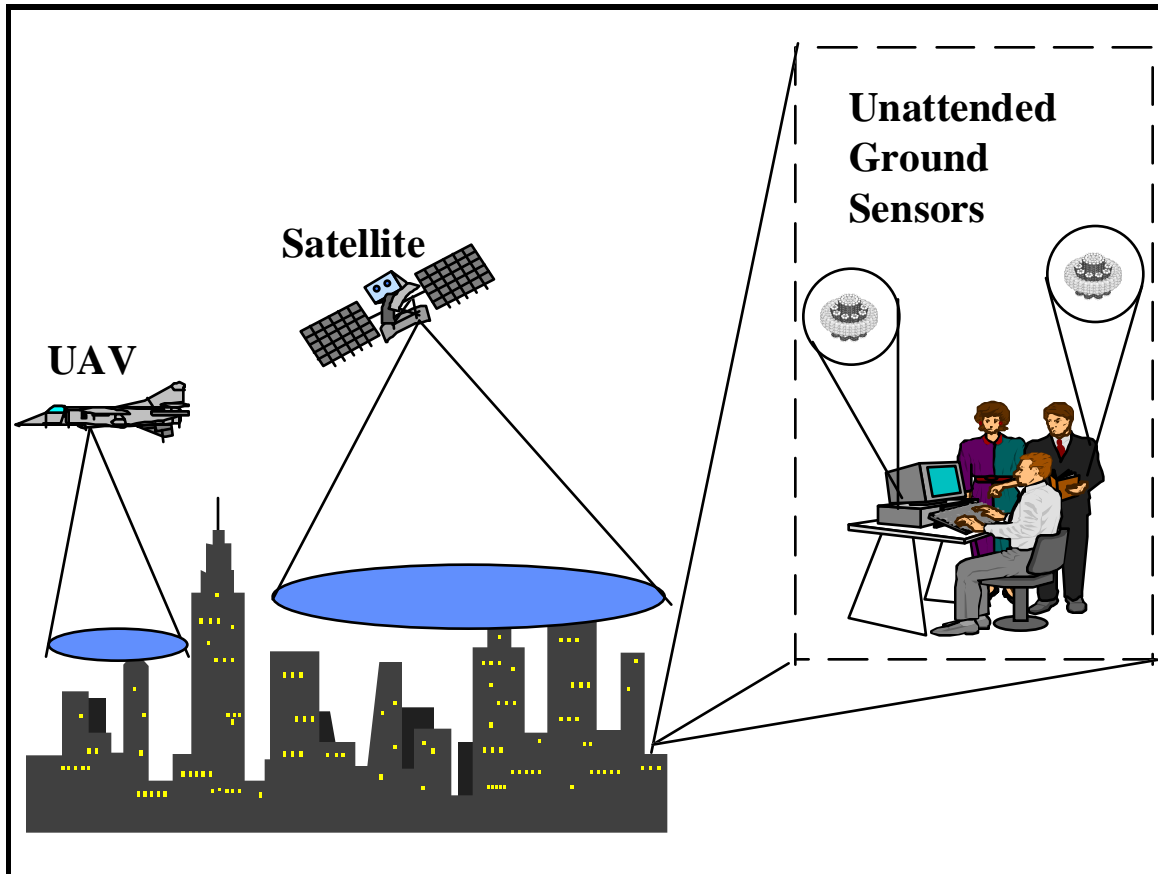

Source: Microsoft Clipart Gallery ©1995 with courtesy from Microsoft Corporation

Figure 2-1. Sensor Platforms

The final requirement for target acquisition in 2025 involves the necessity for sensor data to be transmitted instantaneously to the AI database. Sensor platforms such as satellites and UAVs can transmit data directly to relay stations on the ground or in orbit. Tiny unattended ground sensors depend on an external source to amplify sensor signals. The end result is complementary data from different sensor arrays delivered simultaneously to the AI network for analysis and application in the strategic attack process.

Target Engagement

In 1943, according to McKittrick et al in *The Revolution in Military Affairs*, the U.S. Eighth Air Force prosecuted only 50 strategic targets during the entire year. In comparison, during the first 24 hours of Desert Storm, the combined air forces prosecuted 150 strategic targets—a thousand-fold increase over 1943 capabilities.⁶

In the year 2025, air and space power must make a similar leap in capability to ensure that the US maintains the advantage against its potential enemies. This will be accomplished through capabilities that affect LOVs in a very diverse manner. The system analysis and target acquisition processes provide the details of how to engage each LOV. These details can be characterized by the three boundaries depicted in figure 2-2. The first boundary ranges from lethal to nonlethal force. The second boundary involves the use of either direct or indirect means. The last boundary indicates that the time to engage an LOV will range from immediately to never.

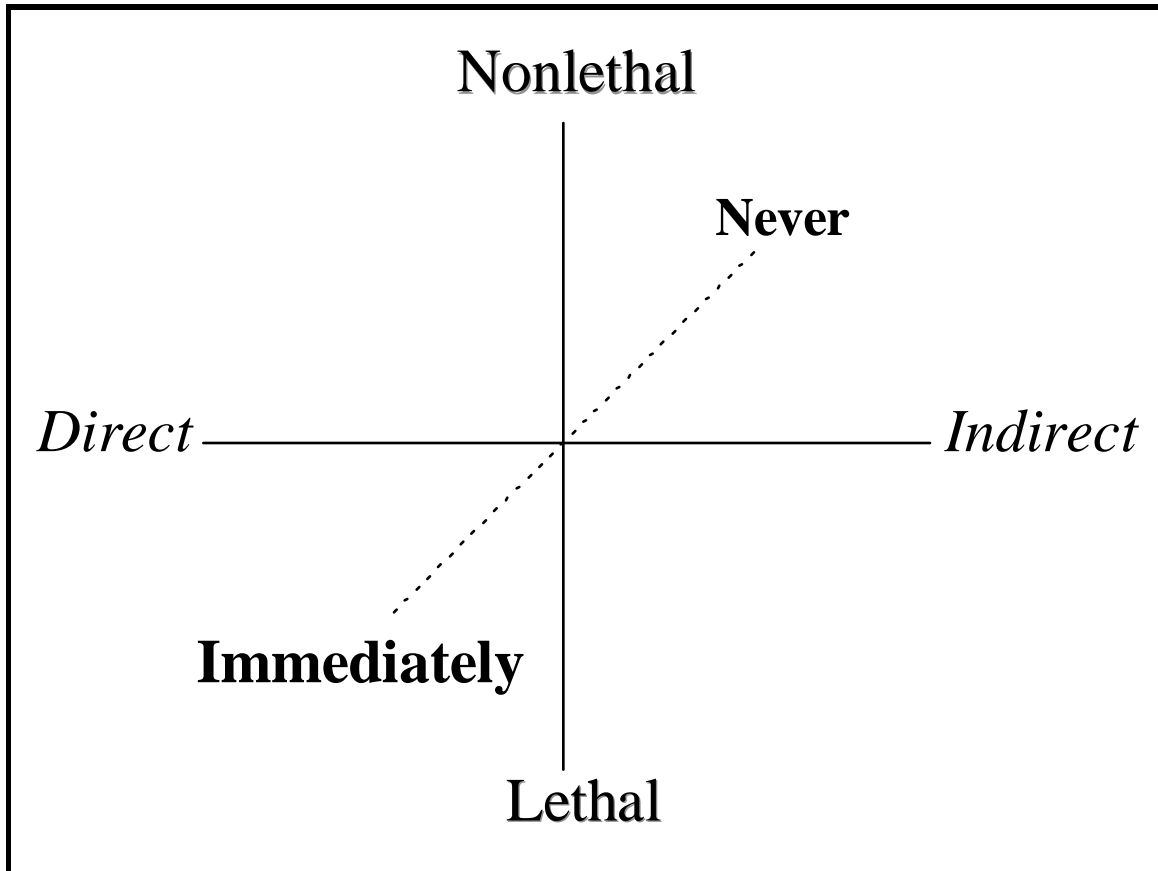

Figure 2-2. LOV Engagement Spectrum

The application of airpower has traditionally been accomplished by directly applying lethal force. However, many cases in the future will call for nonlethal force, especially when engaging another advanced “post-industrial” society. For example, against a third wave adversary we might attempt to disrupt, dominate, and then reorder an enemy’s decision cycle.⁷

Although the Gulf War demonstrated that airpower can deliver direct, lethal force against a target set, there remains much room for improvement. As military force structures continue to downsize, we will lean towards systems capable of affecting multiple LOVs per mission. Instead of an F-117 flying over Baghdad to drop two precision guided munitions (PGM), it is more cost-effective to deliver dozens of PGM-type munitions on the same mission. In 2025, this capability allows a single mission to have the same results as a squadron of F-117s.

An organic, multiple engagement capability increases the application of air and space power throughout the enemy’s strategic system with such great speed and momentum that hyperwar results. The simultaneous engagement of LOVs makes an adversary’s recovery difficult because the remaining energy available to the system is inadequate to restore it to full capacity.⁸

The time to engage a strategic LOV can range from “immediate” to “never.” An example of “never” is making a conscious decision not to attack an enemy’s head of state, as in the case of Iraq’s Saddam Hussein. Another example is the “Ultra” intercepts of Nazi war plans during World War II. Indeed, Churchill had to make numerous painful decisions not to defend Allied assets he knew were going to be attacked for fear of alerting the Germans to prior Allied knowledge of their plans.⁹ On the other hand, we need the capability to engage some LOVs “immediately.” An example is a convoy of NBC weapons discovered less than a mile away from a hardened storage facility deep inside a mountain. The US might have less than one minute to react and destroy these weapons before the engagement opportunity disappears.

The key to successful target engagement is having the air and space power to execute target engagements in terms of lethal or nonlethal force, direct or indirect means, and at the correct time. This will be accomplished by a combination of improvements in weapons and strategic attack platforms.

Feedback

Following a target engagement, the AI network requires near-real-time postattack data to determine subsequent courses of action. Having an instant feedback capability shortens the operational timeline required for strategic attack in 2025. The same sensors used for target acquisition provide the necessary feedback data to the AI network. The data from different sensors is collected and then quickly fused into accurate mission evaluation results by the AI network. This feedback process answers the question as to the outcome of the strategic attack: To what degree did the mission succeed or fail, and did any positive or negative side effects occur that require further action?¹⁰

Notes

¹ Col Phillip Meilinger, *10 Propositions Regarding Airpower*, (Air Force History and Museums Program, 1995), 1.

² USAF Scientific Advisory Board, *New World Vistas: Air and Space Power for the 21st Century*, summary volume (Washington, D.C.: USAF Scientific Advisory Board, 15 December 1995), 25.

³ *Ibid.*, 38-44.

⁴ The proposed system is designed provide suggested LOVs to human decision makers, along with the thought processes behind their selection. The human will then make engagement decisions.

⁵ Gary Stix, "Micron Machinations," *Scientific American*, November 1992, 107.

⁶ Jeffrey McKittrick et al., "The Revolution in Military Affairs" in Barry R. Schneider and Lawrence E. Grinter, eds., *Battlefield of the Future* (Maxwell AFB, Ala.: Air University Press, 1995), 78.

⁷ Barry R. Schneider and Lawrence E. Grinter. *Battlefield of the Future* (Maxwell AFB, Ala.: Air University Press, 1995), 149.

⁸ Col Richard Szafranski, "Parallel War and Hyperwar: Is Every Want a Weakness" in Barry R. Schneider and Lawrence E. Grinter, eds., *Battlefield of the Future* (Maxwell AFB, Ala.: Air University Press, 1995), 128.

⁹ Schneider and Grinter, 150.

¹⁰ The measure of success that the system would be reporting to human decision makers would focus on the desired effect on enemy decision makers.

Chapter 3

Strategic Attack Systems Description

The process required to conduct strategic attack in 2025 uses a “system of systems,” with each subsystem solving one particular part of the attack problem (fig. 3-1). The process is organic, in the sense that all of the parts are interlinked and interactive, each receiving and delivering input to the others. It provides targeting information containing the LOVs upon which the US should act, whether they are hard or soft, should be acted on now or never, lethally or nonlethally, and directly or indirectly.

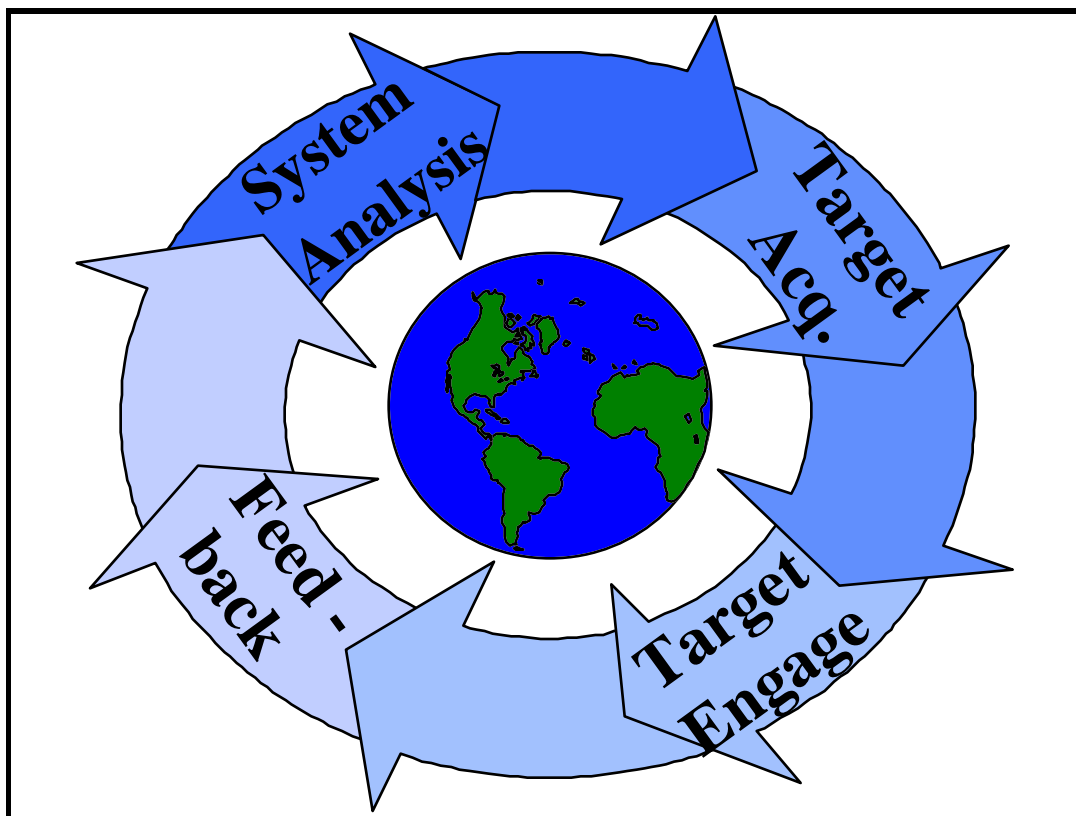

Source: Microsoft Clipart Gallery ©1995 with courtesy from Microsoft Corporation

Figure 3-1. Strategic Attack Process

System Analysis System

A component of the strategic attack model is the system analysis system, this which will operate for decision makers in 2025. It will be composed of a pervasive, distributed, relational database; a blackboard artificial intelligence architecture; and a massively parallel, distributed computing capability. The system analysis system, shown in figure 3-2, functions to provide the decision makers with the knowledge that they need to direct strategic attack.

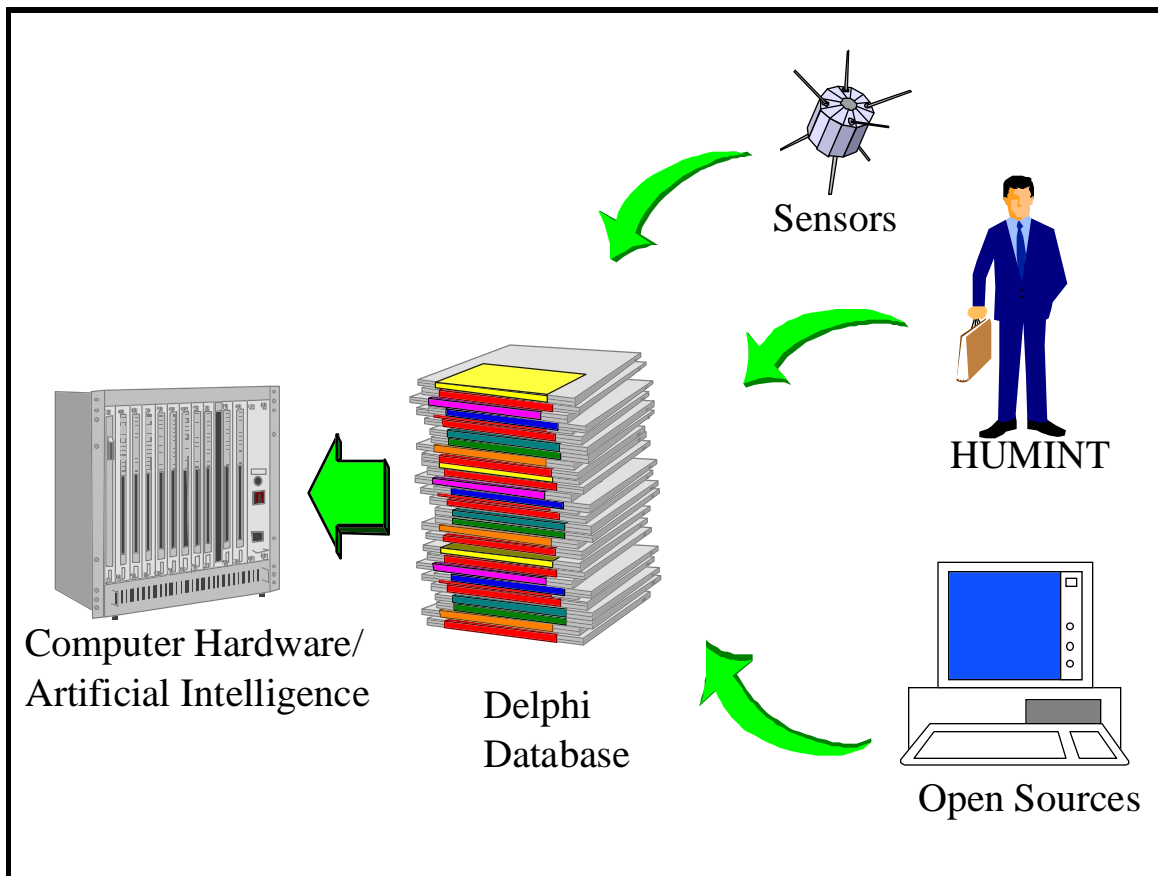

Source: Microsoft Clipart Gallery ©1995 with courtesy from Microsoft Corporation

Figure 3-2. The System Analysis System

The 2025 system analysis system relies on a pervasive, distributed, and relational database.¹ The data comes from all sources, spanning the spectrum from state of the art sensors collecting information in virtual real time, to archives on ancient history and culture. Because the database is so pervasive and distributed, it functions as a database of databases, with the primary users of each segment maintaining their separate parts. Its decentralized, and partitioned structure permits data to be added or altered as future experience shows is

necessary.² A depiction of this type of database arrangement is shown in figure 3-3. In this diagram, four widely separated databases combine to form the Delphi database for the strategic problem or problems that the system is working. The actual titles of the databases in figure 3-3 are notional. The important points to note are that the individual databases originate from virtually anywhere and are tied together by a network to comprise the Delphi system for solving a particular problem. A different set of variables would result in a different database combination.

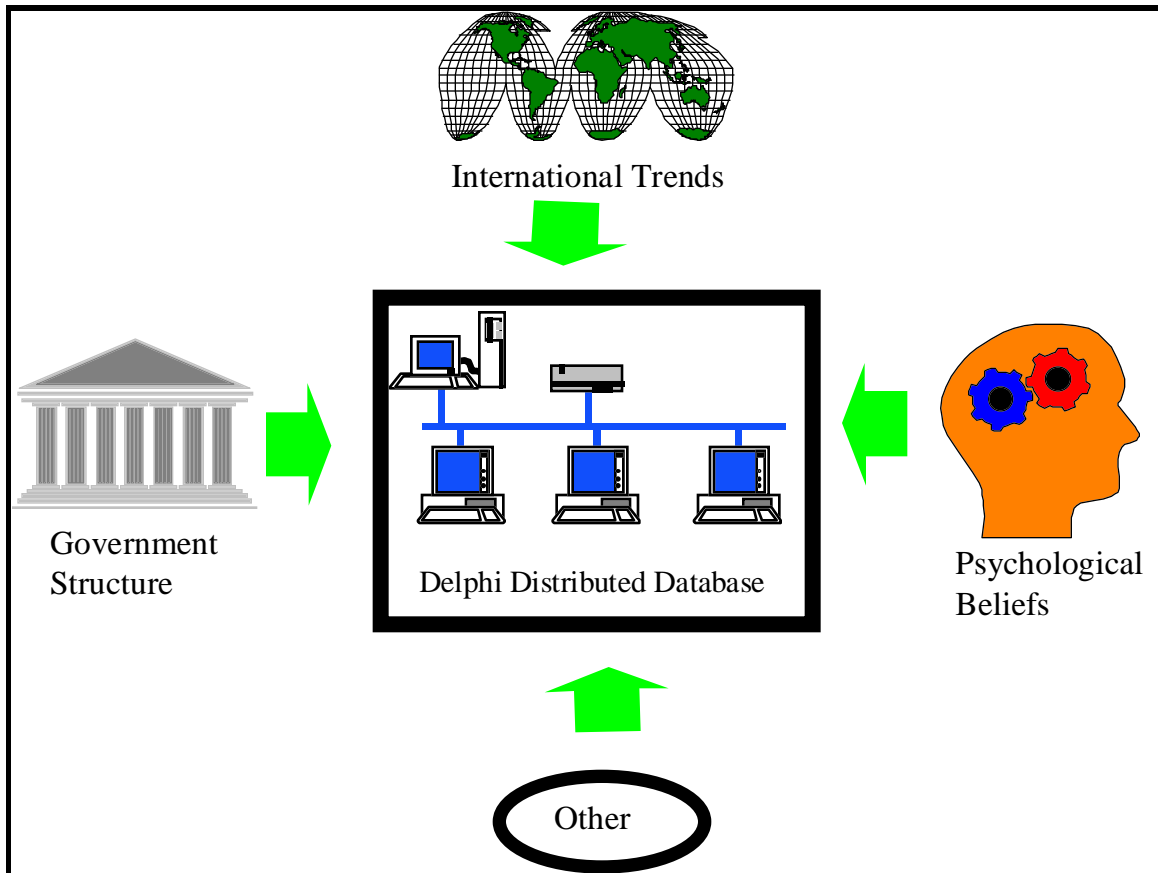

Source: Microsoft Clipart Gallery ©1995 with courtesy from Microsoft Corporation

Figure 3-3. Delphi Database

The technology to facilitate this database will develop at varying rates, so the structure of the database allows the components to be incorporated as they emerge. Electronic data storage and access rates are advancing at a great pace. A recent study suggests that likely advances in optical disk technology and applications of “parallelism” hold the potential for significant increases in storage capacity.³ Broadband fiber optic networking technologies that allow for the distributed nature of the system are advancing and will continue to improve volume and speed of data transfer. The USAF SAB postulates that ultra-high-speed

broadband commercial backbone networks will be widely available by 2005. This infrastructure essentially gives infinite bandwidth to all users, therefore minimizing networks as a limiting factor for the database system.⁴

Access to diverse amounts of information could be a problem. As the value of information grows in the world economy, many distributed databases may become proprietary, denying the Department of Defense (DOD) access. The networked and distributed nature of the Delphi database requires the ability to secure the sensitive parts of it.

The Delphi database could, of course, be countered in a number of ways. The potential opponents of the US could shield the data that we desire. They could prevent our sensors from observing sensitive physical targets, or they could attempt to camouflage or obscure them. Opponents could close their societies, preventing us from collecting information concerning who their leaders are and how they think. Additionally, they could physically attack the data storage or transmission infrastructure or corrupt the data contained in the system. The best counter for attempts to prevent our data collection is a redundant and complementary collection system—many different types of sources. Possible countermeasures against data corruption include comprehensive physical security and defensive information warfare measures.

Artificial Intelligence

AI involves programming a computer to solve problems that normally only people can handle. In 2025 AI provides the help that humans need to make strategic attack decisions. The role of AI is to constantly process the data stored in, and streaming through, the Delphi database. The ultimate goal is to use AI to determine the best way for the US to conduct strategic attack against an emerging opponent. A number of different AI approaches exist, a partial list of them includes expert systems, CBR, and neural networks.

Expert systems turn the knowledge of a human expert into a computer program, and through an “if. . .then. . .else” process, applies that codified knowledge to similar, future problems. They cannot extend that knowledge outside the expert’s field.⁵ CBR is a technique that suggests actions by recognizing similarities between current problems and previously solved occurrences. Because CBR focuses on past problem resolutions rather than the current problem, it is quickly and easily implemented. To the point that new problems differ from those of the past, however, CBR has less value.⁶ The third AI approach involves

neural networks. They employ real-world ambiguous data points to determine a relationship, apply the relationship to make decisions, and constantly review the derived relationship to learn and improve the decision making process. Neural networks require, neither a human expert's knowledge nor past occurrences of the problem in order to function. Further, they can make constantly improving predictive decisions.⁷

The architecture of the AI portion of the system analysis process involves a modified blackboard expert as shown in figure 3-4. A blackboard system is a hybrid expert system comprised of a collection of independent components called "blackboard," "knowledge modules," and "control module."

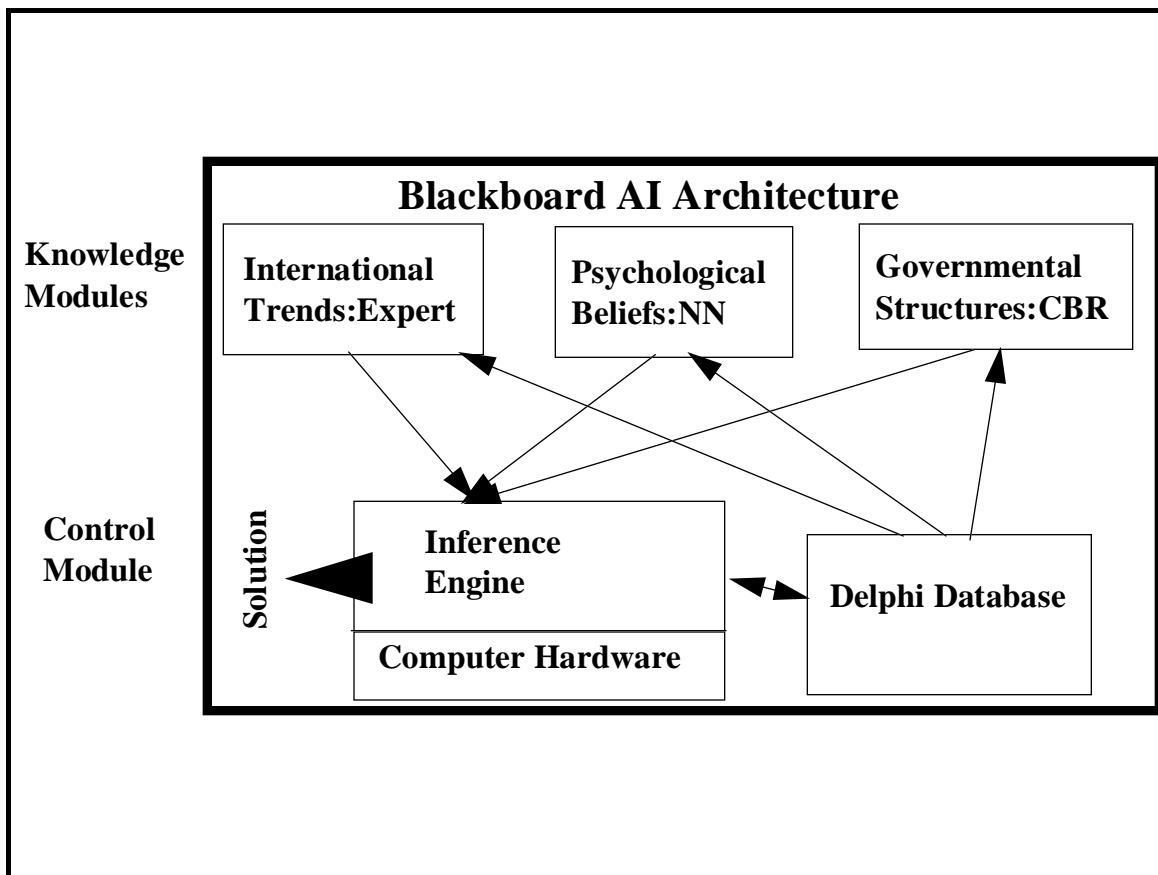

Figure 3-4. Artificial Intelligence Architecture

The blackboard is the part of computer memory that contains the control module and the knowledge modules. The knowledge modules are a collection of independent components that, when combined, provide the information necessary to solve the problem;. The modeler can choose the optimal AI technique for the problem being worked. Each knowledge module can function independently to determine an optimal solution for the problem that it is working.

The control module provides a vehicle for combining the outputs of the knowledge modules in order to arrive at a solution. It does this through the use of an “inference engine,” an algorithm combining AI technologies. The control module considers all contributions from each knowledge module, selecting only those that are appropriate at the time. It weighs each contribution according to its value rating. The control module is linked to the Delphi database to monitor its operation, directing data to specific knowledge modules through the use of software agents.⁸ By monitoring the database, the control module ensures that significant events get routed to the proper place in priority fashion. It devises workarounds and graceful degradation strategies if parts of it fail.

In figure 3-4, the control module combines an expert system, a CBR system, and a neural network system to make decisions. The presence of the first two ensures that the system has the knowledge necessary to make the right call. The use of the neural network adds the ability to learn from past events. A promising scheme for combining these different AI approaches is Fuzzy Approximation Theory, which weights the methods by variable amounts based on the traits of the adversary and the situation.⁹

The blackboard system also enables the proposed AI solution to be “what if’d.” Before proposing a COA, the blackboard expert inputs the decision to a world database residing in memory and games the likely consequence. This simulation process is iterated until arriving at a COA that generates an optimal solution. The solution is then provided to the human decision maker. The “gaming” feature is essential in order to explicitly consider the interdependent nature of world affairs. In *New World Vistas*, experts assert that by 2020 the fuzzy methods required by the inference engine of the “control module” will mature and the ability to “game” proposed COAs will exist.¹⁰

Before an AI system can be reliably employed, much improvement is required. The techniques employed above have been used only at very basic levels. A university professor developed an expert system to explain US foreign policy decisions made in Asia. When his model was backcasted to the 1950s it predicted a very favorable 86 percent of the decisions that the U.S. ultimately made.¹¹ CBR applications are being used commercially to handle customer service calls, with a technician asking the customer questions that take him through a fault isolation tree developed from past product failures.¹² Many examples of neural networks are in operation today.¹³ Finally, the Navy uses blackboard systems to manage complex electronic

networks.¹⁴ While these AI applications are simple compared to the requirements for 2025, they document the great strides being made in this field.

The AI portion of the system can be countered. AI requires the input of data to make decisions. If entered data is inaccurate or corrupted, the AI decisions will be degraded. Verifying the data and decisions for reasonableness minimizes this problem. Since the AI program operates in the electronic environment, it is subject to physical attack—either on the computers or on the electricity sources required to operate them. Steps to enhance the physical security of each major facility, combined with the distributed nature of the system, helps defend against these types of attacks. Finally, since AI is essentially a software-driven system, it is subject to information warfare attacks. This avenue of attack is best countered by an active counterinformation warfare capability.

Computer Hardware Requirements

The significant capability of the system analysis system of 2025 depends on improvements in computing capability.¹⁵ Current processors cannot run the AI programs this system requires.¹⁶ However, massive parallel Central Processing Unit (CPUs), where a large number of processors are combined on individual silicon chips, are being exploited commercially today. Again, there remains room for much growth.¹⁷ Technical experts maintain that the current exponential growth in computing performance based on silicon technology will continue through 2006, at which point material constraint will force alternate methods. Promising alternate technologies include quantum, molecular, and optical computing methods.¹⁸

Target Acquisition System

In 2025, an organic relationship exists between target acquisition and the Delphi database. It is the classic “chicken or egg” relationship: the Delphi database must know the LOV exists before telling target acquisition sensors to find it; but the existence of the LOV may be discovered only after the target acquisition sensors collect initial data hinting at the LOV’s existence. By necessity, therefore, the target acquisition phase operates continuously, passing streams of data to the Delphi database for analysis, while at the same time pulling fused information from the database to help guide the acquisition process.

The target acquisition system must provide decision makers the capability to detect changes in the personal values of an adversary. Changes in a leader's emotions, thoughts, or frame of reference are of interest to the strategic attack system. Techniques that get into the "head" of an adversary to obtain valuable information require revolutionary advances. Finding plausible methods for accomplishing this task is the focus of the classified "Information Attack" white paper. The target acquisition portion of strategic attack in 2025 complements these techniques with a diverse arsenal of sensor platforms.

Data collected by target acquisition sensors can range from single bits of data, like an LOV's exact location, to an entire library of data, such as the LOV's normal activity levels. In the year 2025, sensor collection provides enough data for a virtual 3-D model of the LOV to include its composition, internal structure, baseline characteristics, and tendencies. Using a biological warfare (BW) storage facility as an example, and in the most optimistic case, sensors determine the building's exact dimensions and floor plan. They then highlight possible soft spots. Sensors distinguish between rooms containing biological agents, test equipment, sleeping quarters, and even the snack bar.

Target acquisition sensors also construct a baseline, or living archive, of data concerning routine activity and environmental conditions. Examples include the average number of people who enter and exit each day, the number of vehicles in the parking lot, and the level of noise generated by the facility. This baseline data, combined with 3-D modeling, provides benchmarks for detecting changes in data collection; for example, a sudden increase in vehicular traffic or human activity.¹⁹ Changes in an LOV's baseline activity data can be flagged to determine its significance. The AI system, or a human imagery analyst, can determine if the LOV requires a closer look by target acquisition sensors.

Target Acquisition Platforms

Target acquisition platforms in 2025 can be airborne, space-based, or ground-based. Function, cost, and vulnerability determine where to mount a sensor. It makes little sense to build expensive space platforms for sensors that work effectively from the ground.²⁰ On the other hand, some sensors may work effectively only above a certain altitude or from space. In any case, having a variety of platform types decreases an adversary's opportunity to completely stop sensor data collection and its transmission to the Delphi database.

A combination of commercial and military satellites should provide continuous worldwide coverage in 2025. Spatial resolutions of 10 meters, improved to two or three meters through signal-to-noise ratio calculations, will be available instantly and continuously.²¹ In addition, expect multispectral, hyperspectral, and synthetic aperture radar images to provide periodic submeter resolution throughout a 24-hour span.²² However, to obtain higher resolution images of LOVs on a *continuous* basis, airborne platforms must be employed.

Airborne sensor platforms can be described as standoff systems or overhead systems. A standoff system loitering along a political border at 50,000 feet can stare 230 miles downrange at an LOV and provide continuous one meter resolution.²³ Unmanned aerial vehicles (UAVs) or simple high altitude balloons could carry these sensors. In addition, a low observable UAV that loiters directly over a specific area will carry sensors that provide continuous one centimeter resolution.²⁴ The final type of sensor platform provides acquisition information that is unavailable from space-based assets.

Ground-based platforms in 2025 rely heavily on micromechanics and nanotechnology to shrink sensors and platforms to microscopic sizes.²⁵ These platforms could be inserted via human agents, through water or food supplies, or through aerial seeding operations using UAVs. Microsensors thinner than human hairs could transmit data to the Delphi database via UAV or satellite relay.²⁶ A swarm of ground-based microsensors could ensure constant data transmission of local conditions and activity levels near and inside an LOV.²⁷

Except for micromechanical platforms, the *hardware* for most sensor platforms exists today. However, it is the sensors and not the platforms that collect the data to acquire the LOV. Therefore, the key to effective target acquisition in 2025 will be the development of critical sensor technologies. These technologies allow continuous collection of daytime, nighttime, and weather data that feeds the Delphi database to generate new LOVs.

Critical Target Acquisition Sensor Technologies

Successful target acquisition depends on critical sensor capabilities that will require much more development before the year 2025. To simplify their descriptions, the sensors can be compared to the human

ability to see, hear, smell, and taste. And just like in humans, the sensor data collected can be fused by the Delphi database to provide accurate information concerning LOVs. Traditionally, the “seeing” technologies dominated the sensor field using spectral analysis of the visual and infrared (IR) bands, along with SAR returns.²⁸ In 2025, radically different sensors add critical data to confirm or dispute what we think we “see.” Having sensors that provide complementary data (instead of duplicating data) ensures better accuracy and reliability. It also prevents an enemy from defeating the entire system by destroying, or defending against, one type of sensor.²⁹

Visual Sensors. Multispectral Imaging MSI currently dominates the sensor field. As mentioned before, the use of the visual and IR bands, plus SAR can provide resolution from 10 meters to one centimeter, depending on the platform distance from the LOV and loiter capability.³⁰ New technologies, like hyperspectral imaging, laser-light detection and ranging, and magnetic resonance imaging, can provide other methods to paint an LOV.

Instead of concentrating on a single broad-spectrum band, hyperspectral imaging involves slicing the entire electromagnetic spectrum into hundreds or thousands of single-wavelength data bands for collection.³¹ The bands that produce a signature can be fused together by the Delphi database to construct a target signature.³² LOVs may be able to avoid detection in one spectrum but not from all spectrums.³³ Due to size and weight, hyperspectral sensors will likely require airborne or space-based platforms.

Laser-based light detection and ranging (LIDAR) sensors offer great hope for detecting atmospheric changes due to chemical and biological reactions. By actively probing the atmosphere, LIDAR sensors will detect and construct 3-D images of aerosol clouds common to factories and machines. One can develop a best guess as to what a factory or machine produces by comparing predetermined aerosol images of known substances.³⁴ These sensors could also be used to warn of possible chemical and biological warfare agents on a battlefield. Future LIDAR sensors will easily fit in a small suitcase, making them adaptable for satellite and UAV platforms.³⁵

Magnetic resonance imaging (MRI) is a sensor technology that is useful in building 3-D images of LOVs in 2025. An MRI sensor offers the advantage of imaging the internal, as well as external, structure of the LOV. UAVs could blanket a building with specially designed dust particles that circulate throughout the

structure's ventilation system.³⁶ Then MRI equipment and sensors carried on space-based or airborne platforms could scan the structure, analyzing the circulation of the dust particles to construct an internal image of the LOV.

Sound Sensors. Sound sensors can measure vibrations in the atmosphere or through materials. The ability to listen to human conversations using microphones mounted on space platforms may be available in 2025, but it will be expensive. A cheaper method involves miniature microphones built through micromachining. These sensors, the size of pinheads, could be planted via UAV seeding operations, human agents, or even letters sent through the mail.³⁷ The ability to listen to an LOV and its surrounding environment will provide early warning of an adversary's intention, especially when fused with the cues detected by visual sensors.

A second use for acoustical microsensors involves measuring seismic vibrations and mechanical resonance. Acoustic resonance spectroscopy can reveal the contents of sealed containers by analyzing the container's mechanical resonance.³⁸ Using a horde of tiny microphones, an entire structure could be analyzed and the data from each sensor relayed to the Delphi database via an overhead collector. These sensors could also be used for seismic mapping of underground facilities (like command bunkers) that escape detection by visual sensors.³⁹

Smelling Sensors. In 2025, olfactory sensors will be similar in size to microscopic hearing sensors. Unlike the LIDAR system that detects signatures of aerosol clouds, smelling sensors can detect the actual chemicals themselves. Organic thin film coatings on tiny platforms will contain prefabricated "molecule buckets" to trap suspected chemical molecules. If the chemical is present, the buckets fill up, changing the organic property of the platform.⁴⁰ When irradiated by ultraviolet or X-ray energy, these organic changes can be scanned and analyzed by overhead sensors.⁴¹

Another novel smelling technology available in 2025 involves tracking humans via genetically-linked body odors.⁴² These odors, undetectable by the human nose, can be sensed by bundles of sensors that then transmit the data to the neural network portion of the Delphi database. Since each sensor reacts differently to chemical compounds, specific compounds can be identified.⁴³ If it is possible to get an "odor" sample of an enemy leader, then olfactory sensors could be used to detect and track the human LOV.

Tasting Sensors. Sensors that transmit data after tasting an LOV can provide discriminating clues for the Delphi database in 2025. Tasting sensors can be prefabricated to detect--and attach to--certain types of surfaces, similar to the way smelling sensors have prefabricated molecule buckets. A variety of tiny taste sensors could be dispersed over an LOV, and then irradiated and scanned to gather data.⁴⁴ Taste sensors designed to detect aluminum would stick to aluminum aircraft wings but fall off wooden decoys. Other sensors could taste buildings or vehicles for radioactive fallout, chemical residues, or biological agents.⁴⁵

If sensors can be designed to attach to specific compounds in 2025, they can be designed to attach to specific people. Like prickly cockleburs, tiny sensors would cling to certain humans, effectively tagging them for continuous tracking via overhead platforms.⁴⁶ If a human LOV cannot be tagged specifically, certain items common to that person, like vehicles and clothing, could be tagged for tracking. Possessing the ability to detect and track a human LOV adds greater flexibility to the strategic attack process.

A constellation of sensors provide the tools for detecting and tracking LOVs in 2025. These sensors form the backbone of the target acquisition phase, offering overlapping and complementary capabilities. The data collected is delivered to the Delphi database, where LOVs can be determined and courses of action formulated. When a decision is made to commence strategic attack, the target engagement platforms receive whatever information has already been collected. That information will include the LOV's description, location, weaknesses, strengths, and the suggested method of attack to achieve the desired effect.

Target Engagement System

The third component of the strategic attack process, is target engagement. It provides the method for generating strategic effects in 2025. The targets identified for strategic attack vary widely based on the adversary and the situation, and require a diverse arsenal of capability. This arsenal must include means to affect hard and soft LOVs directly/or indirectly, using lethal or nonlethal power, and within an immediate to indefinite time frame. Futuristic engagement systems and techniques such as holographic projection, noise and gravity fields, biomedical operations, psychological operations, military deception, and information attack are all possible. These innovative indirect means are discussed in the classified C² and Information

Attack white papers. As a complement to those indirect techniques, this paper focuses on target engagements that use direct attacks with lethal and nonlethal power.

In 2025, the effectiveness of an attack is a critical factor. In the *New World Vistas Summary Volume*, modeling experts showed that “if the effectiveness of the attacker is increased from one to five, and the initial forces are equal in number, the attacker will lose approximately 10 percent of the force while destroying the enemy entirely.”⁴⁷ Since the *2025 Alternate Future* study depicts a smaller US military in most cases, we need to significantly increase our attack effectiveness through improvements in weapons and delivery platforms.⁴⁸

Weapons

By 2025, conventional explosive weapons will be more accurate and their explosive effectiveness per unit mass will be higher by a factor of ten than those of today.⁴⁹ The miniaturized munitions technology demonstration’s (MMTD) goal is to produce a 250-pound munition that is effective against a majority of hardened targets previously vulnerable to only 2,000-pound munitions. A differential GPS/INS system will be an integral component of the MMTD to provide precision guidance. These guidance and smart fusing techniques will produce a high probability of target kill.⁵⁰ Self-targeting missiles will compliment the MMTD. These missiles have microoptics, aerodynamic actuator arrays, active skins, and microelectromechanical system (MEMS) technologies. The many advantages of these missiles include standoff capability and relatively cheap production costs.⁵¹ Conventional weapons, however, will not provide the full range of options required in 2025.

Although many of the weapons used today will still be employed in 2025, directed energy weapons (DEWs) have great potential for strategic attack missions. The three general classes of DEWs are laser, radio frequency (RF), and energetic particle beam. They present an excellent complement to conventional weapons due to their characteristics. First, some DEWs have a higher probability of hit compared to projectiles. This is because the spreading beam can irradiate the entire target, therefore requiring less pointing and tracking accuracy. Second, they offer near-instantaneous engagement capability in most weather conditions. Third, each has a large magazine compared with the typical aircraft store of conventional

projectiles and missiles.⁵² Fourth, DEWs have the potential to be much cheaper to support than conventional explosives. The traditional bomb loading, fusing, and storage facility could be replaced by the “fuel” required to source the DEW. Last, and maybe most important, DEWs can be nonlethal in some applications.

Lasers will be the first to become operational on our strategic attack platforms. Significant progress has already been made in the airborne laser (ABL) program, underway since 1992. The program gives the U.S. military a credible boost-phase defense against theater ballistic missiles. This laser is slated to be flight-tested in 2002 and fielded in 2006. Each laser shot is estimated to cost only \$1,000 in “laser fuel,” which is a mixture of common chemicals.⁵³ Cost-effectiveness is further enhanced by a single mission being able to deliver multiple shots prior to mission completion. Recent success in using high density polyethylene (HDPE) plastic in the chemical oxygen iodine laser (COIL) can save on material cost by a factor of 100 and on machining cost by a factor of three—all without degrading laser performance. Because it is nine times lighter than the metals normally used in constructing lasers, HDPE is an ideal choice for an airborne COIL platform.⁵⁴ Through techniques like these, we can make lasers small and light enough to become modular weapons systems on our strike platforms. Limitations of lasers include being fair-weather weapons and requiring dwell times in the range of seconds; however, RF weapons can be used to compensate for these weaknesses.

The RF weapon showing the most promise is the high power microwave (HPM). It is not limited by weather and requires less than a second of dwell time on a target. The HPM’s effect on electronic devices ranges from disruption to destruction, depending on the target’s electromagnetic susceptibility and the HPM parameters. Energy from an HPM weapon can couple into system electronics through front door or back door paths at frequencies that may be either in-band or out-of-band. This means that electronics can be burned out even when the system is turned off.⁵⁵ In general, the susceptibility of electronics to an HPM increases as the scale size of the electronics decreases, making the most modern electronic systems potentially the most vulnerable.⁵⁶

High power microwave weapons also provide great flexibility in their lethality by having “dial-a-frequency” options. In most cases, the HPM could be targeted against electronic systems and be tuned to a frequency that would pass harmlessly through humans. On the other hand, if the situation required, the HPM

could be used against enemy personnel. It could be set at a low power to cause sufficient pain to stop enemy personnel, or “turned up” to actually burn troops to death.⁵⁷

Both laser and HPM weapons have the added benefit of providing our platforms organic self-protection capability. Just as the ABL can engage theater ballistic missiles, our strike platforms could use their organic DEW weapons to destroy attacking missiles. The laser would require a direct hit, while the HPM weapon could be less accurate and still have the same positive results. The HPM approach also has the potential of being a “force shield” for the strike platform if engaged by multiple threats simultaneously.⁵⁸ The major disadvantage of HPM is the danger of fratricide, since US systems rely so heavily on electronics. Safeguards and procedures must be integrated in the weapon system to prevent this hazard.

Energetic particle beams offer the most potent form of DEW, since their penetrating power is robust against the most stringent hardening measures.⁵⁹ As an analogy, using lasers and HPMs is like shooting BBs at a target while the particle beam is like firing baseballs. Unfortunately, the atmosphere significantly degrades the particle beam’s propagation over long ranges and limits its usefulness on earth. Since similar atmospheric propagation problems do not exist in space, and MEMS developments will shrink the size of these weapons appreciably, it is likely that energetic particle beams can be used to conduct strategic attacks against enemy LOVs in space.

Strategic Platforms

Strategic attack platforms will involve UAVs, transatmospheric vehicles (TAVs), and space-based systems. UAVs will be prevalent in the future, and many of them will support the strategic attack mission. Their benefits and specifications are detailed in the 2025 UAV white paper. Because the UAV has a slow response time, newer platforms like the TAV and space-based systems are required. TAVs and space-based platforms can satisfy the portion of strategic attack in 2025 that requires immediate and massive firepower to accomplish great shock value.

The 2025 Spacelift and “Through the Looking Glass” white papers provide the specifications of a plausible force application TAV and space-based weapons. However, many of their characteristics are restated in this paper because they directly support the strategic attack mission. The TAV would be capable-- from an alert posture-- of arriving at a target anywhere in the world within one hour of notification. Its

weapons bay would be modular to allow several different types of weapons for increased flexibility. TAVs returning from a mission could be serviced and ready to fly again in less than a day, and could be surged to fly multiple missions per day if necessary.

The TAV platform capitalizes on several principles of war. It is offensive, bringing the fight to the enemy on our terms. The TAV provides surprise, striking enemy targets at any depth with little or no warning. Additionally, it delivers massed effects by employing precise firepower. Just as the F-117 carrying PGMs delivered on the principles of mass and economy of force during the Gulf War, the TAV will take this one step further. This platform accomplishes multiple attacks over a diverse target set during a single mission. Ultimately, with the appropriate weapons load, it can engage targets in separate major regional contingencies during a single mission. (fig. 3-5). In short, the TAV provides a timely threat to strategic targets anywhere on the globe.

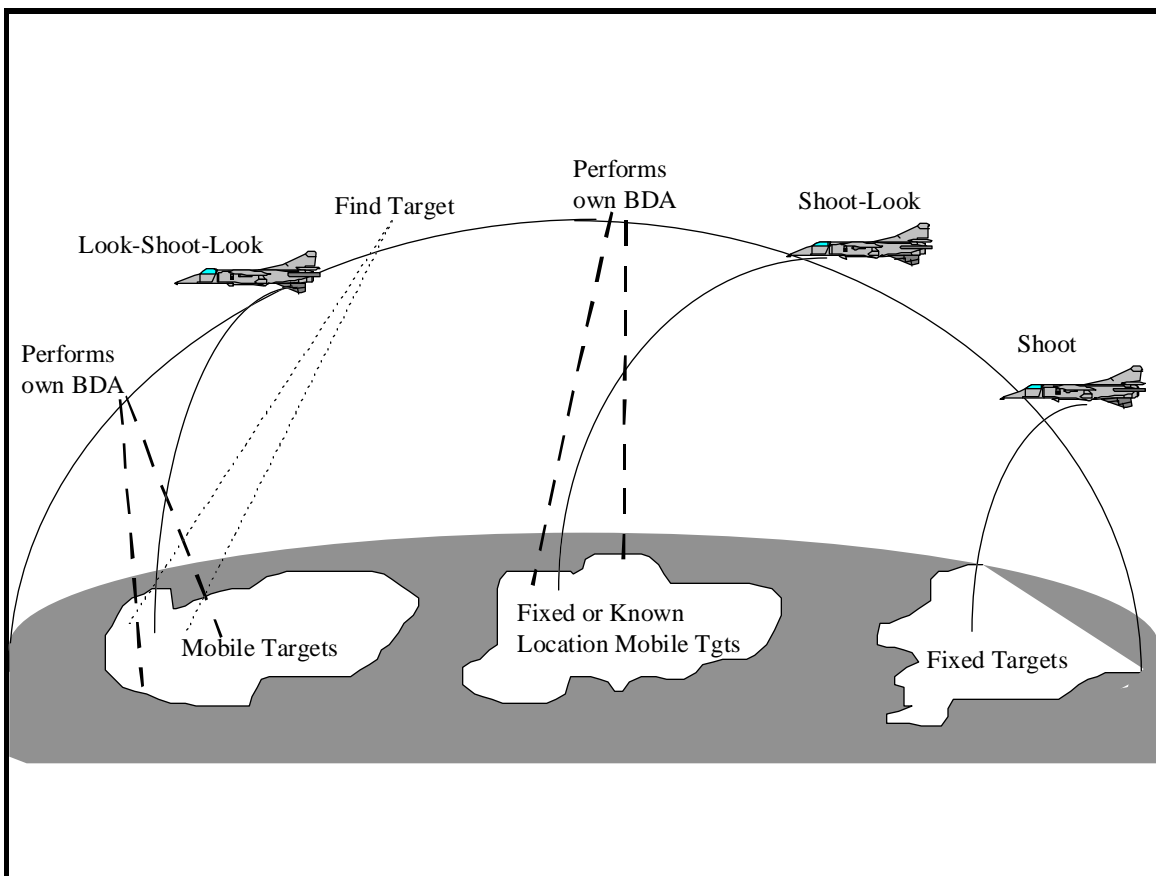

Source: Microsoft Clipart Gallery ©1995 with courtesy from Microsoft Corporation

Figure 3-5. Transatmospheric Vehicle

The vehicle must be designed to incorporate a modular weapons system. This concept increases cost effectiveness by allowing the TAV to be used for a variety of military missions, from force enhancement through force application. These weapon modules are maintained in readiness, stored until needed, and then quickly loaded on the vehicle. Finally, better sustainability can result from quick reloads and rapid turn-times, The TAV will provide quick reaction time across the globe; however, some cases will require more immediate strategic attack.

Utilizing a space-based platform is a powerful strategic attack option because it truly provides an “anytime. . .anywhere” engagement capability. Two generic deployment strategies exist. The first is an autonomous weapon deployed in space along with beam directing optics and control systems. This approach creates significant problems due to space logistics, resupply, targeting, and control. Additionally, it raises political issues related to the placement of offensive power in space. These technological difficulties and political issues make a second deployment option more attractive.⁶⁰

Constructing a DEW on the ground and deploying targeting mirrors in space is the more feasible option. Having the source of energy on the ground means that laser energy will not be limited by satellite power or by available fuel. The large targeting mirrors, built with lightweight structures, could employ wave front compensation to correct for optical imperfections.⁶¹ These spaced-based mirrors provide the capability to immediately apply lethal and nonlethal DEWs on a strategic LOV.

Feedback Systems

The last ingredient of the organic strategic attack process is feedback. Feedback provides the Delphi database with a near-instant awareness of an LOV’s status. It answers the question as to the outcome of the strategic attack: Did the mission achieve success, failure, somewhere in between, or overkill? Knowing how much or how little an LOV was affected allows the system analysis network to generate subsequent courses of action.

Traditionally, feedback in the strategic attack process has been called battle damage assessment (BDA). In 2025, strategic attack may not involve “battle” with an enemy to inflict “damage” to its personnel and

equipment. Nonetheless, the “assessment” part of BDA remains a constant requirement for efficient and effective strategic attack.

The platform and sensor capabilities required for feedback in strategic attack are the same as those discussed in the target acquisition phase. This further illustrates the organic nature of the strategic attack process as a whole. The visual sensors placed on space and airborne platforms can provide continuous multispectral images of LOVs. However the importance of visual sensors may decrease in 2025 as the strategic attack process relies more on nonlethal methods of attack. In this case, non-traditional sensors that can hear, smell, or taste become essential by providing important bits of data that allow the Delphi system to piece together the effectiveness of an attack.

Notes

¹ **2025** Concept, no. 900374, “Living World-Wide Intelligence Data Basing,” **2025** concepts database (Maxwell AFB, Ala.: Air War College/**2025**, 1996).

² Joseph W. Wilkinson, *Accounting Information Systems: Essential Concepts and Applications*, 2nd ed. (New York: John Wiley & Sons, 1993), 219-221.

³ USAF Scientific Advisory Board, *New World Vistas: Air and Space Power for the 21st Century*, summary volume (Washington, D.C.: USAF Scientific Advisory Board, 15 December 1995), 87.

⁴ Ibid.

⁵ John W. Griesser, “Experts Among Us,” *Business Horizons* 35, no. 3 (May-June 1992): 77-80.

⁶ J.J. Daniels and E.L. Rissland., “A Case-Based Approach to Intelligent Information Retrieval,” 1995. On-line Internet, 3 January 1996, available from <http://cbr-www.cs.umass.edu/abstracts.html#Daniels:CBR-Approach-to-IR>.

⁷ Peter J. Denning, “Neural Networks,” *American Scientist* 86, no. 4, (July-August 1992): 426-429.

⁸ **2025** Concept, no. 900446, “Automated Enemy Analysis Software,” **2025** concepts database (Maxwell AFB, Ala.: Air War College/**2025**, 1996).

⁹ Bart Kosco, *Fuzzy Thinking, The New Science of Fuzzy Logic*, (New York: Hyperion, 1993), 156-223.

¹⁰ *New World Vistas*, summary volume, C1-C15. The study suggests that the best approach for using software agents in this fashion is to have the agent generate specific data/task requests, rather than have it remotely travel the distributed database.

¹¹ Charles S. Taber, “POLI: An Expert System of U.S. Foreign Policy Belief Systems,” *American Political Science Review* 86, no. 4 (December 1992): 888-904.

¹² Daniels and Rissland.

¹³ Denning, 426-429.

¹⁴ Randall J. Calistri-Yeh, “Applying Blackboard Techniques to Real-Time Signal Processing and Multimedia Network Management,” *Proceedings of the 7th International Conference on Industrial and Engineering Applications of Artificial Intelligence and Expert Systems*, June 1994 (Austin, Tex.: IEA/AIE), 593-599.

- ¹⁵ **2025** Concept, no. 900397, "Multi-Concurrent Operations CPU," **2025** concepts database (Maxwell AFB, Ala.: Air War College/**2025**, 1996).
- ¹⁶ **2025** Concept, no. 900791, "Quantum Mechanical Computer," **2025** concepts database (Maxwell AFB, Ala.: Air War College/**2025**, 1996).
- ¹⁷ George Gilder, *Microcosm*, (New York: Simon & Schuster, 1989), 319-330.
- ¹⁸ *New World Vistas*, summary volume, 90.
- ¹⁹ Oscar Firschein, "Defense Applications of Image Understanding," *IEEE Expert*, October 1995, 11-17..
- ²⁰ *New World Vistas*, summary volume, 22.
- ²¹ *Ibid.*, 21.
- ²² *Ibid.*
- ²³ *Ibid.*, 22
- ²⁴ *Ibid.*
- ²⁵ Gary Stix, "Micron Machinations," *Scientific American*, November 1992, 107.
- ²⁶ Naomasa Nakajima, "Micromachines," *The Futurist*, January 1994, 50.
- ²⁷ **2025** Concept, no. 900288, "Swarms of Micro-Machines," **2025** concepts database (Maxwell AFB, Ala.: Air War College/**2025**, 1996).
- ²⁸ "Leveraging the Infosphere: Surveillance and Reconnaissance in 2020," *Airpower Journal* 2, vol. 9 no. 2 (Summer 1995): 14.
- ²⁹ *Ibid.*, 12.
- ³⁰ *New World Vistas*, summary volume, 21.
- ³¹ **2025** Concept, no. 900215, "Weather Data Collection/Display," **2025** concepts database (Maxwell AFB, Ala.: Air War College/**2025**, 1996).
- ³² "Leveraging the Infosphere: Surveillance and Reconnaissance in 2020," 15.
- ³³ USAF Scientific Advisory Board, *New World Vistas: Air and Space Power for the 21st Century* (unpublished draft, the sensors volume, 15 December 1995), vi.
- ³⁴ William B. Scott, "LIDAR System to Detect Biological Warfare Agents," *Aviation Week & Space Technology*, vol. 143, no. 2 (13 November 1995): 44.
- ³⁵ Michael Black, "Technology's Brightest Stars," *R&D Magazine: The International Magazine of Research and Development* (October 1993), 58.
- ³⁶ "Leveraging the Infosphere: Surveillance and Reconnaissance in 2020," 12.
- ³⁷ David E. Newland, "Acoustic Micromachines," *Nature*, vol. 370, no. 6484 (7 July 1994): 21.
- ³⁸ "Three DOE Devices Will Assist in Weapons Dismantlement," *R&D Magazine: The International Magazine of Research and Development* (September 1995), 36.
- ³⁹ "Leveraging the Infosphere: Surveillance and Reconnaissance in 2020," 17.
- ⁴⁰ Barbara Smith, "Technology Takes the Pinch Out of 'Going Green'," *R&D Magazine: The International Magazine of Research and Development* (September 1995), 45.
- ⁴¹ *New World Vistas*, (unpublished draft, the sensors volume), 164.
- ⁴² Clive Cookson, "The Rise of the Robot Nose," *World Press Review*, vol. 42, no. 9 (September 1995): 36.
- ⁴³ Otis Port, "A Nasal Network to Sniff Out Friend or Foe," *Business Week: Industrial/Technology Edition*, no. 3454 (11 December 1995): 115.
- ⁴⁴ *New World Vistas*, (unpublished draft, the sensors volume), 164.
- ⁴⁵ "Leveraging the Infosphere: Surveillance and Reconnaissance in 2020," 18.
- ⁴⁶ **2025** Concept, no. 900469, "Hitchhiking Sensors," **2025** concepts database (Maxwell AFB, Ala.: Air War College/**2025**, 1996).

⁴⁷ *New World Vistas*, summary volume, 7. The importance of this quote is as a point of contrast for the expanded engagement capabilities that attack platforms will need in 2025.

⁴⁸ Maj John Geis, et al., “Alternate Futures,” briefing (Air War College, Maxwell AFB, Ala.: 13 February 1995).

⁴⁹ *New World Vistas*, summary volume, 9.

⁵⁰ Lt Col Ted O. Mundelein, “Miniaturized Munition Technology Demonstration,” (Unpublished paper, Eglin AFB, Fla.: January 1996).

⁵¹ Terry Neighbor, “Wright Laboratory 2025 Technologies Air Power Day,” 2025 Lecture (Air War College, Maxwell AFB, Ala.), 13 November 1995.

⁵² John T. Tatum, “A New Threat to Aircraft Survivability: Radio Frequency Directed Energy Weapons,” *Aircraft Survivability*, Fall 1995, 11.

⁵³ Steve Watkins, “Service Closes in on an Airborne Laser,” *Air Force Times*, 21 August 1995, 25.

⁵⁴ Phillips Laboratory Computational Services Division, “Plastic Fabrication of Chemical Oxygen Iodine Laser (COIL) Devices,” Phillips Laboratory, on-line, Internet, 25 March 1996, available from <http://www.plk.af.mil/SUCCESS/coil.html>.

⁵⁵ Dr William L. Baker, “Air Force High-Powered Microwave Technology Program,” *Aircraft Survivability*, Fall 1995, 9.

⁵⁶ *Ibid.*, 9.

⁵⁷ Col William G. Heckathorn, “Advanced Weapons and Survivability Directorate Vision,” 2025 Lecture, Air War College, Maxwell AFB, Ala.: 4 Dec 1995.

⁵⁸ Baker, 9.

⁵⁹ Dr Louis C. Marquet, “Aircraft Survivability and Directed Energy Weapons,” *Aircraft Survivability*, Fall 1995, 7.

⁶⁰ *New World Vistas*, summary volume, 47–48.

⁶¹ *Ibid.*, 47.

Chapter 4

Concept of Operations

The goal of strategic attack in 2025 is to conduct operations “to a point where the enemy no longer retains the ability or will to wage war or carry out aggressive activity.”¹ Those operations run the gamut from traditional, highly destructive, force-on-force encounters to much less invasive, but very effective computer-based warfare. In 2025, advances in technology will improve the ability of the US to bring air and space power to bear on an adversary to achieve such war-winning effects. A description of the 2025 strategic attack system follows, based upon the technologies and organization outlined in the body of this paper. This system has four organically-linked components: a system analysis system, a target acquisition system, a target engagement system, and a feedback system.

Data from all over the world, in virtually every form, is monitored by the system analysis system. This collection of databases, called the Delphi system, is managed by advanced AI technology. As world developments occur, the AI portion of the system determines which databases contain useful facts. The data originates from various military, commercial, and institutional sources. The Delphi system analyzes this data and determines solutions to the strategic problem in terms of what LOV to target and how to affect it. It feeds that information to human decision makers and the target acquisition system.

The target acquisition system in figure 4-1 uses sophisticated visual imaging and acoustical sensors to collect data from airborne platforms. It also employs ground-based microsensors to gather additional facts. It updates the Delphi database by providing LOV characteristics, such as location and composition, and makes this information available to the target engagement system.

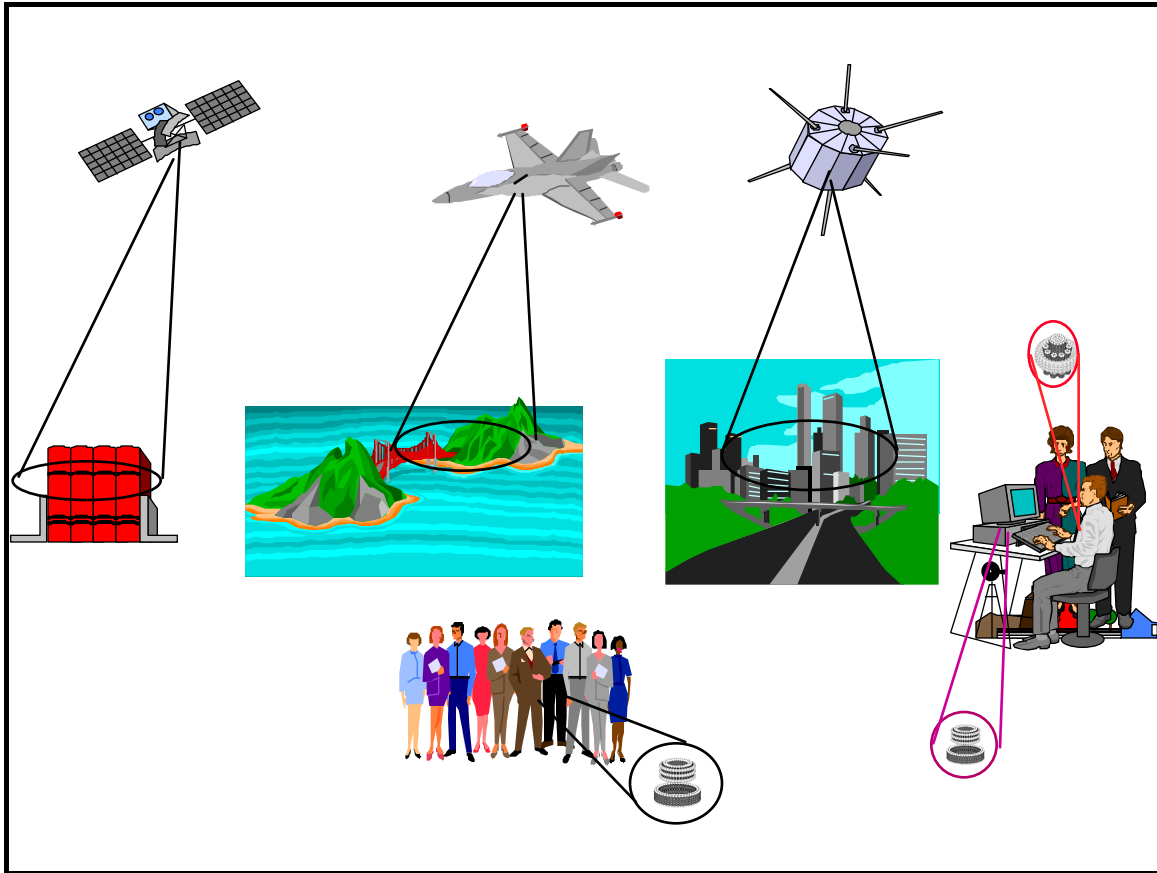

Source: Microsoft Clipart Gallery ©1995 with courtesy from Microsoft Corporation

Figure 4-1. Notional Target Acquisition System

Once national authorities decide to implement the recommendations provided by the Delphi system, the target engagement system depicted in figure 4-2 is employed. The engagement system encompasses a broad range of tools to conduct psychological operations, perform computer-based attacks, deliver powerful conventional weapons from TAVs and UAVs, and utilize DEWs from space. This paper concentrated on attacking physical LOVs; however, as mentioned earlier, strategic effects can come from many approaches. This physical attack focus is intended to complement other **2025** white papers that detail innovative approaches for affecting less tangible LOVs.

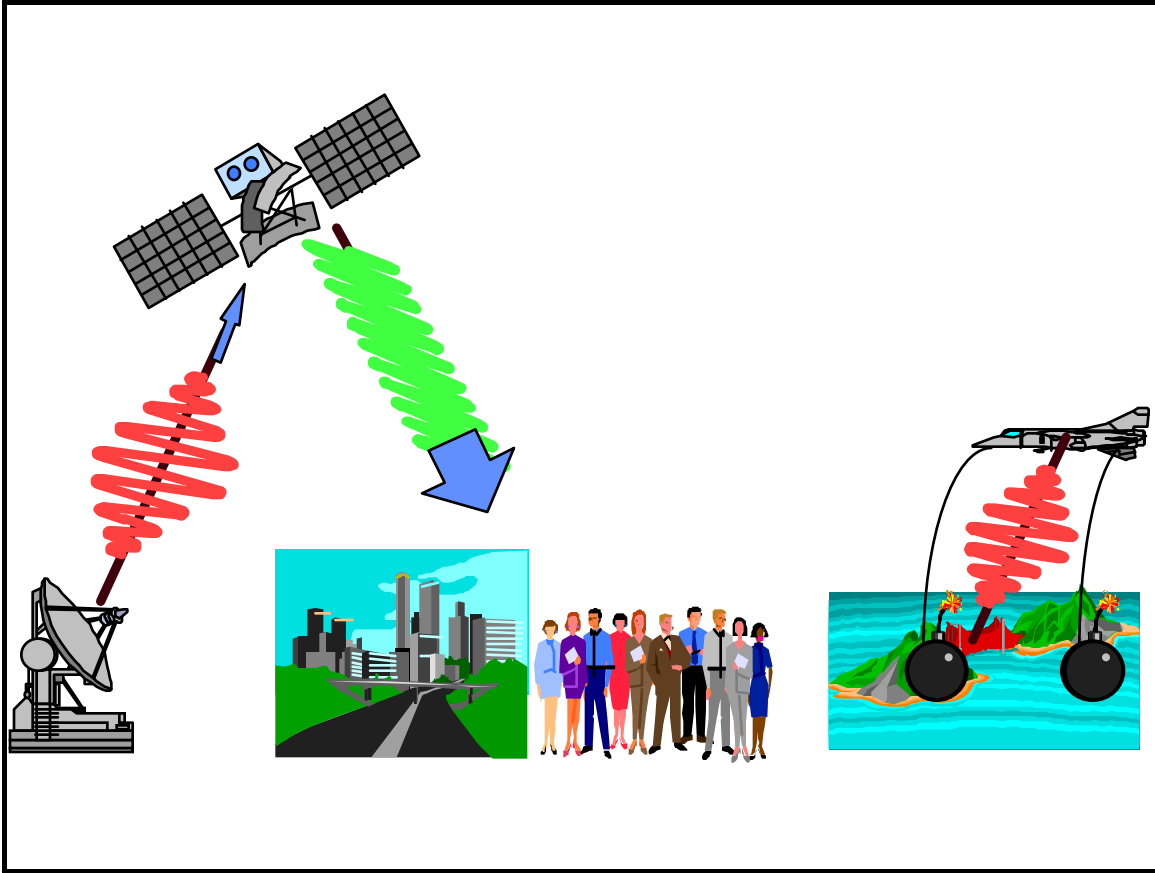

Source: Microsoft Clipart Gallery ©1995 with courtesy from Microsoft Corporation

Figure 4-2. Notional Target Engagement System

The targeting system queries the Delphi database for the information necessary for engagement. The database delivers this product after updating relevant information by communicating with the sensor arrays feeding the acquisition system. Based on the desired effect the targeting system selects the proper platform and weapon for the LOV. During and after the attack, the acquisition system monitors the target and reports its status to the Delphi system. Delphi uses its AI component to determine the degree of target engagement effectiveness. Delphi then reports that information to national leaders, along with the next recommended course of action. The outcome is a series of precise attacks with effects across the depth and breadth of an adversary. Figure 4-3 depicts the total strategic attack system.

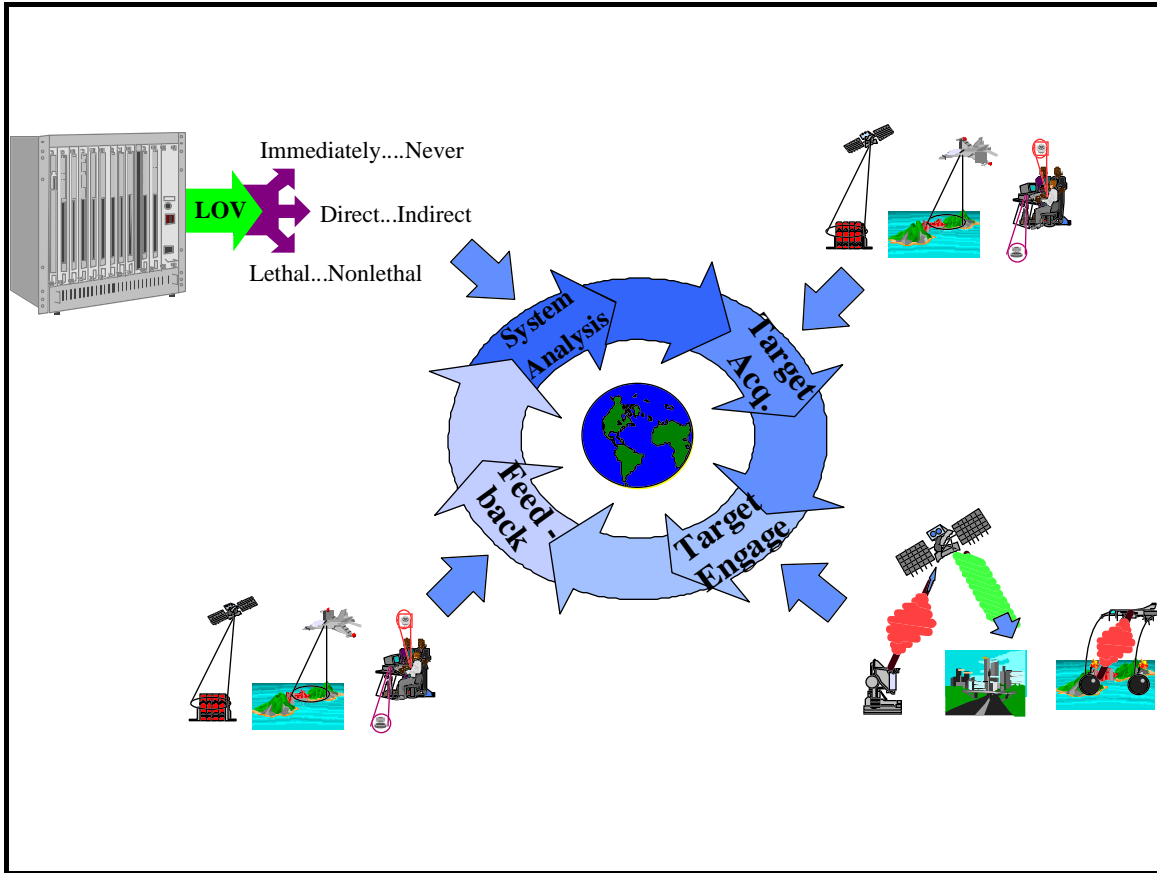

Source: Microsoft Clipart Gallery ©1995 with courtesy from Microsoft Corporation

Figure 4-3. Strategic Attack in 2025

Notes

¹ Department of the Air Force, *Air Force Doctrine Document 1, Air Force Basic Doctrine* (draft) (Langley AFB, Va.: USAF Doctrine Center, 15 August 1995), 13.

Chapter 5

Investigative Recommendations

Examination of the required capabilities for a strategic attack system in 2025 revealed several high pay-off technologies. Chief among the critical requirements are computing ability, artificial intelligence, nanotechnology, directed energy weapons, and transatmospheric vehicles.

At the foundation of the strategic attack system lies the continued improvement in computational and data storage ability. These two required capabilities are found throughout the organically-connected subsystems of strategic attack. While critical, these technologies should not be the focus of military research and development efforts. The rapid, global growth of information-based societies recognize this as a lucrative area for private investment. Scarce DOD dollars should be spent elsewhere.

Sophisticated AI advances are necessary. AI applications and a branch of AI, intelligent software agents, are critical keys to building a Delphi system that provides decision makers with the information to make optimal decisions in 2025. The military will not be alone in its quest to advance AI; many segments of the commercial sector also plan to use it. Improved profit opportunities motivate industries to invest in this area. The task of military leaders and long-range planners is to determine what unique military applications exist in the field, and then selectively fund them.

Selective funding is also required to exploit the budding science of nanotechnology. This technology forms the baseline for some sensors and weapons that the strategic attack system requires. Microsensors used for tagging potential targets, or scattered to monitor specific areas, rely heavily upon nanotechnology. Further, this capability creates smaller weapons for use on UAVs or TAVs.

Another potentially high return area of technology concerns directed energy weapons. DEWs offer a flexible, timely, affordable means to affect an adversary's LOV. They can be "tuned" for a wide range of

effects, from low-order intervention to high-order destruction. Additionally, the low cost of DEWs makes them cost effective. Finally, the speed, ubiquity, and aura of power associated with DEWs provide significant flexibility in execution and have a profound deterrent value.

The TAV is yet another important enabling technology. The TAV retains the flexibility and on-the-fly innovation of manned vehicles. Further, the TAV's inherent speed allows for rapid engagement time. Finally, CONUS-based TAVs shrink the logistical tail, reduce security exposure, and create virtual global presence. The DOD should develop the TAV concurrently with the private spacelift industry.

Chapter 6

Conclusions

Strategic attack has always held a position of importance in the conduct of warfare. Done correctly, strategic attack shortens the fighting and reduces the costs. All warriors dream of conducting it with decisive effect, yet few have been successful. The difficulty usually centers on determining, locating, or engaging the correct LOV. This white paper identifies the most promising technologies and combines them to form an organic system for conducting strategic attack in 2025. Embracing these concepts provides a “hit’em where it hurts” capability to successfully prosecute strategic attack.

Bibliography

- Baker, William L. "Air Force High-Powered Microwave Program." *Aircraft Survivability*, Fall 1995, 9.
- Black, Michael. "Technology's Brightest Stars." *R&D Magazine: The International Magazine of Research and Development*, October 1993, 58.
- Calistri-Yeh, Randall J. "Applying Blackboard Techniques to Real-Time Signal Processing and Multimedia Network Management." *Proceedings of the 7th International Conference on Industrial and Engineering Applications of Artificial Intelligence and Expert Systems*, June 1994, 593-599.
- Clausewitz, Carl von. *On War*. ed. and trans. Michael Howard and Peter Paret. Princeton, N.J.: Princeton University Press, 1976.
- Cookson, Clive. "The Rise of the Robot Nose." *World Press Review*, vol. 42 no. 9 (September 1995): 36.
- Daniels, J.J. and Rissland, E.L. "A Case-Based Approach to Intelligent Information Retrieval." on-line, Internet, 3 January 1996, available from <http://cbr-www.cs.umass.edu/abstracts.html#Daniels:CBR-Approach-to-IR>.
- Denning, Peter J. "Neural Networks." *American Scientist*, vol. 86 no. 4 (July-August 1992): 426-429.
- Department of the Air Force. *Air Force Doctrine Document 1, Air Force Basic Doctrine* (draft). Langley AFB, Va.: USAF Doctrine Center, 15 August 1995.
- Firschein, Oscar. "Defense Applications of Image Understanding." *IEEE Expert*, October 1995, 11-17.
- Gilder, George. *Microcosm*. New York: Simon and Schuster, 1989.
- Griesser, John W. "Experts Among US." *Business Horizons*, vol. 35 no. 3 (May-June 1992): 77-80.
- Grinter, Lawrence E. and Schneider, Barry R. *Battlefield of the Future*. Maxwell AFB, Ala.: Air University Press, 1995.
- Kosco, Bart. *Fuzzy Thinking, The New Science of Fuzzy Logic*. New York: Hyperion, 1993.
- "Leveraging the Infosphere: Surveillance and Reconnaissance in 2020." *Airpower Journal* 2, vol. 9 no. 2 (Summer 1995): 10-25.
- Marqet, Louis C. "Aircraft Survivability and Directed Energy Weapons." *Aircraft Survivability*, Fall 1995, 7.
- McKittrick, Jeffrey, James Blackwell, Fred Littlepage, George Krans, Richard Blanchfield, and Dale Hill. "The Revolution in Military Affairs" in *Battlefield of the Future* edited by Barry R. Schneider and Lawrence E. Grinter. Maxwell AFB, Ala.: Air University Press, 1995.
- Meilinger, Colonel Phillip. *10 Propositions Regarding Air Power*. Air Force History and Meums Program, 1995.
- Mundellein, Ted O. *Miniaturized Munition Technology Demonstration*. Eglin AFB, Fla.: January 1996.
- Nakajima, Naomasa. "Micromachines." *The Futurist*, January 1994, 50.
- Newland, David E. "Acoustic Micromachines." *Nature*, vol. 370 no. 6484 (7 July 1994): 21-28.
- Port, Otis "A Nasal Network to Sniff Out Friend or Foe." *Business Week: Industrial/Technology Edition*, vol. 3454 (11 December 1995): 115.

- Scott, William B. "LIDAR System to Detect Biological Warfare Agents." *Aviation Week & Space Technology*, vol. 143, no. 2 (13 November 1995): 44.
- Smith, Barbara. "Technology Takes the Pinch Out of 'Going Green'." *R&D Magazine: The International Magazine of Research and Development*, September 1995, 45.
- Stix, Gary. "Micron Machinations." *Scientific American*, November 1992.
- Szafrański, Colonel Richard. "Parallel War and Hyperwar: Is Every Want a Weakness," in *Battlefield of the Future* edited by Barry R. Schneider and Lawrence E. Grinter. Maxwell AFB, Ala.: Air University Press, 1995.
- Tabor, Charles S. "POLI: An Expert System of US Foreign Policy Belief Systems." *American Political Science Review*, vol. 86, no. 4, (December 1992): 888-904.
- Tatum, John T. "A New Threat to Aircraft Survivability: Radio Frequency Directed Energy Weapons." *Aircraft Survivability*, Fall 1995.
- Toffler, Alvin and Heidi. *War and Anti-War*. New York: Little, Brown and Co., 1993.
- 2025 Concepts Database. Maxwell AFB, Ala.: Air War College/2025, 1996.
- "Three DOE Devices Will Assist in Weapons Dismantlement." *R&D Magazine: The International Magazine of Research and Development*, September 1995, 36.
- USAF Scientific Advisory Board. *New World Vistas: Air and Space Power for the 21st Century*, Summary Volume. Washington, D.C.: USAF Scientific Advisory Board, 15 December 1995.
- . *New World Vistas: Air and Space Power for the 21st Century*, Sensors Volume. Washington, D.C.: USAF Scientific Advisory Board, 15 December 1995.
- Watkins, Steve. "Service Closes in on an Airborne Laser." *Air Force Times*, 21 August 1995, 7.
- Wilkinson, Joseph W. *Accounting Information Systems: Essential Concepts and Applications*. 2nd ed. New York: John Wiley & Sons, 1993.

Close Air Support (CAS) in 2025 “Computer, Lead’s in Hot”



A Research Paper
Presented To

Air Force *2025*

by

CDR Ronald J. Unterreiner (USN)
Maj Jeffrey A. Brelsford
Maj Richard J. Findlay (USMC)
Maj John F. Hunnell
Maj Michael F. Wagner

August 1996

Disclaimer

2025 is a study designed to comply with a directive from the chief of staff of the Air Force to examine the concepts, capabilities, and technologies the United States will require to remain the dominant air and space force in the future. Presented on 17 June 1996, this report was produced in the Department of Defense school environment of academic freedom and in the interest of advancing concepts related to national defense. The views expressed in this report are those of the authors and do not reflect the official policy or position of the United States Air Force, Department of Defense, or the United States government.

This report contains fictional representations of future situations/scenarios. Any similarities to real people or events, other than those specifically cited, are unintentional and are for purposes of illustration only.

This publication has been reviewed by security and policy review authorities, is unclassified, and is cleared for public release.

Contents

<i>Chapter</i>		<i>Page</i>
	Disclaimer	ii
	Illustrations.....	iv
	Tables.....	iv
	Preface.....	v
	Executive Summary	vi
1	Introduction	1
2	Current and Required Capabilities.....	3
	Close Air Support Description	3
	Close Air Support Issues	4
3	System Description	6
	Background and Assumptions	7
	Target Detection	8
	Target Identification (Combat Identification).....	13
	Target Tracking.....	16
	Command, Control, Communications, Computers, and Information	17
	Battlenet System.....	18
	Kill-Mechanism Carriage	20
	Kill-Mechanism Engagement	23
4	Concept of Operations	32
	Employment	32
	Communications, Logistics, and Personnel Requirements	33
	Countermeasures.....	34
	Joint, Coalition, or Non-Combatant Operations.....	37
5	Investigative Recommendations	38
<i>Appendix</i>		<i>Page</i>
A	Close Air Support Definitions.....	42
B	Close Air Support Description.....	46
C	CAS Fundamentals	48
	Bibliography.....	51

Illustrations

<i>Figure</i>	<i>Page</i>
1-1. Close Air Support Task Loop.....	2
3-1. Target Detection Tasking in CAS Loop.....	8
3-2. BiStatic Target Detection	11
3-3. C ⁴ I Network.....	19
3-4. Flexible Munition Production Pallet and Subsystem.....	28
3-5. FM Multiple Uses.....	29
4-1. Battlernet.....	33

Tables

<i>Table</i>	<i>Page</i>
1 Recommended Research Areas	38

Preface

The Chief of Staff of the Air Force, Gen Ronald R. Fogleman, directed Air University to conduct a major study on air and space power and concepts applicable to the year 2025 and beyond. This will include examination of innovative systems, new concepts of operations, and the emerging technologies enabling them. The study formally commenced in August 1995 when the students arrived for the Air University 1995-1996 academic year and will conclude in June 1996 with delivery of the final report to the Chief of Staff of the Air Force. The final report will be a logically ordered collection of white papers developed from the innovative concepts and technology abstracts submitted.

Executive Summary

The mission of close air support (CAS) currently exists in every service doctrine and will continue to be required in 2025. Advances in technology will reduce the many shortfalls currently causing concern regarding the CAS mission. In 2025, time-critical applications of airpower and space power in support of troops on the ground will be vastly simplified from the perspective of both the tasker and the attacker. This paper describes the requisite systems and technology needed for aircraft to perform the mission. It does not discuss organizational issues.

Advances in ground-based firepower are expected to proceed at a pace commensurate with technical advances in airpower --perhaps reducing the dependency of ground forces on air support, depending on the coalition elements' technical base. The ability for ground forces to overwhelmingly engage an opponent will always be a goal of the ground commander, and commanders will always plan engagements to optimize usage of their available power. Unforeseen opportunity is frequently a product of warfare. Maintaining the flexibility of tactical forces ensures exploitation of good fortune and rapid response to good fortune's evil twin— bad luck. Regardless of doctrinal issues about the best way to employ airpower, there will always be opportunity to influence the ground battle directly from the air with air-to-ground weapons. The most likely first priority of airpower in future conflicts will be to attain air and space superiority, either concurrently with or immediately following the shock delivered by the initial strategic attack. Attaining air superiority allows a fluid reapportionment of air and space assets. Single-mission tactical aircraft are luxuries not likely to be affordable, given today's evolving fiscal realities. The ability of available air-to-air assets to swing to ground attack will maximize the application of power.

In the year 2025, the inevitable evolution of precision weapons will make every air asset that is capable of ground attack capable of performing CAS. The automated assignment of the ground target coupled with ease of employment and standoff capability will profoundly simplify weapon delivery tactics and defensive system requirements. The addition of onboard and in-flight programming capabilities greatly enhances mission effectiveness. Relative proximity of the target to allied ground troops poised for attack could be the

only discriminator of mission demarcation between CAS, battlefield air interdiction, or even strategic attack. Pre-mission planning and weaponeering time will be slashed. The resultant rapid apportionment flexibility will revolutionize the application of airpower.

Chapter 1

Introduction

Opportunities to make quantum leaps in warfare are rare, but they are upon us today. Due to demonstrated and anticipated advances in technology, the ability to project a survivable weapons delivery platform into heavily defended airspace over a target is rapidly diminishing. The use of standardized standoff weapon systems significantly improves delivery platform survivability. Current and forecast growth in the capabilities of standoff weapons are inadequate to maximize their potential. From the outset, the weapons must be considered as only a part of an airpower system. This white paper discusses the many elements of such a system. It is critical that this entire system be defined as early as possible to allow for concurrent procurement programs for its constituent parts.

In the interest of bounding the problem, only air deliveries of air-to-ground mechanisms near friendly forces are considered here. As the name infers, close air support is the use of airpower in proximity to friendly ground troops to complement their scheme of maneuver. It is apparent that many of the technologies discussed in this paper have surface-to-surface applications. Military objectives and available assets drive the need for target engagement by air firepower in addition to ground-based firepower. The technological evolution in outlying years does not diminish the need for the unique aspects of airpower and space power in the battlefield-- and the deep strikes-- of the future.

Close air support functions as a series of tasks and systems to accomplish the mission. Figure 1-1 shows the sequence of the four attack tasks. These elements are common to many different missions as they are defined today. It is obvious in the development of the recommendations contained in this paper that these systems capabilities may render some mission paradigms obsolescent. The resultant method for applying airpower produces a seamless transition across those paradigms. For academic completeness, there is a

discussion of CAS and its current definitions and methods. It is important to note that CAS is just one of the many ground-attack missions. It is useful to review the following discussions of current capabilities and limitations in this context.

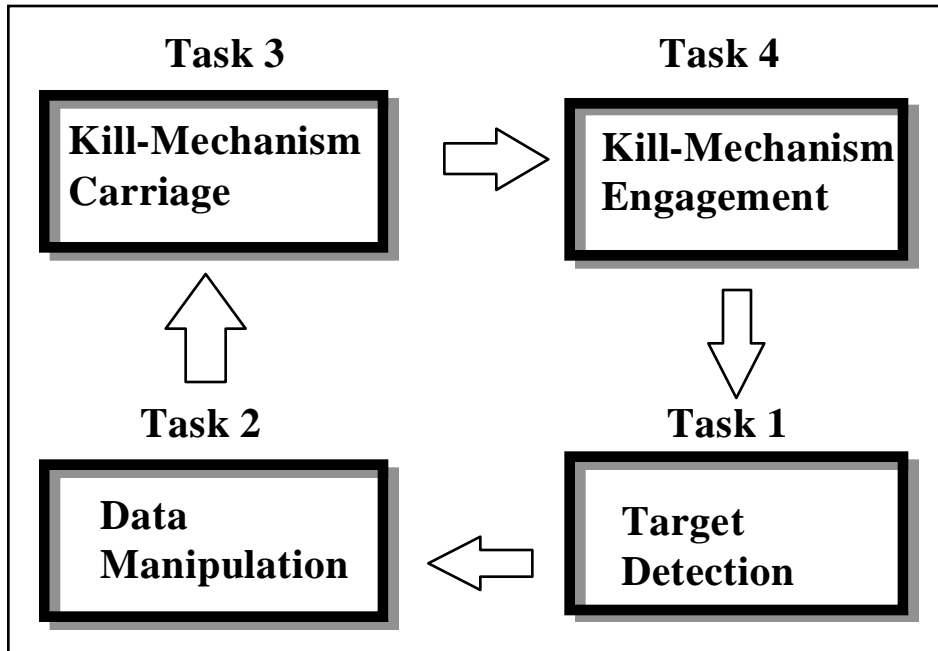

Figure 1-1. Close Air Support Task Loop

Targeting, command, control, communications, computer, and information (C⁴I) data, kill mechanism carriage, and engagement are the four tasks associated with CAS. Targeting refers to detection, identification, and tracking. C⁴I permits prioritizing and directing our air assets while disseminating needed information to all levels of command. Currently, manned aircraft comprise our kill mechanism carriage. In the future air assets other than manned platforms will comprise the majority of delivery vehicles used in CAS. Kill mechanism engagement refers to weapon assignment, desired effects, initialization, release, acquisition, onboard processing, tracking, and fusing of the payload.

Chapter 2

Current and Required Capabilities

All services define CAS similarly. Appendix A presents the independent service definition and its source. They all stress that CAS is air action against hostile targets in close proximity to friendly forces. To varying degrees they stress that it needs to be timely and, flexible, and that it requires detailed integration with the fire, movement, and location of friendly ground forces. The proximity of friendly forces to targets makes fratricide a real concern. CAS accomplishment requires close integration with ground forces to aid their scheme of maneuver. It is important to realize that CAS is *not* independent air action against the enemy where there are no friendly forces. Missions flown in Bosnia during 1995, for example, should not be classified as CAS.

Close Air Support Description

Today's close air support mission requires a one-on-one relationship between the delivery platform aircraft and the ground tactical representative to employ weapons in close proximity to friendly forces. To produce this relationship in a timely and, efficient manner requires a complex command and control network. Appendix B has a more in-depth discussion of the current means for conducting CAS. CAS planners and operators must have a thorough understanding of joint and service operating procedures. In addition, they must understand service communication requirements, delivery platform capabilities, and weapon effects. Significant limitations to CAS effectiveness (e.g. target identification, the threat of fratricide, and the operating environment) prevent full exploitation of the capabilities offered by airpower on the battlefield. Appendix C describes these limitations more fully.

Close Air Support Issues

The CAS debate will be entering its 80th year in 2025. The Army and the Air Force disagree over several issues about how to conduct CAS. Mission allocation priorities, target tactics, timeliness, night and weather capabilities-- all constrain CAS effectiveness. Proposed service-specific solutions are the source of this rift. The Army feels that Air Force allocation and acquisition priorities neglect CAS in favor of air superiority, interdiction, and strategic strike.¹ However, the realities of 2025's battlefield will force an accommodation between the two sides. The Army will acknowledge that CAS aircraft cannot loiter inside the enemy's antiaircraft envelope and expect to survive. The lethality of 2025 antiaircraft weapons will place greater demands on aircraft operating around enemy troops. After action reports on Desert Storm showed that CAS aircraft (A-10s and AV-8Bs) suffered the highest number of combat losses.² Uninhabited aerial vehicles (UAVs) can currently loiter over a battlefield to provide reconnaissance data to collection agencies. These vehicles are readily adaptable for ground attack missions, especially when a significant antiaircraft threat exists. This fulfills the Army's need for ubiquitous airpower presence.

Army doctrine demands high tempo 24-hour-a-day, all-weather operations. Current CAS shortfalls in poor weather and night conditions capability make Army planners reluctant to plan operations where Air Force firepower integration is essential to mission success. Consequently, the Army has often excluded CAS from their scheme of maneuver. These environmental limitations to CAS will be overcome by 2025, thus making CAS more dependable.

Currently the Army is concerned that "immediate response" CAS is not responsive enough to the Army field commander and his scheme of maneuver.³ The Army desires on-call, near instantaneous assets, even if that means holding back those assets from accomplishing multiple missions. The Air Force wants to take full advantage of the high sortie rate of combat aircraft and not hold back assets on the chance they might be needed.

Several improvements by 2025 will serve to mitigate CAS shortfalls. Weapons will be more versatile; the same weapon will be able to reconfigure to fragment for soft targets or penetrate for hard targets. Consequently, mission tasking will be less restricted by aircraft weapons load. Weapons will have greater ranges and stand-off capability. All surface-attacking aircraft will be capable of precision weapons delivery

in weather or at night and will therefore be CAS-capable. Ground commanders and aircrews will have access to the information from a common network that will electronically model the battlefield. The next chapter describes that network.

Notes

¹Raoul Archambault and Thomas M. Dean, *Ending the Close Air Support Controversy*, Newport, R I (21 June 1991), 8-11.

²John T. Correl, ed., "More Data From Desert Storm," *Air Force Magazine* 79, no. 1 (January 1996): 62-66.

³Archambault, 14.

Chapter 3

System Description

In 2025, a ground force element nominates targets via the battlenet without regard to how they will be attacked. The ground force elements is concerned with effect and criticality. The battlenet is a system of systems that collects data from multiple sources, fuses the data, turns data into information, and continuously updates battlespace situational awareness for all users. Furthermore, it provides a comprehensive communications network for the commanders involved in combat to synergistically direct the fight as well as a means for the war fighters to execute and report.

As the battle unfolds, enemy units confronting the ground commander cause direct conflict with the planned scheme of maneuver. Other units not yet on the scene may also threaten the plan. The commander will have a display (a miniature 3D model) of the battlespace (provided by the battlenet). The commander may customize the battlenet display to present only relevant information and forces. Via this battlenet, the ground commander designates targets for destruction, containment, or immobilization, and the timing of such effects. Artificial intelligence (AI) imbedded in the battlenet, as programmed by cognizant authority, will inventory available friendly forces and task weapons systems to engage the enemy within microseconds. The battlenet component onboard a manned platform receives the tasking, acknowledges the assignment, adds the targets to a customized display of the battlespace, and recommends a course of action to the operator. If no friendly system is available at the required time, the battlenet presents various options to the ground commander. It may suggest changing the timing of the attack, the desired effect, retasking another assigned unit, or relaying a request for additional force to the next higher commander on the battlenet. Higher levels of command may hold forces in reserve to answer these requests. Human oversight is available at all levels to provide a robust backup system and to ensure that artificial intelligence and scheme of maneuver remain in

concert. The battlenet will be used by all levels of command and operations, from the commander in chief (CINC) monitoring the theater campaign down to the engaged tank commander. The tank commander uses the battlenet to request additional targets or for assistance in disposing with the present batch.

The nominator of the target may not be physically in the area of operations. In fact, the tasking order may direct CAS not by sortie but by weapon and vulnerability time over a region. This, combined with all-weather weapons, will make CAS constantly available to the battlespace commander. An aircraft on an interdiction mission may be tasked by the battlenet to deliver some of its weapons in a CAS scenario, requiring the platform to ingress over a certain area at a specified time to expend the selected weapons enroute to the interdiction target. Weapons or sorties could be shifted to other missions by the battlenet when it determined that the weapons were no longer needed for CAS. In fact, any aircraft transiting near a ground unit could be tasked by the battlenet for any or all of its weapons to aid in an engagement. The battlenet provides a means for shifting aircraft to higher priority targets at any time. This would be normal, and would be a part of routine training. Human operators coupled with battlenet logic decide whether the new target has high enough priority to warrant diverting or delaying a platform.

Background and Assumptions

In the world of 2025, the Air Force operates at considerable distance from the United States over periods ranging from weeks to months.¹ High-tempo operations will be conducted around the clock, unaffected by weather conditions. With the formation of new nations and changes in the world order, the United States will not know when or where the next conflict may appear, who will be fighting, or whether they are recognized government forces, nongovernmental organizations, or insurgent groups.² Technological advances in all fields will provide a vast array of improvements in materials, computing power, sensors, and weapons. One downside to these technological improvements is that they will be available to almost everyone interested in obtaining them. It is reasonable to assume that today's emphasis on reduced costs, reduced collateral damage, and short-duration involvement will continue in the future. A CAS system in the future (fig. 3-1) must be able to cover large distances and be able to loiter well away from the target area, yet be able to penetrate a highly defended threat zone consisting of surface-to-air missiles, directed energy

weapons, stealthy aircraft, and attack from space.³ In addition, the system must be able to support operations in environments from thick jungle to urban areas against all types of adversaries, ranging from heavily armored, fast-moving shock forces to crowds in the heart of a major city. Two issues central to CAS-- proximity to friendly forces and the rapid delivery of weapons-- will not change. Forces will still need to “close” with each other to achieve a tactical decision. Closing with each other is obviously a relative term, since weapons of the future may have tactical ranges well beyond those of today. The effectiveness of future weapons requires rapid response from our systems to prevent high casualty rates.

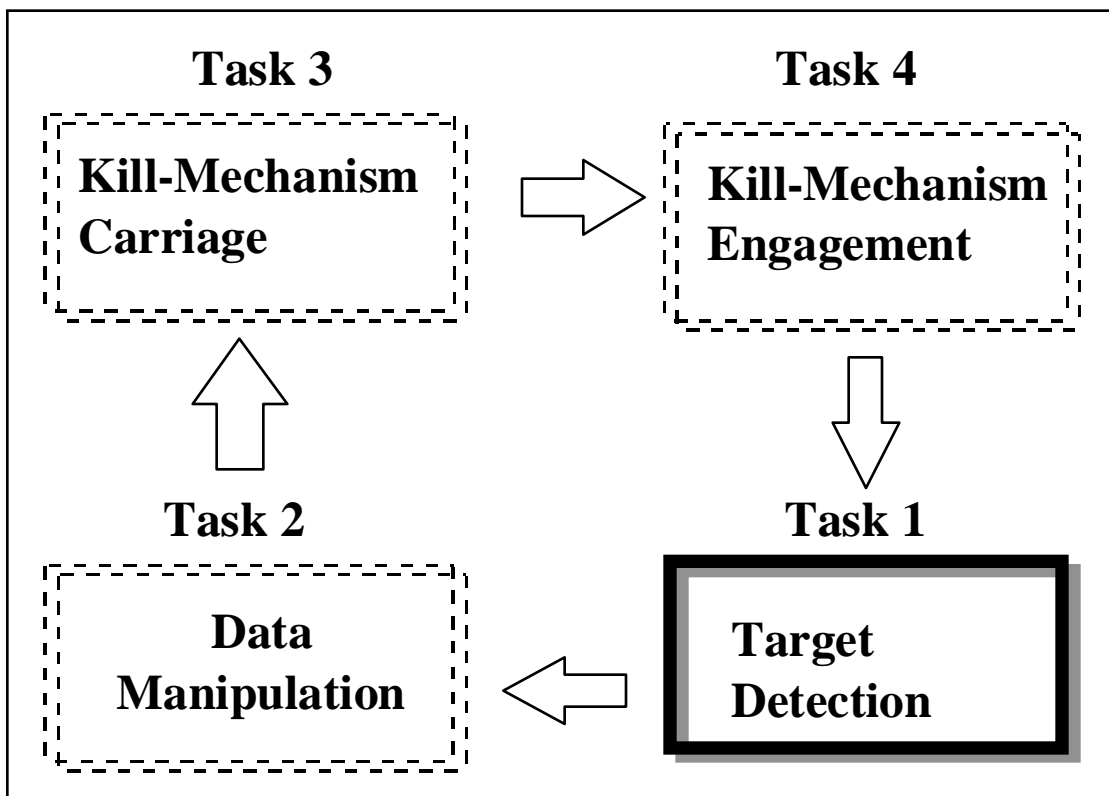

Figure 3-1. Target Detection Tasking in CAS Loop

Target Detection

A major limitation of CAS today is the requirement for the forward deployed spotters to visually sight enemy vehicles or troops before bringing in air support. “Because smaller units will be capable of massing decisive effects on future battlefields, there will be a greater need in the 21st century for our forces to

become less detectable to the enemy” and, conversely, to make the enemy far less opaque to us.⁴ Human observers on the battlefield become less and less effective as forces become smaller, more maneuverable, and lethal. Current intelligence outputs give the ground commander the general location of an enemy force, but not in near-real-time and not with great accuracy, especially if the targets are in motion. Battlespace commanders in the future must have near-real-time enemy dispositions, movements, and intent if at all possible. Our commanders must have continuous knowledge of the presence of individual vehicles prior to their arrival in the battlespace commanders’ area of influence until they are in close contact with friendly forces. Uninterrupted coverage of target vehicles and personnel in all types of weather, on any terrain, or in an urban environment, should be the minimum level of performance in 2025. Force XXI’s concept of operations dovetails with this philosophy and states that our required capabilities hinge on leveraging information-linked technologies, particularly sensor fusion, robotics, fuzzy logic guidance, and control.⁵ Following a preliminary operational analysis on CAS as a system, the following criteria were identified as the most important in target detection and tracking:

1. target location accuracy; less than 10 meters preferred
2. environmental availability; detection 24 hours a day in all weather and terrain
3. target location update; situation dependent 0 to 6 hours⁶

In order to satisfy these and other requirements the United States must develop new sensor technology. One candidate system utilizes space platforms as the primary means of surveillance. However, a system based entirely on satellites poses some formidable problems. Orbital distances create signal attenuation, loiter time, area coverage, and power supply problems for satellites. Elements of the radar equation exact great concessions from a space-based system in terms of power requirements, signal-to-noise, and resolution.⁷ Very large structures will be required to generate the power required by these systems, a fact which negates the desired design feasibility, cost savings, hardness, and maneuverability desired from orbital platforms. “The next generation of American spy satellites should be able to provide virtually continuous 24-hour coverage of a battlefield anywhere in the world. Even further into the future, they may be able to distinguish friend from foe by ‘licking’ the battlefield with a laser so that commanders can follow the movements of their own forces as well those of the enemy.”⁸ This type of system could be expensive, and commanders would likely use these satellites for higher priority missions.

Upgrading existing airborne platforms such as joint surveillance target attack radar system (JSTARS) and the airborne warning and control system (AWACS) will provide some improved capabilities over the next 10 to 15 years. However, the relatively small area coverage, operational inefficiencies, high operating costs, vulnerability, and limited number of these aircraft will severely hamper their operations and reduce their usefulness. The uninhabited reconnaissance aerial vehicle (URAV) proposed in *New World Vistas* appears to be a cost-effective solution when employed either as an independent system or in conjunction with other airborne and spaceborne platforms. URAVs can be outfitted with a wide variety of multispectral sensing equipment-- such as synthetic aperture radar (SAR), light detection and ranging (LIDAR), optical viewers, or laser radar-- and then deployed to loiter at very high altitudes for extended periods without refueling. Already a current electro-optical system suitable for installation on a fighter-sized platform produces “tactically significant imagery” up to 60 miles away from the target.⁹ URAVs working in conjunction with manned platforms and satellites could easily provide continuous and detailed coverage of the area of interest.

URAVs can work cooperatively with satellite constellations by projecting high-power radio frequency (RF) beams over the area of interest. The satellites receive reflected signals from targets near [on] the earth to form a distributed bistatic synthetic aperture radar system (fig. 3-2). Clutter rejection is improved because of the varying reflection angles to different satellites. Moving and fixed targets can be detected with high resolution as the result of the long baseline between satellites. This arrangement limits the number of expensive spaceborne transmitters by reducing coverage to a specific area of interest.¹⁰

This mixture of satellites and URAVs produces resolutions under 10 meters and continuous coverage over a given area of interest. Drawbacks to this system are the complexity and susceptibility of URAVs to attack or malfunction, the requirement to have multiple aircraft on call, and the possibility of leaving an area unmonitored.

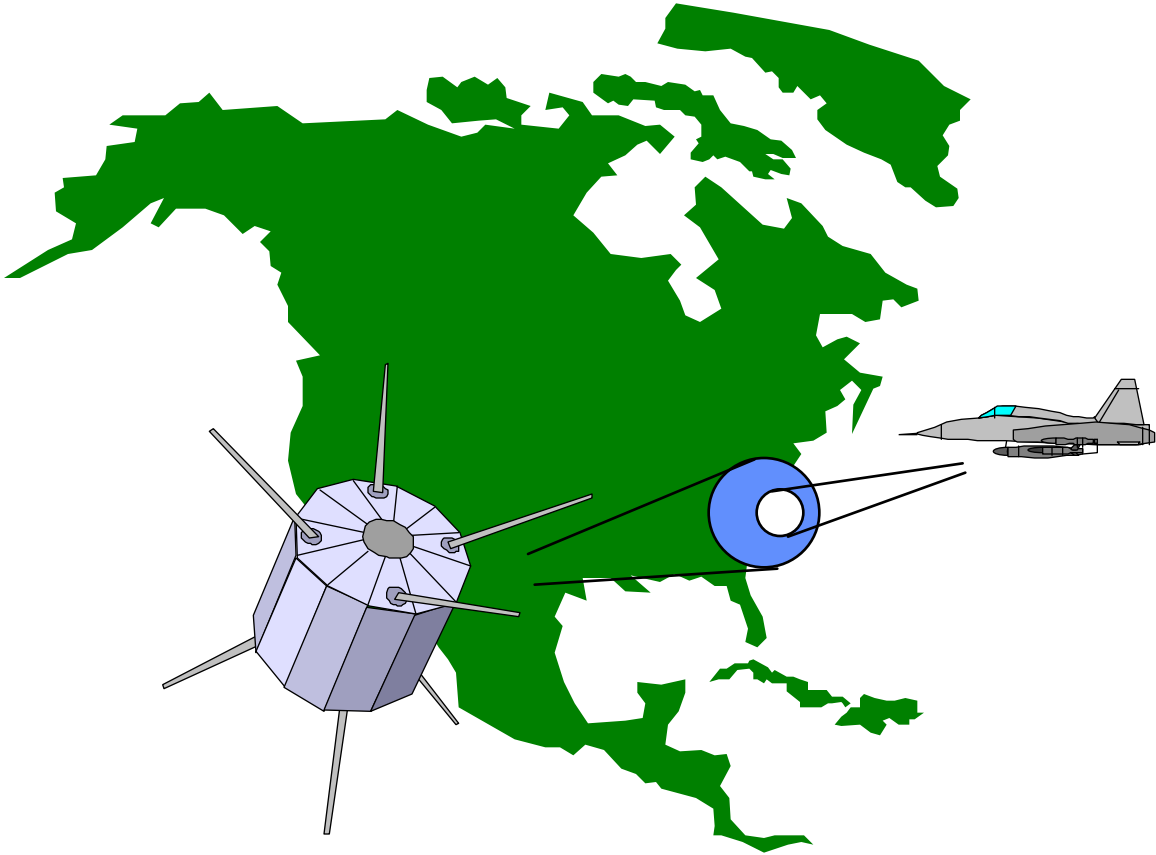

Figure 3-2. BiStatic Target Detection

Remote sensing in synchronization with or in the absence of airborne or space platforms utilizes surface arrays of small camouflaged disposable sensors capable of transmitting data to collection platforms.¹¹ Sensors can exploit the full electromagnetic spectrum, detect forms of mechanical energy such as seismic or acoustic signals, and physically analyze diverse sets of chemical and biological components.¹² Artillery, missiles, or airborne platforms dispense the remote sensors, automatically recording their locations. Signature data transmitted by the sensors to the battlenet become identified targets with speeds and vectors. Active detection devices such as directed-energy transmitters may alert the targets of the presence of sensors, therefore the commander must have the option of passive sensing if targeting effectiveness is adequate.

We must develop a network of ground-based sensors, high-altitude unmanned platforms, and surveillance satellites as recommended by the *New World Vistas* study.¹³ The battlenet must then provide this intelligence to all levels of command with continuous updates including near-real-time battle damage assessments.

Concept of Operations. Locating and tracking a fast-moving vehicle made of lightweight nonmetallic materials powered by a quiet, cool engine may be very difficult. This problem is made even more difficult if the vehicle has radar/IR low-observable technology and onboard countermeasures capable of deceiving radar or laser tracking systems. According to the Army, vehicles on the future battlefields will have these characteristics.¹⁴

Satellites with multispectral sensor suites will locate enemy forces well before their probable contact with friendly units. A battlenet collects data from multiple sources, such as signals, imagery, emissions intelligence, and remote sensor inputs, then fuses the data and continuously updates the battlespace picture. Cycle time between updates depends on the orbit or the number of satellites in the net. Air-breathing UAVs supplement intelligence collection by providing updates to enemy movement over a wide area or focusing on a particularly difficult tracking problem. The battlenet that is providing information to the commander decides when to increase the frequency of observations and adjusts orbital flyovers or activates air-breathing platforms as required to maintain accurate target locations. When commanders, at any level, need more detailed information, they direct the battlenet to provide it and the battlenet chooses the method. A robust system depends on multispectral sensing from each sensing platform in order to accommodate different target types and ambient conditions. As friendly and enemy forces close on each other, cycle time for system updates shrinks to zero, requiring a continuous flow of data into the battlenet. Potentially large target densities found in armored battles or urban crowd control operations dictate that the battlenet be able to discriminate individual vehicles or personnel from among larger target sets. UAVs supplement battlespace coverage at this point, and the battlenet controls their actions. The sensor suite on manned vehicles automatically selects the proper sensor or combination of sensors to compensate for target type, terrain, light, and weather, and then displays the image via a pilot's helmet-mounted cueing system while passing the information to the battlenet. In an autonomous mode the system could find targets, identify them, and then launch weapons without human intervention.

A detection system must be capable of thwarting countermeasures created by target systems. Visual spoofing, such as holographic displays, would fail to pass a multispectral imaging process as they would not create thermal, magnetic, electromagnetic, or acoustic returns.¹⁵ False thermal sources also fail to pass through multispectral gates and discriminators. Artificial intelligence (AI) queries the system to find if target

motion or activity matches known behavior and checks for countermeasure activity. Adaptive learning by the battlenet compensates for new countermeasures fielded by an enemy by adapting the sensor suite without human intervention.

Target Identification (Combat Identification)

Future weapons systems must possess the capability to operate cooperatively with non-US forces in stand-off engagements using smart weapons while preventing collateral damage from friendly fire.¹⁶ The United States will continue to be a major exporter of weapons to other countries; therefore it is reasonable to expect future enemies to come equipped with equipment similar to our own. automatic target recognition (ATR) technology must progress to the point where accuracy, reliability, and unambiguous target recognition allow application of lethal force with nearly 100 percent assurance of target identification.¹⁷

The primary characteristics required of a combat identification (CID) system are accuracy, reliability, and security. The desired system must exhibit close to 100 percent accuracy, reliability under all operating conditions, and security in order to prevent the enemy from mimicking or denying us the identification capability. As a corollary to accuracy, the CID system must be robust enough to utilize any identification systems of civilian police forces, coalition members, or allied nations. Allied forces may present problems to our systems since equipment may not be standardized or even fielded by the respective nations. Coalitions, by their ad hoc nature, present several complications (e.g., language barriers, dissimilar equipment, and limited time) to us in distributing our system for use during rapidly developing scenarios.

For this discussion, CID systems fall into two main categories: active-cooperative and passive. An active-cooperative system requires a transponder affixed to the vehicle or person to transmit a response to an interrogation; much like the battlefield combat identification system (BCIS) currently undergoing testing by the Army. The BCIS actively queries and responds to similarly equipped vehicles in all weather conditions with up to 99 percent accuracy.¹⁸ In the future, responses to interrogation should be multispectral; utilizing acoustics, IR, visual bands, RF, millimeter wave, and laser beams. Active systems have several problems associated with them. One is reliability. Unless the system is 100 percent reliable possibilities, exist for fratricide in combat. Antennas and other external devices (the BCIS uses an externally mounted transponder)

may be blown off during combat, rendering the system useless. Another problem is security. If an enemy can read, jam, or duplicate the incoming or outgoing signals, the system's effectiveness becomes severely degraded. If the signals are not of a low probability of intercept (LPI) nature an enemy is likely to be able to localize emission sources and target them. It is also reasonable to expect that some of our systems will fall into enemy hands, therefore our system must be reprogrammable. A different type of active system does not require interrogations but periodically transmits required information such as identity and status in the blind. This information "strobing" would have to be spectrally unique to prevent detection, but could simplify the overall system and allow one half of the ID equation to remain passive.

Semipassive systems do not utilize transponders or transmitters to reply to interrogations. Instead an interrogator reads the identity from a tag or label of some type on the vehicle of person. For example:

Spacecast 2020 suggested using techniques that it likens to 'licking' and 'tasting' to identify objects on the ground. The licking would be done by a laser beam fired from a satellite which would be equipped with sensors that would 'taste' the spectrum of the radiation reflected back from the target. By comparing this with a database of know tastes it would be possible to identify an object. Friendly tanks and aircraft could be coated with a chemical that produces a characteristic spectrum when excited by energy of a certain frequency or other characteristic.¹⁹

A totally passive system requires the use of naturally occurring emanations such as acoustic, thermal, or RF energy from a target. Another type of system scans for characteristic signals reflected from offboard illumination of the target (visual light, distortion of magnetic fields, or bistatic imaging systems). Computerized pattern recognition is a current and evolving technology.

In all likelihood, in order to achieve near 100 percent accuracy, the CID system of 2025 needs the capability to both actively and passively discriminate enemy from friendly and combatant from non combatant.

Concept of Operations. In 2025, friendly troops enter the battlespace with their personal identifiers.²⁰ The identification mechanisms could be in the form of microchips worn by or imbedded in the soldiers and chemical implants injected into the body or grown externally.²¹ Microchips must be capable of transmitting a response to interrogations in an active mode. In a passive mode, the presence of a chip containing the correct code detected by a sensor acknowledges identification. Chemical or defense nuclear agency (DNA) sniffers detect the desired chemical in a soldier or the existence of a particular organic material grown on the

soldier's body. The same principle could be applied to vehicles. A molecular patch of material imbedded in the vehicle provides a passive method of ascertaining its identity. A variety of multispectral transponders provide active recognition to battlenet queries. Enemy troops and vehicles may be identified by default. If the battlenet knows the locations of every friendly troop or vehicle and can identify noncombatants, then anything else detected is declared hostile unless designated by the battlespace commander.

Sensors locating objects in the battlespace have the ability to identify the object if directed by the battlenet. One type of system utilizes pattern recognition logic to pick out pieces of data coming from sensors and comparing the data to previously stored signatures to identify enemy troop formations and even individual vehicles. If information needed by the system is not available, the system directs other platforms or sensor types to reconnoiter the area in question.²² An active or passive system could identify friendlies by reading a label attached to an object via numerous methods. As the battlenet sensors detect each target in the battlespace, they apply a physical label to the target. For example, a particle beam imprints coded information on the exterior of specially painted vehicles or irradiates the clothing of exposed personnel. Labels placed on targets could be magnetic, optical, or electronic, and can be sized down to the molecular level. The label contains data that includes the type of target, date time group, and military unit controlling the vehicle or person.

The system must be robust enough to utilize the identification systems of allied forces during coalition operations. Sensors would be required to interrogate an unknown transponder, analyze the response, and determine if the response came from a friendly system or a designated hostile system. If the interrogator receives a response that does not correspond to known friendly systems or fails to receive a response at all, the interrogator activates a separate series of identification methods involving discriminators such as material composition, acoustic, electromagnetic, or vibration signatures. For situations involving a mixture of hostile forces and noncombatants in an environment where no external evidence distinguishes the two (a riot or urban disturbance for example), the system may need only distinguish between friendly "tagged" personnel and others. Current electro-optical sensors can discriminate individuals for positive identification at ranges up to three miles; by 2025, it is reasonable to postulate ranges an order of magnitude farther away.²³ Pattern recognition logic could assist in threat determination, based on discriminators such as

vehicle type, color, and motion, or note whether personnel are carrying weapons, moving in a tactical manner, etc.

The battlenet fuses information from a wide variety of sources to bring the confidence factor of the target identity to near 100 percent. The battlenet transmits its confidence factor with the target identity to commanders, thus providing them with crucial engagement data.

Target Tracking

Target tracking is handled as a category, separate from detection. A complete CAS system must be capable of not only finding and identifying objects in the battle space but keeping track of them as well. Tracking systems capable of flexible update cycles maintain contact with designated targets throughout extensive maneuvering during close contact with friendly forces. As with detection, robust tracking systems utilize a mixture of space-based platforms, UAVs, and ground sensors to accomplish the mission.

Concept of Operations. Space-based platforms, URUVs, or remote sensors identify an enemy force in the battlespace commander's area of interest. Sensors identify the number and type of targets as well as the status of the force. A designator mechanism physically brands each target by placing a magnetic, laser, or other detectable code on the object. Various identification mechanisms read this tag and update the battlenet with target location. If a hand-off from the original detection platform to subsequent sensors occurs, the follow-on sensors read the target codes and feed current locations and vectors into the battlenet, thus updating the system. Targets not showing up during repeated update cycles cause the battlenet to provide additional scrutiny from search sensors as the system attempts to relocate the objects. Remote ground sensors providing target information to the battlenet may be equipped to read the identification codes already placed on each target, place a designator, or merely pass existent data to the battlenet. Weapon guidance mechanisms would have the capability to acquire and track these specific identity codes. Tactical platforms capable of continuous real-time target tracking interface with the battlenet to maintain the picture; thus, the battlespace commander or anyone requiring immediate target locations may access the information.²⁴ Multiple platforms managed by the battlenet follow selective target tracking, lists to preclude or provide selective redundant

tracking thereby giving the battlenet a capability to resolve conflicts caused by multiple ground observers locating and designating the same target.

Depending on the level of information required, the battlenet provides each user a display of all or a portion of the battlespace to include friendly and enemy locations as well as terrain features, target types, and target status (destroyed, pending destruction, untargeted). Display methods vary from helmet-mounted displays to laptop sized units in the hands of soldiers to large, room-sized units where commanders can move or see anywhere on a “virtual” battlefield.²⁵ For manned aircraft, the pilots’ virtual visor presents the picture outside his cockpit in any direction. The picture includes target location, aircraft parameters, threat locations, weapons status, and friendly locations.

The battlespace commander authorizes the battlenet to service a target in whatever manner desired. Since the battlenet maintains continuously updated target files, the system chooses a method, weapon, and platform. It then launches and, if necessary guides the weapon to the target. Battle damage and resulting target effectiveness are displayed as soon as the battlenet processes the data.

Command, Control, Communications, Computers, and Information

The success of future CAS hinges on effective command and control (task 2 of fig. 3-1). This integrated system must appear seamless to ground units and to the joint aviation targeting process. According to out year projections of doctrinal concepts (*Sea Dragon* and *Force XXI*), United States Marine Corps, (USMC) and United States of America (USA) operational doctrine will diminish the importance of linear forward line of troops and fire support coordination Line concepts by 2025. Both services envision a greatly expanded amorphous and opportunistic battlefield, with small units operating in great breadth and depth supported by indirect fire. It is a battlefield with no front, rear or flank, where detection results in engagement. Multiple sources, ranging from forward-deployed ground forces to battlespace commanders thousands of miles from the battlefield, input indirect fire requests to the battlenet. Target input will be to battlenet by data burst or similar low-signature transmission. Commanders, with significant assistance from the battlenet, conduct target analysis for appropriateness, deconfliction, validity, and availability of aviation assets. When the battlenet receives instructions to engage a target, the battlenet assigns a delivery platform and transmits

necessary information directly into the fire control system. Weapon and navigation programming are automatically accomplished while the platform proceeds to release points. If the situation dictates, the ground commander may direct the weapons platform to contact a ground or airborne controller for “danger close” or degraded deliveries. Partial failures in the battlenet allow graceful degradation to 1995 doctrinal-style CAS. The battlenet also allows multiple levels of interoperability with coalition partners.

Battlenet System

Human input to the battlenet comes from a variety of equipment (fig. 3-3). All sources, whether they are laptop computers or handheld radios, are secure and jam-resistant. Operators gain access to the battlenet after providing identification that the battlenet recognizes. Key cards and code words are simple forms of identification that are easily distributed to operators. Fingerprint recognition or voice matching are more complicated methods of identification that can be used to gain access to the battlenet. Voice-to-data converters provide unprecedented freedom to the operator by allowing direct voice contact with battlenet computers. Built-in redundancy against single point cataclysmic failure permits graceful system-wide degradation and partially shields operators from the effects of enemy attacks. Filtering data and automatic situation updating of the dynamic 2025 battlefield present two major challenges to a battlenet system. Various command levels will have different available information and display presentations are possible. System designers must analyze the vulnerability and requirements. Virtual reality, holographic, and multifunction personal display device efficiency of centralized versus decentralized processing systems.

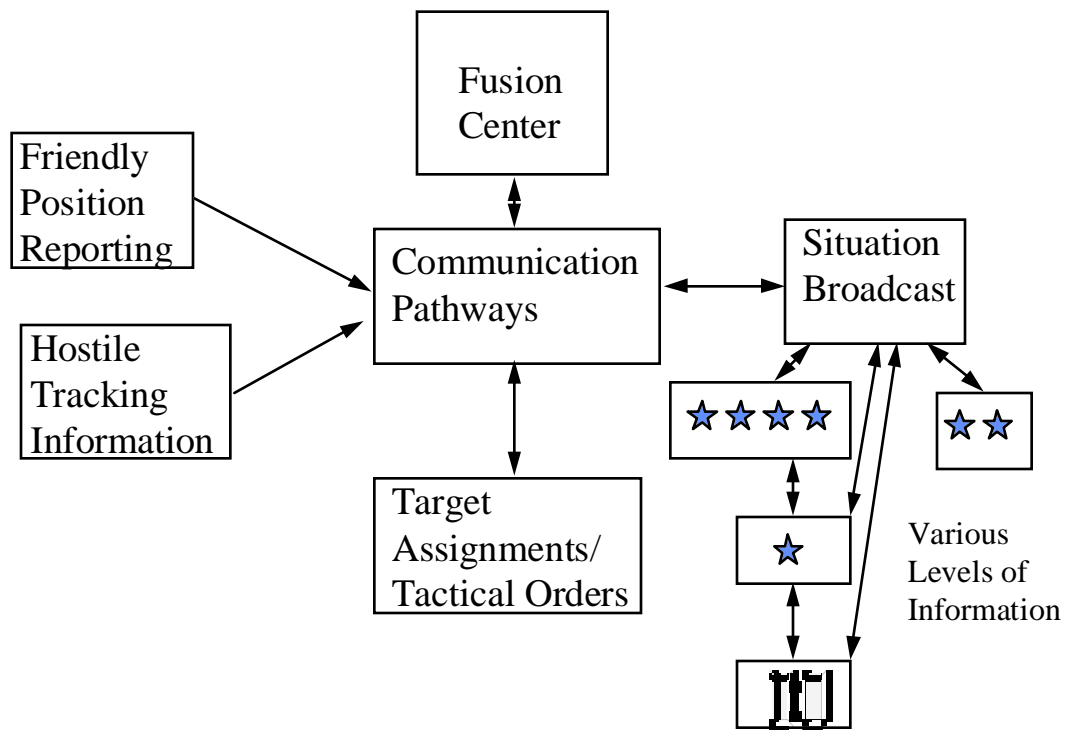

Figure 3-3. C⁴I Network

A horizontal command and coordination network integrating aviation and ground operations ensures quick response to CAS-type missions. The elimination of intermediate decision levels lessens delays caused by administration and processing procedures. The transparent injection of CAS missions into other sorties further enhances CAS timeliness.

Concept of Operations. Input from the sensor network builds a situation map in both digital and visual formats. The battlenet updates friendly, neutral, and enemy locations to the level of detail required to keep pace with their movement through the battlespace. Various levels of command have access to varying degrees of information, dependent on need and security requirements. The battlespace commander engages enemy units as required to accomplish task force missions. As enemy units move (or in a worst case “pop up”) closer to friendly ground units, a variety of sources place CAS requests into the battlenet. The battlenet displays the information to the battlespace commander and a decision to engage follows. All levels of command, from the battlespace commander down to the ground tactical leader, receive a regularly updated

target status from initial detection and engagement to post mission battle damage assessment (BDA). Mission specifics such as location, description, time-on-target (TOT), routing, and target layout are sent to the delivery platform. Computers produce an optimal route to the target, taking into account terrain, threats, and a host of other factors. The battlespace commander possesses the ability to amend the mission until weapons impact. The command hierarchy establishes an authorization priority to preclude conflicting commands. This allows for late changes or mission aborts in case of unforeseen deconfliction problems. A capability to introduce last minute changes to CAS missions, or even weapon trajectories, reduces the potential for air-to-ground fratricide incidents. After weapon impact, the battlenet conducts multisensor BDA to determine mission success and reattack requirements.

Kill-Mechanism Carriage

The “battleplane” of Douhet, a stealthy high-altitude, high-speed bomber that can shoot down incoming missiles, reflect high-energy weapons, rain destruction upon the enemy, and remain affordable probably will not exist. Thirty years is generally insufficient time to procure another new-technology bomber. Current trends in aircraft acquisition time and cost-combined with increased congressional oversight, legal battles, and smaller budgets, virtually guarantee that most of the airframes flying today will still be flying in 2025. Note that the A-6, B-52, C-130, and C-141 flew during Vietnam and are still flying today. Thirty years will elapse from the time the F-15 became operational until its replacement, the F-22, is operational-- assuming no further delays. President Jimmy Carter canceled the B-1 program in favor of a stealth bomber almost 20 years ago. However, a fleet of fully operational B-2 stealth bombers, the block 30s, has not been completely fielded. Lost investment and legal battles over the cancellation of the A-12 program and the Supercollider serve as examples for more oversight. Bureaucratic requirements and approvals result in less risk-taking, which ultimately further slows a lethargic acquisition process. Shrinking defense budgets offer fewer incentives for contractors to champion new products. The consequence to the war fighter is older airframes with more upgrades and improvements. The year 2025 may yet see an F-16 block 80, F-15F, or a B-2 block 40 aircraft. Forecasts show the venerable B-52 to remain in service until 2040.²⁶ Budgetary constraints may find the United States purchasing only manned aircraft that are currently past the demonstration and validation

phase (e.g., the F-22, V-22, and possibly the Joint Strike Fighter). New-technology demonstrator aircraft will also be in existence in the test environment, but not in operational units.

Demands on aircraft systems remaining in the 2025 inventory include greater aircrew situational awareness, augmented countermeasures, better threat identification, greater stand-off range, and improved weapons performance. Improvements in miniaturization and processing power will open new opportunities for communications, information processing, weapons, and UAVs. Future uninhabited combat aerial vehicle's (UCAV), viewed as cheaper alternatives to manned aircraft, are expected to significantly exceed today's capabilities. However, UCAV procurement faces some of the same acquisition challenges that manned aircraft face. Hopefully, the promise of an order of magnitude leap in performance over current manned aircraft with the prospect of affordable costs will spur the development of UCAVs.²⁷

By the year 2025 astro-trackers, terrain matching systems, and improved inertial navigation systems (INSs) will offer relief from the growing dependence on the global positioning system (GPS) yet preserve the navigation accuracy demanded by sophisticated weapon systems. Aircraft navigation computers will store detailed maps of the planet's surface, the location of minute gravity anomalies, and an electronic order of battle. A highly accurate navigation system and a detailed map of the planet provide the means for aircraft to fly nap of the earth passively. Future advances in artificial intelligence and cockpit enhancements permit a significant workload reduction, thus enabling aircrews to devote more time to avoiding the threat and attacking the targets. Greater tactical flexibility will be achieved through better three-dimensional displays of the local combat environment, enemy weapons engagement zones, weapon ranges, and the disposition of forces.

Improved communications and computer capability with a preponderance of smart stand-off weapons give all surface attack aircraft, as well as aircraft not necessarily considered tactical, the capability to conduct close air support. Notable improvements in weapon performance create a mission for essentially an airborne truck. The truck, a UCAV, helicopter, F-22, or B-52, simply hauls weapons to a launch point and initiates a mass attack or an individual weapon launch on demand.

Tactical delivery platforms equipped to carry iron bombs and a gun still have a place in 2025, possibly for no other reason than the fact that these weapons are so numerous, reliable, and cheap. At the high end of the technology spectrum, directed-energy weapons installed on 2025 gunships (progeny of the AC-

130U) offer the possibility of surgical destruction on a variety of targets. As replacement costs for aircraft grow prohibitive, more will be spent on survivability, resulting in an expanding spiral. Ultimately, even strategic bombers need the advantage of being able to shoot back when a venerable but upgraded MiG-21 serendipitously stumbles into a successful intercept.

Many of the same measures used today to evaluate CAS aircraft carry over into 2025. Parameters reflecting superior performance may not be the one's we recognize today. However, aircraft range, speed, weapons capacity, and delivery precision are easily measurable. These characteristics initially answer the question, "Can the aircraft do the job?" Weapon system lethality, aircraft survivability, vulnerability, hardness, and stealthiness form the core characteristics used to address compatibility between aircraft and mission. These measurements, although more important than simple performance factors, are much more difficult to assess quantitatively. Cost, maintainability, and reliability will still be important discriminators, and they will remain under the watchful eyes of the military, Congress, and the media. In the future, aircraft value will be highly leveraged against its capacity to accommodate multiple roles. Single-mission aircraft become a luxury too expensive to be affordable. Flying qualities, critical in the past to aircraft selection, will be less important during initial assessment and selection. Software-driven flight control systems, such as in the F-16, C-17, and B-2, permit operators to rapidly modify aircraft flight characteristics.

Information is the high ground of the twenty-first century.²⁸ Consequently, new critical measures of merit for aircraft will be pilot vehicle interface, human factors, controls, displays, and data fusion. Successful CAS requires fusing data, processing data into information, and timely display of useful information to the aircrew. The absence of quality, easy-to-use controls and displays increases aircrew workload to the point that CAS becomes impossible; the aircraft truly becomes all Mach and no vector. Placing a premium on operational flexibility and lowering aircrew workload during cockpit upgrades results in maximum aircrew effectiveness. Designing from scratch and using automation as an end instead of means are formulas for disappointment-- or at the least, very expensive programs. Aircraft test programs, such as the B-2, have rediscovered that failure to transfer the lessons learned from other aircraft such as the F-16C, F-18, F-15E or F-117, and building automated systems around a rigid, single-focused mission-creates an architecture that is labor-intensive and has little operational flexibility.²⁹ Flexibility is the foundation of CAS and airpower. An aircraft with no flexibility has no utility in accomplishing the CAS mission. By 2025,

fiscal and operational realities will drive the requirement that all strike aircraft, including heavy bombers, be capable of supporting CAS.

Kill-Mechanism Engagement

This section addresses how munitions apply to the 2025 CAS mission(task 4 of fig. 3-1). First, it describes CAS munition characteristics, current weapons, and development trends. Second, it describes future weapon developments and enabling technology required the CAS mission. Finally, this section addresses possible munition countermeasures and counter-countermeasures.

Weapon performance in 2025 will require the same core capabilities as in 1996. Currently, CAS weapons must affect enemy battlefield targets in ways defined as both desirable and advantageous to friendly ground troops. Traditionally, the military limits this association to target destruction. Friendly forces do not always require, or even desire, the complete destruction of an enemy target. This holds true for the entire continuum of targets, from individual soldiers to massed tank formations.

The Viet Cong, for example, found it sometimes beneficial to severely wound or maim US troops rather than kill them outright. Wounding a soldier had the added benefit of degrading his unit's effectiveness by saddling his fellow soldiers with his protection and care until his evacuation. In another example, we can destroy the mission effectiveness of a radar-guided surface-to-air missile (SAM) through electronic jamming of acquisition or tracking elements, as opposed to physical destruction with a bomb. Additionally, jamming may be more cost-effective and less risky than attempting a hard kill. We, therefore, conclude that target characteristics and ground force needs will drive the requirements of CAS weapons in 2025. As previously stated, this does not always equate to target destruction.

Keeping the above discussion in mind, we now address some CAS weapon characteristics that will be required in the next 30 years. First, weapons must produce the desired effect on the target. This characteristic can span the entire range, from vaporizing targets to merely rendering them ineffective for certain periods. Second, CAS weapons of 2025 must have the flexibility to engage several individual types of targets during one mission. Budget constraints no longer allow for the fielding of specific weapons for each type of battlefield target. As a result, we need to develop weapons that have the flexibility to adapt to

changing mission requirements. These changing requirements include an ability to engage a vast array of target types as well as the ability to produce a varied spectrum of effects on those targets. A third characteristic of future CAS munitions will be interoperability between large numbers of delivery vehicle types and different military services or nations. Compact and lightweight construction translates to increased delivery platform performance as measured in range, number of weapons carried, loiter time, maneuverability, and survivability. A final CAS weapon requirement is an ability to lower threat exposure to the carriage platform during the delivery sequence. CAS becomes truly viable only if we can ensure an acceptable risk-to-gain ratio during its execution. Designing stand-off munitions that do not expose delivery vehicles to high-threat environments is one way to increase survivability.

The US military is developing two systems to provide a CAS capability in the future: the joint direct attack munition (JDAM) and the joint standoff weapon (JSOW). JDAM is a low-cost, GPS-aided, inertial guidance kit that is attachable to unguided Mk. 83 (1,000-lb.), Mk. 84 (2,000-lb.), BLU-109, and I-2000 deep penetrating bombs.³⁰ This jointly developed munition attempts to increase the accuracy of weapons types currently in inventory without increasing disproportionately their overall cost. JDAM uses a guided-bomb tail kit to provide GPS updates to a dumb Mk-80-series bomb to increase the bomb's accuracy during the delivery phase of its use. Estimated JDAM accuracy falls in the 10-to-12 meter range, making it an "accurate weapon" but not a precision weapon.³¹ Weapons such as laser-guided bombs are considered to be precision munitions because they produce a very small if not zero circular error probability (CEP). JDAM will be much more cost-effective than true precision munitions against targets that do not demand a zero CEP. JDAM demonstrates an improvement in desired target effects and interservice interoperability over current Mk-80-series munitions. This is the beginning of the trend toward the future weapon characteristics discussed earlier.

JSOW consists of various submunitions carried on a nonpowered, aerodynamically efficient airframe. This frame is constructed of composite and aluminum materials with nonfolding fixed and moveable tail surfaces and folding wings. Submunitions carried include the BLU-97A/B combined-effects submunition, the BLU-108 sensor fused array submunitions, and a preplanned product improvement unitary warhead.³² The weapon's design served to further meet the necessary characteristics of future CAS munitions by addressing the flexibility, desired effect, interoperability, and threat exposure issues.

2025 CAS must be conducted in a cost-effective and survivable manner. Planners and operators must exercise caution before exposing a multimillion-dollar aircraft to a high-threat level for any sort of mission. This threat exposure is necessary in today's environment because the delivery platform/munition combination is not capable of delivering weapons in a manner that shields the delivery platform to a sufficient degree.

There are three approaches to addressing this problem. The first is to develop weapons delivery platforms that are inherently less vulnerable to the fielded threat. An example of this is the current emphasis on stealth technology and self-protection systems. The second is to develop munitions deliverable from outside the lethality ring of the fielded threats. Examples of this are weapons such as the Tomahawk cruise missile and other stand-off munitions. The third approach is a combination of the two.

The three approaches described above cover a wide spectrum of cost, with the first option representing a very high price tag for the delivery vehicle and the second representing a high cost per weapon. There are inherent advantages and disadvantages to both extremes. As the price of the munition or delivery platform increases, the number obtainable with a fixed budget decreases. Senior leaders must wrestle with classic quantity-versus quality decisions. It is important to remember, however, that the combination of weapons delivery platforms and munitions must be of a quality that is sufficient to have a high probability of accomplishing the mission but also of a quantity that is sufficient to be able to take out the volume of anticipated targets. Too few high quality weapons systems are as disadvantageous as an unlimited supply of ineffective low-quality systems. The purpose here is to identify weapon characteristics in 2025 that strike the necessary balance between the quality and quantity extremes.

Keeping the above in mind aids in identifying several key aspects of 2025 munitions. Weapons for 2025 permit the assignment of target and desired effect data to the weapon while onboard the platform or after release. As a result, weapons allow onboard or in-flight reconfiguration of their effect mechanism. To make the weapon truly effective requires flexible guidance options and delivery methods. Developing a fairly high degree of quality and capability into each weapon while maintaining a very high level of to engage a wide array of targets and employment scenarios is extremely important.

Although a high level of capability tends to increase the cost of each weapon, the high degree of flexibility achieved allows the same results with a much lower overall inventory of munitions. This allows additional savings in areas such as logistics, storage, transportation, training, and maintenance. As a result,

these savings can defray increases in the cost of weapons due to their increased sophistication and capability, thereby allowing more weapons to be procured. The end result is an overall decrease in the quantity and types of weapons but an increase in their overall capability and utility. This translates to increased survivability of the delivery platform, thereby reducing the number of delivery platforms required in the force. In essence, a smaller but more capable force structure. The classic example of this reasoning is seen in the combat capability of hundreds of B-17s during World War II (WW II) compared to the effects of just one F-117 carrying two bombs in the Persian Gulf War. These two weapon systems produced similar effects on their targets.

Achieving the anticipated gains in weapon capability requires advancements in computer, guidance, and explosive technology. Weapons used in the 2025 CAS environment must overcome two current limitations of today's weapons. First, they must be dispensed from a platform likely to be well away from the battlespace and not in direct view of the target. Since the delivery vehicle may be anywhere in relation to the friendly and enemy positions, future munitions must be accurate enough and reliable enough to dispense with bomb fall line and aircraft run-in restrictions. Second, they must be able to identify, track, and achieve desired effects on a variety of target types autonomously. Guidance packages and seeker systems permit targeting the weapon or changing targets while onboard the delivery platform, after release, or late in the terminal guidance phase. Battlenet targeting information includes specific target characteristics such as exposed armor aligned linearly north to south in a 50 X 300-meter array and a specific weapon assigned to the target. Each munition provides its own identity to the delivery platform, hence to the battlenet, so that each munition may be independently targeted.

Active or passive seekers will be onboard-selectable. An active seeker illuminates the target by a multispectral source such as radar, laser, or optics. Active illumination of the target by the weapon requires guidance to the target from onboard navigation systems or steering from the battlenet until the weapon reaches acquisition range and begins terminal phase guidance. This guidance could include an on-munition target CID interrogator, or a system able to read the labels installed on enemy vehicles outlined in the previous section. Longer range and endurance CAS weapons require a target recognition system capable of identifying target signatures and characteristics. Passive guidance requires the battlenet to guide the weapon through all phases of flight into contact with the target. Since the battlenet already identified and tracked the target, the system

could issue precision guidance instructions to the weapon. Passive guidance includes the ability of the weapon to read and identify multispectral signatures, either independently or in conjunction with the battlenet, then home in on the source of the signatures. Weapon susceptibility to countermeasures is on par with the battlenet. If necessary, the weapon cross-checks target location with the battlenet to resolve inaccuracies. Weapon guidance system degradation should be graceful and nonlethal. A malfunctioning guidance package requests and receives assistance from the battlenet, a manned platform, or a ground controller. If a malfunction prevents the weapon from accurately recognizing or tracking a target, the weapon deactivates and/or initiates low-order self destruction before impact.

The munitions of the future will be lightweight and multipurpose. Inflight conversion from a unitary warhead to submunitions or mines allows inherent targeting flexibility. In addition, battlenet input and onboard target recognition features allow flexible yields from the unitary warhead. Dual use of the stored energy material as an explosive or propellant would allow tactical trades of energy expenditure against the target or increased stand-off ranges. Submunitions exhibit independent target acquisition capabilities. A nonexplosive kill mechanism such as hypervelocity darts reduce the complexity of the weapons package but they still require a guidance package to get them into position to accelerate into the target. The capability must exist to target individual enemy troops in close proximity to friendly forces and incapacitate or kill them without exposing friendly troops to the weapons effects. Steerable flechettes or directed-energy weapons fired from overhead uninhabited platforms could have this effect.

CAS in urban environments or during peacekeeping missions requires the option of using nonlethal weapons. Acoustic signals, microwaves, sticky foam, or mood-altering pheromones could be dispensed. The caveat here is that friendly troops must have the inherent ability to resist the effects of these weapons because they may not know the type of weapon being used, hence may not have time to prepare. Special ear plugs, nose filters, or uniforms become standard equipment for this type of engagement. *New World Vistas* envisions an autonomous miniature munition (AMM) which is a small (<100 pounds), highly effective unitary munition providing a force-multiplying capability over a wide range of air-to-surface tasks.³³ Perhaps the AMM offers suitable nonlethal effects packages for use in these special environments. However, getting the AMM to be truly effective requires rapid progression in ATR, adaptive lethality, onboard guidance, and maneuvering packages.³⁴

Concept of Operations. Modularity in the build up of flexible munitions (FM) results in a customized weapon tailored to a specific target, or similar subset of targets. A truly effective FM uses a hybrid that material provides a range of released energy effects on a target and which doubles as a propulsive source for stand-off applications. Modularity can also reduce cost by allowing a specific sensor, guidance, and stand-off mechanism to be used as tasked by the battlenet. This reduces system multicapability redundancies that frequently drive up costs.

A self-contained FM production system (fig. 3-4) could be used to rapidly respond to battlenet requests for customized weapons. By producing the weapons “just-in-time,” storage and manual assembly of weapons could be eliminated.

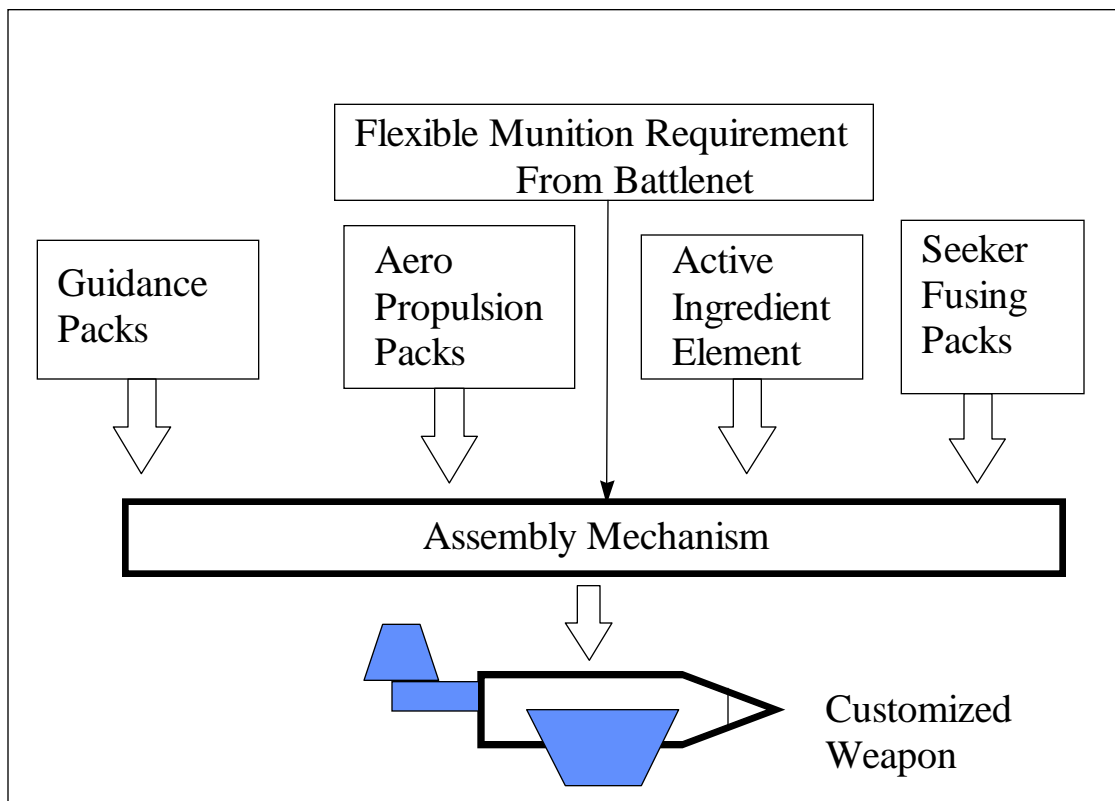

Figure 3-4. Flexible Munition Production Pallet and Subsystem

Location of the system could vary from internal carriage in larger aircraft when their use is warranted, to flightline or forward operating base use for smaller aircraft (fig. 3-5). In large aircraft, the greatest flexibility would be realized since little to no weapons carriage structure would be required. The weapon

would simply be produced and expelled in a continuous process. In smaller aircraft, a universal carriage mechanism is desired. In either case, support for the system would be replenishment of high-use subcomponents.

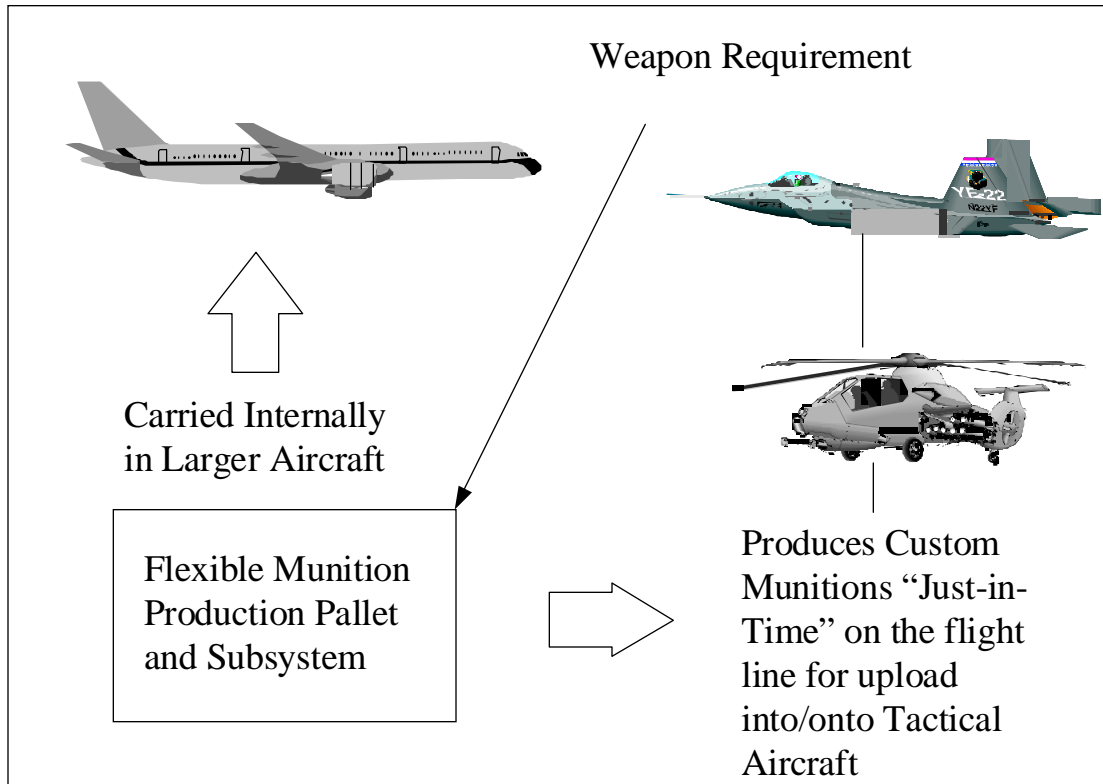

Figure 3-5. FM Multiple Uses

In summary, the battlespace of 2025 may be very different from that of today. However, the four subtasks of air-to-ground attack will remain. The goal of any system will be timely, and precise firepower. Reduction of effort and simplification of combat tasks for the human components during high stress will reduce the “fog of war” and allow the human to better deal with the results of “friction.”

- ¹ USAF Scientific Advisory Board, *New World Vistas: Air and Space Power for the 21st Century*, summary volume (Washington, D.C.: USAF Scientific Advisory Board, 15 December 1995), 5.
- ² Ibid.
- ³ Ibid.
- ⁴ “Force XXI America’s Army in the 21st Century,” *Army Focus*, September 1994, 13.
- ⁵ Ibid., 40.
- ⁶ 2025 Operations Analysis Team interview, Air University, March 14, 1996.
- ⁷ *New World Vistas*, summary volume, 23.
- ⁸ Vincent Kiernan, “The Eyes That Never Sleep,” *New Scientist* 148, no. 2002 (4 November 1995): 510.
- ⁹ David A. Fulghum, “Long Range Sensor Offers Options,” *Aviation Week & Space Technology* 139, no. 2 (12 July 1993): 23.
- ¹⁰ *New World Vistas*, summary volume, 22.
- ¹¹ **2025** Concept, No. 901093, “Continuous Area Surveillance and Denial,” **2025** Concepts Database, (Maxwell AFB, Ala.: Air War College/**2025**, 1996).
- ¹² *New World Vistas*, (unpublished draft, the sensor volume), i.
- ¹³ *New World Vistas*, (unpublished draft, the attack volume), x.
- ¹⁴ Ibid., 40.
- ¹⁵ **2025**, Concept, no. 901175, “Holographic Image Projector,” **2025** Concepts Database (Maxwell AFB, Ala.: Air War College/**2025**, 1996).
- ¹⁶ *New World Vistas*, (unpublished draft, the munitions volume), 66.
- ¹⁷ *New World Vistas*, (unpublished draft, the sensor volume), ix.
- ¹⁸ “New Electronic Device Developed to Prevent Friendly Fire Incidents,” *Defense Electronics* 27, no. 3 (3 March 1995): 12.
- ¹⁹ Kiernan, 13.
- ²⁰ Scott R. Gourley, “U.S. Army Warriors: 21st Century Equipment for 21st Century Missions,” *Defense Electronics* 27, no. 1 (January 1995): 14.
- ²¹ **2025**, Concept, no. 901165, “Personal Tactical Organizer,” **2025** Concepts Database (Maxwell AFB, Ala.: Air War College/**2025**, 1996).
- ²² **2025**, Concept, no. 901151, “Model Based Situation Database,” **2025** Concepts Database (Maxwell AFB, Ala.: Air War College/**2025**, 1996).
- ²³ Micheal A. Dornheim, “New Sensors Show Two Paths to Reconnaissance,” *Aviation Week & Space Technology* 143, no. 2 (10 July 1995): 48.
- ²⁴ **2025** Concept, no. 901131, “Real Time Battlefield Video,” **2025** Concepts Database (Maxwell AFB Ala.: Air War College/**2025**, 1996).
- ²⁵ **2025** Concept, no. 900913 “Virtual Battlefield Assessment Integrator,” **2025** Concepts Database (Maxwell AFB Ala.: Air War College/**2025**, 1996).
- ²⁶ Richard Aboulafia, “A Bomber Force Unrivaled,” *Aviation Week & Space Technology* 144, no. 2 (8 January 1996): 17.
- ²⁷ David A. Fulghum, “ARPA Explores Unmanned Combat Aircraft Designs,” *Aviation Week and Space Technology* 144, no. 9 (26 February 1996): 23-25.
- ²⁸ “America’s Army-Into the 21st Century,” *Army Focus* 1994, September 1994, 1-8.
- ²⁹ James C. Dunn and Donald L. Wiess, “B-2A Flight Test Progress Report” *Society of Experimental Test Pilots Symposium Proceedings* 1995, 17-33.
- ³⁰ David A. Fulghum, “Pentagon Cuts Field of JDAM Candidates,” *Aviation Week & Space Technology* 140, no. 15 (18 April 1994): 22.
- ³¹ Ibid.

³² Mark G. Chauret, ed., *Air Combat Command Operational Concept for the Joint Standoff Weapon (JSOW)*, Draft, 28 March 1994, 4-5.

³³ *New World Vistas*, (unpublished draft, the munitions volume), 10.

³⁴ *New World Vistas*, (unpublished draft, the munitions volume), 11.

Chapter 4

Concept of Operations

The underlying basis for this entire concept is the battlenet. It must exist either in physical form or as an assembly of computational elements in cyberspace. Access to and modification of individually desired architectures must occur at the first indication of need. Ideally, configuration and access requirements would be preplanned and “on the shelf” at the joint planning cells. Any service makes airpower assets (aircraft, weapons and personnel) available to the CINC. The need for tactical mission planning is small and the need for weaponeering is negligible. Aircraft loaded with FMs await a signal from the battlenet to launch. Platforms receive instructions (via datalink commands) to either fly to a point (to await CAS-type assignment) and hold, or to fly to a point and relegate commit authority to the battlenet. Weapons release occurs to engage targets enroute or upon reaching a turnaround point. The battlenet assigns a weapon to a target, then passes FM configuration data to the individual weapon via the carriage platform. The platform releases individual weapons or groups of weapons during various portions of the flight. The same aircraft may drop one or two weapons while crossing an area with troops in contact, drop all but a few against strategic targets, and drop its remainder against an emerging target during its return to reload.

Employment

To initiate a CAS mission, the requester first contacts the battlenet and provides proper authentication. After providing target data and desired effect to the battlenet, controllers receive a target correlation confirmation, proposed TOT, and a request for release authorization. The controller, perhaps someone many leagues from the target, confirms this information, authorizes weapon release, and awaits target engagement.

The controller would either personally evaluate target condition after the attack or receive that information from the battlenet, which could use multiple sources of data to better determine residual effectiveness of the target. Figure 4-1 depicts this process. For interdiction or strategic attack, the same process could occur with the controller being replaced by anyone, anywhere, with access to the battlenet as authorized by the JFACC.

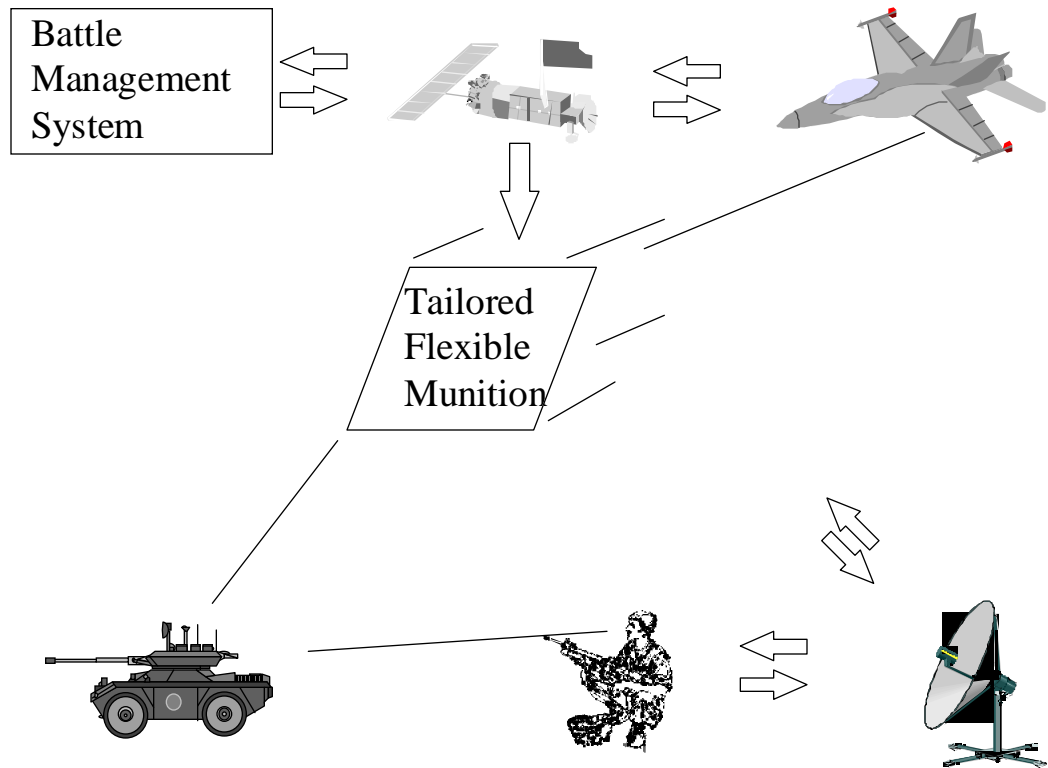

Figure 4-1. Battlenet

Communications, Logistics, and Personnel Requirements

Current communications methods use multiple bands of the RF spectrum. This makes directional detection of transmissions fairly easy. Using LPI techniques helps minimize the possibility of detection. Using other spectral regimes offers security and redundancy. Burst transmissions use the time domain for similar benefits.

Use of tracking software allows business and industry to monitor the transshipment status of materials. Satellite tracking of shipment and inventory control transponders will provide similar capability on a global scale. Logistics tracking subsystems of the battlenet provide additional information to battle managers, with AI-monitored flags available to warn of impending shortages.

Personnel management tasks in 2025 take on even more significance due to lower overall manning levels. Training must be continuous as new applications of technology take hold. As reliance on technology increases, the ability to gracefully degrade to less automated modes becomes very important. Commanders must ensure that personnel do not lose the capability to revert to manual operations if the system becomes degraded. If the battlenet breaks, do the troops know how to call in air support?

Strategically, reduction of the human risk element in many combat environments may increase the willingness of political leadership to employ combat power. The effects of the dehumanization and mechanization of warfare will carry profound philosophical implications. The “push-button” warriors forecast in the seventies became the “video” warriors forecast in the early nineties. By 2025, technically motivated remote control advocates may cause a shift in perception regarding the use of deadly force. The images and realities regarding the inhuman nature of any form of warfare may be the first elements of information filtered from the battlenet. Impersonal employment of death-producing effects, from safe and cozy command centers by those not willing to accept personal risk, fundamentally changes the face of conflict. The moral implications are immense.

Countermeasures

As targeting, C⁴I, weapons, and delivery systems evolve, the US military must expect improvements in enemy countermeasures to these systems. Some of the countermeasure methods, such as destruction, deception, jamming, and intrusion, overlap into several of the functional task areas. Negating the effects of the countermeasures may require different methods, depending on the functional area affected.

Central to the concept of CAS in 2025 is a battlenet for data input, information management, targeting, and command and control. A decentralized battlenet keeps critical nodes to a minimum, that will not prevent a sophisticated enemy from targeting the net. Severing the input sources from the processing units involves

blocking data transmissions, cutting communications uplinks, or electronically separating the data source from the data processor and information from the receiver. Therefore, the system must be resilient enough to withstand these efforts. The battlenet must accept a variety of input methods; for example, a controller with a voice radio should be able to call in target information to the battlenet. The system accepts and converts the spoken words into digitized information used by the battlenet.

If an enemy developed the ability to produce false targets, he could pose several different levels of threat. First, the volume of target information may overwhelm the battlenet itself. Second, the target indications could cause human battlespace commanders to commit weapons to invalid targets. Electronically placing real targets in the wrong location is a technology that is readily available now. If an enemy creates false targets and the battlenet recognizes them as being false, then his forces would be immune from attack if he physically or electronically disguises vehicles and personnel to resemble the false targets. We will not be alone in the technology race. A likely scenario provides a peer competitor access to the same weapons and technology we have. Security of information-based systems must remain a top priority.

Long-range enemy UAVs patrol deep in our territory looking for ours. Air-to-air and surface-to-air weapons systems will inevitably become more sophisticated in their ability to detect, track, and shoot down aerial and even space platforms. This indicates either a need for us to develop small numbers of well-defended platforms with resultant complexity or, perhaps, larger numbers of simple and redundant platforms networked so that losses do not critically affect operations. An effective method of preventing CID poses serious threats to our ability to conduct CAS operations. Compromise of critical capabilities and subsequent reproduction of CID signals could be devastating. Future CID systems should avoid using single-mode interrogation techniques.

The capability for graceful degradation must be built into any system to permit the battlespace commander to authorize weapons release based on targets input by sources outside the battlenet; for example, the forward controllers on the ground. If a threat successfully falsifies its position or prevents detection by our sensors, then command and control could reduce to the forward controller with a pair of binoculars and a radio calling in air strikes.

Perhaps the worst thing the enemy can do to our system is to cause errors in the determination of his location. In 2025, weapons will be small and sophisticated. They travel to targets using offboard systems,

onboard guidance, or a combination of the two for midcourse and terminal guidance. A reduction in the size of weapons in 2025, plus the possible high cost of placing terminal sensors on each munition, creates an argument for placing command guidance packages on some weapons. These weapons remain under the control of the battlenet and receive offboard guidance all the way to impact. Therefore, if the battlenet has incorrect information on the target location by even a few meters, the likelihood of successful target engagement decreases.

Enemy vehicles of the future-- and even personnel-- may carry a close-in self-defense system incorporating a target detector, tracker, and kill mechanism. Once our weapon succeeded in finding its way to the target, it would still run the risk of being intercepted and negated in the last few hundred meters. Our weapons must be too quick, too agile, too smart, or a combination of all three. By smart, the weapon must be able to sense and react to outputs from the target such as lasers, radar, particle beams, or projectiles. Reaction consists of maneuvering by the weapon, closing its eyes for a short time, deflecting or disrupting the enemy's defensive weapons, or targeting the source of the enemy's defensive system.

In any event, the continuous cycle of countermeasure and counter-countermeasure is prohibitively expensive. In fiscally limited environments, the risk exists that threat reactions to system development and deployment are ignored. The easiest method of preventing countermeasure development is to highly classify the newly developed capability. But this carries an increased price tag in security costs, and is in fact a tenuous solution. Compromise of any capability, especially in an information intense era is almost inevitable.

The best method for ensuring war-fighting superiority is to have an acquisition strategy that includes preplanned program improvements and that tests the system in a realistic operational environment. Testing acquired threat systems against ours demonstrates system strengths and weaknesses. The increased use of modeling and simulation runs the risk of missing a hidden threat capability or, just as bad, overestimating a threat capability and wasting precious resources to counter a nonissue.

Joint, Coalition, or Non-Combatant Operations

Systems proposed in this paper must be available to all US forces. Service-unique requirements must not result in reduced joint usage. Various forms of US systems should be made available to our coalition allies. Transparent sophistication will allow for rapid incorporation into any country's forces.

Nonlethal forms of air-delivered weaponry will have direct application in civil disturbances or operations-other-than-war (OOTW). The ability for the battle manager to rapidly apply various levels of precise power to a complicated target arena will provide for a much larger range of risk-management options.

Chapter 5

Investigative Recommendations

To improve close air support in 2025, the Department of Defense should focus its research and investigation on the three main areas listed in table 1: battlenet, weapons, and aircraft.

Table 1

Recommended Research Areas

Area for Research	Component
Battlenet	Combat Identification
	Controls and Displays
	Sensors
	Datalinks
Weapons	Artificial Intelligence
	Stand-off Range
	Terminal Guidance
	Non Lethal
Aircraft	Flexible Configuration
	Uninhabited Aerospace Vehicles
	Situational Awareness
	Performance/Survivability

The information revolution comes to CAS in the form of the battlenet, a network of sensors, computers, communications, and displays. The most important element for development within the battlenet is a reliable combat identification system. The lack of CID and the fear of fratricide make CAS extremely difficult, and training intensive, and they generate employment tactics not conducive to aircraft survival.

Modeling the battle and manipulating information-require new controls and displays. Hardware for displays being developed in the civilian sector will probably be sufficient for military needs. However, the mission-essential software may not be. There are some fundamental differences between the military and civilian computer-operating environments. Speed and clarity are important in both environments. Five

minutes to achieve a completely accurate solution may be quite reasonable to a civilian but intolerable in combat, where an 80 percent solution is acceptable if given in five milliseconds. Most civil applications allow for the operator to focus undivided attention on the data presentation. The combatant operating in a rugged environment under great stress faces life-threatening distracters. He or she will not have time to call up a file manager while sitting comfortably at a desk out of the line of fire. Combat cannot tolerate time spent searching through different pages or levels of software for enough information to formulate an overall picture. There is no such thing as a combat file manager.

Data cannot be dumped on warriors; it must be converted to information, then pushed to the combatants this allowing them flexibility in determining quantity and format. Customized displays on a variety of mediums are absolutely essential to the war fighters. Programs must pursue the lessons learned from related works and projects when designing controls and displays. Keep one eye focused on maintaining flexibility. This is especially true in a world where electronic obsolescence can occur in a few months while new weapons are introduced every few years and aircraft are expected to last decades.

The B-2 program managers elected not to transfer the lessons learned from previous aircraft developments in developing a new software architecture. A rigid, constrained, focus on a single mission unnecessarily increased aircrew workload to the point that it was rated marginally acceptable before the demanding or complex evaluations could be flown.¹ Experienced organizations designing from scratch, following old paradigms, or new inexperienced organizations may be prone to offer what works in an office, machine, process, or game as a solution to the military's needs. Meeting military demands requires robust testing, demonstrated flexibility, and expandability for all types of systems. Continuing progress in the development of artificial intelligence and computer processing power by the civil sector should provide the requisite technology to comply with the military's unique needs to convert data to easily accessible information.

Our senior leadership's vision of the future must motivate substantial investment in reconnaissance and surveillance sensors and platforms. In the future, the multitude of sensors and platforms must be melded into an overarching architecture that supports the battlenet concept. As the battlenet generates improved situational awareness for all echelons of command, the demand for additional information increases.

Therefore, the system of sensors providing data to the battlenet must permit room for rapid growth and expansion.

The string, composed of communications and datalinks, ties the pieces of the battlenet together. Security, speed, and bandwidth require ongoing research and development.

Integrating improved weapon systems into the battlenet will vastly increase the capability of US forces to accomplish CAS. By 2025, all combat aircraft gain the ability to accomplish this mission 24 hours-a-day, regardless of the weather. Increased standoff range, quantum improvements in terminal guidance, sensing, and fusing enhance weapon effectiveness. Targeting flexibility and nonlethal capabilities add new dimensions to CAS operations. In the future, the air tasking order (ATO) may task individual weapons vice actual aircraft.

The current evolution of aircraft is proceeding on the right track. The Department of Defense (DOD) is correctly placing emphasis on developing uninhabited and remotely piloted vehicles. These are the weapons platforms of the future. We will be able to find, identify, and attack targets at lower risk and ultimately lower cost via these platforms. Manned aircraft, however, will not be eliminated by 2025. Accordingly, we should continue to pursue improvements in aircraft performance and stealthiness. These improvements, however, are not the only means of enhancing combat effectiveness. The construction of the battlenet, weapons advancements, and better automation will greatly improve and prolong aircraft combat effectiveness. Improvements that enhance situational awareness will provide the maximum return in combat capability.

The acquisition process is the foundation for much of this improvement. We need an improved cost-effective process that fields technology quickly and supports oversight requirements. The civilian sector aids this process by accomplishing most of the initial research and development. Unfortunately, new developments also aid our enemies, hence we must be able to exploit civil technologies before our adversaries do.

Current acquisition methods are acknowledged to be unwieldy and unnecessarily restrictive. In the emerging era of extremely rapid technology growth, the acquisition system must accelerate to maximize the benefits of new capabilities. The phenomenon of “obsolescence while in development” is a very real hazard. The process also requires continued reform in the face of shrinking defense dollars and the defense industrial base. Using concurrent developmental and operational test processes reduces time and funding

requirements. Detailed modeling and simulation techniques can accurately predict system performance. Operational suitability of future systems will be much easier to test due to the inherent reliability of electronic systems.

A strategic development plan and common architecture must be agreed upon at the earliest planning stages to provide a framework on which to construct independent elements. Concurrent development of subcomponents must occur to shorten the acquisition cycle.

Service parochiality and fights for scarce fiscal resources must be avoided at all levels. Joint procurement processes must continue to be required at every possible opportunity. However, we arrive at the battle in 2025, we know there are austere funding environments enroute. Maintenance of the US military's supremacy in the future will require constant improvement in both technologies and practices. A constant maximum effort must be made by every member of the profession of arms to continually optimize the vast capability of this force, regardless of uniform color, and blind as to which service operates which system. To do less shirks our sworn duty.

Notes

¹ Col James C. Dunn and Donald L. Wiess, "B-2A Flight Test Progress Report" *Society of Experimental Test Pilots Symposium Proceedings*, 1995, 17-33.

Appendix A

Close Air Support Definitions

Close Air Support enjoys a similar definition in each branch of the service. These definitions came from several sources and were cross-referenced. This appendix presents the definitions in the following format:

Branch Of Service

Source of information

Reference where source discovered information

Text of information

USAF

Air Force Manual 1-1 Volume II *Basic Aerospace Doctrine of the USAF* March 1992.

Joint Pub 1-02

Air action against hostile targets which are in close proximity to friendly forces and which require detailed integration of each air mission with the fire and movement of those forces.

US Army FM 100-20, July 1943

Air participation in the combined effort of the air and ground forces, in the battle, to gain objectives in the immediate front of these ground forces.

Joint Force Air Component Commander (JFACC) Primer 2nd ed., Feb. 1994.

Joint Pub 1-02

Close support -- action against targets or objectives sufficiently near the supported force as to require detailed integration or coordination of the supporting unit.

Close Air Support: Supported Commander: JFLCC

CAS Targeting: JFLCC

Coord Air: JFACC

Graphically CAS is depicted as air to surface operations between the Forward Line of Troops (FLOT) and the Fire Support Coordination Line (FSCL)

The United States Air Force, A Dictionary edited by Watson and Watson Garland Publishing, Inc. New York and London 1992.

Department of Defense, Department of the Air Force. *The United States Air Force Dictionary*. Edited by Woodford Agee Heflin. Montgomery Ala.: Air University Press, 1956.

Poyer, David *The Med*. New York: St. Martin's Press, 1988.

Close Air Support (CAS) is action against enemy targets that are close to friendly forces. It requires the detailed integration of each air mission with the fire and movement of the enemy forces. Close air support is requested and approved by the support unit commander, and is controlled by the forward air controller.

Department of Defense, Department of the Air Force. *Air Force Pamphlet 50-34, Training: Promotion Fitness Examination Study Guide*. vol 1. Washington, D.C.: Headquarters US Air Force, 1990.

Department of Defense, Department of the Air Force. *The United States Air Force Dictionary*. Edited by Woodford Agee Heflin. Montgomery Ala.: Air University Press, 1956

Close Air Support Missions support land operations by attacking hostile targets close to friendly surface forces. Close air support can support offensive, counteroffensive, and defensive surface force operations with preplanned or immediate attacks. All preplanned and immediate close air support missions require access to the battlefield, timely intelligence information, and accurate weapons delivery. Close air support enhances land force operations by providing the capability to deliver a wide range of weapons and massed firepower at decisive points. It can surprise the enemy, create opportunities for the maneuver or advance of friendly forces through shock action and concentrated attacks, protect the flanks of friendly forces, blunt enemy offensives, and protect the rear of land forces during retrograde operations.

JOINT/MARINES

Joint Pub 3-0 Doctrine for Joint Operations 1 February 1995.

Joint Pub 1-02

Air action by fixed and rotary wing aircraft against hostile targets which are in close proximity to friendly forces and which require detailed integration of each air mission with the fire and movement of those forces. Also called CAS.

ARMY

United States Army, *A Dictionary* edited by Peter Tsouras, Garland Publishing, Inc. New York & London 1991.

Department of Defense, *US Army Air Defense Artillery Deployment: Chaparral/Vulcan/Stinger*. FM 44-3. Washington, D.C.: Headquarters, Department of the Army.

Attack Helicopter Operations. FM 17-50. 1984

Operational Terms and Symbols. FM 101-5-1. 1985

USA/USAF Doctrine for Joint Airborne and Tactical Airlift Operations. FM 100-27, 1985.

Close Air Support is air action against enemy targets that are located close to friendly forces. Thus, the detailed integration of each air mission with the fire and movement of the enemy forces is required. Close air support is requested and approved by the support unit commander, and is controlled by the forward air controller.

Department of Defense, US Army. *Operations*. FM 100-5. Washington, D.C.: Headquarters, Department of the Army, 1986.

USA/USAF Doctrine for Joint Airborne and Tactical Airlift Operations. FM 100-27, 1985.

Close Air Support Missions support land operations by attacking hostile targets in close proximity to friendly surface forces. Close air support can support offensive, counteroffensive, and defensive surface force operations with preplanned or immediate attacks. All preplanned and immediate close air support missions require access to the battlefield, timely intelligence, information, and accurate weapons delivery.

Close air support enhances land force operations by providing the capability to deliver a wide range of weapons and massed firepower at decisive points. It can surprise the enemy, create opportunities for the maneuver or advance of friendly forces through shock action and concentrated attacks, protect the flanks of friendly forces, blunt enemy offensives, and protect the rear of land forces during retrograde operations.

FM 100-26 Chapter 3, Air Support Operations

Close air support is air attacks against hostile targets that are in proximity to friendly ground forces and that require detailed integration of each air mission with the fire and movement of those forces. The fixed wing CAS strikes are controlled by an element of the tactical air control system (TACS) operating with the supported maneuver unit. This element is responsive to the needs of the commander of the ground unit.

NAVY

The United States Navy, A Dictionary edited by Bruce W. Watson, Garland Publishing, Inc. New York & London, 1991.

Department of Defense, Joint Chiefs of Staff, *Department of Defense Dictionary of Military and Related Terms*, Washington, D.C.: 1985

DOD, US Naval Education and Training Command, *Air Traffic Controller 1&C* NAVEDTRA 10368-F2, Washington, D.C.: 1983

Air Traffic Controller 3&2. James T. Pruett ed. NAVEDTRA 10367-G. Washington, D.C.: 1983

Seabee Combat Handbook. Patrick J. Essinger, ed. NAVEDTRA 10479-C2. Washington, D.C.: 1985

Close Air Support is air action against hostile targets that are close to friendly forces and that require detailed integration of each air mission with the fire and movement of those forces.

Appendix B

Close Air Support Description

All the services use the same joint definition of CAS. CAS gives the ground force commander the ability to engage the enemy with the combined arms of ground and air forces to gain synergistic effects over the battlefield and its targets. To accomplish this integration, the ground commander gains access to the air component's planning and execution process. Specialized communication nets tie these leaders into the normal ATO process and also provide the ability to get crisis response on short notice requests.

All US armed forces doctrinally conduct CAS very similarly, although the CAS joint publication is currently being written. CAS is centrally controlled and decentrally executed. The higher unit commander approves missions and then the FAC and delivery aircraft actually controls final execution. This allows the Air Component Commander to allocate his air resources in compliance with the joint force commander (JFC) direction. To accomplish this, an extensive command and control (C²) network has to be used. CAS differs from air interdiction by its proximity to friendly ground forces and the need for detailed integration of each mission with the fire and maneuver of those forces. Due to concern over fratricide, constraints have been put in place to protect ground forces (mark and clearance to drop). These constraints limit tactical flexibility of the delivery aircraft.

Currently, CAS can be divided into the following C² nodes:

System	Current Agency
1. Terminal Controller	FAC (ground or airborne)
2. Ground C ² System	Fire Support Coordination Center (FSCC)
3. Aviation C ² System	Tactical Air Command Center/ Tactical Air Control Center(TACC)/ Direct Air Support Center (DASC)
4. Delivery Platform/Weapon	Aircraft

The terminal controller is a forward air controller (FAC) whose responsibility is to safely control CAS aircraft ordnance delivery. The FSCC reviews allocation of fixed-wing resources and subordinate requests for CAS support. The FSCC also plans for and coordinates future CAS requirements. The senior-level FSCC or equivalent presents a prioritized listing of requirements to the TACC. The TACC provides CAS sorties to Army forces based on the apportionment decision of the JFC while the DASC provides for fast reaction capability for immediate CAS requests. Aircrews receive the mission from either the ATO or the TACC. Requirements for effective CAS include air superiority, suppression of enemy air defenses (SEAD), target marking, favorable weather, flexible control, prompt response, aircrew, and terminal controller proficiency.

Appendix C

CAS Fundamentals

Apportionment/allocation. CAS is only one of the many missions of airpower. The JFC, through the JFACC balances the percentage of sorties among the various missions to achieve the campaign objectives. The JFC chooses this apportionment by using inputs from his various subordinate commanders and comparing the requirements to the availability of air assets. The Omnibus Agreement provides further guidance on the special airpower requirements of the Marine Corps' Marine Air Ground Task Force (MAGTF) concept. The JFACC takes the JFC apportionment decision and allocates the available CAS sorties to ground commanders. If the ground commander exhausts his allocated CAS sorties, he may request additional sorties. Conversely, he returns excess sorties to the JFACC for use on other missions.

Communications. FACs and other agencies pass detailed instructions on short notice to the aircrews. Specialized fire control, tactical air request, and tactical air direction nets are in place to plan, request, coordinate supporting arms, and direct aircraft. UHF and VHF channels are vulnerable to exploitation by the enemy thus creating the potential for the disruption of CAS missions. Immediate missions are especially dependent on voice communication. The FSCCs at all echelons constantly monitor a special parallel communication net for fire support deconfliction and approval. The TACCs and FCCs use a "silence-is-consent" procedure that ensures minimum response time to fire support requests. A standard nine-line brief contains the information to complete a CAS mission.

CAS categories. There are two types of CAS requests: preplanned and immediate. Commanders use preplanned requests for anticipated CAS requirements. They allow detailed mission coordination

and planning by the aircrews. Preplanned missions appear on the ATO and have an actual target, a location, and a target time. Ground commanders submit requests for preplanned CAS missions to FSCCs for evaluation, consolidation, and prioritization. The senior echelon FSCC makes the final consolidation and approves missions consistent with the CAS sortie allocation. The FSCC passes the missions to the TACC for execution. Preplanned CAS missions compete with other CAS missions for approval and placement on the ATO. Commanders at the battalion level or below use immediate CAS requests for unanticipated or urgent targets which do not appear on the ATO. FSCCs pass the request to the TACC for consideration. If approved, the TACC forwards the request to the Air Support Operations Center for execution. On immediate CAS missions, aircrews do not complete detailed mission planning and coordination before launching. The JFACC holds some aircraft on CAS alert (ground or air) to respond to immediate requests. The TACC has the option to divert aircraft on other missions.

Normal aircraft procedures. A pilot executing a CAS mission plans and flies a route to a predesignated contact point (CP). The pilot contacts the DASC or designated agency and receives further instructions. Pilots usually contact a FAC for final routing and coordination. Pilots fly CAS missions in a high or reduced surface-to-air threat environment. Aircraft, artillery, or naval gunfire provide SEAD to reduce this threat. After completing the mission, the FAC passes BDA to the pilot who then flies through a return-to-force corridor to deconflict with other aircraft, supporting arms, and air defense engagement zones.

Inflight Briefing procedures. Standard nine-line briefs are the joint format for passing CAS information. The brief includes heading, distance, target description, location, elevation, mark, friendly locations, egress instructions, and TOT. Combined operation briefings include the same information but can use different formats.

Target acquisition. Due to the tactical size, dynamic nature, and the necessity for specific target engagement, target acquisition can be the most difficult step of mission completion. Currently, visual recognition is the most common means of target acquisition.

Aircraft losses. The forward area of the battle area is usually heavily defended by air defense systems. This creates a high probability of aircraft loss or damage. Aircraft delivery parameters, multiple attacks, clearance to drop, and lack of SEAD all contribute to aircraft tactics that significantly increase CAS aircraft vulnerability.

Ordnance. Usually, weaponeers choose the specific ordnance for optimum effect on the target during preflight targeting meetings. CAS aircraft on alert for immediate missions may not be loaded with the best ordnance for the assigned target. As a result, the attack may be less effective than required.

Clearance to drop. Due to the close proximity of friendlies, the FAC clears each individual aircraft to drop ordnance. The FAC visually acquires the aircraft to ensure that it heads for the correct target. If the FAC fails to acquire the aircraft due to night, marginal weather, delivery profile, or small aircraft size, the FAC withholds the clearance. This necessitates multiple passes by the attacking aircraft, which considerably decreases its survivability.

Target marking. Targets are marked to improve visual acquisition. Laser designation and smoke are the most common means used to identify targets.

Weather. Poor weather conditions and night operations severely limit CAS effectiveness. Although the current use of night vision devices and sensor pods increase aircraft capabilities, significant limitations exist in marginal weather.

Bibliography

- 2025 Concept No. 901165. "Personal Tactical Organizer." 2025 Concepts Database. Maxwell AFB, Ala.: Air War College/2025, 1996.
- 2025 Concept No. 901151. Model Based Situation Database." 2025 Concepts Database. Maxwell AFB, Ala.: Air War College/2025, 1996.
- 2025 Concept No. 901131. "Real Time Battlefield Video." 2025 Concepts Database. Maxwell AFB Ala.: Air War College/2025, 1996.
- 2025 Concept No. 900913. "Virtual Battlefield Assessment Integrator" 2025 Concepts Database. Maxwell AFB Ala.: Air War College/2025, 1996.
- 2025 Concept, No. 901093. "Continuous Area Surveillance and Denial." 2025 Concepts Database. Maxwell AFB, Ala.: Air War College/2025, 1996.
- 2025, Concept No. 901175. "Holographic Image Projector." 2025 Concepts Database. Maxwell AFB, Ala.: Air War College/2025, 1996.
- Aboulafia, Richard. "A Bomber Force Unrivaled." *Aviation Week & Space Technology* 144, no. 2 (8 January 1996).
- Archambault, Raoul and Thomas M. Dean. *Ending the Close Air Support Controversy*, Newport, RI 21 June 1991.
- Air Combat Command Operational Concept for the Joint Standoff Weapon (JSOW), Draft. 28 May 1994.
- AFM 1-1. *Basic Aerospace Doctrine of the USAF*. 2 vols., March 1992.
- Buchanan, Thomas H. *The Tactical Air Control System: Its Evolution and its Need for Battle Managers*. Airpower Research Institute Report No. AU-ARI-81-1. Maxwell AFB, Ala.: Air University Press, May 1987.
- Correl, John T., ed. "More Data From Desert Storm." *Air Force Magazine* 79, no. 1 (January 1996).
- Dornheim, Michael A. "New Sensors Show Two Paths to Reconnaissance." *Aviation Week & Space Technology* 143, no. 2 (10 July 1995).
- Dunn, James C., and Donald L. Wiess. "B-2A Flight Test Progress Report." *Society of Experimental Test Pilots Symposium Proceedings*. 1995.
- Essinger, Patrick J. ed.. *Seabee Combat Handbook*. NAVEDTRA 10479-C2. Washington D.C.: 1985.
- FM 100-5. *Operations*. 1986.
- FM 100-20. *Command and Employment of Airpower*. 21 July 1943.
- FM 100-26. *The Air-Ground Operations System*. 1973.
- FM 100-27. *USA/USAF Doctrine for Joint Airborne and Tactical Airlift Operations*. 1985.
- Fulghum, David A. "ARPA Explores Unmanned Combat Aircraft Designs." *Aviation Week & Space Technology* 144, no. 9 (26 February 1996).
- _____. "Long Range Sensor Offers Options." *Aviation Week & Space Technology* 139, no. 2 (12 July 1993).

- _____. "Pentagon Cuts Field of JDAM Candidates." *Aviation Week & Space Technology* 140, no. 15 (18 April 1994).
- Gourley, Scott R. "U.S. Army Warriors: 21st Century Equipment for 21st Century Missions." *Defense Electronics* 27, no. 1 (January 1995).
- Joint Force Air Component Commander (JFACC) Primer*. 2d ed. February 1994.
- Joint Pub 0-2. Unified Action Armed Forces (UNAAF)*. 1986. 24 February 1995
- Joint Pub 3-0. Doctrine for Joint Operations*. February 1995.
- Kiernan, Vincent. "The Eyes that Never Sleep." *New Scientist* 148, no. 2002 (November 4, 1995).
- "New Electronics Device Developed to Prevent Friendly Fire Incidents." *Defense Electronics* 27, no. 3, 3 March 1995.
- OH 5-4A. Close Air Support*. October 1985.
- Sullivan, Gen Gordon R and James M. Dubik. *Land Warfare in the 21st Century*. Carlisle Barracks, Penn.: Strategic Studies Institute, 1993.
- Tirpak, John A. "Heavyweights for the New Strategy." *Air Force Magazine* 78, no. 10 (October 1995).
- "Technology, Exploration and Exploitation Plan." Commandant's Warfighting Laboratory. December 1995. 4; on-line, Internet, January 1996, available from <http://138.156.204.100/www/cwl/planch1.htm>.
- Treyz, Fred A., ed.. "Force XXI, America's Army In the 21st Century." *Army Focus* 1994. Washington D.C.: US Army Publication and Printing Command, September 1994.
- USAF Scientific Advisory Board. *New World Vistas: Air and Space Power for the 21st Century*, Summary Volume. Washington, D.C.: USAF Scientific Advisory Board, 15 December 1995.
- _____. *New World Vistas: Air and Space Power for the 21st Century*. Unpublished draft, the Attack Volume. 15 December 1995.
- _____. *New World Vistas: Air and Space Power for the 21st Century*. Unpublished draft, the Munitions Volume. 15 December 1995.
- _____. *New World Vistas: Air and Space Power for the 21st Century*. Unpublished draft, the Sensors Volume. 15 December 1995.

Counterair: The Cutting Edge



A Research Paper
Presented To

Air Force *2025*

by

Col (Sel) Rick W. Lester
CDR Steven M. Jacobsmeyer (USN)
Lt Col Michael M. Miller
Maj Jim C. Bigham, Jr.
Maj Stephen M. Tanous

August 1996

Disclaimer

2025 is a study designed to comply with a directive from the chief of staff of the Air Force to examine the concepts, capabilities, and technologies the United States will require to remain the dominant air and space force in the future. Presented on 17 June 1996, this report was produced in the Department of Defense school environment of academic freedom and in the interest of advancing concepts related to national defense. The views expressed in this report are those of the authors and do not reflect the official policy or position of the United States Air Force, Department of Defense, or the United States government.

This report contains fictional representations of future situations/scenarios. Any similarities to real people or events, other than those specifically cited, are unintentional and are for purposes of illustration only.

This publication has been reviewed by security and policy review authorities, is unclassified, and is cleared for public release.

Contents

<i>Chapter</i>	<i>Page</i>
Disclaimer	ii
Illustrations.....	v
Tables.....	v
Preface.....	vi
Executive Summary	vii
1 Introduction	1
Counterair Defined	3
Why Counterair?.....	5
2 The Evolutionary Trajectory The Fighter Pilot—Here to Stay?.....	7
Counterair Requirements	8
System Descriptions	9
Situational Awareness	10
Detection and Acquisition.....	11
Weapons	12
Countermeasures and Countercountermeasures.....	13
Enabling Technologies.....	13
Concept of Operations	15
Summary	16
3 The Penurial Robophile Trajectory Pilots—the Rarest Breed.....	20
Counterair Requirements	21
System Descriptions	22
Applications.....	23
Weapons	23
Countermeasures and Countercountermeasures.....	25
Enabling Technologies.....	25
Concept of Operations	26
Summary	27
4 The Virtual Trajectory Air Superiority without an “Air” Force?.....	31
Counterair Requirements	32
System Descriptions	33
Information Collection and Processing	34
Situational Awareness/Command, Control, and Communications.....	36
Force Applications Systems.....	38
High Energy Lasers	38
RF and High Power Microwave/Electromagnetic Pulse Devices.....	41
Kinetic Energy Weapons/Ground Launched Cruise Missiles.....	44

<i>Chapter</i>		<i>Page</i>
	Enabling Technologies.....	45
	Concept of Operations	46
	Summary	48
5	Synthesis	52
	Analysis	53
	Comparison.....	55
6	Recommendation.....	58
	Concept of Operations for 2025.....	59
	Conclusion.....	62
	Bibliography.....	64

Illustrations

<i>Figure</i>	<i>Page</i>
2-1. 360 Degree Helmet-Mounted Display	11
2-2. Sensor Fusion and Target ID	14
3-1. Representation of UAV Ground Cockpit.....	24
3-2. UCAV Strike Fighter (FotoFighter)	27
4-1. Distributed Satellite Constellation.....	35
4-2. Holographic War Room.....	37
4-3. Friendly Phased Array Lasers Targeting Enemy Aircraft	40
4-4. Multi-Tiered (Laser, GLCM, Railgun) Missile Defense Capability	48
6-1. Counterair Triad Concept of Operations	61

Tables

<i>Table</i>	<i>Page</i>
1 Comparison of Counterair Approaches	57

Preface

The counterair mission has been the core of every air operation since the days of the first dogfights of World War I. The successful prosecution of every battle, every campaign since that time has relied on the ability of friendly forces to dominate the skies. A question that has arisen numerous times since the start of 2025 has been: will the counterair mission still be relevant 30 years from now? The answer is a resounding *yes*. Regardless of the state of the art, the nature of the enemy, or the battlefield task at hand, the ability to use the skies with impunity, while denying the same capability to an enemy, is a *prerequisite* for every other war-fighting element of any future campaign. Without it, we lose the advantages gained by the inherent speed, range, and flexibility of airpower. We also risk putting ourselves on the defensive while ceding these same advantages to our adversaries. As the precision and lethality of our weapons increases, air superiority must be gained to allow us to observe the enemy, track his activity, and react in a prompt and decisive manner, whether or not he uses (or can use) airpower in support of his own objectives, or even whether or not we choose to use (or can use) airpower in support of our objectives. For this reason alone we are driven to examine not whether the counterair mission will still be performed in 2025, but how we will achieve it in the most effective, efficient manner. This study examines what the counterair mission of 2025 will entail and how we will accomplish it.

Executive Summary

This white paper examines the counterair mission in 2025—what it is, what the threats are, and how we counter them. In the broadest sense, the counterair mission will not change in the next 30 years. The basic premise of air superiority—neutralizing or destroying an adversary’s ability to control the skies—will remain intact. This paper examines the counterair mission by first performing an analysis of three different trajectories. The first is an evolutionary trajectory based on projections of current and programmed capability. The second and third trajectories represent extremes—“anything but” approaches for conducting the counterair mission. The second trajectory is “anything but” inhabited aircraft, and the third is “anything but” aircraft at all—performing the counterair mission solely with surface and space-based systems. The results of this analysis will provide a basis of comparison for each.

Common themes emerge from all three trajectories. The primary theme is a requirement for near-real-time collection, processing, and distribution of information, or in some cases knowledge, to support the commander’s assessment and reaction to a given situation. A comprehensive holographic display system is required to present the information to the commander. There also is a need for robust command, control, and communications networks distributed over commercial and military networks to pass this information. Finally, a synthesis of the three approaches will yield a system of systems—a counterair triad. The triad will be geared to handle a multiplicity of threats, from Cessna aircraft threatening the White House to uninhabited aerial vehicles attempting to monitor our operations, from Chinese-built stealth fighters in the Pacific to cruise missiles from Iran, or from terrorists with hand-held antiaircraft weapons to North Korean theater ballistic missiles. Inhabited vehicles provide flexibility where the fidelity of information available is limited or cut off, particularly in sensitive situations requiring definitive action as well as accountability. Uninhabited vehicles will provide a capability for rapid response using hypersonic, highly maneuverable lethal and nonlethal application of force against an adversary’s air forces. Space and surface-based counterair forces can provide immediate, precision strike against cruise missiles, intercontinental and theater ballistic missiles, as well as instant lethal and nonlethal force against forward air threats out of reach of

available friendly air forces. A synthesis of the results of all three trajectories into a counterair triad will allow the strengths of each area to fill in the weaknesses of the other two, permitting a full range of nonlethal to lethal application of force against any adversary.

Chapter 1

Introduction

The major thesis held by Trenchard and Mitchell, as well as Seversky, was that command of the air is of first priority to any military success in war.

— Maj Gen Dale O. Smith

Airpower is the cutting edge of the sword of the Republic, and upon that sword the Republic will stand or fall. This statement was true in 1980 and it will still be true in 2025. The direction of this effort is to describe the counterair operational world of 2025. The world of 2025 will be different from the world of 1995. This is a given; the question is: how different? Part of the approach of 2025 is the requirement there be no surprises. The approach taken here is to first perform an analysis of how the counterair mission could be accomplished using the “anything but” construct. This analysis looks at the counterair problem from several different perspectives. The first perspective is a projection looking out from 1996 to 2025 based on what we know today. The second and third perspectives are extremes, used to facilitate analysis of the problem. The second perspective examines counterair using anything but inhabited aircraft. The third perspective includes anything but air-breathing aircraft.

The next part of the analysis requires a recognition of where technology is headed and where the Air Force leadership is placing its emphasis. A review of *New World Vistas* demonstrates an emphasis on reduction in USAF spending on specialized systems for common needs (such as communications), a view towards uninhabited air vehicles (UAV), and increased reliance on command, control, communications, computers, and intelligence (C4I) and space.¹ As commercial enterprises outstrip the ability of the military to fund advanced research and technology initiatives, it behooves the US armed forces to take advantage of their efforts rather than fund separate “stove-pipe” military systems.

Air Force Executive Guidance, December 95 Update, focuses on “effective planning for future alternatives.”² It provides a thumbnail sketch of the environment and threat, as well as specific planning guidance and describes offensive airborne vehicles and weapons of mass destruction (WMD) as the most direct threat to US security. The key assumptions drawn from it are an increasing air-breathing threat, including cruise and theater ballistic missiles; an increasing requirement for nontraditional defense systems, such as high-power microwave and lasers against attacking aircraft; and a continuing requirement to suppress enemy air defenses as a prerequisite for air superiority. The guidance that falls from these assumptions is consistent; there is a need to detect, locate, identify, engage, and destroy targets on the surface (both fixed and mobile) and in the air, as well as ensuring onboard threat warning and self-protection systems for aircraft of all air forces.

Finally, a review of the threat environment puts proposed capabilities into proper context. A briefing given by the special assistant to the chief of staff for long-range planning (HQ USAF/LR) to the Defense Science Board in March 1996 describes three types of future adversaries. The first type is a regional adversary, those who will challenge the US in their geographic areas (such as Iraq or North Korea). The second type is peer competitors, which are viewed as likely to emerge in the long term. A peer competitor could be a nation or group of nations with broad-based military power projection capability, able to threaten US or allied interests in more than one region of the world, and could include a resurgent Russia or emergent China. The third possibility is a niche competitor, including nonnation/nonstate actors capable of acting against US interests (i.e., terrorists or drug cartels).³

Combining these views results in three different trajectories, each with a different outcome for how the counterair mission could be conducted in 2025. The first is the evolutionary trajectory. An extrapolation from today in terms of development and modernization programs, this trajectory assumes a world of continuing technological advancement, relatively constant US defense spending, and world players in the same relative positions of strength. Air superiority and the counterair mission will be dominated by existing airframes and those already budgeted or in development. UAVs and space assets will augment these to accommodate smaller air forces relying on power projection from the continental United States (CONUS), aircraft carriers, and a select few major overseas bases.

The second is the “penurial robophile”—cheap robot-lover—trajectory. This assumes a significant reduction of defense spending, coupled with significant advances in technology and its application. An American world view focused internally but still concerned about external threats drives the air superiority mission towards a reliance on awareness and a reactive stand-off capability, representing air forces in being—the strength of the force is in its capabilities, not its size. This cut in spending, reliance on technology, and reluctance to expose US armed forces personnel to risk leads to a primarily UAV counterair capability.

In this trio of possible paths the counterair mission might follow, the last is the virtual trajectory. This trajectory assumes a globally minded United States with a surplus of technology and a budget to back it up. It represents the ultimate in virtual presence, virtual power. It is a ubiquitous space-based capability that includes not only force enhancement capabilities but force application, complemented by surface-based assets for those hard-to-reach, hard-to-kill targets or those evading the space-based assets. This capability allows all the functions listed in the *Executive Guidance* (detect, locate, identify, engage, and destroy targets) to be performed almost instantly.

This white paper reviews each approach with a critical eye towards the goal of no surprises. The triclinic of these trajectories will result in a synthesis of capabilities designed to provide assured air superiority in 2025.

This paper assesses the future counterair mission using the following organization: (1) to define the counterair mission and the focus of this white paper; (2) to develop the assumptions, required capabilities, systems, enabling technologies, and concepts of operations in each of the three trajectories; and (3) to recommend a counterair capability based on a review these results in the context of ensuring no surprises and assured air superiority and develop a concept of operations for employment by 2025.

Counterair Defined

If we lose the war in the air, we lose the war and lose it quickly.

—Field Marshal Bernard L. Montgomery

Counterair is a mission that currently falls under the role of aerospace control. The focus of this white paper is limited to counterair (not counterspace) operations; however, the future is bringing with it a fusion of air and space capabilities that will increasingly blur the distinctions between counterair and counterspace operations. Aerospace control permits aerospace and surface forces to operate freely while denying access to the aerospace by the enemy. Counterair is the enabler that makes this possible. This is true today and it will be true in 2025. The counterair world of 2025 will be a smaller world where the Atlantic and Pacific Oceans will not provide the obstacles to offensive/defensive air operations they do today. The definitions for counterair and the counterair missions follow.

Counterair is a term for operations conducted to attain and maintain a desired degree of air superiority by the destruction or neutralization of enemy air forces. Both air offensive and air defensive actions are involved. The former range throughout enemy territory and are generally conducted at the initiative of the friendly forces. The latter are conducted near to or over friendly territory and are generally reactive to the initiative of the enemy air forces. For example, an F-22 launching an antisatellite missile at a space-based laser attacking friendly air forces would be a counterspace sortie. On the other hand, an F-22 taking defensive measures against a space-based platform is included in the counterair arena. As a guideline, action taken against space assets by air assets in a defensive response is included in the counterair mission area, while preplanned missions against space assets are counterspace missions. Additionally, in 2025, countering the cruise missile and theater ballistic missile (TBM) threat will be a part of both the offensive and defensive counterair mission.

Offensive counterair operations are operations mounted to destroy, disrupt, or limit airpower as close to its source as possible. While suppression of enemy air defenses (SEAD) is clearly in this category, the tactics and weapons to destroy, disrupt, or disable the enemy air defenses fall under the categories of tactical/strategic attack. *Defensive counterair operations* provide the protection of assets from air attack through both direct defense and destruction of the enemy's air attack capacity from the air.

Why Counterair?

It is our principal responsibility to provide the umbrella under which US and multinational forces may operate. Our success in military operations in the future, wherever or whenever they might be, will depend on how successful we are in this area.

—Secretary of the Air Force Dr Sheila J. Widnall

A common question, asked since the birth of airpower, is: Why is air superiority important? The answer lies in examining the purpose for the use of air forces. When the enemy is engaged in insurgency, without an organized air force, friendly air forces seek to minimize the fog of war through the use of reconnaissance and surveillance assets, limit the insurgent's freedom of action through interdiction, or reduce the enemy's ability to mount sustained operations through strategic attack. Successful prosecution of the counterair mission reduces the risk to friendly air and surface forces while increasing the risk to enemy operations. Suppression of enemy air defenses (even as simple as the shoulder-launched weapons that today are available to even the most rudimentary terrorist organization) becomes a deciding factor in the application of airpower.

Against a heavier, more conventional foe, enemy air forces (inhabited and uninhabited) become a threat to friendly forces—air, ground, and naval. In this instance, the more familiar notions of air superiority take over. The cycle comes full circle against a foe who can, but chooses not to use airpower, and instead employs cruise missiles, directed energy weapons, or more crude but equally effective measures such as radio frequency (RF) jammers or highly accurate antiaircraft artillery (AAA). In every instance, air superiority is essential.

While it may be true that in each case the success of the counterair mission may not be the sole deciding factor, it will at a minimum be the enabler that allows the success of the other elements of US military power to come to the fore. This alone is sufficient reason to examine the counterair mission in 2025.

Notes

¹ *New World Vistas* distinguishes between uninhabited reconnaissance aerial vehicles (URAV) and uninhabited combat aerial vehicles (UCAV) for combat and noncombat UAVs. See USAF Scientific Advisory Board, *New World Vistas: Air and Space Power for the 21st Century*, summary volume (Washington, D.C.: USAF Scientific Advisory Board, 15 December 1995), 8, 11.

Notes

² *Air Force Executive Guidance*, December 1995 update, 4.

³ Briefing, HQ USAF/LR to the Defense Science Board, subject: “Air and Space Power Framework for Strategy Development,” 19 March 1996.

Chapter 2

The Evolutionary Trajectory The Fighter Pilot—Here to Stay?

The most important thing to have is a flexible approach The truth is no one knows exactly what air fighting will be in the future. We can't say anything will stay as it is, but we also can't be sure the future will conform to particular theories, which so often, between the wars, have proved wrong.

—Brig Gen Robin Olds

The first trajectory evaluated is the *evolutionary trajectory*, an extrapolation of where the US is today. Assuming a world of continuing technological advancement, relatively constant US defense spending, and world players in the same relative positions of strength, air superiority and the counterair mission will be dominated by existing airframes and those already budgeted or in development. UAVs and space assets will augment these to accommodate smaller air forces relying on power projection from CONUS, aircraft carriers, and a select few major overseas bases.

If a man's trust is in a robot that will go around the earth of its own volition and utterly destroy even the largest cities on impact, he is still pitifully vulnerable to the enemy who appears on his doorstep, equipped and willing to cut his throat with a penknife, or beat him to death with a cobblestone. It is well to remember two things: no weapon is absolute, and the second of even greater import—no weapon, whose potential is once recognized as of any degree of value, ever becomes obsolete.

—J. M. Cameron

While uninhabited aerial vehicles will be widespread in 2025, the inhabited vehicle will be the backbone of air forces around the world. Space assets will have active and passive antiaircraft capabilities. Likewise, aircraft will have antisatellite active/passive capabilities. Multiple detection technologies will abound, with radar remaining as the primary active detection medium. Air-to-air/space-to-air/air-to-space

combat operations will be increasingly lethal. While the current generation of air-to-air missiles like the AIM 9, Python 4, and the advanced medium range air-to-air missile (AMRAAM) have demonstrated high probability of kill (P_k), in 2025 missiles will be even better—smaller, faster, and more accurate. The surface-to-air missiles (SAM) and space-based weapons (SBW) can also be expected to exhibit similar increases in lethality.

In spite of technological advances, dogfights likely will still occur in 2025. Fighters in 2025 will still have a “gun.” The lessons learned from development of the F-4 will still apply. In the 1950s the development of air-to-air missile technology negated the gun requirement for the F-4. By 1965 lessons learned in Vietnam necessitated a gun retrofit for the F-4C/D; the F-4E was designed with an internal gun. Every multirole fighter built or designed since, including the F-22, has included a gun. The counterair mission will require a variety of weapons to use against the entire spectrum of threats and available countermeasures. The gun will remain a lethal weapon when everything is electronically jammed or laser blinded.¹ This advanced gun may have the capability to fire solid projectiles and/or directed energy beams. Also, if history is any indicator, the multi-staged improvement (MSIP) F-22 will still be operational, and possibly upgraded versions of the F-15 as well.

Counterair Requirements

We're not in the business of being defensive when we engage. We want to take the fight to the other guy and we are going to dominate his airspace. We will operate in it, and he will not.

—Gen Ronald R. Fogleman

The aircraft force mix of 2025 will evolve from the current developmental programs, including the F-22 and derivatives, the joint strike fighter (JSF), and a number of UAVs, to both support inhabited vehicles and to operate independently. The F-22 derivatives may include a Wild Weasel platform that will be able to target both radio frequency(RF)-guided surface-to-air missiles (SAM) and directed energy antiaircraft weapons. UAVs will be used predominately to engage high-threat antiaircraft weapons and to provide active sensors for inhabited vehicles that will rely on passive sensors for the majority of their situational awareness.

Sensors and the data they provide will be widely distributed to provide maximum situational awareness. Fighter-mounted sensors should supply information to companion aircraft as often as they provide information to their bearer. Detection and identification probabilities will increase rapidly with sensor diversity and the false-alarm probability and error rates will decrease correspondingly. Uninhabited combat aerial vehicles (UCAV) should provide active sensors that work cooperatively with passive sensors on low observable (LO)-inhabited aircraft. Technologies such as high bandwidth, secure communication for satellite, and aircraft cross and downlink must be developed.

System Descriptions

The F-22 will be the only new fighter available to the US in the next decade. The joint strike fighter should appear after that to replace most current US fighter aircraft. By the time the F-22 and JSF appear, new technologies will be available to enhance their performance, but both aircraft are being designed using extant technologies. These aircraft will not produce a revolutionary change in the way air combat is waged. They represent an evolutionary change in the capabilities of aircraft. As 2025 comes to pass, the US will still have the requirement to control the air over enemy territory. This capability will come from the planned aircraft for the first part of the twenty-first century such as the F-22 and JSF, but also a whole new breed of uninhabited vehicles.

The twenty-first century, and the threats that accompany it, will require the capability to project airpower over a wide area of responsibility relative to today. This trajectory employs a mix of inhabited and uninhabited vehicles to accomplish the counterair mission. The inhabited vehicles will be a mix of upgraded F-22s and JSF aircraft. The uninhabited vehicles will be a whole new family of combat aircraft that will both support the inhabited vehicles and carry out some missions autonomously. If technologies develop as some believe, the concept of a “FotoFighter” as discussed in *New World Vistas* could be a reality in small numbers, or as a prototype. These aircraft would use large arrays of diode lasers to communicate, designate, and execute thermal kills of targets.²

Both inhabited and uninhabited vehicles will have a requirement to detect, identify, and target all types of airborne targets. This will require a combination of improved situational awareness, sensor capability,

and lethal weapons. Significant effort will be required to expand beyond the current sensor suites forecast to allow the pilot to correctly identify threats, even if they are stealthy and their sensors are not actively emitting. This capability will increase survivability when outnumbered in future air battles.

Situational Awareness

The cockpit in 2025 should be linked to virtually every available source with high-bandwidth communications to ensure the highest degree of situational awareness.³ Satellite surveillance networks, sea-based and land-based sites, and mobile platforms in the air and on the battlefield will play vital roles in providing the uplink and downlink of targeting information, individual engagement status, and battle space management directly to the operator.⁴

Onboard computers will correlate all information and display it to the aircrew in a helmet-mounted display (HMD) (fig. 2-1).⁵ Visual presentations will also be displayed using long-range reconnaissance platforms and missile status uplinks. Cockpits will be fully compatible with night and all-weather operations. Fighter-mounted sensors will provide updates to companion aircraft (and vice versa) as often as they provide updates to their bearer.⁶



Source: <http://www.thomson.com:9966/janes/jpict1.html>, Geoff Fowler Media Graphics © 1995.

Figure 2-1. 360-Degree Helmet-Mounted Display

Detection and Acquisition

Airborne detection of adversary aircraft will be increasingly easy in 2025. Cutting edge technology in 1996 will be commonly available and widely dispersed. Effective airpower hinges on early detection and employment of weapons. Detection techniques will incorporate high-confidence, real-time situational awareness (SA) with highly diversified, multisensor detection capabilities and very lethal air-to-air weapons to ensure first launch, first kill and survivability of the launching platform.⁷

It is imperative that target detection and acquisition (hereafter jointly referred to as targeting) occur at the longest possible ranges. Identification of the detected vehicles at the earliest possible time will be

critical to survival of the launching platform. Precision targeting will be possible using linked information from both surveillance and reconnaissance satellites and early warning aircraft correlated to that from onboard sensors.⁸ Laser detection and ranging (LADAR), coupled with advanced Global Positioning System (GPS) inputs, will provide the longest range detection probability in clear air mass.⁹ Radar of one form or another will still provide the longest range detection in adverse weather. Artificial intelligence will aid the aircrew by filtering through and sorting a plethora of linked information on possible targets.¹⁰

Weapons

To take advantage of complete SA, as well as first detection and acquisition, airborne weapons must be flexible, long-range, smart, and extremely lethal in all quadrants. Only a single type of air-to-air missile, possessing the capabilities necessary to ensure destruction of adversary aircraft, is necessary. The missile must be common to all US armed forces, with ordnance personnel from any service able to perform necessary maintenance. The endearing feature of this missile will be its ability, once launched, to perform the entire intercept independent of the launching platform.

Prelaunch information will be input to the missile, either from the aircraft or from external sensors, at increased speeds, proportional to an increased onboard computability. Postlaunch updates, if necessary, will be a combination of inputs from the launch platform and/or the same targeting sensors linked to the aircraft via secure low probability of intercept (LPI) datalink. Conversely, missile status will be linked from the weapon to targeting sensors and the launching platform throughout the engagement, including endgame battle damage assessment (BDA) to enhance SA.¹¹

At launch input, the weapon will compute an intercept trajectory and fall from the aircraft. Using reactive jets, the missile will turn to the correct heading and then begin the boost phase of flight. Active detection capability inherent in the missile will compare data to all available outside sources to ensure precision intercept to the correct target. Autonomous target acquisition will occur and advanced guidance laws, coupled with guidance integrated fuzing, will assure intercept and kill. Postlaunch missile-to-cockpit status will allow the aircrew to determine subsequent courses of action regarding the target in question.¹²

Dependent upon the range to target at launch, the missile will move from the boosted phase flight to a sustained flight stage. Optimum altitude and speed for the missile will be computed based on target data.¹³ This will give the missile the greatest potential flexibility during midcourse and terminal phases.

Precision GPS-derived location will be a primary guidance source during the weapon's entire time of flight. During the terminal phase of the intercept, the missile will incorporate the GPS guidance with precision onboard targeting technology to effect missile-target intercept. Terminal tracking and guidance may employ a combination of LADAR, infrared (IR), magnetic anomaly detection (MAD), jet engine modulation (JEM), photographic, and acoustic sensors, dependent upon weather and atmospheric conditions.¹⁴ It is important to note that we expect that multimode seekers will be required based on expected countermeasure proliferation. Multiple warhead missiles will be possible with guidance to each warhead in the terminal phase.¹⁵

Countermeasures and Countercountermeasures

Survival in a hostile integrated air defense system will be essential. Survival will depend on avoiding detection to accentuate the advantage of surprise in a tactical environment. Enemy detection capabilities will have increased to the point where both active and passive stealth techniques will be necessary. Other countermeasures should include both expendable and nonexpendables, as well as redundancy and reconfigurability of the air vehicle. Expendable countermeasures will include micro-UAVs that actively engage inbound threats to the vehicle it is protecting. If the vehicle is detected, it will have to recognize that detection and then be able to precisely locate and identify what has detected it so that that sensor can be deceived, jammed, or targeted.¹⁶

Enabling Technologies

Active radio frequency and passive infrared stealth capabilities will be the highest payoff technology development for the evolutionary trajectory.¹⁷ Active stealth capability should allow the US to develop techniques that will provide survivability and lethality to more platforms. The expense of developing

passive stealth beyond current capabilities will increase exponentially but will not provide backwards compatibility to older platforms that active techniques might provide. Some of the active stealth concepts developed might include active cloaking film using nanotechnology-based film of micro-robots that vary their color and reflectivity to make an object “invisible” and “paint” with electro-optic materials that adopt a range of colors depending on the voltage applied.¹⁸ These materials could be used to effectively provide active stealth in a particular bandwidth. No single system is envisioned which could provide a cloaking capability across the electromagnetic spectrum.

The fusion of multispectral sensors from different platforms will provide the next leap of capability in 2025 (fig. 2-2). Air vehicles will require the exploitation of offboard information using a high-bandwidth, secure datalink to increase SA and allow real-time targeting. Sharing of the offboard information will be enhanced by artificial intelligence based cooperation and distribution of mission responsibilities between platforms.¹⁹ A distributed satellite system for surveillance and datalink to aircraft will allow the information to be shared throughout the theater of operations, providing real-time command and control.²⁰

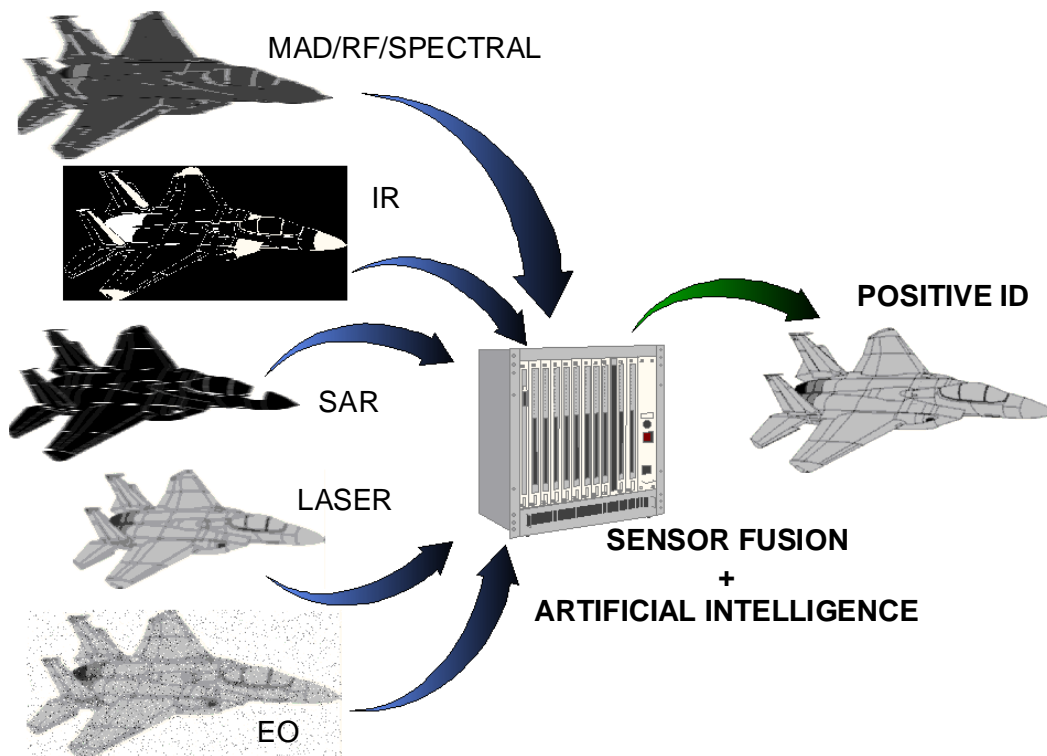

Clipart elements from Federal ClipArt © 1995 with courtesy from One Mile Up, Inc., and Microsoft Clipart Gallery © 1995 with courtesy from Microsoft Corp.

Figure 2-2. Sensor Fusion and Target ID

It is essential that the sensor technology continue to be developed to provide capability against a growing countermeasure proliferation. These technologies include integrated sensors and conformal apertures with open system architectures, cooperative and distributed electronically scanned arrays, and multispectral, multimode seeker heads.²¹

Advanced identification friend or foe (IFF) capability will need to be developed to allow adversary platforms to be targeted with confidence at long range for survivability of the launch platform. Problems exist in current IFF systems that prevent long-range launch of long- and medium-range weapons at optimum ranges. These must be overcome to both negate the possibilities for fratricide and allow effective use of longer range weapons. One option could include the use of LADAR IFF. LADAR would provide 3-D mapping of the target to perform identification (ID).²² The use of sensor fusion across platforms will also help in this endeavor.

After adversary platforms have been detected and identified, the platforms have to be neutralized as a threat. It is imperative that weapons technologies remain lethal in an environment of increasingly sophisticated countermeasures. Advanced munitions and missiles with multispectral and multimode seeker heads will be a necessity. Warhead development that includes nonlethal high-power microwaves will provide the capability to destroy or neutralize the electronics of targeted aircraft or systems.

Concept of Operations

Air superiority fighters will operate in conjunction with UAVs using active sensors and/or weapons appropriate to the mission and will communicate through a worldwide communications data network. A worldwide joint tactical information display system (JTIDS) will provide high-resolution data to both the commanders and the aircraft actually in combat. Space systems will provide the surveillance picture to the network. The artificial intelligence (AI) capability in the aircraft and drones will use both onboard and offboard inputs to give recommendations for tasks such as targeting, a-pole, and ordnance selection.²³ This worldwide data network will result in a flattened hierarchy for command and control. The potential threats and the mission to be accomplished will determine the mix of inhabited and UAVs in a force package.

Once the inhabited fighters and UCAVs have established their defensive combat air patrol (CAP) or offensive sweep, they will use a combination of onboard active and passive sensors and the available data linked information to search their area of responsibility. The AI software in the avionics will fuse the data from multiple sensors, both on and offboard the vehicle, to detect and identify air vehicles (bombers, fighters, cruise missiles, etc.) and develop situational awareness displays for the pilots of the fighters or UCAVs. The decision to engage or avoid the threats will be made and communicated directly to the entire chain of command via the JTIDS link.

If the decision to engage is made, the fighter (or UCAV) will attempt to employ weapons at maximum range to increase survivability. The weapon employed will depend on the current weather conditions and countermeasures employed by the adversary. Ideally, a directed-energy weapon from a FotoFighter could be employed against numerous threats in a very small time period. Since the F-22 and JSF fighters will still be limited to missiles previously discussed in this chapter, the engagement may occur at closer ranges due to late identification of the threat or because longer range weapons may be defeated by countermeasures. Very strict rules of engagement (ROE) could also lead to close-in visual engagements. In either case, the requirement for a close-range weapon appears inescapable. The weapons employed at close range could vary from high power microwave (HPM) to “bullets” from an advanced gun.

Once the engagement is finished, the fighters will return to their assigned area of responsibility or refuel to continue the mission. If the mission objective has been achieved, or if fuel and weapons are not sufficient to continue, the fighters and the UCAVs will return to base. The results of the engagements and significant intelligence information will be passed through data link to update the command and control system. This type scenario will be played again with multiple flights of air vehicles, both inhabited and uninhabited, throughout the area of responsibility for the particular joint force aerospace component commander (JFACC). The force mix and tactics involved will be determined by the mission objective and the perceived threat.

Summary

The capability described above is based on the assumptions that technological advancement between now and 2025 will be evolutionary, and that inhabited vehicles are the dominant means of maintaining air

superiority. Since the advent of the counterair mission, we have seen under what circumstances conventional air forces will prevail—typically when the adversary presents a similar capability, such as World War II, Korea, or the Gulf War. There have also been situations, such as in Rwanda or Somalia, where counterair capabilities have played a lesser role. From this it can be concluded that evolutionary counterair capabilities are best suited to a peer or regional competitor, vice a niche competitor during an insurgency or guerrilla war. This is primarily because conventional counterair forces, as we know them today, have limited nonlethal capabilities. An additional limitation is the fragility of inhabited aircraft systems. The high cost of individual airframes, the cost of training pilots, and the requirement for forward basing in a potential threat area may make the American public too risk-averse to the employment of airpower under even the most compelling circumstances.

However, these are more than counterbalanced by the feasibility of these systems; and survivability of these systems will increase as more complex countermeasures are employed. The passive stealth features of the F-22 and JSF will be a significant improvement over the F-117. The next generation of active countermeasures need not be tied to the airframe technology. Indeed, as nanovehicles become the norm, they will find increasing use providing countermeasures in a hostile air-to-air environment. UAVs could also provide an active countermeasures screen to allow inhabited vehicles with passive countermeasures to penetrate enemy air defenses and engage enemy air forces directly. Upgrades to the present airborne laser program will support the targeting of smaller, more advanced counterair threats such as ballistic and cruise missiles.

Finally, one of the most important reasons for maintaining inhabited air forces will be accountability. In 2025, many of the competitors the US is likely to face will be regional competitors, whose inventories will be little different from what they have today.²⁴ In circumstances where the nature, or more likely the intent, of enemy air forces is not known, a higher level of fidelity—that provided by the pilot—will be necessary to discern the true air threat to the US or its allies. The situational response to many of the circumstances involving a regional or niche adversary in 2025 requires the hands-on accountability that is only possible with inhabited aircraft. In addition, most high-technology weapons such as lasers or HPM, are not recallable; once engaged, the target is permanently affected to the degree the engagement has progressed before it is terminated. There will also be situations where strict ROE demands a pilot on-scene to make a

real-time determination of the actual threat presented. The international political and practical ramifications of an accidental shutdown by uninhabited US systems of either nonbelligerents, or enemy forces whose intent was in question would be significant; it would probably dwarf the response of the international community to situations such as the shutdown of civilian aircraft by the Cuban air force in February 1996. The bottom line is that warfare is still an engagement between two reactive entities, and the instincts and finesse of the pilot will be required to gauge the situation, either to defend the US or prevent an international incident.

Notes

¹ David R. Mets, *Checking Six Is Not Enough: The Evolution and Future of Air Superiority Armament*, CADRE Paper Special Series: The Future of the Air Force, no. AU-ARI-CPSS-91-14 (Maxwell AFB, Ala.: Air University Press, April 1992), 34.

² USAF Scientific Advisory Board, *New World Vistas: Air and Space Power for the 21st Century* (unpublished draft, the directed energy volume, 15 December 1995), viii.

³ 2025 concept, no. 900619, "Panoramic Night Vision Goggles," 2025 concepts database (Maxwell AFB, Ala.: Air War College/2025, 1996).

⁴ Headquarters Air Force Materiel Command, *FY96 Avionics Technology Area Plan*, 1995, 18.

⁵ 2025 concept, no. 900365, "Sensor Cockpit," 2025 concepts database (Maxwell AFB, Ala.: Air War College/2025, 1996).

⁶ USAF Scientific Advisory Board, *New World Vistas: Air and Space Power for the 21st Century*, summary volume (Washington, D.C.: USAF Scientific Advisory Board, 15 December 1995), 11.

⁷ 2025 concepts, no. 900202, "Space-based Special Operations Forces," no. 900317, "Tactical Information Display Helmet," and no. 900364, "Bionic Eye," 2025 concepts database (Maxwell AFB, Ala.: Air War College/2025, 1996).

⁸ *New World Vistas*, summary volume, 20.

⁹ 2025 concept, no. 200014, "Molecular Inertial Navigation Sensor," 2025 concepts database (Maxwell AFB, Ala.: Air War College/2025, 1996).

¹⁰ *FY96 Avionics Technology Area Plan*, 18-19.

¹¹ 2025 concepts, no. 900405, "Weapon Health Monitoring" and no. 900675, "Ordnance Enroute Reporting," 2025 concepts database (Maxwell AFB, Ala.: Air War College/2025, 1996).

¹² Ibid.

¹³ 2025 concepts, no. 900359, "Air-to-Air Missile Interdiction," no. 900554, "Adaptive Munitions," and no. 900555, "Sensor-to-warhead Operations," 2025 concepts database (Maxwell AFB, Ala.: Air War College/2025, 1996).

¹⁴ 2025 concepts, no. 900211, "LADAR Identification Friend or Foe," no. 900508, "Magnetic Detection of Aircraft," no. 900239, "Space-based Missiles with Photo Warheads," and no. 900392, "Acoustic Weapon," 2025 concepts database (Maxwell AFB, Ala.: Air War College/2025, 1996); *FY96 Conventional Weapons Technology Area Plan*, Headquarters Air Force Materiel Command, 1995, 7.

¹⁵ 2025 concepts, no. 900288, "Swarms of Micro-Machines" and no. 900676, "Defense of Missile-Delivered, Multiple Conventional Warheads," 2025 concepts database (Maxwell AFB, Ala.: Air War College/2025, 1996).

Notes

¹⁶ *FY96 Avionics Technology Area Plan*, 11-13.

¹⁷ *New World Vistas*, summary volume, 60.

¹⁸ 2025 concepts, no. 900605, "Active Cloaking Film/Paint" and no. 900573, "Dielectric Materials For Stealth," 2025 concepts database (Maxwell AFB, Ala.: Air War College/2025, 1996).

¹⁹ "Cooperative Air-to-Air/Air-to-Ground Engagements-Distributive Fire Control," *Technology Initiatives Game 95 (Systems Handbook)*, 18-22 September 1995, 20-1.

²⁰ *New World Vistas*, summary volume, 20, 43.

²¹ "Cooperative ESA Jamming," *Technology Initiatives Game 95 (Systems Handbook)*, 18-22 September 1995, 21-1.

²² 2025 concept, no. 900211, "LADAR Identification Friend or Foe," 2025 concepts database (Maxwell AFB, Ala.: Air War College/2025, 1996).

²³ 2025 concept, no. 900414, "Artificial Intelligence: A New Aircrew Member in Tomorrow's Combat" and no. 900550, "Personal Digital Assistant," 2025 concepts database (Maxwell AFB, Ala.: Air War College/2025, 1996).

²⁴ Col Jeffery R. Barnett, *Future War: An Assessment of Aerospace Campaigns in 2010* (Maxwell AFB, Ala.: Air University Press, January 1996), 94.

Chapter 3

The Penurious Robophile Trajectory Pilots—the Rarest Breed

Why can't they buy just one airplane and take turns flying it?

—Calvin Coolidge

No system exists which can provide continuous all-weather coverage of worldwide targets To meet the above requirements, the Joint Staff has identified an urgent need for the capability of an Endurance Unmanned Aerial Vehicle (UAV) System.

—Dr John M. Deutch,
Under Secretary of Defense
(Acquisition and Technology)
July 1993

The road to 2025 may be sown with domestic strife and the propensity for the US to look inwards at its own problems. If so, US interest in world issues and debates would be greatly reduced, while concern for threats to US security from foreign countries or groups would be only as real as the threat. The same domestic problems driving this inward emphasis would drive consistently low defense budgets and interest. Technology would continue its near exponential rate of climb, but with an emphasis on domestic uses. The successful use of UAVs in the Gulf War in 1991 and in Bosnia in 1995–96 might motivate the US to accelerate the development of more advanced, multipurpose UAVs.¹ This technology offers more potential for weapon system performance at apparently lower costs. At the same time, UAVs “serendipitously accommodate the probable inexorable trend of American society who are more and more expecting no losses during US military operations.”²

Although defense budgets and interest by the average citizen may be low, technologies applied to commercial communications and other areas such as electronics and materials would migrate to military

applications as a leverage against lower budgets. Sensors and propulsion systems would continue to improve at similar rates. A more advanced and jam resistant Global Positioning System (GPS) constellation might replace the stage 2R satellites deployed between 2000–2010.³ The level and sophistication of enemy air defenses might grow with technological advances to the point where inhabited systems must accept much higher risks for missions over enemy territory. At the same time, the cost of survivable inhabited systems would grow exponentially, making the development and fielding of these systems economically impossible.⁴ In such a world, the joint service Defense Airborne Reconnaissance Office (DARO), formed in 1993 to manage the UAV program, not only survives early budget challenges and interservice rivalries, but grows in scope and responsibility.⁵ By the year 2010, DARO might be responsible for the development of all UAV systems regardless of mission. In an effort to maximize smaller defense budgets and maintain consistency with the unsupportable expense of inhabited weapon systems and the sophistication of air defenses, civilian and enlisted pilots are recruited to “fly” the uninhabited air forces of 2025.⁶ A fleet of multipurpose UAVs would then replace the aging fleet of F-15s. The F-22, joint strike fighter, and other proposed inhabited fighter and attack aircraft programs would all be canceled due to escalating development costs and the public perception of no real threat. Support and airlift aircraft, maintaining orbits far from potential air defenses, are available for the launch, retrieval, and rearming of UAVs. In the world of 2025, the fighter pilot of old is indeed rare.

Counterair Requirements

As mentioned previously, enemy air defenses have grown more sophisticated with technology. This requires the ability to detect, locate, identify, engage, and destroy fixed and mobile surface and air targets anywhere in the world on short notice. A limited overseas presence and a complex political environment demand power projection with greater precision, less risk, and more effectiveness.⁷ Therefore, the uninhabited counterair force of 2025 must have the ability to deploy from CONUS, strike a target anywhere in the world, and return to a friendly base in CONUS, in the air, or at sea. These operations require a mix of autonomous and controlled flight missions. Finally, nontraditional defenses against aircraft, like high-powered microwaves, and an increased air-breathing threat, especially cruise missiles, will put a premium

on a counterair force mix capable of meeting both the offensive and defensive counterair requirements of 2025.

System Descriptions

The UAV force mix of 2025 evolves from development efforts in the late 1980s and early 1990s, and draws on the combat experience of Bosnia in 1995–96. Stealthy, high- flying, very long-range systems use modular sensor and weapon bays and air or surface launch and recovery for optimal mission flexibility. The Tier 2 Predator, Tier 2 Plus, and Tier 3 DarkStar UAVs fielded in the 1990s were the first systems to demonstrate high- altitude, long-range, and stealth capabilities, respectively, using commercial off-the-shelf (COTS) and government off-the-shelf (GOTS) technology.⁸ The counterair system of 2025 combines the attributes of each of these systems into a single, stealthy system capable of unrefueled global range and the ability to operate from low, terrain-following altitudes to altitudes over 100,000 feet. The multipurpose UAV of 2025 has an advanced turbofan engine, is structured almost entirely of composites, and has a minimum payload of 2,000 pounds.⁹ If technology development permits, a UAV capable of transitioning from air-breathing propulsion to hypersonic capability and back again provides even longer range, higher altitude, more rapid reaction, double digit mach speed, and the enhanced survivability derived from these advancements.¹⁰ Advances in materials and sensors provide for embedded sensors (smart skins) for 360-degree awareness and communications.¹¹ Reconfigurable control surfaces (smart structures) optimize range and performance while minimizing radar cross section.¹²

In addition, active stealth systems will eliminate other detection vulnerabilities.¹³ Increasing maneuverability beyond human tolerance, plus or minus 12 Gs or more, enhances survivability; increasing to plus 20 to 40 Gs greatly enhances missile avoidance in the end game.¹⁴ In addition, advanced defensive avionics use active and passive systems, including mini-UAV decoys and other expendables.¹⁵ Modular sensor suites and weapon bays provide snap-in and snap-out mission customization, keeping unit fly- away cost for the basic air vehicle to the equivalent of today's cost of \$10 million.¹⁶

Applications

In the year 2025, intelligent signal and data processing and secure, redundant data links for control and intervehicle information sharing are standard.¹⁷ The multipurpose UAV will employ the latest synthetic aperture radar (SAR), bistatic radar, infrared (IR) and electro-optical (EO) target tracking capability, target illuminators, and jam resistant, low probability of intercept (LPI) communications and data links to perform any of the envisioned counterair missions.¹⁸

The air tasking order (ATO) of 2025 will be automatically deconflicted by using surface, air, and space-based sensors to provide a synergistic effect for netted systems. Advances in artificial intelligence, computing speed, and secure communications links will make real-time ATO deconfliction and tasking a reality.¹⁹ The joint forces commander of 2025 will display situational awareness and battle management information in the holographic war room with the assistance of UAVs while directing other UAVs to fight the counterair battle.

Weapons

The multipurpose UAV will employ the latest in advanced weapons for air-to-air and air-to-ground attack. The advent of very small, very smart bombs and missiles will optimize payload capacity.²⁰ Explosives with 10 times the destructive force for the same weight will make these sorties 10 times more effective than today.²¹ Advanced GPS receivers embedded in individual powered or unpowered weapons provide fire-and-forget capability without the need for laser illumination from other platforms or sources.²² Smart fuses will enhance hard target kill, while the launch UAV or another UAV in the mission package provides real-time BDA via satellite uplink.²³ Advanced air-to-air weapons will use vectored thrust for optimal turn performance. Distributed satellites and advanced GPS provide worldwide, jam-resistant, low probability of intercept command, control, communications, navigation, and pinpoint weapons delivery and target acquisition.²⁴

Continuing developments of microelectromechanical systems (MEMS) and potential developments in nanotechnology could provide an entirely new family of microminiature, intelligent weapons. Swarms of microminiature weapons could disable or destroy air or surface targets in support of the counterair mission.

Intelligent materials systems, built at the atomic level by precisely placing each atom and molecule, could be powered by light for near limitless range and undetectable size. Inertial guidance systems, sensors and associated actuators, and their control by neural networked microprocessors could all be microsized through the application of MEMS and nanotechnology. Microminiature weapons could be aided by swarms of similarly sized intelligence, surveillance, and reconnaissance (ISR) systems. Swarms of microminiature weapons and sensor platforms could be launched by very small UAVs if the MEMS and nanotechnology development continues at its present rate.²⁵ The multipurpose UAV weapon system can perform a totally autonomous air-to-air or air-to-ground mission and, through advanced GPS guidance and preprogrammed mission parameters, can act in intelligent coordination with other UAVs or be remotely controlled from air, land, or sea bases by the ground pilot of 2025 (fig 3-1).²⁶



Source: <http://www.afit.af.mil/Schools/PA/gall3.htm>, courtesy of Gene Lehman, AFIT/LSEC.

Figure 3-1. Representation of UAV Ground Cockpit

The increasing threat to air vehicles will also be countered by the introduction of the FotoFighter into the inventory. The FotoFighter will use low observable technology coupled with conformal arrays of phased high-power solid-state diode lasers to provide simultaneous surveillance, tracking, designation, and thermal kill of targets, as well as communications.²⁷ The FotoFighter could form the backbone of the air strike capability, since it would be designed to be capable of high speed and maneuverability (hypersonic speeds and ± 20 G capability) increasing its survivability; removal of the pilot would also increase opportunities for signature suppression.²⁸

Countermeasures and Countercountermeasures

Wideband radars and multispectral detection systems will challenge the capability of the multipurpose UAV force to survive in hostile airspace. Active and passive stealth capabilities, low and high-altitude operation, and low subsonic to hypersonic speeds will complicate detection by even the most advanced radars or other systems.

These capabilities provide survivability against surface and airborne threats. The camouflage, concealment, and deception of surface targets will complicate the surface attack portion of the offensive counterair mission. These factors will be offset by using wideband SAR systems, advanced IR detection from other UAVs and space assets, and the overall sensor synergism from surface, air, and space assets.

Enabling Technologies

Target detection and identification will require advanced GPS and distributed satellites, along with artificial intelligence-based cooperation and distribution of mission responsibilities between platforms.²⁹ Cooperative and distributed electronically scanned arrays will support interaction between strike platforms and optimize targeting.³⁰

The key to successful implementation of UAV technology will be in active radio frequency and passive infrared (IR) stealth.³¹ The aircraft itself must be constructed of high strength, lightweight, and reconfigurable materials.³² To maintain on-orbit times and increase endurance, UAVs will use advanced

fuels for lower specific fuel consumption and better all-altitude performance.³³ Hypersonic propulsion systems are needed to cope with the dense threat to air vehicles due to state-of-the-art air-to-air and surface-to-air missiles.³⁴ Part of the job will be to track friendlies, requiring advances in identification friend or foe (IFF) capability.³⁵ Detecting and tracking enemy aircraft means improvements are required in modular integrated avionics, including a downsized and wideband SAR.³⁶ Finally, the high speeds and maneuverability of these systems will dictate advanced munitions and air-to-air missiles.³⁷ MEMS and nanotechnology could provide an exponential leap in microminiaturization for both weapons and platforms. To support the counterair mission in the high-speed, short-time-horizon battle space of 2025, mission planning and execution will require dynamic planning and execution control a la *New World Vistas*.³⁸

Concept of Operations

Multipurpose UAVs armed with sensors and/or weapons appropriate to the mission act in conjunction with surface, airborne, and space-based assets. The modular sensor and weapon bays discussed above provide mission planners the ability to mix and match components for optimal performance against the threat and targets. Potential threats and the mission to be accomplished determine the number and configuration of UAVs in a given mission package—threat detection, threat negation, active and passive decoys, sensor or communications relay, or armed for the defensive or offensive counterair mission. The FotoFighter would provide a unique quick strike capability against counterair targets of opportunity presented by short dwell targets such as missiles, missile launchers, or other hypersonic threat aircraft (fig. 3-2).

The UAV mission package is then launched from CONUS bases or airborne or sea-based platforms described above. This force package will use such air- and space-based assets as GPS and satellite communication links for autonomous operation over long distances and for terminal remote control if desired. Regardless of the mission, offensive or defensive counterair, armed UAVs will suppress enemy air defenses as necessary, destroy enemy aircraft and other systems in the air or on the surface, and return to CONUS bases or other platforms for refueling, rearming, and retasking.³⁹ At the same time, other UAVs operating

independently or as part of the overall mission package identify and illuminate targets or threats for the strike UAVs, act as communications or data links, and provide real-time BDA.

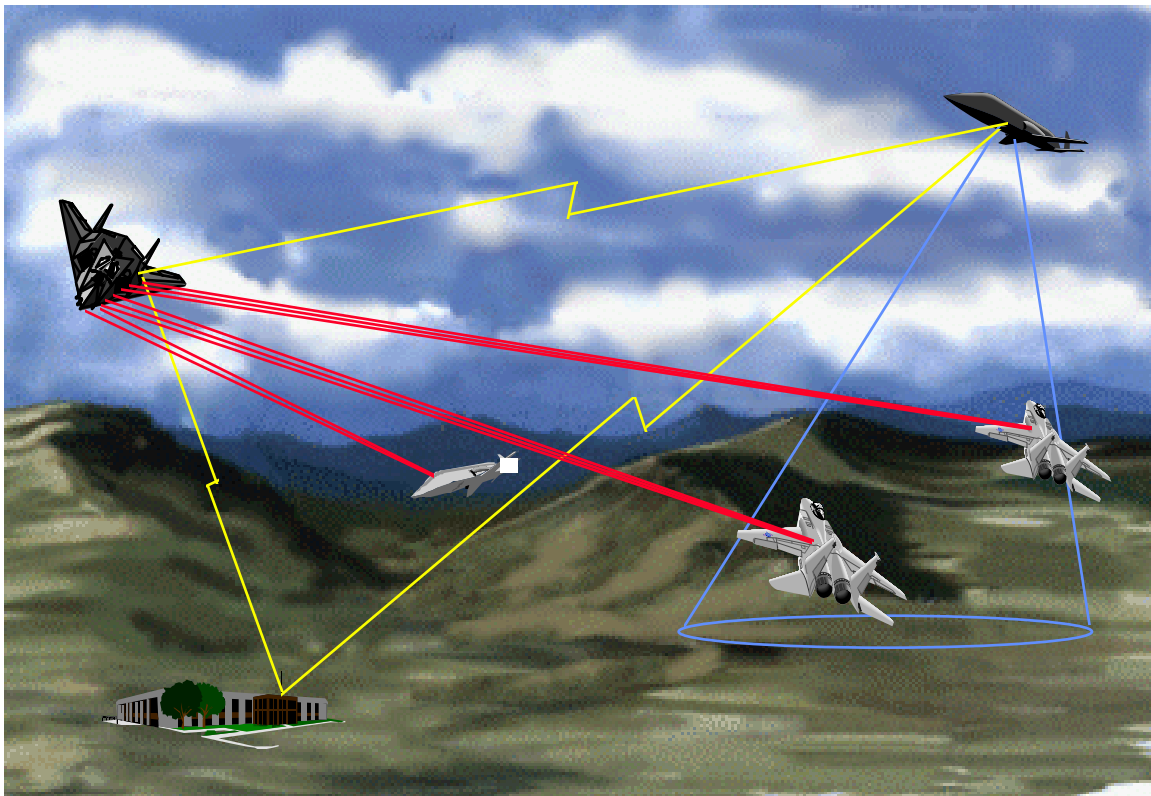

Clipart elements from Federal ClipArt © 1995 with courtesy from One Mile Up, Inc., and Microsoft Clipart Gallery © 1995 with courtesy from Microsoft Corp.

Figure 3-2. UCAV Strike Fighter (FotoFighter)

The systems, technologies, and concept of operations described here provide the joint forces commander of 2025 with a multipurpose, long-range, lethal, and hard-to-detect and hard-to-kill autonomous weapon system or force package. Multipurpose UAVs accomplish the counterair mission of 2025 more efficiently and effectively, without risking the lives of pilots.

Summary

As the US continues to attempt to do more with less, it becomes more and more likely the US will turn to UAVs to perform many of the missions requiring inhabited aircraft today. The counterair mission will be no exception. As described in this chapter, there is an opportunity to perform the entire counterair mission using UAVs. The current characteristics of UAVs—range, adaptability, and loiter time—when coupled with

advances that will yield hypersonic strike capabilities, will allow the employment of UAVs in any environment against any type of adversary, from low-tech adversaries to peer competitors using stealthy cruise missiles or F-22 equivalents.

UAVs are even now coming of age, and decreased development, production, training, and replacement costs make them an attractive alternative to inhabited aircraft. In addition, the modular nature of much of our UAV fleet will allow tailoring of vehicles for specific missions, including air-to-ground counter-C2, SEAD, and conventional air-to-air against low-tech second wave air forces, as well as advanced fighter capabilities of peer adversaries. The FotoFighter, in particular, presents a significant leap in capability likely to be available in 2025. The addition of directed-energy weapons of variable lethality will be a considerable advance over the selectivity of current armaments for close-in and medium range-engagements. The flexibility and increased speed of hypersonic uninhabited strike aircraft will also allow these vehicles to avoid surface-to-air threats as simple as small arms and stinger missiles. This decreases the fragility of our counterair capability while enhancing survivability. Whether based in CONUS or on carriers, these assets can respond on demand, arriving on station in any AOR within hours, ready to conduct the mission without crew rest or prebriefing—the ground pilots having completed these activities while the UAV is en route to target. Once on station, trained ground pilots will assume control of the aircraft, allowing a level of fidelity near that achievable with pilots on-scene, increasing the flexibility of response.

The most difficult challenge will be to develop the technology required to support the strike UAV—the FotoFighter or its equivalent. In addition, to achieve the fidelity required to match a pilot on-scene, allowing the ground pilot to feel as if they are flying the mission will require significant advances. CONUS basing may also pose some challenges to situations that require a more immediate response; deployed UAV carriers would enhance responsiveness in crisis scenarios. Recovery and replenishment will require special attention, but some armament limitations may be overcome by the use of rechargeable DE weapons or nanoweapons. Even as the first of many UAV squadrons becomes operational, it is clear the enhanced capability and flexibility UAVs provide at lower overall risk and cost will drive the US towards an increased use of UAVs in the conducting the counterair mission.

Notes

¹ Lt Col Dana A. Longino, *Role of Unmanned Aerial Vehicles in Future Armed Conflict Scenarios* (Maxwell AFB, Ala.: Air University Press, December 1994), 9-12.

² USAF Scientific Advisory Board, *New World Vistas: Air and Space Power for the 21st Century*, summary volume (Washington, D.C.: USAF Scientific Advisory Board, 15 December 1995), 60.

³ “New GPS 2R Satellites to Operate Autonomously,” *Aviation Week & Space Technology*, 9 October 1995, 54; *New World Vistas*, summary volume, 25.

⁴ Martin L. van Creveld, *The Transformation of War* (New York: The Free Press, 1991), 208–209.

⁵ Bill Sweetman, “Major Milestones in US UAV Programme,” *Interavia*, July/August 1995, 39–40; Bill Sweetman, “UAVs for Joint Forces,” *Interavia*, September 1994, 62–64.

⁶ David A. Fulghum, “Air Force Prepares New UAV Acquisitions, Operations,” *Aviation Week & Space Technology*, 27 November 1995, 52–54.

⁷ Defense Airborne Reconnaissance Office, *1995 Annual Report: Unmanned Aerial Vehicles (UAVs)*, (Washington, D.C.: Office of the Under Secretary of Defense, Acquisition & Technology, August 1995), 6.

⁸ *Ibid.*, 20–25; Bill Sweetman, “Major Milestones in US UAV Programme,” *Interavia*, July/August 1995, 39–40; “UAV Force Concept,” *Aviation Week & Space Technology*, 10 July 1995, 42–43.

⁹ David A. Fulghum, “International Market Eyes Endurance UAVs,” *Aviation Week & Space Technology*, 10 July 1995, 40–43; Bill Sweetman, “Major Milestones”, 39–40.

¹⁰ *New World Vistas*, summary volume, 41.

¹¹ 2025 concept, no. 900441, “The Uninhabited United States Air Force,” 2025 concepts database (Maxwell AFB, Ala.: Air War College/2025, 1996).

¹² 2025 concept, no. 900777, “Smart Structure Aircraft,” 2025 concepts database (Maxwell AFB, Ala.: Air War College/2025, 1996).

¹³ *New World Vistas*, summary volume, 36.

¹⁴ *New World Vistas*, summary volume, 35; 2025 concept, no. 900135, “Offensive Unmanned Aerial Vehicle,” 2025 concepts database (Maxwell AFB, Ala.: Air War College/2025, 1996); “Unmanned Tactical Aircraft Concept,” *Technology Initiative Game 95 (Systems Handbook)*, 18–22 September 1995, 9–1, 9–2.

¹⁵ 2025 concept, no. 900172, “Miniature Precision Targeting UAV,” 2025 concepts database (Maxwell AFB, Ala.: Air War College/2025, 1996).

¹⁶ Defense Airborne Reconnaissance Office, 40; David A. Fulghum, “International Market Eyes Endurance UAVs,” *Aviation Week & Space Technology*, 10 July 1995, 40–43; 2025 concept, no. 900299, “Hunter-Killer Attack Platform,” 2025 concepts database (Maxwell AFB, Ala.: Air War College/2025, 1996); Bill Sweetman, “Major Milestones”, 39–40.

¹⁷ *New World Vistas*, summary volume, 60.

¹⁸ 2025 concept, no. 900135, “Offensive Unmanned Aerial Vehicle,” 2025 concepts database (Maxwell AFB, Ala.: Air War College/2025, 1996); 2025 concept, no. 200006, “Unmanned Airborne Support Vehicle,” 2025 concepts database (Maxwell AFB, Ala.: Air War College/2025, 1996) (PROPRIETARY); 2025 concept, no. 900500, “Unmanned Fighter Bomber,” 2025 concepts database (Maxwell AFB, Ala.: Air War College/2025, 1996).

¹⁹ 2025 concept, no. 900526, “Space-Based Airspace Control & Deconfliction System,” 2025 concepts database (Maxwell AFB, Ala.: Air War College/2025, 1996).

²⁰ “GPS Improves Military Weapons,” *Aviation Week & Space Technology*, 9 October 1995, 56–57; 2025 concept, no. 900528, “Stealthy Lethal UAV,” 2025 concepts database (Maxwell AFB, Ala.: Air War College/2025, 1996); 2025 concept, no. 900233, “The Very Small, Very Smart Bomb,” 2025 concepts database (Maxwell AFB, Ala.: Air War College/2025, 1996).

Notes

²¹ *New World Vistas*, summary volume, 9; 2025 concept, no. 900233, “The Very Small, Very Smart Bomb,” 2025 concepts database (Maxwell AFB, Ala.: Air War College/2025, 1996).

²² 2025 concept, no. 900638, “Autonomous Smart Bombs,” 2025 concepts database (Maxwell AFB, Ala.: Air War College/2025, 1996); 2025 concept, no. 900244, “Global Positioning System Guided Munitions,” 2025 concepts database (Maxwell AFB, Ala.: Air War College/2025, 1996).

²³ 2025 concept, no. 900233, “The Very Small, Very Smart Bomb,” 2025 concepts database (Maxwell AFB, Ala.: Air War College/2025, 1996).

²⁴ *New World Vistas*, summary volume, 10.

²⁵ Craig A. Rogers, “Intelligent Materials,” *Scientific American*, September 1995, 154–157; Marvin Minsky, “Will Robots Inherit the Earth?,” *Scientific American*, October 1994, 109–113; William B. Scott, “Micro-Machines Hold Promise for Aerospace,” *Aviation Week & Space Technology*, 1 March 1993, 36–39; 2025 concept, no. 200023, “Surveillance Swarm,” 2025 concepts database (Maxwell AFB, Ala.: Air War College/2025, 1996); 2025 concept, no. 900481, “Destructo Swarmbots,” 2025 concepts database (Maxwell AFB, Ala.: Air War College/2025, 1996).

²⁶ 2025 concept, no. 900278, “Real-Time Virtual Uplink with Unmanned Aircraft,” 2025 concepts database (Maxwell AFB, Ala.: Air War College/2025, 1996).

²⁷ USAF Scientific Advisory Board, *New World Vistas: Air and Space Power for the 21st Century* (unpublished draft, the directed energy volume, 15 December 1995), iii.

²⁸ *New World Vistas*, summary volume, 35.

²⁹ Defense Airborne Reconnaissance Office, 40; *New World Vistas*, summary volume, 41; “Cooperative Air-to-Air/Air-to-Ground Engagements-Distributive Fire Control,” *Technology Initiative Game 95 (Systems Handbook)*, 18–22 September 1995, 20–1.

³⁰ “Cooperative ESA Jamming,” *Technology Initiative Game 95*, 21–1.

³¹ *New World Vistas*, summary volume, 60.

³² *Ibid.*, 52.

³³ Defense Airborne Reconnaissance Office, 40.

³⁴ *New World Vistas*, summary volume, 41.

³⁵ David A. Fulghum, “Predator to Make Debut Over War-Torn Bosnia,” *Aviation Week & Space Technology*, 10 July 1995, 47–48.

³⁶ Defense Airborne Reconnaissance Office, 40.

³⁷ 2025 concept, no. 900233, “The Very Small, Very Smart Bomb,” 2025 concepts database (Maxwell AFB, Ala.: Air War College/2025, 1996).

³⁸ *New World Vistas*, summary volume, 58–59.

³⁹ “C-17 Unmanned Aerial Vehicle (UAV) Airborne Platform,” *Technology Initiative Game 95 (Systems Handbook)*, 18–22 September 1995, 17–1, 17–2; 2025 concept, no. 900580, “In-Flight Air Refueling/Rearming of Strike UAVs,” 2025 concepts database (Maxwell AFB, Ala.: Air War College/2025, 1996).

Chapter 4

The Virtual Trajectory Air Superiority without an “Air” Force?

New conditions require, for solution—and new weapons require, for maximum application—new and imaginative methods. Wars are never won in the past

—General of the Army Douglas MacArthur

As described earlier, the virtual trajectory assumes a globally-minded US with plenty of technology and money to support military technological advancement. Its motto is Virtual Presence, Virtual Power. The premise: the US is a global power with an attitude, has a strong economy and leverages an exponential growth in technology, but is reluctant to put its blood and treasure on the line routinely for questionable causes or outcomes. This, coupled with an increasing ability to locate, identify, and track both fixed and moving targets with high precision; a space-based force application ability (lasers, high power radio frequency (HPRF), high power microwave (HPM), etc.); and possession of surface-based weapons of a similar nature, leads to a reduction in the need for air superiority aircraft.

The America of 2025 is a global superpower in every respect, defined by a strong economy, political decisiveness, a resurgence in moral strength, worldwide recognition as an honest broker, and a position at the cutting edge of the technology of the day. However, there are some that wish to discredit or challenge the US's place in the world view. The US's penchant for conflicts of minimal violence, with few casualties and little collateral damage, has placed renewed emphasis on precision in lethal application of force and a new stress on nonlethal force for subduing enemies. The result is a need for a space- and surface-based counterair capability for subduing any challenger using standoff weaponry.

The author made some basic assumptions to frame our approach and demonstrate the need for a surface- and space-based counterair capability. The first assumption is that there would be a limited personnel and

airframe base. Defense drawdowns would have reduced the availability of highly skilled pilots. As recently as the Gulf War, it was emphasized repeatedly that “no target is worth an airplane,” and the American predisposition towards risking as few lives as possible is well known.¹ As such, inhabited airframes will be used only for key targets that cannot be hit from the surface or space without risking mission failure or collateral damage; the most likely use is in strategic attack or special operations roles. It was also observed during the Gulf War that the Iraqi population understood the US was targeting Iraqi military capability, and not the general population, because of the precision with which their military assets were targeted.²

The second assumption is the availability of adequate communications bandwidth to support the command, control, communication, computers and intelligence (C4I) infrastructure required for coordinated real-time target acquisition, tracking, and battle management.

The third assumption is that the US will reap the benefits of huge leaps in technology that allow US armed forces to develop and deploy advanced space- and surface-based weapons. This assumption does not eliminate the possibility that a regional competitor, such as Iraq, could not possess capabilities that would pose a threat to most of our forward deployed forces, or even continental United States (CONUS)-based assets.

A related issue is the impact of having an adversary as technologically capable as the US investing primarily in a virtual capability. In this case, the counterair mission as we know it would disappear, its requirements would likely be assumed by strategic attack and interdiction forces.

Counterair Requirements

The requirements for this space- and surface-based counterair system can be broken down into three major areas: information collection and processing; situation awareness/command, control, and communications (SA/C3); and force application systems. Target tracking and identification must allow identification of all friendly and threat aircraft in the area of responsibility (AOR) including airframe type, location, and heading, using both military, COTS systems, and commercial inputs. COTS processing capability will give the required computing power, and commercial multispectral and other inputs will provide additional data points to the threat identification process. When possible, the weapons load of

enemy aircraft should be determined to allow the US to estimate the nature of the threat. Once an adversary is targeted, the weapon will require the capability to acquire a specific airframe to an accuracy that will allow submeter precision (particularly for lasers, to allow targeting specific control surfaces or weapons on the aircraft). This will be required since the most vulnerable parts of airframes are the pilot and the wing root.³ Target acquisition and tracking systems will require a high degree of accuracy. Laser weaponry, in particular, will require accuracies to the centimeter for the more lethal effects. This is one area in which military research and development (R&D) will likely be required.

SA/C3 systems are the linchpin of the effort. They will be required to ensure mission critical communications are being passed between target tracking systems, to the regional commander in chief's (CINC) battle management operations center (BMOC) and then to a target engagement node. Secure, jam-resistant communications must be available to support all phases of operations. The BMOC must be able to coordinate and direct all counterair assets and evaluate attack results. Battle damage assessment (BDA) can be accomplished by the same systems used for tracking and engagement in much the same way as the virtual presence capabilities described in *New World Vistas* where virtual presence allows for laser systems to provide attack, high-resolution imagery, high bandwidth point-to-point communications, optical IFF, and active remote sensing.⁴ The biggest challenge will be sustainment of space-based systems. Once on orbit, space-based systems must either be maintained in-place (using a transatmospheric vehicle (TAV) or other technology) or replenished as required.

System Descriptions

Minimizing collateral damage is a requirement that will dominate all future contingencies and combat operations.

—Col Richard Szafranski
GEO, LEO and the Future

A virtual counterair capability will provide near-instantaneous precision strike with minimum collateral damage. To conduct the counterair mission, the virtual air forces rely on three key components: information collection and processing capability, SA/C3 capability, and force application systems.

Information Collection and Processing

The information collection system is based on the premise of performing wide area (global) surveillance at a low level of resolution, but looking for cues that require detailed monitoring. These cues will trigger a switch to a reconnaissance mode providing multispectral, high-resolution information on activities in a given region or area of interest. A mix of phenomenologies will accomplish this. Using multiple phenomenologies is critical to seeing through enemy camouflage, concealment, and deception efforts to ensure we see what we think we are seeing. In 2025, distributed satellite constellations will be our eyes and ears, providing the global view described in *SPACECAST 2020*.⁵ Distributed systems of small single-function satellites, working in planes much as GPS does today, will allow continuous coverage of the battle space in multiple frequency bands. A constellation of cooperative space-based radar satellites will be capable of providing a moving target indicator (MTI) capability and synthetic aperture radar (SAR) images similar to Joint Surveillance Target Attack Radar System (JSTARS) (fig 4-1). A complementary set of satellite receiver platforms can be used to perform geolocation of electronic emitters or bistatic imaging and tracking of noncooperative targets.⁶

Similar potential exists for EO and IR detection and tracking of targets. Multispectral EO and IR images can be merged with SAR images by superprocessors capable of correlating data from multiple sources and providing a high-resolution image of targets in near-real-time. Finally, a phased-array, space-based laser system will also be able to take high-resolution (submeter) imagery, further improving our capability. This will be accomplished by the use of a super-GPS time and position standard, allowing multiple laser images to be correlated with other sources of information to further refine target knowledge.

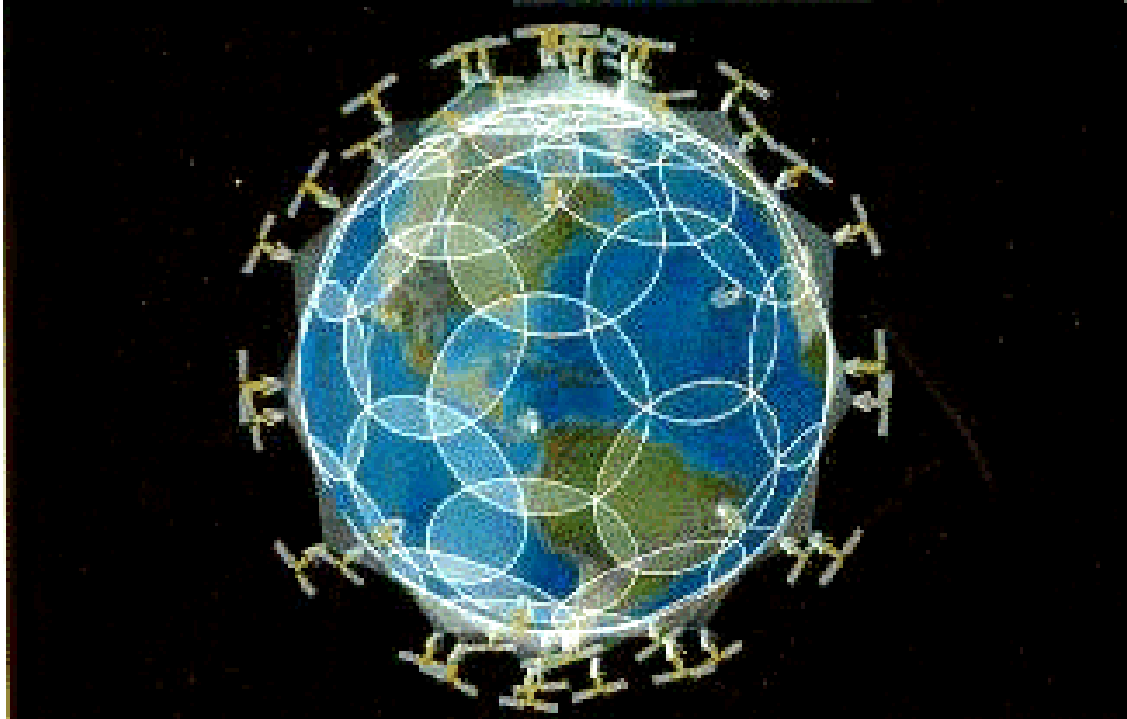

Source: <http://leonardo.jpl.nasa.gov/msl/Quicklooks/Pictures/iridconst.gif>, courtesy of Mike's Spacecraft Library.

Figure 4-1. Distributed Satellite Constellation

The space-based assets will be complemented by a series of fixed and mobile surface-based assets. Their capabilities will mirror those of their space-based counterparts; time-coded signals from individual satellites can be used for SAR image processing, MTI, and bistatic processing. A network of surface-based EO and IR sensors, as well as laser sites, will cover those targets obscured by high-level clouds, further adding to the information base on targets in any given AOR. Those areas covered by frequent low- to mid-level clouds will rely more heavily on the RF-based systems.

The focus of these collection systems is a multimode polyocular processing (M2P2) system that will correlate information using powerful, knowledge-based, image processing capabilities, providing detailed three-dimensional (3D) target images on demand. The combination of EO, IR, and RF phenomenologies, combined with processing designed to detect and identify enemy systems, will allow the US to see through almost any conceivable deception effort. The pseudoimage will be matched against IFF and threat data from space-based airborne warning and control system (AWACS) platforms and against standard target profiles, allowing determination of the weapons load as well as specific modifications made to the target that present special vulnerabilities we can exploit. Thus, a nominal resolution of 1-10 meters from any individual EO,

laser, or IR sensor, combined with bistatic or other SAR images of up to one meter resolution, will result in submeter imagery to support target detection, identification, and tracking capabilities for force application worldwide. Communications redundancy, using a combination of laser-crosslinks for space-to-space weapons platforms communications, and heavy reliance on redundant commercial communications encrypted for military use (particularly using wireless, cellular communications) will ensure worldwide connectivity for the entire system. The result is a system that lets US forces see in near-real-time what is happening in any region of the world at any time. The bottom line of our information collection and processing capability is our ability to continuously monitor the battle space.

Situational Awareness/Command, Control, and Communications

The heart of any operation is its operations center. The air operations center of 2025 has evolved into part of the CINC's battle management operations center. The god's-eye view afforded the CINC and the JFACC, fed by the information collection and processing system previously described, gives the JFACC the ability to display the battle space in its entirety, or zoom down to a particular aircraft or engagement. This is accomplished using a holographic war room, much like the holodeck from "Star Trek," where 3D visualization of the battle space is possible from the synoptic (broad area overview) perspective, to allow monitoring and engagement throughout the AOR, down to a particular target, with the JFACC actively interacting with the holographic depiction, controlling engagement activity and monitoring the progress of the battle in near-real-time (fig. 4-2).⁷

The BMOC fulfills multiple functions. The war room allows not only real-time centralized control, but also, using very high-speed computers (up to 1,000,000 times faster than today's computers), airspace deconfliction, battle simulations, expected outcomes in accelerated time modes, and BDA assessments. The speed-of-light nature of many of the laser and high-powered microwave weapons allows deconfliction of most engagements within minutes (or even seconds) of tasking.⁸ Accelerated simulations allow the commander to evaluate courses of action in near-real-time. The computer will simulate the progress of an engagement based on the capabilities and doctrine of enemy forces using knowledge-based artificial intelligence software. As the BMOC learns more about how the enemy fights, this information will be

applied to the engagement simulations, helping the JFACC select the best mix of weapons and weapon effects.⁹



Source: <http://www.afit.af.mil/Schools/PA/gall3.htm>, courtesy of Gene Lehman, AFIT/LSEC

Figure 4-2. Holographic War Room

The fast-forward outcomes can also be stored for comparison with the actual engagement, so the system can give the commander an empirical estimate of the outcome once a history of engagement activity is built. The results of both the simulations and the actual engagements will be stored as part of lessons learned for postconflict debrief and tactics modification. An assumed outcome to this will be a change from decentralized execution to distributed engagement. Distributed engagement is a result of the use of multiple small weapons to achieve a larger weapons effect, lack of time lapse between decision to engage and actual weapons on target, and a centralized command structure. A benefit of distributed engagements is a graceful degradation and increased survivability. A downside is the increased reliance on a single command center and its potentially vulnerable communications.

Part of the speed with which this activity is performed comes from the ability of the commander to use voice commands to establish ROE, pick targets, and finally specify weapons effects, from nonlethal to lethal. The commands can be as specific as “destroy the four F-16s crossing the Kuwaiti border” (centralized control--centralized execution) to “disable all enemy aircraft entering friendly airspace” (mission-type orders). The BMOC will recommend a series of options, which can be played out in the war room, allowing the commander to see the expected results, then select from one of the courses of action (COA) displayed. At that point, the commander will direct frag orders be sent to the individual weapon systems for execution. Based on inputs from the weapons sensors themselves, as well as our surveillance and reconnaissance systems, the actual battle can be displayed with insignificant time lag; the commander can observe the engagement as it is conducted, obtaining near-real-time feedback on the status of the mission. The closed-loop nature of engagement and feedback will allow rapid retargeting to ensure the CINC’s and JFACC’s objectives are met effectively and when required. The fog and uncertainty of war are significantly reduced, and adjustments to any engagement parameter (target, weapon, effect) can be made as required during the battle.

Force Applications Systems

High energy lasers (HEL) and high power microwave devices have been noted to be complementary.¹⁰ Lasers are noted for their potential for destructive power; however, they require accurate targeting and a relatively benign environment (no clouds or overcast, smoke, or smog).

HPM weapons, on the other hand, are typically capable of less overt destructive power, but are capable of operating in virtually any environment and constitute an all-weather capability. They represent two sides of the same coin which can be leveraged in 2025.

High Energy Lasers

HEL weapons will constitute a part of both the space- and surface-based systems. Space-based lasers will come of age by 2025. A number of advances will make this possible. The first is a super-GPS capability that will provide a level of time accuracy to the nanosecond and position accurate to the

millimeter.¹¹ This capability will be tied into our constellation of distributed phased array laser satellites (PAL-sats). These PAL-sats will not have to be the monster satellites envisioned in the Strategic Defense Initiative (SDI) era; they will be small, medium-power satellites, numerous, and easily replaced. By definition, space-based lasers are long-range weapons. Their power is derived from the ability to use a phased array approach to putting energy on target. The phased array is managed by a central control satellite, using a low power illuminator (also capable of imaging targets) to provide a phase reference for the deployed elements of the laser array (fig. 4-3). The phasing signal could also be used to communicate between elements of the system, passing targeting data, etceteras. Additionally, if the capability is developed, communication between phased array laser elements could be accomplished using quantum communications methods, so phasing between elements could be communicated simultaneously.¹² Using the phase information in the phasing signal, each PAL-sat will use deformable mirrors made of microelectromechanical devices and phase compensation measures such as phase conjugation to compensate for atmospheric and other effects. If coordination of these elements became too difficult or thermal heating of individual array PAL-sats became a problem, time-division-multiplexed lasing could be employed, with each PAL-sat firing in sequence against a particular point on the target, effectively providing a continuous laser from multiple-pulsed lasers.

The constellation approach simplifies each satellite, making it more affordable. The effect of the constellation is a graceful degradation of the weapon's capability if any one of the satellites is removed from operations due to weather, malfunction, or attack. It also allows for multiple weapons effects, which will be described below. Energy for such a system can come from multiple sources; the primary advantage in 2025 will be the development of composite materials that can change their characteristics on command. This is done using microelectromechanical systems (MEMS) deposited in the composite body of the satellite. When in one mode, the device can be rotated to minimize its signature, providing a measure of stealth. If the MEMS are rotated, like the highway billboards you see today, the devices soak up energy—either from the sun or a beam provided from the surface to recharge the weapon.

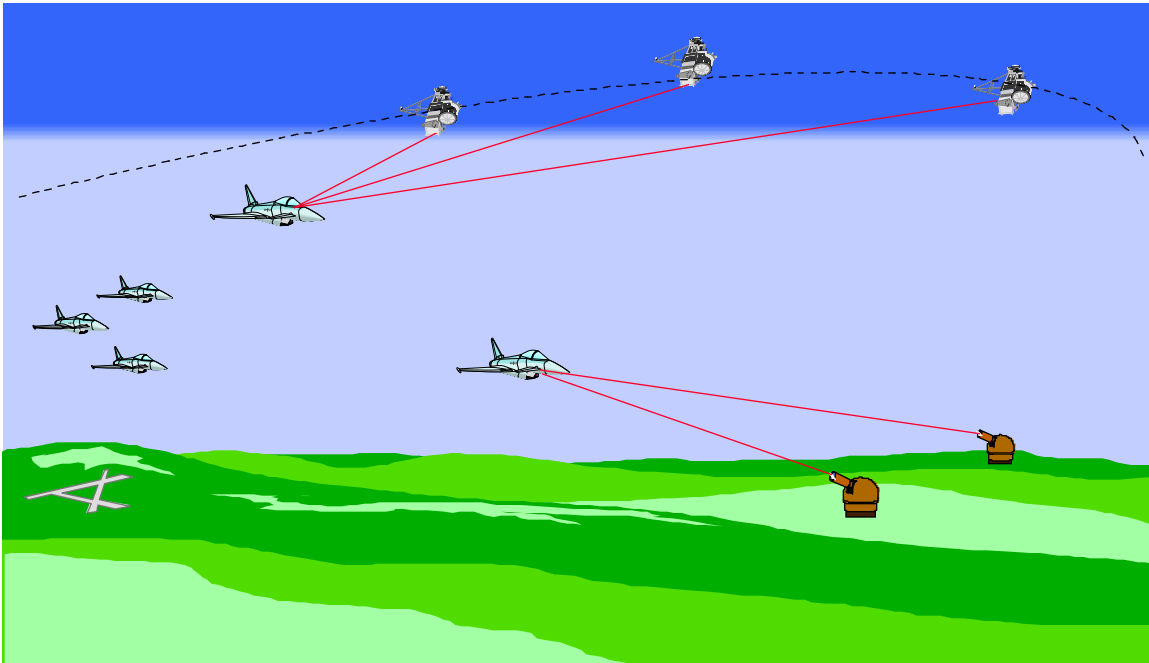

Clipart elements from Federal ClipArt © 1995 with courtesy from One Mile Up, Inc., and Microsoft Clipart Gallery © 1995 with courtesy from Microsoft Corp.

Figure 4-3. Friendly Phased Array Lasers Targeting Enemy Aircraft

Surface-based systems are based on the same principles as the space-based systems. The phased-array approach allows surface-based assets to be used against the same target as the space-based system, and also allows targeting of medium-range targets. Hard kill of airframes becomes a greater possibility, permitting a larger range of weapons effects. It also helps defeat the mitigating effects of weather.

One of the greatest advantages of energy weapons is the variability with which they can be applied. Effects can range from nonlethal to lethal. Nonlethal effects can range from cloaking—using lasers to provide holographic camouflage in the visible portion of the electromagnetic (EM) spectrum—to hide assets from visual identification, to generating holo-threats that would appear to move in out of nowhere, confusing the adversary who must engage a virtual enemy or run for home.¹³ To more fully deceive or confuse enemy onboard systems, HEL systems may require an adjunct whose only purpose is to provide a return for the enemy's radar—physical chaff launched by conventional means or rail gun, or RF deception of their radar systems. Granted, this assumes an unsophisticated enemy, but sometimes this may be enough psychologically. The combination of surface- and space-based systems is well suited for this type of deception.

A slightly higher level of lethality comes from a higher application of power. Effects such as canopy glazing, blinding, thermal effects (cooking off fuel or lubricants), or weakening structures is possible by varying the strength and width of the beam.¹⁴ Lethal effects can be achieved by burning through control structures, fuel lines, or electronics, or causing foreign object damage (FOD) to the aircraft engine.

Finally, and probably one of the greatest reasons for fielding this capability, is the ability to target and destroy cruise missiles, intercontinental ballistic missiles (ICBM), and theater ballistic missiles (TBM). Whether the threat is against an ally overseas or to the continental US, a PAL-sat constellation provides a precision strike capability against even a multiple missile threat.

Countermeasures and Countercountermeasures. The downside to laser weaponry is its vulnerability to atmospheric effects. Although this vulnerability can be partially overcome by adaptive optics and wavelength adjustment, smog, fog, clouds, smoke, and dust can prevent successful operation. Local weather control may be possible to support operations in limited areas.

A prolific PAL-sat constellation and surface complement is also one way to defeat certain local conditions. Hardening against low-power laser radiation is also fairly simple; reflective surfaces go a long way in this direction, but the trade off is increased visibility. Laser-seeking devices could also be a threat to the weapons platforms themselves; in effect, when in operation, laser weapons designate themselves, a factor that needs to be considered. Defender satellites or space sentries in place to counter an antisatellite threat is a possible solution.¹⁵ Visual or IR chaff are also options.

RF and High Power Microwave/Electromagnetic Pulse Devices

Space- and surface-based RF, HPM, and EMP devices will complement the laser capability of 2025 by providing an all-weather, day/night, variable lethality weapon. In addition to an all-weather capability, the greatest advantage of HPM/EMP over laser is that it does not require the same level of precision for targeting; the target may try to evade, but the beamwidth of the HPM device will usually cover an area equal to or larger than the airframe, and, as long as tracking is to that order of magnitude, evasive tactics will prove useless. Collateral damage can still be minimized by proper beam formation and effects limited to the target(s). EMP is even less discriminating in its tracking and targeting requirements. However, it is a one-

shot weapon, and the target has to be in the proximity of the device to be strongly affected, particularly for low-yield, high-explosive warheads.

HPM can be implemented in much the same way as lasers, using a phased-array approach, with both a distributed satellite constellation and surface-based elements. Beam shaping can be accomplished by using various combinations of the constellation and surface-based elements. HPM will be medium- (surface) to long-range (space) weapons. EMP will be implemented as a warhead weapon, being delivered either by railgun or cruise missile, providing everything from close-in to long-range targeting, depending on the required speed of the response or extent of desired effects. Railgun delivery from in-theater assets will be almost as timely as speed-of-light weapons and just as flexible. Surface-launched cruise missiles from CONUS or carriers provide a long-range, stand-off capability that can also serve as a deterrent.

RF weapons are a special case, because they represent a capability for a surgical strike. At any range, an RF weapon could be used to do anything from disrupt aircraft control to take over an aircraft (a.k.a. tractor beam).

Weapons Effects. HPM weapons are particularly effective due to the varied impact they can have on an adversary. As with lasers, HPM weapons can have nonlethal as well as lethal effects. The application of nonlethal HPM can result in thermal effects, such as weakening the structure of airframes, missiles, or command and control (C2) facilities.¹⁶ Continued application of microwaves against human targets (intentional or unintentional) can cause disorientation, discomfort, or long-term damage. At moderate power levels, the composite materials used in modern aircraft tend to absorb microwave radiation rather than reflect it, rapidly aging aircraft materials and destroying its stealth properties. Higher power levels of HPM can cause disruption of electrical circuits, particularly in sensitive integrated circuits or magnetic media. EMP can be used in a SEAD role by using shaped EMP charges to burn out receiver front ends in aircraft, C2 facilities, or SAM sites. Another side effect of EMP bursts to targets on the surface and in the air is cable coupling, causing serious electrical system and structural damage.¹⁷ RF weapons are capable of the simplest effect: basic ECM. This includes using space-based (or, where applicable, surface-based) systems to simply jam the front ends of enemy receivers, to generate false radar images to confuse the enemy's picture of the air war, to insert false imagery into his data stream.

Lethal effects can vary from igniting fuel vapors and the consequent loss of the aircraft, to torching avionics and electronics with directed HPM or wide-area effect EMP bursts, causing loss of control. EMP bursts of sufficiently high power and/or proximity can cause aperture coupling, where the airframe itself couples the energy of the burst, thus causing destruction of all electrical components and damage to control surfaces, as well as possible destruction or damage to any human occupants.¹⁸ In the RF realm, the most lethal effects will be the use of the tractor beam, where MEMS could be placed on an airframe, either by special operations forces, or by having them burrow into the avionics and electronics systems of an aircraft after it flew through a cloud of MEMS designed to penetrate the fuselage and implant themselves. Once implanted, a computer on our side could analyze the aircraft's control systems, and an operator on the surface could establish a link and take control of the enemy aircraft to force it down, or merely land it at a friendly airfield for analysis and pilot debriefing.

Countermeasures and Countercountermeasures. The most significant countermeasure to HPM and EMP is stealth and structural design. If the aircraft is sufficiently stealthy, it will be difficult to track and apply the energy levels required to damage or destroy the aircraft. However, in 2025 few adversaries, if any, will have the capability to make their airframes invisible to all the forms of energy (EO, IR, microwave, laser, radar) used to detect, identify, and track their forces. Structural design can be used to mitigate the effects of aperture and cable coupling. A stealth paint can be applied to surfaces to further reduce visibility in selected portions of the EM spectrum.¹⁹ Possible countermeasures are spectroscopic detection of the paint, exhaust tracking, or magnetic detection of aircraft.²⁰ These capabilities will make the ISR systems described under the Information Collection and Processing section above even more robust. The best countercountermeasure (CCM) for US satellite-based capability would be the embedded MEMS in the composite structures described earlier that would allow the satellite to change its visibility based on the type of sensor attempting to track it, or a shell that deploys to protect the satellite, or the defender satellites mentioned above.

The RF/MEMS link is particularly hard to defend against. If a quantity of these MEMS is suspended in a slowly falling cloud above an air base, they would either fall onto enemy aircraft as they sit on the ramp, force adversary aircraft to fly through them to get airborne, or cause those aircraft to retreat to storage. In each case, the adversary's air capability is effectively grounded.

Kinetic Energy Weapons/Ground Launched Cruise Missiles

Kinetic energy weapons (KEW) and an improved ground launched cruise missile (GLCM-X) capable of intercontinental ranges will provide an enhanced capability against hardened targets and targets of opportunity. The GLCM will replace the ICBM, mostly to enhance survivability. ICBMs are too easily tracked, and deviating from ballistic trajectories for ICBMs is tantamount to GLCM use in any case. Space-based KEWs are possible, but orbitology and time of flight will limit their application. Rapid progress in railgun technology was seen during the 1980s, and kinetic energy weapons have been demonstrated using railgun technology to propel warheads of up to 1000 kilograms (kg) and in excess of six kilometers per second (km/sec).²¹ By 2025, advances in technology for these devices will yield vehicle-mounted weapons that could be located in the AOR and will give a response time that complements our energy weapons. Super-GPS combined with near-real-time target updates will allow medium-to-long-range attacks on hardened airfields, aircraft revetments, airbase C2 facilities, runways, or even aircraft in flight with both types of delivery systems.

Weapons Effects. The advantage of KEW and GLCM weapons is their capability against hardened targets and those targets requiring a tailored warhead. The ability to carry a sizable warhead allows the US to develop sophisticated nonlethal effects that can be delivered to submeter accuracy. Nonlethal effects include HPM/EMP warheads capable of producing effects similar to the space- and surface-based systems, less the phased-array aspect. However, proximity to the target and shaped warheads will compensate for this. The warheads can be delivered by either railgun or GLCM, depending on the state of our forces in theater and the type of response the national command authority (NCA) desires—overt action in theater or covert delivery from CONUS. Other nonlethal warheads include FOD bombs examples include webbing or netting over aircraft on the ground, suppression clouds, oxygen suckers, or highly tensile “silly string” to freeze control surfaces, thereby keeping aircraft grounded.²²

Lethal effects can be achieved by MEMS that can damage or take an aircraft apart in flight, drop submunitions on a runway, or deposit acid or other destructive liquids on airframe surfaces or airbase facilities.²³ An alternative anti-aircraft artillery (AAA) method is to use railgun warheads to eject a suspended net of high-tensile-strength steel that would shred aircraft control surfaces as the aircraft passes

through it. This same method could be used for theater missile defense, disabling or destroying missiles and/or warheads in flight. The most direct approach is obviously to take a high explosive (HE) warhead right to the target—a GLCM warhead can take out a hardened facility, revetment, or C2 facility. With a multiple reentry vehicle warhead and MEMS-controlled submunitions, it could take out an entire air wing on the ground. The railgun would serve as a twenty-first century AAA, putting submunitions right through airframes at hypervelocities capable of ripping the airframe apart. In addition, the surface-based railgun will provide another layer in the cruise and ballistic missile defense umbrella, complementing the capabilities provided by surface- and space-based lasers.

Countermeasures and Countercountermeasures. There are few countermeasures except extremely expensive hardening against HPM/EMP or stealth (antitracking) measures. The high speed of railgun projectiles would negate evasion maneuvers.

A sufficiently small projectile, made of composites and moving at hypervelocity, would be hard to detect, much less counter. The GLCM-X would be designed to go against hard, fixed targets or produce wide-area effects requiring large payloads/warheads; given this, the only effective counter is successful camouflage.

Enabling Technologies

The enabling technologies allowing the successful implementation of the counterair mission using space- and surface-based assets can be grouped into the same categories as the areas requiring development: information collection and processing, situational awareness/C3, and force application. The key technologies supporting information collection and processing include advanced space-based radars capable of SAR, MTI, and bistatic detection; high-speed computing and real-time linking to support space- and surface-based phased array laser and HPM capability; timely, cost-effective launch of tailored, distributed satellite constellations; and distributed processing of multimodal information for real-time tracking of targets.

The requirements for SA/C3 technologies include allowing real-time displays of order of battle, enemy and friendly COA generation, and wargaming of outcomes. This includes artificial intelligence/knowledge processing systems capable of correlating multispectral, multimodal information. Fused, correlated

information would be used to generate enemy and friendly COAs and three-dimensional holographic presentation and real-time simulation of enemy and own force activities in fast forward modes. Combined with the distributed processing of target information, this could also provide near-real-time BDA.

Weapons application technologies are centered around advanced GPS, capable of nanosecond accuracy and millimeter precision, and high-resolution optics, beam directors, and deformable mirrors for laser applications. The phased array lasers and HPM also require the development of phased array timing/phase synchronization signals (such as time-coded reference signals or quantum nodal communications) to allow timely communications between physically separated array elements. Composite materials, with imbedded MEMS capable of changing states to accommodate stealth (energy absorption), power accumulation (energy conversion), or active transmission are needed to support the stealth aspects of our platforms. High power RF and HPM technologies must be developed to make spaceborne platforms viable. Mobile, moderate payload (up to 1000 kg), hypervelocity railgun delivery systems are needed to support the rapid response of surface-based EMP and HPM weaponry.

Concept of Operations

The BMOC is the heart of counterair operations. Using all-source information generated by space- and surface-based sensors, the holographic war room will give the CINC and JFACC the ability to monitor friendly and enemy forces in near-real-time. The JFACC, using voice commands, will be able to ask the war room to “show enemy air forces,” followed by “show enemy IADS.” After reviewing the enemy order of battle, he can ask the system to “show probable enemy actions and targets.” Once requested, the system will examine the enemy ordnance load and fuel capacity (gathered by space and surface-based SAR, EO, and laser imagery), and project their tracks to and from targets. The JFACC will then ask the system to “show own forces,” and all offensive and defensive systems and their effectiveness envelopes will come up. At that point, the commander’s intent will have to be specified in terms of the mission: deter, disrupt, or destroy enemy assets. Depending on the enemy, the target, and the CINC’s objectives, the JFACC will request COAs appropriate to the mission. After reviewing the COAs in fastforward mode, one will be selected and targets identified and designated in the war room. One fallout of the responsiveness of energy weapons to tasking is

the requirement for centralized control and centralized execution of these systems. The immediacy of the impact of weapons use and requirements for real-time deconfliction with other air and surface forces requires control from the war room. This need is reflected in the way space and surface counterair forces are tasked. The degree of damage or destruction of each target will be specified before engagement, and target parameters passed directly to the weapon systems.

Most adversaries will be deterred by the recognition that, as a global superpower with worldwide virtual presence, the US is capable of quickly identifying enemy actions and responding before they pose a threat. Because of this, most operations will likely be deterrent missions, demonstrating capability and resolve to the enemy. Simple methods such as holographic projection of an air threat against the adversary would be attempted first to scare him off. As the adversary increases the aggressiveness of his posture, the US could respond in kind by increasing the threat to enemy air forces, using the MEMS cloud or GLCM to keep enemy aircraft grounded. If deterrence fails altogether, a destruction COA will become more likely. The weapon of choice could be selective lasing of vulnerable airframe surfaces, disabling HPM bursts, or airspace control devices such as the silly string or steel nets. Active high-power lasing, RF or HPM bursts will disable, destroy, or ground large segments of the enemy air capability. Near-real-time BDA will allow for rapid retargeting of assets; one of the advantages of space-based weapons is that they are always forward deployed. In this instance, if high energy lasing of a penetrating aircraft was required, real-time reporting from the laser platforms would be combined with EO, IR, and SAR imagery to determine if the target was “heating up,” had exploded, or gone down in near-real-time. The tractor beam capability will be reserved for high-value air assets and reconnaissance vehicles. This will allow the US to determine the type of enemy systems and capabilities and to build countermeasures or deception programs around this system. This will also increase US stature in the world community by reducing the death and destruction of airframes and pilots, and give the US another source of human intelligence (HUMINT) from pilot debriefings.

Cruise missile and ballistic missile defense (BMD) will be a primary function of space- and surface-based counterair forces. Part of the driver for the global surveillance and focused reconnaissance capabilities of the BMOC will be to accommodate the requirement for constant vigilance of the cruise and ballistic missile threat. The combination of laser, HPM, and railgun payloads will provide a multitiered, all-weather defense against ballistic missiles (fig. 4-4). The M2P2 processing capability described above will

allow the determination of location, velocity, and probable launch and impact points. The war room will provide detail on the nature of and confidence level of the threat, but the crews on watch in the BMOC will be the human in the loop to ensure the threat is identified quickly—within 60 seconds—but verified before destruction. Although 60 seconds is not a significant improvement over detection and warning times today, the problems of detecting stealth missiles will complicate the problem, and the ability to begin neutralizing the threat within seconds of identification provides significant leverage that does not currently exist.

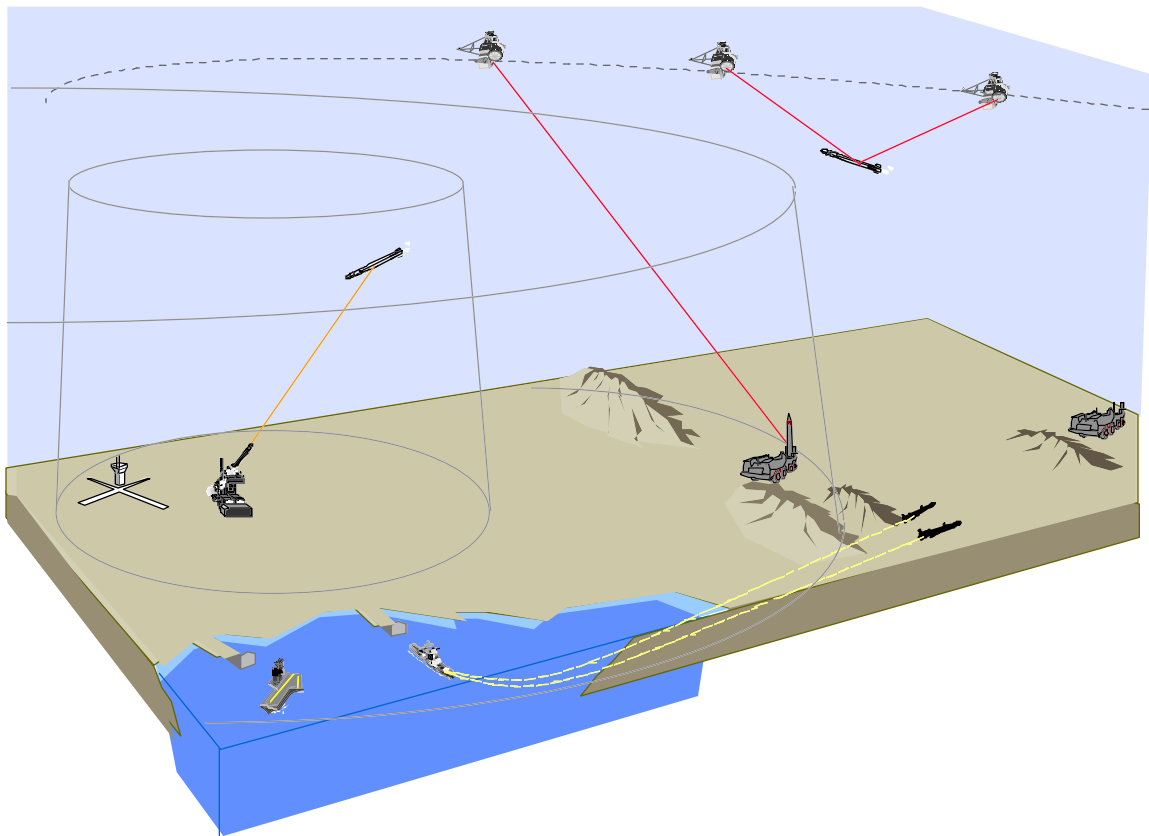

Clipart elements from Federal ClipArt © 1995 with courtesy from One Mile Up, Inc., and Microsoft Clipart Gallery © 1995 with courtesy from Microsoft Corp.

Figure 4-4. Multitiered (Laser, GLCM, Railgun) Missile Defense Capability

Summary

The key to the success of the systems described above is matching the capability to possible threats. This paper described the range of threats. The applicability of directed energy weapons, cruise missiles, and nonlethal munitions payloads varies across the spectrum. The strength of the systems described above is in

their versatility and responsiveness. Directed energy weapons have their strength in their ability to engage at everything from very low to very high power levels, increasing from nonlethal disruptive effects to lethal destruction at the flick of a switch. Cruise missiles will be highly accurate, delivering any payload at high precision at any given time for measured effect. Railguns give the added versatility of being able to put “steel (or plastic) on target” in a short period of time, also with the possibility of multiple payloads.

The weakness of DEW is the flipside of its strength—once engaged, the mission can be halted, but whatever damage is done, is done. Cruise missiles can be destructively aborted; railgun payloads lie somewhere between the two, depending on distance to target and the nature of the payload. None of these systems carry much finesse once a mission has started; a human in the loop is not the same as a human on the scene, and the fidelity of feedback is much more limited.

Even a fused picture of the battle space will not yield the same insights as a pilot in the cockpit engaged in a flyby of possible hostiles. For this reason, UAVs or inhabited aircraft are much better suited to low tech or second wave adversaries engaged in such cat-and-mouse tactics as airspace infringement or insurgency. The significant advantage of these systems is, as previously described, their ability to instantly engage a target. Distributed space-based systems, in particular, provide a method of reaching targets worldwide on a moment’s notice. This is crucial when considering the theater ballistic missile, ICBM, and cruise missile threat of 2025.

The surface- and space-based systems described in this trajectory also enjoy the advantages of low fragility; they appear less vulnerable as a system because of their distributed nature. The distributed engagement concept also allows for a multiple simultaneous target scenario over a large (basically global) engagement area—a direct result of the forward deployed aspect of space assets. This in turn supports the ability to train as you fight, which is inherent in these systems since, to the operator, any simulation seen during training will appear identical to what would be seen in an actual engagement.

The most daunting aspects of fielding these systems are the technological and financial requirements. The technological improvements required to implement a space-based phased array laser or HPM capability are an order of magnitude or more increase from state of the art in 1996. The associated cost for research and development and deployment are significant for all the elements of the system—information collection and processing, SA/C3, and force application systems.

In the final analysis, the ability to immediately reach out and touch a target with both lethal and nonlethal consequences will provide a significant deterrent as a key component of US overall counterair capability.

Notes

¹ Thomas A. Keaney and Elliot A. Cohen, *The Gulf War Air Power Survey Summary Report* (Washington, D.C.: Government Printing Office, 1993), 248–249; and Richard H. Shultz Jr and Robert L. Pfaltzgraff Jr, ed., *The Future of Air Power in the Aftermath of the Gulf War* (Maxwell AFB, Ala.: Air University Press, July 1992), 303.

² Richard P. Hallion, *Storm Over Iraq - Air Power and the Gulf War* (Washington, D.C.: Smithsonian Institution Press, 1992), 199.

³ USAF Scientific Advisory Board, *New World Vistas: Air and Space Power for the 21st Century* (unpublished draft, the directed energy volume, 15 December 1995), 56.

⁴ *Ibid.*, x.

⁵ *SPACECAST 2020 Executive Summary* (Maxwell AFB, Ala.: Air University Press, 1993), 12.

⁶ USAF Scientific Advisory Board, *New World Vistas: Air and Space Power for the 21st Century*, summary volume (Washington, D.C.: USAF Scientific Advisory Board, 15 December 1995), 20.

⁷ 2025 concept, no. 900385, “3-D Holographic Battlefield Display,” 2025 concepts database (Maxwell AFB, Ala.: Air War College/2025, 1996); 2025 concept, no. 900161, “Holographic C2 Sandbox,” 2025 concepts database (Maxwell AFB, Ala.: Air War College/2025, 1996); 2025 concept, no. 900417, “Battlespace Awareness Holosphere,” 2025 concepts database (Maxwell AFB, Ala.: Air War College/2025, 1996).

⁸ 2025 concept, no. 900526, “Space-Based Airspace Control & Deconfliction System,” 2025 concepts database (Maxwell AFB, Ala.: Air War College/2025, 1996).

⁹ 2025 concept, no. 900414, “Artificial Intelligence: A New Aircrew Member in Tomorrow’s Combat,” 2025 concepts database (Maxwell AFB, Ala.: Air War College/2025, 1996); 2025 concept, no. 900522, “Space-Based AI-Driven Intelligence Master Mind System,” 2025 concepts database (Maxwell AFB, Ala.: Air War College/2025, 1996).

¹⁰ *New World Vistas*, (unpublished draft, the directed energy volume), iii.

¹¹ *SPACECAST 2020*, 13.

¹² 2025 concept, no. 200013, “Quantum Effect Communications,” 2025 concepts database (Maxwell AFB, Ala.: Air War College/2025, 1996). (PROPRIETARY)

¹³ 2025 concept, no. 200015, “Distortion Field Projector,” 2025 concepts database (Maxwell AFB, Ala.: Air War College/2025, 1996) (PROPRIETARY); 2025 concept, No. 900313, “Spaceborne/Airborne Hologram,” 2025 concepts database (Maxwell AFB, Ala.: Air War College/2025, 1996); 2025 concept, no. 900336, “‘Cloaking’,” 2025 concepts database (Maxwell AFB, Ala.: Air War College/2025, 1996).

¹⁴ LCDR James Todd Knight, “Aircraft Survivability: Vulnerability to Directed High Energy Weapons,” (Thesis submitted to the Naval Postgraduate School) (Monterey, Calif.: Naval Postgraduate School, December 1986), 126.

¹⁵ 2025 concept, no. 900371, “Automated Space Sentries,” 2025 concepts database (Maxwell AFB, Ala.: Air War College/2025, 1996).

¹⁶ Knight, 51, 110.

¹⁷ *Ibid.*, 45, 47.

¹⁸ *Ibid.*, 45, 46.

¹⁹ 2025 concept, no. 900605, “Active Cloaking Film/‘Paint’,” 2025 concepts database (Maxwell AFB, Ala.: Air War College/2025, 1996).

Notes

²⁰ 2025 concept, no. 900647, “Jet Exhaust Tracking AAMS/SAMS,” 2025 concepts database (Maxwell AFB, Ala.: Air War College/2025, 1996) (PROPRIETARY); 2025 concept, no. 900508, “Magnetic Detection of Aircraft,” 2025 concepts database (Maxwell AFB, Ala.: Air War College/2025, 1996).

²¹ *Study of Oblique Detonation Wave Scramaccelerator for Kinetic Energy Weapons and Lethality Testing*, (Advanced Projects Research Inc., February 1990), abstract.

²² 2025 concept, no. 900258, “Oxygen Sucker,” 2025 concepts database (Maxwell AFB, Ala.: Air War College/2025, 1996).

²³ 2025 concept, no. 900436, “Runway Targeting Smart Munition,” 2025 concepts database (Maxwell AFB, Ala.: Air War College/2025, 1996); Wing Commander E. E. Casagrande, *Non-Lethal Weapons: Implications for the RAAF* (Royal Australian Air Force Air Power Studies Center, November 1995), 15–16.

Chapter 5

Synthesis

The bedrock of what we do is air superiority ... we want to dominate the other guy's airspace.

—Gen Ronald R. Fogleman
Air War College address

The world of 2025 is a world of varied threats. The air threat can be as simple as a terrorist with stinger missiles or Cessnas flying from Latin America or Cuba. On the other end of the scale, the threat could be long-range cruise missiles from Iran, a Chinese stealth capability much the same as the F-117, a Russian air-based laser, or a North Korean theater ballistic missile.

From the previous discussion several conditions can be derived that must be met for the successful execution of the counterair mission. The first condition is that the US must be able to counter the full range of threats, from the surface to the edge of space. These threats encompass the full range from small arms to lasers. What is common to the airborne threats is that they cease to become threats once they are no longer airborne.

This leads to the second condition, one based on the definition of counterair operations—that mission success is based on the neutralization of the enemy's air forces. This can be accomplished by keeping them on the surface or, if airborne, to remove them from the protected/defended airspace and hence remove the threat they pose.

The third condition that must be met for successful execution of the counterair mission is to establish the freedom to operate in any airspace with impunity—the crux of air superiority. The threat the US must deal with is the anti-air capability of today and tomorrow—something as simple as a shoulder-launched anti-aircraft missile to a space- or surface-based laser similar in capability to the type described in our virtual trajectory.

Over time, we have recognized a fourth condition—there will be an increasing need to perform the counterair mission in both a lethal and nonlethal manner. A priority is reducing the exposure of air assets and their operators to enemy fire.

The fifth condition is derived from the increasing ability to project great power over great distances in a short period of time. This mission must be performed both at short range and at increasingly long ranges—and not only protect US airspace at home, but also be able to project power from CONUS to halfway around the world at a moment's notice.

Analysis

A critical assumption is derived from the previous analysis and the conditions described above: the need for a mix of inhabited and uninhabited aircraft as well as surface- and space-based systems. The need for inhabited aircraft is driven by the convergence of two forces—the nature of a second wave airpower threat and the fact that in our democracy we will always consider leaders, at all levels, responsible for their actions. The inescapable conclusion is that some threats require not just a human in the loop, but a human on the scene. At no point in the previous discussion has the assertion been made that any of these systems is foolproof; in a given situation, one may present a better solution than another. The dominant battle space awareness provided by the ISR and situational awareness systems of 2025 will never provide perfect knowledge of enemy capabilities or intentions.¹

Examples are the probing missions conducted by the USSR near US airspace in Alaska during the cold war and the shutdown of private aircraft near Cuba in February of 1996. In the future, US airpower will encounter aircraft in international airspace with questionable or unknown intentions. Even with the near-real-time relay of information, these circumstances will spawn situations where nothing can replace the intuition, or gut instinct, of a pilot flying combat air patrol (CAP), making the determination based on information from offboard, onboard, and experience.

The positive control implied by a pilot on-scene is a powerful deterrent as well; an adversary may be much less likely to attempt to down an inhabited aircraft in a nonprovocative situation for fear of an adverse US or international response. It is also likely that as countermeasures improve, there may be situations where

inhabited as well as uninhabited vehicles will be cut off, losing their eyes and ears. The advantage of inhabited aircraft is that the pilot will be much more capable of recovering from the situation, and possibly taking advantage of it, whereas if the UAV is cut off, it will require a fail safe that will, at best, allow it to return to base.

On the other hand, in the case of a general war scenario, uninhabited vehicles, commanded from a remote operations center for preprogrammed missions or via a real-time data link may be the weapon of choice. In this case, the FotoFighter described in *New World Vistas* may be the right vehicle for taking out enemy targets; combined with uninhabited reconnaissance, command and control, and relay aircraft, the FotoFighter may be the best all-around choice for close-in and medium-range targets.

The disadvantages of the inhabited aircraft have been enumerated many times: high training costs, limited number of platforms, limited number of pilots, and limited number of target engagements per platform. An increasingly hostile threat environment, including hypervelocity missiles with multimode seeker heads, makes conventional aircraft increasingly unattractive in terms of the cost of a single failed engagement. This must be balanced with the projected relative ease and timeliness of the application of high-energy weapons, whose maintenance costs may be high and where depth of magazine, particularly in the space-based situation, may be limited.

The downside of aircraft is reaction time. The best equipped strike fighter is useless if it shows up after the battle is lost—and reaction time will be at a premium against our more sophisticated foes in 2025. Adversaries will increasingly have access to weapons that today seem exotic, such as stealthy cruise missiles.² This is where US space- and surface-based capabilities come to the fore. The ability to detect, acquire, identify, then destroy the enemy's counterair capability within seconds will be the driver behind this capability. It will also provide a more robust deterrent capability, since mobile surface and particularly space-based assets are always forward deployed, basing is not a problem, and there are no assets to move to a forward area under the global grid interconnectivity envisioned for 2025.

The forward deployment of space-based weaponry and the ability to instantly apply firepower is particularly important against the cruise and ballistic missile threat. Once the threat is identified, time is crucial. Delays in detection and identification due to active and passive stealth measures will mean the leverage found in the immediacy of figuratively putting steel on target make DE weapons a key element of our

counterair capability. The complementary nature of high energy lasers, HPM, and railgun kinetic energy weaponry will provide an all-weather, multitiered defense against the ballistic and cruise missile threat of 2025.

The result of the analysis is the identification of a need for a combination of capabilities, a synthesis of the three trajectories. The identification of the strengths and weaknesses demonstrate how the capabilities described in each trajectory complement each other. The combination yields a counterair triad that matches capabilities against threats, and best succeeds at meeting the conditions for successful mission execution described above.

Comparison

Four approaches were developed for conducting the counterair mission based on the evolutionary, penurial robophile, and virtual trajectories, plus a fourth approach defined by the system of systems combination of all three: the counterair triad. Table 1 compares each of the four approaches and maps it against a set of criteria describing the capabilities required in 2025. A four-level gray scale was developed for comparison of each approach against those criteria. On this scale, white means the criteria were not well covered or the capability is limited, with gradations up to black, meaning the criteria is well covered or the capability is robust. These criteria allow a side-by-side comparison of all four approaches to better visualize what each brings to bear in the conduct of the counterair mission.

1. *Applicability to Multiple Scenarios.* There are three types of scenarios at a high level—a regional competitor (a medium-tech, second wave adversary such as Iraq or North Korea); a peer competitor (the old USSR or a future China); and a niche competitor (terrorist/insurgency, etc.). Measure of merit: white = covers none; light gray = one of the three; dark gray = covers two of the three; black = covers all.

2. *Capability Leap.* Measures whether the capability is an evolutionary change or tends to revolutionary improvement in capability. Measure of merit: white = current capability; light gray = minor improvement in capability; dark gray = significant improvement in capability; black = order of magnitude improvement (revolutionary).

3. *Range*. Applicability to close-in (less than 150 miles), medium-range (150-1000 miles), and long-range (1000+ mile) engagements. Measure of merit: white = none; light gray = engages at one range set; dark gray = engages at two range sets; black = at all ranges.

4. *Selectivity*. Describes the range of options provided by the approach, from lethal to nonlethal. Measure of merit: white = no capability; light gray = nonlethal; dark gray = lethal; black = selective lethality (nonlethal to lethal).

5. *Response Time*. Indicates the time between the decision to employ force until action against the threat. Measure of merit: white = days; light gray = hours; dark gray = minutes; black = seconds.

6. *Flexibility*. Reflects the ability to provide a flexible response in the mission profile prior to weapons employment. Measure of merit: white = none; light gray = some; dark gray = routine; black = selective.

7. *Fragility*. Indicates the perceived cost of the loss of a single asset—aircraft, spacecraft, cruise missile, and so forth. and/or loss of life. Measure of merit: white = very high; light gray = high; dark gray = medium; black = low.

8. *Targeting*. Describes the number of potential target engagements per sortie. Measure of merit: white = single; light gray = few; dark gray = many; black = lots.

9. *Weapons Engagement Area*. Indicates the effective area the system can engage in at one time. Measure of merit: white = visual range; light gray = sensor range; dark gray = regional (beyond platform sensor range); black = global.

10. *Basing Limitations*. Describes the type of basing required for each approach. Measure of merit: white = in the area of operations; light gray = in the CINC's AOR; dark gray = CONUS; black = flexible.

11. *Cost*. Reflects the relative cost of deployment/employment of the approach in each approach. Measure of merit: white = very high; light gray = high; dark gray = moderately high; black = baseline.

From this comparison it is clear that each approach has certain strengths and weaknesses. The evolutionary approach is more achievable given today's state of the art and can accommodate more sensitive situations through direct contact of the pilot on-scene, but is more fragile and less responsive than the other two to immediate threats. The penurial robophile approach has more overall strength, but lacks some fidelity, even with ground pilots and, like the evolutionary trajectory, suffers from an inability to respond to

immediate threats. The virtual trajectory is best suited for situations requiring an immediate response (overseas threats or cruise missiles), but requires the greatest leaps in technology, most significant cost, and the most trust in the system—not necessarily a given when such significant responsibility and accountability is demanded of our people. The fourth approach—the triad—covers the approaching threat and required capabilities of 2025 best. A balance of response time, lethality, fidelity, and cost, the counterair triad allows us to respond with the right amount of force at the right time in the right place.

Table 1

Comparison of Counterair Approaches

Criteria	Approach	Evolutionary	Penurial Robophile	Virtual	Triad
Applicability					
Capability Leap					
Range					
Selectivity					
Response Time					
Flexibility					
Fragility					
Targeting					
Weapons Engagement Area					
Basing					
Cost					

The analysis of the three trajectories allows us to put in perspective a more comprehensive approach to the accomplishment of the counterair mission. Each trajectory had its own approach to the counterair problem based on a particular set of assumptions. The convergence of these trajectories leads to a solution set all its own—where the triclinic of these trajectories meets to address a wide range of threats in a variety of environments. The result of this synthesis are found in the next chapter.

Notes

¹ Col Jeffery R. Barnett, *Future War: An Assessment of Aerospace Campaigns in 2010* (Maxwell AFB, Ala.: Air University Press, January 1996), 83.

² *Ibid.*, 111.

Chapter 6

Recommendation

You should not have a favorite weapon. To become over-familiar with one weapon is as much a fault as not knowing it sufficiently well. You should not copy others, but use weapons which you can handle properly. It is bad for commanders and troopers to have likes and dislikes. These are the things you must learn thoroughly.

—Miyamoto Musashi
A Book of Five Rings

The overall requirements for the counterair mission are based on the conditions for successful mission execution described in the previous chapter. The trajectories presented reflect the need to examine the extreme ends of the scale on which counterair missions may be conducted, using an “anything but” criteria. The first trajectory examined “what if technology does not advance much, or the money is not there to implement many changes.” The second trajectory looked at how counterair would be conducted if we used anything but inhabited vehicles. The final trajectory examined how the counterair mission would be conducted using anything but aircraft. Having reviewed these potential outcomes, we realize that in 2025 the counterair mission would and must actually use a mixture of systems from each of the three. There are some common themes running through all of the trajectories, and these will be a part of the counterair mission in 2025—the need for enhanced, real-time intelligence, surveillance, and reconnaissance (ISR), using multiple modes of detection—RF, IR, EO, SAR, spectrographic analysis, laser imaging, magnetic anomaly detection, passive and active intelligence collection, and so forth. Each trajectory also clearly recognized the human propensity for visualization, and identified the need for an operations center based on a near-real-time, three-dimensional presentation of the battle space—a holographic war room. The war room will use advanced knowledge processing to synthesize a visual view of the threat based on multimode polyocular processing,

using the inputs from the many multispectral eyes available to generate a detailed image and depiction of threat capability for course-of-action generation, simulation, selection, and mission execution. The glue that holds these elements together is communications—a robust mix of dedicated military and civilian communications. The combination of information processing to allow situation awareness at a level of detail that can be tailored to the user or operation, combined with real-time simulation and observation of the friendly and enemy actions, and connected by a global grid of intermeshed communications nodes, allows prompt and sustained action in support of air operations.

The varied threat will require a mix of response capabilities—from low-threat, low-speed, nonlethal responses to high-threat, high-speed, lethal response. In each of the three trajectories, there are cases where the capability described is wholly appropriate for the situation. The high-probability second wave threat makes conventional aircraft attractive; the need for stealthy, low-cost, less personnel-intensive, AOR-specific reach and force application make uninhabited vehicles an approach whose time has come; and the need to counter high-speed, high-lethality threats such as TBMs, ICBMs, or cruise missiles, or the need to react on a moment's notice with power projection to a deployed force or ally halfway around the world makes surface- and space-based weapons an excellent choice. This drives the need for inhabited and uninhabited aircraft, as well as surface- and space-based capabilities for the world of 2025.

Concept of Operations for 2025

The counterair forces of 2025 will use the information collection, processing, distribution, and presentation methods described in each of the three trajectories. Distributed satellites, using hyperspectral collection methods, will be processed in real-time to provide everything from wide-area, synoptic views down to details on specific targets. The commander-in-chief or the joint force aerospace component commander (JFACC) of 2025 will be able to use a holographic war room to visualize the battle space, ask the battle management operations center processor to show suspected enemy courses of action, suggest friendly courses of action, and project outcomes. The friendly courses of action will be based on the nature of the threat and the CINC's intent. Simulations can be run for various combinations of friendly versus enemy COAs, and using elements of Chaos theory, projections made on the utility and chance of success of the

responses. From these, the CINC or JFACC can make the appropriate choice and implement it in near-real-time.

The key to determining which assets are required to perform the counterair mission of 2025 is a function of the threat, the required level of deterrence, disruption, or destruction of enemy air forces, and the timeliness of the required response. Minimal threats require minimal, nonlethal response, but politically sensitive operations may require feedback that is only possible with inhabited aircraft. More substantive threats, such as F-22 type aircraft or uninhabited strike aircraft such as an enemy F35, may require lethal to nonlethal responses that can range from short to long range, and varied amount of time to react, making either inhabited, UAV, or surface- or space-based response appropriate. Antiair railguns, with projectiles moving at hypersonic speeds, will provide a lethal air defense capability against enemy UAVs. At the extreme end of the spectrum, the threat may consist of hypersonic stealthy cruise missiles, theater ballistic missiles, or ICBMs where a long-range, immediate response is required, making surface- and/or space-based assets the only appropriate response (fig. 6-1). The end result is a triad approach based on threat, intended effect, and immediacy of response. The options available to the JFACC will be composed of the systems described by our three trajectories. The JFACC will apply the portion of airpower that best suits the mission objective, threat, and desired weapons effect, and his instructions will be passed via his holographic war room. The JFACC will watch his instructions being carried out and get BDA in near-real-time. The common link that will drive this capability will be communications capability. The importance of this capability cannot be over-emphasized as we look forward to 2025.

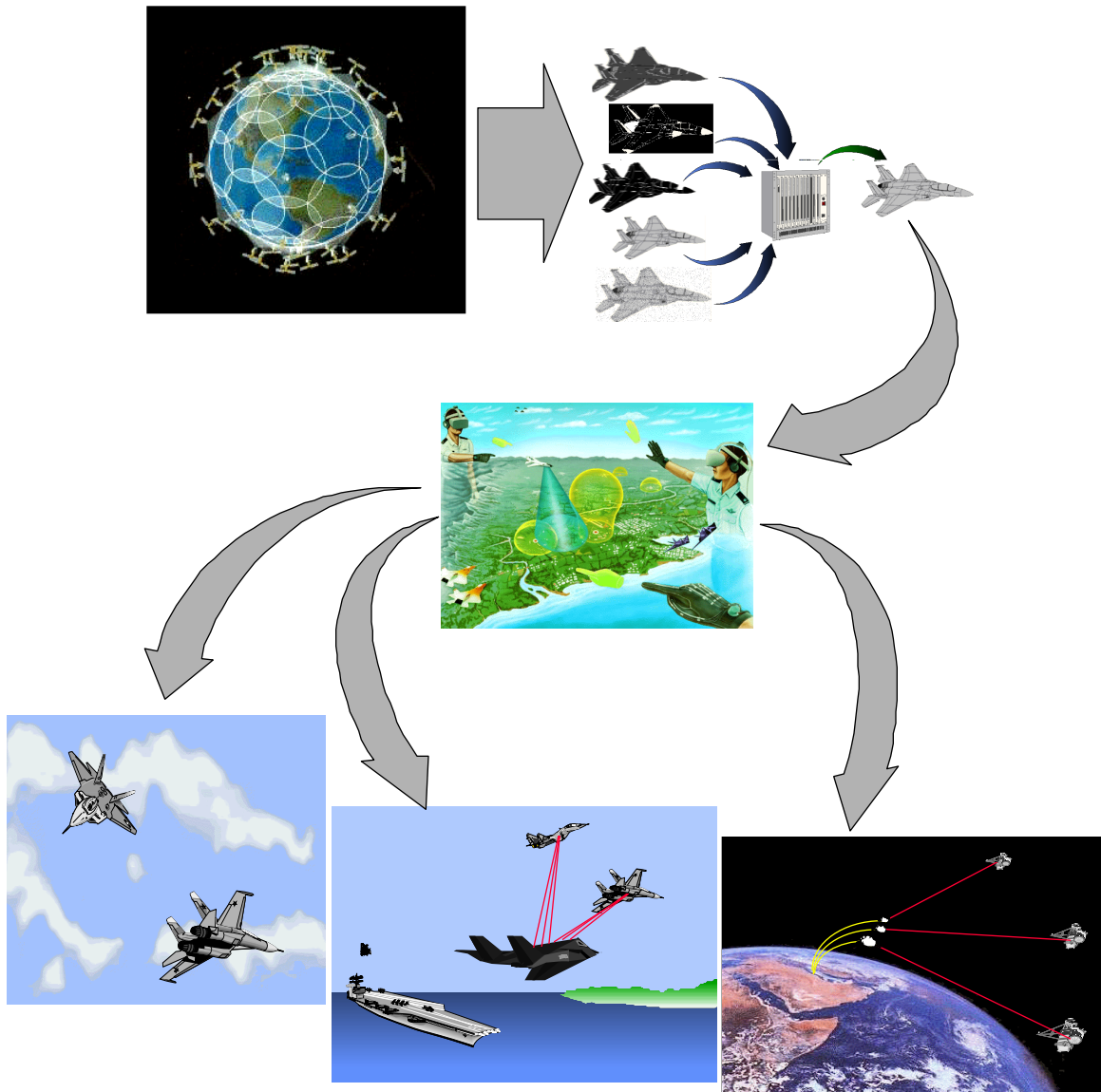

Clipart elements from Federal ClipArt © 1995 with courtesy from One Mile Up, Inc., and Microsoft Clipart Gallery © 1995 with courtesy from Microsoft Corp.

Figure 6-1. Counterair Triad Concept of Operations

The result is a concept of operations based on systems from all three trajectories. As a singular superpower in a multipolar world, the complexities of the counterair threat posed to the US will only increase. The capabilities-based response made possible by the counterair triad described above ensures the US air superiority against each of the threat environments posed above, whereas any one alone will not. The overlapping synergy of the counterair system of systems—the counterair triad—will ensure air superiority for the US in 2025 and beyond.

Conclusion

When offensive weapons make a sudden advance in efficiency, the reaction of the side which has none is to disperse, to thin out, to fall back on medieval guerrilla tactics which would appear childish if they did not rapidly prove to have excellent results.

—Gen G. J. M. Chassin

In war the chief incalculable is the human will.

—B. H. Liddell Hart

The three trajectories presented in this paper are the culmination of a comprehensive analysis of what the counterair mission might entail in the year 2025. Each was developed with an eye toward continuing and sometimes exponential technological progress and innovation. Yet, while there should be little doubt that the far-reaching advances envisioned in these approaches will play a critical role in tomorrow's military, it would not only be wrong to expect technology to be solely responsible for shaping those forces, it would be dangerous to do so. Hence, our triad—a system of systems derived from a combination of the evolutionary, penurial robophile, and virtual trajectories described in this paper. Many of the concepts depicted in this paper are common to all three trajectories, and they are easily assimilated into the triad. Other concepts can be found in only one of the postulated futures, and those that complement each other to best address the capabilities required in 2025 have been included in the recommendations.

The ability to collect and process information will be as central to the decision-making process in 2025 as it is today, and our triad relies on significant advances in this area. As previously described, stealth and weapons technology are also expected to make significant leaps in the next 30 years. The most profound changes, though, will come with better human-machine interfaces for the commanders, planners, and pilots of 2025 which will, without doubt, improve the efficiency and effectiveness of each sortie flown. But, even with an exponential technological growth, the human in the loop and on the scene will still be a requirement. Machines can be programmed to learn; machines can be programmed to react in given scenarios; machines can make decisions. However, machines cannot be programmed with the gut feel that has always been, and always will be, an integral aspect of how we fight. As long as commonsense reasoning remains the holy grail of artificial intelligence research, the best computer available will continue to be the one between the ears. The bottom line: the counterair triad will be the right capability for performing the counterair mission in

2025, while the human in the loop or on the scene, and their instincts and intuition concerning everything from gauging enemy intentions to the decision to fire weapons, will continue to be the last word on how we conduct the counterair mission.

Bibliography

- Barnett, Col Jeffery R. *Future War: An Assessment of Aerospace Campaigns in 2010*. Maxwell AFB, Ala.: Air University Press, January 1996.
- Briefing, HQ USAF/LR to the Defense Science Board, subject: Air and Space Power Framework for Strategy Development, 19 March 1996.
- Director, Test and Evaluation and Technology Requirements. "C-17 Unmanned Aerial Vehicle (UAV) Airborne Platform." *Technology Initiatives Game 95 (Systems Handbook)*, U.S. Naval War College, 18-22, September 1995.
- Casagrande, Wing Commander E. E. *Non-Lethal Weapons: Implications for the RAAF*, Air Power Studies Center Paper Number 38. Royal Australian Air Force Air Power Studies Center, November 1995.
- Director, Test and Evaluation and Technology Requirements. "Cooperative Air-to-Air/Air-to-Ground Engagements-Distributive Fire Control." *Technology Initiatives Game 95 (Systems Handbook)*, U.S. Naval War College, 18-22 September 1995.
- Director, Test and Evaluation and Technology Requirements. "Cooperative ESA Jamming." *Technology Initiatives Game 95 (Systems Handbook)*, U.S. Naval War College, 18-22 September 1995.
- Defense Airborne Reconnaissance Office. *1995 Annual Report: Unmanned Aerial Vehicles (UAVs)*. Washington, D.C.: Office of the Under Secretary of Defense, Acquisition & Technology, August 1995.
- FMFM 1, *Warfighting*, March 1989.
- Fogleman, Gen Ronald R., Address to 2025 Participants, Air War College, Maxwell AFB, Ala., 13 February 1996.
- Fulghum, David A. "International Market Eyes Endurance UAVs." *Aviation Week & Space Technology*, 10 July 1995, 40-43.
- Fulghum, David A. "Air Force Prepares New UAV Acquisitions, Operations." *Aviation Week & Space Technology*, 27 November, 1995, 52-54.
- Fulghum, David A. "Predator to Make Debut Over War-Torn Bosnia." *Aviation Week & Space Technology*, 10 July 1995, 47-48.
- FY96 Avionics Technology Area Plan*, Headquarters Air Force Materiel Command, 1995.
- FY96 Conventional Weapons Technology Area Plan*, Headquarters Air Force Materiel Command, 1995.
- "GPS Improves Military Weapons." *Aviation Week & Space Technology*, 9 October 1995, 56-57.
- Hallion, Richard P. *Storm Over Iraq - Air Power and the Gulf War*. Washington, D.C.: Smithsonian Institution Press, 1992.
- <http://leonardo.jpl.nasa.gov/msl/Quicklooks/Pictures/iridconst.gif>, Distributed Satellite Constellation graphic courtesy of Mike's Spacecraft Library.
- <http://www.afit.af.mil/Schools/PA/gall3.htm>, Representation of UAV Ground Cockpit and Holographic War Room graphics courtesy of Gene Lehman, AFIT/LSEC.
- <http://www.thomson.com:9966/janes/jpictl.html>, 360 Degree Helmet Mounted Display graphic courtesy of Geoff Fowler Media Graphics © 1995.

- Keaney, Thomas A. and Eliot A. Cohen. *The Gulf War Air Power Survey Summary Report*. Washington, D.C.: Government Printing Office, 1993.
- Knight, LCDR James Todd. "Aircraft Survivability: Vulnerability to Directed High Energy Weapons," Thesis submitted to the Naval Postgraduate School. Monterey, Calif.: Naval Postgraduate School, December 1986.
- Longino, Lt Col Dana A. *Role of Unmanned Aerial Vehicles in Future Armed Conflict Scenarios*. Maxwell Air Force Base, Ala.: Air University Press, December 1994.
- Mets, David R. *Checking Six Is Not Enough: The Evolution and Future of Air Superiority Armament*, CADRE Paper Special Series: The Future of the Air Force, no. AU-ARI-CPSS-91-14. Maxwell AFB, Ala.: Air University Press, April 1992.
- Musashi, Miyamoto. *The Book of Five Rings*. Translated by Victor Harris. Woodstock, NY: The Overlook Press, 1982.
- "New GPS 2R Satellites to Operate Autonomously." *Aviation Week & Space Technology*, 9 October 1995, 54.
- Shultz, Richard H., Jr, and Robert L. Pfaltzgraff Jr, ed. *The Future of Air Power in the Aftermath of the Gulf War*. Maxwell AFB, Ala.: Air University Press, July 1992.
- SPACECAST 2020 Executive Summary*. Maxwell AFB, Ala.: Air University Press, 1993.
- Study of Oblique Detonation Wave Scramaccelerator for Kinetic Energy Weapons and Lethality Testing*, Advanced Projects Research Inc., February 1990.
- Sweetman, Bill. "Major Milestones in US UAV Programme." *Interavia*, July/August 1995, 39-40.
- Sweetman, Bill. "UAVs for Joint Forces." *Interavia*, September 1994, 62-64.
- Szafrański, Col Richard. *GEO, LEO, and the Future*, CADRE Paper Special Series: The Future of the Air Force, no. AU-ARI-CPSS-91-2. Maxwell AFB, Ala.: Air University Press, August 1991.
- 2025 concept, no. 200006, "Unmanned Airborne Support Vehicle," 2025 concepts database (Maxwell AFB, Ala.: Air War College/2025, 1996). (PROPRIETARY)
- 2025 concept, no. 200010, "Suppression Cloud," 2025 concepts database (Maxwell AFB, Ala.: Air War College/2025, 1996).
- 2025 concept, no. 200013, "Quantum Effect Communications," 2025 concepts database (Maxwell AFB, Ala.: Air War College/2025, 1996).
- 2025 concept, no. 200014, "Molecular Inertial Navigation Sensor," 2025 concepts database (Maxwell AFB, Ala.: Air War College/2025, 1996).
- 2025 concept, no. 200015, "Distortion Field Projector," 2025 concepts database (Maxwell AFB, Ala.: Air War College/2025, 1996).
- 2025 concept, no. 200023, "Surveillance Swarm," 2025 concepts database (Maxwell AFB, Ala.: Air War College/2025, 1996).
- 2025 concept, no. 900135, "Offensive Unmanned Aerial Vehicle," 2025 concepts database (Maxwell AFB, Ala.: Air War College/2025, 1996).
- 2025 concept, no. 900136, "Stealth IR Signature of Turbine Propulsion," 2025 concepts database (Maxwell AFB, Ala.: Air War College/2025, 1996).
- 2025 concept, no. 900161, "Holographic C2 Sandbox," 2025 concepts database (Maxwell AFB, Ala.: Air War College/2025, 1996).
- 2025 concept, no. 900172, "Miniature Precision Targeting UAV," 2025 concepts database (Maxwell AFB, Ala.: Air War College/2025, 1996).

2025 concept, no. 900202, "Space-based Special Operations Forces," 2025 concepts database (Maxwell AFB, Ala.: Air War College/2025, 1996).

2025 concept, no. 900211, "LADAR Identification Friend or Foe," 2025 concepts database (Maxwell AFB, Ala.: Air War College/2025, 1996).

2025 concept, no. 900233, "The Very Small, Very Smart Bomb," 2025 concepts database (Maxwell AFB, Ala.: Air War College/2025, 1996).

2025 concept, no. 900239, "Space-based Missiles with Photo Warheads," 2025 concepts database (Maxwell AFB, Ala.: Air War College/2025, 1996).

2025 concept, no. 900244, "Global Positioning System Guided Munitions," 2025 concepts database (Maxwell AFB, Ala.: Air War College/2025, 1996).

2025 concept, no. 900258, "Oxygen Sucker," 2025 concepts database (Maxwell AFB, Ala.: Air War College/2025, 1996).

2025 concept, no. 900278, "Real-Time Virtual Uplink with Unmanned Aircraft," 2025 concepts database (Maxwell AFB, Ala.: Air War College/2025, 1996).

2025 concept, no. 900288, "Swarms of Micro-Machines," 2025 concepts database (Maxwell AFB, Ala.: Air War College/2025, 1996).

2025 concept, no. 900299, "Hunter-Killer Attack Platform," 2025 concepts database (Maxwell AFB, Ala.: Air War College/2025, 1996).

2025 concept, no. 900313, "Spaceborne/Airborne Hologram," 2025 concepts database (Maxwell AFB, Ala.: Air War College/2025, 1996).

2025 concept, no. 900317, "Tactical Information Display Helmet," 2025 concepts database (Maxwell AFB, Ala.: Air War College/2025, 1996).

2025 concept, no. 900336, "Cloaking," 2025 concepts database (Maxwell AFB, Ala.: Air War College/2025, 1996).

2025 concept, no. 900359, "Air-to-Air Missile Interdiction," 2025 concepts database (Maxwell AFB, Ala.: Air War College/2025, 1996).

2025 concept, no. 900364, "Bionic Eye," 2025 concepts database (Maxwell AFB, Ala.: Air War College/2025, 1996).

2025 concept, no. 900365, "Sensor Cockpit," 2025 concepts database (Maxwell AFB, Ala.: Air War College/2025, 1996).

2025 concept, no. 900371, "Automated Space Sentries," 2025 concepts database (Maxwell AFB, Ala.: Air War College/2025, 1996).

2025 concept, no. 900385, "3-D Holographic Battlefield Display," 2025 concepts database (Maxwell AFB, Ala.: Air War College/2025, 1996).

2025 concept, no. 900392, "Acoustic Weapon," 2025 concepts database (Maxwell AFB, Ala.: Air War College/2025, 1996).

2025 concept, no. 900405, "Weapon Health Monitoring," 2025 concepts database (Maxwell AFB, Ala.: Air War College/2025, 1996).

2025 concept, no. 900414, "Artificial Intelligence: A New Aircrew Member in Tomorrow's Combat," 2025 concepts database (Maxwell AFB, Ala.: Air War College/2025, 1996).

2025 concept, no. 900417, "Battlespace Awareness Holosphere," 2025 concepts database (Maxwell AFB, Ala.: Air War College/2025, 1996).

2025 concept, no. 900436, "Runway Targeting Smart Munition (RTSM)," 2025 concepts database (Maxwell AFB, Ala.: Air War College/2025, 1996).

2025 concept, no. 900441, "The Uninhabited United States Air Force," 2025 concepts database (Maxwell AFB, Ala.: Air War College/2025, 1996).

2025 concept, no. 900481, "Destructo Swarmbots," 2025 concepts database (Maxwell AFB, Ala.: Air War College/2025, 1996).

2025 concept, no. 900500, "Unmanned Fighter Bomber," 2025 concepts database (Maxwell AFB, Ala.: Air War College/2025, 1996).

2025 concept, no. 900508, "Magnetic Detection of Aircraft," 2025 concepts database (Maxwell AFB, Ala.: Air War College/2025, 1996).

2025 concept, no. 900522, "Space-Based AI-Driven Intelligence Master Mind System," 2025 concepts database (Maxwell AFB, Ala.: Air War College/2025, 1996).

2025 concept, no. 900526, "Space-Based Airspace Control & Deconfliction System," 2025 concepts database (Maxwell AFB, Ala.: Air War College/2025, 1996).

2025 concept, no. 900528, "Stealthy Lethal UAV," 2025 concepts database (Maxwell AFB, Ala.: Air War College/2025, 1996).

2025 concept, no. 900550, "Personal Digital Assistant," 2025 concepts database (Maxwell AFB, Ala.: Air War College/2025, 1996).

2025 concept, no. 900554, "Adaptive Munitions," 2025 concepts database (Maxwell AFB, Ala.: Air War College/2025, 1996).

2025 concept, no. 900555, "Sensor-to-warhead Operations," 2025 concepts database (Maxwell AFB, Ala.: Air War College/2025, 1996).

2025 concept, no. 900573, "Dielectric Materials For Stealth," 2025 concepts database (Maxwell AFB, Ala.: Air War College/2025, 1996).

2025 concept, no. 900580, "In-Flight Air Refueling/Rearming of Strike UAVs," 2025 concepts database (Maxwell AFB, Ala.: Air War College/2025, 1996).

2025 concept, no. 900605, "Active Cloaking Film/'Paint'," 2025 concepts database (Maxwell AFB, Ala.: Air War College/2025, 1996).

2025 concept, no. 900619, "Panoramic Night Vision Goggles," 2025 concepts database (Maxwell AFB, Ala.: Air War College/2025, 1996).

2025 concept, no. 900638, "Autonomous Smart Bombs," 2025 concepts database (Maxwell AFB, Ala.: Air War College/2025, 1996).

2025 concept, no. 900647, "Jet Exhaust Tracking AAMS/SAMS," 2025 concepts database (Maxwell AFB, Ala.: Air War College/2025, 1996).

2025 concept, no. 900675, "Ordnance Enroute Reporting," 2025 concepts database (Maxwell AFB, Ala.: Air War College/2025, 1996).

2025 concept, no. 900676, "Defense of Missile-Delivered, Multiple Conventional Warheads," 2025 concepts database (Maxwell AFB, Ala.: Air War College/2025, 1996).

2025 concept, no. 900777, "Smart Structure Aircraft," 2025 concepts database (Maxwell AFB, Ala.: Air War College/2025, 1996).

"UAV Force concept." *Aviation Week & Space Technology*, 10 July, 1995, 42-43.

USAF Scientific Advisory Board. *New World Vistas: Air and Space Power for the 21st Century*, Summary Volume. Washington, D.C.: USAF Scientific Advisory Board, 15 December 1995.

USAF Scientific Advisory Board. *New World Vistas: Air and Space Power for the 21st Century*. Unpublished draft, the Directed Energy Volume. 15 December 1995.

Director, Test and Evaluation and Technology Requirements. "Unmanned Tactical Aircraft concept," *Technology Initiatives Game 95 (Systems Handbook)*, U.S. Naval War College, 18-22 September 1995.

van Creveld, Martin L. *The Transformation of War*. New York: The Free Press, 1991.

Star Tek—Exploiting the Final Frontier: Counterspace Operations in 2025



A Research Paper
Presented To

Air Force *2025*

by

Lt Col Robert H. Zielinski
Lt Col Robert M. Worley II
Maj Douglas S. Black
Maj Scott A. Henderson
Maj David C. Johnson

August 1996

Disclaimer

2025 is a study designed to comply with a directive from the chief of staff of the Air Force to examine the concepts, capabilities, and technologies the United States will require to remain the dominant air and space force in the future. Presented on 17 June 1996, this report was produced in the Department of Defense school environment of academic freedom and in the interest of advancing concepts related to national defense. The views expressed in this report are those of the authors and do not reflect the official policy or position of the United States Air Force, Department of Defense, or the United States government.

This report contains fictional representations of future situations/scenarios. Any similarities to real people or events, other than those specifically cited, are unintentional and are for purposes of illustration only.

This publication has been reviewed by security and policy review authorities, is unclassified, and is cleared for public release.

CONTENTS

<i>Chapter</i>		<i>Page</i>
	Disclaimer	ii
	Illustrations.....	iv
	Tables.....	v
	Executive Summary	vi
1	Introduction.....	1
2	Framing The Challenge	3
	Space as a Vital National Interest	4
	The Road to Weapons in Space	6
	The Growing Need for Counterspace Capability	8
	Proliferation of Access to Space Systems.....	8
	System Vulnerabilities in 2025	10
	Threats to Space Systems in 2025.....	11
3	Key Technologies And System Descriptions	13
	Space Detection and Targeting.....	13
	Gravity Gradiometer	13
	Anti-ASAT System	15
	Space Interdiction Net.....	16
	Miniaturization.....	20
	Satellite Bodyguards	22
	Robo-Bug.....	25
	Space Stealth.....	28
	Satellite Cloaking.....	29
	Kinetic Energy Weapons.....	32
	Satellite Multiple Attack and Kill System.....	32
	Alpha Strikestar Transatmospheric Vehicle.....	34
	Directed Energy Weapons (DEW).....	35
	High Energy Laser Attack Station (HELAS).....	36
	Solar Energy Optical Weapon (SEOW).....	38
	Electromagnetic Pulse (EMP) and High Power Microwave (HPM) Pills	40
	Ground-Based Laser (GBL)	42
4	Concept of Operations For a Counterspace Architecture	47
	Offensive Counterspace Operations.....	47
	Defensive Counterspace Operations	49
5	Investigation Recommendations.....	51
	Future Concepts—A System Analysis.....	52

<i>Appendix</i>	<i>Page</i>
A Evolving Space Doctrine in the 90s	56
Space Superiority as an Air Force Core Competency	56
Evolving Space Superiority Doctrine	58
Offensive Counterspace	60
Defensive Counterspace.....	60
How the Air Force Does Counterspace Today	61
Bibliography.....	63

Illustrations

<i>Figure</i>	<i>Page</i>
2-1. Joint War-fighting 2010: A “System of Systems.”	3
3-1. Gravity Gradiometer.....	14
3-2. Anti-ASAT System.....	15
3-3. Space Interdiction Net.	17
3-4. Satellite Bodyguards Protecting a High-Value Space Asset.....	22
3-5. Robo-bug Microsats in Action.....	25
3-6. Nanotechnology Cloaking System.....	30
3-7. Satellite Multiple Attack and Kill System	33
3-8. Alpha Strikestar TAV.....	34
3-9. HELAS.....	37
3-10. Solar Energy Optical Weapon.	39
3-11. EMP/HPM Pill.	41
3-12. Ground-Based Lasers.....	43
4-1. Offensive Counterspace architecture.	48
4-2. Defensive Counterspace Operations.....	50
A-1. Core Competencies.....	57

Tables

<i>Table</i>		<i>Page</i>
1	Proposed LEO Communications Systems.	9
2	Offensive Counterspace Options.	26
3	System Analysis Score Sheet: Miniaturization, Stealth, and Detection/ Targeting Concepts.....	53
4	System Analysis Score Sheet: Kinetic Energy and Directed Energy Concepts.....	54

Executive Summary

Space superiority, like air superiority today, will be a vital core competency in the year 2025. US national security is already heavily leveraged in space—a trend which will increase in the future. Likewise, other countries and commercial interests will continue to seek the valuable “high ground” of space. Where space interests conflict, hostilities may soon follow. Protecting the use of space and controlling, when required, its advantage is the essence of counterspace.

This paper demonstrates the need for, and the means by which, counterspace operations will be conducted in the year 2025. A number of factors will drive the need for a robust counterspace capability in 2025. Space will be seen as a vital national interest based on its significant role in maintaining national security. In addition, the ability to operate freely in the space theater of operations will drive the United States (US) to implement capabilities to protect its vast array of space platforms as well as those of its friends and allies. Finally, the importance of space assets in achieving information dominance will force a serious examination of the requirement for developing offensive counterspace capabilities and placing nonnuclear weapons in space.

In order to field credible and effective counterspace capabilities, the US must take advantage of current leaps in computer technologies and nurture advances in other areas. Successes in miniaturization technologies, such as nanotechnology and microelectromechanical systems, will spawn advances in space detecting and targeting capabilities and space stealth technologies. In turn, kinetic and directed energy weapon systems will likely constitute the backbone of future offensive and defensive counterspace capabilities. A counterspace architecture must and will integrate enemy target detection, target identification, command and control, defensive counterspace capabilities, and offensive counterspace capabilities to expand the options available to future commanders.

The focus we place today on counterspace requirements will directly impact the space forces we field in year 2025. This paper identifies the need for counterspace and provides a variety of concepts to do the job. Each concept includes a system description, a concept of operations, and a discussion of possible

countermeasures. Finally, a systems analysis of counterspace concepts yields recommendations on key systems which should pay the greatest dividends in both the commercial and military arena. Offensive counterspace concepts recommended for future development are parasite microsatellites (robo-bugs), transatmospheric vehicles (TAVs), and a ground based laser system. Defensive systems include a space interdiction net capable of detecting and intercepting satellite signals and miniature satellite body guards to protect high-value space assets. These systems will form the backbone of systems which should be pursued in order to ensure US space superiority in 2025.

Chapter 1

Introduction

The year is 2025. Somewhere in a low-earth orbit, a US-owned communications satellite, one of dozens, quietly and unexpectedly goes off the air. Ground controllers with their extensive computerized control systems are puzzled but surprisingly not alarmed. They should be.

Unknown to them, or to the United States (US) defense community, a consortium of rogue nation-states and organized crime cartels has just tested their new, hi-tech satellite blinder. The threat to the single satellite is formidable. The threat to US national security will be devastating when these satellite blinders can target multiple satellites simultaneously. This nightmare happens less than a year later. In an unexpectedly swift and decisive move, links to US military forces worldwide are cut, global positioning system (GPS) navigation is virtually nonexistent, and a majority of US commercial and military reconnaissance returns are nothing but static. Unfortunately, US counterspace capabilities failed in this fictional glimpse into the future.

This paper's purpose is to demonstrate the need for, and the means by which, counterspace operations will be conducted in year 2025. The future, specifically by the year 2025, will see many nations capitalizing on the vantage point of space for both commercial and military reasons. The US will continue its growing reliance on military and commercial space-based capabilities. To protect those capabilities and, when necessary, deny similar capabilities to adversaries, the US must be able to conduct counterspace operations to achieve space superiority.

In building the case for counterspace operations, we make no limiting assumptions. We expect space will be as open and accessible in 2025 as air travel is today through international airspace. The pervasive nature of space assets will foster the broad use of space by most of the nations of the world. Protecting the

use of space and controlling, when required, its omnipresent potential advantages is the essence of counterspace.

This paper first frames the counterspace challenge by emphasizing the urgent and compelling need for a counterspace capability in the 2025 time frame. The discussion then turns to the road to weapons in space and the current proliferation of space capabilities today. Next, we describe counterspace system concepts that will add credibility and substance to future US counterspace operations. These concepts are organized within five technology categories:—(1) space detection and targeting, (2) miniaturization, (3) space stealth, (4) kinetic energy weapons, and, (5) directed energy weapons. Some concepts stretch the imagination but undoubtedly will lay a foundation for what the future space fleet should look like. Next, the concepts are woven into a space defense network to illustrate a system connectivity and concept of operations. Finally, the paper makes some investigative recommendations for future procurement and technology assessments.

Chapter 2

Framing The Challenge

Space superiority will be a key pillar in the war-fighting doctrine of the future. In developing joint doctrine for the twenty-first century, the Joint Warfighting Center (JWC) emphasizes the integration of three capabilities—precision engagement, battlespace awareness, and enhanced Command, Control, Communications, Computers, and Intelligence (C⁴I)—to form a “system of systems.”¹

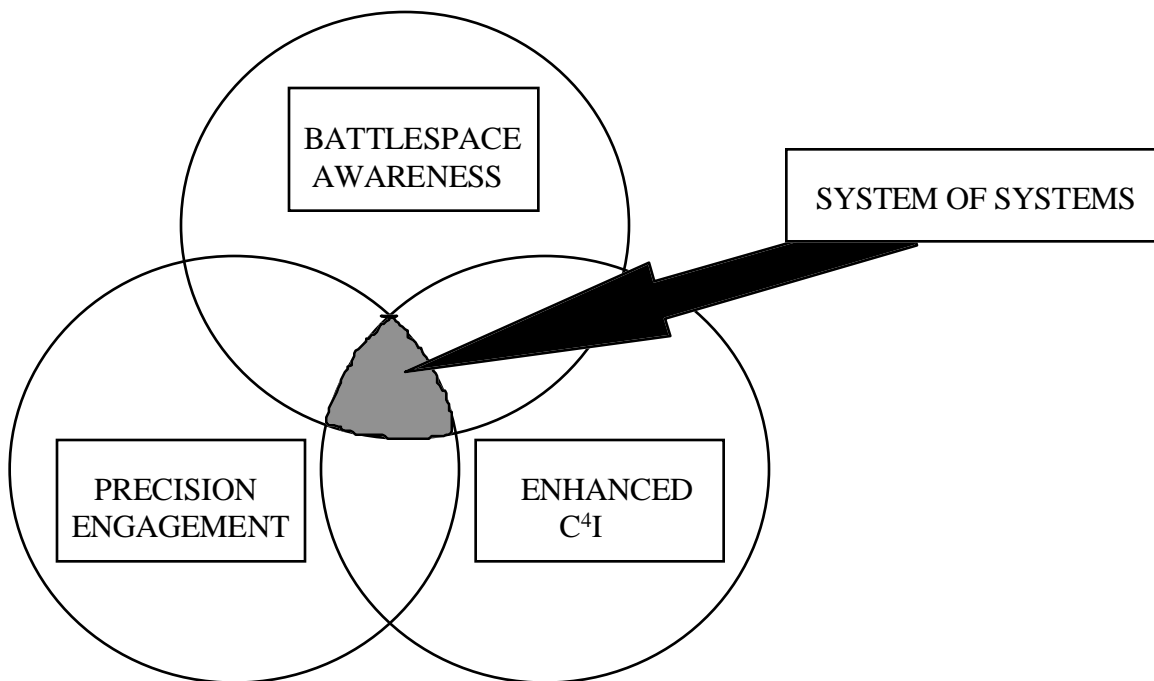

Figure 2-1. Joint War-fighting 2010: A “System of Systems.”

The combined effects of such future capabilities as sensor-to-shooter linkage, real-time situational awareness, precise knowledge of the enemy, exponential increases in data processing, and modern command and control systems will increase US destructive effectiveness above that of any competitor.

In the 2025 time frame, each of these capabilities could be performed solely from space, or, if not, will rely heavily on space systems. Battlespace awareness will be gained through spaceborne intelligence gathered in all spectra to turn battlespace awareness into knowledge. Battlespace awareness also includes information warfare. In a world heavily reliant on satellite communications, space will be a critical battlefield in any enemy's information war. Enhanced C⁴I will rely on space technology to identify important targets, handle data provided by the expansion of sensors, and transfer information to the weapons or forces best suited for the engagement. Precision engagement will invariably be dependent upon enhanced satellite global positioning data, space assisted targeting capabilities, and satellite communications to tell the shooter where to put bombs on target. This type of war-fighting framework will rely heavily on space capabilities. Because of this growing reliance on space, a vigorous counterspace capability will be required to protect US capabilities and deny the enemy any advantage to be gained from the employment of their space assets.

Space as a Vital National Interest

In order to understand the importance of counterspace operations to the air and space environment in 2025, it is important to identify why space will be important to our US national interests. In addition to its role as a key enabler of future joint war-fighting doctrine, counterspace capabilities will be driven by three other significant factors in 2025. First, space will contain interests vital to US national security. Second, the US will continue to look at the freedom to operate in space just as we look at the freedom to operate in international airspace or international waters today. Third, the US will depend on unimpeded space operations for achieving information dominance.

Traditionally, the US has gone to war over only those most critical issues deemed vital interests. Historically, space has never been seen to contain such vital interests. US space systems have not yet been attacked. However, the evolution of space as a strategic necessity in the protection of US vital interests will very likely make space assets themselves vital to the protection of US sovereignty. The compelling question is: Will the US consider it an act of war if a critical space asset is intentionally degraded or destroyed in the

future? As a point of comparison, Soviet space strategy envisioned space as an extension of the terrestrial and maritime battlefield.² As a result, any attack on their space-based warning system is a threat to which armed force, including nuclear force (if coupled with other signs of preemployment or preparation) might be the reply.³ If the destruction of a satellite or its command and control segment leads to the loss of American lives, this should be seen no differently than the shutdown of a C-17 loaded with airborne troops. Another scenario is one in which space-based intelligence, degraded by an enemy, causes the Federal Bureau of Investigation to fail to stop a terrorist bombing which might have been avoided with unspoiled space-based information. Will this be tolerated in 2025? The ramifications of a failure to achieve and maintain space superiority are far reaching to the civilian as well as the military population.

Gen Charles Horner, former commander in chief, United Space Command, envisioned his worst nightmare as seeing an entire Marine battalion wiped out on some foreign landing zone because he was unable to deny the enemy intelligence and imagery garnered from space assets.⁴ Horner emphasized the need to operate our own space systems while developing and deploying the capability to negate an adversary's use of space to support hostile military or terrorist forces. The means to accomplish these goals lie in the ability to perform the counterspace mission. Options for space system negation are bounded only by methods available to attack an enemy. Hard kill can be accomplished by directly targeting the satellite with kinetic or directed energy weapons or by attacking ground-based control facilities or launch sites. Soft kill methods include jamming or intruding the satellite signal or targeting the communication links or ground stations.⁵

In addition to protecting our satellites and denying the enemy the ability to use space against us, the US must preserve its freedom of action in space. In a future where space is equivalent to international airways or seaways of today, the US must be able exercise an equivalent freedom of passage in space. This includes operating military and commercial satellites when and where they are needed. The increasing impact of space systems on military, political, and economic policy make the freedom to operate in this medium critical to US prosperity. Commercial interests using space today range from global telecommunications to global positioning. Ultimately, ensuring freedom of navigation to friends and allies will serve to enhance US prestige abroad in support of national security objectives. This will require the ability, through force if necessary, to assure friendly space assets the ability to freely operate in space.

Space superiority, gained and maintained through offensive and defensive counterspace actions, supports the concept of information dominance. The main product of space systems is information. From communications to imagery, weather, or remote sensing, satellites provide information which today is used by a broad spectrum of clients. Identified as a significant part of the battlefield of the future, information warfare may be a new type of strategic warfare.⁶ In the future, space will be inextricably tied to information and thus information warfare. Information dominance can mean the difference between success and failure of diplomatic initiatives, successful crisis resolution or war, or forfeiture of the element of surprise. Therefore, the ability to attain information dominance can widen the gap between friendly actions and enemy reactions. On the other hand, failure to achieve information dominance at the onset of hostilities could lead to the inability of friendly forces to conduct military operations successfully.⁷ While this paper does not go into any further discussion of information warfare, it seeks to point out the value of space assets (and therefore vigorous counterspace actions) to achieving information dominance in the future.

In order to protect vital interests in space, ensure freedom of space navigation, and achieve information dominance, the US will eventually require weapons in space. The need to counter future space threats and minimize US space vulnerabilities will drive the American people to accept the inevitable—weapons in space. A discussion of the political, policy, and treaty ramifications of weapons in space will highlight some of the existing hurdles to such a venture.

The Road to Weapons in Space

This paper proposes that by year 2025 the US, and indeed the world, will be so reliant on space systems that space superiority will be of vital importance. This in turn will require the placement of force application weapon systems in space for defense against attack and to carry out offensive actions as necessary. Many futurists, both military and civilian, have hailed the rapid development of technology and have predicted the placement of weapons in space. Many say it is inevitable. There is, however, much more to this question than technological capabilities or some kind of intuitive sense of destiny. It is a significant leap from the current political mindset about space use, to a new mindset which supports placing force application platforms in space. The obstacles to placing weapons in space lie in the following three general areas which are not mutually exclusive: international space treaties, policy, and the space sanctuary illusion.

So the question remains, What will be the road to weapons in space? What preconditions will be necessary in the areas of treaties, politics, policy, and social perspective that will lead our military and political leaders to actually break that self-imposed, invisible boundary? There are several treaties which deal with various aspects of military space activities. These include the Limited Test Ban Treaty (1963), the Outer Space Treaty of 1967, and the Antiballistic Missile (ABM) Treaty (1972). The only specific prohibition to weapons in space deals with weapons of mass destruction.⁸ The current administration has been negotiating with Russia on modifying the ABM Treaty, which prohibits space-based ABM systems, in order to allow for development and deployment of more capable theater missile defense. Some say the ABM Treaty is a product of the cold war whose time has past. Others say the US should just abrogate it outright. Many are now talking about changing the treaty or abandoning it altogether. It seems possible that the ABM Treaty is on the verge of significant change which may remove one of the main treaty obstacles to force application in space.

With respect to national policy, we have come a long way from Dwight D. Eisenhower's fundamental principles that US space activity would be devoted to peaceful purposes for the benefit of all mankind. More recently, President George H. Bush's policy specified defense against enemy space attack and assuring freedom of action in space.⁹ One could certainly argue that based on the changes in national policy, an important part of the "road" has already been traveled. Having a national policy that calls for force application from space is a good place to start. The problem is policy is meaningless if the nation's leaders lack the will to implement it or support those who try to implement it. Our national politicians need to recognize the critical nature of space systems, space vulnerabilities, and the need to support pursuing space control and force application capabilities in space. This awakening must occur before a crisis arises and before an antagonistic nation either attacks or deploys the capability to destroy US space assets and holds the nation hostage. Shifts in political will may be forming today as the Congress has been trying to pass legislation to deploy a national missile defense system.

Public will is another matter and is something infinitely difficult to assess. Focusing closer to home, the American people must be asked, "Are you comfortable with the idea that some rogue nation is able to destroy both military and civilian satellites causing you to lose your cable TV, your cellular phone, and the navigation system that guides you to your favorite fishing hole." All things considered, it seems reasonable to

predict by 2025 the US will have mustered the political and social will, in recognition of the absolute criticality of assured freedom of operation in space, to get over the sanctuary hurdle and place the necessary space force structure in place.

The Growing Need for Counterspace Capability

In order to understand why a counterspace capability will be critical in 2025, it is only necessary to look at recent developments which point to the explosive growth in usage of space assets worldwide. As both commercial needs and military missions are increasingly met via space systems, the ability to protect the sovereignty of US and friendly satellites will grow in importance. Make no mistake—there is a potential threat. With the intent to “deny the use of outer space to other states,” the former Soviet Union developed and tested anti-satellite (ASAT) weapons in the 1960s and 1970s.¹⁰ Moreover, a stated high-priority Soviet objective in the late 1980s was a space-based high-energy laser ASAT weapon to complement their current ASAT capable systems.¹¹ Based on these developments, it is reasonable to assert that a number of nations will develop an ASAT capability over the next 30 years.

Proliferation of Access to Space Systems

United States. The US is critically dependent on space. Communication, navigation, intelligence gathering, and weather observation are just a few of the areas in which the US has leveraged its future into space. This investment vigor extends to the commercial arena as well. Numerous domestic and international businesses have committed large sums of capital in order to deliver products and services to the customer. According to the *New World Vistas: “Space Applications Volume,”* in the commercial telecommunications area alone, six different constellations will become operational in the late 1990s.¹²

Table 1

Proposed LEO Communications Systems.

	COMPANY	# SATELLITES	ORBIT/ INCLINATION	COST	IOC
TELEDESIC	MICROSOFT/MCCAW	900 (40+4 IN EACH PLANE)	21 PLANES 98.2 DEG SUN SYNC	\$15B	2001
IRIDIUM	MOTOROLA, LOCKHEED	66 (+ 7 SPARES)	6 PLANES/ 11 EACH	\$3.4B	1994
GLOBAL STAR	LORAL, QUALCOM & SPACE SYS	48 (6x8) +8 SPARES	8 PLANES 52 DEG	\$1.8B	1997
ELLIPSO	ELLIPSAT CORP/ WESTINGHOUSE FAIRCHILD	14-18	ELLIPTICAL 63.4 DEG	\$650M	1998 (?)
ODYSSEY	TRW	12-15	55 DEG 3 PLANES 4 SAT	\$1.3B	1999
ARIES (FORMERLY)	CONSTELLATION COM, INC. & DEFENSE SYSTEMS	48 (4x12)	4 PLANES CIRCULAR	\$300M	1994

Source: USAF Scientific Advisory Board, *New World Vistas: Air and Space Power for the 21st Century* (unpublished draft, the space applications volume, 15 December 1995), 7.

In addition to the explosive commercial growth in space, the military continues to press the strategic advantage that control of the space domain offers. Desert Storm can arguably be designated the “First Space War.” From weather forecasting to target intelligence, US success relied heavily on spaceborne systems. National assets, combined with our GPS constellation, increased the accuracy of our forces, both in, and out of the Kuwait/Iraq theater. The defense satellite program (DSP) system provided tactical warning of Scud launches within minutes, enabling our defense forces to come to their highest alert and defeat the threat. More so than in any past conflict, connectivity between the fielded forces and the commander make information and decisions instantly available to the one who needed it most—the war fighter. As the US depends more and more on precision as a force multiplier, the ability to detect, identify, and target threats will become paramount. To counter increasingly mobile enemy forces, this ability needs to be either real time or near real time. Space offers a medium for near instantaneous, cheap communications. It offers the possibility of continuous surveillance plus highly accurate positioning. In Jeffery Barnett’s book, *Future War*, he called these “war-deciding capabilities.”¹³ As such, our space capabilities must be protected and the enemy’s capability must be negated.

The “Rest” of the World. Other economic and military powers also recognize the value of space. The European Community, the Commonwealth of Independent States, Japan, and China, just to name a few, all have active launch programs deploying assets into space. While our future quarrel may not be with the

“owner” of the space asset, the enemy’s ability to access the information could be very detrimental to our cause. Even in 1991 the “CNN factor” was significant. Saddam Hussein certainly had his television on, even if he could not talk to his troops.

The Teal Group Corporation, a defense and aerospace analysis firm, identified 949 spacecraft that have been funded or scheduled for launch from 1995 to 2004.¹⁴ It is likely that the end of defense export restrictions on sales of computers will allow many countries to manipulate, store, and disseminate medium-resolution data, such as that offered by satellite positioning and tracking (SPOT) and LANDSAT, and make the imagery vastly more useful to foreign militaries. By encouraging US concerns to become commercial leaders in selling imagery as fine as one meter resolution, the government hopes to discourage many other nations from developing their own systems or buying services elsewhere.¹⁵

These current capabilities, demonstrated by multiple countries, are a loud warning to the US to maintain its edge in space technology. Improved capability can be expected in the future. The increase in satellite information vendors means organizations without space capability can purchase the end product from a wide variety of sources.

System Vulnerabilities in 2025

Most, if not all, space systems have three segments: space, ground, and user. Using a communication satellite system as an example, the space segment is the actual satellite. The ground segment likely consists of one or more stations that control customer access to the satellite. The user segment is the customer, the person who is trying to communicate, as well as any user equipment.

Each segment has its own vulnerabilities in a combat environment. Capabilities described later in this paper may make satellites the most lucrative targets to attack, while the political situation may make such an attack untenable. The US may be able to strike a satellite system because it is supplying a third country with intelligence, but unwilling to do so because we are engaged in talks of a delicate nature over a separate issue. Using the same rationale, the ground segment may be too politically sensitive because of its location. In reality, the user segment may be the most politically acceptable target, but it is practically invulnerable due to its dispersed nature.

Existing US technology can strike all segments of space assets. Demonstrated F-15 (ASATs) takes low-earth-orbit systems targets today.¹⁶ Extensions of this, and other technologies discussed later, will make medium earth orbit and high earth orbit systems vulnerable in 2025. Ground and user segments today are vulnerable to both conventional and nonconventional attack.

Threats to Space Systems in 2025

There will be multiple threats to space-based systems in the future. Some will involve threats to the space segment, some the ground, and some the user. These threats could or will come from current conventional forces, space-based forces, or other advanced technology ground/air forces. These threats can be extensions of today's technology, such as F-15 ASAT derivatives or the detonation of nuclear weapons in space. Another possibility will result from leaps in technology that enable realistic directed energy, kinetic energy, and electromagnetic pulse (EMP) based weapons to be directed to individual targets.

To this point, the discussion has focused on the need for counterspace capabilities in 2025 and the challenges facing US forces in gaining and maintaining space superiority. The next section describes key technology areas, ranging from space detection and targeting to directed energy weapons, as well as specific concepts and capabilities, which will enable US commanders to absolutely control the high ground in 2025.

NOTES

¹ Joint Warfighting Center Doctrine Division, *Warfighting Vision 2010 (Draft)* (Fort Monroe, Va.: 1995), 10.

² Gen John L. Piotrowski, "A Soviet Space Strategy," *Strategic Review*, Fall 1987, 56.

³ *Ibid.*, 57.

⁴ Prepared statements of Gen Charles Horner, commander in chief, United States Space Command, in Senate, *Space Seen as Challenge, Military's Final Frontier* (Defense Issues, Prepared Statement to Hearings before the Senate Armed Services Committee, 90th Cong., 1 sess., 1993), 7.

⁵ *Ibid.*

⁶ Barry R. Schneider, "Battlefield of the Future," *The Revolution in Military Affairs* (Maxwell AFB, Ala.: Air University Press, 1995), 80.

⁷ Maj James G. Lee, *Counterspace Operations for Information Dominance* (Maxwell AFB, Ala.: Air University Press, 1995), 4.

⁸ AU-18. *Space Handbook*. Vol. 1, *A Warfighter's Guide to Space* (Maxwell AFB, Ala.: Air University Press, 1993), 55-56.

⁹ *Ibid.*, 103.

¹⁰ Nicholas L. Johnson, *Soviet Military Strategy in Space* (New York: WW Norton and Co., 1986), 155.

¹¹ Capt Gregory C. Radabaugh, "Soviet Antisatellite Capabilities," *Signal*, December 1988, 81-83.

¹² USAF Scientific Advisory Board, *New World Vistas: Air and Space Power for the 21st Century* (unpublished draft, the space applications volume, 15 December 1995), 7.

¹³ Jeffery R. Barnett, *Future War, An Assessment of Aerospace Campaigns in 2010* (Maxwell AFB, AL: Air University Press, 1996), 41.

¹⁴ James R. Asker, "Space Control," *Aviation Week & Space Technology*, 23 May 1994, 57.

¹⁵ *Ibid.*, 51.

¹⁶ While the technology demonstration program validated the concept, F-15 ASAT missiles and warheads were not maintained after cancellation of the program.

Chapter 3

Key Technologies And System Descriptions

Space Detection and Targeting

General Discussion. The linchpin in delivering a critical blow to an enemy system anywhere in the expanse of the air and space environment is accurate detection and targeting. This capability is crucial in providing total battlespace situational awareness. To make this happen, significant advances are required in radar, laser, and infrared detecting and tracking technologies. While "detecting and targeting" imply offensive capabilities, they also lead to formidable defensive capabilities in countering enemy kinetic energy weapon (KEW) and directed energy weapon (DEW) attack.

In order to defend against an ASAT, for example, the defending satellite (or its controlling system) must be able to detect approaching threats in order to defensively react. Defensive traits must go beyond today's satellite hardening and limited space maneuvering. In 2025, space systems must be able to organically detect intruders, have built-in stealth characteristics, and if needed, be able to actively defend against attack. The following concepts explore some system possibilities intended to give the space force commander dominant battlespace awareness.

Gravity Gradiometer

System Description. Gravity gradiometers are instruments and systems that detect mass density contrasts. Recent gravity gradiometer research has focused on sea-based submarine detection applications.¹ This concept goes several leaps forward and proposes its use in space as a passive detection system.

Concept of Operations. With multiple gravity gradiometers located on multiple satellites in orbit, approaching “foreign bodies” can be passively detected. Data and measurements gathered could be combined with data from other detection devices in Kalman filtering or data fusion algorithms to enhance detection and even identification probabilities.

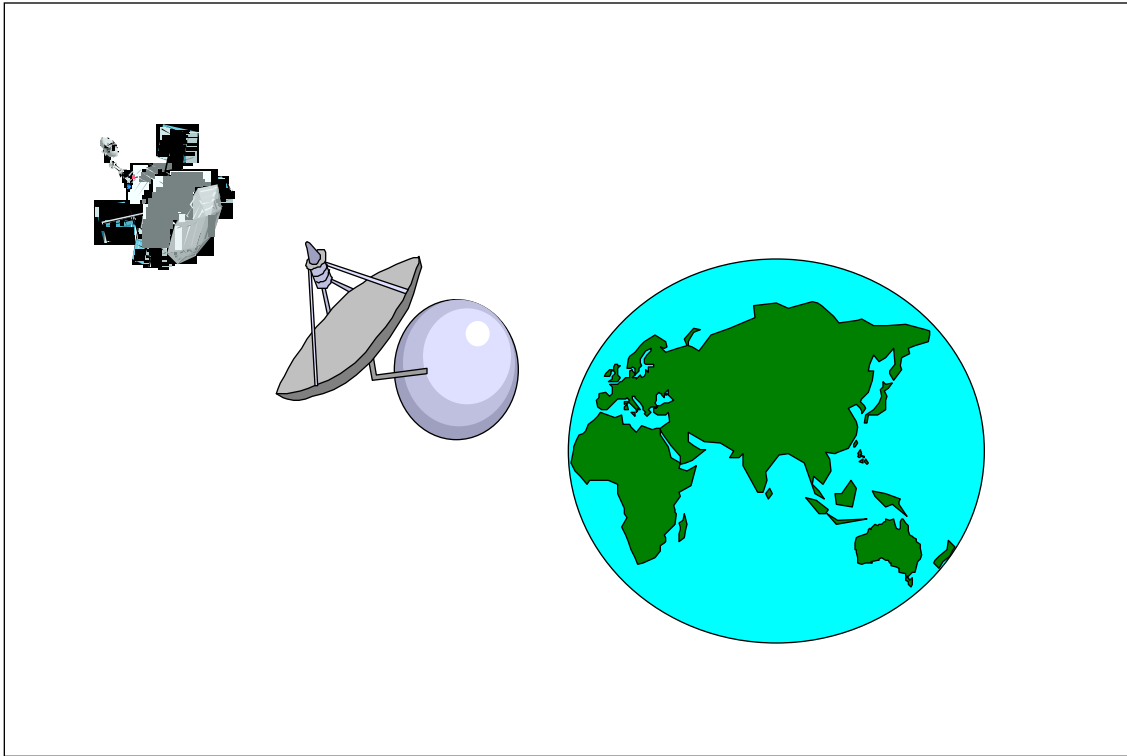

Figure 3-1. Gravity Gradiometer

Gravity gradiometers embedded in multipurpose satellites or spacecraft will detect approaching bodies. Multiple gradiometer systems can accurately pinpoint foreign body locations for follow-on defensive reactions.

Four critical subtechnologies are identified for feasibility investigations with gravity gradiometers. These are (1) gravity gradiometer technology itself; (2) advanced filtering algorithms to combine data from other sensors to enhance detection, location, and identification of approaching bodies; (3) modeling capabilities to appropriately model gravity gradiometer errors and signals; and (4) simulation capabilities to determine the gravity gradiometer accuracy required as a function of the size and mass distribution of the

body under scrutiny, as well as its proximity and maneuver pattern. In order to be able to use the gravity gradiometer in a space detection mode, technology advances must yield a system, which can be deployed in space, capable of detecting an object on the order of 100 kilograms at a range of 100 nautical miles. Reaching this sensitivity by 2025 is an extreme challenge and may be a limiting factor in fielding this technology.

Countermeasures. Synthetic gravity fields may provide effective countermeasures to gravity gradiometer systems. However, the technological leap to “produce” gravity is formidable and not likely by the year 2025. Nonetheless, combining data from other sensors (space based or ground based) to validate organic gravity gradiometer inputs would counter synthetic gravity deceptive attempts.

Anti-ASAT System

System Description. The Anti-ASAT system incorporates a host of sensors embedded on orbiting satellites or spacecraft combined with an artificial intelligence program to detect approaching bodies.² Sensors will detect all forms of radiated wave energy (IR, RF, electromagnetic, etc.). Additionally, the concept design includes ablative and reflective coatings on the host satellite for defense against directed energy attack.

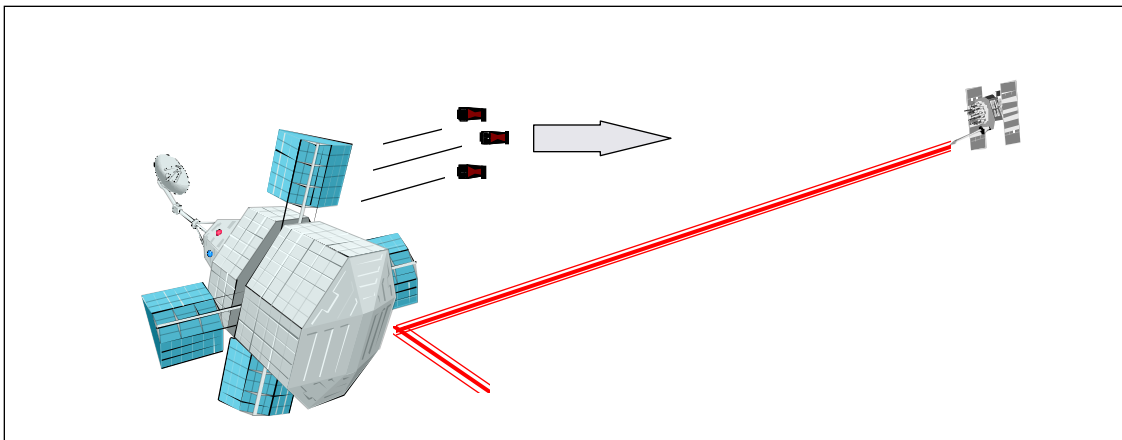

Figure 3-2. Anti-ASAT System

Concept of Operations. This is a satellite self-protection system. If the satellite or spacecraft is approached or attacked by external threats, onboard protective systems eject matchbox-sized "defenders" to home on the intruder, attach to it, and disable it with shaped charges or degrade it by leaching power or disrupting uplink/downlink commands. Hypothetical design should provide a probability of survival (P_s) of .7 against co-orbital threats, .4 against impact or ASATs, and .25 against energy beams. When placed on stealthy satellites, a measure of stealthiness is lost although P_s increases to .9 against co-orbital ASATs and .6 for impact or ASATs and energy beams.³

Countermeasures. An overwhelming attack could defeat the system's self-protection capabilities and destroy or degrade the satellite.

Space Interdiction Net

System Description. Key to any counterspace operation in the future will be total battlespace awareness. The purpose of the space interdiction net is to detect satellite transmissions, identify the source of those transmissions, and find the end user of the information.⁴ This capability is required in order to selectively deny information to an adversary from his own military satellite system or a commercial system. In addition, a space interdiction net will be used to determine whether damage to US or friendly satellites is a result of malicious action or natural causes, such as solar flare or asteroid collision. Consisting of an orbiting grid of satellites capable of continuous coverage of the earth, the space interdiction net will use a web of interlinked microsat systems to radiate a very low power force field over the globe. The field generated by the constellation will act as a blanket around the earth and will be able to detect any energy penetrating the blanket, seek out the desired signal, and jam or degrade that portion of the signal which is important. This force field will be capable of picking up transmissions in a wide range of frequencies and will use triangulation from three or more satellites to pinpoint the source. A capability to detect 70 percent of the transmissions will probably be attainable in 2025. All data deemed not critical to enemy hostile action is left alone to be received as originated. This selectivity enables US commanders to take positive military action to deny an enemy critical information without disrupting nonmilitary information traffic.

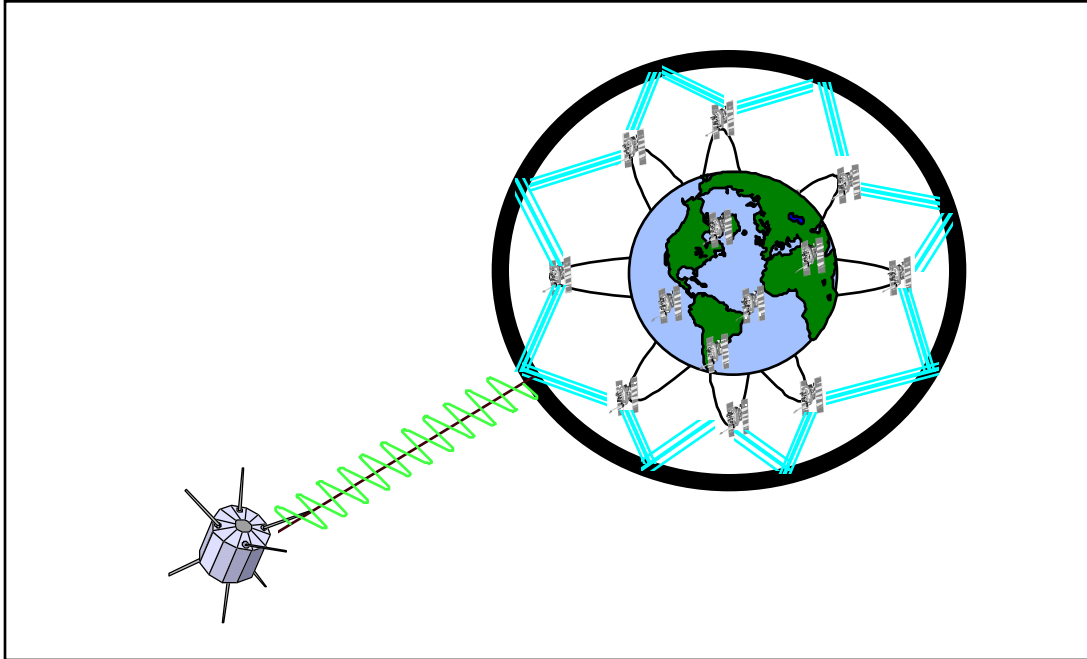

Figure 3-3. Space Interdiction Net.

In 2025, the number of satellites orbiting the earth will rise dramatically (increasing by 25 percent between 1999 and 2005)⁵ and commercial systems will form the backbone of the space information network. The key to performing counterspace operations in this environment will be the ability to identify the critical information being transmitted to an enemy. Upon detection of hostile satellite signals, the interdiction grid will be able to deploy a number of countermeasures ranging from jamming and electronic warfare to destruction via kinetic or directed energy weapons. These actions ultimately keep the end user from capitalizing on critical information from his spaceborne assets.

From a technology standpoint, the power source for this system of integrated sensor network is the most daunting challenge. Battery technology may not advance enough by 2025 to provide continuous power to the system. Solar power can be used a majority of the time, but battery technology is still required for times when sensors are out of view of the sun. A possibility is to use a thin film reflector on orbit to light solar cells on the sensor satellites as they orbit in the shadow of the earth (see the solar optical weapon concept presented later in this paper).

As shown by a variety of concepts presented in this paper, there are a wide variety of ways to disrupt, deny, degrade, or destroy satellite transmissions at the source. However, these methods are not selective in

that they deny information to all users. The detection and interdiction system will be capable of specifically identifying only that information which is being used against the US or its allies. This information can then be used by field commanders and the national command authorities (NCA) to determine whether or not to take action against the satellite itself or its owners. In many cases, the “owners” will be known, as in the case of multinational corporations who operate satellites as part of their business infrastructure. Again, the spectrum of options ranges from soft kill to hard kill.

Another particularly interesting possibility is the modification of the ionosphere to disrupt communications. A number of methods, such as chemical vapor injection and heating or charging via electromagnetic radiation or particle beams, have been proposed to modify the ionosphere.⁶ Because ionospheric properties directly affect high-frequency communications, an artificially created ionization region could conceivably disrupt an enemy’s electromagnetic transmissions. Offensive interference of this kind would likely be indistinguishable from naturally occurring space weather. The capability to create ionization regions could also be used to detect and precisely locate the source of transmissions.

In order to interdict specific signals, the space interdiction net will be capable of projecting a force field between the target and the receiver. This force field will be in the form of a magnetic field or charged particle cloud. Another possible means of surgically removing specific transmissions is a precision molecular particle which, using a nanotech computer brain, follows the data stream to the source. Once at the origination point, the smart particle destroys the frequency bandwidth on which the critical data is being transmitted. We recognize that technology to dissect transmissions at the molecular particle level may not be achieved by 2025 but once achieved will add dramatic leap in counterspace capabilities.

This concept relies on a tightly integrated net of satellites operating in low earth orbit (LEO). The system must be placed in a roughly 250–300 nautical mile orbit in order to be able to detect transmissions from major orbital regions from low earth to geosynchronous. In order to provide continuous coverage to all points on earth, the system will consist of three interlinked constellations of 66 satellites for a total of 198 satellites. All satellites will be interlinked with each individual satellite capable of assuming control of a “hot” sector, one in which hostile transmissions are detected. Satellites will consist of a power system and phased array antenna to project the low energy detection field. In addition, a very high-speed computer will integrate the incoming detection data and correlate the data to a source through triangulation. Finally, a

directional antenna, on order from the command and control subsystem, will project a controlled cloud of charged particles to a point in the sky. The end result is a large charged particle cloud or ionization region placed precisely between the sender and receiver. A further leap would use molecular sensors and computers to lead individual molecules in the charged particle cloud to seek out and destroy specific bits of information from the data stream. The idea of surgical strike has now been taken to the molecular level.

The limiting factor in making the space interdiction net a reality will be the ability to project low power fields over large areas in space. A number of evolutionary advances in space weather forecasting and observation are required to make ionospheric exploitation a reality. The high-speed computer technology necessary to control the smart particles should be available in 2025. In addition, nanotechnology computers may make possible the development of smart charged particles which will be capable of finding and destroying signals. The combination of very low orbits (prone to orbital decay) and the high number of satellites required to form the system will drive the need for a very high resupply rate. This in turn points to the need for a very robust launch capability.

Concept of Operations. The space interdiction net will be in constant orbit around the earth. The system will monitor space transmissions continually while especially looking for strategic indicators which may be warning of impending escalation. With the capability to perform selective offensive counterspace, the activation of the system itself can act as a deterrent to further aggression. Intelligence inputs will give the system an initial estimate of enemy space capabilities which will enable the detection and interdiction system to focus on certain satellite constellations.

The grid will be capable of interrupting key information from all types of satellites including communication satellites, imagery satellites, and weather satellites. It will be closely integrated with the C⁴I system to allow commanders at all levels near instant data on which enemy capabilities have been negated. In addition, the grid will be linked to the other assets which makeup the counterspace system. If precision signal blocking is not necessary, alternate counterspace systems such as directed energy or parasite microsatellites (described later as robo-bugs) can be employed to disrupt or destroy the enemy's space capability. In order to ensure the grid is constantly maintained, a number of on-orbit spares will be placed in parking orbits to be used as needed. A quick-turn launch capability is required to keep the system operationally ready due to expected orbital decay of the LEO satellites which makeup the system. The

interdiction net must be capable of integrating with the command and control system as well as the intelligence system.

Countermeasures. An important countermeasure to this type of system lies in the ability to disrupt or create holes in the detection field. Encryption methods may be capable of making signals hard to attack with smart molecular munitions. If the sender can disguise transmissions or make them capable of changing while en route to the receiver, it will be difficult to identify and attack the right data. Maybe the simplest way to defeat this type of system would be through redundancy via the proliferation of small satellites capable of performing specific missions. Thus, if one system is detected and jammed by the interdiction net, the mission can be accomplished by any number of other satellites capable of transmitting the critical information. This method also complicates the ability to target systems by increasing the cost associated with disrupting or negating a large number of miniature systems operating over a vast battlespace. Should ionospheric disruption become a reality, it could be turned against the space interdiction net to disrupt the low power field or interrupt essential command and control functions.

Miniaturization

General Discussion. Miniaturization is about the age old quest to do more with less, in military parlance, to package more capability in a smaller package. In space, the main reason for miniaturization is weight savings—the ability to maximize precious spacelift resources. This in turn reduces the cost of space systems. Another reason for miniaturization in space is redundancy. A constellation of small satellites performing parcels of the mission is not so vulnerable as a mega-satellite tasked with doing it all. Finally, miniaturization in space opens up new avenues to exploit enemy space systems. It is in this realm that miniaturization can make a true contribution to the counterspace mission. Of note is the urgent desire for commercial industry to exploit miniaturization. Dr Tom Velez, in the keynote address at the eighth annual American Institute of Aeronautics and Astronautics (AIAA) conference on small satellites noted that the small satellite or “smallsat” industry is growing “for reasons that are not political, not military, not scientific, but commercial . . . they’re cheaper and more capable of providing user services.”⁷ This commercial interest should aid immeasurably in the development of technologies and systems that will enable a robust counterspace capability in 2025.

The electronics industry has shown the ability to double the number of transistors on a microchip every 18 months. This trend has driven a dramatic revolution in electronics. Researchers note that the ability to “manufacture millions of microscopic elements in an area no larger than a postage stamp” has inspired further miniaturization technology.⁸

Two emerging technologies show particular promise in making spacecraft smaller and more capable. The first, microtechnology, is the combination of miniaturized mechanical and electric components in microelectromechanical systems (MEMS). The Scientific Advisory Board’s *New World Vistas Space Technology Volume*, report labels MEMS as the next step in the microelectronics revolution in which multiple functions are integrated on a microchip.⁹ An example of a future MEMS system is on-chip optics which will be used to provide agile target recognition and tracking.

The second technology, nanotechnology, is not nearly as developed. Its chief proponent, Eric Drexler, describes it as “taking what we’re very familiar with on a macroscopic level and doing that on a vastly smaller scale using the basic building blocks of matter.”¹⁰ Drexler notes that instead of taking something large, like a silicon wafer, and making it small, nanotechnology starts with molecules and atoms and builds up in tinkertoy fashion. The results will go far beyond simply making atom-scale computers. The *New World Vistas Materials Volume* report notes nanobased processing could provide advanced electro-optical materials, molecular scale sensors, and dynamic stealth materials.¹¹

Nanotechnology offers the capability to build molecule-size factories capable of churning out thousands of specialized nanomachines. Researchers estimate that it will take 20 to 30 years to achieve practical nanotechnology results. The following section describes the link between advances in miniaturization and proposed systems to perform the counterspace mission. Two counterspace concepts with miniaturization as the key enabling technology are promising. Satellite bodyguards—fleets of small satellite sentries—will protect high value space assets. Robo-bugs—parasite microsattellites capable of operating on or near enemy satellites—will use jamming and electronic warfare methods to disrupt and degrade information transmitted from enemy space systems. A description of these potential systems along with a proposed concept of operations follows.

Satellite Bodyguards

System Description.¹² In the years 2000–2005, we can expect a rapid growth in the average number of payloads being launched annually.¹³ The decades following that will probably see launch rates grow at a much steeper rate. In order to protect the vast number of high–value space assets orbiting in 2025, active defensive systems must be able to respond to a wide range of threats. One way to meet this challenge is to place a large fleet of satellite bodyguards in orbits containing critical US and allied satellites. The large number of satellites requiring protection will drive an equally large constellation of bodyguards capable of performing a wide variety of functions. The most efficient means of achieving such a goal is to pursue advances in miniaturization such as microtechnology and nanotechnology.

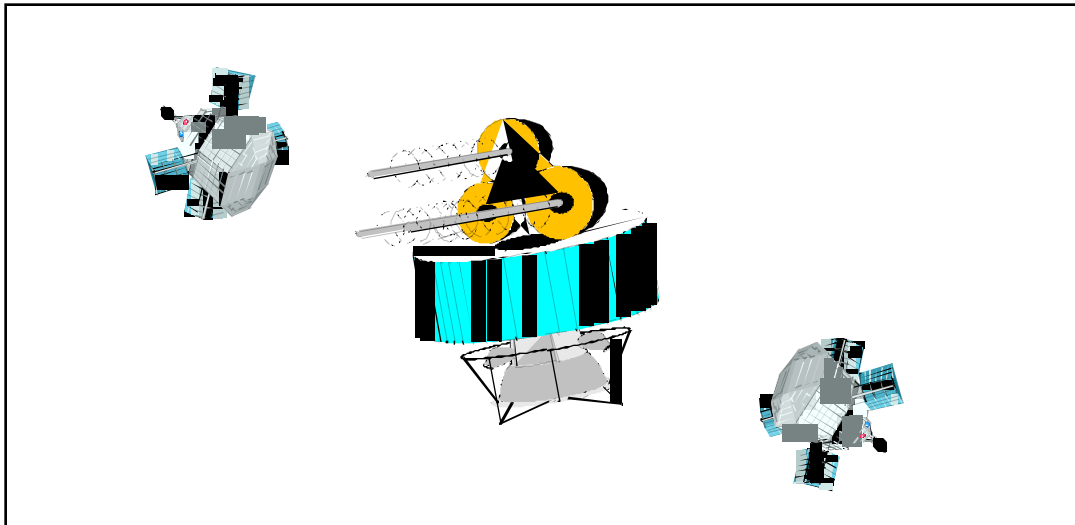

Figure 3-4. Satellite Bodyguards Protecting a High–Value Space Asset.

A space–based satellite bodyguard system might consist of an integrated network of orbiting microsattellites each performing specific subsets of the space protection mission. Similar to P-51 fighter aircrafts flying escort for B-17 bombers in World War II, this system of satellites will be required to detect enemy presence, determine the threat, and act to defeat the threat. However, the bodyguard system of 2025 must take this idea one step further and capitalize on miniaturization to make bodyguards weight and cost effective. The best way to accomplish this is through what Col Richard Szafranski and Dr Martin Libicki, air and space visionaries, call a meta-system.¹⁴ A meta-system is composed of individual systems working

together to perform such tasks as information collection, battlespace awareness, and interfacing with other components of the cooperative distributed network.

Key components of any such meta-system will be miniature sensors coupled with high-speed computers to integrate inputs from multiple bodyguards. The sensor array (an integrated net of sensors on a number of distributed bodyguards) must be capable of detecting inbound threats operating in any spectrum including radar, infrared, acoustic, and visual. Current advances in smart materials and nanotechnology, as well as the miniaturization of high-speed computer technology, will make such a system feasible in the 2025 time frame. This is supported by the trends in computer chips which have gone from circuits three microns wide 10 years ago to current machines which are fabricated at the .35 micron level. Ralph Merckle of Xerox predicts the mainframe of the first or second decade of the twenty-first century “will be the size of a sugarcube and will execute more instructions per second than today’s Cray supercomputers.”¹⁵

While miniature high-speed computers and intelligent materials will increase the capabilities and staying power of the satellite bodyguard, advances must also be made in power and propulsion. Possible solutions to the power problem are nuclear batteries, advanced solar batteries, or fusion technologies, each resulting in a virtually inexhaustible fuel supply. Advances in nonchemical high specific impulse propulsion techniques may provide the revolutionary leap in propulsion needed to make a bodyguard capable of high-speed maneuvering (satellite jinking).¹⁶

A large fleet of bodyguards will be required to form a meta-system capable of protecting the growing number of high-value space assets, both military and commercial. This system, coupled with the need to launch large numbers of dispersed bodyguards in order to reduce the system’s vulnerabilities, will make miniaturization a crucial technology in 2025. A robust space launch infrastructure as well as rapid resupply capability is necessary to keep a satellite bodyguard system operational in a high-tempo environment.

Concept of Operations. In applying the meta-system concept to a satellite bodyguard system, individual bodyguards the size of a laptop computer will perform unique subsets of the overall mission. Based on the same basic design, some bodyguards will be tasked as sensors with the mission to identify and track possible threats. Other bodyguards will be assigned a defensive role where their main function is to seek out threats and negate them. Taking this one step further, defensive bodyguards may be active or passive. Active defenders will use high-specific impulse propulsion techniques (such as electrostatic,

electrothermal, or electromagnetic systems which use electric power to accelerate propellant gasses to high exit velocities) to seek and destroy a space-based threat.¹⁷ Passive defenders will use smart materials (capable of adapting to deflect or absorb inbound energy) to minimize electromagnetic or directed energy damage to a high-value asset. In a worst-case scenario, the bodyguard will sacrifice itself to protect the high-value asset it is guarding. Other bodyguards will be outfitted to perform critical computing and fire control functions.

For incoming ASAT missiles, the system may relay position, velocity, and acceleration data to an orbiting directed energy system which will make the kill. Another option is to equip bodyguards with satellite protective armor which would respond to a KEW attack much as today's reactive tank armor responds to antitank fire.¹⁸ An alternate mission for a satellite bodyguard employs electronic warfare to confuse the enemy. Equipping bodyguards with electronic signals duplication capability will enable a bodyguard to replicate the electronic signature of a high-value asset.¹⁹ By saturating the battlespace with large numbers of small and cheap bodyguards (which to enemy sensors appear to be high-value satellites), the problem of finding and destroying the truly critical satellite becomes much more difficult for an enemy.

Due to the high-risk mission they perform, satellite bodyguards will likely require steady replenishment through the logistics system. Self-replicating nanotech systems may aid in the rapid replacement of damaged bodyguards. A command and control link is assumed to be in place and is critical to the satellite bodyguard concept.

Countermeasures. One way to counter a satellite bodyguard system is to saturate the battlespace around the high-value system with threats to overwhelm the bodyguard meta-system. However, proliferation of inexpensive bodyguards performing subsets of the overall mission may make shooting them too expensive for a future adversary. The command and control function may represent the center of gravity of an integrated meta-system. Destroying the command and control link will effectively disable the bodyguard system by negating the critical integration of information between bodyguards. A hardened burst transmission send and receive capability will decrease the vulnerability of the communications link. Finally, the idea that visibility (to enemy sensors) may equate to death in 2025 makes emission control of vital importance to satellite bodyguards. Stealth as well as minimum communication requirements will help to make bodyguards more survivable in the battlespace of the future.

Robo-Bug

System Description.²⁰ In his 2,500-year-old classic *The Art of War*, Sun Tzu states that “all warfare is based on deception.”²¹ Those words continue to ring true today in the realm of space warfare. The idea of a robo-bug is to use small satellites, equipped with stealth or cloaking capability, to get close to a target enemy satellite. The robo-bug will then take on characteristics of the target. A plausible scenario has an undetected robo-bug satellite affixing itself to a navigation satellite similar to the Global positioning satellite (GPS). The robo-bug will have the capability to detect when a satellite is providing information to an adversary. At the right time, the robo-bug is activated and begins to disrupt the signal through jamming or other electronic warfare methods.

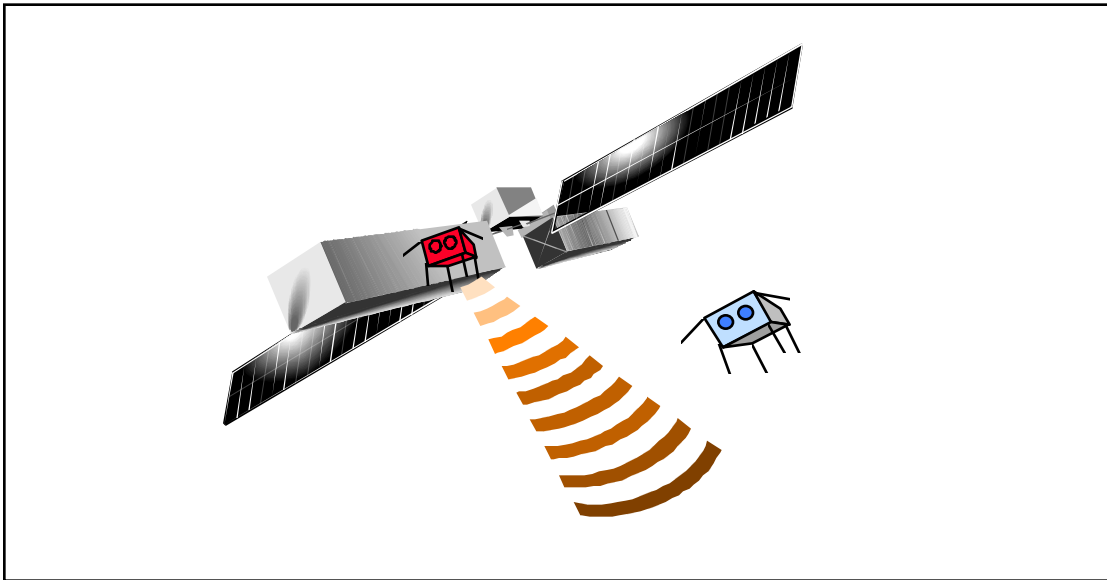

Figure 3-5. Robo-bug Microsats in Action.

Another option is to attack the link system, described as the electromagnetic energy used for space system uplink, downlink, or crosslink. Given a link segment made up of electromagnetic energy, the primary technology used to attack the link is electronic warfare in the way of jamming or spoofing. Jamming is transmitting a high-power electronic signal that causes the bit error in a satellite’s uplink or downlink signals to increase, resulting in the satellite or ground station losing lock.²² Spoofing involves taking over a space system by appearing as an authorized user. An example is establishing a command link with an enemy

satellite and sending anomalous commands to degrade its performance. Spoofing is one of the most discrete and deniable nonlethal methods available for offensive counterspace operations.²³

In his work on counterspace options, Maj James Lee presents a number of options which can be used in an offensive counterspace mission against a peer competitor. These options target the entire system (ground, link, and orbital segments) and range from nonlethal disruption to hard kill as listed in table 2.²⁴ A robo-bug system will be capable of performing the entire spectrum of offensive counterspace options.

Table 2

Offensive Counterspace Options.

GROUND SEGMENT			- NONLETHAL WARFARE - STRATEGIC ATTACK -SPECIAL OPS
LINK SEGMENT	- LOCAL JAMMING UPLINK DOWNLINK	- LOCAL JAMMING UPLINK DOWNLINK - SPOOFING	- JAMMING UPLINK/DOWNLINK - SPOOFING
ORBITAL SEGMENT	- NONLETHAL DISRUPTION	- NONLETHAL DISRUPTION - MISSION KILL	- NONLETHAL DISRUPTION - HARD KILL/MISSION KILL

PEACE

CRISIS

WAR

Source: Maj James G. Lee, *Counterspace Operations for Information Dominance* (Maxwell Air Force Base, Ala.: Air University Press, 1995),34.

The robo-bug is capable of destroying the enemy satellite with a shaped charge explosive or high energy event such as high-power electromagnetic pulse (EMP) or high-power microwave burst. An alternative, the ability to accomplish the counterspace mission with what General Horner, in a speech to the Senate Armed Services Committee on 22 April 1993 described as a “soft kill” (including jamming or intruding the satellite signal and communication links) enables US forces to deny an enemy use of space information without destroying satellites. In a future which sees a blurring of space missions between military, multinational corporations, and numerous governmental organizations, this capability will offer the commander a desirable option to be used in meeting a politically sensitive military objective—space superiority.

A robo-bug system will be comprised of a main module which will take care of basic needs such as power, navigation, and station keeping. The satellite itself will be built using stealth cloaking techniques (described later in this paper). The command and control system will be used to receive direction via

ground or space link and act upon that information to direct the robo-bug to its assigned target. The heart of the system will be the payload which will have a specific mission. Missions are discussed in the concept of operations. The emerging technologies which might make a robo-bug system feasible are MEMS technology, nanotechnology, and small high-speed computing. As previously discussed, each of these technologies show signs of being near maturity in the 2025 time frame.

Concept of Operations. The idea of a robo-bug is not to act as an antisatellite weapon. Instead, the robo-bug uses electronic warfare methods to negate a satellite's capabilities without permanent damage. Robo-bugs will be pressed into operation early in a potential conflict to degrade or eliminate the detection, imagery, and communications capabilities of an adversary.

Robo-bugs must operate in such a manner as to make any loss in enemy satellite fidelity very subtle so the likelihood of discovery by the operator is as small as possible. This can be done in a variety of ways. In addition to the spoofing mission as described in the navigation satellite example, another possible mission (forwarded by Gen Charles A. Horner) is jamming or intruding the satellite signal or targeting the satellite communication links. This negates the enemy's ability to maneuver the satellite or to deploy onboard systems such as sensors and antennas. Yet another possible mission is to simply act as a power drain, sapping the power from the enemy satellite much like a tick on a dog.

Countermeasures. In their paper "Tactical Deception in Air-Land Warfare," Charles Fowler and Robert Nesbit make a fundamental observation that "the military group that is not devoting appropriate efforts to include tactics, R&D, and plotting and scheming in general for deception is almost certain to be vulnerable to being deceived itself."²⁵ Any future US space system must be capable of defeating an enemy parasite system. Specific countermeasures to a robo-bug system are based on the ability to detect disruption efforts and take action. Assuming they can find a robo-bug, an enemy might do periodic maneuvers to avoid it or take offensive action to destroy it. Deception may also be an effective method of countering a robo-bug system. If a satellite is able to radiate emissions which make it appear to be nonthreatening (or even appear to be a friendly satellite), it may be able to fool a robo-bug.

Another very effective method in countering a parasite system is dispersion—using large numbers of small satellites to overwhelm detection and targeting systems. This method causes the enemy to expend numerous resources in an attempt to protect his valuable space systems. Once an enemy suspects a satellite is

being influenced by an unfriendly parasite, confirmation can be made by comparing data to known values. However, without a way to rid itself of the robo-bug, the satellite may very well be rendered useless. Once again, the command and control link between the commander and the robo-bug presents a vulnerability. The ability to operate in a secure command and control environment continues to be an essential part of any counterspace concept.

Space Stealth

General Discussion. Stealth conjures up images of a strike package of aircraft operating deep in enemy territory while the adversary waits, watches, and listens, all to no avail. Author J. Jones describes stealth as the act of proceeding furtively, secretly, or imperceptibly.²⁶ Fast forward the year to 2025 and imagine an enemy hunter-killer satellite team cruising right past a US command and control platform without the faintest hint of detection. Stealth, defined in terms of revolutionary molecular technologies, can be a key component in the protection of friendly space capabilities against enemy attack—classical defensive counterspace.

To date, numerous passive measures such as hardening, redundancy, and cross linking have served to protect US satellites from threats in space. Our status as the lone superpower and leader in space has meant these threats have so far been very benign. On the other hand, the future will likely hold greater threats both in number and sophistication. By taking a significant technology leap, we can defeat these future threats. This leap is broadly categorized as space stealth or cloaking. In essence, we are talking about making satellites invisible.

Most people are familiar with the stealth concepts employed on modern day aircraft such as the F-117 and the B-2. Current stealth technologies seek to blend signature reduction techniques in the radar, infrared, visual, and acoustic domains.²⁷ The classical design problem has been balancing aircraft designs to minimize the signature in each domain. Unfortunately, this does not lead to an optimal solution. For example, highly reflective materials are ineffective in a visual or radar environment but are very desirable in an infrared environment. In 2025, standard detection methods as well as a number of new and unique methods will have to be countered in order to achieve true stealth. The technological leap that may enable us to do this is satellite cloaking.

Satellite Cloaking

System Description. The concept of satellite cloaking takes stealth to a new level. To date, stealth has been a passive activity aimed at trying to minimize reflection and maximize absorption of energy with the goal of reducing the amount of energy reflected back to the sender. In contrast, cloaking will use active means to enable a satellite, as seen by enemy sensors, to blend into any environment.²⁸ Reliant on emerging material science advances as well as miniaturization and high-speed computing, a cloaked satellite will use nanotechnology robot films which will render it invisible in a space environment.

These nanotech materials, comprised of systems on the scale of individual molecules, must have two critical capabilities. First, the system must be capable of detecting any energy being aimed at the satellite. Is this possible? AT&T Bell Labs physicist Bernard Yurke sees nanotechnology systems with the sensitivity to “allow the first detection of individual photons.”²⁹ After detection of incoming energy, the system must be capable of altering its construction to reflect or absorb that energy. With materials that have molecular motors and controllers, whole chunks of satellite skin can be made flexible and controllable. To simplify this idea of molecular manipulation, scientists describe nanotechnology through a vivid analogy. Picture an automated factory, full of conveyor belts, computers, and moving robot arms. Now imagine something like that factory but a million times smaller and working a million times faster with parts and pieces of molecular size.³⁰ In this concept the smart, adaptive skin of the spacecraft reacts to control inputs from the sensor array to make itself invisible to an enemy. In essence, molecular assembly lines are creating a satellite skin which is best suited to deflect or absorb incoming energy.

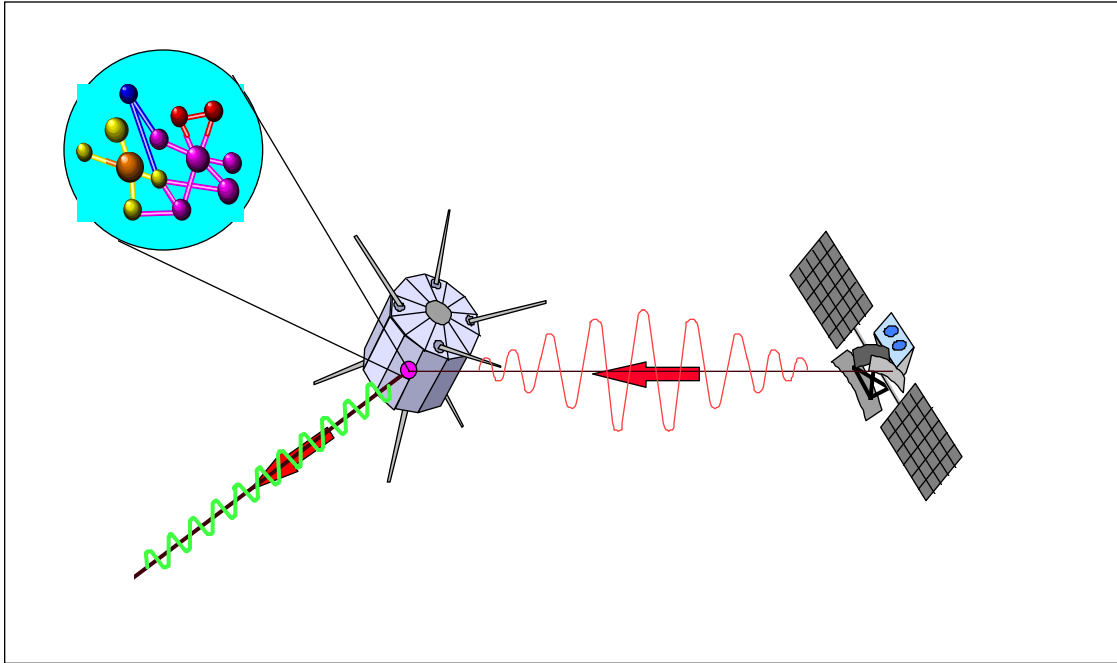

Figure 3-6. Nanotechnology Cloaking System.

Figure 3–6 depicts a friendly satellite being radiated with radar energy from a hostile source. The sensor array on the surface of the friendly spacecraft detects inbound radar energy. The control system then directs the nanotechnology satellite skin to form a radar absorbent material and take an angular shape which will reflect the radar energy away from the source. Molecular sized computers, acting as the brains of this unique defensive shield, will enable the system to react almost instantaneously to inputs from the sensor array. The advent of nanocomputers, says Drexler, will give us practical machines with a trillion times the power of today’s computers, all in a molecular package.³¹

An alternate protective means is a stealthy satellite capable of generating an electrostatic or magnetic repulsion field which will shield the spacecraft from natural threats.³² The repulsion field would be employed against low stress threats such as space debris or possibly to protect against solar flares. An important side benefit of such a repulsion field is the ability to use it as a sensor field to determine whether a satellite has been damaged by natural causes (space debris) or an attack. This capability gives the satellite controllers immediate information as to the probable cause should a satellite mysteriously drop off the screen.

Intelligent materials are another emerging technology with great possibilities in this arena. Researchers are creating materials which, inspired by nature, can anticipate failure, repair themselves, and adapt to the environment. Smart materials employ tiny actuators and motors as muscles, sensors as nerves and memory, and computational networks that represent the brain and spinal column.³³ Molecular computers coupled with molecular sized assembly lines ready to build the right shield at the right moment with materials capable of adapting to the environment may make cloaking a reality in 2025.

As far as feasibility, Stewart Brand, a leading futurist at the Massachusetts Institute of Technology, reflects on nanotechnology, stating “the science is good, the engineering is feasible, the paths of approach are many, the consequences are revolutionary-times-revolutionary, and the schedule is: in our lifetimes.”³⁴ Commercial interest in these technology developments, for uses in adaptive assembly lines and self-repairing machines, will increase the probability they will be available for incorporation in US space systems.

Concept of Operations. The satellite cloaking system will operate on all space assets critical to US operations. This includes both military as well as key civilian spacecraft. The cloaking system will go into action once alerted by its onboard sensor array or warned by its command and control network.

First, the system will classify the incoming detection signal as radar, infrared, or visual (remember, individual photon detection is the norm). Sensor information is passed to the nanocomputer control system which relays commands to the nanobuilding blocks in the satellite skin. The building blocks, acting as their own molecular assembly lines, manufacture a skin which is optimized to reflect or absorb incoming energy. The ability to change at near instantaneous speeds allows the system to overcome the problem of suboptimal design (the trade-off between reflecting and absorbing materials) encountered in today’s stealth aircraft. The nanotech spacecraft skin will be capable of battle damage repair to the spacecraft (a self-healing satellite). The ability to act autonomously to repair itself greatly reduces demand on the logistics system, which in space is a great advantage in both cost and time.

Countermeasures. The most obvious countermeasure to a nanotechnology cloaking system is the ability to disrupt the molecular interactions which enable the system to operate. The possibility also exists for a new detection spectrum, possibly a smart beam, which is capable of changing to counter a response by the cloaking system. Destruction of smart nanotechnology materials should not pose a problem as the system will be capable of rejuvenation. However, this technology can be expected to proliferate through

commercial developers to the community of space faring nations. The ability to perform the offensive counterspace mission against cloaked satellites presents its own unique challenges to US forces.

Kinetic Energy Weapons

General Discussion. Kinetic energy weapons (KEW) destroy things “the old fashioned way,” that is using energy generated by a moving mass impacting a target mass. KEW for space application in the form of antisatellite (ASAT) systems date back to the mid to late 1960s when both the US and Soviet Union were testing ASAT weapons. US commitment to an ASAT changed with administrations until testing was finally terminated in 1985 and the secretary of defense canceled the F-15 ASAT Program in 1988.³⁵

KEW can be employed from the ground, air, or space against targets in any medium. This paper suggests concepts which employ KEW from various platforms against ground and space targets. As noted previously, the space environment of the future will be one of multiple users of military, civil, and commercial satellites. In many cases, political considerations will prevent or severely constrain military options which involve actually destroying satellites. Having a solid KEW capability, however, will serve to deter similar aggression against US satellites and will give the US the option to destroy enemy satellites if necessary. Several concepts are proposed which take advantage of KEW technology. These include the satellite multiple attack and kill system (SMAKS) and alpha strikestar transatmospheric vehicle (TAV).

Satellite Multiple Attack and Kill System

System Description. This system is similar to the Army’s multiple launcher rocket system (MLRS), but instead of ground-to-ground capability the SMAKS employs a ground to space capability.³⁶ The system has three models designed for attacking low, medium, and high earth orbiting satellites. Similar to the Army system it is highly mobile and carries an array of antisatellite rockets. Given the potentially large number of enemy satellites existing in 2025, enough SMAKS vehicles are needed to ensure an effective ground-based ASAT capability over the entire battlespace. The system can also be based on ships and submarines to provide the capability of destroying launch vehicles in the boost phase before they can deploy enemy satellite

systems. SMAKS carries highly sophisticated command and control, targeting, and positioning systems, requires minimum manning, and is readily deployable.

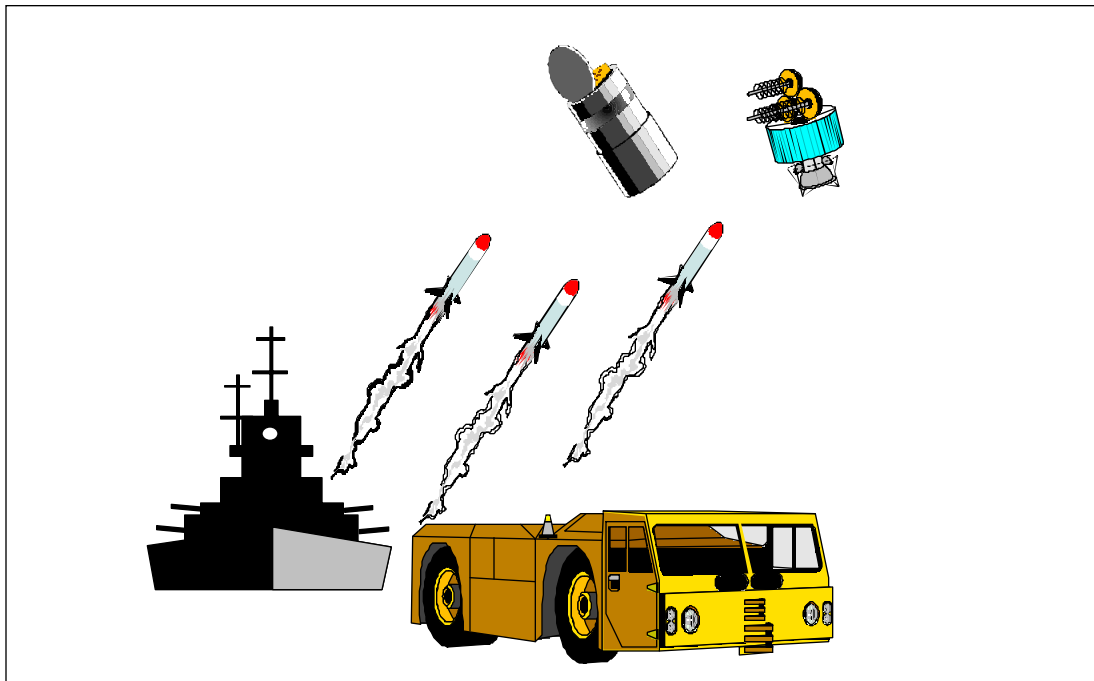

Figure 3-7. Satellite Multiple Attack and Kill System

Concept of Operations. SMAKS is sized to fit easily into the air mobility workhorse of 2025 and must be located at appropriate locations depending on the target set. The system is sea-deployable giving it added flexibility. Using the advanced global positioning system (GPS), SMAKS will take a minimal amount of time to accurately locate itself and prepare itself to conduct antisatellite operations. Upon proper direction, the SMAKS will process appropriate targeting data received from surveillance and reconnaissance assets, upload the targeting data into the appropriate number of missiles, and release the weapons. Surveillance assets will conduct battle damage assessment and feedback to the SMAKS.

Countermeasures. Potential countermeasures to this system would be electronic measures such as jamming and spoofing to confuse the required GPS information or other data links. Also while survivability is enhanced by using a mobile system, it is nevertheless vulnerable to attack from air or space while operating on the surface of the earth. Satellite maneuvering may be an effective countermeasure against a SMAKS type system that is heavily reliant on a target satellite's initial position and velocity for targeting.

Alpha Strikestar Transatmospheric Vehicle

System Description. The Alpha Strikestar is envisioned as a transatmospheric vehicle (TAV) able to take off and land horizontally and enter into low earth orbit.³⁷ It is able to transition between air and space environments repeatedly during the same mission, based on the threat and mission requirements. It carries multiple types of weapons to meet any threat. These include kinetic energy antisatellite missiles designed for total physical destruction and a high-powered laser cannon which is capable of disrupting, denying, degrading, or destroying unfriendly satellites. Another mission is the capture of an enemy satellite for return to earth or transfer to a useless orbit. The Alpha Strikestar is also air/space-to-ground capable using precision guided weapons to take out hard targets anywhere in the world on short notice. The vehicle is equipped with self-protective measures, as well as an imaging capability for battle damage assessment.

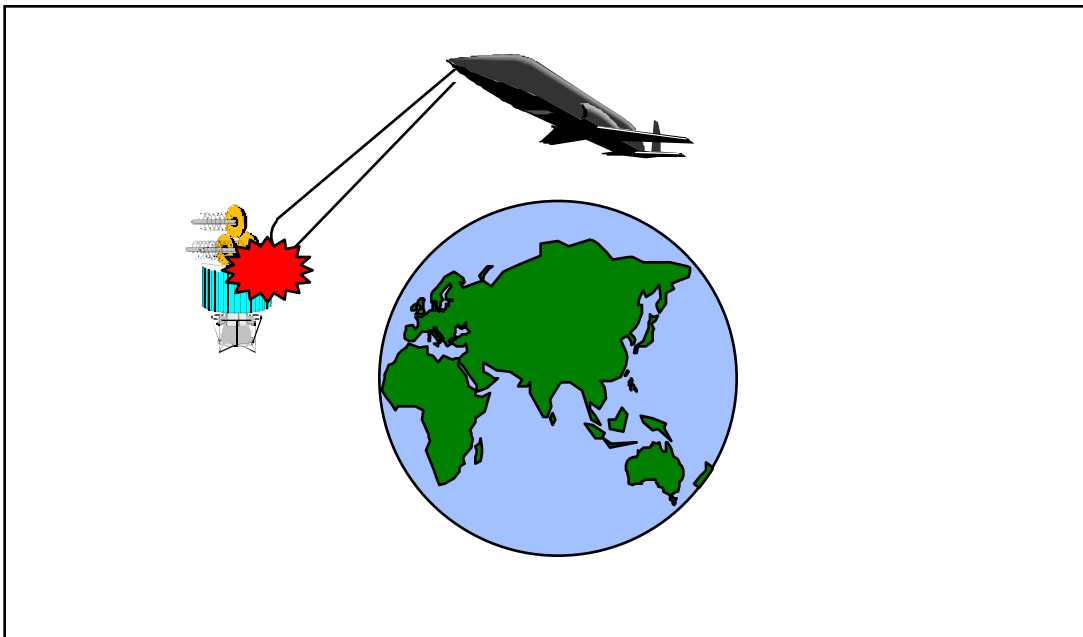

Figure 3-8. Alpha Strikestar TAV.

Concept of Operations. Alpha Strikestar can be scrambled to react to a crisis anywhere in the world on a moment's notice. Orbital insertion planning is preloaded into the weapons system computer to assist the pilot in proper positioning, target acquisition, and target engagement. For ground targets, mission planners will determine best application of weapons load (space or air delivered). The vehicle is flexible enough to enter low earth orbit en route to a ground target, reenter the atmosphere to deliver ordnance, then return to

orbit to overfly the target and conduct battle damage assessment. If necessary the Alpha Strikestar can then reengage to complete the designated mission.

Countermeasures. This system will employ state-of-the art stealth technology, but if detected will be vulnerable to enemy ASAT attack, whether it be kinetic or directed energy. Since a TAV requires ground-based launch and processing facilities as well as runways, these are likely to be targeted as critical nodes by an enemy looking to ground a TAV fleet.

Directed Energy Weapons (DEW)

General Discussion. Counterspace missions in 2025 will require the ability to disrupt, deny, degrade, and destroy enemy space capabilities. The proliferation of space users will reach monumental proportions in 2025, making counterspace attacks on individual users (the ground component) nearly impossible. The critical linkage between the user and the information he or she desires is the space-based asset and the transmitted data. Add to this situation the large future role of the space system entrepreneur and now attacking these systems may not only bring legal action against the US but may degrade our own capability. Directed Energy Weapons (DEW) of 2025 will provide the most promise for disrupting, degrading, denying, and if necessary destroying enemy space capabilities.

A directed energy weapon must be able to generate energy, direct it on the target, propagate it through air or space, to the target, and induce some lethal effect in the target. Charged particle beams are probably the best at generating, directing, and killing but are clearly the worst at propagating. Neutral particle beams can propagate and kill but cannot yet be generated with sufficient intensities. Lasers are very good at directing and propagating, since light reflects from mirrors, can be pointed like a spotlight, and after leaving the weapon propagates in straight lines.³⁸

Historically, the major drawback to DEW has been the necessity to operate in clear weather. If the DEW is placed in space to conduct space-on-space attacks, this deficiency is eliminated. If the DEW is on the ground conducting earth-to-space attacks or in space conducting space-to-earth attacks, 2025 technologies for boring access holes through clouds and other obstructions may eliminate this deficiency. Development of a high-powered microwave weapon which can operate in all weather conditions may eliminate the poor weather deficiency. The current airborne laser (ABL), being developed to counter theater ballistic missiles, will demonstrate the ability of lasers to operate in environmental turbulence of the earth's atmosphere. The

recently completed *New World Vistas Directed Energy Volume* report by the Air Force Scientific Advisory Board indicates, “the ABL will probably be the first practical and effective directed energy weapon to be deployed.”³⁹ This will be the springboard to operating lasers through the medium of air and space. By 2025, DEW systems will likely operate in space and from the ground. This will give us the ability to negate objects in the atmosphere and in space. Five directed energy concepts were explored in this study.

High Energy Laser Attack Station (HELAS)

System Description. Disrupting, denying, degrading, and destroying enemy space capability will be accomplished by a space-based high-powered, short wavelength, solid state laser platform. This constellation of orbiting platforms will provide continuous, 24-hour protection of friendly forces and negation of enemy capabilities.⁴⁰ This constellation of counterspace platforms will be placed in low earth orbit (LEO—150 NM), medium earth orbit (MEO —11,000 NM) and geosynchronous orbit (GEO—22,000 NM). The high energy laser attack station (HELAS) will consist of 16 orbiting platforms at LEO, eight platforms at MEO, and four platforms at GEO. This multilevel constellation will provide a layered interactive defense against all space-borne or space-transiting threats. The multilevel system will protect all US assets in various altitudes and inclinations. A diode pumped solid state laser (DPSSL) will be the heart of the laser weapon subsystem. The DPSSL is more efficient than flashlamp pumping, which is the traditional method of exciting solid state lasers, and it results in much less heating of the laser as well.⁴¹ Current solid state, chemical, and free electron lasers can generate power in the kilowatts range. However, a credible HELAS must employ lasers in the megawatt ranges. There appears to be no major technological limitation for DPSSL to achieve the megawatt range, and continued advancements will reduce the cost to reasonable limits.⁴²

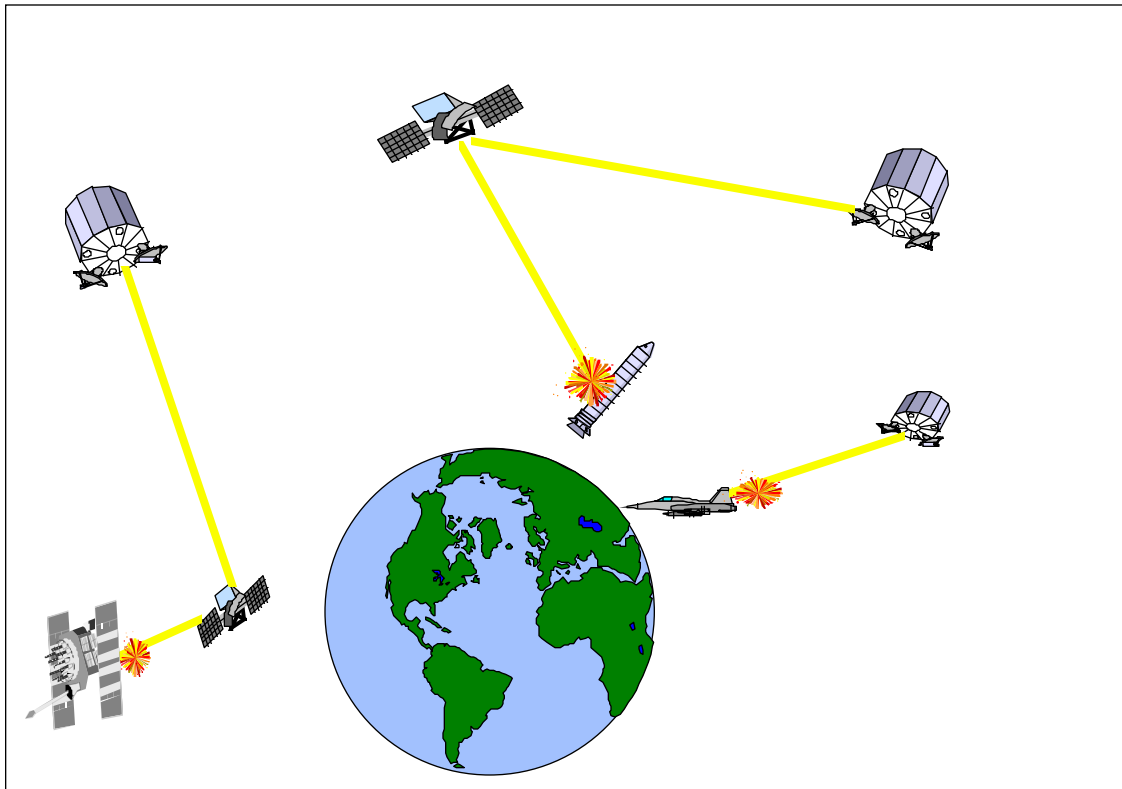

Figure 3-9. HELAS.

Concept of Operations. The HELAS will be the primary space attack/defense network for counterspace operations in 2025. The multilayer, multiinclination constellation will be operated by a single ground crew member (ops chief) with the assistance of artificial intelligence health and maintenance software systems.⁴³ Ground-based telemetry, tracking, and controlling will be conducted via satellite-to-satellite laser crosslinking. Another crew member will serve as the weapons manager who will track, target, and engage hostile targets. These two crew members can sit side by side in any size facility and in any location on the globe as long as they can communicate with at least one satellite. The crosslinking capabilities will provide the global command and control necessary to operate the constellation. Enemy ground launched or co-orbital ASAT can be detected, tracked, and engaged by HELAS. Although primarily a denial/destruction type weapon, the laser can be tuned to damage or degrade satellites by attacking subcomponents (i.e., solar array panels, reaction control thrusters, thermal heating of components to cause system shutdowns, etc.). Counterspace earth targets such as command and control (C²) facilities, earth station antennas, spacelift facilities, and spacelift vehicles can also be effectively engaged by HELAS. The four GEO platforms could

also provide dual-use capabilities for planetary defense by orienting HELAS outward. This could be done in a global emergency noting the degradation of the space defense mission with the GEO platform oriented outward.

Countermeasures Special reflective or absorbent material could make the laser ineffective. Use of low-observable or stealth technology may defeat targeting and identification systems on the HELAS. The HELAS may be vulnerable to anti-satellite weapons or other laser stations. In addition, satellite hardening may be an effective countermeasure against low power laser pulses intended to degrade the target. This may force commanders to opt for the hard kill destruction of hardened satellites. A factor driving this decision will be the potential political impact of a turn in negative international opinion resulting from the total destruction of a satellite.

Solar Energy Optical Weapon (SEOW)

System Description The SEOW will use the evolutionary concept of large orbiting structures to focus solar rays on earth and space targets to disrupt, deny, degrade, and destroy enemy capabilities.⁴⁴ This concept constructs a 10 kilometer magnifying glass or focusing element in space to illuminate targets on the ground or in space. This illumination can turn night to day on the ground, scorch facilities, or overheat satellite components. The solar energy provided to the focusing element on the weapon also provides a perpetual power source for the orbiting platform. Instead of using an orbiting magnifying glass to focus energy, another alternative is to use stored solar energy to power a directed energy weapon. A leap in battery technology leading to the capability to store immense quantities of power can be expected by 2025.

Large lightweight structures (kilometers) are feasible for 2025 and will provide the necessary stable platform to house the focusing or magnifying glass element. Advancements in space membrane structures and adaptive optics may provide the necessary capabilities to produce an energy frugal space-based weapon. Each SEOW will orbit at geosynchronous altitude and consist of an Attitude Control System, Guidance, Navigation, and Control System, Reaction Control System, Targeting and Identification System, and the Laser Communications System.

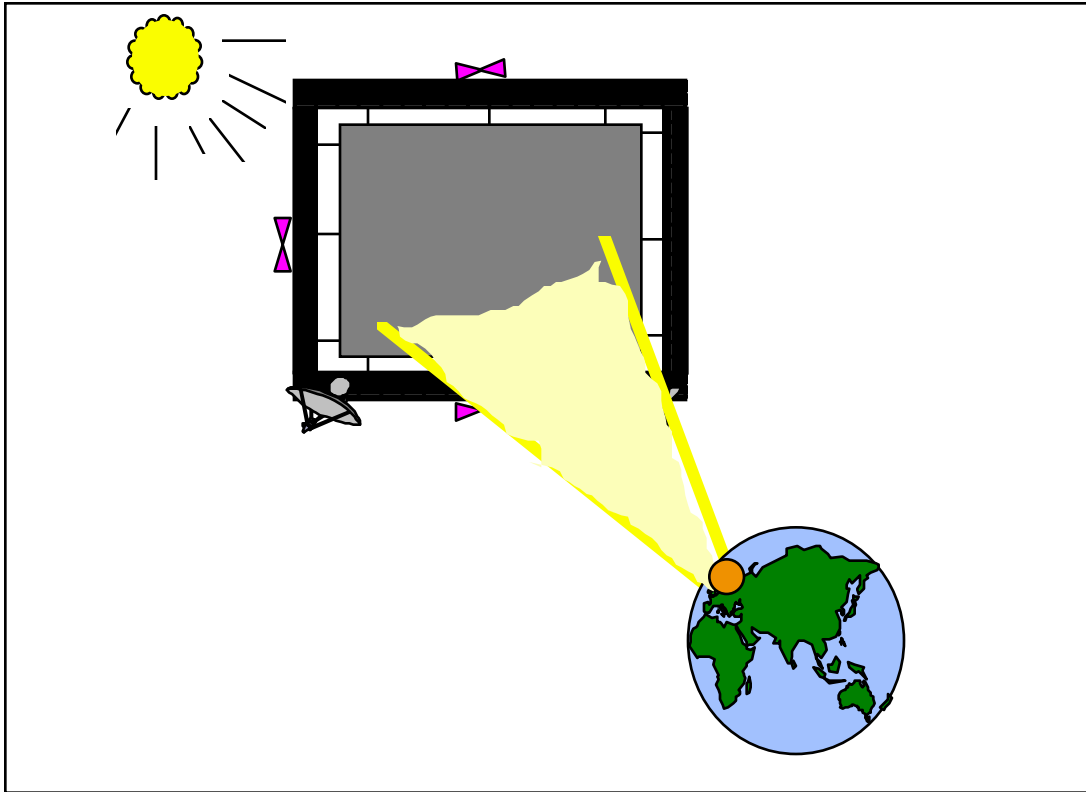

Figure 3-10. Solar Energy Optical Weapon.

Concept of Operations. The orbiting SEOW will be assembled in low earth orbit and boosted into geosynchronous orbit after the completion of the 10-kilometer optical focus assembly. The weapon can be maneuvered over the area of interest to provide space-to-earth capabilities as well. The solar energy can be spotted over a particular area of interest turning night into day. In addition, the beam could be focused on a power generation facility on the ground to provide a continuous high-energy source or the station could focus its beam on a lower orbiting satellite to provide it solar power when it would normally be in the earth's shadow. The beam could also be focused on an enemy orbiting threat to raise the internal temperature beyond functional limits. This may not destroy the satellite but, because of low sensitivity to heat, will force the automated shutdown of the satellite. Enemy controllers will only be able to detect the out-of-limit condition but will be unable to detect the source. For imaging and electronic surveillance satellites which pose a great threat to our forces (i.e., removes element of surprise), the SEOW will illuminate the target prior to its entry into the area of responsibility forcing an automated shutdown of the satellite or blinding of its sensors, thus preventing collection over our assets. Once the target has departed the protected area,

illumination is discontinued until the next threat enters the area. Although this will completely deny use of the imaging/reconnaissance platform to all users for that period of time, US surveillance capabilities will be provided by other US government-controlled assets.

Countermeasures. As a large fragile target, the optic or space membrane could be easily disrupted or destroyed by KEWs or objects. Enemy forces could attempt to ram the weapon with a kamikaze satellite in hopes of rupturing the adaptive optic system. As a result, an active defense system will be needed to counter this potential threat. An alternative is to use a large number of small membranes coupled with adaptive optics to form a synthetic aperture type focusing element. This will make the array less vulnerable by dispersing the elements which make up the optics system.

Electromagnetic Pulse (EMP) and High Power Microwave (HPM) Pills

System Description.⁴⁵ EMP radiation can be viewed as variations or created disturbances in the electromagnetic field which can cause disruption of electronic devices by arcing, overloading, and discharging. These EMP charges can be generated by numerous sources and can cause limited to extensive damage to electronic components. High power microwaves (HPM) can penetrate external protective surfaces and disable or damage critical components of a satellite or other spacecraft. The HPM weapon might be focused on specific circuits and subcomponents within the target in order to disrupt or degrade mission functions.⁴⁶ Focusing and tuning the HPM to a specific wavelength or frequency might allow certain components to be isolated and affected. The EMP or HPM pills will be microsattellites which maneuver within close proximity of an enemy satellite and emit short-range pulses to interfere with the normal operation of the satellite.⁴⁷ These pills are intended for short duration operations in order to minimize the potential for collision with friendly satellites. These microsattellites will be launched into space by aircraft, transatmospheric vehicles (TAVs), small launch vehicles, or small fighter aircraft using high impulse air-to-space missiles. After 30 to 60 days, the pills will be directed to move to a collection orbit to be recaptured by TAV. The EMP/HPM pill will consist of small, lightweight satellites with an EMP gun or HPM generator attached. This compact, short-range weapon will provide an adequate offensive counterspace capability which will be undetected by the enemy. Because of the longer wavelengths and wider beams generated by

EMP type weapons, pointing accuracy will not be as critical as those needed for laser type weapons. Although some EMP/HPM weapons exist today, the challenge for 2025 require miniaturization of the spacecraft and the applicable weapon.

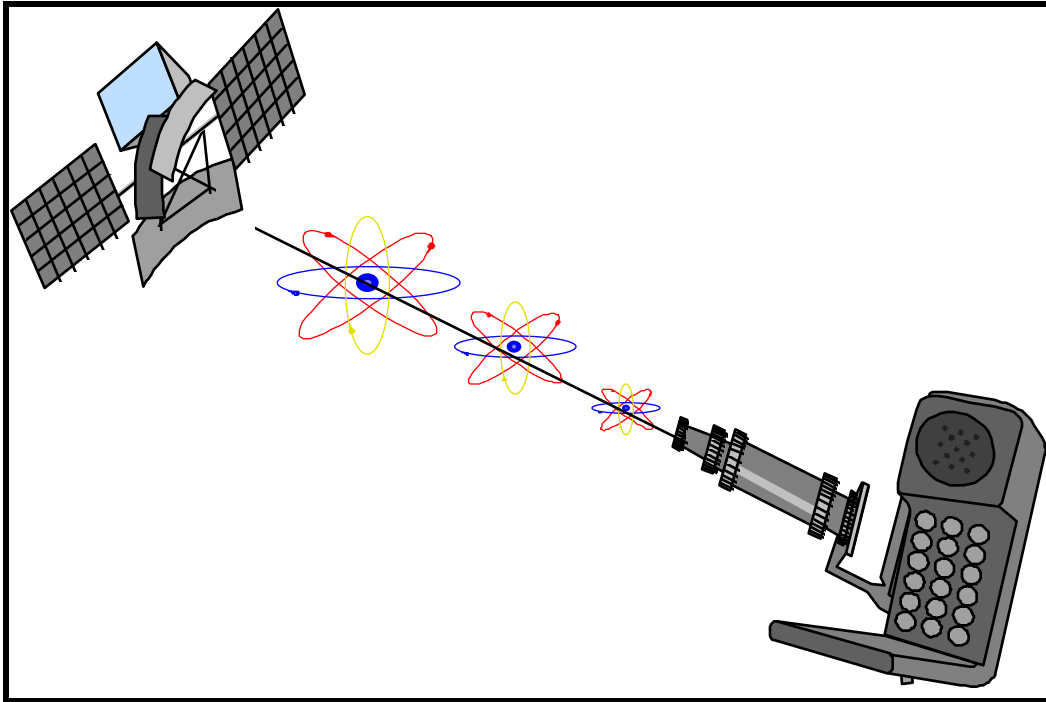

Figure 3-11. EMP/HPM Pill.

Concept of Operations. During prehostilities and during crises/war, EMP/HPM pills will be launched into orbit. These microsattellites will be positioned next to high-value enemy satellite systems and space systems operated by neutral countries or multinational corporations which may supply information to the enemy. The EMP/HPM pills will fly in formation with the enemy satellites until directed to engage. The explosive generator (or applicable weapon) will fire a fine tuned graduated pulse at the target. The goal is to deny the space capability through disruption and not destruction. This is especially true in the case of multinational corporation satellite systems. The pill can fire several rounds over a 60-day period at key times during the enemy satellite's orbit when it is collecting information on US forces or downlinking data to the ground. When the EMP/HPM pill has completed its mission or is no longer necessary, it can be deorbited and allowed to decay in the earth's atmosphere. The EMP/HPM pills can provide local neutralization of enemy satellite systems over the battlefield as well as global with a large number of cheap weapons.

Countermeasures. System shielding and electrical ground may reduce the effectiveness of the EMP/HPM pill. If detected, the enemy could maneuver out of harms way or fire a kinetic or directed energy weapon to degrade or destroy the EMP/HPM pill. Dispersion (spreading the mission over a larger number of smaller satellites) is another countermeasure. The resulting increase in numbers will force a corresponding increase in the number of EMP/HPM pills and will make degradation of the system more difficult. Our forces could counter by making EMP/HPM pills cheaper and easier to operate than the target satellite system.

Ground-Based Laser (GBL)

System Description. The GBL provides the capability to disrupt, deny, degrade, or destroy enemy space capabilities and potentially protect friendly space assets.⁴⁸ Several ground-based laser concepts have been explored over the past 25 years. Ground-based lasers offer unique advantages over space-based laser systems. Supportability and operability are major advantages to the ground-based laser. Deployment and supportability is functionally easier on a ground-based system than on an orbiting space system. There are two major drawbacks to ground-laser systems: line-of-sight limitations and atmospheric perturbation.

This concept will develop the laser station on the earth, fire the laser at relay optics in space, and use those relay mirrors to engage targets either in space or on the earth. This places the most technically challenging component on the ground and deploys a very simple relay network system in orbit. Three to five laser generation sites will be placed in various locations across the continental United States (CONUS). These sites will have access to relay mirrors orbiting above, which can transfer the laser beam to other orbiting relay stations to attack targets on the other side of the globe. Dispersion of the laser stations and relay mirrors will help defeat the poor weather deficiency which has plagued the capability of ground lasers to fire through cloud cover into space. The Laser Guidestar program developed technology for atmospheric compensation which allows a ground telescope site to view a scene or irradiate a target anywhere around the globe while a relay mirror is in position to provide the view.⁴⁹ This technology will greatly contribute to our future ability to bounce lasers off orbiting mirrors to attack targets.

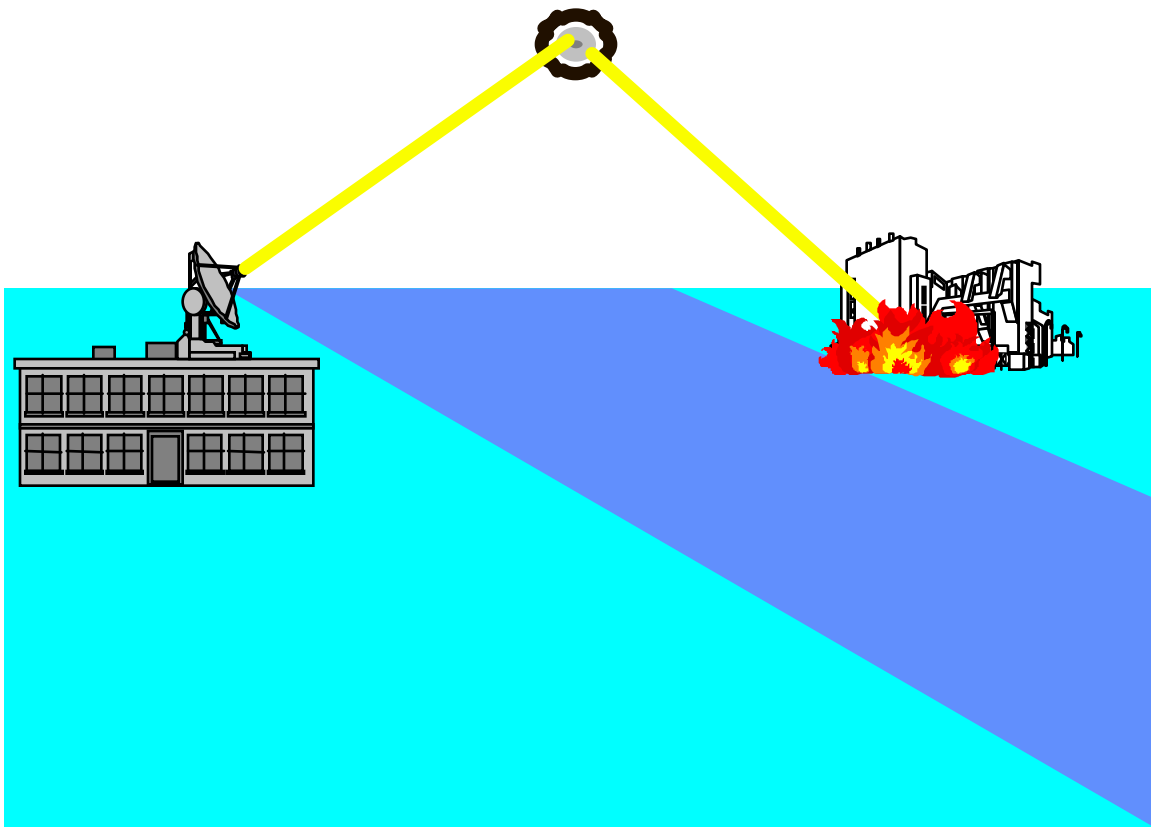

Figure 3-12. Ground-Based Lasers.

Concept of Operations. The five laser generation stations will be placed in those geographical locations best suited for laser operations and favorable weather conditions. Wide dispersion of these sites will increase the probability of having at least one site in clear weather for optimum operation. The laser generation site will be an unattended nuclear-powered facility which will provide the necessary megawattage required for the high-powered solid-state laser. Control of the five stations and the orbiting mirrors will be centralized in a primary facility with a mobile backup facility. Redundant satellite communications between the laser generation sites will increase survivability of the ground-based laser system. The orbiting mirrors will be laser crosslinked to reduce the ground support network for telemetry, tracking, and control (TT&C). The same reflecting mechanism used to attack a target can be used to identify and track the object before engagement. This information will be processed by ground computers at the central control facility and attack commands will be issued to the laser ground sites. Recycle times can be

reduced to instantaneous rapid fire by using multiple laser generating sites to engage multiple targets. Different relay paths can be used to add redundancy to the system and also mitigate the problem of limited number of discharges by a single laser site.

Countermeasures. Ground-based laser generation facilities are susceptible to conventional attack or sabotage. The orbiting mirrors will be susceptible to ASAT attack however, a large constellation of cheap orbiting mirrors is a natural counter to these measures. Excessively poor weather conditions across the entire CONUS will degrade the network capability. This may require overseas or outside the continental United States (OCONUS) basing (i.e., Hawaii, Alaska, Guam, Puerto Rico, etc.). The ability to actively modify weather conditions could be used to defeat a ground-based laser system by planting clouds over the laser site. On the other hand, the ability to remove cloud cover through weather modification may be an effective counter to the effect of poor weather on ground-based lasers.

NOTES

¹ US Naval War College (USNWC), *Technology Initiatives Game (TIG) 95* (Newport, RI, 1995), 5-1.

² Ibid., 147-1.

³ Ibid., 54.

⁴ Air University, *Air & Space in 2025 Research Study 2025*, Maxwell AFB, Ala., undated Counterspace team concept unnumbered. The space interdiction net is a possible technical approach to the problem of total battlespace awareness. Scientists argue that this may not be practical or possible by 2025. Taking this into account, this concept was rated low (i.e., beyond 2025) in the technology challenge area of the systems analysis.

⁵ John L. Peterson, *The Road to 2015* (Corte Madera Calif.: Waite Group Press, 1994), 203.

⁶ Air University, *Air & Space in 2025 Research Study 2025*, Maxwell AFB, Ala., draft, excerpt from "Weather Modification, Force Multiplier in 2025."

⁷ William Genoa, "Smallsats Come of Age," *Ad Astra*, November-December 1994, 2210.

⁸ Kaigham J. Gabriel, "Engineering Microscopic Machines," *Scientific American*, September 1995, 150.

⁹ USAF Scientific Advisory Board, *New World Vistas: Air and Space Power for the 21st Century* (unpublished draft, the space technology volume, 15 December 1995), 49.

¹⁰ Robert Langreth, "Molecular Marvels," *Popular Science*, May 1993, 91.

¹¹ *New World Vistas*, (unpublished draft, the materials volume), 125.

¹² **2025** Concept, no. 900432, "Mantle Communications System," **2025** concepts database (Maxwell AFB, Ala.: Air War College/**2025**, 1996).

¹³ K. Eric Drexler and Chris Peterson with Gayle Pergamit, *Unbounding the Future, The Nanotechnology Revolution* (New York, William Morrow and Company, Inc., 1991), 203.

¹⁴ Richard Szafranski and Martin C. Libicki, ". . . Or Go Down In Flame"? *Toward An Airpower Manifesto for the 21st Century*, 4. Further information from Dr Libicki, INSS, Lecture to Air Command and Staff College, 25 March 1996.

¹⁵ Charles Babcock, "The Incredible Shrinking Computer," *Computerworld*, October 1993, 6.

¹⁶ Air University, *Spacecast 2020-Volume II* (Maxwell AFB, Ala.; Air University Press, June 1994), M10-M13.

¹⁷ Air University, *Spacecast 2020-Operational Analysis*, (Maxwell AFB, Ala.; Air University Press, June 1994), 59-60.

¹⁸ **2025** Concept, no. 200049, “Satellite Reactive Armor (C007U),” **2025** concepts database (Maxwell AFB, Ala.: Air War College/**2025**, 1996).

¹⁹ **2025** Concept, no. 200170, “Electronic signals duplication,” **2025** concepts database (Maxwell AFB, Ala.: Air War College/**2025**, 1996).

²⁰ **2025** Concept, no. 900336, “Cloaking,” **2025** concepts database (Maxwell AFB, Ala.: Air War College/**2025**, 1996); **2025** Concept, no. 900338, “Stealth Technology,” **2025** concepts database (Maxwell AFB, Ala.: Air War College/**2025**, 1996); **2025** Concept, no. 900378, “Smart metals aircraft,” **2025** concepts database (Maxwell AFB, Ala.: Air War College/**2025**, 1996) and **2025** Concept, no. 900605, “Active Cloaking Film^Paint,” **2025** concepts database (Maxwell AFB, Ala.: Air War College/**2025**, 1996).

²¹ Sun Tzu, *The Art of War* (Oxford: Oxford University Press, 1963), 66.

²² *Electronic Warfare Threat to US Communications* (U), Defense Intelligence Agency. (Secret) Information extracted is unclassified.

²³ *Ibid.*, 32.

²⁴ Maj James G. Lee, *Counterspace Operations for Information Dominance* (Maxwell AFB, Ala.: Air University Press, 1995), 34.

²⁵ Charles A. Fowler and Robert F. Nesbit, “Tactical Deception in Air-Land Warfare,” (derived from Defense Science Board Study 1982–83), 17.

²⁶ J. Jones, *Stealth Technology—The Art of Black Magic* (Blue Ridge Summit, Pa.: Tab Books, 1989), 2.

²⁷ *Ibid.*, 13.

²⁸ **2025** Concept, no. 900336, “Cloaking,” **2025** concepts database (Maxwell AFB, Ala.: Air War College/**2025**, 1996); **2025** Concept, no. 900338, “Stealth Technology,” **2025** concepts database (Maxwell AFB, Ala.: Air War College/**2025**, 1996); **2025** Concept, no. 900378, “Smart metals aircraft,” **2025** concepts database (Maxwell AFB, Ala.: Air War College/**2025**, 1996) and **2025** Concept, no. 900605, “Active Cloaking Film^Paint,” **2025** concepts database (Maxwell AFB, Ala.: Air War College/**2025**, 1996). Nanotechnology offers a very great return on investment if it can be applied to technologies such as cloaking or molecular-sized computers. This paper explores a possible technical approach to space stealth which some scientists argue will not be practical or possible by 2025. This concern is addressed in the systems analysis by assigning such systems a low score (i.e., probably beyond 2025) in the technology challenge category.

²⁹ John Travis, “Building Bridges to the Nanoworld,” *Science*, March 1994, 1703.

³⁰ K. Eric Drexler and Chris Peterson with Gayle Pergamit, *Unbounding the Future, The Nanotechnology Revolution* (New York, William Morrow and Company, Inc., 1991), 20.

³¹ *Ibid.*, 144–145.

³² **2025** Concept, no. 901178, “Space Debris Repulsion Field,” **2025** concepts database (Maxwell AFB, Ala.: Air War College/**2025**, 1996).

³³ Craig A. Rogers, “Intelligent Materials,” *Scientific American*, September 1995, 154.

³⁴ *Ibid.*, 5.

³⁵ Roger C. Hunter, *A United States Antisatellite Policy for a Multipolar World*, (Maxwell AFB, Ala.: Air University Press, October 1995), 17–24.

³⁶ Air University, *Air & Space in 2025 Research Study 2025*, Maxwell AFB, Ala., undated, Counterspace team concept unnumbered.

³⁷ **2025** Concept, no. 900292, “Alpha Strikestar Transatmospheric,” **2025** concepts database (Maxwell AFB, Ala.: Air War College/**2025**, 1996).

³⁸ Maj Steve R. Petersen, USAF, *Space Control and the Role of Antisatellite Weapons* (Maxwell AFB, Ala.: Air University Press, 1991), x.

³⁹ *New World Vistas*, (unpublished draft, the directed energy volume), vi.

⁴⁰ **2025** Concept, no. 900420, “Laser Attack Station,” **2025** concepts database (Maxwell AFB, Ala.: Air War College/**2025**, 1996).

⁴¹ *New World Vistas*, (unpublished draft, the directed energy volume), x.

⁴² *Ibid.*, vii.

⁴³ Some scientists have argued the level of artificial intelligence required will not be achieved by 2025. This study acknowledges this debate, however, HELAS will gain most of its advantage from the ability to

crosslink data and command throughout the entire constellation. This ability has just been demonstrated with the current Milstar constellation. The ability to use artificial intelligence for routine satellite “state of health” will be the next milestone, preceded by the ability to handle all TT&C responsibilities.

⁴⁴ *2025* Concept, no. 900163, “Solar Energy Weapon,” *2025* concepts database (Maxwell AFB, Ala.: Air War College/*2025*, 1996).

⁴⁵ *2025* Concept, no. 900270, “EMP Pills,” *2025* concepts database (Maxwell AFB, Ala.: Air War College/*2025*, 1996).

⁴⁶ E. E. Cassagrande, *Non-lethal Weapons: Implications for the RAAF* (Fairbairn, Australia: Air Power Studies Centre, 1995), 4.

⁴⁷ The EMP/HPM pill is a possible technical approach to solving the problem of clandestine attack on a space adversary’s system. An energy source sufficient to fire EMP or HPM bursts as well as a propulsion system to maneuver the pill into position are technology areas which must be addressed. Some scientists have argued that these technology advances will not be practical or possible by 2025.

⁴⁸ *New World Vistas*, (unpublished draft, the directed energy volume), vi.

⁴⁹ *Ibid.*, vi.

Chapter 4

Concept of Operations For a Counterspace Architecture

To assure US space superiority over the global battlespace, all elements of the enemy's space infrastructure and system of systems must be put at risk. Counterspace operations can be offensive or defensive and future commanders will require a variety of counterspace tools to engage various threat scenarios. Offensive counterspace operations seek to neutralize enemy space capabilities before they can be employed against friendly forces. Offensive counterspace missions will target enemy space capabilities on the ground (such as ground control stations or space launch complexes), assets already in space, and satellite communication links.¹ To protect our vast array of high leveraged satellite systems, defensive counterspace will neutralize hostile threats. Defensive counterspace systems will protect both military and civilian space assets and deny any enemy the ability to degrade the effectiveness of US space systems. Both offensive and defensive space missions are required to fully achieve space superiority.

Offensive Counterspace Operations

Within our offensive counterspace architecture, several previously discussed concepts will provide the means to deny, degrade, disrupt, and, if necessary, destroy enemy space capabilities. To identify and monitor space up and down link communications, the Space Interdiction Net concept will provide instantaneous monitoring and accurate identification of any space communication to or from the ground via space-based systems. Unique links may be targeted for denial, disruption, degradation, or destruction while preserving friendly signal integrity. The Space Interdiction Net provides commanders complete space situational awareness as well as a number of discreet options to target enemy links. This is very important considering

multinational use of identical space systems when only one nation may be the offensive counterspace target. The Space Interdiction Net concept provides this valuable service, with or without knowledge of the space system's owning country or corporation. Blended with space targeting and detecting systems (laser designators, Anti-ASAT subsystems, and gravity gradiometers), offensive space systems will target the entire spectrum of enemy space capabilities. Soft kill systems such as robo-bugs and EMP/HPM pills will selectively jam or interrupt a satellite's signals without destroying it. Jamming the data transmission from the sensor to the ground user will not be sufficient in 2025. Once the sensor has collected the data (in the case of surveillance and reconnaissance), the data can be dumped to suitcase size receivers any where on the globe. Instead of targeting the data stream, it may be necessary to halt the collect of the information. EMP/HPM pills, robo bugs, and other soft-kill or temporary blinding weapons will prevent collection over the area or interest which stops the mission at the input stage. This capability greatly increases flexible response options available to space battlefield commanders.

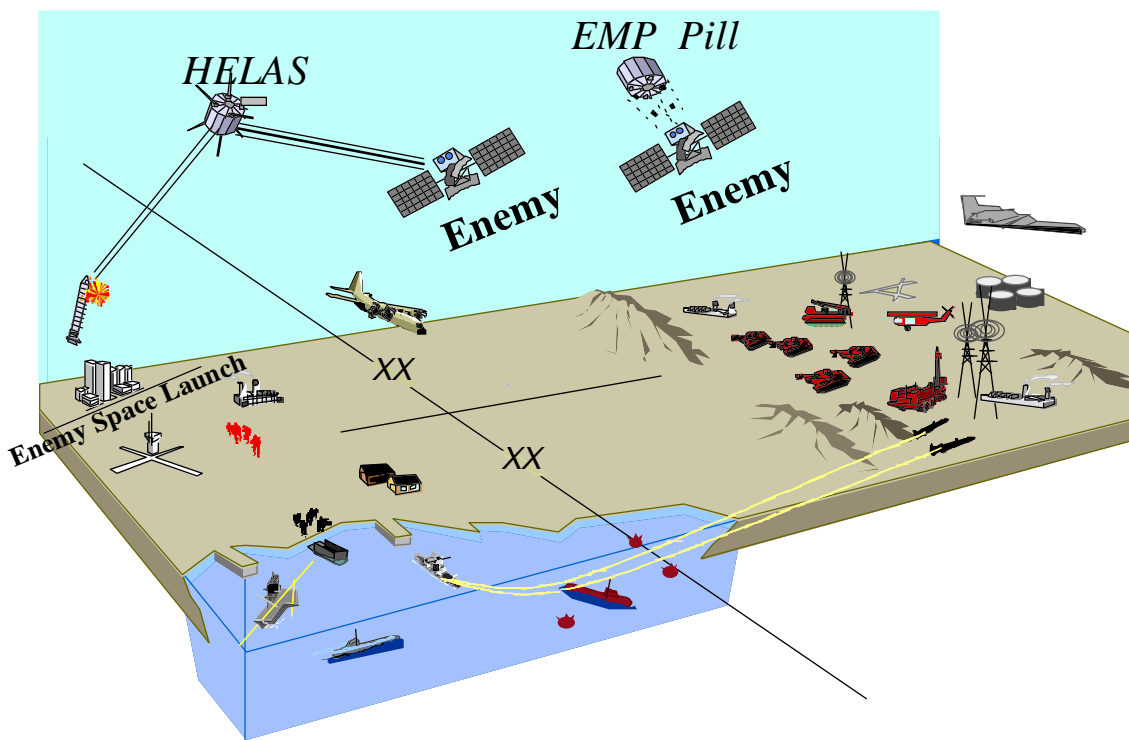

Figure 4-1. Offensive Counterspace architecture.

At the more resolved end of the counterspace spectrum lies physical destruction of enemy space capabilities. Force-on-force engagements may be necessary to destroy enemy capabilities or resupply

efforts. Directed energy weapons (ground- or space-based lasers, Strikestar TAV) provide commanders instantaneous destruction options for global and theater control. Kinetic energy weapon systems (surface, air, or space based), because of range and time limitation may best provide kill capabilities in the area of responsibility however, they can also engage globally from prepositioned locations. With a variety of offensive counterspace weapons to provide flexible engagements options to decision makers, we must also possess responsive and capable defensive counterspace systems.

Defensive Counterspace Operations

Defensive counterspace operations consist of active and passive measures designed to reduce the effectiveness of enemy space systems targeted against friendly interests. Active defense measures detect, identify, intercept, and disrupt or destroy threatening space systems. Passive defense involves protecting friendly space assets by satellite design and maneuver, warning commanders of enemy space threats, and minimizing these threats through camouflage, emission control, deception, and decoys, thus denying the enemy space data.² The Space Interdiction Net provides a valuable defensive capability by monitoring, and if necessary, targeting enemy communication links. In addition, capabilities such as cloaking and satellite bodyguards will be integrated to protect friendly space assets. Successfully employing coordinated offensive and defensive counterspace operations leads to space superiority. The High Energy Laser Attack Station (HELAS) and Ground Based Laser (GBL) offer immediate defensive kill capability. These flexible defensive systems can provide near instantaneous response to detected and identified threats to our space system.

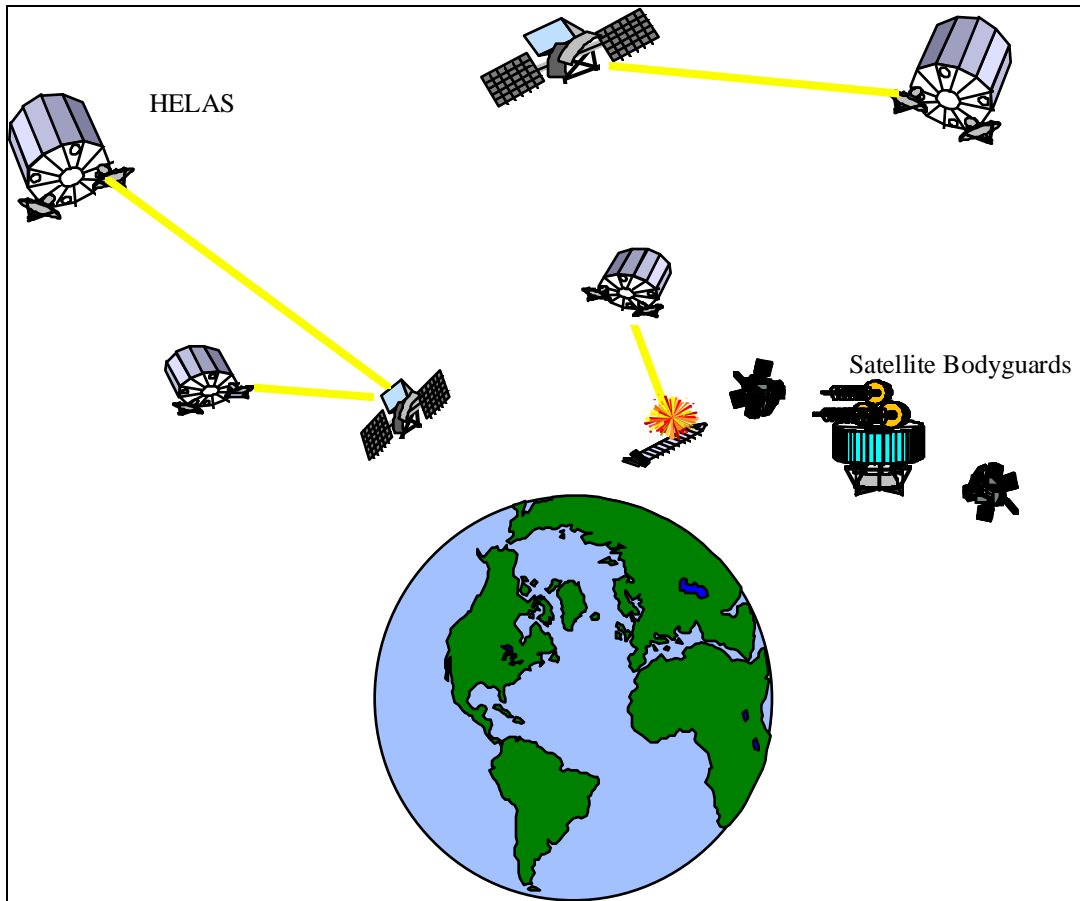

Figure 4-2. Defensive Counterspace Operations.

As more and more nations expand commercially and militarily into space, space superiority will make the difference between victory and defeat in future wars. Many nations learned a great deal from the Persian Gulf War. They noted not only the significance of precision-guided munitions but also the importance of space-based force enhancement.³ Space is the ultimate high ground—a center of gravity in any future conflict. Whoever commands that high ground in all forms will dominate future warfare.

NOTES

¹ *Air Force Doctrine Document 4, Space Operations Doctrine (First Draft)*, 15 August 1995, 12–13.

² *Ibid.*, 13.

³ Lt Col Michael R. Mantz, *The New Sword: A Theory of Space Combat Power* (Maxwell AFB, Ala.: Air University Press, 1995), 6.

Chapter 5

Investigation Recommendations

Space has been called the final frontier, the ultimate high ground, and the wave of the future. Space systems have long been recognized for their contributions to the national security of the US and have proven themselves invaluable in the conduct of modern warfare. As we approach the battlefield of 2025, we must recognize that because space is so totally integrated into the fight, we have no choice but to protect friendly space assets through defensive and offensive counterspace operations as necessary to prevent an adversary from exploiting space systems against the US. Today, we stand on the threshold of an era which will see massive integration of space systems into the way of life of the nations of the world. Those that most effectively leverage space systems will be the political, economic, and military leaders of the world of 2025.

In order to make sure the US stays out in front in space power, we must begin planning now for the counterspace architecture of 2025. Key to this effort is to be proactive in developing the technologies, systems, and operational concepts for counterspace, rather than waiting until an adversary threatens, or worse, destroys one or more US space assets. This paper has discussed key technology areas required to implement certain promising concepts to achieve space superiority. These technologies are detection and targeting, miniaturization, stealth, kinetic energy weapons, and directed energy weapons.

Detection and targeting is a key technology area which is critical to the effective employment of counterspace weapons. Dominant battlespace awareness is critical in achieving space superiority. This area is especially challenging in the 2025 space environment where satellites are used by commercial and military users alike and we must have the capability to identify and target only the appropriate parts of a mission payload or its signal. Next, miniaturization must be pursued to reduce the critical aspects of size, weight, and

cost when lifting large numbers of satellites into orbit. Work going on now in the areas of microelectromechanical systems, micro- and nanotechnology must continue and be tested in order to determine space applications. Given the likely threat capabilities of potential adversaries in 2025, the next technology, stealth, is especially critical to passively and inexpensively protecting US satellites from attack. This type of stealth is the application of nanotechnology and molecular manipulation to make satellites invisible to sensors. There is significant research, development, and testing going on in this area, and it must continue. A fourth area, kinetic energy weapons, will provide the needed capability to hold enemy satellites at risk of total destruction. This capability has already been proven from the air. Technology advances are needed to make this a capability from the ground in large numbers. Finally, the most promising means of force application lie in the area of directed energy weapons. Today the airborne laser is well on its way to operational status. This system must continue to be supported so that it can prove the feasibility of laser weapons. The follow-on efforts to airborne laser will need to prove directed energy weapons can be operated from air to space and within space. An analysis aimed at prioritizing these concepts with recommendations for future development follows.

Future Concepts—A System Analysis

In order to determine which of the counterspace concepts presented in this paper are most likely to yield the maximum return on investment, we have attempted to rank them using a subjective system analysis. Each system is scored in a number of categories which represent those characteristics most likely to contribute to air and space superiority in 2025. In addition, the systems have been scored in areas representing cost, schedule, and technical feasibility (table 3). The categories used to score the systems are:

Commercial Applicability - The extent to which the concept has technology spin-offs which contribute to the commercial sector. (5= very high commercial application; 1= very low commercial application).

Availability - Probability that the system will be operational in 2025. (5= very probable; 1= very improbable).

Payback - Return on investment will be very critical, especially in a world in which the defense budget is shrinking. (5= very high return on investment; 1= very low return on investment).

Contribution to Air and Space Superiority - Probability that a particular system will spur a military technical revolution in 2025 (a silver bullet system). (5= revolutionary contribution to air and space superiority; 1= minimal contribution).

Cost - An order of magnitude estimate of system cost. (5= system cost measured in millions; 3= system cost measured in billions; 1= system cost measured in trillions).

Lethality - Probability of kill (for offensive systems) or probability to prevent hard kill (for defensive systems). (5=very high probability of kill/save; 1=very low probability of kill/save).

Selectivity - Represents the range of options a system offers in terms of offensive or defensive capabilities. For offensive systems, selectivity measures the ability to inflict hard kill, soft kill, or both. For defensive systems, selectivity represents the ability to protect against hard kill, soft kill, or both. (5= offers all options [hard kill, soft kill, both]; 1= offers no options).

Technology Challenge - The probability that technology will advance enough in key areas to provide the capability described in the concept. (5=forecast by 2025; 4=plausible by 2025; 3= possible by 2025; 2= beyond 2025; 1= well beyond 2025).

Table 3
System Analysis Score Sheet:

Miniaturization, Stealth, and Detection/Targeting Concepts

	Satellite Bodyguards	Robo-bugs	Satellite Cloaking	SMAKS	Gravity Gradiometer	Anti-ASAT	Space Interdiction Net
Commercial Applicability	2	2	4	2	2	1	4
Availability	4	4	2	4	3	3	3
Payback	4	5	3	3	3	2	5
Contribution to Air/Space Superiority	4	5	3	3	2	3	5
Cost	3	4	2	3	3	3	2
Lethality	5	4	4	3	3	3	5
Selectivity	4	5	3	2	3	3	5
Tech Challenge	4	3	2	5	2	4	3
Total	30	32	23	25	21	22	32

Table 4
System Analysis Score Sheet:

Kinetic Energy and Directed Energy Concepts

	Alpha Strikestar TAV	High Energy Laser Attack Station	Solar Energy Optical Weapon	EMP/HPM Pills	Ground Based Laser
Commercial Applicability	4	2	4	4	2
Availability	4	3	2	4	4
Payback	5	4	4	3	4
Contribution to Air/Space Superiority	5	5	4	4	4
Cost	2	1	2	5	3
Lethality	4	5	4	4	5
Selectivity	4	3	4	4	3
Tech Challenge	4	4	3	3	5
Total	32	27	27	31	30

Based on this subjective analysis of the counterspace systems developed in this paper, a natural break in the scores appears. Those systems which fall “above the line (score of 30 or better), would seem to offer the greatest potential to contribute significantly to control of the air and space environment in 2025. Those systems (in priority order according to table 3 and table 4) are

1. Space Interdiction Net (32)
2. Alpha Strikestar TAV (32)
3. Robo-bugs (32)
4. EMP/HPM Pills (31)
5. Ground Based Laser (30)
6. Satellite Bodyguards (30)

In ranking the concepts at the top of the list, a number of factors were considered. Developing the Space Interdiction Net by 2025 pushes the technology development envelope to its maximum. However, the return is a silver bullet system which could significantly impact the way any future war in space is waged. On the other hand, the Alpha Strikestar TAV and robo-bugs offer exceptional capabilities but do not make the revolutionary impact on how war is waged that the Space Interdiction Net offers (table 4).

Each of the systems presented will rely heavily on breakthroughs in miniaturization and high-speed computing, both technologies which should see significant commercial development in the future. It is critical that the military capitalize on these advances in technology to develop systems that will offer uncontested access and control of space. Investment in systems such as those presented here will provide this capability in the future. The challenge is to move from the present to the future—where Star TEK is used to exploit the final frontier.

Appendix A

Evolving Space Doctrine in the 90s

Space Superiority as an Air Force Core Competency

In 1994 the secretary of the Air Force set three goals for the Air Force in space. The first of these goals was to make space support to the war fighter routine. Air Force Space Command has made significant progress toward this goal and continues its intensive effort to provide timely, effective space support to war fighters commanding and executing conventional campaigns. As we rapidly move toward routine space operations for war-fighting support, the need to establish and maintain freedom of operations in space becomes increasingly critical. In a speech to the Air Force Historical Foundation in the fall of 1995, Secretary Sheila E. Widnall stated, “Space superiority has emerged as a critical element of today’s military operations. Support from space is becoming the quintessential force multiplier.”¹ Indeed space superiority is one of five core competencies illuminated in the secretary of the Air Force and AF chief of staff’s recent Air Force Executive Guidance (fig. A-1). Core competencies are fundamental contributions provided by the Air Force for national security.

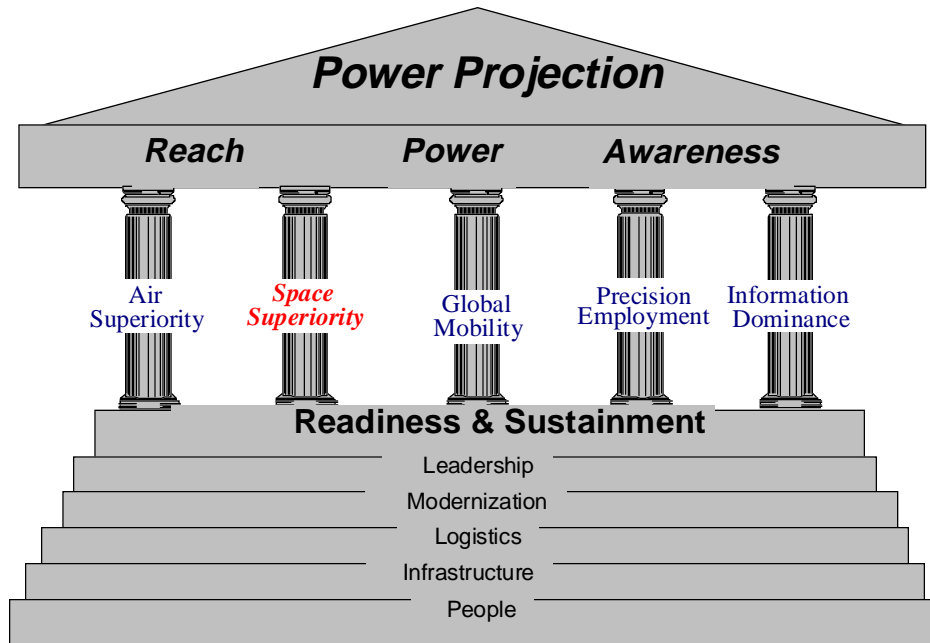

Figure A-1. Core Competencies.

These core competencies are founded on readiness and sustainment, and they support global reach, global power, and global awareness as air and space forces project power around the globe.² Space superiority as a core competency derives from deep historical roots dating to the 1950s in which the Air Force has led the way in space. Today, as the leaders in space, the USAF controls 80 percent of the Department of Defense (DOD) space budget and incorporates 90 percent of DOD’s space personnel. The Air Force supports this core competency with an annual budget of \$5 billion.³ USAF space assets make a real and substantial contribution to US national security.

Space superiority involves a sufficient degree of control to ensure US and allied forces freedom of position, maneuver, employment, and engagement in space, and it involves the ability to deny this freedom to adversaries. To date the US has not had to fight to gain and maintain space superiority. This will change as the US becomes increasingly reliant on space forces to fight and win its wars, and as the use of space systems proliferates to more and more nations around the world. In recognition of this, the Air Force Executive

Guidance states the following assumption and guidance, “Air and Space superiority will continue to be an essential element of US war-fighting capability (as well as) fielding relevant, capable space forces is a modernization priority that spans the near-, mid-, and long-term.”⁴ In its discussion of Air Force core competencies, the draft Air Force Doctrine Document 1 (AFDD 1) equates space superiority to air superiority in terms of critical importance, and it recognizes that control of space may actually secure freedom of operations in all geographical environments.⁵ Having explored space superiority as one of the five Air Force core competencies, it is now important to take a look at the evolving Air Force doctrine for this critical area.

Evolving Space Superiority Doctrine

Space superiority is achieved through counterspace operations. The current Air Force Manual 1-1 (Vol. II), *Air Force Basic Aerospace Doctrine*, March 1992, provides a limited treatment of counterspace under “Aerospace Control Missions.” The document categorizes offensive counterspace operations as those conducted against an enemy’s systems which operate in space, and defensive counterspace as missions to defend against attacks by systems operating in space. The key discriminator in differentiating between counterair missions and counterspace missions is the location of the target. If the target resides in space then the mission is counterspace regardless of the medium from which the force is applied. If the target resides in the atmosphere, then the mission is counterair.⁶ New and evolving doctrine gives more thorough treatment to the space medium.

The new draft Air Force Doctrine Document 1, *Air Force Basic Doctrine*, lays out space superiority as one of the Air Force’s five core competencies. This new document along with a new draft Air Force Doctrine Document 4, *Space Operations Doctrine*, provides a more extensive treatment of those aspects of space forces which support control of space. Space control assures a level of freedom of friendly use of space while denying this freedom to the enemy. Counterspace controls activities both in and through the space environment. An important aspect to understand is counterspace operations may be conducted by air, land, sea, special operations, as well as space forces. Like counterair it includes both offensive and defensive aspects.⁷

Offensive counterspace operations can be of a lethal or nonlethal nature as they disrupt, deny, degrade, or destroy the enemy's space systems or the information they provide. Disruption is considered to be the temporary impairment of the use of space systems and normally does not involve physical damage. Jamming is a good example of disruption. Denial refers to the temporary elimination of the use of space systems but still does not normally involve actual physical damage. An example of denial would be cutting off power to critical ground nodes. Degradation takes things a step further by permanent impairment of the use of space systems, normally through physical damage. Attacks against ground nodes would be an example of this. Finally, destruction is physical damage which permanently eliminates the utility of the space system. Use of airpower to bomb a space uplink or downlink facility falls into this category. Offensive counterspace actions are taken at a time and place of our choosing and can include attacks from space- or terrestrial-based forces on any or all segments of the enemy's space systems to include space vehicles, ground stations, and the signals emanating from both.⁸

Defensive counterspace preserves the ability to operate freely in and through space by reducing or precluding the effectiveness of the adversary's counterspace capabilities. There are two types of defensive counterspace operations, active and passive. These are defined below.

The objective of active defense is to detect, track, identify, intercept, and destroy or neutralize enemy space and missile forces. Active defense operations include maneuvering the satellite, deploying mobile ground links and terrestrial elements, and deploying decoys.

The objectives of passive defense are to reduce the vulnerabilities and to protect and increase the survivability of friendly space forces and the information they provide. Passive defense includes measures such as encryption, frequency hopping, and hardening.⁹

The new draft doctrine also identifies two important contributing capabilities to the counterspace mission: surveillance and reconnaissance of space and ballistic missile warning. Surveillance and reconnaissance of space provide the situational awareness and targeting which are essential to conducting effective counterspace operations. In addition, both space-based and ground-based systems perform detection, tracking, and reporting of ballistic missile events. These functions are critical to determining potential ballistic missile threats to the North American land mass, US operations worldwide, as well as space systems.¹⁰

The preceding discussion of current and evolving doctrine is intended to provide a departure point for discussing counterspace operations in 2025. To circumscribe the remaining discussion, we must look to

where the Air Force leadership wants us to go in the relative near-term as we then leap to 2025. The Air Force Executive Guidance document provides vectors across all areas of core competency including relevant assumptions and specific guidance statements. These assumptions and associated guidance are of such importance that they are quoted here from the Executive Guidance:

Offensive Counterspace

Assumptions:

1. US reliance on space-based capabilities will continue to increase.
2. The number of national and non-national entities utilizing space-based assets to gain advantage will increase.
3. Space situational awareness is critical to space control.

Guidance

1. The Air Force will continue to improve its ability to disrupt, deny, degrade, or destroy adversary space assets or capabilities.
2. The Air Force must survey space and protect its ability to use space while preventing adversaries from interfering with that use.

Defensive Counterspace

Assumptions:

1. Protection, denial, and negation capabilities are core and essential to space control.
2. The Air Force must expect and be prepared to defend against attacks (physical or electronic) on our space systems and facilities.
3. Protecting and assuring US access to space systems employment is essential to protecting US vital interests.
4. Protection of national security space systems capabilities using traditional measures such as deception, ground/space segment hardening, and secure C⁴I techniques and non-traditional measures through integration of defensive Information Warfare measures are necessary to achieve adversary uncertainty about US intentions, plans, and operations.
5. Protecting the Earth and our space-based assets against damage from extraterrestrial objects deserves consideration.

Guidance:

1. The Air Force must continue to enhance its denial, protection and negation capabilities.¹¹

Although fairly general in nature, the three guidance statements above give us a leaping off point to imagine the road down which the Air Force must travel to achieve a truly robust counterspace capability in

the year 2025. One last data point for framing the challenge of future counterspace operations is to understand what counterspace capabilities the Air Force employs today.

How the Air Force Does Counterspace Today

Today our counterspace capabilities are limited and primarily defensive and passive in nature. To the extent possible, US military satellite systems are hardened against electromagnetic pulse and radiation. Currently, secure command, control, and communications techniques (frequency hopping, low probability of intercept/low probability of detection, and signal encryption) are employed. Communications crosslinking provides added survivability against ground station attacks and robust system employment. Satellite subsystems are designed and built with double and triple redundancy. Large satellite constellations such as the global positioning system are dispersed to allow for graceful degradation should a small number of satellites be lost from the constellation. In addition, satellites carry fuel on board for station keeping operations which, given sufficient warning, could be used for maneuvering to attempt to avoid attack. Clearly these measures fall into the defensive counterspace realm whereby we are trying to reduce the vulnerabilities and increase the survivability of friendly space forces and the information they provide.

Perhaps the greatest amount of infrastructure and effort in defensive counterspace today lies in the extensive battle management and command, control, and communications (BM/C³) capability of the Space Defense Operations Center (SPADOC) at Cheyenne Mountain Air Force Base, Colorado. The SPADOC is responsible for defense of US and allied space systems through monitoring and reporting on unusual space activity and planning possible defensive countermeasures. It assesses possible threat attack information and determines which friendly systems are vulnerable. The SPADOC is a data fusion center with wide connectivity to all space systems owners and operators through the Space Defense Command and Control System.¹² In a hostile space environment such as that expected in 2025, today's simple countermeasure will not be sufficient to protect US space systems and critical nodes such as SPADOC will be vulnerable.

NOTES

¹ The Honorable (Dr) Sheila E. Widnall, secretary of the Air Force, "Space: No Longer a Secret," address to the Air Force Historical Foundation, Washington, D.C., 21 September 1995.

² *Air Force Executive Guidance*, December 1996, 5–6.

³ Widnall.

⁴ *Air Force Executive Guidance*, 7-8.

⁵ Air Force Doctrine Document 1, *Air Force Basic Doctrine* (First Draft), 15 August 1995, 9.

⁶ Air Force Manual 1-1, Vol. II, *Basic Aerospace Doctrine of the United States Air Force*, March 1992, 104-5.

⁷ Air Force Doctrine Document 4, *Space Operations Doctrine (Proposed Final Draft)*, 8 November 1995, 4.

⁸ *Ibid.*, 4–5.

⁹ *Ibid.*, 5.

¹⁰ *Ibid.*

¹¹ *Air Force Executive Guidance*, 9.

¹² AU-18. *Space Handbook*. Vol. 1, *A Warfighter's Guide to Space* (Maxwell AFB, Ala.: Air University Press, 1993), 103.

Bibliography

- 2025 Concept, no. 200049, "Satellite Reactive Armor (C007U)." 2025 concepts database (Maxwell AFB, Ala.: Air War College/2025, 1996).
- 2025 Concept, no. 200170, "Electronic signals duplication." 2025 concepts database (Maxwell AFB, Ala.: Air War College/2025, 1996).
- 2025 Concept, no. 900163, "Solar Energy Weapon." 2025 concepts database (Maxwell AFB, Ala.: Air War College/2025, 1996).
- 2025 Concept, no. 900270, "EMP Pills." 2025 concepts database (Maxwell AFB, Ala.: Air War College/2025, 1996).
- 2025 Concept, no. 900292, "Alpha Strikestar Transatmospheric." 2025 concepts database (Maxwell AFB, Ala.: Air War College/2025, 1996).
- 2025 Concept, no. 900336, "Cloaking." 2025 concepts database (Maxwell AFB, Ala.: Air War College/2025, 1996).
- 2025 Concept, no. 900338, "Stealth Technology." 2025 concepts database (Maxwell AFB, Ala.: Air War College/2025, 1996).
- 2025 Concept, no. 900378, "Smart metals aircraft." 2025 concepts database (Maxwell AFB, Ala.: Air War College/2025, 1996).
- 2025 Concept, no. 900420, "Laser Attack Station." 2025 concepts database (Maxwell AFB, Ala.: Air War College/2025, 1996).
- 2025 Concept, no. 900432, "Mantle Communications System." 2025 concepts database (Maxwell AFB, Ala.: Air War College/2025, 1996).
- 2025 Concept, no. 900605, "Active Cloaking Film/Paint." 2025 concepts database (Maxwell AFB, Ala.: Air War College/2025, 1996).
- 2025 Concept, no. 901178, "Space Debris Repulsion Field." 2025 concepts database (Maxwell AFB, Ala.: Air War College/2025, 1996).
- Air Force Doctrine Document 4, Space Operations Doctrine (First Draft)*, 15 August 1995.
- Air University, *Spacecast 2020-Volume II*, Maxwell AFB, Ala.: Air University Press, June 1994.
- Air University, *Spacecast 2020-Operational Analysis*, Maxwell AFB, Ala.: Air university Press, June 1994.
- AU-18. *Space Handbook*. vol. 1, *A Warfighter's Guide to Space*. Maxwell AFB, Ala.: Air University Press, 1993.
- Asker, James R. "Space Control," *Aviation Week & Space Technology*, 23 May 1994, 57.
- Babcock, Charles. "The Incredible Shrinking Computer," *Computerworld*, October 1993, 6.
- Barnett, Jeffery R. *Future War, An Assessment of Aerospace Campaigns in 2010*. Maxwell AFB, Ala.: Air University Press, 1996.
- Cassagrande, E.E. *Non-lethal Weapons: Implications for the RAAF*. Fairbairn, Australia: Air Power Studies Centre, 1995.

- Defense Intelligence Agency. *Electronic Warfare Threat to US Communications* (U) (Secret) Information extracted is unclassified.
- Drexler, K. Eric, and Chris Peterson with Gayle Pergamit. *Unbounding the Future, The Nanotechnology Revolution*. New York,: William Morrow and Company, Inc., 1991.
- Fowler, Charles A., and Robert F. Nesbit, "Tactical Deception in Air-Land Warfare," (derived from Defense Science Board Study 1982–83).
- Gabriel, Kaigham J. "Engineering Microscopic Machines," *Scientific American*, September 1995, 150.
- Genoa, William. "Smallsats Come of Age," *Ad Astra* (November-December 1994), 2210.
- Johnson, Nicholas L. *Soviet Military Strategy in Space*. WW Norton & Co., New York, N.Y., 1986, 155.
- Hunter, Roger C. *A United States Antisatellite Policy for a Multipolar World*, Maxwell AFB, Ala.: Air University Press, October 1995.
- Joint Warfighting Center Doctrine Division, *Warfighting Vision 2010 (Draft)*, Fort Monroe, Va.: 1995.
- Jones, J. *Stealth Technology—The Art of Black Magic*. Blue Ridge Summit, Pa.: Tab Books, 1989.
- Langreth, Robert. "Molecular Marvels" *Popular Science* May 1993.
- Lee, Maj James G. *Counterspace Operations for Information Dominance*. Maxwell AFB, Ala.: Air University Press, 1995.
- Libicki, Dr Martin C. and Col Richard Szafranski. "*Or Go Down in Flame*?" *Toward An Airpower Manifesto for the 21st Century*, 1996.
- Mantz, Lt Col Michael R. *The New Sword: A Theory of Space Combat Power*. Maxwell AFB, Ala.: Air University Press, 1995.
- Petersen, John L. *The Road to 2015*. Caorte Madera Calif.: Waite Group Press, 1994.
- Petersen, Major Steven R. *Space Control and the Role of Antisatellite Weapons*. Maxwell AFB, Ala.: Air University Press, 1991.
- Piotrowski, Gen John L. "A Soviet Space Strategy," *Strategic Review*, Fall 1987.
- Prepared Statements of Gen Charles Horner, commander in chief, United States Space Command, in Senate, *Space Seen as Challenge, Military's Final Frontier* (Defense Issues, Prepared Statement to Hearings before the Senate Armed Services Committee, 90th Cong., 1 sess., 1993, 7.)
- Rogers, Craig A. "Intelligent Materials" *Scientific American* September 1995, 154.
- Schneider, Barry R. "Battlefield of the Future" *The Revolution in Military Affairs*. Maxwell AFB, Ala.: Air University Press, 1995.
- Radabaugh, Capt Gregory C. "Soviet Antisatellite Capabilities," *Signal*, December 1988, 81–83.
- Travis, John. "Building Bridges to the Nanoworld," *Science*, March 1994, 1703.
- Tzu, Sun. *The Art of War*. Oxford: Oxford University Press, 1963.
- USAF Scientific Advisory Board. *New World Vistas: Air and Space Power for the 21st Century*. Unpublished draft, the Directed Energy Volume. 15 December 1995.
- . *New World Vistas: Air and Space Power for the 21st Century*. Unpublished draft, the Space Applications Volume. 15 December 1995.
- . *New World Vistas: Air and Space Power for the 21st Century*. Unpublished draft, the Space Technology Volume. 15 December 1995.
- . *New World Vistas: Air and Space Power for the 21st Century*. Unpublished draft, the Materials Volume. 15 December 1995.

US Naval War College (USNWC). *Technology Initiatives Game (TIG) 95*, Newport, R.I., 1995.

Surfing the First and Second Waves in 2025: A SOF Strategy for Regional Engagement



A Research Paper
Presented To

Air Force *2025*

by

Lt Col Thomas F. Berardinelli
Maj Sandra R. Bignell
Maj Michael J. Irwin
LCDR Alfredo E. Rackauskas (USN)

August 1996

Disclaimer

2025 is a study designed to comply with a directive from the chief of staff of the Air Force to examine the concepts, capabilities, and technologies the United States will require to remain the dominant air and space force in the future. Presented on 17 June 1996, this report was produced in the Department of Defense school environment of academic freedom and in the interest of advancing concepts related to national defense. The views expressed in this report are those of the authors and do not reflect the official policy or position of the United States Air Force, Department of Defense, or the United States government.

This report contains fictional representations of future situations/scenarios. Any similarities to real people or events, other than those specifically cited, are unintentional and are for purposes of illustration only.

This publication has been reviewed by security and policy review authorities, is unclassified, and is cleared for public release.

Contents

<i>Chapter</i>	<i>Page</i>
Disclaimer	ii
Illustrations.....	v
Tables.....	vi
Preface.....	vii
Executive Summary	viii
1 Introduction.....	1
Scope.....	2
Assumptions.....	3
Methodology.....	4
2 Regional Engagement.....	5
Core Capability and Core Competencies.....	5
Employment Opportunity	8
Organization.....	8
Regional Orientation.....	9
Force Size.....	11
Decentralized Control and Execution.....	11
Focus of Expertise	11
3 Concept of Operations (CONOP)	13
Defensive SORE.....	14
Offensive SORE.....	14
Advantages of SORE	15
4 Enabling Tasks.....	18
Recruit, Assess, and Train.....	19
Observe, Communicate, and Decide.....	25
Counter	33
Sustain	37
5 Conclusions and Recommendations	45
<i>Appendix</i>	<i>Page</i>
A Systems and Underlying Technologies	48
Recruit, Assess, and Train Systems	49
Dependencies or Training Systems Provided by Non-SORE Sources	53
C ⁴ I Systems	53
Observation or Collection Systems.....	54

Dependencies or Observation Systems Provided by Non-SORE Sources	55
Communications Systems.....	56
Dependencies or Communications Systems Provided by Non-SORE Sources	57
Decision Systems.....	59
Counter Systems.....	61
Dependencies or Counter Systems Provided by Non-SORE Sources	62
Sustain Systems.....	63
Move or Transportation Systems	66
B Definitions of Underlying Technologies	68
Bibliography	71

Illustrations

<i>Figure</i>	<i>Page</i>
1-1. Teaching Rudimentary Skills.....	2
2-1. SORE Forces Interact With Indigenous Personnel.....	9
2-2. Notional SORE Areas of Responsibility	10
3-1. The Realm of Special Operations Regional Engagement.....	13
3-2. SORE Forces Training in the First and Second Waves.	16
4-1. Illustrated "Virtual Reality" Center Concept to Provide Experience	20
4-2. Recruit, Assess, and Train Selection Cycle.....	22
4-3. Camouflage Is Critical.....	30
4-4. "Blending in with the Locals.".....	32
4-5. PSYOP in Action.....	35
4-6. "Fast Food" Production for Deployed SORE Forces.	40

Tables

<i>Table</i>	<i>Page</i>
1	Recruit, Assess, and Train Attributes 23
2	Observe, Communicate, and Decide Attributes 26
3	Counter Attributes..... 34
4	Sustain Attributes..... 38
5	Recruit, Assess, and Train System Tasks, Qualities and Measures 49
6	Training Systems' Dependency Matrix..... 51
7	C ⁴ I Tasks, Force Qualities, and Measure of Merit Matrix 54
8	Observe Systems' Dependency Matrix..... 55
9	Communications Systems' Dependency Matrix 56
10	Decision Systems' Dependency Matrix..... 60
11	Counter Tasks, Force Qualities, and Measures of Merit Matrix 61
12	Countermeasure Systems' Dependency Matrix..... 62
13	Sustain Systems' Dependency Matrix 64
14	Move Systems' Dependency Matrix 66

Preface

Special Operations Regional Engagement (SORE) is the topic of this study. Its enduring qualities are timeless in comparison to technological advancements. To frame the function, assume the challenges faced by the fictional Yankee moving back to face a medieval King Arthur's Court, or by the more contemporary Star Trek travelers "teleported" onto a planet resembling the earthly world of 1996. Although the travelers possess a multitude of techno-gadgets capable of mystifying and destroying the masses of earthly dwellers, they must abort the notion of dominating the planet with their intergalactic capabilities and, instead, work within the population they have encountered. They must assimilate the language, culture, clothing, and times; they must be familiar with the mores and values of the population they encounter. The travelers cannot influence the behavior of the "barbarian" dwellers if they do not possess the ability to evaluate the populace; wisdom to integrate and communicate on the local level; the knowledge and familiarity with the local methods of barter and trade; and collectively, operate at the inferior technical level they encounter—a level vastly different from which they have come. With this as a frame of reference, we expect the SORE forces of the next century to be faced with the same dilemmas challenging the fictional Connecticut Yankee in King Arthur's Court. This paper focuses on the ability to advance those forces technologically and firmly plant the need to retain specific rudimentary, but extremely perishable, skills which may fall prey to the "cyber-warrior" quest.

Executive Summary

The United States is riding high on the crest of “thirdwave” technology as it leads the world’s rush into the Information Age. It must not become so fixated on the information-based future that it is unprepared to deal with 78 percent of the world’s population who will still be living in preindustrial and industrial societies late into the twenty-first Century.¹ Our thesis is that Special Operations Regional Engagement (SORE) forces will be the United States’ warriors prepared to successfully engage in these less developed, though no less threatening worlds of the first- and second-wave “the ‘Niche Warriors’ of 2025.” Their timeless core competencies—skill in the use of unconventional equipment and tactics, excel in politically sensitive environments and operations, employ unorthodox approaches, exploit limited opportunity, and produce/use specialized information—make them “special” and distinguish them from conventional forces.

These core competencies underlie SORE-unique and specialized skills that make them the force of choice to meet this challenge. First, they possess the cross-cultural skills that will remain elusive for many but are needed to build and gain the trust of these underdeveloped nations—foreign language proficiency, cultural and area awareness, nonverbal communications, and interpersonal skills.² Second, they “blend” into the environments in which they operate, either using their cross-cultural skills or the new third-wave technologies at their disposal. Third, SORE forces are not employed to “fight the client’s battle” but to train them to “defend themselves” without developing a dependency on SORE forces. There is a critical air power component to SORE that the Air Force must prepare itself to meet. Many first- and second-wave entities will face threats to their internal security that may require the proper use of air power. The fledgling air forces of these entities will require assistance in developing adequate tactics, procedures, maintenance, supply, and other support systems within their own technological limitations. Last, since conventional forces will no longer possess the expertise, the weapons or the equipment found in most of these first- and second-wave areas, it will be the responsibility of SORE forces to be the “experts” in the procedures, tactics, and support requirements necessary to prevent and counter the spreading threat that “outbreaks of small wars” pose to US national interests.

SORE activities are conducted across the spectrum of military operations, from peace to war, and focus their defensive and offensive operations on training, advising, and assisting. The defensive objective is to enable host nations or other internationally recognized entities to maintain their internal security against forces that promote lawlessness, subversion, and terrorism, using their own personnel and equipment. Although ideally conducted in noncombative environments, SORE forces may be employed or unavoidably find themselves in combative situations. Offensive operations target an occupying force or established entity threatening US national interests. It may employ guerrilla warfare, subversion, sabotage, intelligence activities, evasion and escape, or other activities of low visibility, covert, or clandestine nature³ to counter these forces. Defensive or offensive operations may require independent or combined direct combat action by SORE forces. The reader should not construe this paper as an attempt to “freeze” in time the SOF foreign internal defense (FID) and unconventional warfare (UW) missions of today. Rather, the focus must be to ensure the US does not lose these essential capabilities and is caught ill-prepared or off-guard when “endless outbreaks of small wars”⁴ indirectly threatening US security become the norm of first- and second-wave nations in 2025. SORE forces will meet these challenges head-on by exploiting the advanced technology of third-wave warfare to improve their ability to operate effectively in the 126 predicted first- and second-wave nations of the twenty-first Century.⁵ They will not disrupt the evolutionary stage of those countries by introducing third-wave technology before its time but instead will work within the constraints of those countries’ capabilities, using third-wave technology only to train, prepare, and protect themselves.

The first step is employing an assessment system to “select” the best recruits for these operations, followed by realistic training and preparation in a virtual reality training center. Secondly, communications, computer, command, control, and information (C⁴I) systems that “blend” into SORE first- and second-wave environments, yet also provide “third-wave” capabilities and interoperability with conventional force systems, is paramount. Third, they must have the know-how and systems to counter threats in these regions and to assist in information warfare (IW) activities. Advances in psychological operations tools and access to “information weapons” will play a key role in SORE countermeasure capabilities and in their collateral role of IW. Lastly, since SORE is performed on a personal level, rather than from a standoff position as envisioned by conventional force or SOF precision strike operations, basic sustainment needs of the individual cannot be overlooked. Simple, portable methods to feed, water, and resupply SORE are needed.

Furthermore, lightweight and compact “energy” sources—to ensure power is available for C⁴I systems, weapons, and support equipment—must be devised. The details of these tasks and systems, as well as how they will be employed, are the heart of this white paper.

Notes

¹ Charles W. Taylor, *Alternative World Scenarios for a New Order of Nations*, Strategic Studies Institute, US Army War College, 1993, 26–28.

² These were the components of crosscultural communications identified by USCINCSOC in a briefing to the students of the Air War College on 25 March 1996.

³ Joint Pub 3-05.3, *Joint Special Operations Operational Procedures*, II-5.

⁴ Alvin and Heidi Toffler, *War and Anti-War, Making Sense of Global Chaos* (New York: Warner Books, 1993), 103.

⁵ Taylor, 26–28.

Chapter 1

Introduction

In numerous incidents during the last two decades, the inability of developed countries to protect their interests and even their citizens' lives in the face of low-level threats has been demonstrated time and again.

—Martin Van Creveld
The Transformation of War

Although not necessarily a sole superpower in 2025, the US will be a leading third-wave nation.¹ As in the past and present, the US will look to identify a threat to national survival that it can understand and fight on its own terms. This potential peer competitor, like the Germany of the World Wars and Soviet Union of the Cold War, will, in all probability, be a nation or “entity”² that generally thinks, plans, organizes, trains, and equips its forces in ways similar to the US. Justifiably, it will be important to ensure the US is a capable competitor in, if not the leader of, the third-wave world. However, it will be equally important that the US not become so fixated on building an information-based “Maginot Line” that its flanks are left vulnerable to the first- and second-wave threats that Western ethnocentrism or “technocentrism” often misunderstands or overlooks entirely. This is particularly important when one considers 78 percent of the world’s population (126 of 147 nations) will live in preindustrial or industrial societies in 2020.³

The thesis of this white paper is that in 2025, SORE forces will be the “niche warriors” that provide the capability for the US to successfully engage in the less developed, though no less threatening, worlds of the first- and second-wave.



Source: 1994 United States Special Operations Command Posture Statement, 49.

Figure 1-1. Teaching Rudimentary Skills

Scope

As the thesis indicates, it is not the intention of this white paper to address all aspects of special operations (SO) in 2025. Other valuable SO capabilities such as *Precision Strike* and *Peacespace Dominance* will be addressed in other white papers. The scope of this paper is limited to the *Regional Engagement* capability of SO. The term *regional engagement* refers to the capability to protect and pursue US interests where political and cultural sensitivity, as well as knowledge of first- and second-wave equipment, tactics, procedures, and related support, are critical. It will include potential missions such as

sabotage; subversion; guerrilla warfare; evasion and escape; counterinsurgency/secessionist/separatist operations; and training, advising, and assistance operations.

This is not an attempt to freeze in time what SO foreign internal defense (FID) and unconventional warfare (UW) operations do today. Its basic objectives will be similar. However, Regional Engagement in 2025 will exploit the advanced technology of third-wave warfare to improve its ability to operate in first- and second-wave nations without disrupting the evolutionary process of those nations. In other words, SORE forces will not introduce or train third-wave technology in first- and second-wave nations, but rather train and assist those entities in using their own technology. SORE forces will, however, exploit third-wave technology to protect, train, and prepare themselves for operations in these first- and second-wave nations.

Assumptions

The strategic backdrop for this paper is provided in the context of the 2025 Alternate Futures. These alternate futures cover a spectrum of possible scenarios and include various assumptions. The following are those assumptions, either synthesized from the alternate futures or developed by this writing team, that are most relevant to this paper's thesis:

- Agrarian, industrial, and information-based societies will exist and coexist in 2025.
- Despite advances in information technology, language and cultural skills will remain critical but elusive for many.
- Employment of humans in hostile, denied, and politically sensitive environments will be required.
- Increased urbanization will require “transparent assimilation” vice physical concealment.⁴
- Although other entities such as large transnational corporations, economic alliances, and nongovernmental organizations will become more significant players in the global community, the nation-state will remain an important actor.

Methodology

This paper is divided into three major sections and two appendices. The thesis, assumptions, and core capability serve as the common thread tying the tasks, force qualities, and underlying technologies to SORE mission needs and core competencies in 2025. The first section (chapters 2 and 3) introduces the reader to SOF core competencies, the core capability of SORE, organization, and our proposed concept of operation (CONOP) to employ this core capability. The second section (chapter 4) addresses and details the critical tasks that enable the CONOP. These enabling tasks are recruitment, assessment, training, observation, communication, decision, countermeasures, and sustainment. Movement is also an important enabling task. However, since movement support for SORE operations will come from non-SOF, host or sponsor, and/or SOF lift platforms (designed for precision strike) and are addressed in the *Airlift*, *Spacelift*, and *SOF Precision Strike* white papers, we will not address them here. The closing section (chapter 5) provides our conclusions and recommendations for the future. Two appendices support the body of this paper. Appendix A identifies and discusses the force qualities and attributes needed in the recommended systems, as well as the underlying technologies required to create those systems. Appendix B provides a brief definition of those underlying technologies.

Notes

¹ Refers to the definitions used by the Tofflers in their books, *The Third Wave* and *War and Anti-War*. The first wave encompasses agrarian-based societies; the second wave, industrial societies; and the third wave, information-based societies. See Alvin and Heidi Toffler, *War and Anti-War* (New York: Warner Books, Inc., 1993), 8–9.

² “Entity” refers to potentially significant nonnational players in the world arena, such as multi- or transnational corporations and other nongovernmental organizations.

³ Charles W. Taylor, *Alternative World Scenarios for a New Order of Nations*, Strategic Studies Institute, US Army War College, 1993, 26–28.

⁴ For instance, today’s UW operations such as evasion and escape focus on avoiding population concentrations. This assumes these missions will only be conducted in isolated areas. Based on this assumption, transparency is achieved by physical concealment. In an urban environment, avoidance of indigenous personnel will be more complex. Accordingly, SORE forces must “blend in” and be capable of handling unanticipated contact.

Chapter 2

Regional Engagement

. . . a bewildering diversity of separatist wars, ethnic and religious violence, coups d'etat, border disputes, civil upheavals, and terrorist attacks, [push] waves of poverty-stricken, war-ridden immigrants (and hordes of drug traffickers as well) cross national boundaries. In the increasingly wired global economy, many of these seemingly small conflicts trigger strong secondary effects in surrounding (and even distant) countries. Thus a "many small wars" scenario is compelling military planners in many armies to look afresh at what they call "special operations" or "special forces"—the niche warriors of tomorrow.

—Alvin and Heidi Toffler
*War and Anti-War, Making Sense
of Global Chaos*

Core Capability and Core Competencies

SORE's core capability encompasses two general components: defensive and offensive operations. The defensive objective of SORE is to prevent or free a society from subversion, lawlessness, and/or insurgency. This is primarily accomplished by training, advising, or otherwise assisting host military and paramilitary forces, with the goal of enabling the host to unilaterally assume responsibility for eliminating internal instability.¹

The offensive objective of SORE is to influence a government or nongovernmental entity whose behavior is contrary to US regional interests. Offensive operations involve a variety of military and paramilitary missions in hostile, denied, or politically sensitive areas. These missions are characterized by long duration, indirect activities including guerrilla warfare, and other offensive, low-visibility, covert, or clandestine operations.² SORE forces conduct or train and assist clients in subversion, sabotage, intelligence

activities, evasion and escape tactics, and other activities of a covert or clandestine nature.³ Operations themselves are generally conducted by indigenous forces organized, trained, equipped, supported, and directed in varying degrees by SORE forces.⁴

The SORE core capability and special operations force (SOF) core competencies are closely related. Although the targets and focus of regional engagement may vary over time, the five core competencies are timeless. SOF must (1) be skilled in the use of unconventional equipment and tactics; (2) excel in politically sensitive environments; (3) employ unorthodox approaches; (4) exploit limited opportunities; and finally (5) use and produce specialized intelligence. The following paragraphs further define the core competencies and link them to SORE. Specifically, SORE forces must be skilled in the use of unconventional equipment and tactics.

The unusual demands of a SO mission define the training and equipment required. Often, accomplishing the SO mission calls for a unique mixture of specialized skills and equipment that may be outside the capabilities of conventional forces.⁵

In 2025, this will be manifested in two ways for SORE operations. First, SORE must possess crosscultural skills. In other words, they must be regionally focused, skilled in foreign language, and culturally attuned. Second, the force must be skilled in the employment of equipment, tactics, procedures, and support functions associated with first- and second-wave societies and warfare.

Given the nature of their projected employment, they must excel in politically sensitive environments and operations.

Virtually every aspect of a SO mission is constrained by the politically sensitive context in which it is conducted. For instance, the cultural mores of a country may dictate a low-profile operation, while in another situation, larger political considerations may require a visible presence in an advisory capacity. [SO] are marked by the need for political sensitivity and require patient, long-term commitments to achieve national objectives.⁶

Patient and *long-term* are the key adjectives of this core competency. These terms neither characterize the nature of conventional force employment nor the American public's attitude about such employment. SORE operations cultivate the relationships and presence necessary to conduct missions where our interests are at stake in politically or economically sensitive areas, not otherwise accessible to conventional (third-wave) forces, yet with significant economies of force. SORE operations also provide the flexibility of using SOF visibly when a high-profile US presence is desired or covertly/clandestinely when no US signature is required, but human presence is necessary.

To meet these diverse profile employment efforts, SORE forces must employ unorthodox approaches.

SOF missions do not negate the traditional principles of war. Rather, a different emphasis is placed on their combination or relative importance. In a SO mission, surprise achieved through speed, stealth, audacity, deception, and new tactics or techniques can be far more effective and efficient than a conventional force using traditional tactics based on massed firepower and tactical maneuvers.⁷

In 2025, conventional, third-wave operations and tactics may be characterized by very precise munitions delivered from unmanned platforms or the manipulation of data from a work station far removed from the intended target. In such a world, the ability to infiltrate a SOF team and remain long enough to build a relationship of trust with indigenous personnel will certainly be considered unorthodox, yet remain critically important.

These unorthodox, critical approaches will require strict windows of availability and criteria to meet successful fruition. Specifically, SORE forces must be capable of exploiting limited opportunities.

Some SO missions . . . must capture the appropriate moment for complete success. Tactical advantage may be limited and fleeting. Repeat opportunities are unlikely, and failures will be politically and militarily costly.⁸

Although more characteristic of SOF *Precision Strike* missions, SORE operations, by exploiting the world-wide presence of deployed forces in politically sensitive areas, may provide information or be used to conduct missions where a narrow window of opportunity exists. This will be true for both low-visibility and high-visibility missions.

Again, relative to the exploitation role of SORE forces in these visibility missions and all other tasks, SORE members will use and produce specialized intelligence.

SO missions are intelligence-driven and intelligence-dependent. They require immediate and continuous access to information from traditional as well as nontraditional sources. SO generally rely on formal intelligence structures, but, for certain sensitive missions, tactical and operational information must be developed using SOF assets such as advance or reconnaissance forces. Moreover, SOF need detailed national and theater intelligence products at the tactical level of execution, often in near-real-time.⁹

SORE forces will be an excellent, nontraditional source of information valuable to political, diplomatic, economic, and military decision makers. Long-term relationships developed with indigenous personnel and/or host governments and military officials may allow the gathering of information not otherwise possible through traditional military, diplomatic, or economic contacts.

Employment Opportunity

The opportunity to employ this SORE core capability will be ripe given any of the six 2025 Alternate Futures.¹⁰ All include the possibility for instability associated with lawlessness, subversion, insurgency, separatism, secessionism and states or other entities that sponsor or conduct terrorism and other destabilizing activities. Clients may include host nations or virtually any legitimate international organization whose maintenance of stability in a given region is in the interest of the US (e.g., multi-/transnational corporations, nongovernmental organizations, and regional alliances or coalitions). SORE operations may also be targeted *against* such entities should they conduct or sponsor activities that promote instability or are counter to US interests. Opportunities for miscalculation also exist. As noted in the following, this is particularly true regarding language and cultural skills.

The relevance of [training] programs . . . depends heavily on requirements that the US intelligence community cannot always predict. Egypt and Syria emerged as the most important Arabic dialects after the Arab-Israeli War of 1967. As a direct result of that decision, only 16 Arab linguists on active duty (less than one percent) had studied Iraqi before Saddam Hussein invaded Kuwait. No one predicted large-scale SOF employment in Kurdistan or Somalia, where Operations PROVIDE COMFORT and RESTORE HOPE took place. The maintenance of language skills is just as essential as initial learning but, for most linguists, peak proficiency occurs the day they receive their diploma.¹¹

The above example provides for a positive opportunity. It illustrates how third-wave information technology can be exploited to improve our ability to engage in first- and second-wave warfare. For instance, the capability to transform information into knowledge and, ultimately, into wisdom will contribute to our ability to identify future flash points and subsequently adjust our language training. Similarly, improved technology such as the introduction of more sophisticated translating devices (although no substitute for face-to-face conversation in the spoken language)¹² and other learning enhancement devices and techniques will likely improve comprehension and retention.

Organization

It is not the intention of this white paper to become immersed in the intricacies of organizational structure, service component responsibility, or any other controversial organizational issues associated with

details and minutiae. Rather, the purpose is to identify and discuss the important characteristics of any SORE organization—be it a service or joint organization.

Regional Orientation

Americans often become “bulls in china shops” . . . The “American way” of dealing with problems sometimes fails in the international milieu. It is particularly important for American leaders . . . to be sensitive to national concerns and to listen carefully to . . . other nations.

—Perry M. Smith
*Taking Charge, A Practical
Guide for Leaders*



Source: 1994 United States Special Operations Command Posture Statement, 17.

Figure 2-1. SORE Forces Interact With Indigenous Personnel

Gen Perry Smith’s warning further underscores the importance of robust SORE forces possessing the components of an effective cross-cultural communications capability—foreign language proficiency, cultural and area awareness, nonverbal communications, and interpersonal skills.¹³ An organizational structure, based on regional orientation, is critical to ensuring SORE forces maintain this vital crosscultural capability. In a fiscally unconstrained military, areas of regional responsibility could be made smaller and more numerous to limit the diversity of language, cultural, and military capability within any one area. Such an

arrangement would allow for highly focused training and proficiency in language skills, weapons, and tactics. In a technologically unconstrained world in which a transparent language translation capability, “gift of tongues,” is available, division of regional responsibility would be less constrained or perhaps not necessary. However, based on the alternate futures and our developed assumptions, it is not likely such a favorable environment, either fiscally or technologically, will exist in 2025. With this premise in mind, figure 2-2 illustrates a notional division of responsibility that seeks some balance between diversity within a region and force structure size limitations. Since SORE operations are focused on first- and second-wave areas; North America (less Mexico), Western Europe, Japan, Australia, and New Zealand are not included in the regional coverage scheme. The specific boundaries shown, although not entirely unrealistic possibilities, are for illustrative purposes only.

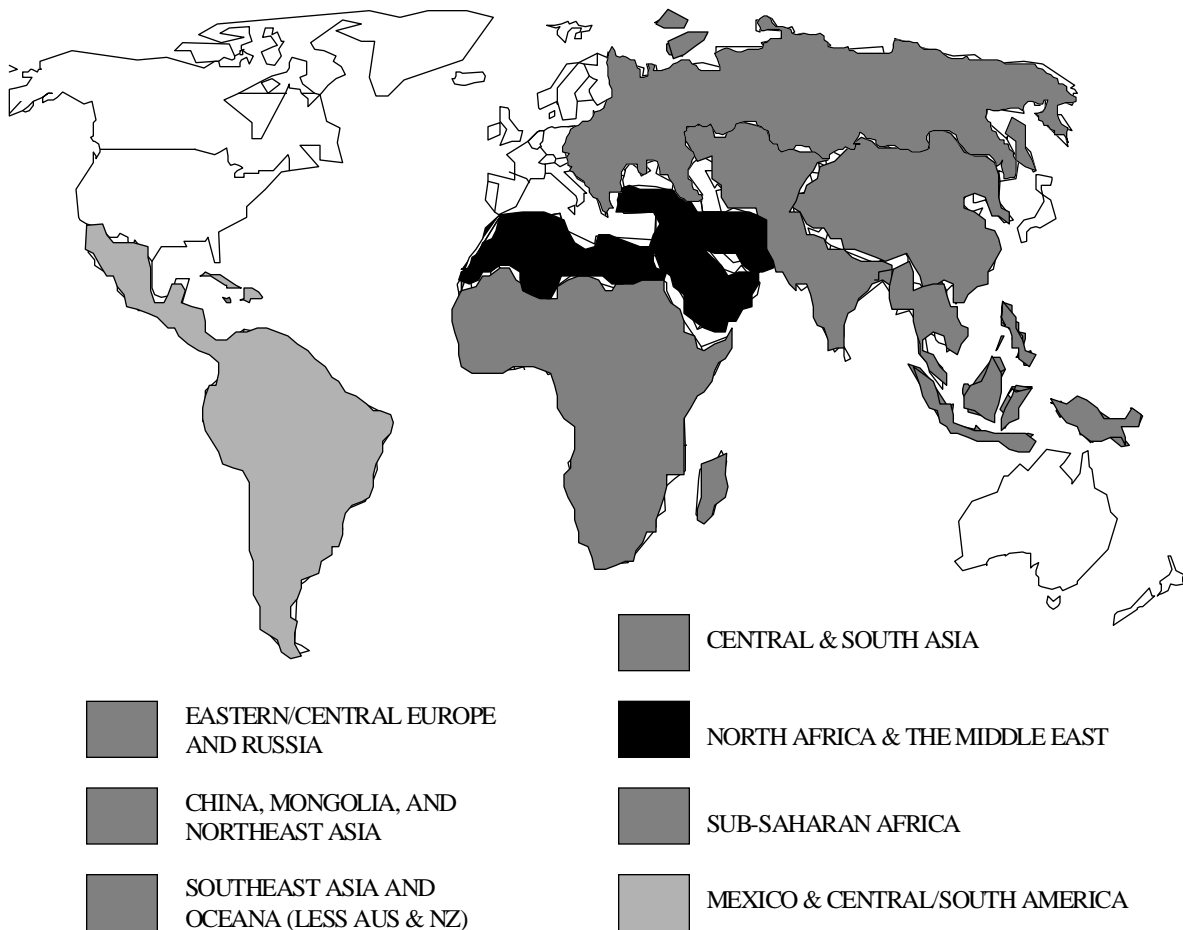

Figure 2-2. Notional SORE Areas of Responsibility

Force Size

The nature of the SORE mission will determine the size of the force. Offensive SORE missions such as sabotage or evasion and escape may require less than 10 people with little equipment. Conversely, a defensive SORE mission to train, advise, and assist a fledgling air force in air-to-ground tactics and procedures, in maintenance inspection methods, spare parts management, and weather observance and forecasting, may require a significantly larger team, in a more visible role. Nonetheless, either can be conducted more unobtrusively than large, conventional operations whose actions may be followed closely by the international media.

Decentralized Control and Execution

Greater battlefield awareness coupled with improved C⁴I will require an individual who can make rapid and correct decisions. . . these changes imply a dramatically flattened command structure staffed by an extremely high caliber of individual at every level.

—*Warfighting Vision 2010, A Framework for Change*, 1 August 1995

Another important attribute of SORE organization will be a “flat” structure that emphasizes decentralized control and execution. The continuous, long-term, low-visibility, and crosscultural nature of SORE operations demand a force that can accomplish the mission with little more than clear articulation of the desired end state and associated rules of engagement (ROE). Within these broad constraints, the SORE operator can be trusted to rely on his/her extensive training to determine the best means of accomplishing the mission (in accordance with the ROE).

Focus of Expertise

The final attribute of a SORE organization is the focus of its expertise. The aviation training mission provides a good example. The ultimate objective of SORE defensive operations is to empower the client to protect itself and maintain stability using organic equipment, weapons, and, most importantly, personnel. In terms of aviation, it is not the primary objective to teach the rudiments of initial flying qualification or “wrench turning.” It is assumed the client already has the capability to provide these basic skills. The focus of SORE operations is to improve the client’s tactics and weapons employment, which may include training

and procedures associated with support functions such as supply, maintenance, and weather. This focus has force structure implications as well. Since pilots will fly in an observer role, it is only necessary for SORE operators to be familiar with the overall characteristics of aircraft flown in the regional area of responsibility. It is not necessary for them to be qualified in all aircraft in the region. Subsequently, SORE aviation units need only possess aircraft that closely resemble the characteristics of aviation platforms in that geographic area. This capability may be accommodated through leasing arrangements that allow the unit to change its aircraft inventory to reflect regional changes on a near-real-time basis. This approach is far less costly and time consuming than the traditional research, development, acquisition and life cycle maintenance associated with traditional military aircraft inventories.

This flexible, regionally focused organizational structure optimizes the core competencies and capability discussed in this chapter. Together, they provide the foundation for successfully implementing the CONOPs in the next chapter.

Notes

¹ Joint Pub 3-05, Doctrine for Joint Special Operations, October 1992, II-8.

² The terms covert and clandestine are often confused. Doctrinally, and for the purpose of this paper, they are defined as follows. A clandestine operation places emphasis on the concealment of the operation itself. A covert operation places emphasis on the concealment of the identity of the sponsor. In special operations, an activity may be both covert and clandestine and may focus equally on operational considerations and intelligence-related activities. (See Joint Pub 1-02 and Joint Pub 3-05.)

³ Joint Pub 3-05.3, Joint Special Operations Operational Procedures, August 1993, II-1.

⁴ Joint Pub 1-02, Joint Warfare of the United States Armed Forces, January 1995, I-X.

⁵ United States Special Operations Command, The United States Special Operations Forces Posture Statement, 1994, 3.

⁶ Ibid., 3.

⁷ Ibid., 4.

⁸ Ibid.

⁹ Ibid.

¹⁰ Refer to the Alternate Futures white paper for specific definitions.

¹¹ John Collins, CRS Report for Congress, Special Operations Forces, An Assessment 1986–1993, 30 July 1993, 1991.

¹² This assertion is further addressed under the “Advantages of SORE” section of chapter 3, Concept of Operations.

¹³ These were the components of cross-cultural communications identified by USCINCSOC in a briefing to the Air War College on 25 March 1996.

Chapter 3

Concept of Operations (CONOP)

The Americans neglected to study history's many examples of supposedly outmatched combatants prevailing over better-equipped rivals. And they took it for granted that their potential adversaries would accept the American interpretation of the "revolution." But America's most likely opponents were invariably unlike America and thus not beholden to the American interpretation.

—Charles J. Dunlap, Jr.

The CONOPs for SORE in 2025 involves a broadening and enhancement of current foreign internal defense and unconventional warfare capabilities. This is particularly true for the aviation or specialized airpower component of SORE. Like the capability it employs, the CONOP has both a defensive and offensive component (see fig. 3-1).

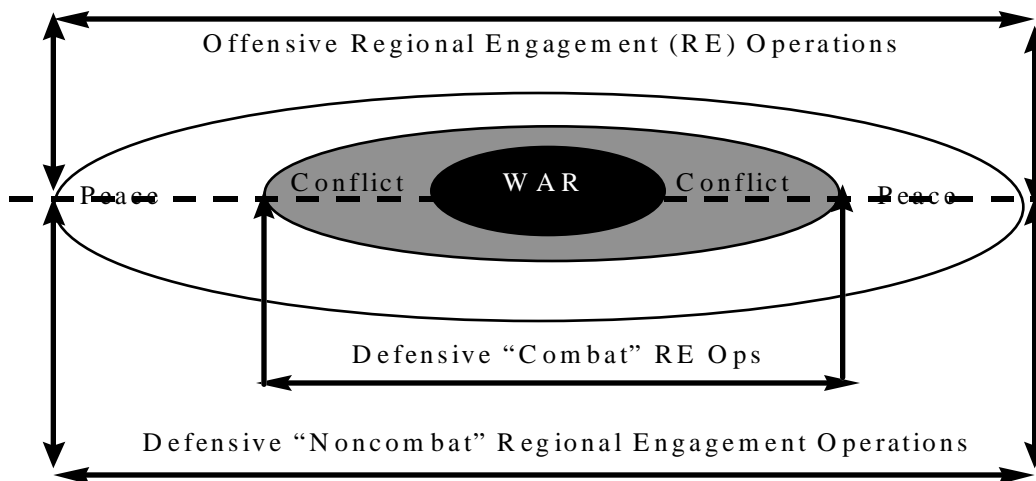

Figure 3-1. The Realm of Special Operations Regional Engagement

Defensive SORE

Given the diversity of the SORE missions within the “peaceful” realms, the defensive component can be further divided into combat and noncombat operations. Both focus on developing the indigenous leaders, organizations, and individual skills of host nations, or other entities determined to be legitimate and whose viability is considered to be in the interest of the US. In other words, these defensive SORE operations are centered on training, advising, and assisting. Ideally, potential customers are identified before they face an organized, destabilizing threat. In such cases, SORE operations would be conducted in a controlled environment that presents little threat of subjecting the team to hostile action. However, “when subversion, lawlessness, or insurgency, [separatism, or secessionist activities] threaten a friendly nation’s stability, the NCA may direct US forces to provide support to friendly nation’s counterinsurgency [et al] efforts. This support is distinct from . . . training or advisory assistance . . . because it involves the operational commitment of US forces . . .”¹ It is entirely likely that SORE operations may begin in a noncombat environment and transition to a combat environment.

An example of defensive operations may involve the employment of a SORE aviation team into a developing, second-wave nation. In such a case the team might assist the fledgling air force in developing doctrine, tactics, and procedures for conducting close air support of ground forces or combat search and rescue; a logistical system to support flying operations; and, perhaps, a limited weather observation and forecasting capability. Should the competency of this notional air force be so rudimentary, the NCA may be compelled to direct SORE forces to actually fly combat missions as part of the host nation’s aircrews. Such a decision clearly raises the consequence of failure. However, due to the possibility of a rapid transition from noncombat to combat, SORE forces must always be prepared for such an eventuality.

Offensive SORE

The offensive component of SORE “includes guerrilla warfare, subversion, sabotage, intelligence activities, evasion and escape, and other activities of a low visibility, covert, or clandestine nature.”² The core of offensive SORE operations, similar to the defensive component, is training, advising, and assisting. However, there are two essential differences. The first is the nature of the target. In offensive operations,

SORE activities are directed against an established entity or “occupying” force. The second follows from the political sensitivity of the first. The operation will almost always be conducted in a covert or clandestine manner to effectively mask US involvement. This last consideration may lead to the requirement to use sophisticated systems to infiltrate, exfiltrate, sustain, and communicate in a clandestine or covert manner. The challenge will be to exploit third-wave technology such that it will be transparent in a first- or second-wave environment.

An example of offensive SORE operations in the context of the “Zaibatsu” alternate future may involve the infiltration of a SORE team into a region dominated by a multi- or transnational corporation where vital American interests are at stake.³ Such a mission may be characterized by training, advising, and assisting indigenous personnel in harassment activities. Such an operation might also facilitate or complement a SOF precision strike mission aimed at disrupting information systems.

Advantages of SORE

The advantages of possessing a core capability to conduct SORE operations in 2025 are several fold. First, since SORE operations are focused on first- and second-wave entities, emphasis will be on weapons, tactics, procedures, and support infrastructure considered crude or primitive, both today and 30 years hence (fig. 3-2). Conventional forces of 2025 will not possess these cruder weapons, and subsequently, have no expertise in their employment.



Source: USSOCOM Pub 1, *Special Operations in Peace and War*, 2–15.

Figure 3-2. SORE Forces Training in the First and Second Waves.

Second, even if technology is available for universal or programmable language translators, imagine how intimidating or socially offensive the use of such devices might be to a non-Western and/or lesser-developed people. Unless such translation devices can be made transparent to the receiver, they will be inadequate as a replacement for the language-skilled, culturally attuned individual. The following example illustrates this point.

In Uganda last year during the efforts to assist the refugees from Rwanda, an Army Special Forces captain was tasked to introduce American aid representatives to the President of Uganda. The captain started off the conversation, introducing himself and greeting the president in the President's own language. This impressed the President greatly and smoothed the introduction of much more difficult topics and discussions. The captain's [language and cultural] training and previous deployments had allowed him to . . . make the telling first impression.⁴

Third, interpersonal relationships cultivated during SORE operations “strengthen ties with the host nation [or other entity] while building future ‘contacts’ that may not otherwise be available through traditional [or conventional] military or diplomatic channels.”⁵ Fourth, SORE operations are preventive in nature and therefore result in significant economies of scale. Early engagement of small, unobtrusive SORE teams in a variety of locations throughout the globe provide the ability to influence events before they become

media spectacles and take on a life of their own. These teams also provide a source of intelligence that can be placed in a cultural or societal context not possible with other sources.

Having described the offensive and defensive components, as well as the advantages of the CONOP, this paper now turns to its enabling tasks. In the chapter that follows, these tasks and their attributes are addressed and evaluated in detail.

Notes

¹ Joint Pub 3-05.3 *Joint Special Operations Operational Procedures*, II-5.

² *Ibid.*, II-1.

³ Refer to *Alternate Futures 2025* White Paper.

⁴ USCINCSOC Congressional Testimony, 27 March 1995.

⁵ *2025* Concept, no. 900772, "Aviation Foreign Internal Defense," *2025* Concepts Database (Maxwell AFB, Ala.: Air War College/*2025*, 1996).

Chapter 4

Enabling Tasks

As scarce resources are allocated and the highly visible . . . systems receive the most attention, it is the grunt—often equipped much as his grandfather was—that is most often called upon to implement foreign policy . . . Many situations . . . will still require...the ability to interact with local populations, and the ability to make human “in the loop” decisions.

*—2010 Warfighting Vision, A Framework
for Change, 1 August 1995*

Based on the concept of operations for SORE, very specific and defined enabling tasks emerge. Sequentially, the tasks of recruit, assess, train, observe, communicate, decide, counter, and sustain follow and are measured. In the tables throughout this chapter, the terms critical, desired, or ideal refer to the attribute's level of need for each task. A Critical attribute is required to accomplish the task. A Desired attribute allows for a reasonable expectation of enhancement that is within fiscal and technological possibility. In other words, a desired attribute may make task accomplishment or system outcome faster, more precise, or lighter weight, but the mission can still be accomplished without it in 2025. Lastly, an ideal attribute enhances task accomplishment and ultimately mission execution, yet may push fiscal and technological limits.

Recruit, Assess, and Train

My first plea is for the frontiers—not the mainstream. The mainstream, by definition, will have enough volunteers and preferences to garner the attention it needs to see us through the necessary doctrinal evolution. But what of the lonely, dangerous frontiers, with all of their uncertainties and risks? Will we have enough volunteers? Will those who volunteer have the wit, courage, and stamina that frontiers seem always to demand of pioneers? I hope that the frontiers of air and space doctrine will beckon those airmen who have the potential to be doctrinal pioneers.

—Carl H. Builder

Given that SORE operations in 2025 may occur with limited opportunity to prepare are politically sensitive and will occur in permissive, hostile and/or denied environments, selective recruitment, detailed and thorough training, coupled with continuous mission rehearsal and assessment, will be critical. The use of specialized equipment and unique skills dictate the need for an ongoing, comprehensive recruitment, training and assessment program. To this end, SORE forces will undoubtedly take advantage of developing technologies. As mentioned previously, their efforts may include direct support of first- or second-wave military or fielded forces, multinational corporations, or other governmental agencies.

If you tell me, I'll listen.

If you show me, I'll see.

If I experience it, I'll learn.

—Lao Tze, 430 BC



Source: <http://www.afit.af.mil/schools/PA/gall3.htm>. Artwork courtesy of Gene Lehman.

Figure 4-1. Illustrated "Virtual Reality" Center Concept to Provide Experience

To effectively meet these train-to-task missions, both on a continuing basis and for initial selective trimming of SORE candidates, development and use of virtual reality centers or the “holo-deck” type arenas, currently envisioned in the Star Trek TV series, should be pursued. These virtual reality centers would allow SORE forces to totally “immerse themselves” in the pending or projected mission(s) (ideally to include anticipated “environmental influences” i.e., rain, snow, mud, and cold to be encountered). For those previously qualified, the centers would provide ongoing refresher or reorientation training. For new accessions or potential candidates the center would serve as a proving ground to determine the acceptability of an untested recruit.

Further, potentially every member involved in a particular mission or deployment could rehearse his part with all the reality of executing the mission void of the potential ramifications of mistake in a sensitive environment. Mission rehearsal or selection parameters could be repeatedly played out with multiple contingencies and backup scenarios to force reactive and proactive player responses. The SORE virtual reality training centers could be linked with other similar centers allowing all participants, military and

civilian, who are not geographically collocated to interact, train, and rehearse as a single entity—as if actually accomplishing assigned tasks and responsibilities well in advance of true debarkation. Additionally, the centers should be linked to “real-time” national assets—intelligence, information and data collection, and battle management systems—to afford the injection of real-time conditions into mission training and rehearsal.

The SORE virtual reality training centers would allow mission particulars such as cultural awareness and immersion to include language skills to be “experienced” first hand. Similarly, operating with dangerous materials, highly specialized or first-wave one-of-a-kind equipment, and unique tactics could be repeatedly practiced or rehearsed, improving the quality of training and likelihood of mission success. The virtual reality training centers would be equally useful as proving grounds for evaluating potential SORE candidates.

Accordingly, SORE recruitment, assessment and training regimens and the system descriptions to support those regimens must be highlighted for operations in 2025. Initially, given the nature of SORE tasks, the potential conditions and environments in which those conditions will occur and the realistic assumption that SORE force structure will consist of a small number of selectively trained and experienced warriors, picking the “right troop” in 2025 could prove to be the cognizant driver in the accession process.

To illustrate the importance of selecting the highest caliber forces, USCINCSOC’s testimony to Congress in March 1995 provides a concise vision of what those selection demands could hold for SORE forces of the future.

It . . . requires a particularly mature, independent, and self-starting individual who can operate in small groups, often in harsh environmental conditions. Finding these kinds of individuals requires a special selection and assessment process that can gauge a person’s suitability to these kinds of tasks.¹

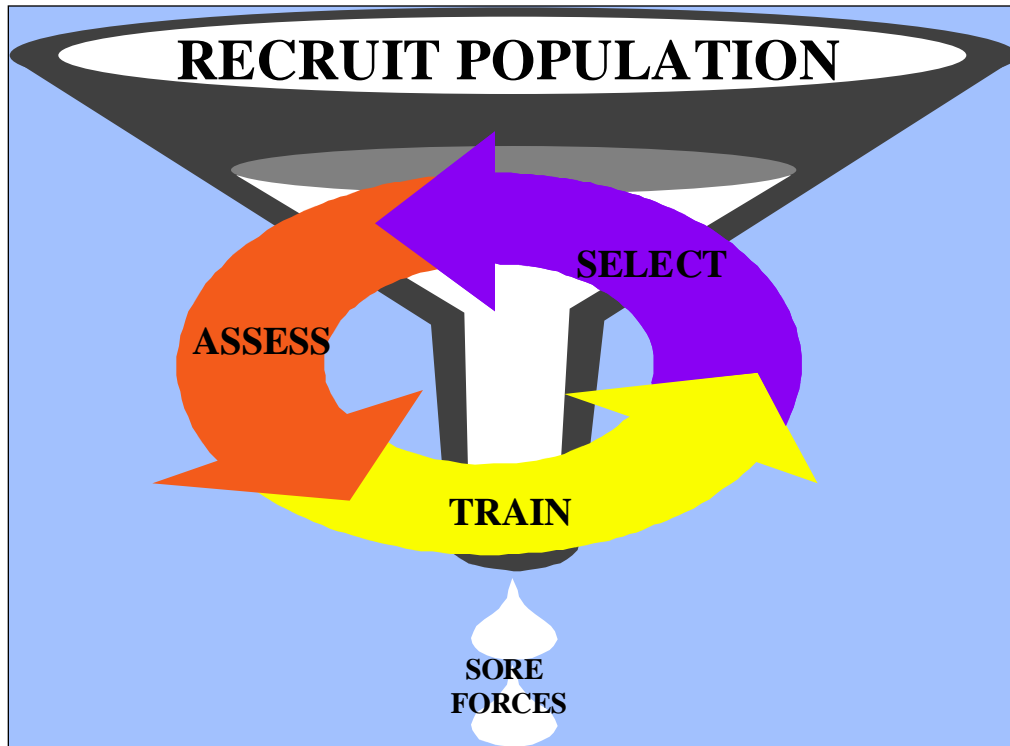

Figure 4-2. Recruit, Assess, and Train Selection Cycle

As mentioned, this “mature” population must come from the mainstream—either conventional forces or general population. Accordingly, the “Recruit, Assess, and Train Cycle” used to facilitate SORE force acquisition must be attuned to the pool of candidates available and weighted against the needs of protracted mission accomplishment. In that light, force designers must begin with the basics and construct a viable marketing program to attract potential SORE candidates. After an “acceptable” pool of candidates is identified, a vigorous assessment cycle must commence to determine which potential candidate(s) will “make the cut” for qualification training. Figure 4-2 graphically illustrates the conceptual framework for this initial recruitment and selection cycle. As noted, the recruited population may be large. After a series of “selective” psychological and physical screening tests, the pool will dwindle to reasonable proportions, similar to the manner in which NASA and the Navy screen their astronaut and SEAL candidates respectively.

While the recommendations for enhancing the collective recruit, assess, and train regimens for SORE forces follow, the concept of selective retention² must be assumed. Considering the enduring nature of our

core competencies, the same “selective” process of today must occur in 30 years, yet must be replete with the technological and medical advances anticipated. A grounded commonality remains; the process is continuous. As candidates enter the recruit funnel, the continual selection, assessment, and training regimen must be used time and again. The outcome of the cycle will result in culturally attuned, physically and mentally prepared SORE forces capable of implementing and sustaining the rigorous demands of the SORE CONOP. At any point within this cycle, a recruit will be dismissed or returned to conventional forces since SORE force employment and application is a “high-risk-of-failure” proposition.

Table 1 provides the attributes needed and desired in the initial selection/screening process and the follow-on assessment and training requirements. While these parameters will serve to initially select, continually assess, and later prepare SORE forces for specific areas of performance, the essence remains to develop an organic approach to refining the initial selection process.

Table 1
Recruit, Assess, and Train Attributes

Attribute	Recruit	Assess	Train
Cultural/Political Sensitivity	*Desired	Desired	Critical
Regional Orientation	Ideal	Desired	Critical
Language Proficiency	Desired	Critical	Critical
Negotiation Skills	Desired	Desired	Critical
Psychological Profile	Critical	Ideal	Ideal
Cognitive Learning Ability	Desired	Ideal	Ideal
Physical Attribute/Ethnicity	Desired	Desired	Desired
Adaptability	N/A	Critical	Critical
Interactive (Realistic)	N/A	Desired	Critical
Individually Tailored	N/A	Ideal	Ideal
Portability	N/A	Desired	Desired
Interoperability	N/A	Ideal	Critical

*Critical, desired, and ideal refer to “level of need” for task accomplishment.

In that vein, genetic engineering, testing, and selection parameters may prove to be an early discriminator to achieve this goal.³ Similarly, during the initial process, advance testing should be adopted to apprise an applicant's potential to learn language based on brain hemisphere dominance, profile his/her psychological state to determine historical nurturing, and IQ testing to rate cognitive learning ability. Further, future mission requirements will dictate that physical attributes of the candidate(s) be considered in building the force structure verses simply filling projected losses. To restate, initial selection procedures will be critical to effectively field the highest caliber forces to achieve specialized and changing SORE mission objectives. Given the nature of the SORE mission and the potential expense associated with its follow-on training, mistakes must be kept to a minimum or be systematically revealed at any point in the selection and/or assessment process. Ultimately, the training of selected individuals will refine and result in cognizant members capable of effectively operating as SORE employed forces.

To meld the selection and training profiles and further qualify this process, an essential element will be to speed the learning process of the people selected and being trained within the virtual system. Some innovations and ideas relevant to this enhanced ability may range from artificially intelligent word processing,⁴ to selective knowledge pills⁵ ingested as situations dictate, to accommodate the increased need to absorb magnitudes of data over extended periods of time or for short durations. Overall, these concepts may provide the key links for allowing our selected SORE forces to receive and process the massive output of the envisioned Virtual Reality Center. Again, USCINCSOC's testimony appropriately addresses the criticality of the collective tasks:

Units that conduct these operations invest a great deal of time and energy in language proficiency, cultural awareness, and regional orientation. It often takes years of study, in the actual area of operations, to develop the kind of understanding required to work with forces where the SOF operator has no command authority but must accomplish the mission through cooperation and mutual understanding. This must be followed by a training program that teaches not only the language and regional specifics, but also how to deal with and operate in unusual situations where there usually are no doctrine or guidelines and they have no authority to issue orders but must use persuasion to solve a myriad of challenges they confront.⁶

Collectively, recruitment, assessment, and training will be critical to the effective fielding of SORE forces in 2025. Without these building blocks of successful selection and preparation, the end game of their actions cannot be assured or predicted with any certainty. However, by applying specific standards to these criteria, we will dramatically increase the probability of success by fielding a select group of brilliant

warriors, selected, educated, trained, and employed in diverse regions of the world. As noted by Lt Gen Jay W. Kelley in his unpublished article addressing the Brilliant Warrior concept as applied to professional military education—“Brilliant Warriors must be critical thinkers.”⁷ The rigorous recruit, select, and train regimens described in this chapter will help produce the “brilliant warriors” of 2025.

Observe, Communicate, and Decide

*Advanced materials and electronic developments will lead to enhanced SOF communications capabilities. These [will] include features such as miniaturized command, control, and communication functions as well as embedded artificial intelligence for situational decision making. . . . To keep pace with mission requirements, SOF will require enhanced, next-generation communications equipment.*²

—United States Special Operations Forces
Posture Statement, 1994

Three enabling tasks of SORE’s core capability—observation, communication, and decision—have been grouped together because they are an inextricably linked process. Observing data, without communicating it, is of little value. Even if the ability to observe is enhanced and methods of transmitting data are improved, there is no value added unless there is a means of turning that information into knowledge useful to the decision maker. Therefore, it would be a mistake to look at these tasks individually, since the process must facilitate all three.

Brig Gen William E. Harmon, USA, program manager for the Joint Tactical Fusion Program wrote, “The most sophisticated intelligence collection in the world is worthless if the information it provides does not reach the commander in a timely manner.”⁸ The authors of *New World Vistas: Air and Space Power for the 21st Century* also agree. They assert, “The power of the new information systems will lie in their ability to correlate data automatically and rapidly from many sources to form a complete picture of the operational area, whether it be a battlefield or the site of a mobility operation.”⁹ Restated, the ability to collect, fuse, and process data into a usable form and then ship the information to the decision maker on demand is crucial. Whether the process is “third wave” as discussed by *New World Vistas*, or crude “first- or second-wave” where the process may be as simple as “seeing” with one’s own eyes, “telling” someone what you saw, “discussing” it, and then acting—the need for effective interweaving of these three tasks remains high. For

familiarity, the term C⁴I (communications, computers, command, control and intelligence) is used to refer to the “observe-communicate-decide” process—not a technological system, but rather a process.

Table 2 lists the twelve attributes imperative to the observe-communicate-decide process. The first seven—interoperability, divergence or fusion, portability, transparency, face-to-face contact, security, and resolution—are critical to SO regional engagement operations and are captured in four overriding requirements. These requirements are discussed at length in this section. The remaining five attributes are desired, not critical, and are briefly discussed.

Table 2

Observe, Communicate, and Decide Attributes

Attribute	Observe	Communicate	Decide
Interoperability	*Critical	Critical	Critical
Divergent and/or Fused	Critical	Critical	N/A
Portability	Critical	Critical	Desired
Transparency	Critical	Critical	Critical
Face-to-Face Contact	Critical	Critical	Critical
Security	Critical	Critical	Critical
Resolution	Critical	N/A	N/A
Range (global/local)	Desired	Desired	Desired
Speed (near real time)	Desired	Critical	Desired
Capacity (giga-terabits/sec)	Desired	Critical	Desired
Survivability	Desired	Desired	N/A
Accuracy	Desired	Desired	Desired

*Critical, desired, and N/A refer to “level of need” for task accomplishment.

The *four overriding requirements* needed for successful employment of SORE’s observe-communicate-decide task in 2025 are (1) interoperability and fusion with third-wave C⁴I systems with appropriate range, speed, and accuracy qualities, as well as a divergent detection and resolution capability; (2) portable field equipment that is lightweight, secure, and survivable; 3) C⁴I equipment that “blends” into

first- and second-wave nations—either using twentieth-century equipment or camouflaged, customized equipment that is transparent in first- and second-wave worlds; and (4) face-to-face communications to keep the “human in the loop.” Each requirement is impacted by various aspects related to the technology already available in the conventional forces or by the environment in which it will be employed. These aspects are addressed along with each requirement in the following paragraphs.

First, we must recognize most of SORE’s third-wave C⁴I support will come from non-SOF resources. The primary third-wave support will be interoperable, robust networks that provide an integrated C⁴I network where image, voice, and digital data are fused for transmission and receipt. An underlying concern with conventional fused systems is that “fusion” does not simply provide an “average of two data sets,” but rather a divergent detection and resolution capability necessary to support the precise nature of SOF targeting requirements. Furthermore, fusion may be difficult to attain. As *New World Vistas Study* stresses “. . . robust interpretations of sensor data are hard to develop from mathematical considerations alone . . .” and commonsense reasoning about the process of fusion must be understood and automated.¹⁰ With or without fusion, the network must also be near real-time, secure, survivable, and provide redundant transmission paths. These capabilities are not only needed for SORE but also for the conventional forces.

Information obtained from conventional C⁴I systems and divergent detection and resolution sources will be used in defensive SORE operations where the mission is focused on assisting and training sponsor forces in a noncombative environment. These sources will provide a secure, reliable C⁴I link “back home” and simultaneously provide interoperability and intelligence sharing with coalition forces, host nations, or clients. As noted in Joint Pub 3-07, “US intelligence sharing ranges from strategic analysis to current intelligence summaries and situation reporting for tactical operations. An adequate intelligence collection and dissemination capability is often one of the weakest links in a host nation’s military capability.”¹¹ However, we must be careful about what third-wave knowledge we share and how we share it. We do not want to provide “intelligence” obtained from third-wave sources or to provide the host a direct “link” to our systems unless we plan to leave it behind for the host’s future use. Otherwise, when the forces depart, the host will be at a loss.

This concept is best explained by using an example from our CONOP where US SORE forces are training a host and then are tasked to join the flying crews of sponsor nations when the environment shifts into

a combative mode. It would be tempting to offer third-wave intelligence sources to pinpoint enemy actions and to assist the sponsor in developing an operations plan, just to protect our own SORE pilots. However, this action risks leaving the host more vulnerable than when we arrived. A better approach is for SORE forces to take advantage of their “link” to intelligence systems during the non combative phase, to keep in tune with changing events in the area and to formulate the best method to optimize the host’s existing forces and resources to locate and eliminate the threat. For example, they might help the host set up a human intelligence (HUMINT) network or retrofit an existing aircraft with reconnaissance gear to gauge the nature of the impending threat. Teaching the host how to use their own resources versus “plugging” them into ours is much more beneficial to their future development.

Another key use of these same third-wave systems is predicting and dealing with the effects of urbanization. Population trends indicate that by 2010, 50 to 65 percent of the world’s population will live in urban areas.¹² We have already seen the impact of urbanization on US operations in Somalia, Haiti, and Bosnia where starvation, disease, pollution, and mass migration are staggering. The United States’ “capability to operate and conduct military operations in built-up areas and to achieve military objectives with minimum casualties and collateral damage requires more precise weapons, surveillance, sensing, target detection, and situational awareness enhancements.”¹³ Payback for developing divergent detection and resolution will be realized in this case, since “precision” will be critical.

The future holds great promise for systems that collect, fuse, and distribute information. The most likely candidates are a Global Surveillance, Reconnaissance, and Targeting System (GSRT),¹⁴ an ultraprecise, jam-resistant global positioning system (GPS),¹⁵ and worldwide surveillance, collection, and reconnaissance done from commercial, possibly international conglomerate platforms producing high-resolution mapping and worldwide weather monitoring.¹⁶ Again, the key is to provide a “fusion” capability that does not simply produce an “average of two data sets,” but rather a divergent detection and resolution capability necessary to support SOF precision identification and targeting requirements, particularly offensive SORE operations.

Similarly, there are many possibilities for improved communications networks in the future. The three most likely successors, Distributed Satellite Systems, Fiber and Satellite Networks, and direct link between satellite and aircraft, are described in *New World Vistas: Air and Space Power for the 21st Century*.¹⁷

Since these systems are addressed in the *Information Operations, Counter Information, and S & R Information Operations* white papers, we will describe them only briefly in the Systems and Underlying Technologies appendices. However, SORE “packaging” of these third-wave C⁴I systems for use in first- and second-wave nations may differ from conventional packaging. This “unique” packaging will be addressed in the third requirement.

The second requirement deals with the C⁴I systems necessary for covert or clandestine operations normally associated with offensive SORE.

[These type of SOF] missions are intelligence-driven and intelligence– dependent. They require immediate and continuous access to information from traditional as well as nontraditional sources. SO generally rely on formal intelligence structures, but, for certain, sensitive missions, tactical and operational information must be developed using SOF assets such as advanced reconnaissance forces.¹⁸

Quite simply, SOF operations will require the full array of intelligence products available to conventional forces, such as indications and warning data, orders of battle, threat tactics, weapon systems characteristics and capabilities, communications, environmental, and maritime factors.¹⁹

SORE forces will need lightweight, mobile, secure, and survivable equipment that works well in harsh, austere environments, that ensures low visibility for covert or clandestine operations, and that inherently guarantees synchronization and security of small teams fighting subversion, lawlessness, insurgency, and terrorism. The same equipment will be needed for teams that must “up close and personally” verify information on enemy capabilities, intentions, and activities that are unverifiable through conventional surveillance and intelligence means. This equipment must have the range and capacity for teams to communicate securely with command and control centers, with each other, with intelligence sources, and/or directly to weapons delivery systems.

A miniature C⁴I unit, constructed of micromechanical devices where a “single chip” is the entire system, could be embedded in a helmet, on a sleeve, or in a wristband. The system could be voice, gesture, or thought controlled as deemed plausible in *New World Vistas: Air and Space Power for the 21st Century’s*²⁰ concept of Human/Machine System Fusion.²¹ The All Seeing Warrior concept²² or the Tactical Information Display Helmet²³ are both excellent examples. Another possibility is to build very small aperture antennas (VSAT) into the receiver systems which are capable of transmitting video and sophisticated computer-generated data around the world.²⁴ These VSATs could be mounted on or embedded in a C⁴I helmet,

wristband, or any other “handy” device. In each case, either non-SOF or specialized SOF C⁴I systems, with capabilities similar to the systems used for *SOF Precision Strike*, would be appropriate.²⁵ Collectively, a potential problem may arise in providing appropriate power supplies to these microsystems without “frying” the chips. For possible solutions to this and other power problems, please refer to the “sustain” section that follows.



Source: P. J. Griffiths Magnum, “Wireless Networks,” *Scientific American*, September 1995; 53.

Figure 4-3. Camouflage Is Critical.

The third requirement highlights the uniqueness of a third-wave SORE force which must “operate and blend into” first- and second-wave worlds. It portends that, even if available, standard third-wave C⁴I systems may be inappropriate for SORE operations. For example, even though high-tech, third-wave communications systems will exist for team-to-team communications, like the Tactical Information Display Helmet,²⁶ it does not “look and feel” like the sponsoring nation’s equipment, nor does it “blend” into their low-tech environment. Rather than blend into the local environment, the helmet would merely flaunt SORE force presence and jeopardize their low profile assistance. Therefore, we may not want to employ it, since using it would defeat our purpose of training and developing the sponsored forces with their own equipment and in their own technological era.

To eliminate these problems, two solutions or approaches are suggested. First, we must be fully aware of and knowledgeable about the current technological state of our host. Next, we must be prepared to use the host’s C⁴I equipment or to deploy equipped with organic first- or second-wave equipment. We cannot expect

their equipment to be as sophisticated as ours nor can we count on them to have sufficient C4I assets to support us while in-country.²⁷ Therefore, in 2025, we must plan to arrive at the doorstep with their generation of equipment, which may be only slightly different from today's. This amplifies the need for SORE teams to be trained in a myriad of "old" and "new" technology, from 1980s' -vintage to 2025 "third-wave" high-tech systems. This is particularly true for defensive SORE operations.

The second approach is to take advantage of third-wave technology to hide or camouflage "third-wave" capabilities in first- and second-wave C⁴I equipment (retrofit) or to design high-tech systems in low-tech form or objects (mimic). The goal is to have third-wave C⁴I technology available to the SORE team, yet conceal its presence from the local population and/or host. The concealment serves two purposes. First, it ensures our SORE teams have reliable, secure communications and up-to-date intelligence for their planning and protection. Secondly, it prevents SORE teams from intimidating or offending their hosts or tempting them with advanced technology before its time, since they must evolve at their own pace, not ours.

Without camouflage in these primitive environments, reliable, secure, interoperable C⁴I may not be available to our SORE teams. The need for secure communications and updated intelligence even in a nonhostile environment is summarized in Joint Pub 3-07.1:

A thorough intelligence analysis must focus on the political, social, scientific, technical, and economic aspects of the area as well as on an analysis of hostile elements. Active intelligence support must continue through to the end of the employment of military forces in support of a program. This continuous intelligence effort will gauge the reaction of the local populace and determine the effects of US efforts, as well as evaluate strengths, weaknesses, and disposition of opposition groups in the area.²⁸

To arrive equipped with the third-wave C⁴I tools desired, embedding the already mentioned "single chip C⁴I system" alongside the rudimentary crystal inside a 1990's vintage Land Mobile Radio hand set (brick) may serve our purposes. The retrofitted "brick" would furnish the appropriate first-wave camouflage for our third-wave C⁴I, allowing us to meld into the environment with a means to communicate on their local technological level, yet allowing third-wave interface for the SORE team.

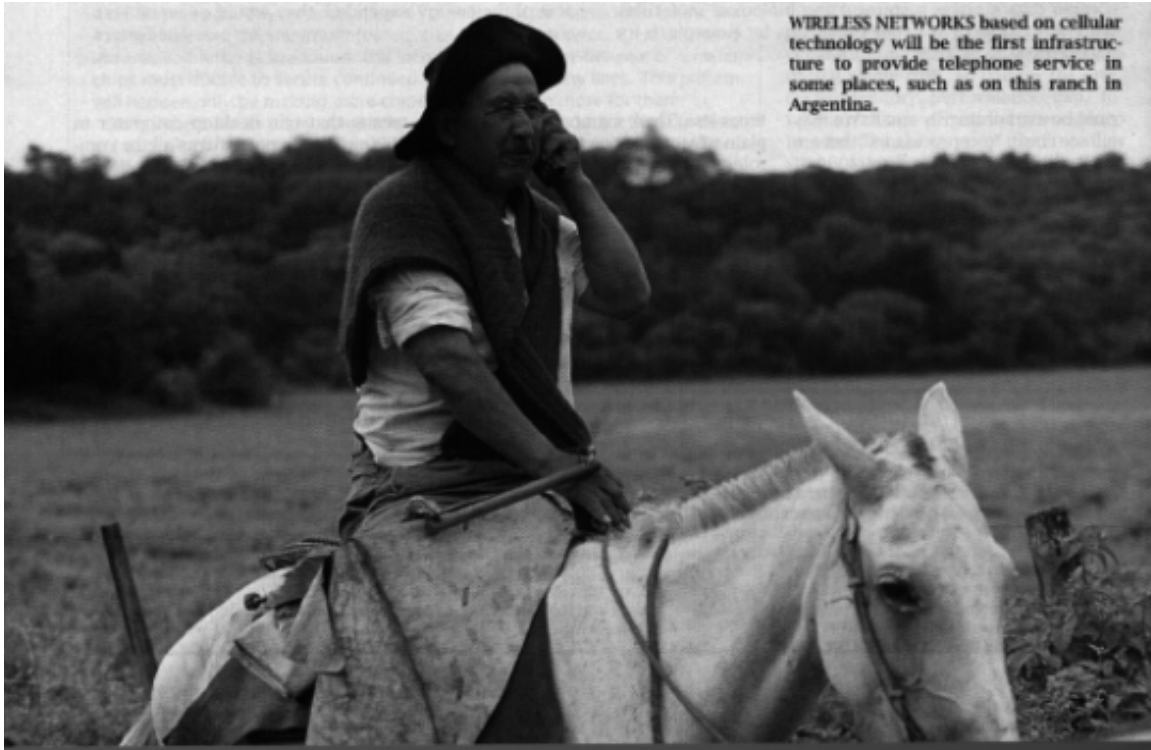

Source: Richard Pasley, "Wireless Networks," *Scientific American*, (September 1995), 52

Figure 4-4. "Blending in with the Locals."

Designing C⁴I systems resembling or "mimicking" 1990s' era equipment— such as an aircraft mechanic's toolbox, a cigarette lighter, a wristband, or a canteen— exemplifies the notion. Another candidate would be a satellite communication antenna that looks like an ordinary "leaf." Similarly, miniature listening devices in the shape of lifelike insects, such as the "Fly on the Wall"²⁹ or "Robobugs"³⁰ concepts, could easily and transparently be distributed by the SORE teams to accommodate the collection task.

The fourth and final requirement—a critical component of SO today and just as valuable in 2025—is face-to-face communications. Keeping the "human in the loop" will be important for two main reasons.

First, . . . SOF in direct combat with the enemy or in offensive operations have as their focus preparing foreign forces, either military or paramilitary, to conduct operations on a wide range of tasks from combat to nation building, in peace, as well as war. Successful conduct of these operations relies on the ability of SOF teams to establish rapport with and positively influence those they train.³¹ Secondly, in addition to standard conventional force products, SOF analytical requirements may include internal security force order of battle information, reaction time and size of opposing forces, weapon systems available to the security force, daily routine and habits of the security force and local population, security force communications, and detailed physical characteristics (such as construction materials) of specific buildings in the target area,³² precision intelligence on urbanization trends and movements, or verification of questionable data.

As stated by Dr Larry Cable in a 1996 lecture to students of the Air War College, information of this nature, although it may be verified and enhanced by technological means, is most likely to come from HUMINT sources. He further stipulated that SOF's ability to make contact with and to gain the local security forces' confidence may provide one of the best tools of intelligence gathering and unconventional warfare.³³

As such, these operations place a high premium on not only knowing the language of the people being taught but in having a thorough understanding of the culture and the area where these operations take place.³⁴ Even with extensive preparation, cultural differences and language barriers remain a major obstacle. Hence, taking advantage of training in "virtual" environments as well as employing an unobtrusive, possibly a "hearing aid" style, translator should overcome these barriers. Either way, it is important to note that, although technology might speed up the cultural indoctrination process and minimize the language barrier, unless the translator is transparent to the receiver it may only intimidate a lesser developed nation or tribe and/or offend nations of lesser development. With this in mind, exploiting the proposals for portable or handheld translators identified in the 2025 concept database should minimize their size and awkwardness.

More importantly, and as noted in Joint Pub 3-05.3, "because SORE forces focus on developing indigenous leaders, organizations, and individual skills, they conduct operations primarily on a personal level, rather than through transfer of hardware."³⁵ Thus, the focus of technology should be on improving the human's ability to learn new information faster, retain it longer, and assimilate ideas more rapidly in order to prepare them in less time for operations in countries with differing cultures, languages, dialects, and regional orientation interests.³⁶

As a final note, the real focus of third-wave technology should be directed at enhancing the effectiveness of assimilating the individual versus "arming" them with "techno-gadgets." Collectively, the emphasis should be on the processes and systems that accelerate or advance language and cultural assimilation skills and improve the person-to-person contact so vital to SORE mission success.

Counter

Since World War I, airmen have had to control the air environment effectively to employ airpower. What is more, air and space superiority are virtually sine qua non for employing ground and naval forces. Information is the next realm we must control to operate effectively and with the greatest economy of force.

—*Cornerstone of Information Warfare*
Department of the Air Force

The application of C⁴I countermeasures is another important enabling task of SORE. In fact, it is an integral component of any war-fighting concept that combines denial and influence of information, deception, disruption, and destruction to counter adversary C² while simultaneously protecting friendly C².³⁷ The five principle military actions used to achieve these results are operations security, psychological operations (PSYOP), military deception, electronic warfare (EW), and destruction. Up front, we recognize that most of SORE C⁴I countermeasure systems will come from non-SOF resources since conventional and SOF will face similar “electronic” threats.

Table 3

Counter Attributes

Attribute	Counter
Interoperability	*Critical
Fusion	Critical
Portability	Desired
Transparency	Desired
Range	Desired
Capacity	Critical

*Critical, desired, and ideal refer to “level of need” for task accomplishment.

Some protection can be gained by enforcing good operations, computer, and communications security (OPSEC, COMPUSEC, and COMSEC) procedures. Poor OPSEC is not a new problem, but one that permeates SO operations today.

A major problem in all SOF activities is denial of critical information about friendly intentions, capabilities, and activities to hostile elements. This is due to the fact that groups engaged in lawlessness and insurgency operations may be corrupted members of penetrated foreign governments. US and foreign personnel involved in SOF programs should be provided extensive OPSEC training to ensure effectiveness of their operations.³⁸

Coding/decoding methods, encryption/decryption devices, as well as a host of new security technologies could aid in solving the problem. As Dr Martin Libicki points out, “Although the contest between bit senders and bit blockers gets more sophisticated on each side, new technologies (multistatic radar, digital signal processing, spread-spectrum, public-key encryption and authentication) favor the bits getting through, uninterrupted, as well as without spoofing.”³⁹

PSYOP as “an aspect of information warfare as old as history”⁴⁰ will continue to be an invaluable countermeasure. The targets may not change, but the means to counter or affect them will. Communications support for PSYOP should concentrate on cultural assimilation, simple, and effective ways to deliver the information to the locals, and methods to negatively or positively persuade those individuals.

Psychological operations . . . multiply [the] effect of military capability by communicating directly to their enemies the power of the US or coalition forces, threat of force or retaliation, conditions of surrender, safe passage for defectors, incitations to sabotage, support to resistance groups and other messages⁴¹ as well as strengthening economic and diplomatic sanctions, and emphasizing the adversaries’ isolation or weaknesses.⁴²



Source: USSOCOM Pub 1, *Special Operations in Peace and War*, 2–17.

Figure 4-5. PSYOP in Action.

Direct PSYOP support for SORE operations should be concentrated before arrival, to facilitate positive communication with the local population. This preparation may use different media (radio, leaflets, TV, holographics, etc.) to persuade or influence. In 2025, more advanced broadcasting and projection systems, which can operate from workstations in CONUS, and leaflets distributed with precision guidance systems to target audiences should be considered. Along the same lines, a Holographic Projector⁴³ could be used as a deception or PSYOP tool projecting images in the sky above the target audience. Translators could make television, radio, holographic broadcasts, or direct contact with enemy troops or citizens more effective. In fact, direct broadcast television (DBTV), which has more than a 100–channel capability and sells for less than \$1,000 today, should be capable of providing “information on demand” in the future.⁴⁴ DBTV could be an inexpensive way to affect first- and second-wave nations in 2025.

DBTV would not only be useful as a preparation tool, it could pay high dividends as an “offensive” PSYOP tool. Just as TV mesmerized the US in the 1960s and China in the 1990s, it could be equally distracting or alluring to preindustrial and industrial nations in 2025. Broadcasting “free TV” 24 hours a day to specific targets groups could render them “immobile, infuriate the masses, or launch them into new directions.” For example, broadcasting MTV, “Soaps,” Talk Shows, and/or Educational TV for teens, and “fictional CNN” for the general public, business, military, and government could pay high dividends with minimal investment. The key is knowing the desired goal and the target audience, and then broadcasting the appropriate propaganda to achieve it.

Finally, “PSYOP is not only a user, it is a producer of intelligence, capable of contributing to the overall national effort as well as servicing its own needs.”⁴⁵ To further explain, the extensive regional collection and assessment conducted for PSYOP may produce intelligence useful for other special or conventional operations. For example, the assessment data could be incorporated in the Virtual Reality Training Center for up-to-date regional awareness training.

In a collateral role, offensive and defensive SORE forces might be tasked to assist and support other information warfare (IW) activities—particularly in the “controlling information” role where SORE forces exploit the enemy’s systems while protecting their own.⁴⁶ Since IW masks preliminary preparations and movements, overloading the enemy’s command decision making allows us to precisely apply our combat power at his most vulnerable points.⁴⁷ Therefore, the SORE forces’ role might be as simple as verifying the

“Information Warrior’s” information target. In-country acceptance of SORE forces makes them prime candidates for verifying “unconfirmed” data, providing realistic knowledge of exploitable targets for psychological operations or information warfare targets,⁴⁸ or for attaching monitoring devices (i.e., “tagging”) on potential targets in the region.

Similarly, offensive SORE forces may be tasked to influence enemy perceptions using strategic perception management (SPM)⁴⁹ or one of the many other counterinformation systems directed at military deception, electronic warfare, and destruction. Many of these systems will be available through non-SOF or specialized SOF systems. Therefore, rather than address transatmospheric reconnaissance aircraft (TRA),⁵⁰ information systems weapons or electronic countermeasures,⁵¹ defensive information warfare,⁵² or high powered microwave and high power laser directed energy weapons (HPM)⁵³ in this paper, precise information can be found in the white papers dedicated to information dominance, such as *Information Operations*, *Counter Information*, and *S & R Information Operations*.

Finally, defensive SORE forces may be required to restrict the use of third-wave systems with a host entity unless the technology is camouflaged. The rationale is twofold. First, the open use of advanced technologies, such as handheld translators may be offensive to the receivers and subsequently impede interpersonal interaction. Second, since the ultimate goal of defensive SORE is to advise, train, and assist host-entities in the use of their own aerospace equipment, it is counterproductive to make them dependent on an advanced system and then remove it when SORE forces leave. Furthermore, teaching them how to effectively use their own air assets allows them to bring their own airpower to bear on the source of internal instability without simply “handing” them our advanced technology.

Sustain

*I don't know what this “logistics” is . . . but I want some of it.*⁵⁴

As we make the mad rush into the next century, we cannot forget the basics of force survival. Although technology will play a pivotal role in many areas, the heart of all those advances will remain the individual. This is especially true for SORE forces. They may deploy to built-up, fully equipped host entities who possess and maintain “creature comforts” and infrastructures conducive to successful operations and training.

A more likely scenario, however, would be to employ SORE forces in preindustrial environments where conditions are more stark and less habitable. In these situations, their survival depends on “carrying-in” organic support. In this scenario, they must be self-reliant, innovative, and adaptable. This will be especially true for offensive SORE forces that may be isolated from more direct means of sustainment or support.

Assuming the latter is the norm, four main SORE sustenance needs must be considered: food, water, portable energy sources, and ammunition. Each is critical to the “survival” of the individual SORE warrior. Looking at the construct of Col John Warden’s five-ring analysis of “The Enemy as a System,”⁵⁵ each SORE force member is, in fact, a system with its own ring of “organic essentials.” Following his premise, SORE forces’ survival can be affected if enemy actions are directed against this ring, or if inadequate attention is paid to ensuring that the needs of this ring are met. Accordingly, given our thesis that the “man-in-the-loop” is the prime actor and “effector” of change in 2025’s less developed regions, improvements to these essentials must be foremost in our advances.

Following Warden’s analogy, all systems require certain organic essentials to survive. Without an energy source (food, oxygen, and water), the human system will cease to operate. At the center of the human system is the decision-making mechanism—the brain. Organic essentials allow the brain to process inductive and deductive logic—without which, one cannot effectively function as a “Brilliant Warrior,” to use General Kelley’s term. Obviously, without these basic essentials, a human body cannot survive. This observation may appear simplistic and it is. However, the essence remains—we must pursue methods and technologies that provide SORE forces the day-to-day capability to exist in any environment and for indefinite periods of time. Table 4 provides the task attributes and level of need to meet these requirements.

Table 4
Sustain Attributes

Attribute	Sustain
Portable	*Critical
Customized	Desired
Unobtrusive	Critical
Automatic	Ideal
Precision delivery	Critical

*Critical, desired, or ideal reference “level of need” for task accomplishment.

To begin, an individual must be put through a battery of tests to determine individual organic levels and nutritional needs. Then a survival package which is lightweight and compact can be devised and tailored for each force member. To accomplish this, we must pursue advances in food development such as biochemical-enhanced “hyper speed growth” seeds cultivated on portable substrates. Unfortunately, the “Chia Pet” is probably the only universally advertised “speed growth” method conceptually known to the general public today. Something similar to the Chia Pet concept, that is simple, fast, unobtrusive, and man-portable is needed to replenish SORE forces’ nutrients “while on the go.” The approach should seek to exploit chemically enhanced seeds, nuts, or grains which grow and produce “food” within a 24– to 72-hour period or less.



Source: Miguel L. Fairbanks, "Technology for Sustainable Agriculture," *Scientific American*, September 1995, 149.

Figure 4-6. "Fast Food" Production for Deployed SORE Forces.

These pursuits could be complimented by refined metabolic rate screening results obtained during individual assessment. The results of this screening, combined with nutritional-matching discussed above, will ensure enhanced performance during employment. A potential candidate is the human optimization of metabolic and behavioral response (HOMBRE) concept. With this system, we may be able to determine each SORE force member's metabolic type, then selectively enhance cognitive and physical performance through specific nutritional regimens.⁵⁶ Enhanced and peak performance on short-term tasks will help ensure success in any given environment.

Water purification agents and collection devices must be improved and made portable for forces in the field. A quick solution may be to use absorbent receptacles to collect dew, obtaining small quantities of

water for force sustainment in a dry environment. Long-term, more exotic sources may be the manufacture of dry chemicals which, when combined, bond at the molecular level to produce water. An even more far-reaching approach may be to filter and purify body fluids to act as an interim water supply should extreme conditions arise. Presumably, humans can exist for weeks without adequate food since the body will compensate and feed off internal reserves. However, water must be available within days, or death will result.

Given the multitude of electronic and kinetic gear used by SORE forces, portable power sources will be crucial. Several technologies must be pursued to provide these sources. For example, since water is critical to existence, methods to extract power from the hydrogen compounds in these water sources could be adapted to SORE force needs, thus doubling the benefits of having the water! Similarly, battery packs must be more compact, lighter, rechargeable, and retain longer life on a single charge.

Assuming the philosophy that man is a machine, the potential exists to create and implement technologies to exploit human movement and central or autonomic nervous system activity as low-grade energy sources to provide that potential power supply.⁵⁷ Discounting initial insertion and aviation-related missions, SORE force members will take the tried-and-true method of transport—they will walk. We must harness and exploit that energy dispensing action. For example, the physical motion of walking may lead to development of “boot chargers” located in the heels of a force member’s boots. The charger would operate or recharge as the member performs his/her daily routines. In the same vein, a plethora of other technologies are projected which may provide alternative portable energy sources. They may range from lightweight, solar panel collection systems for daylight operations, to ambient lunar light collection panels for day-night capability, to miniaturized power-generating factories on a single microchip⁵⁸. The technological leaps made in researching and powering solar-powered automobiles and satellites, as well as microscopic machines, should be investigated for SORE force application.

Finally, SORE force application may involve covert, clandestine, or hostile action. Accordingly, provisions must be made to arm and resupply the SORE warrior with first-to-third wave ammunition. While nonlethal application of force may be preferred, the nature of the SORE mission dictates possession of lethal weapons. When all else fails, a “gun,” whether loaded with kinetic energy, high-powered microwave, or 1990s’ depleted uranium projectiles must be available to SORE forces. Expedient replenishment and

replacement of first-, second- and third-wave ammunition sources must be considered. Potential solutions are precision-guided delivery systems and energy weapon recharging via direct satellite link. In both cases, sensors will monitor inventory levels and track source supply points automatically and replenish as needed. The latter concept is a “passive-push” replenishment system similar to today’s Just-in-Time or Trickle Charge systems. This approach minimizes administrative communications that may compromise covert or clandestine units and optimizes use of limited replenishment assets. Without the “tools of the trade,” SORE forces will be ineffective and at risk.

With sustainment, the enabling task discussion is complete. Having addressed those tasks and their relative importance, the next section of the paper summarizes our findings and includes some broad recommendations. For a detailed prognosis and evaluation of the systems and their underlying technologies, please refer to appendices A and B.

Notes

¹ USCINCSOC Congressional Testimony, March 1995.

² SORE force members will be recruited, assessed, retained, and employed based on actual performance. If a member’s performance falls below acceptable levels, he/she will be returned to conventional forces or separated.

³ As noted in W. F. Anderson’s article “Gene Therapy,” *Scientific American*, September 1995, 96-98B, significant progress in the realm of gene modification to affect gene-based disease has been made. Assuming quantum progress continues well into the next century, selective gene screening and DNA typing may well be applied to potential candidates. Anderson does not advocate an era of “eugenics” to alter composite gene pools. Similarly, the authors of this paper do not advocate the “super human” genetic application nor experimentation. However, the intent of this approach is to use DNA and genetic make-up as a tool for selecting the pool of SORE candidates who theoretically will be capable of replicating successful SORE operations based on those SORE forces whose genetic makeup is similar.

⁴ 2025 Concept, no. 900501, “Artificially Intelligent Word Processor,” 2025 Concepts Data Base (Maxwell AFB, Ala.: Air War College/2025, 1996).

⁵ 2025 Concept, no. 900562, “A Selective Knowledge Pill,” 2025 Concepts Data Base (Maxwell AFB, Ala.: Air War College/2025, 1996).

⁶ USCINCSOC Congressional Testimony, March 1995.

⁷ Jay W. Kelley, Lt Gen, USAF, “Brilliant Warriors,” (Draft article for *Joint Forces Quarterly*), 14.

⁸ James P. Marshall, “Near Real-Time Intelligence of the Tactical Battlefield,” *Theater Air Campaign Studies Course Book*, Maxwell AFB, Ala.: Air Command and Staff College 1996, 235.

⁹ USAF Scientific Advisory Board, *New World Vistas: Air and Space Power for the 21st Century*, summary volume (Washington, D.C.: USAF Scientific Advisory Board, 15 December 1995), 11.

¹⁰ USAF Scientific Advisory Board, *New World Vistas: Air and Space Power for the 21st Century* (unpublished draft, the information applications volume, 15 December 1995), 5.

¹¹ Joint Pub 3-07.1, *Joint Tactics, Techniques, and Procedures for Foreign Internal Defense*, 20 December 1993, I-13.

- ¹² Dr James Kvach, Armed Forces Medical Intelligence Center, *2025* Lecture, 31 January 96.
- ¹³ Joint Staff Memorandum to the SECDEF, 19 December 1995, Subject: *Volume 4 (Future Capabilities)*, *Joint Planning Document for FY 1998 through FY 2003* (JPD FY98-03), Enclosure, 3.
- ¹⁴ *Spacecast 2020, Air University into the Future, Operational Analysis*, Air University, 22 June 1994, 34.
- ¹⁵ *Ibid.*, 35.
- ¹⁶ *New World Vistas*, summary volume, 10.
- ¹⁷ *New World Vistas*, summary volume, 62.
- ¹⁸ Air Command and Staff College *United States Special Operations Forces Posture Statement*, 1994, 4.
- ¹⁹ Joint Pub 3-05.3, *Joint Special Operations Operational Procedures*, 25 August 1993, VI-2.
- ²⁰ *New World Vistas*, summary volume, 62.
- ²¹ Voice recognition and voice generation, gesture recognition and response, multilingual translation and generation, and brain control of computers technologies will all contribute to making sure the human is not the limiting factor.
- ²² *2025* Concept, no. 900263, “The All Seeing Warrior,” *2025* Concepts Data Base (Maxwell AFB, Ala.: Air War College/*2025*, 1996).
- ²³ *2025* Concept, no. 900317, “Tactical Information Display Helmet,” *2025* Concepts Data Base (Maxwell AFB, Ala.: Air War College/*2025*, 1996).
- ²⁴ John L. Petersen, *Road to 2015, Profiles of the Future* (Corte Madera, Calif.: Waite Group Press, 1994), 190–193.
- ²⁵ Power and energy supply obstacles must be overcome when developing and employing these “micro” systems. Those organic needs are addressed in the Sustain section of this chapter.
- ²⁶ *2025* Concept, no. 900317, “Tactical Information Display Helmet,” *2025* Concepts Data Base (Maxwell AFB, Ala.: Air War College/*2025*, 1996).
- ²⁷ Nor does it allow us the opportunity to exploit our own technology in their environment—this will be explained in approach two.
- ²⁸ Joint Pub 3-07.1, *Joint Tactics, Techniques, and Procedures for Foreign Internal Defense*, 20 December 1993, IV-1.
- ²⁹ *2025* Concept, no. 900280 “Fly on the Wall,” *2025* Concepts Data Base (Maxwell AFB, Ala.: Air War College/*2025*, 1996).
- ³⁰ *2025* Concept, no. 900341, “Robobugs,” *2025* Concepts Data Base (Maxwell AFB, Ala.: Air War College/*2025*, 1996).
- ³¹ Joint Pub 3-05.3, *Joint Special Operations Operational Procedures*, 25 August 1993, VI-2.
- ³² *Ibid.*
- ³³ Dr Larry Cable, University of North Carolina, Wilmington, AWC Lecture, 31 January 1996, permission granted.
- ³⁴ USCINCSOC Congressional Testimony, 27 March 1995.
- ³⁵ Joint Pub 3-05.3, *Joint Special Operations Operational Procedures*, II-5.
- ³⁶ *2025* Concept, no. 900624, “Hand-held Translator,” *2025* Concepts Data Base (Maxwell AFB, Ala.: Air War College/*2025*, 1996).
- ³⁷ *JFACC Primer*, Second Edition, February 1994, 24.
- ³⁸ Joint Pub 3-07.1, *Joint Tactics, Techniques, and Procedures for Foreign Internal Defense*, 20 December 1993, IV-6.
- ³⁹ Dr Martin Libicki, “What Is Information Warfare?” *Strategic Structures Course Book*, Vol II (Maxwell AFB, Ala.; Air Command and Staff College, 1996), 684.
- ⁴⁰ *Ibid.*, 685.

- ⁴¹ Frank L. Goldstein, “*Psychological Operations—Principles and Case Studies*,” (Maxwell AFB, Ala.: Air University Press, forthcoming), 5.
- ⁴² Jeffrey B. Jones and Michael P. Mathews, “PSYOP and the Warfighting CINC,” *Joint Forces Quarterly*, Summer 1995, 29.
- ⁴³ *Spacecast 2020, Air University into the Future*, 36.
- ⁴⁴ Wayne A. Downing, General, USA, “Joint Special Operations in Peace and War,” *Joint Forces Quarterly*, Summer 1995, 25.
- ⁴⁵ Goldstein, 147.
- ⁴⁶ *Cornerstones of Information Warfare*, Department of the Air Force, 11.
- ⁴⁷ *Warfighting Vision 2010, A Framework for Change*, 1 August 1995, Joint Warfighting Center, Doctrine Division, Fort Monroe, VA, 12.
- ⁴⁸ Dr Cable, AWC Lecture, 31 January 1996, permission granted.
- ⁴⁹ Jeffrey Cooper, *Another View of Information Warfare, Conflict in the Information Age*, SAIC, 30.
- ⁵⁰ **2025** Concept, no. 900351, “Transatmospheric Reconnaissance Aircraft (TRA),” **2025** Concepts Data Base, (Maxwell AFB, Ala.: Air War College/**2025**, 1996).
- ⁵¹ *New World Vistas*, summary volume, 60.
- ⁵² *Ibid.*, 10.
- ⁵³ *Ibid.*, 46.
- ⁵⁴ Used in opening remarks delivered by The Honorable John H. Dalton, Secretary of the Navy, while christening the USNS PATUXENT (T-AO-201), at Avondale, La., 23 July 1994. Specifically, Mr. Dalton’s context was: “Those are the words of Fleet Admiral Ernest King shortly after he became Commander-in-Chief of the US Fleet and Chief of Naval Operations. The year was 1942. America had suffered a surprise attack and her leaders realized that a long, bloody war lay ahead . . . a war that would consume vast quantities of fuels, supplies and materials. It was a war in which all Americans, from admirals commanding fleets to the men and women working in the shipyards and factories on the “home front,” would learn the word ‘logistics’ and its importance in achieving victory.” Although the context may change, the concept as applied to SORE needs remains timeless. In order to achieve victory, we must ensure the “logistics,” vis-à-vis, sustain requirements, are provided to our fielded SORE forces.
- ⁵⁵ Col John Warden, USAF, Retired, “The Enemy as a System,” *Strategic Structures Course Book*, Maxwell AFB, Ala.: Air Command and Staff College, 1996, 437–439.
- ⁵⁶ R. Wiley, HOMBRE Concept Submission, *Technology Initiatives Game 95*, Item 111-1.
- ⁵⁷ **2025** Concept, no. 900123, “Body Heat As A Low Grade Energy Source,” **2025** Concepts Data Base (Maxwell AFB, Ala: Air War College/**2025**, 1996).
- ⁵⁸ Kaigham J. Gabriel, “Engineering Microscopic Machines,” (*Scientific American*, September 1995), 118–121.

Chapter 5

Conclusions and Recommendations

Like Greely, I too would urge young men to go west—would urge airmen to look to the frontiers of air and space power. New doctrine is desperately needed there. The doctrinal gaps . . . are probably as great as those faced by the ACTS [Air Corps Tactical School] pioneers 60 years ago as they contemplated the doctrinal gap between an air service and an air force. Stalking and conquering frontiers are clearly the Air Force heritage. That alone should tell us where the future lies.

—Carl H. Builder

Currently, the Air Force is struggling with its frontier missions and those missions' place in doctrine. Most are familiar with our frontiers in space and information. Air Force leadership, past and present, has placed significant emphasis on coming to grips with the Air Force role in these areas. Other frontiers have not been lavished with as much attention. The aviation piece of SORE may provide a breakthrough in this regard. Although not a “glamorous” mission, it is nonetheless a vital one if the Air Force is to come to understand its role in this frontier of warfare.

In 2025, the United States will face challenges to its leadership and interests from nations and entities in the first-, second-, and third-waves. SORE forces will be the military forces organized, trained, and equipped to engage in the first- and second-waves to protect and further US interests. SORE is not just a ground or riverine mission suited to “green berets” and SEALs. There is a critical air power component to SORE that the Air Force must prepare itself to meet. Many first- and second-wave nations and entities will face threats to their internal security that require the proper use of air power. The fledgling air forces of these entities will require assistance in developing adequate tactics, procedures, maintenance, supply, and other support systems within their own technological limitations.

The challenge to all SORE forces is fourfold. First, they must possess the cross cultural skills necessary to build the trust that underlies productive interpersonal relationships. Second, they must use these same crosscultural skills to make themselves as “transparent” as possible in the environments in which they operate. This is particularly true for SORE offensive operations which are almost always covert or clandestine. Third, they must exploit the advanced technology at their disposal, to prepare and protect themselves in the context of first- and second-wave societies. Lastly, SORE forces must ultimately ensure clients do not develop any dependence on them, lest we set the stage for failure when we depart.

The myriad of challenges can be overcome and the capabilities achieved using both SOF and non-SOF resources. In fact, many systems forecast for SORE operations in 2025 may not be SOF-unique. However, to ensure the SORE tasks are accomplished, a combination of conventionally developed, commercially leased resources, or specially designed SOF-unique systems must be available to ensure SORE conceptual employment goals are met.

We recommend the following concepts and systems be pursued for SO Regional Engagement operations: (1) Designing a recruitment and selection system—Virtual Reality combined with genetic and cognitive learning ability screening; (2) Developing a similar or exclusive Virtual Reality Training/Battlefield Awareness Center for training, rehearsal, and assessment; (3) Retrofitting first- and second-wave C⁴I equipment with “third-wave” technology (the Land Mobile Radio “Brick” example); (4) Designing third-wave equipment, “mimic systems,” camouflaged in first- and second-wave form (a C⁴I system disguised as an aircraft mechanic’s toolbox or a SATCOM antenna shaped like an ordinary leaf) or designing third-wave technology that “fits” first- and second-wave signature (the “Fly on the Wall” or “Robobugs” collection devices; or “The All Seeing Warrior” contact lens); (5) Procuring standoff PSYOP broadcasting and projection systems as well as precision-guided delivery systems; (6) Minimizing language barriers with “transparent” translators; (7) Taking advantage of standard third-wave C⁴I systems such as the Global Surveillance, Reconnaissance, and Targeting System, Global Positioning System, Strategic Perception Management systems, distributed satellite systems, and direct satellite link to large aircraft and UAVs, to name a few, for interoperability and compatibility across all services; and finally; (8) Pursuing sustainment systems such as fast growing food, chemically bonding water capsules, microchip power

supplies or “recharging combat boots,” as well as some type of “passive push” replenishment systems and concurrent nutritional enhancement regimens—HOMBRE.

Our final recommendation is to capture the requirement for a SORE capability in defense planning guidance. Without such emphasis and resultant funding, the research and development of these systems’ underlying technologies will not be possible. Without these “parts-pieces,” the systems needed will not be fielded, and our “2025 SORE Warriors” will be out of place in “King Arthur’s Court.” As Carl Builder notes:

It takes farsightedness and guts to build an armed force that will only be called to fight in, say, a decade. One has to guess, as best one can, what resources will be available, what kind of opponent the force will be called on to face, and what kind of environment they will have to operate in. Those fundamental questions settled, the time comes to decide how to best meet the challenges ahead.¹

The time is now to make these decisions. The current draft of Air Force Doctrine Document (AFDD) 1 is not a pioneer effort regarding air power in Special Operations. It is the hope of the authors that this white paper will contribute to the “pioneer” spirit that Carl Builder calls for in the development of future air power doctrine.

Notes

¹ Martin Van Creveld, *The Transformation of War* (New York: Free Press, 1991), 117.

Appendix A

Systems and Underlying Technologies

We cannot always be on the leading edge of technology ourselves. It is too expensive. We have adopted a program of prudent innovation, choosing carefully which technological paths to take and fully leveraging the research conducted by the Services, other government agencies, and the private sector.

—USINCSOC Congressional Testimony
27 MARCH 1995

Special Operations will require training, C⁴I, countermeasure, sustainment and movement (transportation) systems, and/or concepts that can support a wide variety of missions, ranging from nation assistance or civil-military activities in friendly environments, to assistance of conventional forces in hostile environments, to special operations in enemy-held, enemy-controlled, or politically sensitive environments. These systems must provide the SORE warrior the tools necessary to carry out missions of controlling, exploiting, and enhancing overall force effectiveness.

This appendix is divided into seven sections—train, observe, communicate, decide, counter, sustain, and move. Each section identifies those systems that are SORE unique or reliant on other sources, ranging from conventional forces, commercially leased, host “entity,” to SOF-unique systems developed for another “arm” of SOF. “Dependencies” matrices are provided for each function, where a quick picture of those systems can be referenced—table 6 discusses training; tables 8 to 10 show C⁴I; table 12 reflects countermeasures; table 13 details sustainment, and movement systems are spelled out in table 14. Within each major section, the enabling task’s attributes and measures of merit (MOM) are laid out in table 5 for training, 7 for C⁴I, and 11 for countermeasures. The system descriptions follow in the text.

Recruit, Assess, and Train Systems

SORE recruitment, training, and assessment regimens and the system attributes are presented in table 5. The table presents the attributes required of a training system with the respective measures of merit needed to gauge the effectiveness of that system. The effectiveness is based on the outcome and qualities of the individual skills learned. The system (as defined) must act as a filter and trainer for potential SORE candidates. For example, in the selection and training process, a person's ability to adapt to a culture, learn a language, operate a vintage aircraft, or act as an individual negotiator in his/her region of employment must be the outcome and will be the measure. Hence, the matrix shows those requirements and effectively rates them on a scale of critical to ideal, as discussed in chapter 4. In addition, the force qualities' level of need is targeted against its application to each task—recruit, assess, or train. As a note of caution, the systems may fill the requirements of all tasks, however the scale of importance will vary greatly depending on the status of the process (i.e., stage of recruitment, level of assessment after selection, or mission training requirements based on specific tasking). On a linear scale, as the system outcome draws closer to actual employment, level of criticality increases. Within the table, common criticality levels reflect an **X**. Where levels of importance vary, the task affected falls under the relevant criticality column.

Table 5

Recruit, Assess, and Train System Tasks, Qualities and Measures

TASK	CRIT/DES/IDL			Force Quality	Measure of Merit
R, A, T	X			Cult/Pol Sensitivity	Multi-Wave Skilled
R, A, T	T	A	R	Regional Orientation	Number of Regions Support
R, A, T	X			Language Prof	Number of Languages Prof
R, A, T		X		Negotiation Skills	Number of “Successful” Results
R, A, T	R		A/T	Psychological Profile	Based on Empirical Data
R, A, T		R	A/T	Cognitive Learn Ability	Retention Testing/Evaluation
R			X	Physical Attributes	“Look the Part”
A, T	X			Adaptability	Number of Variations Possible
A, T	T	A		Interactive/Realistic	Number of Scenarios/Waves
A, T			X	Individually Tailored	Number Trained/What Level
A, T			X	Portable	Time/Transport Require to Move
A, T	T	A		Interoperable	Near Real-time Input and Update

R=Recruit, A=Assess, T=Train, Crit=Critical, Des=Desired, Idl= Ideal, X=Common

Several training systems and concepts exist or are projected which may be unique to SORE recruitment, assessment, and training or may be drawn from other sources. As depicted in table 6, these systems could be beneficial but are not essential to SORE training.

Table 6

Training Systems' Dependency Matrix

RECRUIT, ASSESS, TRAIN SYSTEMS	SORE Source	NON-SOF Source	OTHER SOF Source	HOST Source
Virtual Reality Trainer	X		X	
HOMBRE	X			
Rehearsal System		X	X	
“Gumping” A/V Lib		X		
Selective Knowledge Pill			X	
AI Word Processor		X		

The Virtual Reality Training Center/Virtual Battlefield allows participants, despite their geographic location, to simultaneously visit the same virtual battlefield in whatever type of tank, plane, ship or system they will be tasked to use. They “see” the battlefield from their own individual perspective which enables simultaneous viewing of the battlespace or the peacespace by all participants. Similarly, this approach will allow for real-time simulations—giving the force commander real-time, hands-on experience in the battle or peace space, and will afford the opportunity to try modified and divergent tactics and will interpret results, while the mission is in virtual progress. This virtual battlefield approach offers the specialization and evaluation required without the potential for deadly mistakes prior to employment. Similarly, this approach also tracks real-time actions taken as they are played out for subsequent mission preparation and use by other teams.¹

To create a realistic “virtual” environment will require technology from multiple sources. Data fusion and image-processing techniques will be needed to acquire, transfer, analyze, display, and interpret raw intelligence to change it into useful, usable information in real time.² Virtual reality and holography technology must be available. As these technologies proceed, not only will they be used for the Virtual Battlefield System at home, but they will allow fielded SORE forces to take advantage of full-color, three-dimensional projection transmitted to their employment location on demand.

Similarly, high performance computing³ with extremely high-performance digital vector and massive parallel processor architecture will be needed to process the plethora of data in real time. Without this high-speed capability, information saturation will inevitably occur. Molecular nanotechnology follows the same principle of building “things from the bottom up.” Working at the individual atomic level, it must be possible to exploit this bottom-up approach to training the regional warrior, from accession through separation, using molecular sized machines to put information together in predetermined configurations.⁴ If we assume nanotechnology will effectively size information to the molecular level, we can then use the principle of condensed charge technology to produce small, tightly bound dense clusters of electron charges of enormous power relative to their size and effectively integrate the spark, or more accurately micro-arc discharges, into our system to take advantage of the phenomenon.⁵ Assuming human-system interface can be achieved, information can then be made, controlled, and used on command by the SORE member on the ground.⁶ As situations and environments change, regional engagement operators must not be surprised by the unexpected. Recurring training, by “plugging in,” to the “home-based” system will be the most effective method to keep surprise to a minimum.

Further, to optimize the cognitive learning skills of the individual, the Human Optimization of Metabolic and Behavioral Response (HOMBRE) system attempts to match the nutritional regimen of SORE intermediary metabolic profiles to systematically and sequentially enhance the needed cognitive performance.⁷ The system will match the regimen to the individual and occupy a “feed and forget” phenomenon to promote and predict successful performance.⁸ While the input and feeding may be needed for short durations, the possibility exists that this approach can be applied over longer periods as the situation dictates. Further, reverse engineering may allow for the same process to be applied in selecting SORE candidates, after sufficient data is obtained, which will point toward the most effective metabolic rates to screen and recruit for new accessions.

Determination of metabolic genotypes will be one of the underlying technologies needed for this enhancement process to be possible. The notion of gene typing and selective enhancement is feasible. The requirement and capability for enhanced signal and pattern discrimination capability currently exist.⁹ The system matches the prognosis regimen to the individual instead of mass application and thus increases

probability of predicted outcome. Using this approach, metabolic rates can be limited and thus be more effective. The process can work in concert with other systematic enhancements or serve in a stand-alone capacity.

Dependencies or Training Systems Provided by Non-SORE Sources

Advancing development by related forces or scientific fields should make these systems available from other employment efforts. Accordingly, SORE application and system modification should occur as these technologies evolve. For example, if available through other sources, the “Rehearsal for all Missions System,”¹⁰ could provide an additional resource for realistic training, while the “Gumping Audio and Video Library”¹¹ could provide the highly motivated individual another tool to train at their own pace and convenience. The “Artificially Intelligent Word Processor”¹² might be used for day-to-day training and preparation of conventional forces or corporate employees, or for tracking individual work progress automatically without the associated cumbersome filing and status system of today. The final conceptual approach to developing a “selective knowledge pill” relates directly to enhancing brain functions by intentionally introducing chemical imbalances in the central nervous system stem core. Detailed research must be conducted before this aggressive application can occur; however, the same principle as applied to behavior modification can be used. Obviously, SORE force training would benefit from these advancements, yet development should not occur based solely on RE mission requirements.

C⁴I Systems

Table 7 displays the attributes needed in SORE observe-communicate-decide systems. The matrix shows the relationship between the task, its “level of need,” the force quality or attribute needed to support the task, and the measure to determine the system’s merit. Again, within the table, a single “**X**” in either the critical, desired, or ideal column indicates the same “level of need” crosses all three tasks. When the level of need differs among the three tasks, the individual task’s “level” is indicated by its “initial” in the appropriate—critical, desired or, ideal—column.

Table 7

C⁴I Tasks, Force Qualities, and Measure of Merit Matrix

TASK	CRIT/DES/IDL			FORCE QUALITY	MEASURE OF MERIT
O,C,D	X			Face to Face Contact	100% w/locals / min with C ² at HQ
O,C,D	X			Transparent	Blends into 1st/2d wave worlds
O,C,D	X			Interoperability	With standard C ⁴ I systems
O,C	X			Divergent and/or Fused	Intel, surv, comm, weather, etc.
O,C,D	X			Secure	95%
O,C,D	O/C	D		Portable	Under 1 lb.-unobtrusive
O,C,D		X		Range	Global and Local
O,C,D	C	O/D		Capacity	Giga/terabits/sec
O,C,D	C	O/D		Speed	Near Real-time
O	X			Resolution	High
O,C		X		Survivability	All Wave
O,C,D		X		Accuracy	95%

O=Observe, C=Communicate, D=Decide, Crit=Critical, Des=Desired, Idl=Ideal

In all the *unique* SORE systems listed in tables 8 through 10, “transparency” or “packaging” is the principle priority. If forces cannot “blend” into their first- and second-wave environments, success in their operational employment will be suspect.

Observation or Collection Systems

Table 8 lists the collection systems sourced by SORE and those expected to be available through other sources. All would be useful to the SORE warrior; however, only the first- and second-wave “retrofitted or mimicked” systems should be organically sourced by SORE. All the other systems should be available through other awareness as indicated in the table.

Table 8

Observe Systems' Dependency Matrix

“OBSERVE” SYSTEMS	SORESource	Non-SOF Source	SOF PS Source	Host-Entity Source
Retrofitted 1st/2d Wave	X			
“Mimicked” 1st/2d Wave	X			
All Seeing Warrior		X	X	
Fly on the Wall/Robobugs		X	X	

A host of retrofitted and “mimic” observation systems resembling twentieth-century objects should be valuable in first- and second-wave environments. For example, embedding (retrofitting) host entities’ collection equipment with third-wave technology or designing listening and audio devices resembling ordinary 1990s’ “stuff” such as an aircraft mechanics toolbox, canteen, or cigarette lighter should be pursued. The underlying technologies for these retrofitted or “mimicked” systems might be metal-oxide semiconductors, CPUs on a single microchip, high performance computing, electromagnetic communications, and divergent detection and resolution technology. Critical dependencies include technologies that interface system actions to communication networks for interoperability, fusion, and long-haul transmission.

Dependencies or Observation Systems Provided by Non-SORE Sources

The remaining collection systems will be equally valuable to conventional forces and should be fielded by non-SOF resources. The “All Seeing Warrior,” a contact lens-like display for a warrior which provides all sensor, surveillance, reconnaissance, intelligence, and aircraft data at the blink of an eye, creating a seamless, real-time display for unsurpassed situational awareness¹³ is a potential candidate. The same underlying technologies needed to build other collection platforms apply, with the addition of nanotechnology to miniaturize the system, as well as a safe, nonirritating material to make the lens comfortable. Critical dependencies include commercial adaptation, data compression and transmission technology, divergent detection and resolution technology, and fused, interoperable communication systems.

The “Fly on the Wall”¹⁴ or “Robobugs”¹⁵ concepts provide the foundation ideas where miniature, remotely controlled “robot bugs” embedded with audio and video sensors or lasers are used for data collection or destruction. Underlying technologies are Alife techniques, nanotechnology, metal-oxide semiconductors, and single-chip CPUs.

Communications Systems

All of the systems identified in table 9 are required for SORE forces to communicate among themselves and/or back to headquarters. Only the “real” first- and second-wave equipment or the “retrofitted and mimicked” systems should be sourced by SORE. All the other systems are equally valuable to conventional forces and the commercial sector, thus should be available through alternate sources.

Table 9

Communications Systems' Dependency Matrix

“COMMUNICATE” SYSTEMS	SORE Source	Non-SOF Source	SOF PS Source	Host-Entity Source
First / Second Wave Equip	X			X
Retrofitted 1st/2d Wave Equip	X			
“Mimicked” 1st/2d Wave	X			
Translators		X	X	
Tactical Info Display Helmet		X	X	
VSAT		X	X	
Distributed Satellite Sys		X		
Fiber and Satellite Sys		X		
Direct link to URAV/ Lg A/C		X		
Transatmospheric Recc Aircraft		X		

Actual first- and second-wave communications equipment may be needed in 2025. Standard twentieth-century communications equipment like today’s communications systems—land mobile radios (bricks), high

frequency (HF) radios, tactical satellite systems (TACSAT), telecommunications devices such as digital switching systems, and computers must be available and kept operationally current. This equipment may be the only viable method for SORE forces to interface with host equipment.

The most important force qualities in the next two concepts are transparency, interoperability, and fused or divergent data. Without these third-wave qualities, we cannot guarantee that SORE forces operating in crude surroundings will have access to third-wave technology and/or systems.

The first concept is retrofitting or camouflaging “third-wave” micromechanical single chip systems into the host’s low-tech apparatus. For example, a 1990-vintage land mobile radio equipped with a C⁴I microchip could provide the communication link needed for all ranges and levels—from first through third-wave environments.

The other method is designing custom communications systems that “mimic” or “fit” into a first- or second-wave environment. For example, a satellite communications antenna that looks like an ordinary “leaf” that can be easily set up by “planting” it in the ground would be invaluable in the jungle or an urban area. Or, as described in the “observe” section, equipment built to look like 1990s’ everyday articles but are actually sophisticated, third-wave communications equipment, could be invaluable collection aids.

The primary underlying technologies for all of these systems will be metal-oxide semiconductors, CPUs on a single microchip, and high performance computing. In addition, these systems will require interface to the communications networks described in the following section.

Dependencies or Communications Systems Provided by Non-SORE Sources

First, a wide array of language translators suggested in the 2025 concept database should be available and beneficial to the SORE warrior, especially in PSYOP where translation could enhance television and radio broadcasts or direct contact with enemy troops or citizens. However, unless transparent, they would have minimal use to the SORE warrior in the field. Therefore, a translator resembling a “hearing aid” would be the most beneficial. Other potential systems include the “Universal Language Translator,”¹⁶ a pendant-size translator capable of translating voice both to and from a receiver, and several variations of the same concept, the “Hand-held Translator,” the “Portable Language Translator,” and/or the “Universal Translator.”¹⁷

A tactical information display helmet, a helmet that provides the warrior a full spectrum of C⁴I displayed across a face screen and controlled via voice or gesture,¹⁸ coupled with a very small aperture antenna (VSAT) capable of transmitting audio, video, and sophisticated computer-generated data around the globe,¹⁹ would be a tremendous combat field device. However, the helmet may be perceived as threatening in a nonhostile environment, and thus unusable until engaged in a combative operation. Again, underlying technologies include, but are not limited to, metal-oxide semiconductors, CPUs on a single microchip, and high performance computing with a strong dependency on interface to the communications networks described below.

The key to all the C⁴I systems discussed thus far, and in the next two sections; whether for collection, communication, decision-making, or countering, is interoperability via fiber and/or satellite networks. As cited in the *New World Vistas Report*,

Distributed satellite systems, partly or wholly commercial, are a natural way to provide affordable connectivity where fiber is nonexistent. We depend more and more on commercial terrestrial communication networks because they are redundant, reliable, survivable and cost effective. We seem to insist, however, on developing military satellite communication (SATCOM) systems in spite of their exorbitant cost and limited performance.

During the next decade commercial SATCOM systems will exceed the capacity, reliability, and survivability of the military system. Commercial systems will have multiple ground stations which connect to the world wide fiber system. They will eventually use laser cross-links and down-links that will dramatically increase redundancy of the systems. It is likely that the commercial systems can be used for military purposes more reliably than can dedicated systems. This will be especially true if other nations develop anti-satellite systems.²⁰

An alternative is using direct satellite link to large aircraft and URAVs, which requires a much smaller architecture and is less expensive.²¹ Authors of *New World Vistas* reinforce the notion. Specifically, they assert that: “Certainly direct satellite links should be provided to all air lifters, AWACS, Joints STARS, URAVs and tankers. Commercial carriers will probably suffice for the air lifter links and perhaps for the tanker links.”²² They detail the communication ties in great depth. For example,

We estimate that MHz bandwidth is possible [for direct communications between high performance aircraft and satellite] if the fighter aircraft has a conformal phased array antenna. Cost of this is very high. It is now true that fighter aircraft are seldom out of range of communication with large aircraft such as a tanker, AWACS, or Joints STARS.

As high altitude URAVs, enter the theater in large numbers, line of sight communications between them and a fighter aircraft will be reliable. A URAV at 60,000 feet can transmit line of sight to a fighter at 20,000 feet over a range of over 400 NM. Line of sight is not

necessarily the limit of communication range for a high power transmitter . . . reliable communications over long range to standard antennas onboard a fighter aircraft can be accomplished without direct satellite links.²³ The deployment of airborne transmitters and satellite receivers in a bistatic²⁴ geometry . . . may be the ultimate system to provide what AWACs and Joint STARS provide today.²⁵

A similar alternative may be the application of the transatmospheric reconnaissance aircraft methodology of providing real-time surveillance when ASAT knocks out our satellites. It operates below ASAT level and above SAM level.²⁶

Warfighting Vision 2010, A Framework for Change suggested commercial adaptation for improving future communication networks.

C⁴I for the Warrior concept integrates commercial and military networks and systems. This “Systems of Systems” maximizes feasibility, interoperability, capability, cost, security, availability, precedence and assures military service . . . Artificial Intelligence (AI) supports more efficient fusion and fully integrated multimedia, multi-functional processors capable of near real-time decision aiding. Multilevel Security (MLS) solutions include multiple layer encryption, combined with electron, benign, transparent cryptographic key distribution and automated key management approaches. Network security devices provide the flexibility to maintain security without degrading operational effectiveness. Data compression and transmission technologies involve increasing speed and efficiency while decreasing the cost of processing and transferring digital information, including voice, data, imagery and video. Computing before communicating is increasingly important as computer technology outpaces increased bandwidth technology.²⁷

Collectively, these technologies will be the underlying building blocks necessary for successful integration of SORE communications requirements. The need for many of these technologies will be widespread, serving a diverse audience ranging from business, to government, to the military, and to the general public. Therefore, availability of these technologies and systems should be common place and not sourced by SOF alone.

Decision Systems

As table 10 indicates, none of these decision systems will be developed solely for SORE forces. However, all would be extremely beneficial for SORE operations, especially in their collateral mission of Information Warfare. The purpose of presenting these systems in this white paper is to ensure the conventional forces pursue development.

Table 10

Decision Systems' Dependency Matrix

“DECIDE” SYSTEMS	SORE Source	Non-SOF Source	SOF PS Source	Host Entity Source
GSRT-Global Surv/Recon/Trk		X		
GPS-Global Positioning Sys		X		
Holographic C² Sandbox		X		

The most important force quality indicators or attributes required in these decision systems or “Systems of Systems” are interoperability and fusion of multiple sources of information. Range and “packaging” will also prove important for SORE operations. These requirements are noted by previous authors of both *Spacecast 2020* and *New World Vistas*. Specifically,

The Global Surveillance, Reconnaissance, and Targeting System (GSRT) provides omni-sensorial collection, processing, and dissemination in real time. Creates virtual reality images of the area of interest and could be used at all levels of command to provide situation awareness, technical and intelligence information, and two-way command and control.²⁸

Similarly, an ultra precise, jam resistant Global Positioning System (GPS),²⁹ which would be an advancement over today’s GPS, could provide . . . increased accuracy on the order of centimeters, fusion with other sensor assets, enhanced on-board computational capabilities, and a high data rate transmitter using low power and spread spectrum technology. [The RE force member] would employ a system of coded signals to provide multi-level, fused information and selectable accuracy to deny capability to all but selected [or verifiable] users.³⁰ It should provide precise and absolute positioning and timing which has a 30 cm spatial accuracy and 1 nanosecond (Ns) timing accuracy.³¹

A Holographic C2 Sandbox is another potential decision aid for a commander “back at headquarters” or to the SORE “grunt” in the field. It would provide a complete picture of the battlefield by injecting information on a real-time basis. This system, like the GSRT system described above, requires image processing, holographic neural technology, and wide baseline interferometric synthetic aperture radar imaging technology.

Counter Systems

Table 11 displays the critical attributes needed in counterinformation or countermeasure systems designed solely for SORE or available to SORE. The matrix shows the relationship between the task, its “level of need,” the force quality or attribute needed to support the task, and its measure of merit.

Table 11

Counter Tasks, Force Qualities, and Measures of Merit Matrix

TASK	CRIT/DES/IDL			FORCE QUALITY	MEASURE OF MERIT
Counter		X		Transparency	Blends into 1st/2d wave worlds
Counter	X			Interoperability	With standard C ⁴ I systems
Counter	X			Fusion	Intel, surv, comm, weather, etc.
Counter		X		Portability	Under 1 lb.-unobtrusive
Counter		X		Range	Global and Local
Counter	X			Capacity	Giga/terabits/sec

Crit=Critical, Des=Desired, Idl=Ideal

As table 11 shows, the most critical attributes to counter adversary information exploitation attempts are interoperability, fusion, and capacity. The only countermeasure systems unique to SORE, as depicted in table 12, directly support PSYOP missions—the advanced broadcasting system and the holographic projector. The other systems are generic to all forces’ requirements and should be developed/sourced by collateral entities.

Table 12

Countermeasure Systems' Dependency Matrix

“COUNTERMEASURE” SYS	SORE Source	Non-SOF Source	SOF PS Source	Host-Entity Source
Advanced Broadcasting Systems	X		X	
Holographic Projector	X		X	
Direct Broadcast TV		X	X	X
SPM-Strategic Perception Mgt		X		
HPM		X	X	

Interoperability, capacity, and range are imperative to transmit large quantities of data to the target. For example, an advanced broadcasting system, which may be nothing more than a simple loudspeaker system but allows delivery from a standoff point or is capable of distributing leaflets with precision to its target audience, will require a wide “bandwidth” for execution. The same is true for the Holographic Projector³² which could communicate US objectives by projecting “holographic” images directly into the region of concern. A few of the underlying technologies associated with these systems are image processing, holographic neural technology, and wide baseline interferometric synthetic aperture radar imaging, as well as standard communications networks.

Dependencies or Counter Systems Provided by Non-SORE Sources

Direct Broadcast Television, a 100 channel, relatively cheap system (less than \$1000) today, should be capable of “information on demand” in 2025. It will be an inexpensive way to broadcast PSYOP messages to desired audiences. It is being researched and fielded by the commercial enterprises; therefore, off-the-shelf purchase of these types of systems is suggested.

Many types of information system weapons and electronic countermeasures will be devised by the various services. Two possibilities are

High Powered Microwave and High Power Laser Directed Energy Weapons. These speed of light weapons, with the full spectrum capability to deny, disrupt, degrade and or destroy,

will continue to evolve and may eventually replace most traditional, kinetic energy explosive driven weapons and self protection countermeasure systems.

However, there are five innovative technologies required for “energy frugal” directed energy weapons. Specifically, they are high, light weight optics, HPM antennas using thin membrane fabrication, high-power short-wavelength solid-state lasers, high average power phase conjugation, new approaches to adaptive optics and phased arrays of diode lasers.³³

Whether used in combination or in singular application, these technologies and their ensuing systems may prove invaluable for SORE countermeasure efforts, especially in collaboration with information warfare practices. Finally, we must remember the eloquence of the *New World Vistas* report in addressing the collaborative and defensive efforts. Specifically,

Defensive IW will be pursued by the commercial community because of the obvious effects that malicious mischief can have on commerce. The military problem is, however, likely to be different enough that some effort will be required. The commercial solutions should be monitored closely for possible application or technology breakthroughs.³⁴

One approach for SORE application may be to build a Strategic Perception Management system. Under this concept, new tools provided by the “Information Revolution” are so formidable that when they are employed to affect enemy perceptions, they could provide a war-winning, or at least war-detering capability.³⁵ This may be the ultimate countermeasure for the technologies developed to measure, enhance, compensate, or convince the friendly decision maker.

Sustain Systems

Sustenance of the individual will be crucial for SORE operations. A host of technological leaps and applications will suffice to meet these needs. The focus, however, must be to meet the organic essentials of the human system by providing the nutrition, water, power, and ammunition required. Table 13 provides the dependencies as they relate to development of the systems.

Table 13

Sustain Systems' Dependency Matrix

SUSTAIN SYSTEMS	SORE Source	Non-SOF Source	SOF PS Source	Host-Entity Source
“Chia pet”- Fast Food	X			
Portable Water Supplies	X	X		
Portable Power Generators		X		
Passive push Replenishment		X		

Before we can feed SORE force members, we must determine individual organic levels and nutritional needs. Then a lightweight and compact survival package can be devised and tailored for each force member. To accomplish this, we must pursue advances in food development such as biochemical-enhanced “hyper speed growth” seeds cultivated on portable substrates. Something similar to the “Chia Pet” concept, that is simple, fast, unobtrusive, and man-portable is needed to replenish SORE forces’ nutrients “while on the go.” The approach should seek to exploit chemically enhanced seeds, nuts, or grains which grow and produce “food” within a 24- to 72-hour period.

Refined metabolic rate screening, combined with nutritional-matching, will ensure enhanced performance during employment. A potential candidate is the HOMBRE concept. With this system, we may determine each SORE force member’s metabolic type, then selectively enhance their cognitive and physical performance through specific nutritional regimens.³⁶

A quick solution for water purification or collection may be to use absorbent receptacles to collect dew, obtaining small quantities of water for force sustainment in a dry environment. A long-term, more exotic source may be the manufacture of dry chemicals which, when combined, bond at the molecular level to produce water. An even more far-reaching approach is filtering and purifying body fluids to act as an interim water supply, should extreme conditions arise.

Several technologies must be pursued to provide portable, organic power sources. For example, methods to extract power from the hydrogen compounds in water sources could be adapted to SORE force needs, thus doubling the benefits of having the water.

Similarly, battery packs must be more compact, lighter, rechargeable, and retain longer life on a single charge. In that light, the potential exists to create technologies that exploit human movement and central or autonomic nervous system activity as low-grade energy sources.³⁷ Further, since SORE forces will spend a lot of time walking, this “energy” must be harnessed and exploited. For example, “boot chargers” located in the heels of a force member’s boots could be used to operate or recharge as the member performs his/her daily routines. These combinations may, in turn, be applied to battery charging to accommodate the need.

In the same vein, several energy technologies are projected which may provide alternative portable sources. They range from lightweight, solar panel collection systems, to ambient lunar light collection panels; to miniaturized power-generating factories on a single microchip.³⁸ The technological leaps made in solar power, as well as microscopic machines, should be investigated for SORE force application. Expedient replenishment and replacement solutions might be precision-guided delivery systems and energy weapon recharging via direct satellite link. In both cases, sensors will monitor inventory levels and track source supply points automatically and replenish as needed. The latter concept is a “passive-push” replenishment system similar to today’s Just-in-Time or Trickle Charge systems. This approach minimizes administrative communications that may compromise covert or clandestine units and optimizes use of limited replenishment assets.

Move or Transportation Systems

Any special transportation requirements needed by SORE forces will likely be provided by non-SORE resources. As table 14 indicates, non-SOF, Precision Strike SOF, and/or Host-Entity resources will fulfill our movement requirements.

Table 14

Move Systems' Dependency Matrix

“MOVE” SYSTEMS	SORE Source	Non-SOF Source	SOF PS Source	Host-Entity Source
Av Foreign Internal Defense		X		X
Exfiltration/Infiltration Systems		X	X	X
Strap-on/Strap-off for SO Acft		X	X	

While these new systems will be advantageous to SORE, none are SORE-unique. Hence, SORE forces will rely on application, access, and use of collaterally developed methods to meet their transport needs. Therefore, these systems are not described in this paper. The reader can refer to the *Precision Strike*, *Airlift and Spacelift* white papers for details.

Notes

¹ John L. Petersen, *Road to 2015, Profiles of the Future*, (Corte Madera, Calif.: Waite Group Press, 1994), 46.

² Ibid., 57.

³ Ibid.

⁴ Ibid., 58.

⁵ Ibid., 61.

⁶ Ibid.

⁷ Wiley, R., *Human Optimization of Metabolic and Behavioral Response (HOMBRE) Technology Initiatives Game '95*, Naval War College Compendium, 1995.

⁸ Ibid.

⁹ Ibid.

¹⁰ 2025 Concept, no., 200007, “Rehearsal for All Missions System,” 2025 Concepts Database (Maxwell AFB, Ala.: Air War College/2025, 1996).

- ¹¹ **2025** Concept, no., 900577, “Gumping Audio and Video Library,” **2025** Concepts Database (Maxwell AFB, Ala.: Air War College/**2025**, 1996).
- ¹² **2025** Concept, no., 900501, “Artificially Intelligent Word Processor,” **2025** Concepts Database (Maxwell AFB, Ala.: Air War College/**2025**, 1996).
- ¹³ **2025** Concept, no., 900263, “The All Seeing Warrior,” **2025** Concepts Database (Maxwell AFB, Ala.: Air War College/**2025**, 1996).
- ¹⁴ **2025** Concept, no., 900280, “Fly on the Wall,” **2025** Concepts Database (Maxwell AFB, Ala.: Air War College/**2025**, 1996).
- ¹⁵ **2025** Concept, no., 900341, “Robobugs,” **2025** Concepts Database (Maxwell AFB, Ala.: Air War College/**2025**, 1996).
- ¹⁶ **2025** Concept, no., 900340, “Universal Language Translator,” **2025** Concepts Database (Maxwell AFB, Ala.: Air War College/**2025**, 1996).
- ¹⁷ **2025** Concept, no. 900624, “Hand-held Translator,” Concept, no. 900560, “Portable Language Translator,” and Concept, no. 900607, “Universal Translator,” **2025** Concepts Database (Maxwell AFB, Ala.: Air War College/**2025**, 1996).
- ¹⁸ **2025** Concept, no., 900317, “Tactical Information Display Helmet,” **2025** Concepts Database (Maxwell AFB, Ala.: Air War College/**2025**, 1996).
- ¹⁹ Petersen , 190–193.
- ²⁰ USAF Scientific Advisory Board, *New World Vistas: Air and Space Power for the 21st Century*, summary volume (Washington, D.C.: USAF Scientific Advisory Board, 15 December 1995), 27.
- ²¹ Ibid.
- ²² Ibid.
- ²³ Ibid.
- ²⁴ See *New World Vistas Study* for complete definition.
- ²⁵ Ibid., 23.
- ²⁶ **2025** Concept, no., 900351, “Transatmospheric Reconnaissance Aircraft,” **2025** Concepts Database (Maxwell AFB, Ala.: Air War College/**2025**, 1996).
- ²⁷ *Warfighting Vision 2010, A Framework for Change*, 1 August 1995, Joint Warfighting Center, Doctrine Division, Fort Monroe, Va., 12.
- ²⁸ *Spacecast 2020, Air University into the Future, Operational Analysis*, Maxwell AFB, Ala.: Air University, 1994, 34.
- ²⁹ *New World Vistas*, summary volume, 10.
- ³⁰ *Spacecast 2020*, 35.
- ³¹ *New World Vistas*, summary volume, 25.
- ³² *Spacecast 2020*, 36.
- ³³ *New World Vistas*, summary volume, 60.
- ³⁴ Ibid., 10.
- ³⁵ Jeffrey Cooper, *Another View of Information Warfare, Conflict in the Information Age*, SAIC, 30.
- ³⁶ Wiley, Item 111-1.
- ³⁷ **2025** Concept, no., 900123, “Body Heat as a Low Grade Energy Source,” **2025** Concepts Data Base (Maxwell AFB, Ala.: Air War College/**2025**, 1996).
- ³⁸ Kaigham J. Gabriel, “Engineering Microscopic Machines,” *Scientific American*, September 1995, 118–121.

Appendix B

Definitions of Underlying Technologies

Central Processing Units on a Single Microchip where the power of 16 Cray YMP super computers will be manufactured for under \$100 on a single microchip that will contain about 1 billion transistors. These will be used to create micromechanical devices, micromachines, microrobots, microsensors, and be integrated with microelectronics devices on a “single chip.”¹

Condensed Charge Technology “produces small, tightly bound dense clusters of electron charge of enormous power relative to their size. Integrates spark, or more accurately micro-arc discharges, into, not out of, a system thereby taking advantage of the many beneficial properties inherent to the phenomenon. It can then be made, controlled, and used on command.”²

Data Fusion Technology whereby multivariate data from multiple sources are retrieved and processed as a single, unified entity. Fundamental to C², with Intel being a major component.³

Electromagnetic Communications. Development and production of a variety of telecommunications equipment used for electromagnetic transmission of information over any media. Analog or digital information ranging in bandwidth.⁴

High Performance Computing. Development of extremely high performance digital computers with vector and massive parallel processor architecture. Needed to process massive amounts of data in real time.⁵

Image Processing. A process that will acquire, transfer, analyze, and display real-time imagery for use in a variety of systems.⁶

Holographic Neural Technology. Software written in complex numbers (real and imaginary) using holographic principles and quantum theory, allowing information to be superimposed or enfolded by a convolution of complex vectors, requiring only one to three passes to map the desired information.⁷

Metal-oxide semiconductor is a microtransistor with nanometric dimensions.⁸

Molecular Nanotechnology. Building things from the bottom up. Starts with individual atoms and uses molecular-sized machines to put systems together in predetermined configurations.⁹

*Non-Binary Computing*¹⁰ where speed of data computing will be increased by magnitudes of order beyond today's current standards.

Virtual Reality. Holographic full-color, three-dimensional projection where the information can be digitized and transmitted to remote locations. Will enable a person to operate complex systems from remote locations or project themselves into an artificial environment.¹¹ For example, "picturephones may project the person on the other end of the line into the middle of your room as a 'light sculpture'."¹²

Wide Baseline Interferometric Synthetic Aperture Radar (SAR) Imaging. 3D dimensioning where images can contribute important data.¹³

Zero-point Energy is the process of taking energy out of the air and converting it directly into heat or electricity with no other by-products. Zero-point energy is the ambient energy left in space after all of the heat has been removed—absolute zero. Basically, it is taking energy out of the electromagnetic fluctuations in a vacuum.¹⁴

Notes

¹ John L. Petersen, *The Road to 2015, Profiles of the Future*, Corte Madera, Calif.: Waite Group Press, 1994, 29.

² *Ibid.*, 61.

³ *Spacecast 2020, Air University into the Future*, Maxwell AFB, Ala.: Air University Press, 1995, 56.

⁴ *Ibid.*

⁵ *Ibid.*, 57.

⁶ *Ibid.*

⁷ Petersen, 44.

⁸ *Ibid.*, 29.

⁹ *Ibid.*, 58.

¹⁰ **2025** Concept, no. 900357, “Micromechanical Devices,” **2025** Concepts Database (Maxwell AFB, Ala.: Air War College/**2025**, 1996).

¹¹ Petersen, 45.

¹² *Ibid.*, 62.

¹³ **2025** Concept, no. 200005, “Multiplatform Interferometry,” **2025** Concepts Database (Maxwell AFB, Ala.: Air War College/**2025**, 1996) and USAF Scientific Advisory Board, *New World Vistas: Air and Space Power for the 21st Century*, summary volume (Washington, D.C.: USAF Scientific Advisory Board, 15 December 1995), 43.

¹⁴ Petersen, 159.

Bibliography

ARTICLES/MAGAZINES

- Andre, David J. "The Art of War-Past, Present and Future" *Joint Forces Quarterly*, Autumn 1995.
- Builder, Carl H., "Doctrinal Frontiers" *Airpower Journal*, Winter 1995.
- Cooper, Jeffrey "Another View of Information Warfare, Conflict in the Information Age" SAIC, 30 August 1995.
- Dunlap, Charles J., Jr. "How We Lost the High-Tech War of 2007" *The Weekly Standard*, 29 January 1996.
- Jones, Jeffrey B., and Michael P., Mathews, "PSYOP and the Warfighting CINC" *Joint Force Quarterly*, Summer, 1995.
- Libicki, Martin Dr. "What Is Information Warfare" *Strategic Structures Course Book, Vol II*, Maxwell AFB, Ala.: Air Command And Staff College, 1996.
- Marshall, James P. "Near Real-Time Intelligence of the Tactical Battlefield," *Theater Air Campaign Studies Course Book*, (Maxwell AFB, Ala.: Air Command and Staff College, 1996.
- Scientific American, Key Technologies for the 21st Century* September 1995.
- Warden, John A. "The Enemy as a System" *Strategic Structures Course Book*, Maxwell AFB, Ala.: Air Command And Staff College, 1996.

Books

- The Chicago Manual of Style*. 14th ed. Chicago: The University of Chicago Press, 1993.
- College of Aerospace Doctrine, Research, and Education. *AU Press Author Guide*. Maxwell AFB, Ala.: Air University Press, March 1995.
- . *AU Press Style Guide for Writers & Editors*. Maxwell AFB, Ala.: Air University Press, December 1994.
- Hamel, Gary, and C. K. Prahalad, *Competing for the Future, Breakthrough Strategies for Seizing Control of Your Industry and Creating the Markets of Tomorrow* Boston, Mass.: Harvard Business School Press, 1994.
- Kennedy, Paul. *Preparing for the Twenty-First Century*, New York: Random House Publishing, 1993.
- Pasmore, William A. *Creating Strategic Change* New York; John Wiley and Sons Inc., 1994.
- Petersen, John L. *The Road to 2015, Profiles of the Future* Corte Madera, Calif.: Waite Group Press, 1994.
- Schwartz, Winn *Information Warfare—Chaos on the Electronic Superhighway* New York: Thunder's Mouth Press, 1994.
- Schwartz, Peter *The Art of the Long View* New York: Doubleday Dell, 1991.

Toffler, Alvin and Heidi *War and Anti-War, Making Sense of Global Chaos* New York: Warner Books, 1993.

Van Creveld, Martin *The Transformation of War* New York: Free Press, 1991.

Concepts—2025 and Technology Initiatives Game

2025 Concept No. 200005 “Multiplatform Interferometry” **2025** Concepts Database (Maxwell AFB, Ala.: Air War College/**2025**, 1996).

2025 Concept No. 200007 “Rehearsal for all Missions System” **2025** Concepts Database (Maxwell AFB, Ala.: Air War College/**2025**, 1996).

2025 Concept No. 900123 “Human Body Heat As a Low Grade Energy Source” **2025** Concepts Database (Maxwell AFB, Ala.: Air War College/**2025**, 1996).

2025 Concept No. 900263 “The All Seeing Warrior,” **2025** Concepts Database (Maxwell AFB, Ala.: Air War College/**2025**, 1996).

2025 Concept No. 900280 “Fly on the Wall,” **2025** Concepts Database (Maxwell AFB, Ala.: Air War College/**2025**, 1996).

2025 Concept No. 900317 “Tactical Information Display Helmet” **2025** Concepts Database (Maxwell AFB, Ala.: Air War College/**2025**, 1996).

2025 Concept No. 900340 “Universal Language Translator” **2025** Concepts Database (Maxwell AFB, Ala.: Air War College/**2025**, 1996).

2025 Concept No. 900341 “Robobugs, ” **2025** Concepts Database (Maxwell AFB, Ala.: Air War College/**2025**, 1996).

2025 Concept No. 900351 “Transatmospheric Reconnaissance Aircraft (TRA),” **2025** Concepts Data Base, (Maxwell AFB, Ala.: Air War College/**2025**, 1996).

2025 Concept No. 900357 “Micromechanical Devices” **2025** Concepts Database (Maxwell AFB, Ala.: Air War College/**2025**, 1996)(Proprietary).

2025 Concept No. 900460 “Portable Language Translators,“ **2025** Concepts Database (Maxwell AFB, Ala.: Air War College/**2025**, 1996).

2025 Concept No., 900501, “Artificially Intelligent Word Processor,“ **2025** Concepts Database (Maxwell AFB, Ala.: Air War College/**2025**, 1996).

2025 Concept No. 900562 “A Selective Knowledge Pill,“ **2025** Concepts Database (Maxwell AFB, Ala.: Air War College/**2025**, 1996).

2025 Concept No. 900577 “Gumping Audio and Video Library,” **2025** Concepts Database (Maxwell AFB, Ala.: Air War College/**2025**, 1996).

2025 Concept No. 900624 “Hand-held Translator” **2025** Concepts Database (Maxwell AFB, Ala.: Air War College/**2025**, 1996).

2025 Concept No. 900772 “Aviation Foreign Internal Defense,” **2025** Concepts Database (Maxwell AFB, Ala.: Air War College/**2025**, 1996).

Wiley, R. *Human Optimization of Metabolic and Behavioral Response (HOMBRE)*, Technology Initiatives Game ‘95, Naval War College Compendium, 1995.

Publication/Reports

Air Force Doctrine Document 1, *Air Force Basic Doctrine* (draft), 15 August 1995.

Allotey, Sam, et al. *Planning and Execution of Conflict Termination* ACSC Research Project 95-05-053, May 1995.

Cornerstones of Information Warfare Department of the Air Force, 1995.

Goldstein, Frank L. “*Psychological Operations—Principles and Case Studies*” Air University Press, Maxwell AFB, Ala.: 1995.

Hammond, Grant T *The New “PPBS”: Pork, Politics, Budgets and Strategy and the Active and Reserve Components in the US Military*, National Security Strategy Chair, Air War College, Maxwell AFB, Ala., Draft Paper for Presentation to the American Political Science Association Annual Meeting, 31 August 1995.

JFACC Primer Second Edition Government Printing Office, February 1994.

Joint Publication 1.0. *Joint Warfare of the United States Armed Forces* January 1995.

Joint Publication 3-05. *Doctrine for Joint Special Operations* October 1992.

Joint Publication 3-05.3. *Joint Special Operations Operational Procedures* August 1993.

Joint Publication 3-07.1. *Joint Tactics, Techniques, and Procedures for Foreign Internal Defense* December 1993.

Joint Staff Memorandum to the SECDEF, 19 December 1995. Subject: *Volume 4 (Future Capabilities), Joint Planning Document for FY 1998 through FY 2003* (JPD FY98-03), Enclosure.

Spacecast 2020, Air University into the Future Maxwell AFB, Ala.: Air University Press, 1995.

Taylor, Charles W. *Alternative World Scenarios for a New World of Nations* Strategic Studies Institute, US Army War College, 1993.

USAF Scientific Advisory Board. *New World Vistas: Air and Space Power for the 21st Century*, Summary Volume. Washington, D.C.: USAF Scientific Advisory Board, 15 December 1995.

———. *New World Vistas: Air and Space Power for the 21st Century*. Unpublished draft, the Information Applications Volume. 15 December 1995.

United States Special Operations Command Publication 1 *Special Operations in Peace and War*, January 1996.

United States Special Operations Command *The United States Special Operations Forces Posture Statement* Government Printing Office, 1994.

Warfighting Vision 2010, A Framework for Change, Joint Warfighting Center, Doctrine Division, Fort Monroe, Va., 1 August 1995

Speeches/Lectures

Cable, Larry Dr. University of North Carolina, Wilmington Air War College Lecture, 31 January 1996

Cognitive Engineering for Information Dominance 2025 Briefing, Lt Col Martin L. Fracker, Human Resources Directorate, Armstrong Laboratories, Human Systems Center, Brooks AFB, Tex. 16 October 1995.

Collins, John CRS Report to Congress *Special Operations Forces, An Assessment 1986–1993*, July 1993.

Downing, Gen Wayne A., USA, USCINCSOC *Senate Armed Services Committee Congressional Testimony* March 1995.

Medical Implications in the Future Dr James Kvach, 2025 Briefing, 31 January 1996.
Shelton, Gen Hugh M., USA, USCINCSOC Air War College Lecture, 25 March 1996.

**The DIM MAK Response of Special Operations
Forces to the World of 2025:**

“Zero Tolerance/Zero Error”



A Research Paper
Presented To

Air Force *2025*

by

COL (Sel) James A. Cerniglia (USA)

LtCol Duane R. Schattle (USMC)

Maj Dave B. Carr

Maj Teresa L. Dicks

Maj Edward M. Griffin

Maj James M. Maxwell

August 1996

Disclaimer

2025 is a study designed to comply with a directive from the chief of staff of the Air Force to examine the concepts, capabilities, and technologies the United States will require to remain the dominant air and space force in the future. Presented on 17 June 1996, this report was produced in the Department of Defense school environment of academic freedom and in the interest of advancing concepts related to national defense. The views expressed in this report are those of the authors and do not reflect the official policy or position of the United States Air Force, Department of Defense, or the United States government.

This report contains fictional representations of future situations/scenarios. Any similarities to real people or events, other than those specifically cited, are unintentional and are for purposes of illustration only.

This publication has been reviewed by security and policy review authorities, is unclassified, and is cleared for public release.

Contents

<i>Chapter</i>		<i>Page</i>
	Disclaimer	ii
	Illustrations.....	iv
	Tables.....	iv
	Preface.....	v
	Executive Summary	vi
1	Introduction	1
	Assumptions.....	2
2	Capabilities Required and Concept of Operations.....	5
	Weapons of Mass Destruction Neutralization	6
	High-Value Target Engagement.....	8
	High-Value Asset Recovery.....	8
	Ether Targeting	9
3	Enabling Capabilities and Supporting Technologies.....	12
	Communications.....	13
	Worldwide Communications.....	15
	Clandestine Operations	17
	Communication Security	19
	Data Fusion.....	20
	Mobility	21
	Stealth Airlifter.....	23
	Low Earth Orbiter.....	24
	Extraction Rockets	25
	Destruction/Neutralization.....	27
	WMD Neutralization (Targeting Items)	28
	HVT Engagement (Targeting Items)	30
	HVT Engagement (Targeting People).....	31
	HVA Recovery (Targeting the System Process).....	32
	Ether Targeting (Ether)	34
4	Conclusion and Investigation Recommendations.....	38
	Communications.....	39
	Mobility	40
	Destruction/Neutralization	41
<i>Appendix</i>		<i>Page</i>
A	Scenario #1	43

<i>Appendix</i>	<i>Page</i>
B Scenario #2	45
C Scenario #3	47
D Supporting Technologies Abstracts.....	50
Bibliography.....	56

Illustrations

<i>Figure</i>	<i>Page</i>
2-1. SOF Precision Operations	6
2-2. “Buddy” Jump.....	10
3-1. System of Systems (Modified for Precision Operations in 2025).....	14
3-2. MC-X	23
3-3. MA-X	27
3-4. Future Targeting Helmet Design	33

Tables

<i>Table</i>	<i>Page</i>
1. Relationship of Systems to SOF Missions (Mobility)	22
2. Relationship of Systems to SOF Missions (Destruction/Neutralization)	28

Preface

Special operations missions are both enduring and compelling in nature. In the past, special operations forces (SOF) led the way for conventional forces by applying cutting-edge innovative technology and tactics. This Department of Defense (DOD) force multiplier effectively leverages minimum capital investment into military capability equally effective in first, second, and third wave environments.

The focus of this paper is to provide new ideas for employing SOF in the world which might exist in 2025. The methodology used allowed team members to produce new concepts of operation, employing innovative technologies against missions which will likely exist within the study time frame.

After defining 2025 SOF offensive missions, the study group selected the top three capabilities needed to perform these missions. The three capabilities selected were required in all four SOF offensive missions and the missions could not be performed if any one of the three capabilities were missing. Numerous capabilities are required to successfully accomplish the SOF tasks, but the team restricted research to the top three priority enabling capabilities (EC).

The paper takes the reader through a mission validation process which provides justification for the envisioned four SOF offensive missions. Assumptions are used to project these missions into the future. The paper's authors used alternate futures to form the boundaries for concept of operation development and technology solutions. The mission requirements, satisfied by the three ECs, resulted in three sets of unique capability requirements. Proposed technological solutions which might exist in 2025 fulfill requirements of the ECs. The result is a futurist view of SOF offensive missions and how these missions might be accomplished.

Executive Summary

The United States enters the Twenty-first Century as the world's lone superpower. The alternate futures of 2025 propose different scenarios whereby the US face different competitors.¹ Col Jeffrey Barnett, in *Future War*, details two types of competitors the US will likely face in the next century—peer and niche.² A peer competitor will have technologies and weapons comparable to the US while a niche competitor will possess limited numbers of new weapons and a considerable mix of current weapons. The goals of these competitors are to control or challenge vital US, national interests. These potential competitors and the threat they pose imply that the dangers cited in the current national military strategy will still be relevant in 2025. These dangers are regional instability, proliferation of weapons of mass destruction (WMD), dangers to democracy and reform, and transnational conflicts.³

The authors believe special operations forces precision operations (PO) will offer senior commanders alternatives conventional forces cannot provide. SOF give the commander in 2025 a highly motivated and trained team able to respond to missions characterized by a narrow window of opportunity, low requirement for repetition, and a high-consequence-of-failure.

What do the authors envision for role special operations forces in 2025? The authors define special operations missions and the concept of operations (CONOPS) for the missions, develop capabilities required to support these missions, and identify enabling technologies.

Key special operations missions will be weapons of mass destruction (WMD) neutralization, high-value target (HVT) engagement, high-value asset (HVA) recovery, and ether targeting. The WMD neutralization mission is designed to destroy or neutralize a WMD device in a target location. The HVT engagement mission will cause either a permanent or temporary effect to a person or item to achieve strategic effects. HVA recovery operations are conducted to bring sensitive items or American citizens back under US control. Ether targeting missions expose or exploit vulnerabilities in the electron medium used by either peer or niche competitors. Special operations ether targeting requires rapid and stealthy insertion and extraction

of individuals. Long loiter in the target area significantly increases probability of detection and mission compromise.⁴

Key capabilities will be communications, mobility, and destruction/neutralization. These three capabilities link global awareness (communication); global reach (mobility); global power (destruction/neutralization); the selected special operations missions; and the system elements that comprise these missions. The capability of communications not only details the communications requirements of future SOF precision operations missions but addresses the need for mission knowledge, fusion, integration, and analysis of the specialized information necessary for precision operations missions. The capability of mobility addresses the problems facing today's special operations planner such as vertical lift, global range, and high speed of current special operations lift aircraft. The capability of destruction/neutralization looks at the weapons or devices required in these missions. The paper explores entire spectrum of weapons from nonlethal to lethal for potential application to tailor the weapon for the specific mission. This exploration includes the investigation of potential technical "weapons" kits for ether targeting missions. The system elements targeted in each of these missions are a person, item, process, or ether.

All of these missions possess unique mobility, communications, and destruction challenges. Research into the requirements for these missions revealed potential technology advances to solve today's challenges. The most promising technological solutions are in propulsion and powerplants for SO aircraft such as hypersonic aircraft; design and development of a stealth airlifter; extraction rockets; smaller, integrated, and more durable communications equipment; and tunable lethality weapons.

Notes

¹ Engelbrecht, Col Joseph A. Jr., et al. *Alternate Futures for 2025: Security Planning to Avoid Surprise.* Draft of White Paper for 2025 study.

² Jeffrey R. Barnett, *Future War* (Maxwell AFB: Air University Press, 1996), xviii.

³ President of the United States, *A National Security Strategy of Engagement and Enlargement* (Washington D.C.: The White House, 1996), 1.

⁴ Political sensitivity and limited opportunity special operations competency in third wave warfare. While security, policy, doctrine, and technology for information dominance will reside in conventional or civilian domains, Special Operations will be the primary tool selected for eyes on target, special reconnaissance verification, and exploiting extremely limited windows of opportunity. This white paper focuses exclusively on the special operations slice of information dominance and tools required to enable this unique capability.

Chapter 1

Introduction

Victory smiles upon those who anticipate the changes in the character of war, not upon those who want to adapt themselves after the change occurs.

—Gulio Douchet
The Command of the Air

Dim Mak (or *Dim Hsueh*) is a once forbidden technique in Chinese kung fu. The literal translation is “The Poison Hand” (or “Touch of Death”). *Dim Mak*’s technique teaches to strike a vital point, with a certain force, at a certain time, and kill.

The mastery of this art requires long hours of hard training with patience, perseverance, and study. It masterfully focuses a precise strike, accounting for both position and direction, with a variable degree of power, depending on the point of impact, at a target. It also requires near-perfect knowledge of the enemy system, and is highly dependent on both the weather and the time of day for a successful strike. The *Dim Mak* strike provides for many levels of lethality, from paralysis to death in several hundred days.

The attributes of *Dim Mak* are mirrored in those of special operations forces in 2025. These forces will be highly dedicated, motivated, specially trained, and uniquely equipped. They will operate throughout the war and peace spectrum, but their forte will lay in missions characterized by political sensitivity, limited opportunity, and the use of unorthodox approaches. In 2025, the SOF precision operation’s capability will demand a continuous stand-ready posture on a global watch and, that a moment’s notice, the ability, to mobilize, deploy, locate, identify, and engage specific targets. Using varying levels of effect or lethality, SOF can then withdraw and redeploy without a trace.

In deciding how to apply SOF precision operations capabilities against a particular target, the target is viewed as a system whose components can be categorized into one of the following: people, items (or hardware), processes, and ether. With the ongoing information revolution and growing dependence on information technologies, ether is becoming a lucrative environment that SOF precision operations can target. The decision of what component to target within a system must be analyzed by thoroughly understanding the desired end-state, accurately evaluating system component vulnerability, and knowing the risk to precision operations forces.

In SOF, mission failure is not an option. In the true spirit and capability of *Dim Mak*, SOF offensive operations will provide the US with an uncanny ability to defend national interests and achieve national security strategy objectives.

Assumptions

To postulate special operations force's missions, the authors used a limited number of assumptions that they generated after considering the 2025 alternate futures.¹ The assumptions, together with the alternate futures, allowed the study group to validate the need for SOF to perform four specific missions no other US forces would be capable of performing.

Competitors will still exist to challenge the US in 2025. Many of these competitors will have the same high technology systems as the US. Some states will lack the sophistication inherent in US systems and will lag behind US advances in microtechnologies, computers, electronics, aerospace technologies, miniaturization, and robotics. The nature of the global state environment will range from poor and impoverished states to third wave, high-technology states.

Nonstate actors with the power to threaten US interests will exist in 2025. These actors may include the multinational corporations, terrorist organizations, drug cartels, criminal organizations, and possibly energy or resource coalitions. Nonstate actors will be less sensitive to political influence and economic pressure will have very little effect on their organization or operation. Consequently, military power may be the only element of national power which can control these actors. State and nonstate actors challenging US interests

may emerge with an expanded technological edge over the US. These actors may appear slowly and cautiously or may come on the global scene unexpectedly.

Terrorism will be an increasing activity performed by powerless political groups. These organizations may reach a level of sophistication and begin using some forms of WMD to accomplish what the gun, rifle, and bomb did not in the Twenty century. Americans will present lucrative targets to these organizations using terrorism as US business people travel the world tapping into foreign markets, exploiting natural resources, and searching for cheap labor to assemble goods. State and nonstate actors not capable of pursuing political goals through military means may use hostage taking as a means of gaining world attention and achieving limited political objectives. The US must be prepared for this eventuality.

A weapon of mass destruction is any weapon having the capability of killing at a level of magnitude much greater than conventional weapons. Today, WMD include nuclear devices and biological and chemical weapons, and in 2025 some forms of ether attack. These weapons will likely continue to proliferate; by 2025, or even well before, many of today's third world countries will be at least capable of building primitive WMD devices. Both state and nonstate actors will likely possess these weapons in 2025. Terrorists armed with these devices may extract ransom after demonstrating use and threatening future use. Irrational state actors possessing WMD and delivery capability pose the gravest threat to US interests in 2025.

The US must be able to attack selected targets which are not vulnerable to precision-guided munitions conventional explosives. These targets may need servicing with tunable destructive weapons which limit or eliminate collateral damage. These high-value targets could be people, facilities, or electronic databases. Enemy targets, valuable to the US, will be protected by passive and active means. Deep underground bunkers and mobile targets will present the greatest challenge to US targeteers.

The information age will present many challenges to states with economies based on this technology. The spectrum of electronic medium will service both military and private sectors. The US must have the ability to react to threats in this medium in much the same manner we react to violence perpetrated by criminals and terrorists. The world of 2025 will have certain countries which have established electronic means of performing all functions performed today using paper— such as money, contracts, military orders, and designs for buildings or facilities. Protecting and penetrating this medium will be a US requirement.

Lastly, technology will not solve all tactical military problems. The need to have a human on the ground will still exist in 2025 to observe, decide, and react. Humans in the loop required for missions having the highest risk of failure and highest consequence of failure when the level of success guarantee nears 100 percent. Humans will still be needed to perform these zero-failure missions. They will add the flexibility needed to react to the unexpected and succeed.

Notes

¹ Engelbrecht, Col Joseph A. Jr., et. al. “Alternate Futures for **2025**: Security Planning to Avoid Surprise.” Draft of White Paper for **2025** study.

Chapter 2

Capabilities Required and Concept of Operations

It takes farsightedness and guts to build an armed force that will only be called to fight in, say, a decade. One has to guess, as best one can, what resources will be available, what kind of opponent the force will be called on to face, and what kind of environment they will have to operate in. Those fundamental questions settled, the time comes to decide how to best meet the challenges ahead.

— Martin van Creveld
The Transformation of War

SOF in 2025, like today, will focus on high-risk, highly specialized, high-consequence-of-failure missions; and will require nearly 100 percent guarantee of success, ‘Zero Tolerance / Zero Error’. Political sensitivity is so significant that only a tailored organization with special skills, training, and equipment can accomplish these missions and assure success. The nature of the mission, size of the force required, and skills needed will dictate use of small, extremely mobile, highly trained, quick to react teams of special operators. The frequency of the requirement to use these forces, the specialized nature of their employment, the target, risk, and consequence of failure levels will require employment of these unconventional forces. Figure 2-1 provides a graphic representation of the mission area SOF precision operations will operate in. There will continue to be some missions, where the consequence of failure and mission risk are so high that a military option may not exist.

Where are SOF Precision Operations?

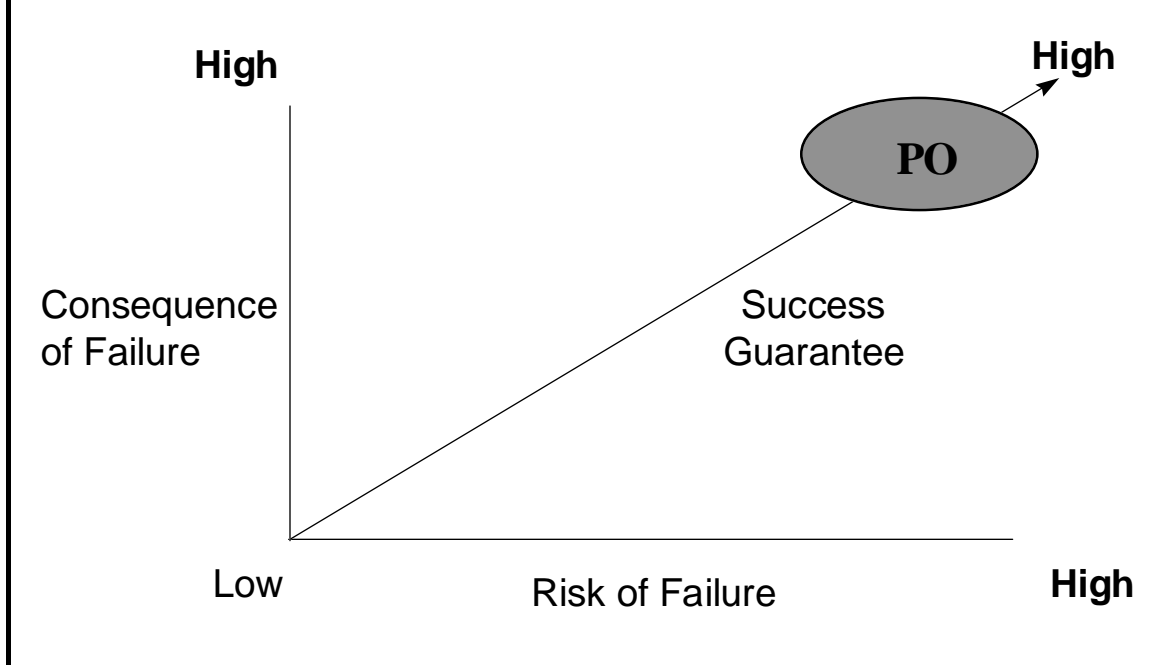

Figure 2-1. SOF Precision Operations

Special operations in 2025 will continue to employ the five near timeless core competencies of “unconventional training and equipment, political sensitivity, unorthodox approaches, limited opportunity, and the need for specialized intelligence”¹ to varying degrees and will be very mission dependent. These core competencies coalesce and beget the required capabilities to meet four primary mission types plausible for any possible future world of 2025: WMD neutralization, HVT engagement, HVA recovery, and ether targeting. Each of these missions will require special teams of specially equipped forces.

Weapons of Mass Destruction Neutralization

Weapons of mass destruction will continue as a reality well into the twenty-first Century and as a major security concern for the US. Nations not possessing these weapons may seek the security this weapon

provides. Nonstate actors and terrorists may successfully hold states hostage and achieve objectives by using these weapons once and then making demands with the threat of continued use. Irrational state actors electing to use WMD as preemptive tools may draw other states possessing these weapons into Armageddon.

These weapons will be secured through passive and active means. Deep underground bunkers and mobile launchers will make destruction of these devices difficult. Air attacks may require precision designation by SOF, with a much greater accuracy than today's capability. Several target sets may be too precariously positioned to permit self-designation by airborne platforms. It is additionally possible that precision-guided munitions and air attack, even by uninhabited aerial vehicles (UAVs), may be futile against some deeply buried storage sites which are protected by early warning devices and layers of air defense weapons. Enemy ground forces will be positioned to react to intrusion and thwart direct attack by conventional means. WMD storage and launch sites will be located in distant, isolated areas which naturally make intrusion and penetration difficult. Gathering intelligence on these sites will be challenging due to cover, security, and location of these sites. Mobile launchers will be moved from site to site for protection from attack. States threatening use will have forces at high alert to protect these high-value items.

In 2025, WMD will include nuclear weapons, poor man's nukes (biological and chemical weapons), and a new "deadly" WMD—"Information Bombs" (IB).² Demographic and political changes described in the 2025 alternate futures unfortunately provide uncommonly fertile ground for Alvin Toffler's first, second, and third wave entities to execute both coherent and sporadic direct actions on the United States and its allies and friends. The purpose of these actions by aggressor nations, terrorists, organized crime cartels, or even single individuals will be to "level" the distribution of wealth and resources, power redistribution, or simple political agendas.

WMD neutralization will require locating, analyzing, penetrating, and eliminating the weapon. Neutralization may include destruction at the site, transporting to friendly control, or neutralizing critical components. Penetrating the facility will require high-fidelity, accurate, real-time intelligence. Strategic and tactical mobility to move SOF teams and neutralization equipment is also required. Eliminating security forces will require a variety of weapons-- weapons which can stun, immobilize, or kill.

High-Value Target Engagement

HVT engagement seeks to obtain a wide range of options, from temporarily disabling to total destruction. Designated high-value targets would have strategic significance affecting the highest levels of an organization (i.e., multinational corporation) or state during peacetime or war. These operations could be conducted against individuals as HVT engagement operations are tunable for a variety of results, from lethal to nonlethal. High-value targets may include C⁴I nodes, protected power generation sites, or underground command centers to facilities in close proximity to sensitive noncombatant sites such as hospitals, religious places, or schools. Both the nature of the target and the location will dictate precision operations, eliminating or minimizing collateral damage.

SOF will face many of the same challenges presented in WMD neutralization missions. Strategic and tactical mobility to and from the site is required. Some of these operations may be conducted remotely with essentially a reconnaissance team waiting for the opportunity to strike or designate the target. In those instances where a facility or deep underground facility must be penetrated, the same capabilities inherent in the WMD neutralization mission apply. SOF will still be faced with eliminating security, penetrating the target site, and applying tunable devices which manipulate the target. These devices will limit damage to what is required to achieve desired results. Tunable weapons will permit SOF operators to achieve results without producing unwanted world criticism. Precision-neutralization operations conducted against high-value targets require extreme precision, timing, coordination, and offer the added value of deniability.

High-Value Asset Recovery

HVA recovery operations return sensitive items, people, or things to US control. HVA recovery operations may also return allied citizens to their country and friendly control. Additionally, in 2025, HVAs may include financial databases, corporate trade secrets, or proprietary knowledge in Bill Gates' brain. These missions are the most difficult and must be conducted as quickly as possible. Time wasted formulating plans, preparing forces, and deciding options allows enemy forces to gain positional advantages. Precision-operations forces must safeguard sensitive items and hostages. Facilities will offer the enemy protection

from direct assault. The surgical nature of these operations require sorting out enemy personnel from hostages and separating enemy personnel from sensitive items without damage to the item.

SOF will require high-fidelity, accurate real-time intelligence to penetrate these facilities successfully. Neutralizing enemy security forces without harming hostages or damaging sensitive items is of paramount importance. Tunable weapons will permit separating enemy from friendly personnel. Strategic and tactical mobility is required to move SOF from base locations to target sites. Speed, stealth, and surprise are essential requirements to successful operations. Arriving undetected at the site permits securing HVAs before the enemy can react. Transportation of team members and hostages or sensitive equipment requires both tactical and strategic mobility.

Hostile governments and organizations will pose a significant threat to the safety of American citizens. Nations, organizations, and/or individuals not possessing the adequate power to confront the US may resort to kidnapping and stealing to attain political goals.

Ether Targeting

Despite giant strides in information dominance over the intervening years, disparity between US laws and customs and those of peer or competitor entities provide fertile ground for hostile activities to contravene US vital interests. These “unfriendlies” develop special talents to circumvent both prevailing law as they become the modern-day cyber pirates.³ They readily steal, lift, or appropriate commercial trade secrets, software, or the individual who possesses the knowledge. The market is king. US dependence on information systems, knowledge or “wisdom,” and commerce will make the impact of a logic bomb or a multimorphing power virus⁴ devastating.



Source: "Parachute 740-2 MMS," *Armada International*, October/November 1994, 51.

Figure 2-2. "Buddy" Jump

Drop Zone®, a movie starring Gary Bussey, covered this exact scenario where the target set was a Drug Enforcement Agency (DEA) database of undercover agents. Bussey, an ex-SEAL, employed precise high-altitude low-opening (HALO) jump techniques to land on the DEA headquarters in restricted airspace of Washington, D. C. He had already snatched a computer geek and taught him to jump under extreme conditions. Figure 2-2 shows a picture of this type of parachuting. With a small, carefully crafted team, Bussey, and team, tapped into the DEA database, downloaded the pertinent information on deep cover agents, and transferred the information to cartel chiefs for a small fee.⁵

As previously discussed, current policy for off-the-shelf contracts and information management acquisition to decrease government expenditures set the stage for easy access to critical economic and security information. Today, the manipulation and stealing of knowledge is a reality in commercial, political, and military arenas.⁶ To know and control (ether *Dim Mak*) the knowledge of one's adversary is the key to success. Sun Tzu wrote "foreknowledge must be obtained...all war is based on deception."⁷ Special operations forces must determine when the ether problem is deception and when it is real. When directed

within the ether or cyber environment, special operations will neutralize or destroy target sets outside the boundaries of conventional means.

One commercial “system” that may be a hot prospect is the idea of intellectual property.⁸ Once targeted by an adversary or “snatched,” special operations would employ HVA recovery techniques for the property’s safe return. Preempting this scenario would require sophisticated ether identification, monitoring and “destruction” techniques. Our adversaries are investing heavily in information manipulation. Once in this arena, special operations forces will require an “info” kitbag.

Notes

¹ United States Special Operations Command, *1994 United States Special Operations Forces Posture Statement*, 3–4. GPO, Washington, D.C., 1994.

² **2025** Concept No. 900328, “Information Bomb.” 2025 concepts database (Maxwell AFB, Ala.: Air War College/**2025**, 1996); See **2025** Counterinformation White Paper for further research on MMPVs and information bomb impacts on US vital interests.

³ Microsoft Network News, “US, Japan in Piracy Battle,” Internet address: <http://www.msn.com>, 10 February 1996, 1845 CST, states the “music piracy dispute could become a test case for the new intellectual property rules of the 116 member WTO. . . . The US argues that under the trade-related aspects of intellectual property rights (TRIPS) agreement of the Uruguay Round world trade accord, Japan must extend copyright protection to foreign records dating back 50 years. The Geneva-based WTO covers intellectual property rights, unlike the General Agreement on Tariffs and Trade (GATT).”

⁴ Wieslaw gornicki, “In the Shadow of the L-Bomb,” *Warsaw Przegląd Społeczny Dzisiaj*, (FBIS Translated text—Polish officer discusses Infowar), 1 November 1995, 48–60; **2025** Counterinformation White Paper.

⁵ *Drop Zone*®, Paramount Pictures, 1994.

⁶ Microsoft Network News.

⁷ Samuel B. Griffith, *Sun Tzu, The Art of War*, Translated and with an Introduction by Samuel B. Griffith (Oxford, England: Oxford University Press, 1971), 106 and 145.

⁸ Danton K. Mak, “Intellectual Property Checklist for Ventures in the 90’s.” On-line, Internet, 20 March 1996, available from <http://www.calcom.com/sm/articles/ipcheck.>, 1.

Chapter 3

Enabling Capabilities and Supporting Technologies

This chapter performs two functions: (1) it lists and describes the requirements for each of the three capabilities introduced as essential to mission success in the four SOF missions; and (2) provides the reader with, when possible, technology solutions which satisfy each enabling capability requirement. Where research falls short or technology solutions are not provided, the team has provided possible alternatives or technology transmutations which might exist in the time frame of the study. The authors have carefully considered concepts of operation where they recommended specific technologies. The researcher has pointed out the potential shortcoming associated with using technologies which have a potential tactical shortcoming associated with its use, and when possible, has made recommendations to minimize the drawback.

The three essential enabling capabilities needed to successfully perform the SOF offensive missions of 2025 are communications, mobility, and destruction/neutralization. This chapter discusses each capability, lists and, where necessary, defines performance requirements, and provides technological solutions. The chapter discusses solutions subsequent to the introduction of each performance requirement. Requirement parameters are expressed using the extreme end of the requirement criteria (most demanding criteria). For example, the range to a target may vary with the mission, but this chapter uses the most demanding range to describe the performance criteria.

Communications

SOF precision operations communication requirements go significantly beyond the team members ability to talk to each other. Communications in the context of this paper involves the quest and distribution of mission knowledge in a timely and useful manner to guarantee mission success. Mission knowledge involves intelligence (preknowledge of one's adversary or threat), real-time remote sensing, human-enhanced sensing, and finally electronic information processing, distribution, and storage systems. As noted in Alan D. Campen's book, *The First Information War*, "because of the strategies of deception, maneuver, and speed employed by coalition forces in Desert Storm, *knowledge* came to rival weapons and tactics in importance."¹ The SOF precision operations teams of the future will depend on the ability to manage and dominate mission knowledge. Communications via voice, sight, touch, external sensors' inputs, and even thought will afford SOF precision operations teams of 2025 the edge to gain and maintain mission knowledge dominance over any adversary.

Several unique factors drive communication requirements for the precision operations mission. SOF communication drivers currently include the requirement for worldwide, real-time, multinet linking capability within a precision operations team, and to other command, control, communications, computer, and information (C⁴I) nodes. Based on the authors' assumptions, in 2025 there will be a need for communication systems featuring clandestine and covert modes of operation; multilevel security; and the capability to integrate, fuse, and manage numerous sources of data and information." These future sources may include voice, video, sensor's inputs, navigational information, and identification friend or foe (IFF) data.

Today, this all-encompassing communication capability, "system of systems," conceived by the former Vice Chairman of the Joint Chiefs of Staff, Adm William A. Owens, USN, is under initial development for US DOD needs.² New technologies in computer capabilities, digital data storage, processing, data fusion capabilities, and global positioning supported this concept. This system of systems brings together battle space awareness, increased precision engagement capability, and enhanced C⁴I to provide the future SOF precision operations mission the needed advantage to achieve mission objectives.

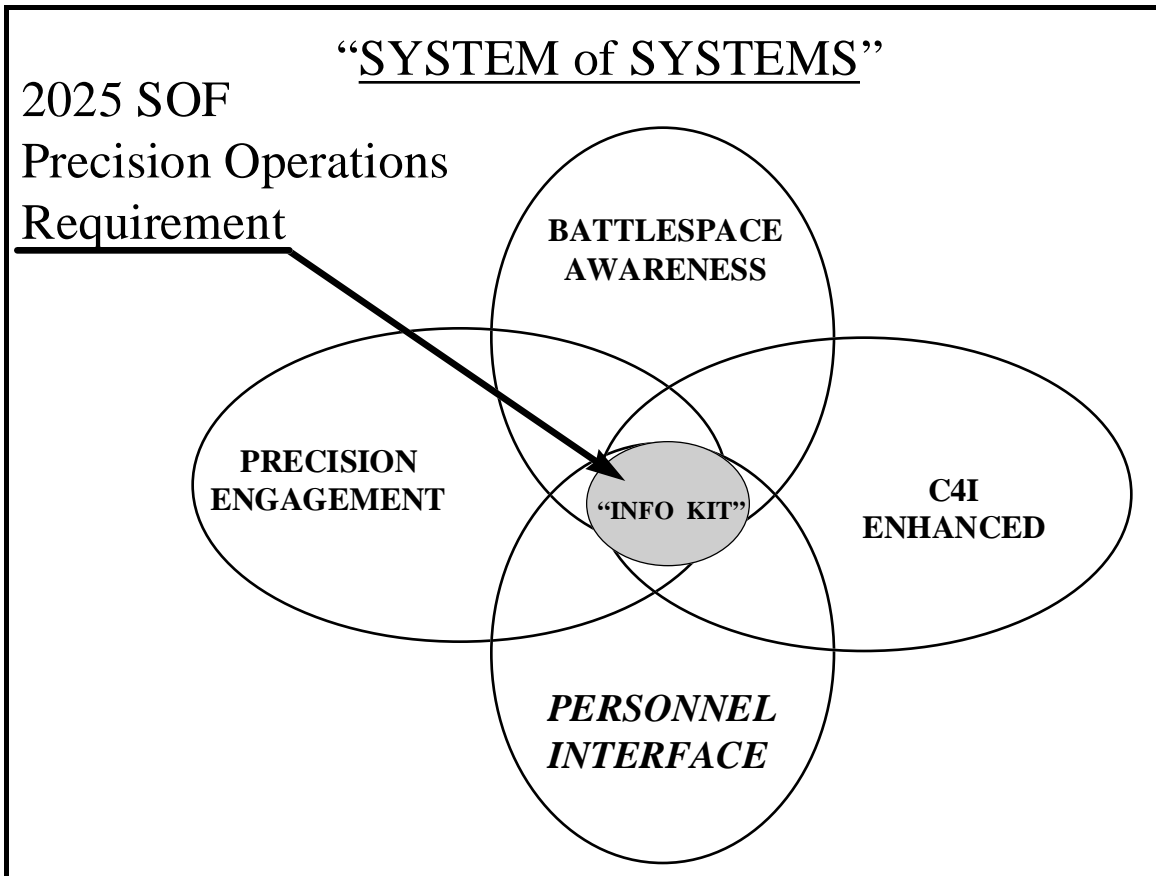

Figure 3-1. System of Systems (Modified for Precision Operations in 2025)

Figure 3-1, a derivative of Admiral Owens’s initial idea, shows an added region to the system of systems called personnel interface.³ A critical requirement for PO in the 2025 time frame, the personnel interface section of this system of systems identifies the unique human-interfacing requirements for precision operations. The unique personnel interface requirements are primarily driven by needs for covert operations and security during precision operations missions. Nondetectable equipment and signals will be a necessity for precision operations in 2025 especially as the threats’ capability to detect and counter SOF missions will increase. Admiral Owens’s system of systems must be compatible with SOF precision operations needs, and this personnel interface will ensure the requirements for these communications are identified and addressed. The term *info-kit*, also shown in figure 3-1, is a proposed name for this future system and will be used throughout this section of the SOF precision operations white paper.

The consequences of mission failure are extreme for both the SOF team members and potentially the United States. Therefore, the need for extremely reliable, durable, simple, and redundant communications is essential. Affordability will also be a driving factor for any future communication systems, and will make unilateral SOF development of precision-operations communication equipment unlikely and dependency on commercial communication markets a necessity. The rapid pace of technological developments makes the ability to develop, procure, and bring to operational status communication equipment before it becomes obsolete or vulnerable to threat countermeasures difficult and too costly for expected SOF budgets. Numerous commercial applications are being developing for secure local, regional, and global communications capabilities. The military and SOF can take advantage of this commercial development its procure required communication capability, their avoiding the initial developmental costs.

The ability to effectively communicate has always been a key component to any successful military operation. Sun Tzu identified the importance of communications during military operations when he wrote, “. . . drums and bells . . . flags and banners . . . must be used for troop communication in battle.” Then, now, and in 2025, communications capabilities will provide SOF precision operations the necessary flexibility to achieve concentration of force, coordinated and undetected mobility, speed, precision, synergy of effort, unity of command, surprise, and ultimately the achievement of mission objectives. Communications truly is a force multiplier and one of the founding pillars supporting the fundamental principles of war.

Worldwide Communications

SOF precision operations requirements for worldwide communications will generally fall into three categories, local, theater, and global. Each category may require unique equipment for several reasons including technology limitations, diversity, and reduced complexity allowing tailoring for specific mission needs. Ideally, an all-in-one device, an “info-kit,” could offer the required communication capabilities needed by SOF in 2025. Whatever technologies exist in the future, the info-kit must provide seamless communications with other DOD communication systems and provide significant interoperability with older communications equipment and systems that will be prevalent throughout the world.

Local communications would SOF precision operations team members links between each other and with other C⁴I nodes. These SOF teams must be capable of communicating over relatively short distances up

to several kilometers without detection. Additionally, SOF requires the ability to use multiple nets or channels simultaneously allowing precision-operations team sub-elements discrete interconnected communications. Direct communication with other military organizations and noncooperatives would also be a necessary feature. The term non-cooperative identifies organizations or systems not willingly or knowingly communicating with the SOF precision operations team. Supporting airpower requirements for the local precision operations communication may include the use of prepositioned uninhabited aerial vehicles. UAVs may provide communication relays between local precision operations teams, other military forces in the local area, or relays to other theater and global C⁴I networks. These flying relay stations would be deployed singularly or in constellations as necessary for each mission and be withdrawn at mission completion.⁴

The next two categories for SOF precision operations communications are theater and global. These categories would entail the ability to communicate with a diverse array of command and control nodes and mission support systems such as remote and nationally controlled sensors and transportation assets. During a recent lecture at the Air Force's Air Command and Staff College (ACSC), Col John A. Warden III (Ret.) provided the potential of future C⁴I

During the initial strikes on Baghdad in January 1991, part of the air campaign planning staff sat around their TV sets in Washington DC watching for indications on CNN *Headline News* about the attack success on one of their first target priorities that night, Baghdad's electrical power grid. Shortly after 1900 EST (0300 in Baghdad), a CNN correspondent team reported live from Baghdad indicated the city lights started going out.⁵

Colonel Warden additionally described that some Scud missile-launch warnings were being provided to in-theater target areas via relays through US based command and control nodes.

Similar to the two events described above, a diverse real-time global communication capability would allow for critical mission information and decision making to take place anywhere in the chain of command. Decisions could be made or mission results could be viewed in real-time at National Command Authorities (NCA), commander in chief (CINC), or joint force commander (JFC) levels, if necessary. The sensitivity of future precision operations missions may not permit a final mission decision until the SOF team is engaged at the mission objective or target site. For example, the neutralization of a rogue nuclear device may include several options-- device removal, device destruction, or device manipulation to give the appearance of operability though inoperable. The final decision concerning disposition of the device may not be realized until actual events develop during execution and on-scene mission environmental factors are evaluated.

Global communications will allow final mission decisions at the regional CINC, JFC, or NCA level. In this scenario, a worldwide communication capability has provided additional flexibility to the mission by allowing the mission execution decision to be made at the highest level if needed, and at a latest possible moment. Other solutions, such as ongoing negotiations, would have an extended chance to resolve the crisis.

Supporting technologies for regional and global communications include the use of high-altitude UAVs and spaced-based satellite communications relay and processing systems similar to the advanced military satellite communications (MILSATCOM) concept offering significant increase in capability of today's MILSATCOM systems.⁶ The advanced MILSATCOM will offer global, secure, personalized, high-data rate communication capability. Another Air Force 2025 concept applicable for worldwide communications suggests the capability of faster-than-light, infinite distance communications via "quantum polarization shift of shared photons."⁷ This capability would revolutionize communication and mission knowledge dominance as we know it today. Finally, the technology to transmit, receive, and process very high data-flow rates, on the order of terra-bits per second, is a future requirement for all worldwide communications capabilities.

Clandestine Operations

The requirement for PS teams to operate covertly drives the need for any future SOF communications to operate with low probability of intercept or detection (LPI/LPD). Two general approaches to this solution are identified. First, to develop a communication system with signals that are undetectable by the threat. This can be accomplished in a number of ways, including the use of very low-power transmitters, but this may limit equipment effective range. A smart info-kit system of the future may allow for real-time adaptive power modulation techniques that use only the minimum required power to accomplish the data transmission. Another approach to making precision operations communications undetectable would be to develop a system that operates outside the normal energy patterns for typical or expected communication bandwidths. Today, a majority of military communications occur in the very high frequency (VHF) bandwidth, generally in the area of 30 to 500 MHz. Undoubtedly, future military communication systems will expand to cover a much wider spectrum. Currently, developments in the 1.5 GHz bandwidth is ongoing with the potential to expand significantly higher or lower.⁸ Whatever communication systems exist in 2025, the ability to operate

on the fringes or outside the normal energy bandwidths could provide the needed surreptitiousness inherent in precision operations.

The second approach to LPI/LPD communications for precision operations teams of the future would be to make such equipment and associated signals blend into the surrounding environment. Currently, nearly every country in the world today is experiencing a communication evolution. Some estimates predict that by the year 2000, up to 80 percent of worldwide telecommunications will be wireless.⁹ Mobile telecommunications are expanding rapidly throughout the world, especially in many developing countries where land phone and data lines do not exist. Cellular-based systems for voice and data communications using microwave radio networks are becoming common throughout the world. They afford a developing nation the “quick connect” to a diverse local and worldwide communication network. Additionally future developments in wireless technologies will provide the popular local area network (LAN) systems, prevalent throughout the industrial world of today, a wireless capability.¹⁰ Over the next several decades the atmosphere will be “buzzing” with numerous signals from these developing wireless capabilities. The ability for SOF precision operations communications to blend into this noisy environment may be less of a challenge than trying to avoid detection and provide another means for covert communications.

Any attempt to lower detection levels through LPI/LPD communications in the future will most likely require a combination of techniques. No one solution will fit all scenarios or requirements for precision operations’ stealthy communication. The design of these future communication systems must be adaptive and capable of operations in many future world environments.

The next concern for SOF precision operations with regard to covert communications deals with the visibility or recognition of the communication equipment. Potential precision operations scenarios may require the SOF team to blend into the local populous and surrounding environments. Personnel hauling a communication kit with antennas, a cumbersome battery pack, and headsets will be very conspicuous and therefore a lower probability of success should be expected. The capability to miniaturize and hide communication equipment is essential.

Under the charge of the US Army Communications Electronic Command (CECOM), the 21st Century Land Warrior Program is developing and field testing an individual soldier computer/radio kit.¹¹ This kit is expected to weigh approximately two pounds and strap onto the soldier of the twenty-first century providing

voice, data, and imagery to each soldier and throughout the chain of command. This system is expected to greatly enhance the overall effectiveness of Army combatant units. Though two pounds of equipment does not sound cumbersome by today's standard, the packaging of this equipment will not meet precision-operations team requirements. Team communications equipment will need to be light, mobile, and unrecognizable as a communication system. Miniaturization should allow communication and supporting equipment to be imbedded into mission apparel or uniforms. Interfacing with the equipment could be through implanted ear and throat pieces. Contact lenses could be the display screens of tomorrow affording normal fields of view. These lenses could display necessary visual data for mission tasking and additionally act as sensors for data collection or enhancing as night vision goggles do today. Controls for such equipment must also be unrecognizable and activated through gestures, voice, touch, or even thought control. Whatever communication technologies develop in the future, the precision operations team will most likely need equipment that is unrecognizable as such for mission accomplishment.

Advances in electrical and mechanical microminiaturization technologies will be needed to package the info-kit of 2025 into a usable precision operations system. Additionally, communication equipment power supplies often make up a large percentage of the total system volume and weight. Power supplies for the info-kit of 2025 will need to be inconspicuous, durable, and highly mobile. An Air Force 2025 concept suggests the use of human body heat as a potential energy source.¹²

Communication Security

Secure communications will be required for SOF precision operations missions not only within the precision operations team but also with other related activities. These missions may proceed or occur simultaneously with other combatant operations. Being able to communicate securely with other operations will be crucial. The need for multilevel encryption capability will be required in the future and is currently being developed by CECOM in their digital integrated laboratories.¹³ Currently, separate networks are needed for different levels of classified communication. To be compatible and capable of communicating with different operations apart from the precision operations team, a multilevel security unit that allows the commingling of data with different security classifications will be needed. Interoperability will be needed

not only with other DOD communication equipment but with other secure nets to include those operated by other nation's military forces and noncooperative systems described earlier.

The info-kit of 2025 may afford an adversary an tremendous advantage should it fall into his hands. Therefore, operation of such a system must be protected and could be easily accomplished by deoxyribonucleic acid (DNA) tagging specific equipment to individuals or groups of individuals. When the DNA tag is lost so is the info-kits capability. Additionally, data storage areas within the info-kit would be self-destroying after a preset time of lost user DNA signature.

Data Fusion

The next aspect to discuss for SOF precision operations communications involves the capability of future systems to integrate, process, and provide numerous sources of information to the precision operations team member. Admiral Owens's system of systems now in the conceptual design and initial technology demonstration phase will evolve into an operational system in the early part of the Twenty-first century. In the time frame of 2025, this system will undoubtedly be more capable and functional for SOF precision operations requirements. Today, new technologies are allowing the fusing of multiple communication and information data into one multipurpose device. Advances in computer software, data storage, and processing speed capabilities along with microminiaturization advances will allow for the combination and integration of many data sources for precision operations. Numerous informational data source (NIDS) processing capability will greatly enhance the future SOF operations. A part of the info-kit, NIDS processing would combine real-time voice, video, external sensor data, global position location and navigation, IFF information, and any other system deemed necessary in 2025.

External or remote sensor inputs to the NIDS systems could range from those at the national asset level such as spaced-based multispectrum satellites, theater-level UAV inputs, to local preposition or on-body sensors such as the Advanced Research Project Agency (ARPA) concept being developed to detect toxic substances. ARPA is working on a "neuron-based biosensor that can feature nerve cells growing directly on microchips capable of sensing toxic substances."¹⁴ Air Force 2025 concepts such as "I Can Smell You," and "Fly on the Wall" are ideas for local sensors that can be propositioned for a PO mission and provide vital real-time mission data directly to a NIDS type-system.¹⁵

Other subcomponents to the NIDS system could include an individual monitoring system (IMS) capable of evaluating, and if necessary, administering immediate life-sustaining medication to the system user. For HVA recovery missions where hostage rescue is the objective, the NIDS could incorporate another subcomponent called Medical Emergency Reaction Instructions or MERIT guidance for self-administered emergency medical treatment to injured hostages or other SOF team members. When activated, the MERIT system would help remotely diagnose and instruct the necessary medical treatments, similar to the medical tricorder seen in Paramount's *Star Trek*® TV and movie series. Through the development and use of artificial intelligence computer capability, the NIDS system would provide the user with the right information at the right time to enhance situational awareness, sustain life, and guarantee mission success.

Communication requirements for SOF precision operations in 2025 will involve much more than just the ability to talk to team members. Technology is affording the future precision operations team member the capacity to achieve knowledge-space-dominance needed for 2025 tasks and missions. Admiral Owens's system of systems will likely be in its third or fourth technology evolution by 2025. Combining many of the emerging and developing other technologies will provide situational awareness to SOF precision operations, guaranteeing mission success. By identifying SOF precision operations communication requirements now, the evolution of the system of systems, will be the info-kit in 2025. This capability for SOF to achieve knowledge-space-dominance over an adversary will ensure the US is capable of achieving its national objectives in 2025.

Mobility

Mobility is one of the three enabling capabilities for special operations in 2025. It plays a key role in each of the missions envisioned; --WMD neutralization, HVA recovery, HVT engagement, and other targeting. This section details systems attributes and required technological advances to support these systems. Mobility, as defined for this study, is the system or systems that provide SOF insertion and extraction capability for a designated mission. This study will not address any additional mobility requirements for the teams after initial insertion, only the strategic and tactical systems for insertion and extraction. The team has identified three potential mobility systems satisfying special operations 2025

mobility requirements, a stealth airlifter, low earth orbiter (LEO), and exfiltration rockets. The mobility systems directly affect the enemy processes in the sense that the insertion and extraction location, method, and route planning will impact enemy command and control efforts to counter the mission. Additionally, mobility has a direct impact within all facets of the HVA recovery mission due to the payload requirements for the people or things to be recovered. The enemy will dictate target locations; therefore, SOF must possess an infinite range of insertion and extraction capabilities. This will enable special operations teams to operate throughout the enemy system processes to conduct WMD neutralization, HVT engagement, HVA recovery, and ether targeting missions. Though mobility requirements exist across the full spectrum of SOF missions, table 1 illustrates the most critical aspects (shaded areas) between the SOF missions and enemy system elements with relation to their mobility requirements. (i.e., a critical SOF mobility focus for HVA recovery is on personnel and/or human characteristics)

Table 1

Relationship of Systems to SOF Missions (Mobility)

	People	Item	Process	Ether
WMD Neutralize			Critical	
HVT Engagement			Critical	
HVA Recovery	Critical	Critical	Critical	
Ether Targeting				

Current special operations lift platforms will not survive third and fourth wave competitors in 2025. Emerging technologies can modify and enhance existing platforms increasing their performance, but to increase the probability of mission success, a new special operations aircraft is needed. To obtain vertical lift capability in current lift platforms, a large trade-off in speed, payload capabilities, and range is accepted. Analysis reveals that by 2025 this need not be the case because of technological advances in areas of lift platforms, powerplant and propulsion systems, and aircraft rotorblade improvements.

Stealth Airlifter

A primary lift system to accomplish this could be a stealth airlifter.¹⁶ A stealth airlifter is needed because surprise is critical to success in SOF precision operations. Primary attributes that need to be incorporated into the stealth airlifter are low observability, high speed, long range, global reach, increased payload, reliability, and durability. This new airlifter should also possess vertical take-off and landing (VTOL), armament, and an array of emission support sensors. Experts estimate that a special operations stealth airlifter could be fielded in adequate numbers with these capabilities in 20 years.¹⁷ An artist's conception of a potential special operations stealth airlifter, is the MC-X (fig. 3.2), based on a current study undertaken by the USAF to be completed in 1997. The primary focus of the study is infrared (IR) and radar cross section, and powerplant and propulsion systems for airlifters.¹⁸



Source: ©McDonnell Douglas, “Commando Spirit” Concept Photo.

Figure 3-2. MC-X

A value added feature might be to incorporate a pilotless function to the stealth airlifter. This feature would reduce the number of personnel at risk and allow for a smaller craft, thus reducing the radar cross section of the platform. This feature is expanded from a concept in *New World Vistas*, “Aircraft and Propulsion” volume, depicting an unmanned fighter-type aircraft.¹⁹ This platform could be adapted to house a special operations team in the payload bay for insertion. The precision navigation and targeting capabilities onboard offer the JFC an option he does not now possess.

Another lift platform offering promise is a 2025 concept suggesting a modular medium lift aircraft.²⁰ This aircraft will employ low-observable technology, large cargo capacity, internal engines, and possess a 6,000 nautical mile unrefueled range. A benefit of this concept is the platform can be manufactured in the modular level and have several different models with comparable characteristics: airlifter, tanker, global range strike, and the special operations version. This concept saves time and eliminates the requirement to invest precious research and development dollars to develop a purely special operations lift platform.

Technological advances also offer promise in powerplant and propulsion systems. National Aeronautics and Space Administration (NASA), working in conjunction with aircraft manufacturers, has invested heavily in aircraft engine technology.²¹ One effort having a direct military application is a Mach 4 civil transport with reduced nitrogen oxides emissions, and quieter engines. An additional area offering promise is the use of magnetic-based rotation of ionized air as a substitute for physical turbine blades.²² Powerplant experts in the *New World Vistas* predict that modern adaptive control methods to engines may yield improvements of 10 percent in the near future.²³ If successful, these technological improvements could give the NCA or a JFC the ability to quickly react to trouble spots with a highly trained team.

A final area of technological solutions to aircraft problems could be the use of eclectic materials in the construction of aircraft rotor blades. Eclectic materials must be rigid enough to withstand effects of flight but be malleable enough to enable changes in shape during operation. Use of these materials will permit airfoils to adjust shape during flight—improving lift, reducing drag, and resulting in increased performance.²⁴ Retrofitting existing aircraft with this technology will deliver an increase in performance potentially eliminating a need to design and develop a new aircraft.

Low Earth Orbiter

A second potential lift system for SOF in 2025 could be a Low Earth Orbiter (LEO). This platform would be able to deliver the two-to-four-man teams anywhere in the world with a precision landing. The LEO gives the JFC the ability to respond quicker than airlift platforms; however, thermal reentry signatures detectable by competitor threat detection systems must be overcome.

Technological advances in hypersonic vehicles research and study has increased the potential of this platform for special operations use. A promising vehicle in planning would fly at hypersonic speeds and be

able to deliver a payload in 10 minutes.²⁵ The team would be housed in the payload compartment and released for a precision landing at the desired location. While this system is primarily designed as a weapon, the payload could be designed to house the special operations team with its associated equipment. Precision delivery of the payload such as a circular error probable (CEP) of under 100 feet, is vital to this system. Special operations missions often entail night insertion and the teams must be able to begin their mission quickly after arrival. Dispersed teams needing to regroup or identify their exact location run the risk of compromising mission success. To achieve this level of accuracy the aerial delivery system (ADS) must continue to be improved. Advances in parachute, guided parafoil, and deployable wing systems offer promise in improving the ADS capability.²⁶ Integrating these advancements with improved Global Positioning System (GPS) and onboard navigation systems, and digital ground mapping will enable payload delivery with pinpoint accuracy. It is estimated that reusable launch vehicles, if developed in conjunction with NASA, could be available in 10 years using rocket propulsion and twenty five years using airbreathing propulsion.²⁷ A great deal of investment in fuels, propulsion, ceramics, and other technologies must be undertaken to make this a reality.

Additional hypersonic platforms in research at this time are rapid response/global reach aircraft system and space launch/support system.²⁸ The rapid response/global reach aircraft system is projected to fly at speeds greater than Mach 8 with global reach. The space launch/support system proposes a reusable launch vehicle (RLV) that could deliver a payload in orbit on short notice and return to base. If payload pods could be produced, the teams could be inserted from space from this vehicle. This concept would emulate the delivery profile of the troops in Robert Heinlein's science fiction novel *Starship Troopers*.²⁹ In this novel, military forces are loaded into capsules to be ejected from the spaceship. Once through the atmosphere, parachutes are employed to brake the descent until landing.

Extraction Rockets

A solution to the vertical lift extraction problem may exist in the extraction rocket. The SOF team has taken an idea from the *New World Vistas* and used it for extraction, not delivery.³⁰ This system would be inserted with the special operations team, be easy to set up and launch from field conditions, and have a payload capacity large enough for the team plus extra cargo. If necessary, the rockets could be hidden with

chameleon camouflage during mission execution and then used when needed.³¹ The extraction payload could be a WMD device or a HVA item. Use of this system will allow a team and payload to quickly exit the target location. This is critical for special operations, since the longer the team remains in the mission area, the greater the chance they may be captured or killed.

Another option for extraction could be a jet-pack device the team member would strap on their back. This device would transport the member to a safe haven for extraction by airlift or to loiter for an aerial recovery.

The extraction rocket would possess the following attributes: speeds in excess of Mach 1; air refuelable; long range; payload capacity large enough for a two-to-four-man team and a WMD device or HVA item; high durability; and precision delivery. An additional possibility for the extraction rocket would be to launch the team into a low orbit and the team would be recovered in space. This would eliminate the long-range and precision delivery requirements. The extraction rocket would boost the crew into space and await the arrival of an RLV to return the team to earth.

The jet pack would need to lift at least 500 pounds and transport the member up to 100NM. This would enable the special operations team to depart the target area and deploy to a safe haven for extraction. An alternative would be a deployable balloon connected to a cable to allow for aerial recovery of the member. Incorporated in the jet pack would be a emission-control sensor suite to reduce the signature of the member as he flies. Additional features could be a jet-pack suit the member would wear, which incorporates low-observable technology, is armored, and has a programmable navigation system. These features would allow the member to climb into the suit, program the navigation system, and sit back as he is delivered to the desired location. This would be an especially attractive feature if the member is injured and unable to pilot the jet pack himself or if the HVA to be extracted can not operate the controls. The propulsion system must be very quiet to avoid detection but still provide high speed to allow the team to quickly exit the target area.

Technological advances offer promise to solve many of the challenges facing future SOF planners. The trade-offs required for vertical lift in speed, range, and payload, and other critical requirements such as secrecy, security, long range, and speed can be solved by technology. Specifically, advances in stealth and propulsion and powerplant systems will allow the development of stealth airlifters and hypersonic aircraft dedicated to the SO mission.

Destruction/Neutralization



Source: ©McDonnell Douglas, “Commando Dagger” Concept Photo.

Figure 3-3. MA-X

As in the past, special operations forces in 2025 will be required to apply force to accomplish national strategic objectives. In the future, such an offensive application of force will be categorized into two types of engagement: destruction and neutralization. Each type of engagement will also house several levels of lethality. As is the case today, Twenty-first century capability must include the ability to conduct such engagement with a high degree of certainty with minimal risk of compromise. However, unlike today, 2025 requirements will include the necessity to operate not only within all three of Toffler’s waves of global social development, but possibly within a new wave yet to be projected.³²

Table 2 graphically depicts that selected SOF precision operations missions in 2025 will have a requirement to destroy or neutralize, with varying degrees of lethality, an enemy system’s parts. Though requirements will exist across the mission spectrum, for SOF in 2025, emphasis on the five system elements, shaded and marked as critical, provide a nice cross-section of capabilities.

Table 2

Relationship of Systems to SOF Missions (Destruction/Neutralization)

	People	Item	Process	Ether
WMD Neutralize		Critical		
HVT Manipulate	Critical	Critical		
HVA Recovery			Critical	
Ether Targeting				Critical

WMD Neutralization (Targeting Items)

WMD resources require the host government provide the best available security or protection and control. Specially trained and specifically focused forces are needed to successfully engage within this arena. special operations forces will require an in-depth knowledge base and high-tech equipment to effectively target this threat.

It is not feasible to have all special operations team members be combinations of nuclear physicists, biochemical professors, computer science specialists, munitions disposal experts, and special operations specialists. 2025 technology will allow teams to carry with them this level of expertise. Within 30 years virtual systems will become less cumbersome, more miniaturized, more concealable, as well as more capable. The capability to wear virtual sunglasses or contact lenses will be commonplace, very similar to technology creatively displayed in William Shatner’s futurist novel and film series *Tek War®*.³³ Special operations will require that this technology develop further into a seamless two-way heads-up display system with a direct link, to the source experts located elsewhere provide the appropriate technical data and procedures to perform the neutralization task.

Nuclear weapons will remain a formidable resource within a government’s WMD arsenal but biological and chemical weapons will be easy to produce and afford, and will provide the most difficult challenge. WMD capability is presently measured categorically by payload, speed, and range but in the future, this measure will be more appropriately quantified by controlled distance, measurable effectiveness,

and loiter time (linger time and half-life). If SOF are to be successful in neutralizing the WMD threat, they must be capable of operating with complete control of these measurable variations.

To adequately neutralize a WMD, on-site special operations forces will be required to either physically destroy the resource, render the destructive element unusable, render the delivery system unusable, or limit the effectiveness of the destructive element. Physical destruction of the resource or delivery systems, poses no additional requirements on SOF than any other engagement of a HVT. These requirements will be developed and discussed later in the HVT engagement section. However, if the neutralization of the threat requires hands-on manipulation of the system, then several other requirements will exist.

SOF precision operations equipment must possess the capability to encompass and quarantine the WMD system and apply a technology to accelerate its decay, while maintaining the outward appearance and weapons system functional integrity. This, of course, secures SOF from discovery, and the antagonist will be operating under the false pretense of a whole-system WMD capability. Any technology that could operate from outside the delivery system housing, perform the decay, and never require direct tampering, would be the optimum.

Surgically removing the agent container mechanism from its weapons system housing provides the simplest form of extraction but depend on knowledge of the system. More crude systems may provide more difficult scenarios where friendly exposure is highly probable. Future development of the immune warrior, may make the risk of addressing this type of threat more acceptable.³⁴ It has been stated that, “by the year 2000, 15 percent to 20 percent blood doping will be proven to provide up to 25 percent enhancement of a soldier’s performance in a variety of environments.”³⁵ Taking that next step in human manipulation as common practice, by 2025 near by 100 percent protection to selective agents should be a reality.

Even if selective immunity for precision-operations team personnel neared 100 percent, the creation of a miniaturized, self-contained, translucent biosphere which will hermetically wrap as a flexible bubble around the weapon system, to protect the operations environment is necessary. Included within the bubble will be tools to neutralize the weapon through dismantling, injection, or exposure of the core to a chemical or biological antiagent. Sun simulators or other light-spectrum decayers can be applied from outside.

A final requirement of SOF within the WMD realm, which leans towards a precision operation, will be to either insert a WMD into an enemy’s arsenal for activation or utilize an indigenous weapon and create

controlled accident scenario for the enemy to deal with. This will require the finest remote operations capability available for activation, so as not injure special operations forces. This technology should also include a selfdestructing system to avoid any discovery of tampering after the fact.

HVT Engagement (Targeting Items)

Precision operations revolve around providing precision access to difficult high-value target sets. Special operations engagement of these HVTs can take many forms, but the two to be discussed presently are within a designation role and a sniper role. These two roles promote distance from the target and nondetectability. These, of course, do not relieve SOF from the possible requirement to get dirty in a target area planting next generation explosives, with varying levels of destruction, on-site. However, future deceptive technologies such as chameleon camouflage and deceptive holographic imaging would assist SOF in nondetectability.³⁶ Of course, these technologies would not become a mission show-stopper, because special operations members in 2025 will continue to be highly versed in the art of concealment and evasion, and always will fall back on their naked-man skills. Additionally, a special operations designation team requires the capability to designate a target, but not be actively tied to a designation system. The capability is needed to place an undetectable emitter on a target from a distance, which emits continuously (or with a minor decaying rate) within a spectrum received by the guided or homing weapons of 2025.

The tactical designation ranges for present-day laser systems provide a respectable standoff distance from the target. In the future, SOF would still, depending on the mission parameters, appreciate that separation capability for illumination. Beam emissions need to be modified by 2025 to allow selfemitting beam riders to follow the designation stream and attach themselves to the target, similar to a particle beam without the impacting force.

Expanding on a paint tag ID system, a technique could be derived to develop a form of clear paint which maintains a phosphorescent capability in the electrooptical spectrum, which remains in visible to the naked eye and has a decay rate.³⁷ Additional options for pinpoint designation would be to optimize nanotechnology and develop a ROBOBUG, a fly on the wall, or some form of nanotech emitter to proceed or be placed on a target's desired mean point of impact (DMPI) awaiting signal capture by an air system with an

adequate weapons payload.³⁸ These guided weapons-- either missile, bomb, or direct beam-- must all have the capability to home in on the emission signal.

HVT Engagement (Targeting People)

Some scenarios will not allow for the convenience of outside weapons systems to provide the form of kill. The special operations sniper team must also possess the capability to properly identify (ID) the target, designate the target (if needed for internal systems), and provide the appropriate kill mechanism to manipulate the target. The term kill implies the completeness or finality of the engagement action, with varying levels of lethality, and does not imply the literal definition of death.

The Hollywood movie, *Runaway*®, with Tom Selleck provides an interesting form of projectile for development.³⁹ It is fired from a hand-held weapon, resembling a gun, but houses homing missiles with an individual DNA signature applied. Fired within the sensor range of the target, the missile goes active. The missiles could also contain varying levels of solid or liquid explosive. Of course, the movie targeted humans, but this system could be tied to any of the other designators already discussed and applied to targeting items.

Star Trek the Next Generation®, episode 157, called “The Vengeance Factor,” showed an interesting form of targeting people which may a SOF precision operations tool for 2025. The story involves a planet with a history of clan wars, and one clan developed a bio-virus that would only affect a certain clan of people. The developing clan was not directly affected, but could carry the virus, nearly undetected within their own bloodstream. By merely a touch to anyone of the enemy clan, can be death.⁴⁰ The possibility of a SOF precision operations team, being able to infiltrate into an enemy target area, apply a predetermined or tunable level of lethality to enemy personnel simply by touch, would minimize the need for additional support equipment and weapons-- thus, allowing the forces to blend into the cultural environment.

In all precision situations, the question of level of destruction is very important. Weapons systems either carried in by SOF to perform the destructive task or an external application targeted via special operations designation must have the capability to be controlled and/or varied in theater or via communications enroute. Focused blasts, yield variations, penetration with time-delay fuzing, genetic homing, and many others will give the SOF specialists the on-the-spot targeting capability for a given

situation. Development of a universal explosive, which by appropriate shaping and form of detonation, may provide for many different styles or/explosions with varying levels of destruction “Doing the right amount of damage, to the right thing, at the right time.”

HVA Recovery (Targeting the System Process)

Within the high-value asset recovery mission, only two overlying capabilities exist due to the inherent possibility of human-to-human confrontation-- identification of friend or Foe and Self-Protection. Technologies in 2025 will operate in the nanosecond regime between functions, leading to a quicker output to SOF for decision making. A special operations team should have the capability to walk into a roomful of individuals, and within a split-second neutralize all the bandits, sort all the bogeys (presenting appropriate decision making data to all precision operations team members), and exclude all the friendlies. Primary use for this capability would be in hostage rescue.

To provide this level of coverage requires advances in two areas, first the sensory/display area and then the fire control/weapons system. The sensory array could be tuned for target ID via DNA sensing, or possibly a form of pheromone sensing like that of pre - covert target marking, or as simple as those individuals with weapons are bad and all others require further forms of interrogate.⁴¹ These sensory inputs could then be filtered and combined with other team-gathered information, near instantaneously, and displayed within the visor of an ultimate warrior targeting helmet or a modified tactical information display helmet (fig. 3-4).⁴² Of course, the sensory/targeting system must operate in all light conditions and weather environments. The targeting data then is instantly fed to a hand-held slaved weapons system which will appropriately target the captors.

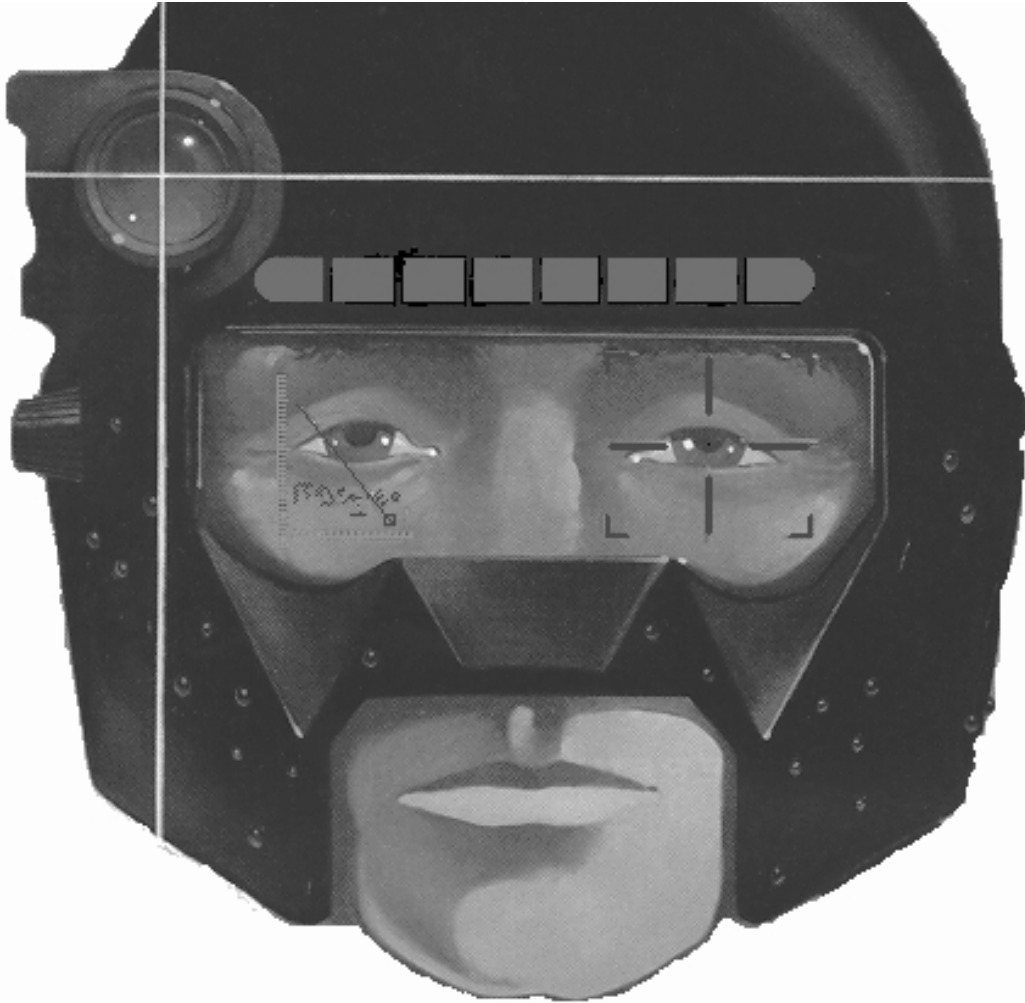

Source: ©Litton, “Litton Night Vision” GSA Direct Advertisement, *Armed Forces Journal International* (July 1995), 12.

Figure 3-4. Future Targeting Helmet Design

As with these offensive improvements, the defense requires equal development. The need exists to sport a self-protection field which repels all forms of forceful attack and photo-reactively counters all biological and chemical weapons. The most impressive futuristic body armor which may have merit within the next 30 years was displayed in the Hollywood movie *Dune*⁴³. This system provided a form of overpressure envelopment-force field garb which would repel reactively any fast-moving projectile, while still allowing for any slow-movement action such as touching and picking up items to continue normally.

Additionally, any form of calmativ agent that could be employed prior to engagement limiting the amount of resistance, such as an amiability agent or delayed action agent, and possibly providing a passive, nonconfrontational extraction, would be welcomely employed by SOF.⁴⁴

Ether Targeting (Ether)

Sting sings, “if you want to keep something precious, you gotta lock it up and throw away the key.”⁴⁵ Information experts appear to nod sagaciously at this theory for securing databases. This may not work. While most invasive information dominance procedures can be done remotely, in some cases, SOF employment will be driven by an eyes-on-target as special reconnaissance or validation for systems impenetrable by conventional means.⁴⁶

The ether targeting environment also drives needs for peculiar skills and equipment. Specifically, adversaries will certainly avail themselves of high-fidelity sniffers and sensors to detect net invasion. By 2025, electrons will be as identifiable as DNA strands allowing individuals to detect, identify, and target particular transmissions for manipulation. Unlike most warfare, cyberwar and commercial war open Pandora’s box—defining truth.⁴⁷ This peculiar problem defines the unique requirement for special operations vice conventional or civilian remote expertise. SOF will get in close enough to personally verify and validate what the computer expert sees on his monitor. The level of threats in cyberwar will dictate absolute confidence in the input source and adversary motives before punitive action is taken, either overtly or covertly.

A strong emphasis remains on high-fidelity intelligence, real-time intelligence, personnel selection, training, and limited communications along with rapid mobility of personnel, equipment, and neutralization device. If the special operations cyber team is interdicting a commercial piracy ring duping music, videos, or software packages, they will need unprecedented interagency and international authority cooperation. If the team is targeting an individual or network and wishes to preserve deniability, they may plant a specialized ether weapon such as an undetectable antidote that corrupts on system start-up. This antidote would be encased in a low-profile briefcase and transmit electronically up to several meters.⁴⁸

Advances in electron recognition systems enable the special operations cyber warrior to monitor ether lines of communication and perform a variety of missions. One would be nulling the gateway to unfriendlies

--information is sent, but stops at the gateway. It can disappear, spin into delay, receive a small parasite virus, or have minimal changes which corrupt perceived reality but defy detection.

Countercountermeasures for ether targeting are remarkably similar to aircraft systems. To perform *any* ether or cyber tasks, the warrior will require (1) ether IFF; (2) better analytical tools to determine cyber centers of gravity; (3) feedback loops with infinitesimal precision by current standards; (4) low probability of intercept/low probability of detection for ether weapons and monitoring devices; and finally (5) ether detection avoidance systems or threat avoidance systems as the unfriendlies will be equally diligent and capable in ether targeting techniques.

For ether targeting within commercial warfare, SOF precision operations will require a different array of capabilities. In a business-suit briefcase set, the SOF warrior stands out like a sore thumb. He is ill-equipped today to glide effortlessly in the halls of high finance and intrigue. Yet, US national security defined by trade secrets and corporate knowledge determine both US power and vulnerability in both foreign and domestic markets. Only political sensitivity and limited opportunity would prompt SOF precision operations engagement.

SOF hyper teams would target and deny commercial lines of communication to those who do not comply with US rules of engagement. In these cases, centers of gravity would be critical nodes such as gateways, undersea fiber optic cables, or other system links. The key for SOF precision strikes is effects-based targeting that deny the target use by foes and retain their use for friends.

Accomplishing these objectives will require delivery platforms, very high fidelity intelligence, multilevel security interagency and international coordination tools, and effective feedback loops or measurement tools to determine point of cutoff or access denied.

Notes

¹ Alan D. Campen, *The First Information War*, (Fairfax, Va.: AFCEA International Press, 1992), x.

² *Warfighting Vision 2010, A Framework for Change*, Joint Warfighting Center Doctrine Division, Ft Monroe, Va. 1 August 1995, 10.

³ Ibid. The original System of systems does not contain the 4th area called personnel interface.

⁴ **2025** Concept, no. 900604, "UAV Constellations," **2025** Concepts Database (Maxwell AFB, Ala.: Air War College/**2025**, 1996).

⁵ Col John A. Warden III, USAF, (Ret.), lecture to the 1996 ACSC class, 8 April 1996. During the Persian Gulf War, Colonel. Warden was assigned to Checkmate in the Pentagon, a unique directorate in Air Force Plans chartered to provide independent thinking and analysis on important combat-employment issues.

- ⁶ **2025** Concept, no. 200004, “Advanced MILSATCOM Capability,” **2025** Concepts Database (Maxwell AFB, Ala.: Air War College/**2025**, 1996) (PROPRIETARY).
- ⁷ **2025** Concept, no. 900291, “Quantum Polarization Shift Communications,” **2025** Concepts Database (Maxwell AFB, Ala.: Air War College/**2025**, 1996).
- ⁸ Braunberg, Andrew C. “Advances Push Communications Toward Army’s Lowest Echelons.” *Signal*, November 1995, 30.
- ⁹ USAF Scientific Advisory Board, *New World Vistas: Air and Space Power for the 21st Century* (unpublished draft, the information technology volume, 15 December 1995), 20.
- ¹⁰ *Ibid.*
- ¹¹ Braunberg, Andrew C. “Advances Push Communications Toward Army’s Lowest Echelons.” *Signal*, November 1995, 27.
- ¹² **2025** Concept, no. 900123, “Body Heat as a Low Grade Energy Source,” **2025** Concepts Database (Maxwell AFB, Ala.: Air War College/**2025**, 1996).
- ¹³ *Ibid.*
- ¹⁴ Braunberg, Andrew C. “Technology Agency Aims For High Payoff Systems.” *Signal*, December 1995, 29.
- ¹⁵ **2025** Concept, no. 900567, “I Can Smell You,” **2025** Concepts Database (Maxwell AFB, Ala.: Air War College/**2025**, 1996); and **2025** Concept, no. 900280, “Fly on the Wall,” **2025** Concepts Database (Maxwell AFB, Ala.: Air War College/**2025**, 1996).
- ¹⁶ *New World Vistas*, (unpublished draft, the mobility volume), 22.
- ¹⁷ *New World Vistas*, (unpublished draft, the aircraft and propulsion volume), 41.
- ¹⁸ Vincent P. Grimes, “New Ships, Plane Upgrades Enhance Special Operations Punch,” *National Defense*, December 1995, 31.
- ¹⁹ *Ibid.*, 10.
- ²⁰ **2025** Concept, no. 200017, “Modular Medium Lift Aircraft,” **2025** Concepts Database (Maxwell AFB, Ala.: Air War College/**2025**, 1996).
- ²¹ John L. Petersen, *The Road to 2015, Profiles of the Future*, 172. Corte Madera, Calif: Waite Group Press, 1994.
- ²² **2025** Concept, no. 900130, “Use of Magnetic Based Rotation of Ionized Air,” **2025** Concepts Database (Maxwell AFB, Ala.: Air War College/**2025**, 1996).
- ²³ *New World Vistas*, summary volume, 30.
- ²⁴ **2025** Concept, no. 900144, “Use of Eclectic Materials in Aircraft Rotorblades,” **2025** Concepts Database (Maxwell AFB, Ala.: Air War College/**2025**, 1996).
- ²⁵ *New World Vistas*, (unpublished draft, the aircraft and propulsion volume), 41.
- ²⁶ *New World Vistas*, (unpublished draft, the mobility volume), 22.
- ²⁷ *New World Vistas*, (unpublished draft, the aircraft and propulsion volume), 41.
- ²⁸ *Ibid.*, 16–17.
- ²⁹ Robert A. Heinlein, *Starship Troopers* (New York: The Berkley Publishing Group, 1959), 8–12.
- ³⁰ *Ibid.*, 20–21.
- ³¹ **2025** Concept, no. 900699, “Chameleon Camouflage,” **2025** Concepts Database (Maxwell AFB, Ala.: Air War College/**2025**, 1996).
- ³² Alvin and Heidi Toffler, *War and Anti-War*, (Warner Books: New York), 1993.
- ³³ *Tek War®*, Atlantis Productions, 1994.
- ³⁴ **2025** Concept, no. 900262, “Immune Warrior,” **2025** Concepts Database (Maxwell AFB, Ala.: Air War College/**2025**, 1996).
- ³⁵ John L. Peterson, *The Road to 2015, Profiles of the Future*, Appendix B, 347.
- ³⁶ **2025** Concept, no. 900699, “Chameleon Camouflage,” **2025** Concepts Database (Maxwell AFB, Ala.: Air War College/**2025**, 1996) and **2025** Concept, no. 900570, “Deceptive Holographic Imaging,” **2025** Concepts Database (Maxwell AFB, Ala.: Air War College/**2025**, 1996).
- ³⁷ **2025** Concept, no. 900532, “Paint Tag ID System,” **2025** Concepts Database (Maxwell AFB, Ala.: Air War College/**2025**, 1996).
- ³⁸ **2025** Concept, no. 900341, “ROBOBUGS,” **2025** Concepts Database (Maxwell AFB, Ala.: Air War College/**2025**, 1996) and **2025** Concept, no. 900280, “Fly on the Wall,” **2025** Concepts Database (Maxwell AFB, Ala.: Air War College/**2025**, 1996).

³⁹ *Runaway*®, TriStar Productions, 1984.

⁴⁰ *Star Trek: The Next Generation*® “The Vengeance Factor,” Episode 157, 1989.

⁴¹ **2025** Concept, no. 900375, “Target ID via DNA Sensing,” **2025** Concepts Database (Maxwell AFB, Ala.: Air War College/**2025**, 1996) and **2025** Concept, no. 900468, “Covert Target Marking,” **2025** Concepts Database (Maxwell AFB, Ala.: Air War College/**2025**, 1996).

⁴² ULTIMATE WARRIOR Concept Submission, R. Colvert, *Technology Initiatives Game 95*, 38-1 through 38-2 and **2025** Concept, no. 900317, “Tactical Information Display Helmet,” **2025** Concepts Database (Maxwell AFB, Ala.: Air War College/**2025**, 1996).

⁴³ *Dune*®, De Laurentis Productions, 1984.

⁴⁴ **2025** Concept, no. 900688, “Amiability Agent,” **2025** Concepts Database (Maxwell AFB, Ala.: Air War College/**2025**, 1996) and **2025** Concept, no. 900330, “Delayed Action Agents,” **2025** Concepts Database (Maxwell AFB, Ala.: Air War College/**2025**, 1996).

⁴⁵ Sting, “If You Love Somebody Set Them Free,” *Fields of Gold*, A&M Records, 1994.

⁴⁶ Again, this mission is not the sole purview of special operations. Commercial vendors, law enforcement agencies, and government will all strive to meet the growing threat with both individual and collective efforts. However, both cyberwar and commercial war activities will require special operations intervention—to protect political sensitivity and exploit limited opportunity.

⁴⁷ Gornicki (previously cited) takes exception with Col Jeffrey Jones, former psychological operations unit commander who states, “Truth is our best weapon.” Gornicki rebuts by invoking Socrates who “long ago complained about the difficulty defining truth,” 6.

⁴⁸ Discussion with Scientific Advisory Board Chair, Dr Gene McCall, during the 2025 Advisors meeting at Maxwell AFB, Ala. 26 March 1996. Dr McCall indicated a belief that SOF required a unique kitbag of equipment for ether, cyber, or commercial targeting and neutralization. This kitbag or toolkit should be impervious to all mediums (i.e., submersible in water up to 100 meters or more or pressurization tolerant), relatively nondescript such as a briefcase, and possess a robust capability for density penetration or communication. While several concepts address conventional information dominance tools, they do not explore the realm inhabited by special operations. Dr McCall agreed this required further study.

Chapter 4

Conclusion and Investigation Recommendations

The time frame of 2025 will continue to be challenging for special operations forces and their precision operations missions. All alternate futures identified by 2025 research require SOF. In particular, SOF precision operations will provide the flexible deterrence and engagement options needed by tomorrow's political and military leaders to ensure US national security and national interests are safeguarded. In the true spirit and capability of *Dim Mak*, the precision operations capability in 2025 will mandate a continuous stand-ready global posture and the ability to instantaneously mobilize, deploy, locate, identify, and engage a target. Using varying levels of effect or lethality, precision operations teams can then withdraw, and redeploy with no trace or evidence of their being or the operation. As identified in the beginning of this white paper, special operations precision operation forces will need to be highly dedicated, motivated, specially trained, and uniquely equipped. They will operate throughout the war and peace spectrum, but their niche will lay in missions characterized by political sensitivity, with limited windows of opportunity, and the use of unorthodox approaches.

Though each of the 2025 alternate futures worlds (Gulliver's Travails, King Khan, Zaibatsu, Digital Cacophony, Crossroads 2015 & Halfs and Half-Naughts) possess unique characteristics, several variables remain constant. These are proliferation of WMD, the increase in terrorism, and the rapidly expanding worldwide interconnectivity and interdependency on ether technologies. Facets of US national interests, such as defense, economy, politics, environment, and communications, along with the developing global community are becoming more reliant on the electronic data manipulation. With this ongoing information revolution and growing dependency on information technologies, ether is becoming a lucrative environment that SOF precision operations can target.

In choosing how to apply SOF precision operations capabilities in 2025 against a particular threat, the threat must be viewed as a system whose components (people, hardware, processes, and ether) can be selectively targeted for desired effect by SOF. The enabling capabilities for 2025 precision operations identified in this white paper are communications, mobility, and destruction/neutralization. These three capabilities provide the bridge between the global awareness-communication, global reach-mobility, global power-destruction/neutralization, and will continue to in 2025.

The exact mission or missions for SOF precision operations in 2025 are impossible to predict. However, the core competencies of SOF precision operations will most likely not vary far from the present; and these competencies drive the need for specific capabilities generic to any likely future precision operations tasking. Specific recommendations for generic capability follow.

Communications

Communication requirements for SOF precision operations goes significantly beyond the ability of team members to talk to each other. Communications involves the quest and distribution of mission knowledge in a timely and useful manner to guarantee mission success. The development of the system-of-systems suggested by Admiral Owens is a foundation for the info-kit of 2025. Fusing numerous information and data sources into a usable format that is interoperable for all future worldwide communication systems is essential. Though all 2025 alternate future worlds will require SOF to interact with ether systems, the Digital Cacophony future will require a distinctive edge in communication capability because one's adversary will most likely be very capable of information manipulation too.

Providing this communications capability in an inconspicuous package defines the personnel interface requirements for precision operations and the system-of-systems for 2025. Key technologies will be data compression, fusion, and transfer capabilities and new advances in software or artificial intelligence techniques to manage, manipulate and process required data. The right information at the right time will be crucial for SOF precision operations in 2025.

Global networking with multilevel security access will be needed to meet precision operations requirements. Robust, hardened, and diverse satellite and UAV constellations would provide this global

communication capability if developed and available for SOF in 2025. Additionally, microminaturization of mechanical and electronic equipment will be needed for clandestine operations. Robust but inconspicuous power supplies will also need further advances to satisfy SOF precision operations clandestine requirements.

Mobility

Mobility remains a key to special operations in any of the envisioned futures of 2025, from the peer competitor of Khan to the niche competitors in Gulliver's Travails. Regardless of the environment, insertion and extraction of SOF poses challenges that emerging technology can solve. The following areas offer suggested recommendations for investment of technology dollars to solve those challenges by 2025: stealth airlifter, hypersonic aircraft and low earth orbiters, and extraction rockets.

Current airlifters will not be survivable in 2025. A stealth airlifter will offer greater potential for mission success due to the incorporation of current and ongoing research and development in both low-observable and powerplant and propulsion systems. Investment in these areas will allow the production of lift platforms that meet critical special operations requirements of vertical lift, long range, high speed, and payload.

In a volatile world there is often a requirement to respond quickly to a given situation. Special operations missions are characterized by a very narrow window of opportunity for mission success. Hypersonic aircraft and LEOs offer the potential of inserting SOF into crisis areas quickly. Ongoing research and development in powerplant and propulsion systems will offer the potential for production of platforms suitable for special operations.

The extraction portion of special operations missions is a critical time for mission success. The requirement to exit the target area quickly is paramount. An extraction rocket could offer a potential solution to this problem. A rocket secured at the insertion point could quickly extract the SOF team out of the target area for recovery by LEOs in space or by aerial recovery systems. Extracting the team for recovery into space or utilizing aerial recovery would shorten the range requirements of the rockets reducing the size of the vehicle.

Destruction/Neutralization

All phases of the precision operations mission are critical, however, once the precision operations team is engaged with the target, how the target is manipulated is critical not only for desired effect but in the protection of political sensitivity and if need be, deniability. The insurmountable consequence of failure also drives the do or action phase of SOF precision operations to an extreme level of capability and reliability. Second chances are not viable options. To this end, recommendations for each of the four mission areas will be addressed.

WMD neutralization includes advances in the immune warrior concept, selective immunities to biological and chemical agents; and advances in technology to accelerate decay of chem/bio agents or partial neutralization to render the destruction element or limit its effectiveness.

HVT engagement involves development of designation or tagging systems that operate within different emission spectrums. These tags would incorporate a low chance of adversary detection, self-destruction, and pinpoint location of the tagged item. HVT engagement will also provide for tunable lethality explosive technology, to select on-location the appropriate level of kill for the given target set, environment, and scenario.

HVA recovery will have advances toward an integrated tactical sensory/display/targeting helmet or info-kit as described in the communications section. This equipment would be capable of sorting out friend or foe, provide real-time communication and data links between all team members and external sensors, and incorporate direct weapon slaving and targeting links for handheld weapons. HVA recovery will also have handheld weapons systems with tunable lethality, with near-instantaneous changing between levels from stun to paralysis to death.

Ether targeting is the key to effective SOF precision operations targeting in either cyber war or commercial warfare and can preserve political deniability, exploit a very narrow window of opportunity, and support withdrawal. Capabilities and technologies to accomplish this mission are partially found in the communication section of this paper. The precision operations teams ability to interact and thus manipulate information of Noncooperatives lies in the capabilities envisioned with the info-kit of 2025. Other 2025 research papers discuss actual techniques and equipment to manipulate or destroy an adversary's electronic

data. This arena will not come naturally to a SOF hunter/killer team. These skills will seem more than foreign and alien, only in the magnitude of the threat and inability of civilian agencies to meet that threat will SOF reluctantly heed the call.

Above all, the decision of what component to target within a system must be analyzed by thoroughly understanding the desired end-state, accurate evaluation of system component vulnerability, and the risk to precision operations forces.

Appendix A

Scenario #1

In 2025, it is highly likely that nations possessing WMDs will also have sophisticated means of detecting and directing reaction forces. In all probability, WMDs will be guarded by both human and remote sensors or systems. Addressing the remote sensors will be accomplished by electronic disruption and/or deception. As a result of such efforts, electronic confusion and diversion will convince the enemy that attacks are in progress at other locations while full spectrum jamming and broadcasts allow SOF freedom of movement for short but adequate periods of time. The use of molecular altering devices and/or chemical/biological reversing agents will allow SOF teams to neutralize WMDs, leaving the weapons system intact and preventing the enemy from knowing the weapons are harmless.

When necessary, SOF teams employed against an array of WMD sites for simultaneous destruction operations will be linked together for coordinated action through satellite communications display devices. Through a heads-up display inside the helmet, this capability will permit the operator to see actions at various sites or locations on demand, and allow operators to communicate with other operators regardless of distance or terrain. Space-based command and control centers will provide both communications connectivity between operators and command direction when required. The need for secure, digitized over the horizon, long-distance communications between operators and control centers is absolute. Communications mediums will have both secure voice as well as secure imaging capabilities.

WMDs which must be transported from site locations and require manpower in the absence of mechanical devices will be moved by biomechanical human enhancement devices. A man capable of lifting 200 pounds will be capable, through the use of exoskeleton devices, of lifting 500 pounds. Superhuman strength will be achieved through chemical injection and biomechanical devices. Climbing, lifting, and

physical exertion tasks will be accomplished by enhancing human attributes through the use of these drugs and devices. These technologies, in addition to lightweight ceramic armored body shells, will turn the SOF operator into a formidable foe.

Appendix B

Scenario #2

Because of political as well as ethical reasons, equipment and techniques used for destruction and neutralization missions will require a level of sophistication that results in minimal to no collateral damage, as well as secrecy. Target areas identified for operations will be visually fixed in a way which allows for continuous monitoring via the fusion of information gathered by space-based and all other information-gathering platforms and methods. Such fusion will provide the user (team and NCA) with information dominance within the objective area. Once this dominance is achieved (including secure communications), teams will be inserted into a region via stealthy LEO spacecraft (referred to earlier) from which they will infiltrate by foot to the objective site. Once at the site, teams will emplace systems which will provide continuous, secure, on-site video and BDA systems for post-attack analysis and real-time observation by the NCA or appropriate command authority.

Upon completion of the tasks mentioned above, teams will mark targets for engagement by using advanced laser designation systems or other systems which place permanent emitters on the target tuned to a specific frequency or infrared (IR) pattern identifiable only to the team and missile or system chosen for engagement. During this process the team will select the appropriate type of system to engage the target and transmit the information via secure SATCOM methods so that the appropriate delivery platform can be made available. The selection of the engagement system will be determined based on such things as the location and construction of the target, security, and defensive systems protecting the target, flight path obstacles, engagement angles, and civilian locations. Platforms chosen to deliver the required weapons system will be allocated by higher authority based on such items as platform location, time of flight, availability, and risk of compromise. While there may be exceptions to the rule, in most situations, teams will be extracted prior to

target engagement. Engagement will be conducted using precision-guidance weapons launched from platforms well outside territorial air, land, and sea space.

Appendix C

Scenario #3

Firsthand experience developing an unclassified local and wide-area network for special operations in the late 1980s and early 1990s illuminated the potential of ether targeting in the future. Sitting at a desk in Washington, D.C., my computer would crash. I could call the system administrator at Hurlburt Field, Florida who would dial into my computer and “see what was happening. Within limits, he or she accomplished real-time troubleshooting, blasted patches or software upgrades, and I’d be back in business.¹ If I sent e-mail, he could watch it clear respective gateways until reaching its destination in seconds. However, occasionally I would have to confirm what was really happening on the monitor when it did not correspond to data on his screen. The lesson learned was that with the root password and proper training, anyone could dial into my system and watch while I worked. The second lesson learned was that the military will not be able to select the personnel to design or maintain our communications, or computers, command and control networks once the military establishment shifts totally to off-the-shelf (OTS) acquisition.

People unfriendly to the United States will probably exploit this dependence on the commercial sector.

Winn Schwartau provides a provocative quote from Lester Thurow

History is clear. While military power can sometimes outlast economic power for centuries, eventually it depends upon having a successful economic base. America’s success in the Gulf War proves that it is, and will be, a military superpower in the century to come. But its success in the Gulf in no way guarantees that it will be an economic superpower in the twenty-first century.²

Our economic base is both the source of our strength and the primary target of our foes. “The knowledge and beliefs of decision makers are the Achilles’ heel of hierarchies.”³ As our decision makers depend on the US

industrial base to research, develop and maintain their metasecosystems (complex and interconnected galactic spider webs), we observe the creation of a weak link—the vulnerability to cyberwar.

Toffler describes a second vulnerability during an interview with Peter Schwartz for *Wired* magazine in 1995. “The thesis (of *War and AntiWar*) is very simple. The way you make war is the way you make wealth. If you change the way you make wealth, you inevitably change the way you make war.”⁴ Toffler contends that making wealth in the twenty-first century is a complete reversal of the industrial age mass production, marketing, investments and trade. Instead, third wave economic and information warfare will center on microtrade/capital/markets/technologies and microweaponry. This is more than mere miniaturization of existing force. Mass production begat mass destruction, or

industrialized warfare. And if we are now in the process of transforming the way we create wealth, from the industrial to the informational, or call it whatever you wish, there is a parallel change taking place with warfare, of which the Gulf War gives only the palest, palest little hint. The transition actually started back in the late-1970s, early-1980s, to a new form of warfare based on information superiority. It mirrors the way the economy has become information-dependent.⁵

The density and redundancy of metasecosystems defy targeting. Yet, within the military lies a vulnerability.

As the Pentagon becomes ever-more dependent on high tech, it finds itself deeper and deeper in a maze:

- It is developing a new cyberspace warfare strategy that is intended both to defend and wreck the very computer networks that support it and all other modern armed forces.
- Military officials acknowledge that they have no ability to protect themselves from cyberspace attacks and no legal or political authority to protect commercial phone lines, the electrical power grid and vast, vital databases against hackers, saboteurs and terrorists.⁶

Individuals with questionable agendas can now fulfill Toffler’s prophecy of a one man, one-niche market, one-weapon threat. This drives the requirement for an equally potent countercapability.

Special operations must confirm or deny input and output of economy, security, or knowledge information systems before application of force. Just seeing it on your screen or tracing the electrons back to a source may not be sufficient verification of hostile intent. In this case, seeing is not believing. In developing a counter capability, we need to understand the environment. Col Richard Szafranski effectively narrowed the ether target set for special operations in “A Theory of Information Warfare.”

Warfare is the set of all lethal and nonlethal activities undertaken to subdue the hostile will of an adversary or enemy. In this sense, warfare is not synonymous with “war.” . . . Warfare is hostile activity directed against an adversary or enemy. Information warfare is

a form of conflict that attacks information systems directly as a means to attack adversary knowledge or beliefs...netwar or cyberwar.⁷

If the adversary is attacking knowledge or beliefs through ether means, special operations tasks may be to confirm the hostile nature of the activity. Special operations will confirm that what you see IS what you get.

Thus, both the US education system and Wall Street provide targets of opportunity for an enterprising foe. Planting seeds early for fruition down the road, applications at defense contractor facilities will contain impeccable credentials from the finest institutions of learning. But, everyone working for the defense industry will not possess hostile intent.

Special operations ability to act decisively in politically sensitive situations with limited opportunity require specialized enabling capabilities in cyber or commercial warfare. At a recent nonlethal weapons conference held in Washington, D. C., Lt Gen Lloyd (“Fig”) Newton, assistant vice chief of staff of the Air Force and former USSOCOM/J-3, “introduced information warfare and the use of electronic warfare . . . (and) establishment of appropriate rules of engagement . . . the requirement for seamless integration of lethal and nonlethal weapons.”⁸ Special operations conducted in cyberwar and commercial war require tools to complement and seamlessly interface with both civilian and conventional primes as a force multiplier.

Notes

¹ ARINC’s Software Reusability Group (SRG) patented a procedure for simultaneously updating widely dispersed networks and dubbed it “blast.”

² Quoted in Winn Schwartz, *Information Warfare*, (New York: Thunder’s Mouth Press, 1994), 38.

³ Col Richard Szafranski, USAF, “A Theory of Information Warfare: Preparing For 2020.” Culled from the Internet off the worldwide web, IASIW homepage, 1996. On-line, Internet, 20 March 1996, available from <http://www.psycom.net/iwar.1.html>.

⁴ Kevin Kelly, “Shock Wave (Anti) Warrior,” *Wired*. On-line, Internet, 20 March 1996, available from <http://www.hotwired.com/wired/1.5/features/toffler.html>. 1995.

⁵ Ibid.

⁶ Neil Munro, “The Pentagon’s New Nightmare: An Electronic Pearl Harbor: A Look At The On-Line Frontier,” *The Washington Post*, 16 July 1995.

⁷ Col Richard Szafranski, USAF, “A Theory of Information Warfare: Preparing For 2020.” Culled from the Internet off the worldwide web, IASIW homepage, 1996. On-line, Internet, 20 March 1996, available from <http://www.psycom.net/iwar.1.html>.

⁸ John Alexander, “Nonlethal Weapons: The Requirements,” unpublished article documenting the March 1996 DOD Conference on Nonlethal Weapons—accepted by Jane’s IDR for publication. Used by permission.

Appendix D

Supporting Technologies Abstracts

Advanced MILSATCOM Capability (AF 2025 Concept #200004)

The advantages of future MILSATCOM systems will affect virtually all Air Force mission categories to include SOF precision operations. With the ability to securely transmit and receive large amounts of data in near-real-time, and employ fully interactive communications, significant advances in precision operations effectiveness can be expected.

Amiability Agent (AF 2025 Concept #900668)

This agent causes those individuals contacted to become very easily persuadable. This could become quite useful in hostage negotiations, providing a quick and peaceful defusing of the situation.

Body Heat as a Low Grade Energy Source (AF 2025 Concept #900123)

This capability would eliminate or reduce the need for separate battery power units for low energy consumption communication gear carried personally.

Chameleon Camouflage (AF 2025 Concept #900699)

The goal is to develop camouflage paint or uniforms that can change color to blend with the surrounding terrain. Tiny sensors and nanotech electronic devices provide the color-change capability. Color changes

are provided to help minimize visibility, but could also be adapted for work in the near-visual spectrum, masking IR signature or other emissions. Advantages include the reduced preparation for deployment with no need to modify current camouflage schemes.

Covert Target Marking (Using Bug B.O.) (AF 2025 Concept #900468)

Making use of a pheromone-imitating substance or device to mark HVTs, exit trails, and extraction points for SOF. With a target marked, a new form of guidance kit must be developed to home in on this signature. Targets could, additionally, be marked well in advance depending on the persistence of the pheromone and weather conditions.

Deceptive Holographic Imaging (AF 2025 Concept #900570)

This concept calls for the development of the capability to project an array of holographic images about certain locations. The intent being to deceive the adversary into misallocation of resources, attention, and/or effort around the present operation.

Delayed Action Agents (AF 2025 Concept #900330)

Development of a poison or nonlethal agent (e.g., sleep-inducing) that has a controlled delay time before becoming effective. Such a substance could be clandestinely introduced into the food, water, or air of the adversary. The advantage is to disable the adversary without them knowing who is responsible and allowing for uncontested SOF precision operations.

Fly on the Wall (AF 2025 Concept #900280)

Modifying the original mission of this concept from reconnaissance to a fly-to placement of itself on a target, configured to emit low energy code, allowing a homing weapon to guide in on its position. The fly requires advances in nanotechnology that would give it full mobility, flight a large field of view, visual acuity, and optimize the fly's bulging hex-covered eyes with simultaneously views in nearly all directions.

The fly would be operated via remote control by on-site special operations personnel to the DMPI, providing near-pinpoint targeting accuracy.

I Can Smell You (AF 2025 Concept #900567)

This concept proposes developing a computer chip or targeting system to detect the smell of a particular target. For precision operations, this type of device could be used in the counter WMD where once a target was detected a weapon with “smell-seeking” guidance could home in on the aroma or scent of the device.

Immune Warrior (AF 2025 Concept #900262)

By the year 2005, scientists plan to decipher the entire human genetic code, and by 2015 expectations are to have a complete DNA coding or functional definition for each of over 100,000 genes that make up a human being. The plan is to create super boosters for the human immune system, consisting of adaptive antibodies capable of responding to a wide range of pathogens from chemical or biological weapons. These super boosters will have an unlimited useful lifetime in the bloodstream and have no side effects. The special operations specialist of 2025 could selectively remain immune to any known chemical or biological agent that the enemy owned, while performing the neutralization mission.

Information Bomb (AF 2025 Concept #900328)

The commanders of adversarial forces can be paralyzed by a flood of information that SOF could directly disseminate into their computer systems, their sensors, or their satellites. This would be a controlled and timely information overload.

Modular Medium Lift Aircraft (AF 2025 Concept #200017)

Aircraft is a high-efficiency modular aircraft in the 100-ton weight class. Four comparable models are designed for airlift, tanker, global range strike, and SOF. This aircraft would employ low observable technology, provide adequate range (6000 NM) unrefueled payload size (90kLB), and vertical lift for SOF variant.

Paint Tag Identification System (AF 2025 Concept #900532)

This concept provides a more efficient means of distinguishing between friendly and enemy platforms. The paint tag identification concept incorporates an undetectable microscopic transponder embedded in specialized, conductive paints. A low power signal is emitted from the friendly source for discerning ID, or on the targeted enemy item for destruction by a homing weapon.

Quantum Polarization Shift Communications (AF 2025 Concept #900291)

Since quantum polarization has the potential for faster than light communications at any distance and is jam proof, it would revolutionize communication as we know it today. Quantum physics has demonstrated that when two photons are emitted by a particular light source and given a unique and identical polarization, they always share the same orientation. If polarity of one photon is changed, the other photon changes its polarity instantaneously. This concept invokes the notion of subspace communication capability postulated in the Star Trek television series and would offer SOF precision operations teams tremendous capability.

ROBOBUGS (AF 2025 Concept #900341)

Same as the Fly on the Wall concept described above.

Tactical Information Display Helmet (TID-H) (AF 2025 Concept #900317)

Target sets detected by advanced battlefield sensors and other team member helmets would be data linked to all helmets. A set of targeting and recognition symbols would be projected within the SOF precision operations team member's visors, using an adaptation of helmet-mounted sight technology and virtual reality systems. Dispersed, multi-axis attacks by team members are now less susceptible to friendly fire targeting, with minimal oral communication required.

Target Identification using DNA Sensing (AF 2025 Concept #900375)

This is the capability to identify weapons, targets, and friend or foe, through the DNA sensing technology. Each object has its own DNA fingerprint; the ability to recognize this DNA fingerprint could revolutionize target ID. An ongoing data-gathering process allows for data base growth; displays for SOF in the form of a HUD within a targeting helmet.

UAV Constellations (AF 2025 Concept #900604)

This concept would allow the deployment of several UAVs to provide radio or sensor coverage in an area of operations during a precision operations mission. If other communications systems were not available, UAVs would provide temporary or augmentation for precision operations mission tasking.

Ultimate Warrior (TIG 95 Concept)

Omnipotence in surrounding area data flow. A SOF precision operations member looks through the equivalent to a HUD; superimposed on that observation are geo-registered data, presented in visual icon form, for terrain mapping, friendly forces ID, threat positions and radii, battle plans, and communication. Added within the system could be a sophisticated targeting system, slaved to offensive and defensive weaponry.

Use of Eclectic Materials in Aircraft Rotorblades (AF 2025 Concept #900144)

Eclectic materials would permit the airfoils to adjust their shape during power on and off flight. These changes inflight would improve efficiency by improving lift, increase autorotational glide distances, reduce drag, and increase retreating blade-stall airspeeds. Primary advantages are that they can be retrofitted on current aircraft. This improvement, coupled with increase in powerplant and propulsion systems, would increase helicopter performance. A significant increase in current systems performance could negate the immediate requirement for new helicopter design.

Use of Magnetic-Based Rotation of Ionized Air (AF 2025 Concept #900130)

This concept is based on the use of magnetic-based rotation of ionized air as a substitute for physical turbine blades incremental compression of air. The advantages of this technology are that it reduces the number of moving parts and decreases the weight of the vehicle. The reduction in moving parts increases reliability rates and the reduction in weight would offer a potential increase in range and speed. All three of these factors are critical to any special operations system.

Bibliography

Articles/Magazines/Newspapers

- Alexander, John. "Nonlethal Weapons: The Requirements." (unpublished article). March 1996.
- Braunberg, Andrew C. "Advanced Push Communications Toward Army's Lowest Echelons." *Signal*, November 1995.
- Braunberg, Andrew C. "Technology Agency Aims For High Payoff Systems." *Signal*, December 1995.
- Grimes, Vincent P. "New Ships, Plane Upgrades Enhance Special Ops Punch." *National Defense*, December 1995.
- Munro, Neil. "The Pentagon's New Nightmare: An Electronic Pearl Harbor: A Look At The On-Line Frontier." *The Washington Post*. 16 July 1995.

Books

- Barnett, Jeffrey R. *Future War*. Maxwell AFB, Ala.: Air University Press. 1996.
- Campan, Alan D. *The First Information War*. Fairfax, Virginia: AFCEA International Press, 1992.
- The Chicago Manual of Style*. 14TH ed. Chicago: The University of Chicago Press, 1993.
- College of Aerospace Doctrine, Research, and Education. *AU Press Author Guide*. Maxwell AFB, Ala.: Air University Press, March 1995.
- College of Aerospace Doctrine, Research, and Education. *AU Press Style Guide for Writers & Editors*. Maxwell AFB, Ala.: Air University Press, December 1994.
- Douhet, Giulio. *The Command of the Air*. Washington D.C.: Office of Air Force History, 1983.
- Griffith, Samuel B. *Sun Tzu, The Art of War*, Translated and with an introduction by Samuel B. Griffith. Oxford, England: Oxford University Press, 1971.
- Heinlein, Robert A. *Starship Troopers*. New York: The Berkley Publishing Group. 1987.
- Petersen, John L. *The Road to 2015, Profiles of the Future*. Corte Madera, Calif.: Waite Group Press, 1994.
- Schwartz, Winn. *Information Warfare--Chaos on the Electronic Superhighway*. New York: Thunder's Mouth Press, 1994.
- Schwartz, Peter. *The Art of the Long View*. New York: Doubleday Dell, 1991.
- Toffler, Alvin and Heidi. *War and AntiWar, Making Sense of Global Chaos*. New York: Warner Books, 1993.
- Van Creveld, Martin. *The Transformation of War*. New York: Free Press, 1991.

Concepts--AF 2025 and Technology Initiatives Game

- 2025** Concept No. 200004. "Advanced MILSATCOM Capabilities." **2025** Concepts Data Base. Maxwell AFB, Ala.: Air War College/**2025**, 1996. (PROPRIETARY)
- 2025** Concept No. 200017. "Modular Medium Lift Aircraft." **2025** Concepts Data Base. Maxwell AFB, Ala.: Air War College/**202**, 1996.

- 2025 Concept No. 900123. "Body Heat as a Low Grade Energy Source." 2025 Concepts Data Base. Maxwell AFB, Ala.: Air War College/2025, 1996.
- 2025 Concept No. 900130. "Use of Magnetic Based Rotation of Ionized Air." 2025 Concepts Data Base. Maxwell AFB, Ala.: Air War College/2025, 1996.
- 2025 Concept No. 900144. "Use of Eclectic Materials in Aircraft Rotorblades." 2025 Concepts Data Base. Maxwell AFB, Ala.: Air War College/2025, 1996.
- 2025 Concept No. 900262. "Immune Warrior." 2025 Concepts Data Base. Maxwell AFB, Ala.: Air War College/2025, 1996.
- 2025 Concept No. 900280. "Fly on the Wall." 2025 Concepts Data Base. Maxwell AFB, Ala.: Air War College/2025, 1996.
- 2025 Concept No. 900291. "Quantum Polarization Shift Communications." 2025 Concepts Data Base. Maxwell AFB, Ala.: Air War College/2025, 1996.
- 2025 Concept No. 900317. "Tactical Information Display Helmet." 2025 Concepts Data Base. Maxwell AFB, Ala.: Air War College/2025, 1996.
- 2025 Concept No. 900328. "Information Bomb." 2025 Concepts Data Base. Maxwell AFB, Ala.: Air War College/2025, 1996.
- 2025 Concept No. 900330. "Delayed Action Bombs." 2025 Concepts Data Base. Maxwell AFB, Ala.: Air War College/2025, 1996.
- 2025 Concept No. 900341. "ROBOBUGS." 2025 Concepts Data Base, Maxwell AFB, Ala.: Air War College/2025, 1996.
- 2025 Concept No. 900375. "Target ID via DNA Sensing." 2025 Concepts Data Base. Maxwell AFB, Ala.: Air War College/2025, 1996.
- 2025 Concept No. 900468. "Covert Target Marking." 2025 Concepts Data Base. Maxwell AFB, Ala.: Air War College/2025, 1996.
- 2025 Concept No. 900532. "Paint Tag ID System." 2025 Concepts Data Base. Maxwell AFB, Ala.: Air War College/2025, 1996.
- 2025 Concept No. 900567. "I Can Smell You." 2025 Concepts Data Base. Maxwell AFB, Ala.: Air War College/2025, 1996.
- 2025 Concept No. 900570. "Deceptive Holographic Imaging." 2025 Concepts Data Base. Maxwell AFB, Ala.: Air War College/2025, 1996.
- 2025 Concept No. 900604. "UAV Constellations." 2025 Concepts Data Base. Maxwell AFB, Ala.: Air War College/2025, 1996.
- 2025 Concept No. 900688. "Amiability Agent." 2025 Concepts Data Base. Maxwell AFB, Ala.: Air War College/2025, 1996.
- 2025 Concept No. 900699. "Chameleon Camouflage." 2025 Concepts Data Base. Maxwell AFB, Ala.: Air War College/2025, 1996.
- 2025 Study White Paper. "Counterinformation." 2025 Concepts Data Base. Maxwell AFB, Ala.: Air War College/2025, 1996.
- Colvert, R. *Ultimate Warrior*. Technology Initiatives Game '95. Naval War College Compendium. 1995 (FOUO).

Publications/Reports/Pamphlets

- Gornicki, Wieslaw. "In the Shadow of the L-Bomb." Warsaw Przegląd Społeczny *Dzis*. (FBIS Translated Text), 1 November 1995.

Spacecast 2020, Air University Into the Future. AU Press, 1995.

USAF Scientific Advisory Board. *New World Vistas: Air and Space Power for the 21st Century*, Summary Volume. Washington, D.C.: USAF Scientific Advisory Board, 15 December 1995.

———. *New World Vistas: Air and Space Power for the 21st Century*. Unpublished draft, the Aircraft and Propulsion Volume. 15 December 1995.

———. *New World Vistas: Air and Space Power for the 21st Century*. Unpublished draft, the Information Technology Volume. 15 December 1995.

———. *New World Vistas: Air and Space Power for the 21st Century*. Unpublished draft, the Mobility Volume. 15 December 1995.

United States Special Operations Command. *The United States Special Operations Forces Posture Statement*. GPO, Washington, D.C., 1994.

US President. *A National Security Strategy of Engagement and Enlargement*. Washington D.C.: The White House, 1996.

Warfighting Vision 2010, A Framework for Change. Ft Monroe, Va.: Joint Warfighting Center, Doctrine Division, 1 August 1995.

Movies/Television/Music

Drop Zone®. Paramount Pictures, 1994.

Dune®. De Laurentis Productions. David Lynch - Screenplay Author. (7th draft - 1983), 1984.

Runaway®. TriStar Productions, 1984.

Star Trek: The Next Generation®. Episode 157. "The Vengeance Factor," 1989.

Sting. "If You Love Somebody Set Them Free." *Fields of Gold*. A&M Records, 1994.

Tek War®. (*TekWar: TekLords*®, *TekWar: TekLab*®, *TekWar: TekJustice*®). Atlantis Productions. William Shatner - Writer/Director, 1994.

Speeches/Lectures

Collins, John. CRS Report to Congress. *Special Operations Forces, An Assessment 1986-1993*, July 1993. GPO, Washington, D. C., 1993.

Medical Implications in the Future. Dr James Kvach. 2025 Briefing. 31 January 1996.

Internet Resources

Kelly, Kevin. *Wired*. "Shock Wave (Anti) Warrior." Internet address: <http://www.hotwired.com/wired/1.5/features/toffler.html>. 1995.

Mak, Danton K. "Intellectual Property Checklist for Ventures in the 90's." On-line, Internet, 20 March 1996, available from <http://www.calcom.com/sm/articles/ipcheck>, 1.

Microsoft Network News. "US, Japan in Piracy Battle." Internet address: <http://www.msn.com>. February 1996.

Szafrański, Richard. "A Theory of Information Warfare: Preparing For 2020." Internet address: <http://www.cdsar.af.mil/apj/szfran.html>. 1996.

A Hypersonic Attack Platform: The S³ Concept



A Research Paper
Presented To

Air Force *2025*

by

Dr. John J. Bertin
Cadet John M. Boehm
Cadet Stephen B. Matthews
Cadet Thomas C. McIntyre
Cadet Brandon L. Rasmussen
Cadet Adam R. Sitler
Cadet J. Brett Taylor
Cadet Robert A. Williamson
Cadet George R. Wyse

August 1996

Disclaimer

2025 is a study designed to comply with a directive from the chief of staff of the Air Force to examine the concepts, capabilities, and technologies the United States will require to remain the dominant air and space force in the future. Presented on 17 June 1996, this report was produced in the Department of Defense school environment of academic freedom and in the interest of advancing concepts related to national defense. The views expressed in this report are those of the authors and do not reflect the official policy or position of the United States Air Force, Department of Defense, or the United States government.

This report contains fictional representations of future situations/scenarios. Any similarities to real people or events, other than those specifically cited, are unintentional and are for purposes of illustration only.

This publication has been reviewed by security and policy review authorities, is unclassified, and is cleared for public release.

Contents

<i>Chapter</i>		<i>Page</i>
	Disclaimer	ii
	Illustrations	v
	Tables	vi
	Preface.....	vii
	Executive Summary.....	ix
1	Overview of Proposed Integrated Weapons System.....	1
	Characterization of the Proposed Weapons System.....	2
	Features of the Elements of the Proposed Weapons System	5
	Utilization of the Proposed Weapons System	7
	Technology Considerations	13
2	Supersonic/Hypersonic Attack Aircraft (SHAAFT)	17
	General Mission Requirements	18
	CONUS Basing	18
	Cost-Saving.....	18
	Hypersonic Requirement.....	19
	Range	20
	Payloads.....	20
	SHAAFT Vehicle Concepts	20
	The “Zero-Stage” Flying Wing.....	20
	SHAAFT Design	22
	Flight Control Systems	29
	Special Considerations	30
	Mission	31
	Flight Profile.....	31
	Landing Phase	31
	Payload Deployment	32
	Threats to the SHAAFT	33
	Component Summary.....	34
3	Standoff Hypersonic Missile with Attack Capability (SHMAC)	36
	General Mission Requirements	38
	Range and Time to Target	38
	Cost Effective.....	39
	Operational Simplicity.....	40
	SHMAC Vehicle Concepts	41
	SHMAC Design	41
	Propulsion	43
	Guidance	45

<i>Chapter</i>	<i>Page</i>
Modular Weapons Bay.....	46
Special Considerations	46
Mission	47
Flight Profiles	47
Objective.....	50
Component Summary.....	53
4 Space Control with a Reusable Military Aircraft (SCREMAR)	55
System Overview	55
The Need for Access to Space	56
General Mission Requirements	59
Payload	59
Sizing	60
Staging.....	61
Operational Efficiency	63
Development	64
Infrastructure	64
Special Considerations	66
Missions.....	68
Deployment/Retrieval of Satellites	70
Repair of Damaged Satellites.....	70
Antisatellite Warfare.....	71
Additional Possibilities	71
Operations.....	72
SCREMAR Vehicle Concepts.....	74
Component Summary.....	76
5 Critical Technology Requirements.....	79
Cruise Phase Velocity Study: The Driving Force.....	79
Thermal Protection Systems	83
Conclusion	85
Bibliography	87

Illustrations

<i>Figure</i>	<i>Page</i>
1-1. Capabilities of the S ³ Hypersonic Weapons Platform.....	3
1-2. Standoff Capabilities of SHAAFT/SHMAC.....	8
1-3. Aerospace Roles and Missions Fulfilled by S ³	12
1-4. Schematic of Mated S ³ Platform (with SCREMAR).....	13
2-1. Zero-Stage Flying Wing.....	21
2-2. Conically Derived Waverider.....	23
2-3. Specific Impulse Variation.....	24
2-4. L/D Barrier for Waveriders.....	26
2-5. Supersonic/Hypersonic Attack Aircraft (SHAAFT).....	27
2-6. SHAAFT Sizing.....	28
3-1. Effective Ranges of the SHMAC.....	39
3-2. Standoff Hypersonic Missile with Attack Capability (SHMAC).....	42
3-3. Rocket/Dump Combustor Scramjet.....	44
3-4. High Speed Air Launched SHMAC Mission Profile.....	48
3-5. Low Speed Air Launched SHMAC Mission Profile.....	49
3-6. Surface Launched SHMAC Mission Profile.....	50
4-1. SCREMAR Performing Various On-Orbit Operations.....	69
4-2. Space Control with a Reusable Military Aircraft (SCREMAR).....	75

Tables

<i>Table</i>		<i>Page</i>
1	Density Values of Slush Hydrogen (All Values at Triple Point).....	25
2	Parameters Considered for the Supersonic/Hypersonic Attack Aircraft (SHAAFT) at Mach 8 Flight	81
3	Parameters Considered for the Supersonic/Hypersonic Attack Aircraft (SHAAFT) at Mach 12 Flight	82

Preface

In the Spring of 1995, Col Richard Szafranski (Air University, Maxwell Air Force Base) invited personnel from the US Air Force Academy to take part in the study: “2025.” Col Randy J. Stiles, who was acting chairman of the Department of Aeronautics (DFAN), suggested that a section of the senior design course be dedicated to the support of that study. Their role was instrumental to the birth of this project.

This study was accomplished by the cadets of a Senior Design Class (AE481Z and AE 482ZS) at the USAF Academy during the Academic Year 1995–1996. The authors of this report received numerous briefings from leaders of the aerospace community. Those who briefed the class at various times during the Academic Year 1995-1996 include:

John Bode, Sandia National Laboratories, Albuquerque, N.Mex 87185
Ramon Chase, principal, ANSER Corporation, Arlington, Va 22202
Chuck Eldred, head, Vehicle Analysis Branch, Langley Research Center, Hampton, Va 23681-0001
Col Jae Engelbrecht, professor, National Security Studies, Air University, Maxwell Air Force Base, Ala 36112
Harry Hillaker, Consultant (Member of USAF Scientific Advisory Board), Fort Worth, Tex 76116
Dr Jim Horkovich, senior engineer, Science Applications International Corporation (SAIC), Albuquerque, N.Mex 87106
Dr Hans Mark, professor, the University of Texas at Austin, Austin, Tex 78712
Lt Col Rich Moore, HyTech Program Office/WL, Wright-Patterson Air Force Base, Ohio 45433
Don Rondeau, Sandia National Laboratories, Albuquerque, N.Mex 87185
Maj Bert Schneider, Wright Laboratory, Eglin Air Force Base, Fla 32543
Don Stava, Flight Dynamics Directorate/WL, Wright-Patterson Air Force Base, Ohio 45433
Dr Jim Trolrier, technical director, Science Applications International Corporation (SAIC), Wayne, Pa 19087

In January 1996, the cadets traveled to the Wright Laboratory where they shared their ideas with and received briefings from: Val Dahlem, Peter Gord, Harry Karasopoulos, Don Stava, and Don Stull. They also received tours of the relevant research facilities at the Wright Laboratory. This exchange of information provided midcourse guidance to the project.

In April 1996, Dale Gay, Ron Kay, and Mary Dyster at the US Air Force Academy provided substantial graphical support that had a significant impact on the quality of the final product.

The authors would like to express their gratitude for all who gave of their time and of their talent to share their expertise. The visions they shared and the challenges they offered made significant contributions to the education of the cadet authors. The cadet authors and Dr Bertin thank you.

Executive Summary

Place yourself into the future, into the world of 2025. Where will our nation be and what adversaries will we face? Possibilities include a resurgent Russia, a hostile China, or possibly a hostile Korea or Iraq. What capabilities will opposing nations have to our military? One thing is for certain, all of these possible adversaries will have access to high technology weapons. What capabilities will we need to counter these potential adversaries?

To counter these problems, we have identified three broad missions that the United States (US) military must accomplish in 2025. First, we must have the ability to deliver accurate lethal blows before or at the onset of hostilities. Second, we must be able to sustain our fighting potential without a large support infrastructure and logistical footprint. Third, we must be able to provide a routine, reliable, and flexible access-to-space capability. Based upon these three missions, we feel that our best option is the use of hypersonics.

Proposed is an integrated weapons platform approach, the S^3 concept, which would accomplish these objectives. It involves three separate, but integrated, vehicles. These include the SHAAFT (supersonic/hypersonic attack aircraft), the SHMAC (standoff hypersonic missile with attack capabilities), and the SCREMAR (space control with a reusable military aircraft). SHAAFT, SHMAC, SCREMAR (S^3) can accomplish the broad roles of Global Reach/Global Power, in-theater dominance, and access to space.

The SHAAFT is a dual stage hypersonic aircraft that fulfills future requirements for Global Reach/Global Power. It is a mach 12 hypersonic aircraft that uses a “zero-stage” flying wing to stage at mach 3.5. It is designed for compatible use with a hypersonic missile, the SHMAC, and a transatmospheric (TAV) orbiter, the SCREMAR. These two components combine with the SHAAFT to form the S^3 concept and allow for the fulfillment of the in-theater dominance and access to space mission requirements, respectively.

The initial goal of this study was to investigate Air Force missions that are best accomplished by hypersonic vehicles and the technology required to support them. The identification of the three broad missions to be accomplished by military forces in the year 2025 led to the need for a hypersonic weapons platform. The diversity of these missions yielded a need for different platforms with different capabilities. However, with current military budget cuts and drawdowns, development of three different weapons systems is impractical. Instead, we opted for a

fresh approach based on previous studies and our own research that integrated the necessary features for accomplishment of these missions. The result was the S³ concept: a highly survivable, lethal integrated hypersonic weapons platform that allows the US to accomplish a diverse set of missions and is capable of deterring and/or punishing adversaries anywhere in the world.

Chapter 1

Overview of Proposed Integrated Weapons System

The clairvoyant who in 1996 gazes into a crystal ball with the intent of predicting the world of 2025 indeed faces daunting challenges. The economic, political, and military environment of the world is changing rapidly. Apparently, gone are the continued stress and tension associated with the confrontation between two superpowers. Gone also is the stability that resulted because the two superpowers developed alliances in which most of the other nation states of the world took a subservient role. Military strategists from one alliance could focus on a single adversary (or a single alliance of adversaries). Although regional military conflicts occurred, there was an absence of global conflict, since both of the superpowers recognized the substantial risks of MAD (mutually assured destruction).

Some vestiges of the cold war remain today (e. g., traditional alliances, such as the NATO alliance, continue to exist, albeit aiming for a membership expanded to include former adversaries). However, in addition to the traditional alliances, ad hoc alliances are developed in real time in response to regional conflicts, such as Operation Desert Storm, and to “internal” conflicts, such as the conflict in the Balkans. Rogue nations, no longer constrained by dependence on a superpower’s military aid or financial aid, follow confrontational policies which threaten the peace and security, both of a region and of the world. Whether it is the desire of Iraq to dominate a region of the world or the desire of North Korea to develop nuclear weapons, these rogue nations are less likely to consider the downside of aggressive actions, before initiating hostilities.

While the level of economic and of political constraint diminishes, the potential for destruction grows. The military strategist of the twenty-first century can expect that most adversaries—whether a relatively traditional alliance of nation states, a rogue nation using military hostilities as a tool of national policy, or an ethnic army from a fragmented country—will have weapons of considerable destructive power, speed, and range. Many countries have

nuclear weapons and other weapons of mass destruction (WMD). Theater missiles and high performance aircraft armed with sophisticated missile systems are available to all the countries of the world.

Thus, no matter what model one postulates to describe the world of 2025, it is very likely that the air and space forces of the United States (US) will have (at least) three broad roles in any conflict in 2025. They include

- (1) Deliver decisive blows at the outset of hostilities, with the goal of destroying the adversary's desire to fight a protracted war.
- (2) Deliver cost-effective weapons to defeat time-critical targets and to establish in-theater dominance, if a protracted war cannot be avoided.
- (3) Maintain flexible, readily accomplished access to space. (As will be noted subsequently, the access-to-space missions will also be conducted during peacetime to develop operational procedures should the transition to the pace of wartime operations be necessary.)

This paper proposes an integrated multistage weapon system, which is capable of performing a variety of missions, both strategic and tactical. The design of this weapon system would be based on technologies developed during a variety of previous and of existing programs. Furthermore, the design process would include consideration of mission planning activities, base operational support requirements, etc.

In addition to the three broad roles described above, the air and space forces of the United States of the twenty-first century will have many other tasks to perform, including: counter air, close air support, and air lift (including humanitarian relief). However, these missions are best accomplished by other air force assets, such as the F-15, the F-16, the C-17, or their twenty-first century replacements. The proposed weapons platform is designed to be a deterrent, used at the onset of hostilities to stop the war before it begins. In short, the SHAAFT, SHMAC, SCREMAR (S³) hypersonic weapons platform can deliver lethal blows quickly and without a large support infrastructure, is survivable with both the vehicle and the crew returning safely to their base in continental United States, and can provide routine, sustained access to space for a variety of scenarios.

Characterization of the Proposed Weapons System

The proposed weapon system is an integrated multistage system, which can perform all three roles defined previously, as indicated in figure 1-1. A two-stage configuration serves as the delivery system. The weapons delivery system includes (1) an unpiloted flying wing, which is used to accelerate the weapons system from the runway to a flight condition of mach 3.5 at approximately 60,000 feet and (2) a piloted, aerodynamically efficient, attack aircraft capable of sustained hypersonic flight, known as the supersonic/hypersonic attack aircraft (SHAAFT).

The SHAAFT cruises at a nominal mach number of 12 at approximately 100,000 feet. The SHAAFT could launch either: (1) a barrage of hypersonic cruise missiles (HCM), which could deliver massive firepower to multiple targets, or (2) a transatmospheric vehicle (TAV), which is capable of delivering new satellites to orbit, repairing existing satellites, or attacking the enemy's space assets. The cruise missiles will be referred to as standoff hypersonic missiles with attack capability (SHMAC) and the TAV will be part of Space Control with a Reusable Military Aircraft (SCREMAR). Since the hypersonic cruise missiles have a range of over 1,000 nautical miles, the attack aircraft can stand off from the targets, minimizing the risk of losing the delivery system and its crew. Piloted and unpiloted versions of the TAV are under consideration.

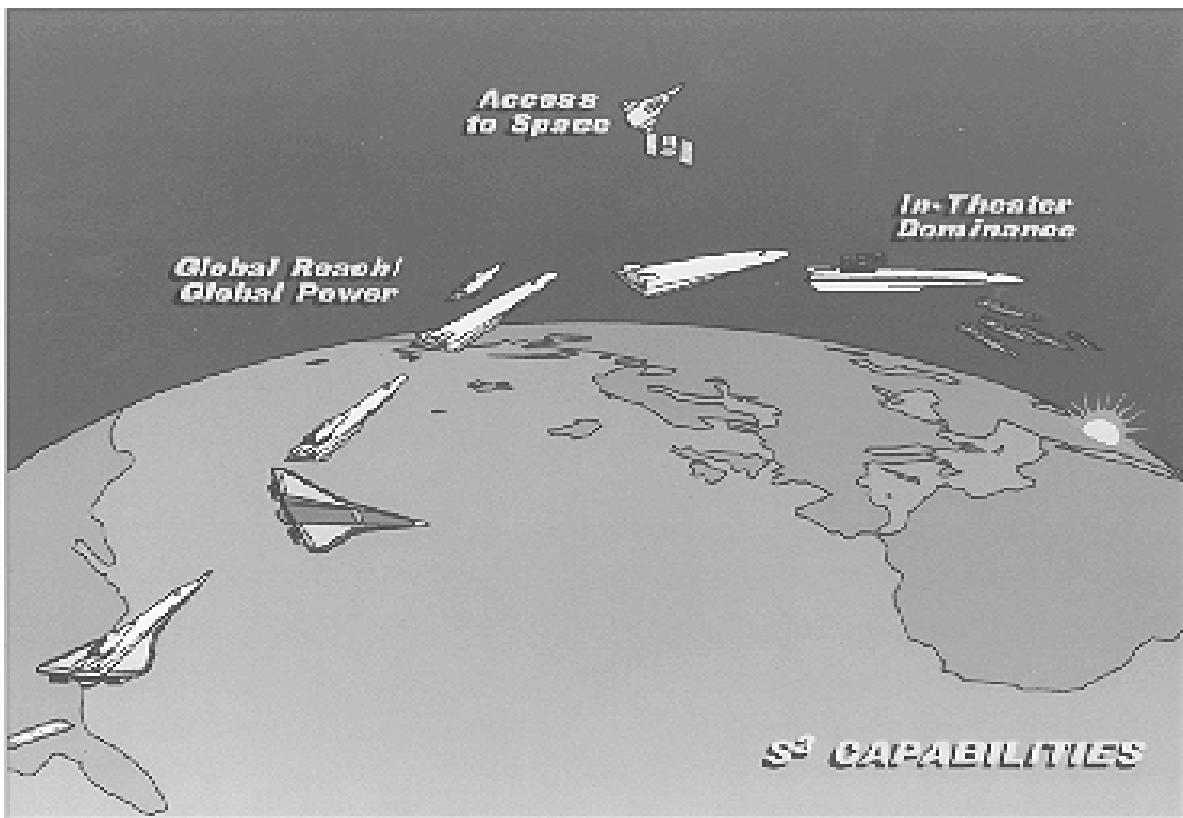

Figure 1-1. Capabilities of the S³ Hypersonic Weapons Platform.

Note that the SHAAFT is the only one of the four elements that definitely has a crew. For the proposed integrated multistage weapons platform, both the flying wing and the SHMAC should be designed as unpiloted aerospace vehicles (UAV). As noted in the previous paragraph, piloted and unpiloted versions of the TAV are under consideration. Thus, referring to figure 1-1, the reader can view the SHAAFT as a mobile control room wherein the personnel who deploy and control the myriad of UAVs in their arsenal are transported closer to the action. Thus,

using continually updated intelligence, the crew can make better use of the unpiloted assets by modifying the mission profile in real time.

The design of the two-stage delivery system would be such that the flying wing and the SHAAFT are capable of an unrefueled flight of 14,000 nautical miles. The elimination of the refueling requirement provides many benefits. First, the operational complexity required to support the mission is reduced. Second, by eliminating the prepositioning of tanker aircraft to refuel the weapons delivery system en route to the target, there is a considerable reduction of the communications-traffic/mission-signature that could alert the adversary of the impending mission. Third, the mission will cost less when tankers are not required. Finally, since there is no rendezvous with a tanker, it is easier to update the mission plan in response to intelligence updates. The integrated weapons system would operate from one of four bases within the continental United States (CONUS), essentially one at each corner of CONUS. By flying at hypersonic speeds, the attack aircraft (the SHAAFT) could reach any point in the world within approximately two to four hours. The exact mission duration depends on the mission routing and the exact speed range of the elements. Based on the present conceptual designs, the flying wing accomplishes the low-speed portion of the flight, from takeoff up to cruise at a mach number of 3.5, the SHAAFT cruises at mach 12 at which point the SCREMAR may stage or SHMACs may be launched, and the SHMAC flies at mach numbers up to eight.

Because there is no prepositioning of tankers to tip off the mission and because the elapsed flight time from take off from the CONUS base is relatively short, the adversary has very little response time. Furthermore, the SHAAFT operates at hypersonic speeds at high altitudes even when launching the SHMACs. Since the SHMACs, themselves, are standoff weapons with a range of over 1,000 nautical miles, the supersonic/hypersonic attack aircraft will not have to fly over heavily defended targets. Thus, it will be a very tough target for enemy defenses. The combination of hypersonic flight at high altitudes with standoff weapons makes the SHAAFT very survivable. The high altitudes and speeds also make it ideal to serve as a first stage to a small TAV. Thus, the weapons system would have the ability either (1) to deliver massive firepower to targets anywhere in the world from bases in the CONUS or (2) to provide reliable, routine, flexible access to space.

Beam weapons can affect the ability of the S³ system to successfully execute its mission. If the SHAAFT relies totally on external navigation inputs such as global positioning system (GPS) to accomplish its mission, an adversary with advanced space capabilities could attack those assets. Thus, the elements of the S³ system should have an onboard navigation capability. Laser weapons are currently under development to provide point defense against

theater missiles, such as the Scud. It is conceivable that powerful adversaries could develop beam weapons to intercept (at least some of) the incoming SHMACs. The development of the S³ system will have to consider such possible threats to the successful execution of its mission.

Features of the Elements of the Proposed Weapons System

—*The Flying Wing* The flying wing serves as a zero-stage, launch platform. The use of a flying wing, (incorporating many of the technologies developed for the high-speed civil transport (HSCT), to accomplish the initial acceleration of the weapons system provides many advantages, especially in relation to simplifying the design of the second stage vehicle, the SHAAFT. For the outbound leg, the crew of the SHAAFT would pilot the mated configuration. Once staging occurs and the SHAAFT is on the way to the target, the flying wing will return to its CONUS base as a UAV. The second-stage SHAAFT can be much lighter, since it does not have to carry the considerable weight of fuel required to accelerate the vehicle to a mach number of 3.5 and carry it to the 5,000-nautical miles point, where it stages. The landing gear assembly for the second-stage vehicle can be relatively small, since it needs only accommodate the relatively light weight of the vehicle at the end of the mission (and the potential ferry missions to be described subsequently). Furthermore, since staging occurs at mach 3.5, the second-stage vehicle will not need propulsion cycles that operate efficiently at low speeds. However, such a decision means that the SHAAFT will land unpowered (as does the Space Shuttle Orbiter).

—*Global Reach/Global Power* Based on the computations presented in the proceedings from the Wave Rider Conference and reproduced in our research, a vehicle capable of flying at mach 12 would be capable of reaching any point on earth within two hours.¹ Furthermore, to accomplish the objective of *Global Reach, Global Power*, the second-stage vehicle should be capable of 14,000 miles of unrefueled flight at a mach number of eight or of 12. The second-stage vehicle, a SHAAFT would be an aerothermodynamically efficient design incorporating technologies developed during the National Aerospace Plane (NASP) program and for waverider designs. The SHAAFT would deliver multiple SHMACs without slowing down. Thus, the entire mission would be accomplished at hypersonic speeds, greatly increasing the survivability of the SHAAFT and its crew. Furthermore, the SHMACs themselves would fly hypersonically to targets at a range of over 1,000 nm. Launching the SHMACs, which are HCMs, from a flight path which keeps the SHAAFT well away from heavily defended areas, further enhances the survivability of the weapons system. The ability to deliver a decisive suite of weapons to any point on earth within hours provides a

permanent “presence” that does not require constant forward deployment of the United States’ armed forces. The short time required to execute the operation will catch the adversary by surprise before critical elements of the opponents military strategy can be deployed or protected. Potential targets for the SHAAFT/SHMAC weapons systems include the adversary’s space access complex, command and control centers, and other assets critical to the conduct of warfare in the twenty-first century. It is believed that the massive, sudden, and unexpected application of force on the first day of conflict will eliminate the opponent’s desire and capability to wage war.

—*In-Theater Dominance* In addition to serving as the weapons to be launched from the SHAAFT, the hypersonic cruise missiles would have many uses in the case of protracted hostilities. The SHMACs would be sized so that two could be carried by and launched from an F-15E or from other conventional aircraft. Because the SHMAC has a range of over 1,000 nautical miles, the F-15E would be able to remain well out of the range of most defense systems. Furthermore, the hypersonic capabilities of the SHMAC accommodate its use against time critical, moving targets (e. g., mobile launchers, tank formations, etc.). Since the SHMACs would be launched from the (conventional) carrier aircraft at high subsonic speeds at an altitude of 35,000 feet, additional power would be required to accelerate the missile to hypersonic speeds and high altitudes (i. e., essentially the initial conditions from which the SHMACs are launched from the SHAAFT). As will be discussed in chapter 3 on the design characteristics of the SHMAC, the initial acceleration from the subsonic speeds associated with a conventional aircraft launch would be accomplished by a rocket located within the dual-mode ramjet/scramjet combustor flowpath. After the rocket fuel has been expended, the rocket casing is ejected, leaving a clean flowpath.

Since the SHMAC is to be a weapon that would be launched from conventional aircraft and, therefore, to be deployed to forward bases around the world, simplicity of operations is a driving factor in the design of this weapon. The handling of cryogenic fuels under these conditions was believed to introduce undesirable operational complexities and expense. Therefore, since the maximum mach number associated with the use of endothermic hydrocarbon fuels is eight, that established the maximum flight mach number for this weapon.

—*Access to Space* Should the objective of a very short war not be achieved, the weapons described in the previous paragraphs can play significant roles in the military strategy for a protracted war. In this case, any nation that possesses the ability to launch nuclear weapons into space poses a serious threat to the command control, communications, and intelligence (C³I) operations of our armed forces. A relatively small orbiter—roughly similar in size to the Black Horse or to an F-15 could replace the HCMs carried as the payload for the SHAAFT.² Using

multistage concepts similar to the Beta³ or the Saenger,⁴ the flying wing and the SHAAFT would deliver the orbiter to efficient initial conditions for its “*Access-to-Space*” mission. The multiple-stage system would provide flexible access to space from conventional military runways, which would be a most valuable characteristic in the event that the adversary had destroyed the facilities at Cape Canaveral and at Vandenberg. Using rocket propulsion and aerodynamic forces to achieve the desired orbits, the SCREMAR would be able to place as many as three to four satellites (nominally six feet by six feet by six feet and weighing 1,000 pounds) into low earth orbit (LEO). The same TAV could also be configured to repair satellites on-orbit as well as perform sophisticated antisatellite (ASAT) missions.

Utilization of the Proposed Weapons System

The proposed integrated multistage weapons system is capable of performing a variety of missions, both strategic and tactical. Consider the scenario where an adversary threatens to invade (the threat may include nuclear blackmail) or has just invaded a neighbor state. Based on recent headlines, the adversary in this scenario could be Iraq or North Korea. Future headlines might include China or a resurgent Russia. Despite negotiations at the highest levels, the adversary shows no signs of backing down or retreating from the occupied territory. Plans are made for a mission that would strike at the key war-fighting infrastructure of the adversary. The targets include the command, control, communications, computer center(s), the space launch facilities, critical supply depots, massed formations of enemy tanks, etc. An ultimatum from the president of the United States suggests that, if the enemy does not act responsibly, massive force will be applied, suddenly and without further warning. Authority is given to plan a mission that would seriously damage the adversary’s ability and will to fight.

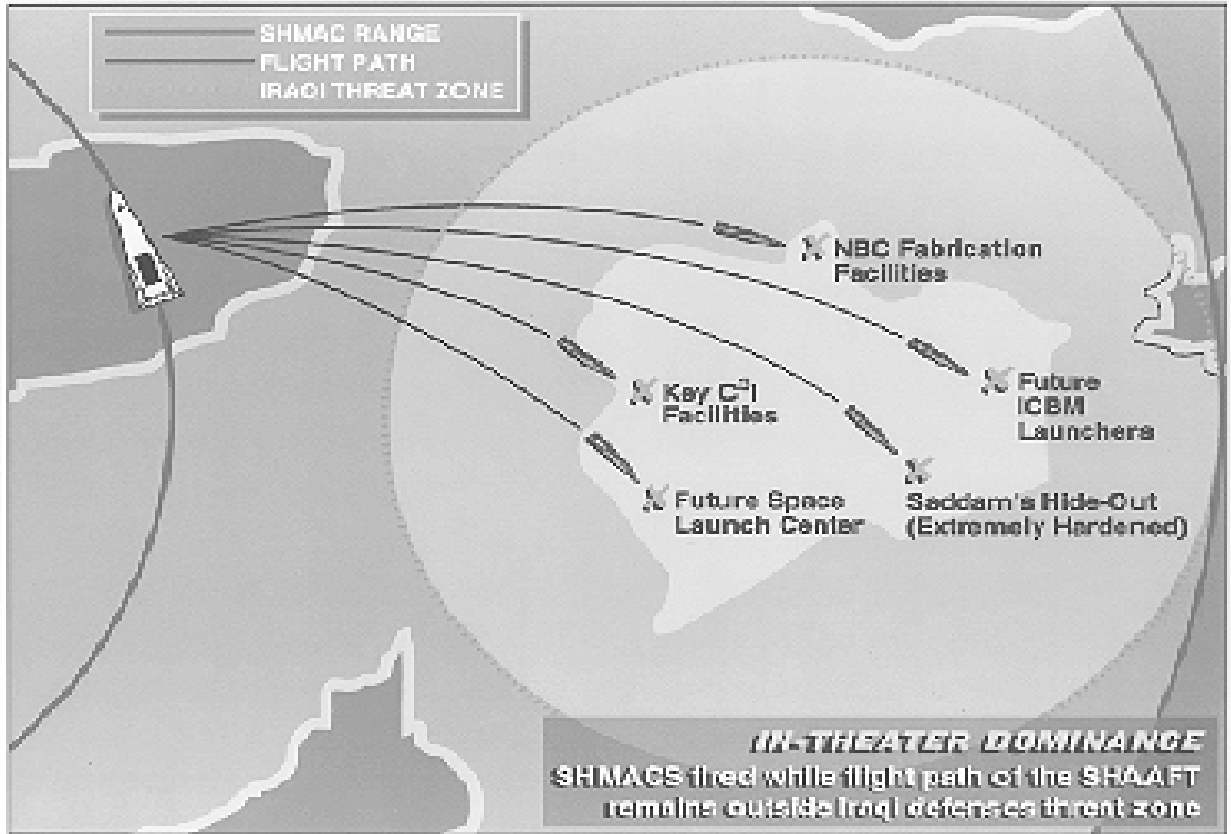

Figure 1-2. Standoff Capabilities of SHAAFT/SHMAC.

The next day the mission is launched. One to four SHAAFT weapons systems are launched. The number depends on the size of the adversary (specifically, the number of and distance between the targets) and the operational philosophy (whether the mission objectives include total destruction of the enemy's war-fighting capabilities or merely a very strong attention-getting strike at selected targets). The range of the "zero" stage, the flying wing, allows it to take the attack aircraft approximately halfway to the target (for purposes of discussion, 5,000 nautical miles). Staging occurs at mach 3.5 at an altitude of approximately 60,000 feet. The supersonic/hypersonic attack aircraft, the SHAAFT climbs to approximately 100,000 feet, where it flies at a mach number of approximately 12. Soon after staging from the flying wing, the crew of the SHAAFT is given final instructions: continue on to the target and execute the full-scale operation, continue on to the target and execute a modified plan (change the targets or change the degree of destruction), or abort the mission altogether. The fact that the SHAAFT is a crewed vehicle provides a great deal of flexibility. Assuming that the instructions are to continue the mission, the SHAAFT proceeds to the area where the SHMACs are to be launched. Since the SHMACs have a range of over 1,000 nautical miles, the launch point, which is 10,000 nautical miles from the SHAAFT's home base, may not even be over the hostile country. To see an example

of the standoff capability of the SHAAFT/SHMAC weapon system, refer to figure 1-2. Without slowing down, the SHAAFT launches a barrage of SHMACs from a point well out the enemy's threat zone. Since the SHAAFT does not slow from its cruise mach number of 12, the SHMACs will decelerate to their design cruise mach number of eight. The SHMACs themselves may strike the target or they may deploy submunitions, which further prioritize and diversify the targeting philosophy. The suite of weapons may be nuclear, conventional, or ray devices.

Having delivered massive firepower to the targets, the next consideration is the safe recovery of the SHAAFT. The optimum scenario would have the SHAAFT return to its CONUS base. However, if there is not sufficient fuel to reach the CONUS, the SHAAFT would proceed to an alternate, preselected recovery base. Depending on the mission, Hawaii or Diego Garcia seem natural selections for the non-CONUS recovery base. The recovery base will be within the 14,000 nm overall mission capability of the flying wing/SHAAFT. Once it releases the SHAAFT, the flying wing would proceed directly to Hawaii or Diego Garcia, where it would await the SHAAFT to complete its mission.

Procedures by which the SHAAFT returns safely to its CONUS base from other recovery bases, such as Diego Garcia, will be evaluated through further study. One possibility is sending a flying wing to retrieve the SHAAFT. The mated configuration would be flown home using the engines of the "zero" stage, the flying wing, and fuel added at the recovery base. Fuel and supplies would be brought to this base so that the SHAAFT could be serviced for its flight back to its home base in the CONUS. Because the technology base for the flying wing is that of the HSCT, the logistics infrastructure at the alternate recovery bases is relatively conventional.

Considerable savings can be realized through the elimination of the constant forward deployment of the more conventional forces to provide a "presence" of US armed forces. For those regions of the world where our forces do not have a permanent physical presence, the deployment of forces for a regional conflict is a very expensive and time-consuming project. Recall that Desert Shield took longer than Desert Storm. Furthermore, it is not likely that a future adversary will leave in place a near-by base infrastructure and then allow us the luxury of several months to build up our forces in the region. The savings described in the previous sentences could pay for most, if not all, of the design and of the development costs for the proposed, integrated hypersonic weapons system. The total fleet would consist of (approximately) five vehicles, deployed from four bases in the CONUS, two on each coast. By having an integrated weapons system strategy, the cost of the technology programs required to design and to develop the system would be greatly reduced. Furthermore, technology programs relevant to the various elements of this integrated weapons system

(the flying wing, the supersonic/hypersonic attack aircraft, space control with a reusable military aircraft, and the standoff hypersonic missile with attack capability) have been in various stages of development for more than a decade.

Consider next the application, where the weapons delivery system (the flying wing and the SHAAFT) would serve as the first stage of a multi-stage access-to-space system. A transatmospheric vehicle would replace the SHMACs as the payload carried by the weapons delivery system. In a mission concept similar to that of the Beta System⁵ or to that of the Saenger,⁶ the two elements of the first stage would carry the TAV/orbiter to its launch point. Although the exact conditions for launch of the TAV/orbiter would be the subject of design trade studies, obtaining a high speed for staging appears to be more important than obtaining a high altitude.⁷ Preliminary calculations indicate that the orbiter would be lighter or the payload would be greater, if staging occurred at mach 12. Since the proposed system is to be an integrated, multipurpose weapons system, the results of the staging trade studies will influence decisions relating to the maximum velocity capabilities of the SHAAFT (in addition to the constraints placed on the SHAAFT as a result of its mission as the delivery system for the SHMACs).

It is assumed that the armed forces of the United States will have a constellation of satellites (on the order of hundreds) in place at the outbreak of hostilities. Using a variety of launch vehicles, these satellites (some large, others small) will have been placed in space over the years, as part of an evolving, strategic military strategy. However, at the outbreak of hostilities, the military leaders identify the need for additional satellites (perhaps to fill a gap in coverage, to provide additional information using special sensors, etc.) or the need to repair existing satellites. The situation becomes more critical if our adversary has disabled and/or destroyed a considerable fraction of our satellites. The armed forces of the United States have become very dependent on military/commercial satellites for communication and reconnaissance and are becoming increasingly dependent on other systems, such as GPS and Milstar. The elimination of a significant fraction of these assets by an enemy would paralyze our C³I. Rapid replenishment of lost assets is critical to the successful execution of our military operations. The flying-wing/SHAAFT combinations take the TAV/orbiter to mach numbers near 12 at 100,000 feet, where it stages. The TAV is a rocket-powered vehicle, approximately the size of an F-15, capable of carrying three or four small satellites (6 feet x 6 feet x 6 feet, weighing 1,000 pounds) into LEO. Thus, after a handful of missions, the country's military leaders could have a minimum of a dozen new satellites in place within days of the outbreak of hostilities. These satellites would provide communication links, intelligence information, etc.

It is envisioned that the flying-wing/SHAAFT/SCREMAR system would be routinely used during peacetime to place military satellites in space, to repair and to reposition existing military satellites, etc. This would be done to develop mission planning and operational experience, so that our armed forces could easily shift to the wartime pace of operations in the event that hostilities cannot be avoided.

Furthermore, the TAV/orbiter of the SCREMAR could perform the ASAT role should our adversary also have significant space assets. Finally, once sufficient technology for the TAV/orbiter is developed, it could be modified to fulfill other missions: it could deliver weapons in a strategic attack on the enemy for a suborbital profile or serve as a space-based laser (SBL) or airborne laser (ABL) weapons platform.

It is quite possible that, despite the severity of the strike described in previous paragraphs, the enemy will choose to continue to fight a war. One enemy may view the conflict as a Holy War and would consider early surrender unthinkable. Another enemy may have the resources (large population and widely scattered assets) to absorb such a blow and continue the fight. A third possible scenario would be the case where the United States was confronted with two Regional Conflicts and the strike described above would be used to eliminate one enemy, allowing us to focus on the other. In each case, our forces are involved in a protracted war.

For the protracted war, the elements of the integrated weapons system could serve as significant elements of our arsenal. For instance, in addition to serving as the weapons to be launched from the SHAAFT, the hypersonic cruise missiles would have many uses in the case of protracted hostilities. The SHMACs would be sized so that two could be carried by and launched from an F-15E or some other conventional aircraft. Because the SHMAC has a range of over 1,000 nautical miles, the F-15E would be able to remain well out of the range of most defense systems. Furthermore, the hypersonic capabilities of the SHMAC accommodate its use against time critical, moving targets (e. g., mobile launchers, tank formations, etc.).

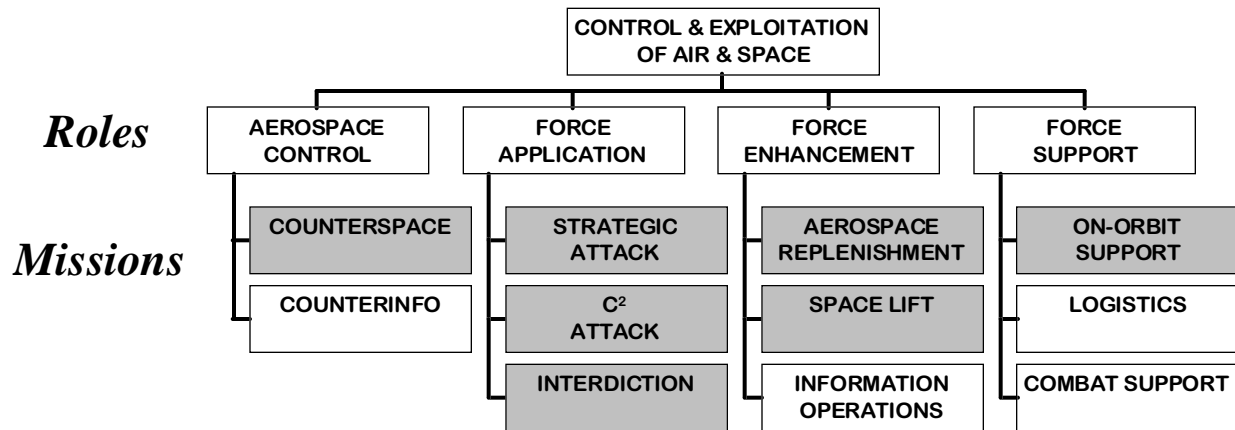

Figure 1-3. Aerospace Roles and Missions Fulfilled by S³.

Indicated in figure 1-3 are some of the basic aerospace roles and missions that can be performed by the S³ integrated weapons system. The missions that the S³ can accomplish by itself are highlighted in gray boxes while other missions that are fulfilled as a result of the capabilities of the S³ are indicated in plain boxes. A schematic of the fully mated S³ concept can be seen in figure 1-4. The integrated weapons system that has been described can perform counterspace tasks for aerospace control, tasks of strategic attack, of C² attack, and of interdiction for force application, aerospace replenishment and space lift tasks for force enhancement, and on-orbit support for force support. It is an integrated hypersonic weapons platform capable of accomplishing a diverse set of missions in a variety of situations.

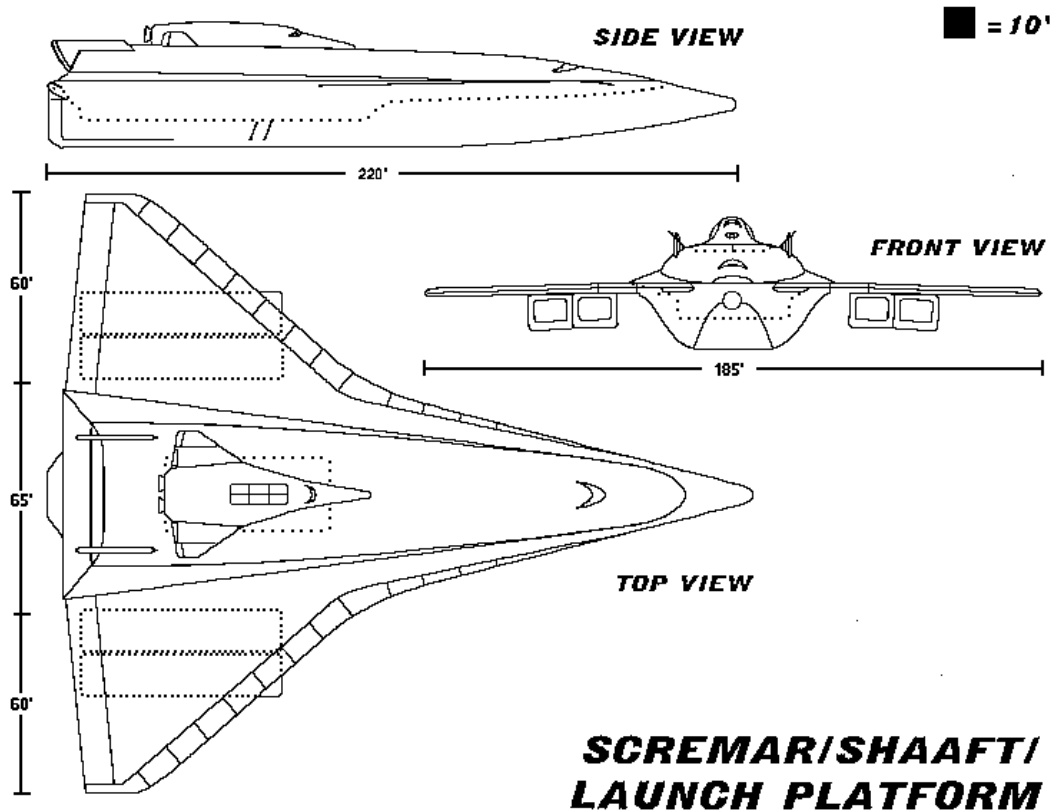

Figure 1-4. Schematic of Mated S³ Platform (with SCREMAR).

Technology Considerations

Numerous technological challenges will have to be met before the proposed integrated, multistage weapons system can be built. However, none of these challenges presupposes that a breakthrough in technology is an enabling requirement. The zeroth-stage flying wing is a UAV with a maximum mach number of 3.5. While that is slightly above the mach number for the current high-speed civil transport design, it should not be difficult to solve the problems unique to this application, given that the proposed system would be fielded in the twenty-first century.

The design of the SHAAFT offers the greatest challenges because there exist no vehicles that have flown at sustained hypersonic speeds while powered by an airbreathing system. Furthermore, the aircraft should have global range with a payload of approximately 50,000 pounds. The use of a flying wing to transport the SHAAFT to the one-third point of its global range mission at a mach number of 3.5 greatly simplifies the design of the SHAAFT. Considerable weight savings occur because the flying wing will carry the fuel required for takeoff, acceleration, and

flight to the one-third point. The SHAAFT won't need heavy landing gear to support the takeoff weight. Furthermore, it does not need a zero-speed or a low-speed propulsion system. It appears that a dual-mode ramjet/scramjet combustor⁸ could be used to accelerate the vehicle from mach 3.5 to its cruise mach number of eight or of 12 and to sustain flight in this speed range. The decision as to whether to limit the vehicle design to mach 8 flight or to extend its capabilities to mach 12 flight is dominated by the propulsion system. Assuming reasonable development of the technologies of hypersonic-airbreathing propulsion systems and their fuels, it is assumed that mach 8 is the upper limit for the use of endothermic hydrocarbon fuels. One will need cryogenic fuels to extend the maximum cruise speed to mach 12. Some of the pros and cons of this problem are presented in the *Critical Technology Requirements* chapter, tables 5-1 and 5-2. Based on the survivability and on the range of the SHAAFT as a weapons platform for delivering SHMACs and as the initial stages for the SCREMAR, mach 12 flight would probably be preferred. Based on considerations relating to ground operations and support, especially if a recovery base is needed as an intermediate host, the endothermic fuels support a decision to limit the vehicle to a maximum mach number of eight. In any case, a serious trade study (including the effect on the design of the TAV/orbiter and its payload) should be conducted at the outset of the SHAAFT program.

An aerothermodynamically efficient vehicle having a hypersonic lift-to-drag ratio of five, or better, will be a long, slender body with relatively small leading-edge radii (the nose radius, the cowl radius, and the wing leading-edge radius). Thus, the heating rates in these regions will be relatively high. Controlling the vehicle weight will have a high priority. Therefore, the development of high-strength, lightweight materials and the ability to efficiently use them for the load-carrying structure and for the thermal protection system are high-priority items. Researchers at the National Aeronautics and Space Administration's Ames Research Center (NASA) are developing advanced Diboride Ceramic Matrix Composites (CMC), including Zirconium Diboride and Hafnium Diboride materials which are reportedly able to withstand repeated exposure to temperatures of 3660 degrees fahrenheit and of 4,130 degrees fahrenheit, respectively. Materials for thermal protection systems developed for Shuttle derivatives, for the NASP, for the X-33, and for the X-34 should be reviewed for use in the proposed weapons system.

Major problems facing the aerothermodynamicist include the determination of boundary-layer transition criteria and the complex viscous/inviscid interaction associated with the multiple shock waves that occur, when the payloads (either the SHMACs or the SCREMAR) are released from the SHAAFT. The problem of developing boundary-layer transition criteria challenged the developers of the first reentry vehicles; it challenged the developers of the NASP;

and it will challenge the developers of the SHAAFT. In the end, most likely, a criteria will be selected (with a degree of conservatism appropriate to the acceptable risk) and the design will proceed. The problem of shock/shock interactions associated with two objects flying in close proximity at hypersonic should be solvable. Some work has already been done, for on the staging of the Saenger.⁹

The decision to limit the SHMAC to a maximum flight mach number of eight was straight forward. Since a variant of the SHMACs will be launched from conventional aircraft, such as the F-22 or the F-15E, simplicity of ground operations, of fuel handling, and of weapons loading at forward bases dictates against cryogenic fuels. By limiting the SHMAC to a maximum mach number of eight, hydrocarbon fuels can be used. Use of hydrocarbon fuels instead of cryogenics greatly simplifies in-theater logistics, ground-support operations, and training requirements for base personnel. However, the SHMAC design must accommodate the transient loads associated with the short-duration overspeed when being launched from the SHAAFT.

Technology developments will be needed in the areas of guidance, navigation, and control (GN&C) and sensors for both the SHAAFT and SHMAC. Large changes in weight and in weight distribution will occur during the flight of the SHAAFT. Control of an aircraft flying at hypersonic speeds over great ranges requires advances in the state of the art. Collection and interpretation of data (threats, targets, political considerations at the brink of war) and decisions as to how to react must be continuously incorporated into the mission plan.

The design of the TAV/orbiter, a.k.a. the SCREMAR, should make use of the large number of access-to-space programs continuing around the world, including international programs, such as, the Japanese HOPE, as well as US programs, such as the X-33, the X-34, and the XCRV (currently under development at NASA). Since the SCREMAR is all rocket powered and operates in a similar manner as the Space Shuttle once separated from the SHAAFT, it should use as much of the current technology incorporated by the Space Shuttle as possible.

The technology programs used to develop the SHAAFT can be transferred directly to the SHMAC and SCREMAR, and vice versa. This is another application of the term *integrated* weapons system. The development of the S³ concept as a single weapons platform with several similar and fully compatible vehicles will be much easier on the technology demands as well the development costs than attempting to fulfill the same roles with different weapons systems.

- ¹ I. M. Blankson, J.D. Anderson, M. Lewis, and S. Corda, "Air Breathing Hypersonic Waveriders: A Survey of Research Needs," Proceeding from the Wave Rider Conference, University of Maryland, 1993.
- ² R. M. Zubrin and M. B. Clapp, "An Examination of the Feasibility of Winged SSTO Vehicles Utilizing Aerial Propellant Transfer," AIA 94-2923, 30th Joint AIAA/ASME/SAE/ASEE Joint Propulsion Conference, Indianapolis, Indiana, June 1994.
- ³ P. R. Gord, K.J. Langan, and M.E. Stringer, "Advanced Launch Vehicle Configurations and Performance Trades," Paper from AGARD Conference Proceedings No. 489, Space Vehicle Flight Mechanics.
- ⁴ E. Hoegenauer and D. Koelle, "Saenger, the German Aerospace Vehicle Program," AIA-89-5007, AIAA First National Aero-Space Plane Conference, Dayton, Ohio, July 1989.
- ⁵ Gord, Langan, and Stringer.
- ⁶ Hoegenauer and Koelle.
- ⁷ G. Moore, private discussion, February 1996.
- ⁸ E. T. Curran, W. H. Heiser, and D. T. Pratt, "Fluid Phenomena in Scramjet Combustion Systems, *Annual Review of Fluid Mechanics*, 28, 1996, 323–360.
- ⁹ W. Schroeder, G. Hartmann, "Analysis of Inviscid and Viscous Hypersonic Flow past a Two-Stage Spacecraft," *Journal of Spacecraft and Rockets* 30, no. 1 January–February.

Chapter 2

Supersonic/Hypersonic Attack Aircraft (SHAAFT)

The SHAAFT (Supersonic/Hypersonic Attack Aircraft) is an airborne weapons system designed for operational use in the year 2025. It is capable of putting munitions on target, anywhere in the world, within four hours after takeoff. It is a direct result of the defined mission requirements of Global Reach/Global Power and specifically, Global Force Projection. The SHAAFT can fight and win two major regional conflicts simultaneously. It also complies with the current force draw down in which the majority of all US military forces will be based in the continental United States (CONUS). Flight line operations would require cryogenic support for the fuel needs of SHAAFT. It cruises to and from the target at mach 12 and at 100,000 feet. It is a completely reusable vehicle, like most USAF aircraft. The SHAAFT will deploy various weapons to destroy nearly any type of essential enemy target, dependent on real-time battlefield information or existing intelligence data to destroy targets. The SHAAFT will also serve as the base component to accomplishing in-theater dominance with the SHMAC and access to space with the SCREMAR.

The goal of the SHAAFT is to cause enough destruction and chaos in the first hours of a conflict such that the enemy realizes war is a futile choice. The enemy is then crippled and nearly defenseless against subsequent attacks from conventional forces in a protracted war. It would also serve as an extremely effective deterrent force, since the enemy would know that any military movement could be utterly upset if not completely destroyed within a matter of hours from its discovery. But unlike conventional aircraft, the hypersonic flight regime makes SHAAFT a difficult, and therefore highly survivable, target.

A hypothetical attack scheme consists of five SHAAFTs, dispensing nearly 50 hypersonic, precision strike, cruise missiles, for example, SHMACs. These would hit vital targets such as command, control, and communications

facilities (C³I network), power centers, transportation hubs, and potential space launch complexes. This attack alone would not cripple an advanced country's war machine, but it would severely disrupt their war-fighting operations to the point that they are no longer able to immediately continue any operations. Within hours of the initiation of hostilities, the enemy's infrastructure would be in shambles with their ground forces unable to communicate, maneuver, or fight a coordinated battle. The hostiles would then be unable to defend themselves against conventional military forces.

In the event that an enemy is able to perform some form of ASAT warfare, the SHAAFT would also serve as a staging vehicle for the SCREMAR reusable access to space vehicle. The SHAAFT/SCREMAR combination could be used to repair and replace damaged satellites. The system would be used in peacetime for routine replacement and replenishment of satellites, which would also produce operational experience that could be adapted to a critical wartime situation.

General Mission Requirements

CONUS Basing

The reasons for avoidance of overseas basing are extremely important. The SHAAFT, incorporating hypersonic technology, will be costly. Thus, few would ever be produced. This craft is essentially a "golden bullet" that will aid the United States (US) in deterring conflicts, or if that fails, to win a war, hopefully in a short period of time.

Overseas basing provides the advantage of reduced range. But with shrinking defense budgets, such basing can no longer be relied upon. The security and stability of these foreign assets cannot be guaranteed in the year 2025. Basing the SHAAFT at large CONUS bases would enable a secure area in which to operate for years. Bases would be chosen such that infrastructure and geographic positioning could best support the hypersonic mission.

Cost-Saving

CONUS basing of the SHAAFT allows for security and stability in aircraft maintenance. But keeping the mission of global reach/global power restricted to one aircraft saves a great deal of money. That is, the logistics

usually required to maintain a fleet of attack aircraft are extensive and time-consuming, utilizing precious resources that could be saved.

The SHAAFT attempts to eliminate the swarms of tankers, airlifters, and support personnel that are normally required to sustain overseas operations. This aircraft takes off, deploys munitions, and returns, without refueling. Therefore, the SHAAFT saves money by reducing the logistics footprint required. It could save more money by stopping a war that would certainly cost billions. Had Desert Storm been prevented by a preemptive strike with well-placed munitions, the US could have saved many dollars in hardware and, more importantly, saved lives.

Hypersonic Requirement

The reasons that the SHAAFT must go hypersonic match the new face of warfare. It must make nearly instantaneous attacks while hiding under the cloak of survivability. If this attack aircraft travels at mach 12 and 100,000 feet, it is improbable that 2025-era enemy technology would be able to overtake it. Considering the amount of time that it would take to detect, track, identify, and then launch an interceptor that must climb to 100,000 feet and then overtake the SHAAFT, the chances of losing the SHAAFT to an interceptor or surfaced launched missiles are next to impossible.

The SHAAFT would launch SHMAC missiles hundreds of miles from the hostile airspace of the enemy. Such a standoff attack would provide several layers of defense to the SHAAFT. First, the cruising velocity and altitude are unmatched by any current aircraft. Also, it is improbable that future adversaries would have the research and technology base to attain this envelope, although not impossible. Second, the aircraft never passes over a threat area. Enemy forces would undoubtedly see the SHAAFT coming, but a counterattack would have to occur far from their home base. Combined with the speed of the SHAAFT, the enemy force now has to fly a long way to intercept. Third, hypersonic cruise missiles like the SHMAC increases the synergy of the attack. These three layers of defense provide extensive protection against enemy forces.

The SHAAFT also serves as the staging vehicle for the SCREMAR. The achieve orbit, a transatmospheric vehicle (TAV), such as the SCREMAR, has to produce a large velocity change typically on the order of 25,000 feet per second for a LEO. The greater the velocity provided by the staging vehicle, the less the TAV/orbiter has to produce on its own, thus resulting in a smaller size or greater payload for the TAV. The overall effects of having the SHAAFT fly at different hypersonic speeds (i.e., mach 8 versus mach 12, are covered in greater detail in chapter 5.

Range

Because of CONUS basing, the SHAAFT would require a large range. Because of the unusual flight regime and cryogenic fuels, tanker aircraft would be of little support (unless an entirely new tanker fleet were developed, which, under current budgetary constraints, is not foreseeable). Depending on the enemy, the SHAAFT can attain a range of 14,000 nautical miles.

This large range requires a vehicle that is aerothermodynamically designed for a high lift-to-drag ratio. The range is directly related to the mach number—the faster the flight velocity, the farther the range. This range also includes the turning radius. At mach 12, the radius of a 2-g turn is 480 statute miles. The equivalent turn diameter equals about half the width of the US. Such a turn would take approximately 23 minutes, requiring long-term straining maneuvers of the pilot.

Payloads

Pay load concerns include both the weight and volume. The SHAAFT is designed to carry a payload of 50,000 pounds. If the SHAAFT carries 10 cruise missiles at 4,000 pounds each, that leaves 10,000 pounds for pylons and supporting hardware on the aircraft. Furthermore, the SHAAFT is designed to carry an orbital vehicle. For instance, the SCREMAR, would be placed into low-earth orbit, requiring the volume of a light F-15.

SHAAFT Vehicle Concepts

The “Zero-Stage” Flying Wing

Because the SHAAFT will be taking off from conventional runways and operating across such a huge airspeed spectrum, the design team will have numerous challenges to overcome. How will an aircraft configured to cruise at mach 12 take off from a runway and remain airborne at low speeds? These two speed regimes demand completely different wings, propulsion systems, and fuel systems. If the SHAAFT were to use turbofans for takeoff, then switch to ramjets, and then scramjets for hypersonic cruise, it would have to carry thousands of pounds of extra weight in the form of inert turbofan engines.

To overcome this problem, a two-stage vehicle is proposed. The “zero-stage” is an unmanned launch platform upon which the SHAAFT attack vehicle will achieve flow conditions conducive to ramjet operation (figure 2-1). The purpose of the launch platform is to lift the SHAAFT off of a conventional runway, then accelerate it to mach 3.5 at 65,000 feet. At this point, the SHAAFT will be able to ignite its dual-mode ramjet/scramjet engines, separate from the launch platform, and accelerate up to mach 12 and 100,000 feet. The launch platform will then return to base and accomplish a fully automated landing.

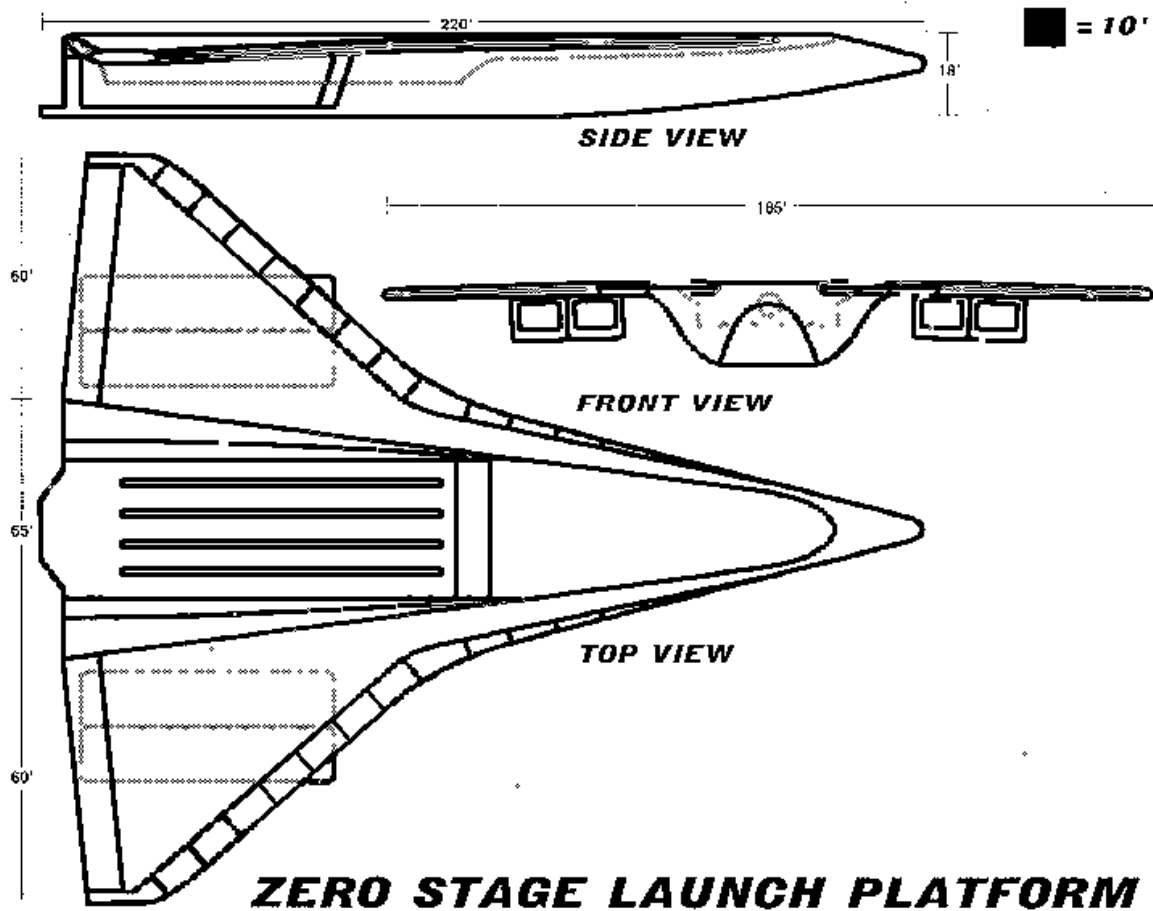

Figure 2-1. Zero-Stage Flying Wing.

The concept of developing two independent aircraft seems extremely expensive in that two technologically advanced platforms must be produced. The SHAAFT will carry a substantial price tag, but the launch platform will be relatively inexpensive and will actually save large sums of money. A large majority of an airplane’s cost comes from development and research. The technology to build the zero stage has already been developed (at least partially)

in such aircraft as the high-speed civil transport (HSCT) and operational aircraft such as the Concorde. In addition, its mission is so narrow and specific that it will not require complex systems and components.

The zero stage will be required to accelerate down a long runway (no short field capability required), lift off without the use of complex lifting devices, accelerate straight ahead to mach 3.5, release the SHAAFT, and then return to base. It must carry enough fuel for a radius of 5,000 miles at the higher mach number. It will not perform any demanding maneuvers or be subject to aeromechanically exhaustive flight regimes. Because of these limited demands, the launch platform will not incur large development or production costs. Furthermore, it greatly simplifies the design of the cruiser and dramatically reduces its size requirements.

Current design proposals consist of the following configuration, as studied by the National Aeronautics and Space Administration's (NASA) Boeing HSCT Study in 1989.¹ The proposed design is similar in platform to the HSCT, powered by six afterburning turbofans, each producing 50,000 pounds of thrust. A delta wing with a span of 160 feet and an area of 6,370 square feet would be able to take off with a gross weight of 2,000,000 pounds at 290 mph and a lift coefficient of 1.5.

It is essential that the SHAAFT be able to return to its home base or another SHAAFT-equipped recovery base. In order to do this, it will have to be able to land on a conventional runway. When it returns from a mission it will be much lighter than when it took off, having burned thousands of pounds of fuel. (The weight of the fuel is more than any other component on the aircraft, including structures and propulsion.) However, due to its aerodynamically configured shape, it will have to land extremely fast. It will need the assistance of a parachute braking system to slow down. Each SHAAFT would possess its own zero-stage vehicle, along with one extra for sustained operations through any contingency, in order to allow all five SHAAFTs to launch at once.

SHAAFT Design

Sizing and building the SHAAFT design will be the most difficult process. In this section, attempts to size the vehicle were made to fulfill mission requirements. The first step in deriving a platform involved the aerodynamic forces and how to use them to come up with a vehicle. The second step involved simple lift, drag, thrust, and weight trade studies to derive a generic design for the 14,000-mile journey to enemy territory and back. The third step verifies vehicle size using the Breguet range equation.

A unique phenomenon of high mach number flight is the effect of shock interaction. The nose of the SHAAFT would create a conical shock around the body; such a shock results in significant pressure drag and must be overcome by propulsion systems. If the lower portion of the SHAAFT could keep the outer wing tips even slightly attached to the bottom portion of the conical shock, then the resulting total pressure on the bottom of the wing would be much higher than the top. This is the basic idea behind a waverider. The effect of the waverider can be modeled mathematically. If the bottom of the vehicle follows the same pattern as the stream lines of air, then it can be drawn as attached to the shock, as was done in a study by Dr Charles Cockrell of NASA Langley Research Center in 1994.² This can be seen in figure 2-2, where a mach cone is generated mathematically in front of the waverider.

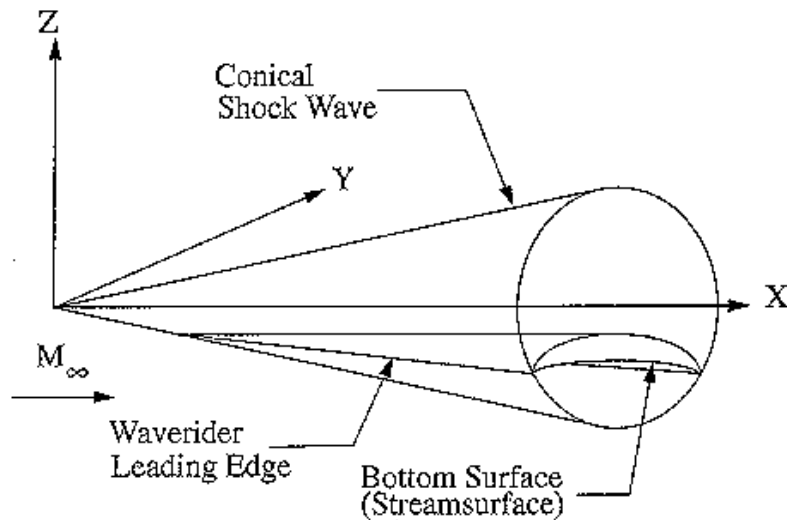

Figure 2-2. Conically Derived Waverider.

The waverider, which matches the flow (streamsurface), attaches to the shock and obtains a large lift-to-drag ratio (L/D), which enables much further range when compared to other hypersonic bodies. Although getting a shock wave to attach perfectly is impossible in reality, the initial shock angle can be made as oblique as possible, reducing pressure drag. When combined with the high aerodynamic heating of hypersonic flight, the waverider background surfaces in the conceptual proposal for the SHAAFT: an aerothermodynamically configured vehicle.

Overcoming drag in excess of 358,000 pounds will be required by the power plant of the SHAAFT. A 10,000-mile flight at mach 12 lasts approximately 74 minutes (this range subtracts the range of the zero stage). This figure includes time from zero-stage separation to engine shut-down and glide-in (in which no fuel is spent), therefore, extra fuel will be available for emergency contingents. The 74-minute flight will require the most amount of thrust for the least amount of fuel.

For mach 12 flight, the large heating rates (which will be discussed later) cause dissociation of atomic oxygen. Typical, large-molecule hydrocarbon fuels— such as JP-4, JP-8, JP-12, gasoline, and other petroleum-based fuels— would suffer incomplete burning and poor efficiency under these conditions. The other fuel alternative is cryogenics such as liquid hydrogen, liquid methane, and others. Liquid hydrogen allows for the highest Isp; its light molecular weight and high energy combustion rate make it ideal for the mach 12 mission.

Several types of powerplants were considered, based upon the findings of the 1992 US Air Force Scientific Advisory Board. For this application, specific impulse was the paramount variable(fig. 2-3). Specific impulse is defined as:

$$I_{sp} = \frac{\text{Thrust}}{\text{Rate of Fuel Flow}} = \frac{T}{\dot{m}}$$

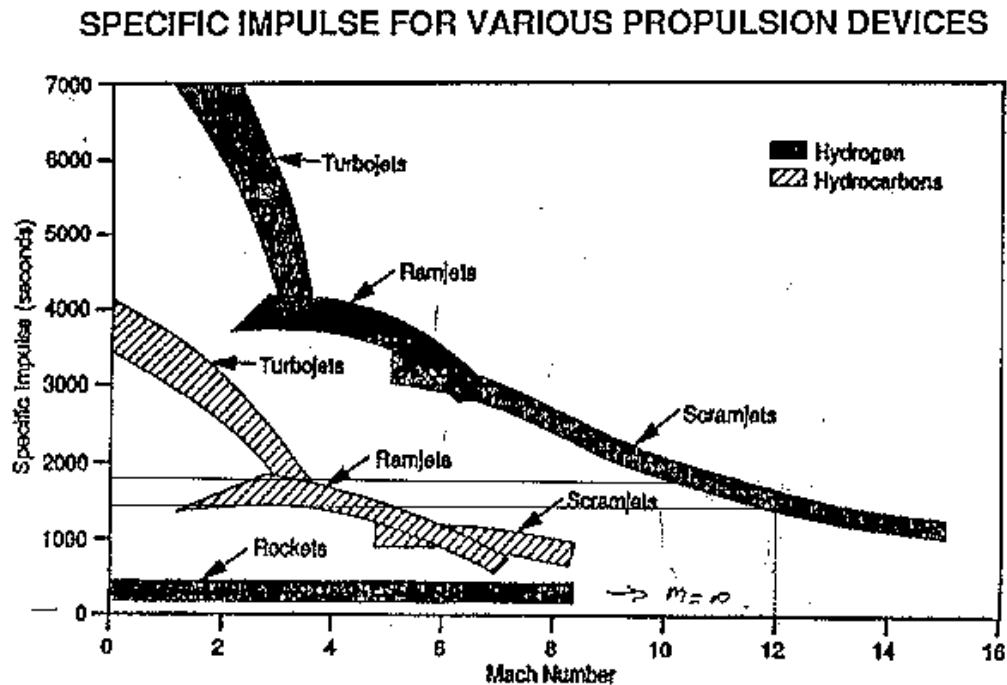

Figure 2-3. Specific Impulse Variation.

Two alternatives exist for SHAAFT propulsion: rockets and dual-mode ramjet/scramjets. Rockets have excellent acceleration characteristics but poor cruising characteristics. Because rockets have such poor specific impulse, requiring their own oxidizers, ramjet/scramjets are the best alternative. Their air breathing technology, combined with hydrogen fuel, allows for the most “bang for your buck”. As seen in figure 2-3, the I_{sp} of such a combination lies between 1,400 second and 1,800 second. Since this aircraft would become operational around the year 2020, an I_{sp} of 1,700 second will be assumed for the design point.

The negative consequence to hydrogen fuel is the extremely large volume it occupies which will cause the majority of sizing problems with the SHAAFT. One key to overcoming the density problem is using “slush” hydrogen. Dr F. S. Billig of Johns Hopkins University computed the density of different slush hydrogen,³ and these can be viewed in table 1. For the technology level of 2020, a level of 50 percent solidification was assumed, resulting in a density of 5.11 lbm/ft³. Using this denser hydrogen, the overall fuselage volume can be reduced, reducing drag.

Table 1
Density Values of Slush Hydrogen (All Values at Triple Point)

Percent Solid by Weight	Density (lbm/ft ³)
10	4.81
20	4.87
30	4.99
40	5.05
50	5.11
60	5.16
70	5.22
80	5.28
90	5.34
100	5.40

To judge the size of the SHAAFT, a trade study was conducted to measure lift, drag, fuel requirements, and required fuel storage space. For the study, a lift coefficient of 0.125 and a drag coefficient of 0.025 were used to estimate appropriate aircraft length. These coefficients were chosen from experimental data performed by Dr T. Eggers and Dr R. Radespiel of the German Institute for Design Aerodynamics in 1993.⁴ It was also matched with the mathematically derived “L/D Barrier” for conical flow derived waveriders, as seen in figure 2-4. At cruise speed, the maximum L/D is given by the expression:

$$\left(\frac{L}{D}\right)_{\max} = \frac{4(M+3)}{M}$$

The $(L/D)_{\max}$ value with this equation for mach 12 is 5.0, which matched the values used in spreadsheet iterations.

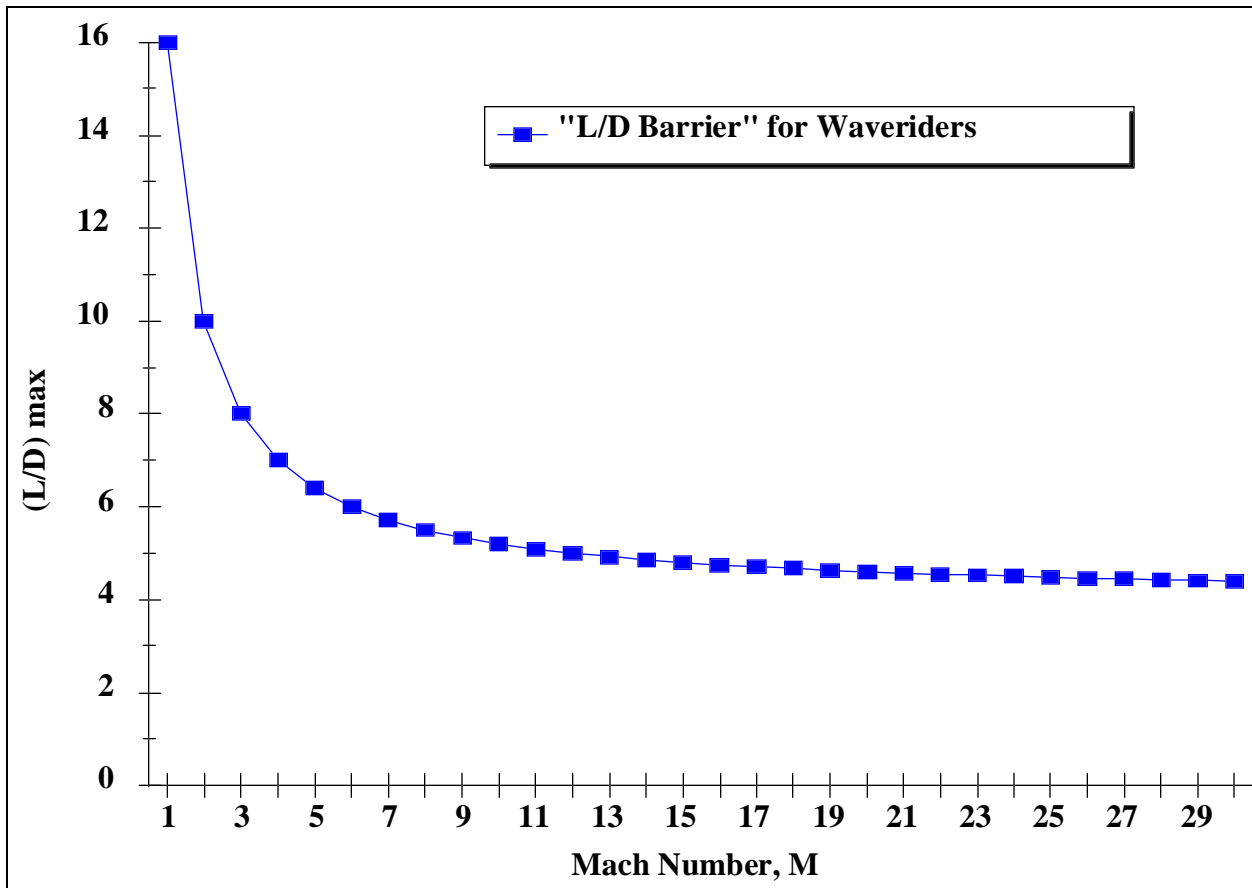

Figure 2-4. L/D Barrier for Waveriders.

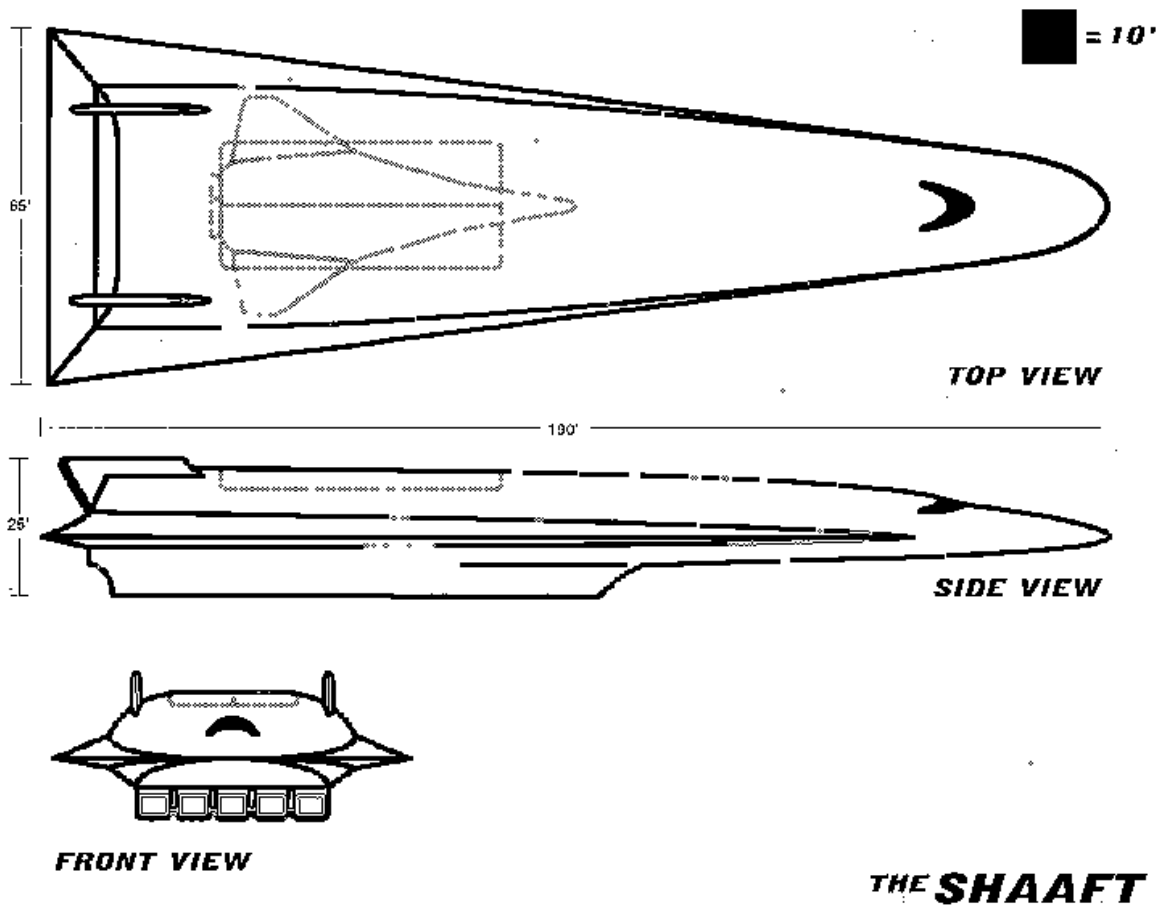

Figure 2-5. Supersonic/Hypersonic Attack Aircraft (SHAAFT).

The first step in the trade study was to pick an initial waverider size. With this, wing area was calculated using simple triangular geometry. Figure 2-5 shows the basic geometry of the proposed SHAAFT. Knowing that lift is given by the equation:

$$L = C_L q S$$

lift coefficient was found. Using coefficient of lift and drag plots derived by Dr Cockrell during experimental testing, drag coefficient was found. With the familiar drag equation:

$$D = C_D q S$$

drag for the vehicle was found. With this value, thrust was known, since thrust equals drag in level, unaccelerated flight. With thrust, and the assumed I_{sp} of 1,700 seconds, the fuel flow was calculated. When multiplied by the total flight time, a fuel mass was obtained. This fuel mass was divided by the 50 percent slush hydrogen density to obtain a fuel volume.

Fuel volume was compared to available tank volume from initial waverider dimensions chosen. Using traditional aircraft design, the fuel tank accounted for 50 percent of total aircraft volume. With an actual fuel volume calculated, the aircraft size was changed to try to match available fuel volume with required fuel volume. Aircraft weight was calculated with this volume of fuel, and the assumption that five pounds were required per square foot of wing area. This information was revealed in meetings with personnel of Wright Laboratory's Flight Dynamics Directorate, Wright-Patterson AFB, Ohio. This results in a SHAAFT body weight of 28,500 pounds, not including the 50,000 pound payload weight.

With the trade study, the fuel mass required met the fuel mass available at a waverider length of 190 feet. The tail end of the SHAAFT has a wingspan of approximately 60 feet. This design requires approximately 875,000 pounds of slush hydrogen to complete the 10,000 statute mile journey. The effects of the different iterations can be seen in figure 2-6. This particular iteration showed that the aircraft volume was too small, requiring further iterations.

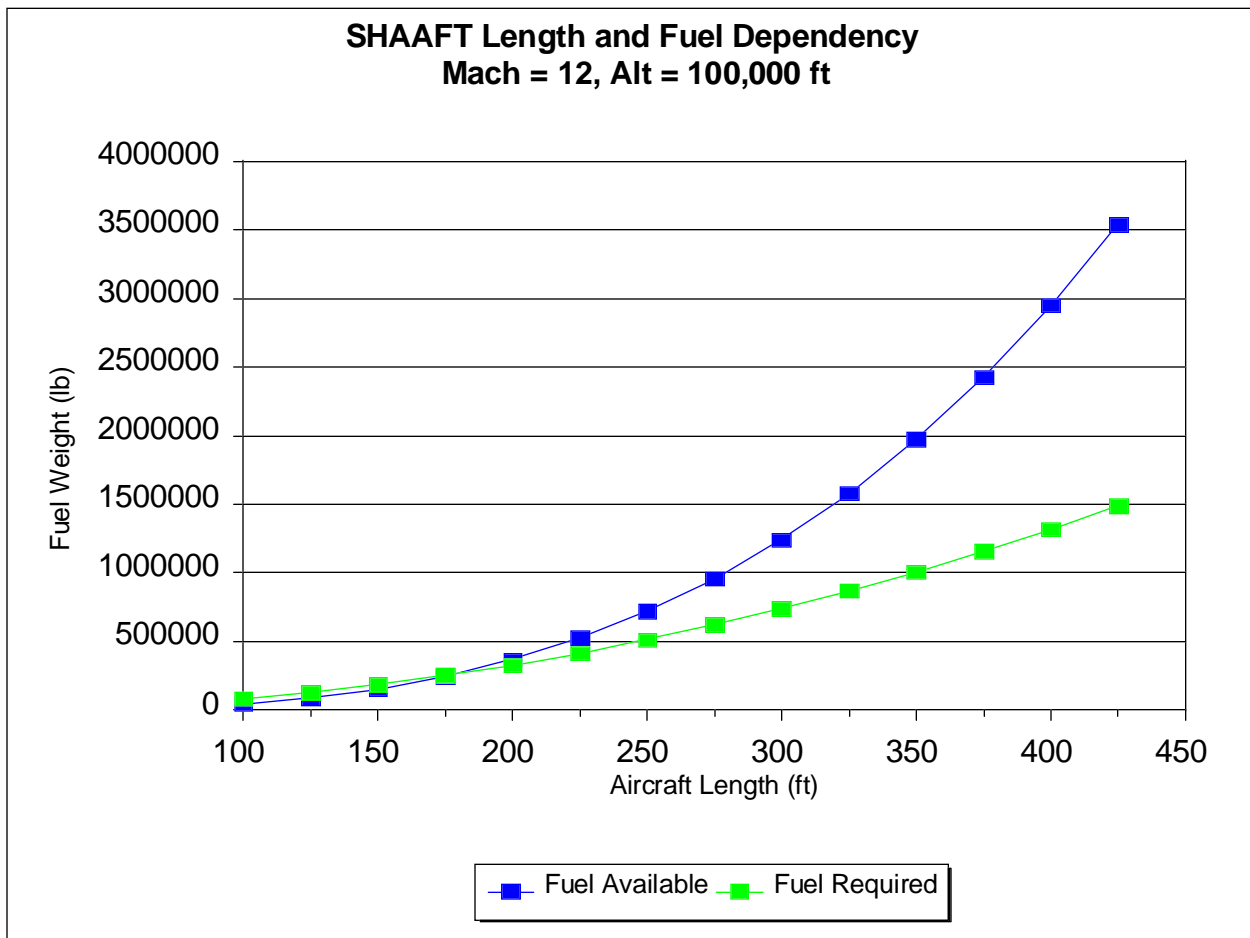

Figure 2-6. SHAAFT Sizing.

The Breguet range equation can be used to verify the aircraft size. With the assumption of cruise flight only and at constant velocity, the equation is

$$\text{Range} = \left(\frac{V}{C_t} \right) \left(\frac{L}{D} \right) \ln \left(\frac{W_i}{W_o} \right)$$

where V is velocity, C_t is thrust specific fuel consumption, L/D is the $(L/D)_{\text{max}}$ for the SHAAFT at mach 12, W_i is initial weight and W_o is final weight.

It is also important to note that C_t is related to the previously mentioned I_{sp} :

$$I_{sp} \approx \frac{1}{C_t}$$

Thus if I_{sp} is 1,700 seconds, C_t is 0.000588 pound/pound mass seconds. V is 11,891 feet/second, L/D is five, W_i is 954,000 pounds, and fuel mass required is 875,000 pounds, then W_o is approximately 78,500 pounds. Using the Breguet range equation, the mathematical range is over 25,000 miles, far exceeding the 14,000-mile requirement. However, the reason the mathematical range is nearly double what is needed is because the equation does not account for the excessive amount of fuel that is needed to takeoff and accelerate the SHAAFT to its cruise condition where it is most efficient. Approximately half the fuel will be spent taking off and accelerating the SHAAFT while also covering a large range. The extra calculated range is to ensure sufficient range throughout the entire flight. It also does not account for the large turning radius, given by the equation:

$$R = \frac{V^2}{g\sqrt{n^2 - 1}}$$

Here, R is turn radius, V is velocity, g is acceleration due to gravity, and n is the load factor of the turn. The SHAAFT would slow to mach 8 for turning and simultaneously launch SHMAC missiles. This gives a velocity of 11,890 feet per second. At a constant inch 2-g inch turn, the radius is approximately 480 miles, assuming a 50,000 pound payload is still in the aircraft.

Flight Control Systems

Payloads will be placed on the back end of the SHAAFT, requiring room and center of gravity considerations. By the year 2020, the level of fly-by-wire technology should be very commonplace, and application of such

technology to the waverider concept should be simple. The pilot would have a typical control stick, interfaced with a black box computer. The pilot's inputs would be fed into two outboard split ailerons, giving both yaw and roll control, and into inboard elevons, giving both pitch and roll control. During cruise flight, such control inputs would be very minor, as surface deflections produce extreme moments at mach 12.

Payloads would have to be located near the center of gravity of the SHAAFT. When these payloads are deployed, the shifting center of gravity could be disastrous if not properly accounted for in fuel ballast and in placement of loads along the fuselage. As 50,000 pounds of equipment depart the SHAAFT, the separation should occur smoothly and quickly to avoid dangerous situations.

Special Considerations

The unique mission and design of the SHAAFT will require facilities that are currently very rare or nonexistent. In addition to cryogenic storage and handling equipment, it will need an extensive facility to mate the SHAAFT with the launch platform. This would most likely be performed with a crane structure that would raise the SHAAFT into the air while the wing taxied into position beneath it (not unlike the space shuttle being mated to the Boeing 747). Automated facilities and technicians would then mate the two craft together.

Another consideration which can not be overlooked is the reality of an in-flight emergency developing and the SHAAFT being forced to land at a base which is not equipped to handle it. In this situation, some manner of getting the "Golden Bullet" back to the US would be imperative. This would be accomplished by dispatching a zero-stage wing to act as a ferry. The launch platform has extensive volume within its wings that is used up quickly during supersonic flight—but acting as a ferry, this range and endurance would increase substantially due to the low drag incurred by subsonic velocity. The alternative base would be equipped with a simple mating device, or if emergency demands, one could be airlifted to the foreign base. Once the two crafts are mated, the launch platform will take off and return to CONUS. It is important to remember that the SHAAFT is essentially a flying gas tank and that most of its weight comes from fuel. It would obviously be drained of unnecessary fuel and payload for the trip back to the US to reduce the workload on the launch platform. The zero-stage launch platform would use conventional, hydrocarbon fuels for all points in its mission, landing at specific points around the globe to refuel.

Mission

Flight Profile

After being brought to mach 3.5 by the zero stage launch platform, the SHAAFT would release and pitch up, automatically initiating the start of ramjets. From there, it would accelerate and increase in altitude until it reaches the cruise phase.

The cruise phase, at mach 12 and 100,000 feet, consists of the majority of the flight, including attack or SCREMAR transatmospheric vehicle deployment. The SHAAFT would continue at its cruise speed throughout the entire envelope, with the exception of takeoff, landing. This is due to safety considerations for the SHAAFT. If it entered or departed the target area at a much slower speed, to reduce negative aerothermodynamic effects, it would be vulnerable to more conventional types of attack. For instance, if an enemy country expected a SHAAFT attack, it could set up remote-based (possibly sea based, fleet launched) aircraft or SAM sites that do, and most likely will, have the capability in 2025 to destroy mach 5+/- aircraft.

In the attack phase, the SHAAFT would launch missiles/munitions from a considerable distance away from the target. It would have to release its munitions early in the attack phase to allow the munitions to acquire and adjust its course at such high speeds. Once the munitions were released, the SHAAFT would most likely make a constant 2-g turn and head back to the planned landing base. The precise routing would have to be precisely planned knowing that a 180 degree turn going mach 12 may take place over several countries.

If the SHAAFT were launching an orbital vehicle such as the SCREMAR TAV, it would takeoff, adjust its course to get to the desired inclination, and release the TAV going mach 12 at 100,000 feet. This gives the orbital vehicle an extreme advantage in potential and kinetic energy. An even greater advantage is that space access vehicles could be launched from any long runway in the world, rather than specific launch sites. This would be of an extreme advantage in wartime when it is possible and likely that our space centers will be a primary target.

Landing Phase

The landing phase would begin approximately 30 minutes prior to landing. While at cruise phase, the SHAAFT will shut down engines and decelerate to subsonic speeds to begin convectively cooling the skin surface. The glide

aspects will be very similar to current Space Shuttle landings. It will continue gliding until touchdown, where the pilot can maintain control during the most critical phase of flight. The onboard computers would assist the pilot in setting up the airspeed and altitude adjustments to avoid pilot error.

The landing gear will be relatively small and only capable of operation during landing (due to the zero-stage launch platform). Since the aircraft weight is reduced dramatically during cruise flight (fuel is an enormous percentage of the total weight), and substantially during takeoff with the launch platform, the landing gear does not need to be extremely heavy, at least in comparison with take off requirements. This also assists in overall aircraft design by drastically reducing the weight fraction of the landing gear.

The flying wing zero stage was able to lift the SHAAFT off the ground at conventional airspeeds. But the SHAAFT, being an aerothermodynamically configured vehicle for mach 12 cruise flight, would have much less lifting capability at traditional landing speeds. Therefore, it would have to land at high speeds, nearly 250–300 mph, which is similar to Space Shuttle landing speeds. In order to land this vehicle on large, but typical runways, a self-contained arresting system consisting of drag parachutes being deployed and extremely powerful brakes being applied upon landing would be incorporated into the design.

Payload Deployment

The inherent attack advantages of a hypersonic cruiser must not degrade its attack capability by deploying slow speed and ineffective munitions. Therefore, the focus of weaponry to be added to the SHAAFT should be newly designed and developed weapons that are capable of supersonic/hypersonic speeds and contain extremely lethal yields. At first sight, the SHMAC missile is an excellent complement to the SHAAFT in that it flies at hypersonic speeds and is extremely lethal. It should also increase the range of the SHAAFT by approximately 1,000 nautical miles. This could allow the SHAAFT to either carry less fuel and more payload (weapons) or be more simply designed with less required weight (in fuel and range). It would also allow the SHAAFT to stay well out of enemy defense zones by using the less expensive, expendable SHMAC to fly into the threat zone. These two systems would be of excellent complement to each other.

Another nearly ideally complementary system to the SHAAFT is the space access mission complement that can be accomplished. With a typical TAV, the size of a light F-15, the SHAAFT could be a rapid, reusable, and extremely advantageous launch platform. It could carry TAV vehicles with the capability to launch them into orbit at any

inclination and give them an initial, “free,” boost to 100,000 feet and mach 12. This would be of extreme benefit to the simplification of the design of the still futuristic TAV concept.

The primary considerations are that weapons be developed with varied capabilities to be able to attack multiple types or targets depending what appears at the moment as the primary threats. In addition to the SHMAC, penetrating rods, flechettes, conventional bombs, self-guided antiarmor munitions, subnuclear munitions, and whatever is developed in future years are all possible payloads for the SHAAFT. They would all have to be developed much further, but there is a potential for some extremely powerful and lethal weapons arising from hypersonic speeds.

Overall, the SHAAFT has an extremely varied capability either to attack to or be used as a mother vehicle for various other missions. The standard payload area should be able to accept a myriad of different weapons and clusters of weapons. It should be capable of striking not only multiple targets in one sortie, but striking different target types with the varied types of munitions it can carry. For instance, it would be very feasible for the SHAAFT to fly abreast of a country the size of Iraq, drop a few SHMAC's at primary C³ facilities, then drop precise antiarmor type munitions at key defensive sites. This capability would almost assuredly destroy the enemy's will and capability to wage war within a matter of several hours and a few sorties. High-value targets are key to success. With such a capability, it is assured that we could, on demand and nearly always, completely and definitively put a stop to the war before it begins.

Threats to the SHAAFT

Two possible threats that the SHAAFT could encounter are interceptors or laser weapons. The problems that an interceptor would face are enormous. It would have to detect, track, identify, launch, accelerate while climbing to 100,000 feet, and then overtake a target moving at 12 times the speed of sound. An interceptor that could do this would have to be traveling on the order of mach 20. Even if the enemy did spend the money to develop this super surface-to-air missile (SAM), where would they put it? It does no good to place it near key targets because the SHAAFT is releasing its cruise missiles from 1,000 miles away! An enemy would have to create a ring of super SAMs thousands of miles long around its entire perimeter to keep the SHAAFT from entering. However, if the SHAAFT launches its payload from 1,000 miles out to sea, or over a neighboring country, little ground protection exists.

The other potential threat comes from lasers. The advantage that the laser has is that it can nearly instantaneously track and then fire at a moving target. It does not have to catch up to its target nor can it be outmaneuvered. But its disadvantage is its range and power supply. A laser that was powerful enough to reach both hundreds of miles downrange to the SHAAFT and 100,000 feet in altitude would require **enormous** energy stores.⁵ A facility to supply this type of power could not be placed in a van and hidden on a mountain top. It would be a sprawling, high visibility complex that would be easily visible. Once again, if Special Forces units could not neutralize it before the attack occurs, the SHAAFT could attack the site from a thousand miles away or avoid it altogether.

Component Summary

The idea of the Supersonic/Hypersonic Attack Aircraft was derived by taking a look at what the U.S. Air Force will need to accomplish in the year 2025. Gone are the massive enemies of east and west; gone also are the large budgets which could support their armies. Now the United States must deal with regional threats, in a timely manner, in a costly manner, and in a manner safe to the members of U.S. armed forces. The SHAAFT is simply a tool to achieve these ends.

Hypersonics drives the missions of the SHAAFT. The infrastructure-intensive framework of supporting a fleet of turbine-driven attack aircraft reduces to a few supporting facilities in CONUS bases that support the SHAAFT. But the SHAAFT does not replace all existing and future Air Force inventory--it is a means to prevent the costly use of all other weapons. It saves money.

The SHAAFT has been designed to promote the proper usage of energy. By staging, it leaves bulky turbine engines on the ground as it completes the hypersonic attack role. By going hypersonic, the survivability of the SHAAFT increases tremendously. As of now, no known defensive weapons counter the SHAAFT threat; it simply flies too fast and too high. Upon completion of the mission, the aircraft would shut down engines and land on conventional runways, deploying drag parachutes to reduce the braking required. Such braking would occur with landing gear that has already been reduced greatly in weight due to the light airframe that would land back in the CONUS (the flying wing staging aircraft is equipped with bulky, expensive landing gear).

Technological improvements will be required to formalize this design. An operational ramjet/scramjet is key to designing such an aircraft. Aeroacoustic loads on the airframe cause many mechanical loading problems.

Aerothermal heating requires the use of advanced heat dissipation materials. Command and control of the aircraft would require computational software and a hydraulics system that can perform under extreme circumstances. But many of the technologies for SHAAFT would be drawn from existing areas of research. The flying wing zero stage would utilize designs from the high-speed civil transport program. Waverider studies would finalize the design of the SHAAFT. Hypersonic research of ramjets would be used for power plant designs. Such measures should be easy in the information-rich age of 2025.

Imagine a single aircraft that could fly up the Mississippi River and simultaneously destroy key facilities at Falcon AFB, Colorado, Cape Canaveral, Florida, and Washington, D.C. A similar blow to some rogue nation would cause them to seriously question their current military and political endeavors. If you ignite conflict with the US, the motto is You'll Get The SHAAFT!

Notes

¹ Boeing Commercial Airplanes. *High-Speed Civil Transport Study*, NASA Contractor Report 4234, under Contract NAS1- 18377, 1989.

² Charles Edward Cockrell, Jr. *Vehicle Integration Effects on Hypersonic Waveriders*, George Washington University School of Engineering and Applied Science, 21 April 1994.

³ Frederick S. Billig, *Propulsion Systems from Takeoff to High-Speed Flight*, American Institute of Aeronautics and Astronautics, 1990.

⁴ T. Eggers and R. Radespiel, *Design of Waveriders*. DLR, Institute for Design Aerodynamics, 11 October 1993.

⁵ During the SDI development, several laser systems were proposed that would be powerful enough to fire into space. Remember that these were fired straight up through 50 miles of atmosphere to reflecting satellites. A laser attacking the SHAAFT would have to fire at a slant angle through a thousand miles of atmosphere, refracting the beam and posing much less of a threat.

Chapter 3

Standoff Hypersonic Missile with Attack Capability (SHMAC)

The SHMAC (Standoff Hypersonic Missile with Attack Capability) is proposed as a weapon system which has in-theater dominance capability. This weapon system strikes quickly, accurately, and can survive enemy air defenses. The SHMAC can be fired from future hypersonic aircraft such as the SHAAFT (Supersonic/Hypersonic Attack Aircraft), from a low-speed conventional aircraft like the F-15E or the future F-22, from standard ship-based vertical launch system (VLS) tubes, or from mobile or fixed ground launch sites. The propulsion system and warheads will be varied to accommodate the launch platform and the service employing the SHMAC, be it the Army, Navy, Air Force, or Marines. In order to best exploit the range and response time of hypersonic weapons, the SHMAC will be most effective when launched from a hypersonic weapon system, such as the SHAAFT. The SHMAC concept has evolved into an in-theater dominance hypersonic missile, whose design is based upon the need to strike quickly with a high probability of success. The SHMAC will be the primary weapon delivered from the SHAAFT. Its range allows the SHAAFT to safely deliver SHMACs outside the range of air defense systems.

The United States armed forces do not have the ability to strike enemy centers of gravity quickly, decisively, and with a high degree of safety. To destroy targets such as space launch facilities, power grids, communication facilities, and command centers, a rapidly deployable, highly survivable, extremely accurate weapon is needed. Hypersonics is the key to reaching these heavily defended targets in a timely manner and attacking them with a high probability of success. The range and response time inherent in a hypersonic weapon gives the United States armed forces the ability to destroy any ground target in any theater. This is an enormous advantage for US forces as it allows complete in-theater dominance. The SHMAC is a hypersonic weapon system capable of fulfilling this mission.

Several factors drive the design of the SHMAC. These include range, time to target, survivability, guidance requirements, payload requirements, launch platform size restrictions, heating rates, acceleration loads, and maintenance requirements. Initial designs include easy-loading modular payloads. The limitation for the payload is a maximum warhead of 500 to 1,000 pounds. This restriction is driven by the weight limit and size limit of the entire vehicle. Modularity offers flexibility of application of the SHMAC in a fluid war environment.

The missile body has a conventional cruise missile configuration adapted for hypersonic speeds. The propulsion concept is a combination of a rocket for the initial acceleration and a scramjet for sustained propulsion to the design speed of mach 8. The rocket engine will not be necessary for the high-speed air-launched version (SHAAFT launched) because the missile will be deployed at or above cruise speed and altitude. The technology for the rocket/dump combustor-scramjet propulsion system has been studied in the ramjet form by engineers at the Flight Dynamics Laboratory at Wright Labs from 1977 to 1980.

The leading edges could be comprised of ablative materials or an ultrahigh temperature ceramic (UHTC) composed of a dibromide material like ZrB_2/SiC .¹ Ablators are an economical thermal protection system (TPS) because the SHMAC is a single use weapon. Albatross are much less expensive than more exotic reusable materials. The shape of the missile will not change during flight when high temperature regions are protected with UHTC materials. This ensures that the flight characteristics of the missile will not change during the course of the flight. The ablative technology employed in the thermal protection system is currently available, while UHTC materials are currently being developed by the Ames Research Center.²

The guidance technology takes into account the unique high-speed environment in which the missile will be operating. Possible technologies employed in the SHMAC guidance system include inertial navigation systems (INS) and global positioning system (GPS) usage for the cruise phase. Synthetic aperture radar (SAR) and infrared (IR) guidance is employed in the missile's terminal phase. The technology required to support the design of this missile should mature and become readily available within the next 10 years.

The SHMAC is the first step in developing a line of hypersonic vehicles to meet the needs of the Air Force well into the twenty-first century. These technologies will build upon each other, covering the complete spectrum of hypersonic speeds all the way to orbital velocities. The weapons systems range from in-theater dominance to global and space power projection. This hypersonics program will be an integrated effort (S^3) which allows one program to build upon previous research and development and the lessons learned in the other projects.

General Mission Requirements

Range and Time to Target

There are several minimum requirements that military planners have set for a hypersonic weapon system like the SHMAC. The ultimate constraint is for the missile to have a range of 1,000 nautical miles or more. It is desirable to be able to travel this distance in approximately 20 minutes although this is not as important as the range. Figure 3-1 shows the effective ranges of the high-speed air launched, low-speed air launched, and surface launched SHMACs in the Middle Eastern and European theaters. The time-to-target requirement of 20 minutes is based upon the time from missile launch until the SHMAC reaches the intended target. This time requirement, as well as survivability considerations, drives the need for the missile to cruise at mach 8. Technologically, mach 8 is an upper limit on the speed because of the desire to use endothermic hydrocarbons as a scramjet fuel, eliminating the need for cryogenics and the associated complexities.

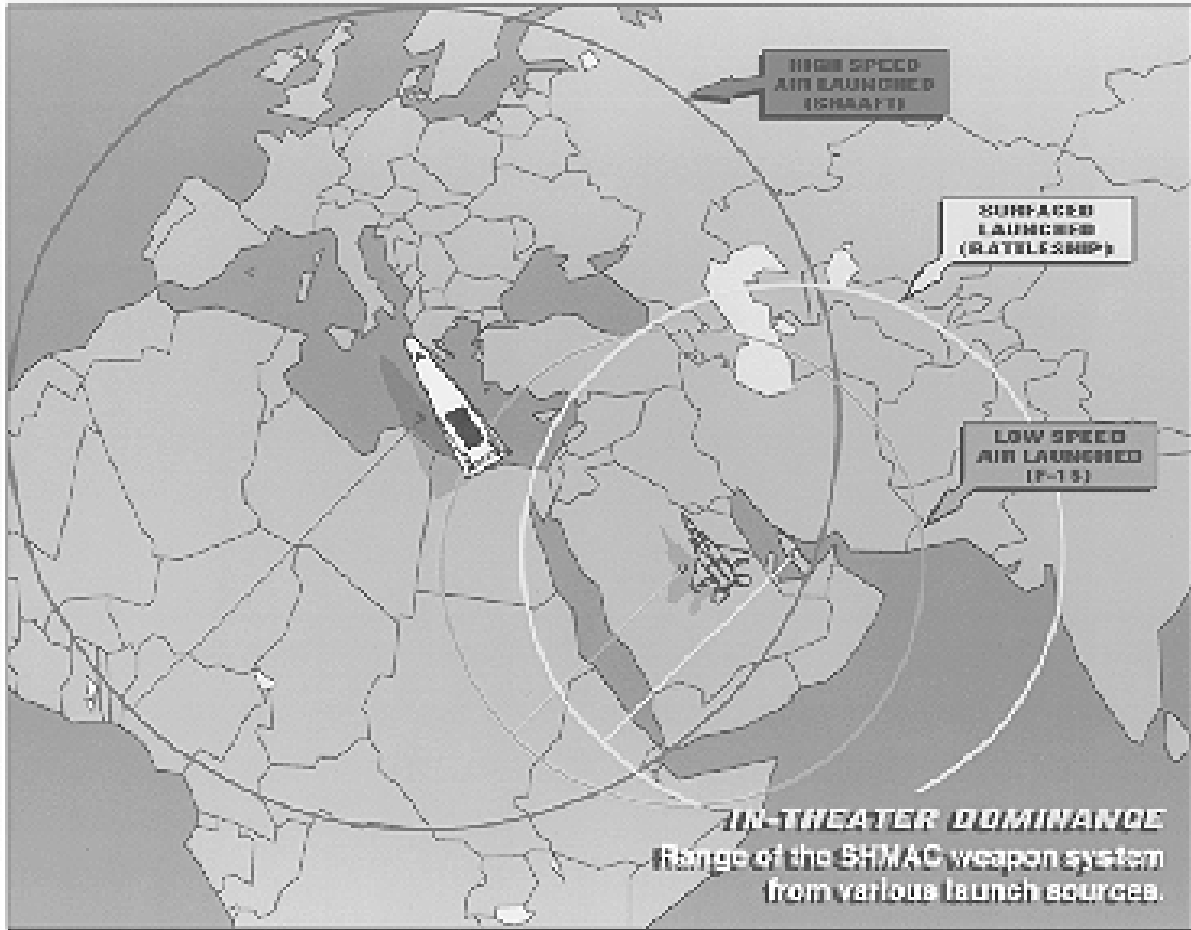

Figure 3-1. Effective Ranges of the SHMAC.

Cost Effective

With today's budget constraints it is nearly impossible to justify any acquisition program to Congress if the cost is too high. In order to keep costs low, existing technologies, modular designs, low-cost materials, and start-of-the-art or evolutionary design techniques will be employed. While hypersonics may be thought of as a revolutionary application, new designs can be developed on a technology base of more than 40 years of work. Furthermore, the design and development costs of the SHAAFT/SHMAC combination will be offset by the money this team saves in the long run.

Developing and employing the SHMAC will allow the US to maintain a strong military presence, while staying within the limits of our own borders and military budget constraints. The SHMAC has the ability to avoid a protracted war by reducing the enemies will and ability to continue a war. This minimizes, or could eliminate, the costs

associated with a major force deployment. This cost is not only measured in dollars but more importantly in human lives. If a conflict can not be avoided, the SHMAC has the ability to save lives, aircraft, and operational costs by striking heavily defended, hard to reach, key targets with accuracy and lethality. At first glance the price tag for this Platinum Bullet may seem high; but when all the opportunities and benefits are considered this is an economically feasible weapon system.

Operational Simplicity

The missile will be relatively inexpensive and operationally simple. This includes technology considerations such as thermal protection systems, propulsion and fuels, payloads, and guidance as well as base infrastructure such as missile maintenance and other support activities.

At a mach number of eight and an altitude of 100,000 feet, the aerothermodynamic environment produces high surface temperatures, approximately 3500 °R at the stagnation points. This environment drives the design of the thermal protection, propulsion, and guidance and control systems. The TPS for the nose and leading edge will be comprised of either ablators or UHTC. Existing rocket technology will be utilized in combination with a scramjet. The weapons bay will be designed to accommodate existing warheads and smart submunitions. Guidance and control will take advantage of GPS and SAR technology to acquire and destroy targets.

A goal throughout the entire design process has been to keep the missiles required support, maintenance, and other infrastructure very small, simple, and cheap. The missile requires only a small number of support personnel to maintain it. Since it is one use only, there is no need for through-flight maintenance. All munitions crews will be trained in proper methods to handle the SHMAC. Therefore the missile can be shipped or flown to the operational theater and be ready for deployment on any aircraft without requiring specifically trained personnel. Since it will be hard to know exactly what the targets will be in advance, the missile design also allows for easy transfer of existing munitions into the missile. Personnel trained to prepare the missile can configure the SHMAC for any mission on a moments notice by interchanging the modular payloads.

SHMAC Vehicle Concepts

SHMAC Design

Three distinct versions of the SHMAC will be originally developed to allow for launch platform diversity. The versions are high-speed air launched, low-speed air launched, and surface launched. The high-speed air launched category includes all hypersonic delivery platforms. The SHAAFT will deliver SHMACs designed for high-speed launch. The low-speed air-launched category includes current and future transonic attack aircraft. Existing aircraft which could launch SHMACs include the F-15E, F-16, F-14, B-1, B-52, F-111, P-3, S-3, and the B-2. The surface-launched category includes both ship launched missiles from a standard Navy VLS tube, as well as ground launched missiles from a mobile or fixed launch platform.

A unique design feature of the SHMAC is a platypus nose. This provides two distinct advantages. First, a platypus nose has a lower heating rate than a conical nose. This is due to the ability of the cross section to better distribute the heating across the missile nose in two dimensions, rather than concentrating it at a single point. The heating rates will still be high at the stagnation point of the nose. The second advantage is the higher lift-to-drag ratio inherent in a platypus nose design.

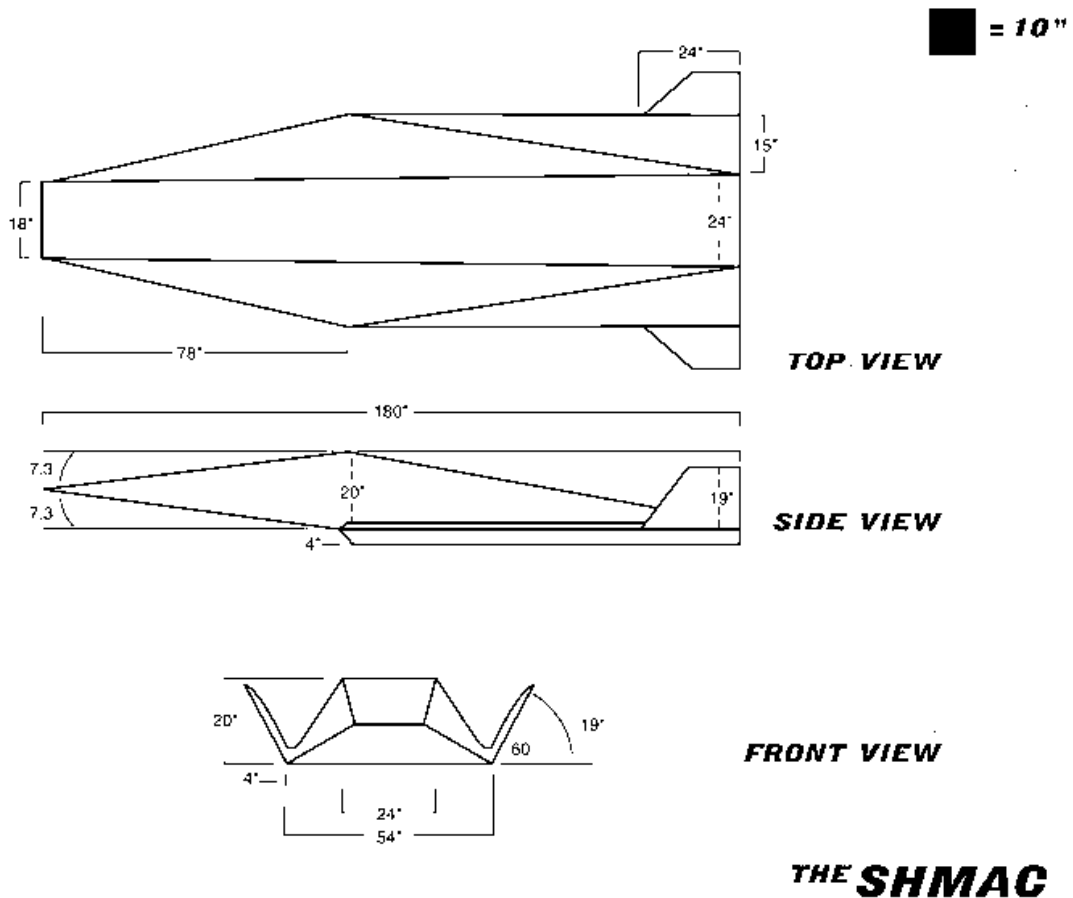

Figure 3-2. Standoff Hypersonic Missile with Attack Capability (SHMAC).

The missile configurations for the high-speed air launched and the low-speed air launched are virtually identical. A potential conceptual design is shown in figure 3-2. Both have the same dimensions, the difference is the additional weight associated with a rocket in the low-speed air launched version. The missile's dimensions are 180 inches long, 54 inches wide, 23 inches high, and a nose radius of 1.5 inches. There is one slanted surface on the bottom of the missile which forms the compression ramp for the air entering the engine inlet. This also provides a component of lift to complement the wings. A lift-to-drag ratio of 4.5 was determined for the SHMAC based on calculations as well as values determined from other sources.³

In order for the system to be employed by the Navy through a VLS it must be modified. The missile is longer and more slender in this configuration than the traditional SHMAC. This was driven by the need to retain volume for the rocket fuel while fitting within the slender confines of a VLS tube. The dimensions are 250 inches long, 16 inches

high, and 22 inches wide. In addition, folding control fins are utilized to allow the missile to fit within a VLS tube. These will deploy after launch and provide the required control and stability for the missile.

The SHMAC exploits modular payload designs. This missile must be flexible in the types of targets it can hit. As a result, the SHMAC has the ability to change payload depending on the intended target. Payload variations range from high explosives to smart submunitions. Based on current missile designs, we plan to target the enemy with approximately 500 to 1,000 pounds of explosive material. The entire missile design is an iterative process that must balance propulsion, aerodynamics, payload, guidance and navigation, and many other considerations.

Propulsion

The first area of consideration is propulsion. For the low-speed air launched or surface launched SHMAC configuration, we recommend concentrating on developing an integral rocket/scramjet engine. This choice of engine is driven by the desire to accomplish the mission at a low cost without sacrificing effectiveness. This type of combined propulsion cycle provides high initial acceleration without multiple air-breathing propulsion concepts. The rocket will quickly accelerate the missile to high altitude and a mach number where the scramjet takes over.

The driving force behind the entire design of this missile is the mission. However, as previously mentioned, further considerations must be made to account for the delivery platform. For example, if the SHAAFT will be the primary delivery system, the missile needs to be easily compatible with that aircraft. Further modifications need to be made if the SHMAC is to be used by today's fighter/bomber aircraft because of their unique limitations. Ship based SHMACs will be sized to fit into the Navy's VLS tubes. The largest modification for a land or sea fired SHMAC is the rocket engine. A rocket propulsion system is required to accelerate the SHMAC to cruising altitude and mach number before the scramjet engine becomes effective. The rocket/dump combustor scramjet combination is shown in figure 3-3.

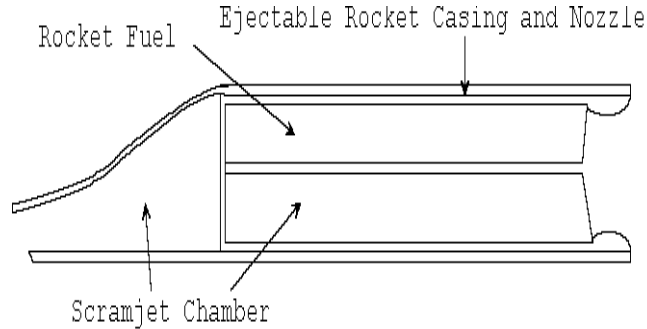

Figure 3-3. Rocket/Dump Combustor Scramjet.

The SHMAC uses both a rocket and a scramjet to take advantage of the unique capabilities of each propulsion system. A rocket provides large initial acceleration at low mach numbers. Rocket fuel is more dense than scramjet fuel due to the need to carry oxidizer within the fuel. Because of the low I_{sp} s of rockets, more fuel is required to produce the same amount of thrust. This means an all rocket concept is not desirable due to the large size and weight resulting from the rocket fuel.

On the other hand, a scramjet provides efficient high-speed cruise performance. This is due to its ability to gather oxygen from the atmosphere and its relatively high I_{sp} as compared to rockets. The I_{sp} for the rocket is due to the oxidizer contained within the solid propellant.⁴ All of these attributes keep the size of a scramjet small. The drawback of the scramjet is its inability to function at low speeds. Therefore, the optimum propulsion concept is a rocket for low-speed acceleration and a scramjet for high-speed cruise.

A low-speed airbreathing concept without rocket acceleration would include a turbojet propulsion system. This results in the need for moving mechanical parts, increased expense and complexity, as well as large size and weight. A turbojet can not provide the quick boost of acceleration to scramjet operating speed and altitude that a rocket can. This high acceleration is desirable to reduce mission time and increase SHMAC survivability. Since the SHMAC has a need for both quick response time and a long range, a combined propulsion system like the rocket and scramjet combination is a must.

The propulsion system which will be used in the SHMAC is a combined rocket and scramjet. This system incorporates an ejectable rocket case. The tolerances required for a scramjet to function in the mach 8 regime would be violated by using a scramjet chamber clogged with the remains of a burnt out solid rocket. The residue and spent fuel of the solid rocket will be removed from the scramjet chamber by ejecting the entire rocket casing after its burn is

completed. The high heating rates along the combustor section of the rocket casing will be the most critical area driving the need for the engine material. Typical rocket fuels burn around 6500 °R.⁵ A single rocket nozzle will be used. This provides simplicity, low weight, and low cost, though multiple nozzles would reduce the overall volume.

The rocket system, with its high initial acceleration, will be used to boost the missile up to a speed and altitude where the scramjet becomes efficient. Limited trade studies have shown an optimum altitude of 100,000 feet and mach 6 for the transition from rocket propulsion to scramjet power. The scramjet system, with the advantage of highly efficient cruise capability, will keep the missile at its altitude and speed until reaching the descent point for the target.

Guidance

Another area considered is guidance. The missile will be programmable while in flight. This enables it to receive updated information permitting in-flight vectoring to a moving target. One means to accomplish this is an inertial guidance system with GPS redundancy which will be updated with the new coordinates as the target moves. A design challenge is ensuring that the guidance signals sent to the missile have enough power to penetrate the hot boundary layer and relay information to the guidance system of the missile. As the SHMAC nears the target area, it will employ self-guidance procedures.

One of these self-guidance procedures is synthetic aperture radar which will guide the SHMAC to a fixed target. This type of target may not have as distinctive a heat signature so a SAR system will have a much greater chance of success against this type of target. Today's SARs have resolutions of less than one meter at 70,000 feet, so the capability certainly exists to acquire and destroy a target using SAR.⁶

The most effective means to target a recently fired launcher is initial detection of the infrared signature of the launching missile coupled with radar tracking for pinpointing its location. The North American Aerospace Defense Command has the ability to use these two technologies to locate launch vehicles anywhere in the world. Sending the coordinates of the target to the SHMAC can be used to guide the missile to the target area. However, the final acquisition and tracking of the launcher must use a different form of terminal guidance such as IR or SAR because the launcher may have moved after launching.

Modular Weapons Bay

The SHMAC has so many different missions (flexibility is the key to air power), that modular design to accommodate different weapons and guidance payloads is a must. This will simplify the tasks for maintenance crews on the flight line by allowing them to reconfigure the missile easily. In general, this missile will not be harder to maintain than another single use weapon like the Sparrow or Sidewinder. The rocket booster contains solid fuel and the scramjet uses an easily maintainable endothermic hydrocarbon fuel, JP-8 or some derivative. Fueling the missile before it is placed upon the aircraft will not require excessive support personnel or time.

Special Considerations

An important consideration in propulsion system design is the engine inlet. All three SHMAC versions are characterized by an underbody engine inlet that was shown in figure 3-2. A favorable forebody compression field is created by the interaction of the shock from the nose and the inlet lip. Other oblique shocks are formed along the inlet ramp to the combustion chamber which further slow the flow. The disadvantage of an underbody inlet is that the missile needs bank to turn in order to ensure good flow into the engine during flight maneuvers.⁷ This increases the complexity of the flight control system.

The ideal intake scenario is one in which the flow transitions from laminar to turbulent upstream of the inlet. A laminar boundary layer is desired in front of the inlet, since it will keep the heating rates along the compression face of the missile lower than if this flow is turbulent. However, a mature turbulent boundary layer is required before the flow enters the inlet. This transition needs to occur soon enough so that the inlet shock has a turbulent boundary layer across it. The shock-boundary layer interaction works better with turbulent flow. Turbulent flow is also better suited for rapid mixing of fuel and air in the scramjet.⁸ The burn phase must be completed extremely quickly for the scramjet to operate effectively. At high mach numbers, the flameholders and fuel injectors must be highly advanced to successfully mix the fuel and airflow and fully combust it in the scramjet chamber for the most efficient burn.

One solution to the flameholder problem is to use highly reactive fuels (such as hydrocarbons with 20 percent ethyl decaborane).⁹ Reactive fuels spontaneously combust when mixed with the airflow, eliminating the need for flameholders. This would enhance the performance of the engine by reducing the drag and flow problems caused by

the flameholders. One problem with reactive fuels is safely storing and maintaining them as well as their high cost when compared to conventional fuels.

The scramjet will have an on-design point of mach 8 which is the desired cruising speed. To further reduce the cost, the inlet to the scramjet will be fixed geometry designed for mach 8 freestream velocity. Since the scramjet has no moving parts, the overall cost of manufacturing it will be fairly low, an important consideration in a single-use weapon. The cost of the scramjet is mostly driven by the materials contained in the scramjet/ rocket engine. These materials will need to withstand the burning of the endothermic hydrocarbons and the oblique shocks formed on the inlet ramp.

The next area considered is the thermal protection system for the SHMAC. A great deal of thermal protection system research was conducted during the Apollo and Shuttle program. This research established many low cost thermal protection alternatives which are readily available for use on the SHMAC. The Space Shuttle program has also led to the development of new TPS. There has also been great progress in the study of ultrahigh temperature ceramics. Since the SHMAC is a single-use vehicle, the most cost-effective form of TPS seems to be ablators. However, significant research still needs to be conducted in this area as to what form of TPS is best for the SHMAC. Further considerations in this area are discussed in greater detail in chapter 5.

Mission

Flight Profiles

Spreadsheets were used to develop the high-speed and low-speed air launched and surface launched representative mission profiles. For each flight phase, values were calculated based on a simple free body diagram of the missile. The independent variables in this iteration were rocket boost end altitude, rocket boost downrange, descent downrange, acceleration cruise downrange, and unaccelerated cruise downrange. The estimated rocket fuel and scramjet fuel values were adjusted to match the iterated values produced from the calculations. All of these variables were iterated and manipulated until the mission profile could be successfully met, and the overall vehicle weight did not exceed 4,000 pounds.

Several assumptions were made to produce these profiles. One assumption was that rockets have a thrust to weight ratio of 10. Another was that a scramjet at 100,000 feet has a thrust to weight ratio equal to 0.1.¹⁰ A representative rocket fuel (polyvinyl chloride/ammonium perchlorate/aluminum) was used. This fuel has a density of 0.064 lb/in³, burns at 6150 °F, and has an Isp of 265 sec⁻¹. Scramjets operating at mach numbers from six to eight have Isp's between 900 and 1200 sec⁻¹ (see fig. 2-3). A representative scramjet Isp of 1100 sec⁻¹ was used in the spreadsheets.

These iterations produced the following mission for the SHAAFT launched SHMAC shown in figure 3-4. The SHAAFT launches the missile at 100,000 feet at mach 8. The scramjet ignites, and the missile cruises at mach 8 over the next 10 minutes. This cruise phase brings the missile 810 nautical miles down range. Finally, the scramjet shuts off and the missile pitches over into the descent phase. This phase lasts for 11 minutes and allows a target that is an additional 620 nautical miles away to be destroyed. The entire mission gives the SHAAFT launched SHMAC a range of 1,440 nautical miles in a flight time of 21 minutes.

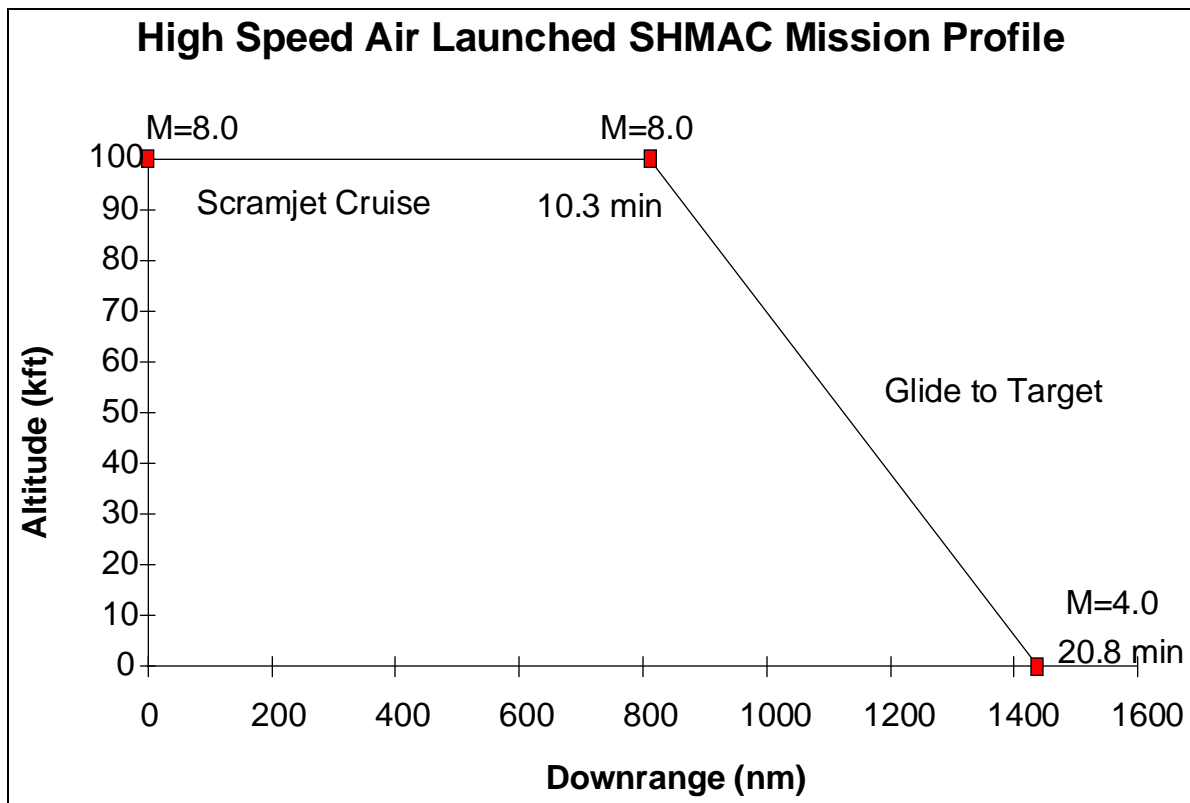

Figure 3-4. High Speed Air Launched SHMAC Mission Profile.

The second mission we considered was launching the SHMAC from a conventional fighter or bomber such as an F-15 or B-1. This low-speed air launched profile is shown in figure 3-5. The SHMAC will be launched from approximately 30,000 feet and mach 0.8. The solid rocket booster accelerates the missile at an average flight path angle of 50° to 80,000 feet at mach 6. This results in an average acceleration rate of 9 g's. The boost places the missile seven nautical miles downrange in 18 seconds. The cruise phase then accelerates the SHMAC to mach 8, 100,000 ft and an additional 460 nautical miles downrange in a little over six minutes. The glide phase carries the missile another 630 miles downrange and slows it to mach 4. This gives this variant a total range of 1,100 nautical miles in 17 minutes.

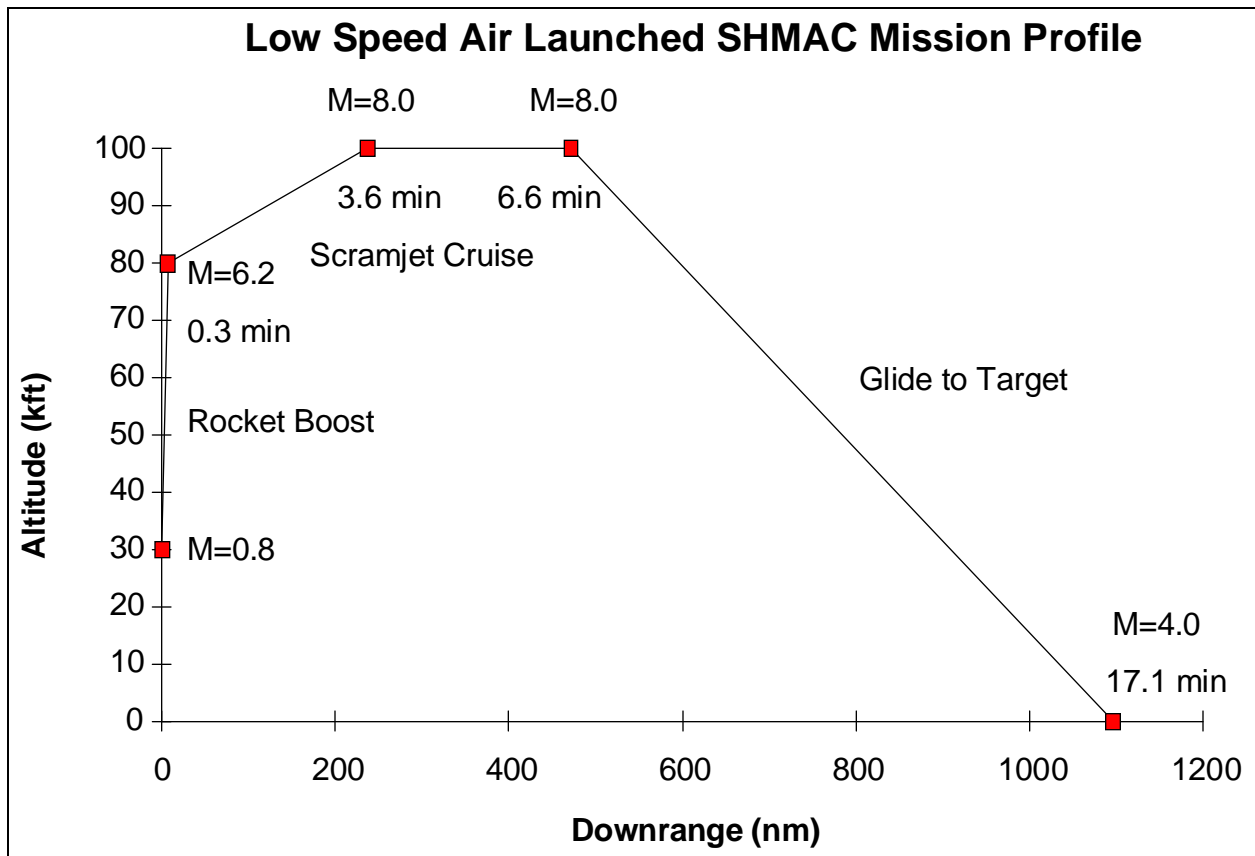

Figure 3-5. Low Speed Air Launched SHMAC Mission Profile.

The third mission considered is for the surface launched version and is shown in figure 3-6. The SHMAC will be launched from an altitude of approximately zero feet and a mach number of zero. The solid rocket booster accelerates the missile at an average flight path angle of 54° to 50,000 feet at mach 6. This results in an average acceleration rate of 9 g's. The boost places the missile six nautical miles downrange in 20 seconds. The cruise phase

then accelerates the SHMAC to mach 8, 100,000 feet and an additional 410 nautical miles downrange in six minutes. The glide phase carries the missile another 630 miles downrange and slows it to mach 4. This gives this variant a total range of 1,040 nautical miles in 17 minutes.

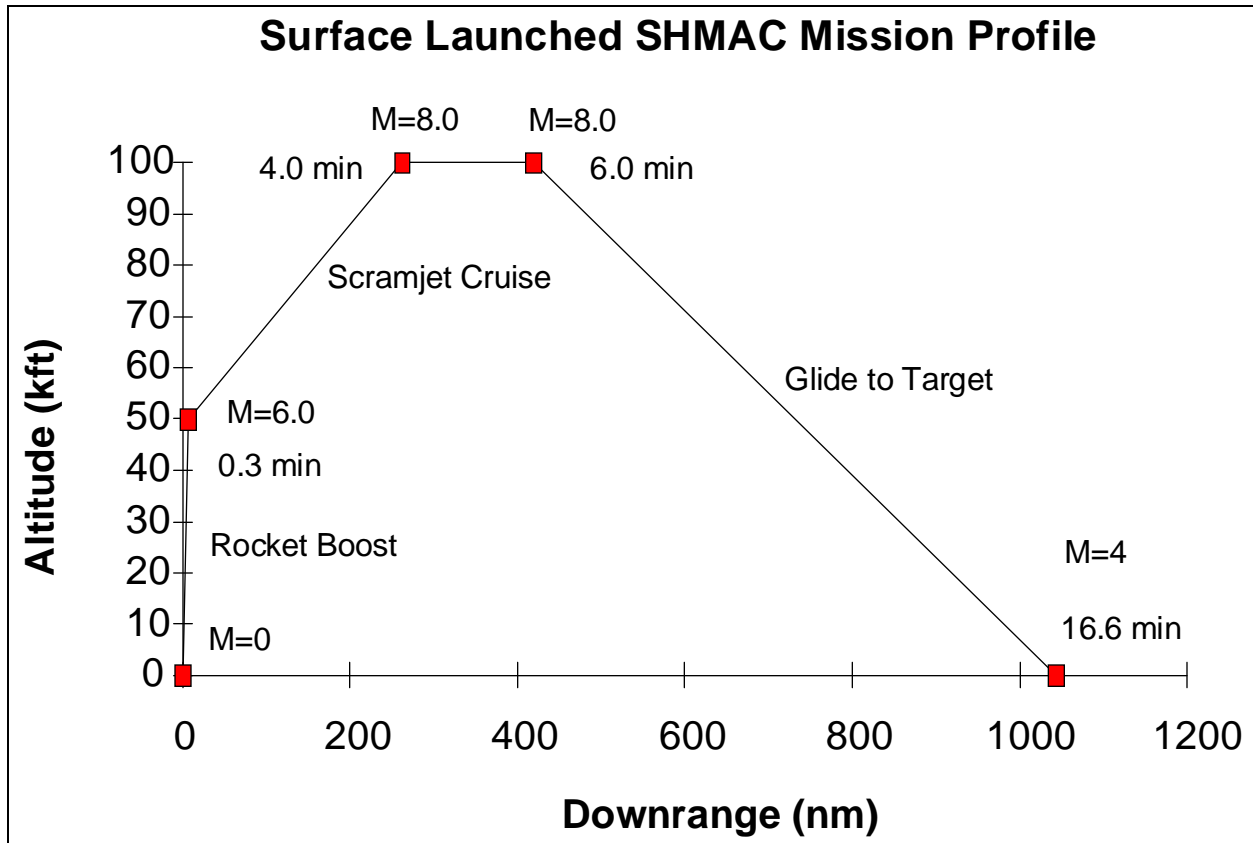

Figure 3-6. Surface Launched SHMAC Mission Profile.

Objective

The ability to attack key centers of gravity and strategic targets in a theater without prepositioned forces is beneficial for several reasons. This allows the United States to use its military instrument of national power immediately, at any location in the world. This ability can help avoid the development of a protracted conflict by immediately reducing the enemy's will and ability to fight a war. Of equal importance, the immense expense associated with maintaining an overseas presence during peacetime can be avoided by the development of a long-range-quick strike capability. The logistics footprint associated with a large deployment of US troops, like in Desert Storm, is a major expense and hardship on our nation. The SHAAFT/SHMAC combination avoids this footprint by providing the ability to strike anywhere in the world from a CONUS base.

The SHMAC gives the Air Force the essential capability to make a decisive strike in the first hours of a conflict. If a conflict arises, it takes a significant amount of time to mobilize a response force. The SHAAFT/SHMAC integrated weapon system gives the US the ability to strike enemy centers of gravity within hours.

Another advantage of the SHMAC is its ability to protect other war-fighting assets. The 1,000 nautical mile range of the SHMAC allows the SHAAFT to place weapons on target from a safe distance. The SHMAC is released from its host, be it a SHAAFT, F-15E, sea launcher, or ground launcher from a distance safely outside of enemy air and ground defenses. The SHMAC can attack enemy centers of gravity such as command and control centers, access to space assets, and power and communication centers without putting more valuable assets, like aircraft, ships, and, most importantly, human lives into harms way.

The speed of information gathering and distribution in warfare has matured at a phenomenal rate, but the military technology to deliver ordnance quickly enough to take advantage of this increased capability has not followed suit. The inability to attack detected targets of opportunity is a major shortcoming of our present force structure. These targets may include recently fired mobile ballistic missile launchers or military commanders whose whereabouts were recently discovered. This is where the speed and range of a hypersonic missile is a needed and crucial advantage. With SHMAC technology, the enemy will have no safe haven or freedom of movement. Anytime they are detected, they can be quickly attacked and destroyed.

There will be no escape from the oncoming SHMAC. The SHMAC will expand the Air Force's power-projection ability and increase our national security by enhancing the attack capability of all our armed forces. As mentioned earlier, the US military will now be able to stop the development of a protracted war without deploying any troops.

Possibly the greatest advantage of the SHMAC is its survivability. This weapon is highly survivable due to its mission profiles. The SHMAC will cruise at mach 8 and at an altitude of 100,000 feet. This flight regime is exceedingly difficult to reach with current air defense weapon systems. A surface-to-air missile system with 200 miles of coverage would have just over one minute to acquire and launch a missile at the SHMAC. This assumes the SHMAC is detected and classified as a threat at the limit of the missiles radar range. If they delay longer than this period, the missile will already be overhead and almost impossible to catch up to in flight. During the descent, to the target the missile never slows below mach 4 and numerous submunitions can be deployed. Therefore, there is very little chance that an enemy will be able to destroy it with a conventional surface-to-air missile in the terminal flight

phase. Furthermore, the missile is not a dumb bomb but is capable of maneuvering, further increasing its survivability and success.

Possible threats to the SHMAC in the future are directed energy weapons such as lasers and microwaves. However, though these weapons may be developed, their complexity and high-power consumption will limit who is able to deploy them and how many are deployed. Only well-developed countries will be able to afford these weapons and only to protect key targets. This kind of threat is a definite possibility, but the standoff capability of the SHMAC ensures that the missiles will be targeted instead of manned aircraft, ships, or trucks.

Although the SHMAC has the potential to be used for many different types of missions, it was designed with a specific mission in mind. That mission is to strike a ground target 1,000 nm away in 20 minutes or less after release from a launch system. This mission was chosen to be the primary focus because it represents a current void in the US's ability to project military force. The ability to strike and destroy ground targets deep inside enemy territory is a mission that will continue to plague US forces in future conflicts unless this problem is solved now.

Future variants of the SHMAC may accomplish different types of missions using the same basic SHMAC technologies incorporated into the first version. These additional missions may include ballistic missile intercept, cruise missile intercept, air to air, surface to air, antiship, close air support, interdiction, and psychological operations. The speed and survivability of the SHMAC can enhance all of these missions. However, modifying the SHMAC to complete these missions will need to be accompanied by large advances in technology in other areas, especially guidance and control. This list represents the flexibility of a hypersonic missile, it is not an advertisement of the near-term capability of the SHMAC.

One of these missions, ballistic missile intercept, was a particularly plaguing problem for the US during Operation Desert Storm. The most effective way to destroy a ballistic missile is to reach it in its boost phase. Attempting to destroy the missile in the reentry phase when decoys, submunitions, and debris are present is extremely difficult. Hypersonic technology is required to reach a ballistic missile in the boost phase. The SHMAC could provide this capability.

Boost phase intercept capability will become more important in the future as more countries obtain the capability to employ weapons of mass destruction. We do not want to destroy a chemical or nuclear weapon over our own troops since the chemicals or fallout will then harm our own forces. Destroying a nuclear biological chemical weapon over our foe's territory is an extremely attractive option for a commander in the field.

When the technology required for a boost phase intercept is developed, this will still be a difficult mission for the SHMAC. One challenge in this mission is getting to the enemy missile while it is still in the boost phase. The SHMAC's speed and range is essential for completion of this mission during the enemy missile's vulnerable boost phase. The largest technological challenge is targeting another hypersonic missile in the air. Closure rates of well over 12,000 feet per second are probable when a SHMAC intercepts another missile. Not only must the SHMAC detect and track the missile, it needs to be able to physically strike the enemy missile to achieve a kinetic kill.

Component Summary

It is critical that funding be provided for the SHMAC immediately. With it the US will truly be able to dominate any theater during any future conflict. Also, the average cost of a fleet of SHMACs will still be considerably lower than the current cost required for the Navy's tomahawk land attack missile to hit a target. In addition, it will be highly survivable, fast, and lethal. In short, **there will be no escaping the oncoming SHMAC.**

A hypersonic attack missile should be the first step towards developing an Air Force that can truly achieve Global Reach/Global Power through hypersonics. As explained before, the SHMAC falls into the first of three major categories of hypersonic vehicles: in-theater dominance, global reach/global power (SHAAFT), and access to space (SCREMAR). An in-theater dominance weapon like the SHMAC has the simplest mission and is closest to development today; using existing hypersonic vehicle and missile technologies. The SHMAC can become a stepping stone towards developing more complex vehicles and should later be integrated into other hypersonic platforms like the SHAAFT.

Notes

¹ Jeff E. Bull and Paul Kolodziej, "X-34 Sharp Wing Integrated Flight Test (SWIFT), Thermal Protection Materials.

² Ibid.

³ R. J. Krieger et al., "Aerodynamic Configured Missile Development—Final Report," Wright Laboratories, 15 March 1980.

⁴ Frederick S. Billig, "Tactical Missile Design Concepts," *Johns Hopkins APL Technical Digest*, 139–54.

⁵ Ibid.

⁶ Dan Rondeaux, private discussion, 20 November 1995.

⁷ Billig.

⁸ E. T. Curran, W. H. Heiser, and D. T. Pratt. "Fluid Phenomena in Scramjet Combustion Systems," *Fluid Mechanics Annual Review*, 1996.

⁹ Billig.

¹⁰ Ibid.

Chapter 4

Space Control with a Reusable Military Aircraft (SCREMAR)

System Overview

The SCREMAR (Space Control with a REusable Military AiRcraft) is a transatmospheric vehicle that can provide flexible, reliable, routine, and readily available access to space well into the future for a variety of applications. It is a multiple-stage-to-orbit (MSTO) vehicle designed for integrated use with the SHAAFT. It is 66 feet long with a gross takeoff weight of 50,000 pounds, roughly the size of an F-15, and fits piggyback on the SHAAFT. The hypersonic capabilities of the SHAAFT are used to take the SCREMAR to mach 12 at 100,000 feet where the SCREMAR then separates. The SCREMAR then uses its two rocket engines to complete the remainder of the access-to-space mission in a similar fashion as the Space Shuttle, returning to a predetermined base for a horizontal landing on a conventional runway. Since SHAAFT produces a significant portion of the velocity change required to get the SCREMAR to orbit, the size of the SCREMAR can be greatly reduced while the payload increased.

The SCREMAR is a TAV/orbiter capable of carrying a 3,000 pound payload to a low-earth orbit. This payload will most likely be three 1,000-pound satellites, but there are also other options. The SCREMAR is not designed to replace the existing fleet of space launch vehicles. Rather, it is designed to fulfill a specific niche that current launch systems do not occupy. Specifically, the SCREMAR accomplishes the deployment and retrieval of satellites for a variety of scenarios (to include critical wartime replenishment), on-orbit support and repair of damaged satellites, and sophisticated ASAT warfare against vulnerable space assets of potential adversaries. Essentially, the SCREMAR can fulfill the essential mission requirements for spacelift, on-orbit support, and counterspace applications.

There are a variety of scenarios where an easily planned access-to-space mission is critical. The best means for accomplishing these missions is a reusable TAV/orbiter, for example, the SCREMAR. The most likely is a situation in which an adversary has managed to render a significant portion of a satellite constellation inoperable. In this situation, the SHAAFT/SCREMAR combination would be a means of quickly replenishing vital space capabilities. This would occur in two possible ways: the SCREMAR would take several new satellites to space to be deployed and replace damaged satellites or the SCREMAR could simply repair damaged satellites by docking with them in their orbit.

The role SCREMAR will play in helping the US maintain its space superiority status well into the future is crucial. In the past, and even present day, the US has enjoyed unopposed access to space, albeit at a very costly and time-consuming process. In the vastly changing political structures throughout the world, it is very likely potential adversaries will have the capabilities required to significantly hinder the missions we now accomplish from space through the use of satellites as well as our access-to-space capability. Due to its increasing importance, space is most likely to be the dominion of the modern battlefield.

The Need for Access to Space

The accelerated pace of the modern battlefield has dictated that the US become increasingly dependent upon their space assets. In fact, the success of the Army, Navy, and Air Force throughout Desert Shield and Desert Storm was due in large part to the advantages provided by global positioning system, communication, and intelligence satellites. The war was won in the air and on the ground because there was no contest in space; the United States maintained control of the ultimate high ground throughout the entire conflict. In the future, space power and control over the ultimate high ground will be critical to winning battles on the sea, in the air, and on land. The SCREMAR can maintain this control.

With the increasing importance on space assets, the US cannot afford to neglect the necessity of space superiority. Space has become a vital means of communication, intelligence, and navigation for the Army, Navy, and Air Force in all military operations. Already in place are large and small satellites of varying types arranged in constellations to perform these and many other specific functions. Most nations of concern do not possess an adequate space infrastructure, but they do, however, possess the ability to level the playing field against the US through the use of nuclear weapons in space. For example, Russia and China, with their formidable space infrastructure, have the

capability of posing a serious threat to US space assets. With the assets the US currently has in place and the vital role they fulfill in all military operations, America cannot lose a significant portion of this infrastructure and still function as a modern-day military power.

Nations without a strong access-to-space infrastructure (e.g., Iraq and North Korea) could still significantly hinder the US space capabilities at low costs and with little effort. Consider this: Iraq possess an enormous Scud missile inventory and possibly the ability to procure nuclear warheads. This could be extremely dangerous to US interests abroad. Although the range of the Scud missile is very limited and nowhere close to being able to strike the US mainland, it is a ballistic missile with the capability of reaching the earth's upper atmosphere and lower regions of space if launched straight up. If fitted with a nuclear warhead, the electromagnetic pulse alone due to a nuclear detonation in the ionosphere could wipe out a significant portion of a satellite constellation's ability to operate effectively. Several detonations could make our satellite fleets inoperable.

Future concerns also include the possibility of a nation with notable space capabilities, such as Russia, performing sophisticated ASAT warfare. A resurgent ultranationalist Russia or a disgruntled China could either selectively engage and destroy our satellites as needed or use the previously mentioned method of random destruction depending on how many space assets they have in the area and if they can afford to lose them.

Satellites are extremely fragile spacecraft. This is due largely to the push for lower spacecraft weights (directly impacting lower launch costs) and the fact that no real threat exists in space to damage satellites other than the solar radiation damage (which we have made significant progress over the last few years in reducing) and the extremely unlikely and very rare event of the satellite being struck by a projectile of significant size, such as an asteroid or man-made object. The ability of a rogue nation with no legitimate space infrastructure being able to guide an object to impact a satellite in the vastness of space is an extremely difficult task.

However, with nuclear weapons, accuracy is not an issue. A nuclear detonation close to the earth's atmosphere in the lower regions of space would have enough energy alone to completely obliterate all satellites in the region overhead that are positioned in low-earth orbits. Although the exact effective region for such an explosion alone in space is unknown, it is estimated in the thousands of miles. Clearly accuracy is not a driving factor for an adversary wanting only to take out America's ability to look at them for several hours; they could clear out the entire region above them while they launch a surprise attack on allied forces.

The damage to US satellites extends far beyond just what is done from the impact of the explosion. There is also an electromagnetic pulse that is dispensed by the explosion, extending for thousands of miles beyond the area affected from the detonation forces, which could incapacitate satellites' sensitive sensors and circuits, although the satellites' structures themselves would not be significantly damaged. This electromagnetic disturbance also tends to linger over an affected area for extended periods of time (e.g. several days) that make operations over the infected area extremely difficult until the disturbance had degenerated.

Regardless of the duration of the electromagnetic disturbance, there would be a significant US interest to replace those satellites in the constellation which have been destroyed and repair those which have been damaged. Replaced and repaired satellites should be ready to become fully operational as soon as conditions permit or in as little as a couple of days. Although current technology uses "hot spares" (satellites that are already in the constellation, but not turned on) to cover for satellites that quit working for various reasons, these extra satellites would most likely also be damaged to some extent from the detonations. Using hot spare satellites that are in other orbital planes in order to reduce the impact of such an explosion is extremely difficult. Only if the satellite is in the same orbital plane does it have a chance of being effective in covering the area of responsibility for a destroyed or damaged satellite in an emergency situation. In the event that several nukes are set off at given intervals over an area, the effect of hot spares being able to restore previous capabilities is drastically reduced.

With flexible access to space through the use of a transatmospheric vehicle, (for example, the SCREMAR, the military would be able to replenish destroyed satellites and repair damaged ones in a substantially reduced time frame relative to what is required by today's launch systems. This restoration time would be measured in terms of hours in getting a spacecraft that is on alert status into orbit with its payload of new satellites and/or replacement parts and getting the new/repared satellites operational. A specially configured TAV could also perform various aspects of sophisticated ASAT warfare against enemy space assets. Also of importance would be the development of a technology that would readily allow access to space on a regular basis during all phases of conflict: before, during, and after the war. Having easily obtainable access to space on a regularly repeated basis would greatly increase the United States' chances of maintaining overall combat effectiveness through such a situation as previously described. Space control would become as regular a mission as air superiority. There is a definite need for the US to develop some form of countermeasure to the diverse space threats in anticipation of maintaining space control throughout the duration of any battle.

General Mission Requirements

The success of the access-to-space mission is dependent on several key requirements. Although not all of the requirements mentioned in this section are critical, they are necessary in terms of getting the flexibility, reliability, responsiveness, and low costs desired in an access-to-space TAV/orbiter. Some of the more critical requirements include (1) ability to get a 3,000-pound to a LEO, (2) 50,000-pound gross weight, (3) release point from first stage at mach 12 at 100,000 feet, (4) launch-on-demand capability, (5) ease of mission planning, (6) small, flexible, highly trained ground crew, (7) build off of existing infrastructure as much as possible, (8) develop in conjunction with other hypersonic technologies, (9) rapid turnaround time, (10) horizontal takeoff and landing (HTOL), and (11) global reach from a suborbital flight path. These requirements are directly related to increasing flexibility and cost effectiveness. Other important requirements to be considered are manned and unmanned aircraft versions and modular cargo bay for ease of integration of various cargo and weapon systems.

Payload

The most critical requirement for a reusable military aircraft to fulfill the flexible access-to-space mission is the ability to take a sizable payload into a LEO. Having a military aircraft that is just designed to get to space without carrying any type of payload, as past programs have suggested, is virtually useless as a space control asset. The US' presence in space is based on the number of deployed and usable satellites.

Typical communication and intelligence satellites weigh in the neighborhood of 1,000 pounds or so and have dimensions roughly 6 feet x 6 feet x 6 feet when folded up. This is more or less the case for the newest constellation of satellites being deployed, the Iridium satellites, with expected reductions in size and weight in time with technology advances in materials and electronics. Having this capability would allow the SCREMAR to put approximately three satellites into a LEO (approximately 100 nm x 400 nm) in a single mission that can be planned and executed in a few days. Using today's technology, this would most likely take three separate missions with several weeks of planning in between each launch.

The benefits in terms of time and monetary costs can be seen from just this aspect while operational benefits extend even further. The SCREMAR could replenish an entire orbital plane of a satellite constellation with just three missions that could be accomplished in succession. The importance of the ability to plan and execute these missions

in a short time as well as turn around the vehicle for subsequent missions quickly will be discussed in more detail later. Nevertheless, the importance of this capability can be seen in that satellites cannot be deployed (or repaired) if they (or the necessary tools) cannot be taken to orbit.

Sizing

The requirement for a gross takeoff weight around 50,000 pounds is driven by several factors. First and foremost is that this is the maximum payload of the SHAAFT. Also of importance is the fact that the lighter the overall weight, less fuel will have to be used to get the required change in velocity to get such a spacecraft into orbit. This places less demands on the need for significant improvements in both fuel and rocket propulsion technology. This relationship can be seen from the following orbital velocity equation:

$$\Delta V = gI_{sp} \ln \left(\frac{m_0}{m_0 - m_p} \right)$$

where g is the earth's gravitational acceleration, I_{sp} is the specific impulse of the fuel, m_0 is the initial mass, and m_p is the mass of the propellant. Thus, costs savings are realized both in terms of cost to build and cost to launch/operate when existing fuel and propulsion technologies can be taken advantage of.

The constraints placed upon a final stage TAV/orbiter from the first stage, for example the SHAAFT are critical. Having a TAV/orbiter much greater than 50,000 pounds causes a significant impact on the ability for the SHAAFT to accelerate the SCREMAR to mach 12 at 100,000 feet. The rationale for needing to stage at mach 12 at 100,000 feet is explained later; however, it is important to realize that the issues of size, weight of dry structure, weight of payload, weight of fuel, and staging are all interrelated and have significant impacts on each other. Previous studies, such as Blackhorse,¹ Beta,² and Saenger,³ have concluded that a spacecraft roughly the size of an F-15 or F-16 would be the most beneficial configuration in terms of technology required to produce such a vehicle.

Another important consideration is the fact that attempting to produce such an orbiter that carries an equivalent payload, 3,000 pounds, that is much lighter than 50,000 pounds requires a significant breakthrough in structure materials. As it stands now, the proposed SCREMAR's total weight is nearly 75 percent fuel and the other 25 percent encompassing both the payload and dry structural weight. As can already be seen, this is going to require

improvements in structural technology; however, it will not require a significant breakthrough, only the natural progression of technology with time.

Staging

As alluded to earlier, there is also a critical need for staging at mach 12 at 100,000 feet. Studies have shown that the altitude is not so much a factor as is the staging mach number. In order to reach a LEO, the required velocity is around 26,000 feet/s (30,000 feet/s considering losses due to losses from pressure, drag, etc.). Since the desired orbit is at least 100 nm, the effects on required velocity change of staging at 50,000 feet versus 100,000 feet versus 150,000 feet are nearly negligible versus staging mach number. The overriding factor is the change in velocity that the TAV/orbiter, SCREMAR, has to produce on its own. Staging at mach 12 versus mach 8 means a starting velocity difference of approximately 12,000 feet/s versus 8,000 feet/s. This is a difference of having nearly 40 percent of the required orbital velocity supplied by the first stage versus 27 percent. Similarly, the staging height of 50,000 ft versus 150,000 feet is only between 10–25 percent of the total height above the earth needed, but the same velocity change has to be produced.

Staging at a lower altitude requires a larger vehicle since more fuel will be required to achieve the additional height as well as overcome the effects of air density. This places more demands on the structure all over, including weights and TPS. Staging at a higher altitude is limited to the capabilities of the first stage, e.g. the SHAAFT, since it uses airbreathing engines. Either way, the same amount of total energy is required to put an object in orbit. The velocity of the TAV/orbiter that is required to get it to a specified orbit is given by:

$$V_1 = \sqrt{2\mu \left(\frac{r_2}{r_1(r_1 + r_2)} \right)}$$

where v_1 is the tangential velocity at the minimum radius, r_1 is the minimum radius, r_2 is the maximum radius, and μ is the earth's gravitational constant. The only biggest difference is how much of this velocity is supplied by the first stage, the SHAAFT, and how much will have to be supplied by the final TAV/orbiter stage. The diagram for describing this orbital equation around earth is given below (note: the figure is not drawn to scale):

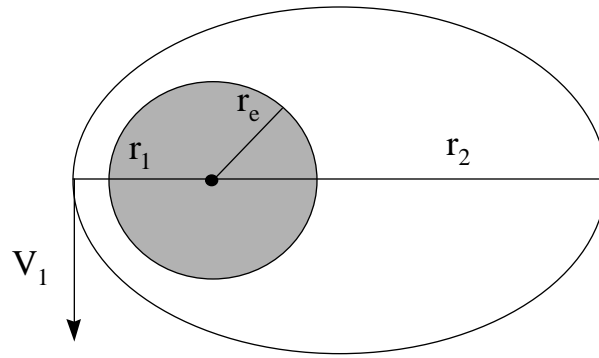

Using the LEO previously described, r_1 would relate to the 100 nm part of the orbit and r_2 would relate to the 400 nm part of the orbit. However, this equation also takes into account the radius of earth, r_e , which is 3,443 nm (much greater than the 100 nm or 400 nm height above the earth's surface). For instance, $r_1 = r_e + 100$ nm and $r_2 = r_e + 400$ nm. Therefore, the real benefits in terms of the velocity change that would have to be produced by the TAV/orbiter considering staging at 150,000 feet versus 50,000 feet are less than 0.01 percent. Staging above 100,000 feet places other excessive demands on the SHAAFT since it is an airbreathing aircraft. Having a staging height somewhere below 100,000 ft means that more fuel will have to be burned to achieve the additional height, increasing operating costs. This would also mean that additional size would be needed to hold the additional fuel. In terms of benefits versus costs, 100,000 feet appears to be the optimum staging altitude. From this altitude, SCREMAR size increases significantly with a 50 percent decrease in staging height; but the size does not decrease significantly for a 50 percent increase in staging height.

The effects of staging velocity are even more critical. Using the two equations above and spreadsheets that varied the different parameters affecting the SCREMAR, relationships were determined between staging height, mach number, payload weight, gross total weight, and fuel weight. Various fuels with different densities and I_{sp} s were used with staging heights between 50,000 feet and 150,000 feet and staging mach numbers between eight and 12. With height, the only amount of additional fuel required is that to achieve an extra 50,000 feet or so of altitude. However, the study showed that much more additional fuel is required to produce the extra required velocity from mach 8 than from mach 12 at every altitude than the amount of additional fuel required to produce the additional height from 50,000 feet to 150,000 feet at either mach 8 or mach 12. Thus, a TAV staging at mach 12 at 50,000 feet would be about half the size of a TAV staging at mach 8 at 150,000 feet. With the considerations mentioned before, the optimum staging conditions for the SCREMAR are mach 12 at 100,000 feet.

Also, developing the technology for the first stage to have the capability to stage at mach 12 will be less costly in the long run than trying to develop a TAV/orbiter of roughly the same size that overcomes greater velocity changes. The SCREMAR TAV/orbiter concept is already stretched in terms of existing technology for dry structural weight versus size. Having a staging point of mach 12 at 100,000 feet greatly reduces the amount of fuel needed to achieve the required velocity change, and thus the overall size of the TAV/orbiter. Also, 100,000 feet is a reasonable altitude in which the SHAAFT can operate with sufficient air and without the excessive drag penalties. This topic is also discussed in more detail in chapter 5.

Operational Efficiency

The requirements for launch-on-demand capability, ease of mission planning, rapid turn-around time, and a small, flexible, highly trained ground crew go hand-in-hand. The requirement for launch-on-demand capability stems from the need for time-critical replenishment/repair of US satellites. Only by having the capability to replace damaged satellites in a short time can the US maintain the upperhand with space assets during a military operations. As previously mentioned, consider the case in which a majority of our space assets or a key satellite have been destroyed. Today's capabilities would require weeks to replace a single key asset, months or even years to replace a majority of a constellation. With the pace of the modern battlefield, the war could long be over before we could even get a single satellite on-line with today's launch systems. By having launch-on-demand capability, a mission to replace damaged or destroyed satellites could be underway within hours of the incapacitation of the satellites, thus getting the US back into the war with C³I in a matter of days.

Of course, getting three satellites into orbit in a matter of hours is great, but really means nothing if another mission cannot be launched for several weeks. Thus, the need for launch-on-demand is required in conjunction with the need for ease of mission planning and rapid turnaround time for vehicle missions. A given mission should be able to be identified and planned within a days time. The proposed time frame for turnaround time, six to eight hours, is enough to allow for two missions to be completed in a single day, allowing also for a four to six hour mission time. A normal orbital plane of a constellation usually consists of 5-15 satellites, depending on the orbital height and number of satellites required in a field-of-view (FOV). Having six satellites placed in an orbital plane would be enough in most situations to provide substantial coverage over any given area.

It is also important to realize that these two requirements of launch-on-demand and rapid turnaround can only be met with a small, flexible, highly trained ground crew. The more people involved, the more time required for everyone to communicate and agree upon the status of the vehicle and increased chances of breakdowns in communication. Also, having a small, highly trained ground crew reduces the operating costs by not having to use as many resources to maintain operability. A small, flexible crew would also be much easier to transport in the event that the SCREMAR has to divert to a remote base. Most importantly, it implicitly requires that everything be done in a relatively simple manner. The less complexity, the cheaper the costs, the easier to operate and maintain, and the less chance there is for a major catastrophe.

Development

With the need for reducing the complexity of the overall system, there are a couple of complementary requirements: (1) develop critical technologies in conjunction with other hypersonic programs (for example, the SHAAFT and SHMAC) and (2) build off the existing infrastructure as much as possible. These requirements produce several key benefits to the program.

Savings in time and costs can also be realized by developing critical technologies, such as propulsion, fuels, TPS, and structural materials in conjunction with the other hypersonic programs of the SHAAFT and the SHMAC as well as extracting information and experience gained from vehicle and technology programs done and underway elsewhere. Since the technologies will be developed together, they will be cheaper in terms of the usefulness gained among the different systems (SCREMAR, SHAAFT, and SHMAC) rather than applying technology to only one. It will also make it easier to integrate the technologies among the three systems since they will be applicable to all systems. By building off of the existing infrastructure and developing hypersonic technologies together at one time, the SHAAFT/SCREMAR/SHMAC becomes a much lower-cost and less-complex integrated weapons system.

Infrastructure

Building off of the existing infrastructure means several things. Considerable monetary savings can be realized by not having to develop and build an entirely new and different access-to-space infrastructure. Existing infrastructures for both space and general aviation can be utilized and combined. Also, facilities for handling the

support of the SHAAFT and SCREMAR combination will be available worldwide, wherever, for example, the SCREMAR lands, providing greater flexibility to the SHAAFT/SCREMAR system. Only slight modifications to training and facilities would be required, reducing both costs and time to produce an operational infrastructure that is mission capable.

Building from the existing infrastructure has several advantages. First is the reduced costs associated with being able to redesign and utilize existing structures versus having to develop a completely new infrastructure. This is due primarily to the fact that almost everything needed to support operations is already in place and has already demonstrated the capability to support similar operations. Also, by combining assets from both the aero and space infrastructures, all US Air Force aircraft operations could be conducted from one multifunctional infrastructure rather than three separate ones. This is consistent with the Air Force's movements towards composite wings. It also increases the flexibility of the SHAAFT/SCREMAR system by expanding the number of bases from which it can operate. This is an extremely important factor in the storage of fuels. If a majority of bases do not possess the ability to store the fuels required by both the SHAAFT and the SCREMAR, the base is essentially useless unless the fuels can be transported in by a special aircraft, such as a modified KC-10. However, if this is not possible, then the SCREMAR can be transported to wherever the SHAAFT is located via a Boeing 747, similar to the Shuttle.

It is also necessary that the infrastructure be able to support both the SHAAFT/SCREMAR system. This is because the SHAAFT is required for SCREMAR operation. The SCREMAR is not designed to takeoff on its own. It must be loaded onto the SHAAFT in order to get off the ground. As designed, the SCREMAR is currently expected to fit on top of the SHAAFT. This could present some problems with bases having the capability to load the SCREMAR onto the SHAAFT in the situation where the SCREMAR must be diverted to a remote base. If a majority of bases do not have this capability, then they become useless. The means fitting the aircraft together, either to the SHAAFT or a 747, should either be transportable or extremely simple. The Beta concept of rolling the TAV/orbiter underneath the staging vehicle and then attaching it should be explored more.⁴ In any case, the SHAAFT should be able to get to any location of the SCREMAR and at least be able to return it to a staging base, if not launch another mission from where it is.

As previously mentioned, requirements dictate that rapid turnaround is a capability that should definitely be sought after. The ability for rapid turnaround extends primarily from the ability to perform maintenance and other ground operations. Normal maintenance and ground operations, such as refueling and reloading, should be able to be

accomplished in the desired time to meet the six to eight hour turnaround time requirement on the ground. Other maintenance and ground tasks, such as cleaning and damage repair, should be able to be accomplished within reasonable times. A good criteria would be approximately the same time it takes to accomplish these with today's fighter aircraft. Also of importance here are members of the ground crew. They play an important role in accomplishing all of the maintenance and ground tasks. They should be highly trained and specialized in accomplishing all of the necessary functions that occur on the ground.

Current launch systems are not standardized in their configurations. There is a definite need for standardizing launch vehicles and payload interfaces. Having payloads that are interchangeable among different vehicles increases the flexibility of both the payload and the launch system. This standardization also reduces the complexity involved with having to put similar payloads on different spacecraft or a variety of different payloads upon a single spacecraft, such as the SCREMAR. It could be done simply by using modular cargo bays that can be added and removed depending upon mission requirements and payload. Thus making it easier to reload cargo onto another spacecraft in the event that a mission is aborted prior to takeoff. The ability for cargo to be placed on different airframes allows for easier transportation of cargo to different bases. In a way, it also inherently implies that subsequent space transport systems will be developed. Having standardized payload interfaces also allows for the vehicle and payload to be prepared in parallel. Today's systems often require that the payload be prepared and loaded only after the vehicle is in place or vice-versa. Using modular cargo bays, the SCREMAR would be able to be prepared for launch and already loaded onto the SHAAFT while the cargo is still being modified. The cargo could be loaded into the SCREMAR either before or after connection to the SHAAFT.

Special Considerations

Because of SCREMAR's integration with the SHAAFT, there are two other important requirements: (1) the capability for horizontal takeoff and landing and (2) the capability for global reach from a suborbital flight path. Like previous requirements, these two also go hand in hand. The ability for horizontal takeoff will be provided by the SHAAFT. Having this capability allows for the SHAAFT/SCREMAR system to operate from any base with a sufficient support structure and a conventional Class A runway. This would be extremely important in the event that the enemy has taken out our current space facilities at Vandenberg AFB, California, and Cape Canaveral AFS, Florida. In the event of war, these bases would become primary targets for a nation trying to hinder our space control

capability. This ability also provides for greater flexibility in the planning, timing, and versatility of access-to-space missions.

Likewise, the capability for horizontal landing provides similar advantages along with others and is characteristic for both the SCREMAR and SHAAFT as individual aircraft. First is the reduced weight since the TAV/orbiter will be able to glide to a landing in a similar manner as the Shuttle. The landing gear would only have to be designed to support the nearly empty weight of the TAV/orbiter since almost all of the fuel will be spent in achieving orbit. Landing vertically on rockets after reentering the earth's atmosphere **not only** presents a challenge but also requires that additional fuel be carried in order to provide significant thrust as the vehicle reaches the ground. Conversely, vertical landing would provide for the capability to land practically anywhere a concrete pad could be laid. Although already demonstrated through programs such as the DC-X, this technology need not be exploited since a little fuel will remain in the SCREMAR in order to ensure global reach from a suborbital flight path. Also, being able to land in the middle of nowhere does little good if the SCREMAR can not be efficiently transported back to a base where it can be mated with the SHAAFT and its zero stage. Nevertheless, the capabilities of global reach from a suborbital flight path would allow the SCREMAR to reach and land on any conventional runway in the world. Which is very essential if our current facilities are destroyed, especially if they are destroyed while the SCREMAR is accomplishing a mission.

The requirements mentioned throughout this section seem to be the most critical requirements driving the design of the SCREMAR TAV/orbiter concept; however, they are not the only factors to be considered. If the access-to-space mission is to truly ever become cheap, flexible, and reliable, there are millions of other considerations that need to be taken into account. A couple of the more important of these considerations seem to stand out. First is the potential to develop both piloted and unpiloted versions of the SCREMAR. The first step lends itself to the piloted version since real-time control and on-hands experience will be necessary in accomplishing the prescribed missions. However, with increases in technology, unpiloted versions will allow for the accomplishment of almost all of the prescribed missions (with the possible exception of only on-orbit support) while providing less risk of human casualties. Having less manpower to operate would also be a substantial benefit since the entire mission could be controlled by one person on the ground.

As alluded to earlier, another important consideration is a modular cargo bay with standardized cargo and weapon modules. This speeds up the turnaround time significantly since subsequent missions can already be

preplanned and prepackaged before the TAV/orbiter even returns to the ground. It also reduces the costs of having to fit individual payloads to individual spacecraft cargo bays. A standardized system could be incorporated that could be applied to future spacecraft, reducing the need to continually redesign cargo.

The requirements, as defined throughout this section, play a critical role in determining the final design of the SCREMAR TAV/orbiter concept. Obviously, these are not the only factors involved in developing access-to-space technology, nor are they absolute. Although there are many factors to be considered, these consistently appear throughout various studies to be the most critical in developing ready, reliable, flexible access to space. Concentrating on these requirements yields the greatest possibility of developing an access-to-space vehicle that successfully accomplishes all of the missions previously presented in this study.

Missions

With the increasing importance being placed on space assets such as communication, intelligence, and GPS satellites, the US can not afford to overlook the drastic impact of having a significant portion of the existing satellite fleet wiped out. It takes dozens of satellites in a constellation just to make the constellation operational enough for practical applications. With today's launch capabilities, it normally takes months, or even years, to insert a satellite constellation into orbit. This is due to the inefficiencies of only being able to take up one or two satellites at a time with launch intervals that take months to be planned and executed.

With the future possibilities of threats that face space assets, the US must have a viable means of maintaining control of space. As with maintaining control over the air, there must be a space infrastructure designed to provide Force Enhancement, Force Support, and Space Control. The most likely solution to accomplishing these missions with a single system is Space Control with a Reusable Military Aircraft. A TAV/orbiter (fig. 4-1) roughly the size of an F-15 and capable of carrying a 3,000-pound payload to LEOs could fill the major facets of these missions by accomplishing ready, reliable spacelift and on-orbit support while also providing a platform for counterspace operations. In fulfilling these multiple roles, the advantages of flexible access to space with a single platform can be realized.

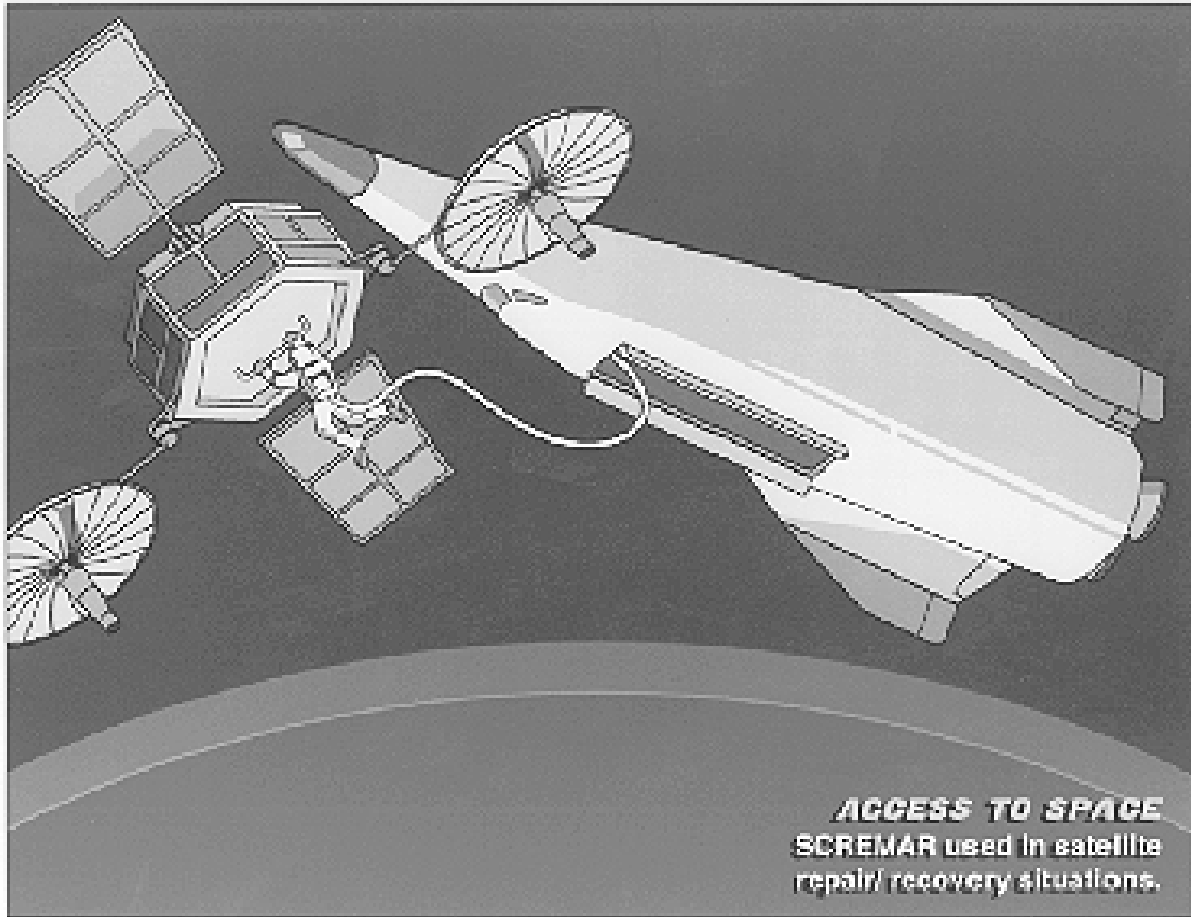

Figure 4-1. SCREMAR Performing Various On-Orbit Operations.

The three primary missions to be accomplished by the SCREMAR TAV/orbiter are (1) deployment/retrieval of satellites, (2) repair of damaged satellites on-orbit, and (3) antisatellite warfare against enemy space assets. These missions (fig. 1-3) help achieve the broader concepts of Force Enhancement with spacelift and replenishment of space assets, Force Support by providing on-orbit support, and Aerospace Control through counterspace and counterinformation tactics achieved with ASAT. However, with the capabilities of a small TAV/orbiter, other possible missions still exist. SCREMAR could also be used as weapons platform for launching key strikes from above (strategic attack) as well as reconnaissance platform to gain and disseminate tactical information and intelligence in real time (Information Operations and Combat Support). These missions could be accomplished by manned or unmanned versions of the SCREMAR.

Deployment/Retrieval of Satellites

The current successes enjoyed by US space operations are due primarily to the large, unopposed fleet of satellite constellations which has taken years to acquire. With an enemy capable of performing any of the various kinds of ASAT, these years and billions of dollars could become vain as the US would be unable to operate on the modern military battlefield. Having routine, easily accomplished access to space allows the effects of such a blow to be significantly reduced. This is best accomplished by the capability of ready, reliable deployment of satellites provided by a small TAV/orbiter. In a situation where the enemy has detonated a nuclear weapon, or a series of nuclear weapons, near satellite orbits, wiping out a majority of a constellation, the SCREMAR could be used to replenish destroyed satellites.

With a rapid turnaround mission time, the SCREMAR could deploy as many as six satellites within a single day. Time to get a complete satellite constellation on-line and operational could be reduced to just a few days. This limits the enemy's ability to downgrade our command, control, communication, and intelligence (C³I) operations for any significant period of time. Satellite replenishment could be used in any situation in which more satellites are desired, including the cases where an enemy has selectively destroyed several key satellites and just adding new constellations for various reasons. The TAV/orbiter could also be used to retrieve severely damaged satellites and return them to earth for repairs. Although the need for this mission is clear during war, it could also be accomplished during peacetime to aid in the normal deployment of satellites on a regular basis, also providing operational experience to the crews of the SHAAFT/SCREMAR platform so that they have the knowledge and understanding to accomplish the same missions during the accelerated pace of war.

Repair of Damaged Satellites

In the situations described previously, not all satellites will be destroyed. In some cases, it might be more cost and time efficient to have many of the damaged satellites repaired while in orbit. This is especially true if all of the satellites are in the same orbital plane. The SCREMAR TAV/orbiter could accomplish this by simply slowing down or speeding up within the orbital plane to dock with individual satellites and repair them real time. This significantly reduces the costs of an operation by not having to take as much of a payload into orbit (only the necessary tools and replacement parts) as well as the costs of not having to actually build replacement satellites. Time would be reduced

in that the in-orbit satellites would not have to be positioned nor configured. As soon as they are repaired, they would be on-line and ready to go.

This mission could also be accomplished in conjunction with the deployment/retrieval of satellites for maximum effectiveness, for example, the SCREMAR would reach orbit with replacement satellites and deploy them, repair the slightly damaged satellites, and retrieve the severely damaged satellites, all in one mission. As previously mentioned, the missions of spacelift and on-orbit support could also be performed during peacetime as a means of maintaining a viable satellite fleet as well as providing practice for routine access to space during wartime situations. This would be an essential portion of the training the crews receive.

Antisatellite Warfare

Another integral form in maintaining space control is space superiority. In a wartime situation, it is very plausible that our enemy will also have significant space assets. SCREMAR could be used to perform sophisticated ASAT to take out the enemy's "eyes" and "ears." Just as the destruction of our satellites could significantly hinder our C³I capabilities, so could the destruction of the enemy's satellites hinder theirs. Having the ability to gain an intelligence advantage over the enemy and to be able to communicate when they cannot provides a significant advantage, especially in the fast pace of the modern battlefield, as demonstrated in Desert Shield and Desert Storm.

This could be accomplished by fitting the SCREMAR TAV/orbiter with a weapons system capable of destroying satellites at varied ranges, perhaps a laser or other beam weapon. Also, the SCREMAR TAV/orbiter could simply "capture" the enemy's satellite, take it out of orbit, and bring it back to earth. The satellite could be dismantled and probed for valuable information with regards to the enemy. Another concept is to have the SCREMAR dock with the enemy satellite, similar to repairing operations (fig. 4-1), and "fix" the satellite so that it sends falsified information controlled by the US as a means of deceiving the enemy. This mission achieves several principles of war, including taking out the enemy's ability to see and communicate along with surprise by deception.

Additional Possibilities

Although these missions alone are enough to provide the US with the ability to control and exploit space, the SCREMAR is not limited to just these. Once the technology for a TAV/orbiter is developed, variations of the

SCREMAR could be developed to serve as a suborbital or space-based weapons platform (depending on the various treaty requirements) for attacking the enemy from overhead as part of a strategic attack or as a reconnaissance platform for gaining wartime intelligence in real time. The SCREMAR could serve as the ultimate standoff weapon by being able to attack well out of range of any enemy fighter or missile.

Possible weapon configurations include an extremely powerful laser for attacking pinpoint strategic locations and the capability to release either conventional or nuclear “brilliant” munitions from the cargo bay and guide them to their targets from a suborbital flight path. As a reconnaissance spacecraft, the SCREMAR could be used to direct a battle in real time by gaining valuable intelligence information from above and sending it to particular on-field commanders. The TAV/orbiter could also be used to gain information in a gap that working satellites do not cover.

Operations

Having a well-developed infrastructure does not mean just being able to provide maintenance to the SCREMAR while it is on the ground. The infrastructure must also have the necessary systems to allow the SHAAFT/SCREMAR to function operationally. This is in reference primarily to the control centers that communicate with, exchange information with, and direct operations of the SCREMAR. It is the operations of the SCREMAR that accomplish the missions, not the ground operations. Operationally, there are four phases of a mission that must be considered: (1) preflight, (2) takeoff/separation, (3) space operations, and (4) reentry/landing. Each is unique and presents its own challenges to the SCREMAR.

Preflight. The preflight phase includes all of the ground operations: mission planning, refueling, loading cargo, loading onto the SHAAFT, maintenance, etc. The importance of many of the factors to be considered during the preflight phase have already been addressed. The main focus in this phase is on the ability to have reliable and quick ground operations that allow for the SCREMAR to be launched on demand and accomplish successive missions rapidly. Of great importance is the ability to be able to reload the SCREMAR with cargo and onto the SHAAFT for a turnaround mission. It is in the other three phases where the SCREMAR as an operational vehicle will earn its money.

Takeoff/Separation. The takeoff/separation phase begins once the SHAAFT has started its takeoff roll and ends once the SCREMAR has successfully separated from the SHAAFT and is climbing to space under its own power. The SCREMAR will be loaded in a piggyback fashion aboard the SHAAFT. The SHAAFT will already be placed on its zero-stage flying wing. Essentially, the SCREMAR will take off by means of the SHAAFT’s and zero-stage’s engines

as a multiple-stage-to-orbit (MSTO) vehicle. Upon departure, the SHAAFT will separate from its zero-stage around mach 3.5 at 60,000 feet, as previously described in chapter 2. The SHAAFT will then continue to accelerate and climb to its maximum velocity of mach 12 at 100,000 feet. Here, a pop-up maneuver will be performed in which the SCREMAR will detach from the SHAAFT. Once free and clear from the SHAAFT's wake, the SCREMAR will ignite its rocket engines and accelerate to orbit.

There are a couple of very important factors that need to be examined during this phase. First is the shock/shock interactions that would occur during separation and the impact they would have on both the SHAAFT and the SCREMAR. If they cause significant problems, then ways to reduce the problems need to be sought, such as releasing or ejecting the SCREMAR directly backwards. Another consideration is how the maneuver should be performed to release the SCREMAR or if any maneuver needs to be performed at all. This is the most critical phase of the entire mission. More things could go awry here than at any other time, with a likely exception being the landing phase. Nevertheless, separations at these high speeds have never been demonstrated before and must be studied extensively in order to quantify the effects and reduce the chance for mishap. Other possibilities for failure during this phase, such as rocket engines not igniting, the SCREMAR not separating, etc. need to be carefully examined to ensure successful completion of the stage.

Space Operations and Reentry/Landing. The next phase is where the mission accomplishment occurs, space operations. This phase, although complex, has already been demonstrated in some respects by the Shuttle and other space vehicles. Similarly, so has the reentry/landing phase. Important items to be considered in these two phases have already had extensive research in past programs. Particularly, these items include thrusters for maneuver in space, thermal protection systems and gliding to a landing from a suborbital flight path.

The SCREMAR will require a means to maneuver in space, especially if it is going to dock with several satellites for retrieval, repair, and ASAT. Of essential importance is how much latitude the SCREMAR will have while maneuvering in LEOs. It is an extremely difficult task with limited maneuverability because of the proximity to the earth's atmosphere. Nevertheless, it can be accomplished by placing small thrusters at various points on the SCREMAR. They will also assist in maneuvering the TAV/orbiter into the proper position for reentry.

Thermal protection systems have been studied extensively. The capability to use heat absorbent tiles for reentry has been successfully demonstrated with the Shuttle; although a similar concept might not be recommended for the

SCREMAR. Nevertheless, a significant advancement in TPS would not need to be made for the SCREMAR to accomplish its mission other than what is required for the SHAAFT. This topic is also discussed further in chapter 5.

The ability to glide to a horizontal landing on a conventional runway has also been demonstrated by the Shuttle. The capability just needs to be improved so that global range to any conventional runway can be achieved from a suborbital flight path.

SCREMAR Vehicle Concepts

The design of the SCREMAR TAV/orbiter concept is driven primarily from the environments it must endure as well as the multiple mission profiles and the respective requirements. Increased cost benefits can be realized by increasing the vehicle's flexibility for multiple missions, using common logistics and operational procedures with other systems, using the existing infrastructure for support, and designing critical technologies in conjunction with other programs, such as the SHAAFT and SHMAC. A schematic of the SCREMAR TAV/orbiter concept can be seen in figure 4-2.

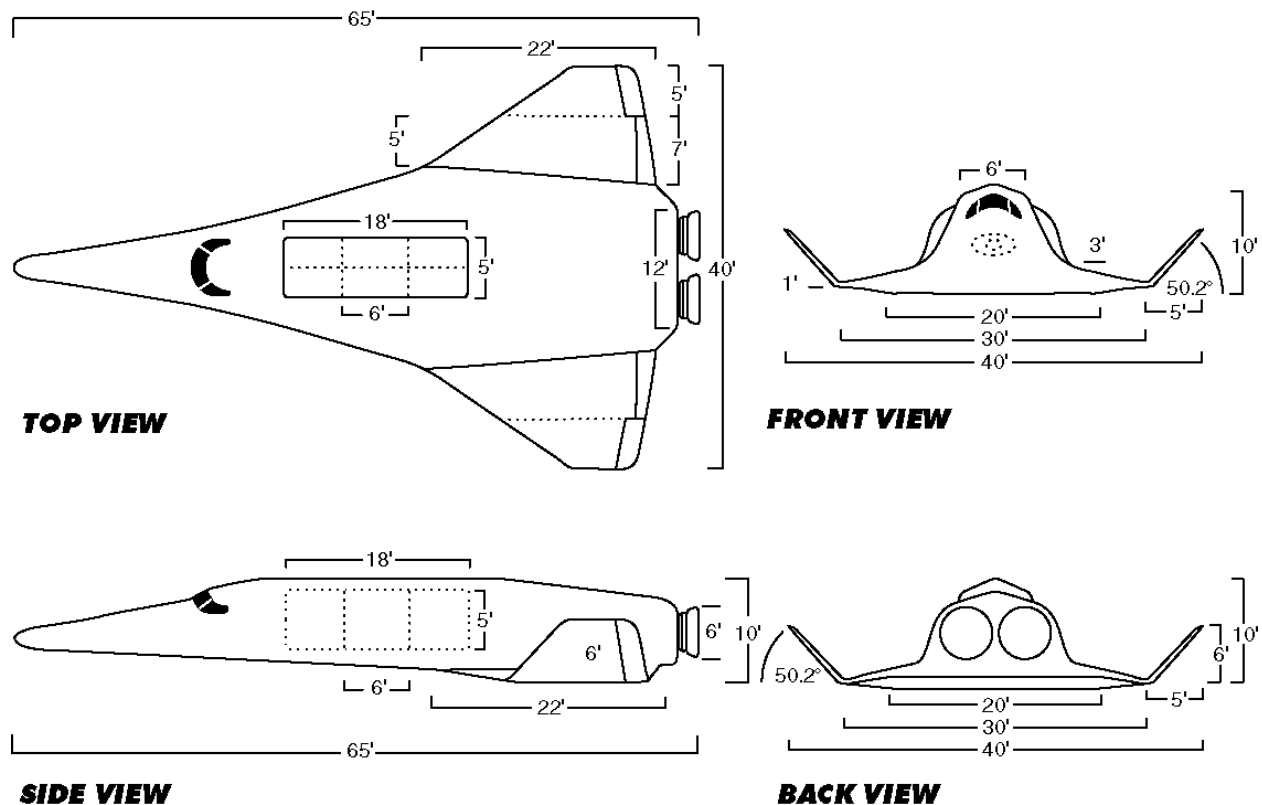

THE SCREAMAR

Figure 4-2. Space Control with a Reusable Military Aircraft (SCREAMAR).

The SCREAMAR is aerothermodynamically designed as a TAV/orbiter that piggybacks aboard the SHAAFT to a release point of mach 12 at 100,000 feet where it then separates and uses two rocket engines to boost up to orbit. It can carry a 3,000-pound payload to orbit, roughly the size of three 6 feet x 6 feet x 6 feet, 1,000-pound satellites. The cargo bay is 6 feet x 18 feet x 6 feet. With a modular cargo bay integration, payloads could vary anywhere from tools to satellites to weapons systems. Upon returning to the atmosphere, the TAV/orbiter would have the ability to reach and land on any Class A conventional runway worldwide. The design is simple enough so all that needs to be done once it returns is loaded with the new prepackaged payload, refueled, and reloaded onto the SHAAFT for another mission. Of course, due to the changing needs, the US has in the operational space environment versions that could be developed for both piloted and unpiloted vehicles.

As previously mentioned, the SCREAMAR TAV/orbiter concept is roughly the size of an F-15. It is 66 feet in length and a total wingspan of 40 feet. It has an inverse-cokebottle type of shape that is similar in some respects to that of a lifting body or waverider concept. The wings themselves are fairly short, being only seven feet long each

with a slight anhedral but rounded underside to produce a detached shock wave during reentry. Other concepts could have the wings with a slight dihedral and keeping everything else the same. Studies would need to be conducted on which design would be the most beneficial in terms of heating during reentry to the atmosphere, which provides the better lift to drag ratio in order to ensure global range from a suborbital flight path, and which is easier to integrate with the SHAFFT. Studies may also need to be conducted as to whether having the SCREMAR piggyback on top of the SHAFFT (as considered for this report) or whether it might be more beneficial to have the SCREMAR stored inside or underneath the SHAAFT, similar to the Beta concept.⁵

Considering the vertical stabilizer component of the wings, then each wingspan could actually be considered to be 12 feet. This is due to the fact that the vertical fins are actually canted at roughly 50° from the edges of the wings themselves. The reasoning for placing these vertical stabilizers in such a manner is so that lateral-directional stability can be maintained throughout the high angles of attack that occur during reentry as well as help lower the q_{∞} 's. This is why the vertical stabilizer of the Shuttle had to be enlarged; it was not very effective at the high angles of attack the Shuttle encountered during reentry since it was directly blocked from the airflow by the body. Since there is no inlet for an airbreathing portion of the engine, the entire body configuration can be even more aerothermodynamically designed to support the mission.

There are two rocket engines that would provide enough thrust to get the spacecraft to orbit. There would also be various other thrusters along the body so that the SCREMAR TAV/orbiter could maneuver in orbit. Roughly 75 percent of the TAV/orbiters gross takeoff weight would consist of fuel which would be loaded throughout the entire body, maximizing the available volume. The only areas that would not contain fuel would be the cargo bay, cockpit, and the nose forward of the cockpit where all of the electronics would be placed. As previously mentioned, the density of the fuel as well as the I_{sp} are critical in maintaining the ideal size and weight of the spacecraft. Studies as to which fuels are the most efficient in terms of both I_{sp} and density are discussed further in chapter 5 as well as other important design considerations.

Component Summary

The SCREMAR TAV/orbiter concept has the capability to fulfill all of the tenets of aerospace power: Force Enhancement, Force Support, Aerospace Control, and Force Application. It can perform the missions of spacelift, on-

orbit support, counterspace, and possibly strategic attack and reconnaissance. It provides a direct contribution to the missions of C³I operations and counterinformation operations which are accomplished by the satellites it deploys. Refinements may also be used as part of a strategic attack and combat support operations. The use of a small TAV/orbiter, such as SCREMAR, allows for responsive, reliable, flexible access to space in all situations that are crucial to controlling and exploiting space.

The technologies needed for the SCREMAR should be developed in conjunction with the SHAAFT and SHMAC and from other similar programs to reduce time and costs. The infrastructure for supporting the SCREMAR should be developed from existing infrastructures. Because of the integrated nature of the SCREMAR with the SHAAFT, an integrated infrastructure should also be developed. This is because the SCREMAR functions operationally by means of the SHAAFT. Maintenance and other ground operations should be able to be accomplished within the times of what is already required for today's fighters.

There is also a need for standardization among launch vehicles and payload interfaces. In reducing planning, preparation, and turnaround times, the payload and spacecraft should be able to be prepared in parallel. The infrastructure should be able to allow the SHAAFT/SCREMAR to be launched on demand from a quick-reaction alert status while also allowing for the use of the widest number of bases possible. The infrastructure should be designed so that the SHAAFT/SCREMAR can function operationally similarly to today's aircraft.

There is no doubt that space is going to be the battlefield of tomorrow. The SCREMAR TAV/orbiter concept is designed to fulfill a vital role in maintaining control over that battlefield. It is intended to build off of the technologies and infrastructures that already exist or are in the process of being developed. Because of the simplicity of the SCREMAR and the reliance on near-term technologies, a significant breakthrough in technological achievement will not be required. This makes the development costs cheaper and the development time shorter. The SCREMAR, or similar vehicle, is destined to become a mainstay in the fleet of the US Air Force's vehicles. It is the capabilities of such a vehicle that will ensure that the US is able to control and exploit space for years to come through reliable, flexible, routine access to space. This concept will **enable the United States to Screaming into the Future!**

Notes

¹ R. M. Zurbin and M. B. Clapp, "An Examination of the Feasibility of Winged SSTO Vehicles Utilizing Aerial Propellant Transfer,": AIAA 94-29-23, 30th Joint AIAA/ASME/SAE/ASEE Joint Propulsion Conference, Indianapolis, Indiana, June 1994.

² R. M. Zurbin and M. B. Clapp, “An Examination of the Feasibility of Winged SSTO Vehicles Utilizing Aerial Propellant Transfer,; AIAA 94-29-23, 30th Joint AIAA/ASME/SAE/ASEE Joint Propulsion Conference, Indianapolis, Indiana, June 1994.

³ E. Hoegenauer and D. Koelle, “Saenger, the German Aerospace Vehicle Program,” AIAA-89-5007, AIAA First National Aero-Space Plane Conference, Dayton, Ohio, July 1989.

⁴ Ibid.

⁵ Ibid.

Chapter 5

Critical Technology Requirements

Cruise Phase Velocity Study: The Driving Force

Defining the mission of SHAAFT was crucial to determining what type of vehicle was required. Similarly, defining the cruising velocities is vital to determining generic vehicle size, shape, performance, and supporting elements in the attack mission. This study considered two mach numbers (8.0 and 12.0) at which to fly. These two mach numbers represent the best means in which to achieve the desired survivability. mach 8.0 characterizes the highest velocity in which endothermic hydrocarbons can be effective in scramjet engines, while being used as a coolant for aircraft surface skins. mach 12.0 requires cryogenic fuels, such as liquid hydrogen, that can be used as an active coolant to accommodate extreme aircraft heating. However, active cooling requires a great deal of pipes, gasket, and seals which must be maintained. This report assumes that material strengths will be great enough by the year 2025 (as will be discussed later) such that this type of cooling will not be necessary. Therefore, mach 12.0 appeared to be the best design choice.

One advantage of mach 12 flight involves the usage of current technology. Although developing cryogenic facilities for the SHAAFT would cost money, much of the technology exists for handling mass quantities of liquid or even slush hydrogen. Furthermore, with slush hydrogen, SCREMAR deployment would occur at a higher velocity, increase satellite payload capability or increasing the orbital altitude.

Table 2 summarizes the positive and negative points of limiting the mach number to eight. Table 3 summarizes the same points for mach 12. Overall, the advantages of mach 12 flight appeared much greater than mach 8 and resulted in their incorporation into the SHAAFT. These key benefits include the reduction of the logistics arm

required to support an allied attack on foreign land, the increased survivability, and expedient nature of attack. Also, a higher range results from higher velocity, thus conserving fuel.

Table 2

Parameters Considered for the Supersonic/Hypersonic Attack Aircraft (SHAAFT) at Mach 8 Flight

Pros	Cons
<ul style="list-style-type: none"> ● Hypersonic vehicles powered by ● air-breathing propulsion systems with endothermic hydrocarbon fuels should be possible with reasonable advances in the technology of endothermic hydrocarbon fuels and in dual-mode ramjet/scramjet combustors. <p>* The increased density of endothermic hydrocarbons means that less volume is required for fuel. As a result, it is easier to generate aerodynamically efficient configurations.</p> <p>* Endothermic hydrocarbons are easier to store and easier to transfer. This simplifies base operations and preflight activities. It probably also saves on training of ground personnel relative to the safe handling of fuels. These features also simplify transporting personnel and supplies to a non-CONUS recovery base.</p> <p>* Since the SHMACs (the standoff weapons to be delivered by the SHAAFT) fly at mach 8, a flight mach number of eight for the SHAAFT presents no problems relative to the deployment of these weapons.</p>	<p>* Endothermic hydrocarbons have lower specific impulse and lower cooling capacity than cryogenics (liquid hydrogen/liquid oxygen). As a result, if one uses endothermic hydrocarbons, the range is decreased and the time of flight to the target area is increased.</p> <p>* Preliminary studies have shown that the mach number at which the SCREMAR (the TAV) is staged has a significant impact on the weight and the size of the TAV. This also affects the size and number of satellites that can be carried to orbit. Thus, it is possible that features which produce savings on the vehicle and on the infrastructure to support the SHAAFT may increase the cost of the SCREMAR and the cost of getting payloads to space. The trade studies conducted in support of the design of the integrated, multivehicle weapons system should consider the interdependence of such phenomena.</p>

Table 3

Parameters Considered for the Supersonic/Hypersonic Attack Aircraft (SHAAFT) at Mach 12 Flight

Pros	Cons
<ul style="list-style-type: none"> * Aircraft is much more survivable * Pilot fatigue is reduced by cutting the total amount of flight time—in the worst-case scenario, this could save the life of the SHAAFT * Decreases time to target (response time) * Increases range due to increased specific impulse of slush hydrogen versus endothermic hydrocarbons * Increased velocity results more design options for SCREMAR access-to-space vehicle * It is more advantageous to launch the SHMAC missile from a higher speed and decelerate rather than low speed and a need to accelerate (like an F-15 launch) * Technology already exists to handle mass quantities of cryogenic fuels 	<ul style="list-style-type: none"> * Increased surface heating poses several problems. Material concerns, thermal expansion, and aero-acoustic problems all increase in magnitude. If active cooling is used, fuel pumps, gaps, and seals will drive up complexity and cost of the design. * Base infrastructure, logistical support must be created at the SHAAFT base to support cryogenic fuels, which are inherently more expensive and complex * Low density of slush hydrogen means a larger fuel volume—this increases drag, which increases the required fuel, which drives up the size of vehicle even further

While some parts of the missile design already exist, much research and development is required in other areas. This is particularly true in the case of the scramjet propulsion system which allows the missile to sustain mach 8 flight. One design challenge is sizing the combustion chamber. It must be long enough to allow adequate air and fuel mixing and combustion within the engine. For example, flow going through a 15-foot-long missile at mach 2.0 (2,000 fps) will be contained within the scramjet chamber for approximately 0.007 seconds. This is an incredibly short time and does not allow for efficient mixing and combustion of all the fuel and air in the chamber of the scramjet using conventional fuel mixers and igniters.¹

While new rocket fuels are not a must, it would certainly be desirable to have fuels available with higher specific impulses (I_{sp}). These are particularly needed for the ground and sea-launched versions since they will have to be accelerated from a standstill at ground level and will therefore not have the speed and altitude advantages of the air-launched versions.

Structurally, the missile will have to withstand the high initial acceleration of the rocket boost phase and maneuvering en route to the target. The average load factor in the acceleration phase is nine Gs. This is a consideration since it is desirable to keep the overall weight of the missile as low as possible.

Better high-speed guidance, targeting, and control systems will also need to be developed if the SHMAC's capability is to be maximized. For example, it is believed that the SHMAC could be used in 2025 to intercept ballistic missiles in flight, although with current technology, this is not very feasible. However, with all of the research currently going on in this area, it is very possible that this mission will be one of the SHMAC's.

Thermal Protection Systems

The expected temperature extreme on the SHMAC is approximately 3,400 °R for a leading edge radius of 1.0 in. This was based on calculations of the stagnation point heating rate as it varies with the nose radius and altitude of the vehicle.

The variant used in the shuttle is LI-900 (Lockheed Insulation, nine pounds per cubic foot) and LI-2200 (22 pounds per cubic foot) which are used to cover 50 percent of the exterior of the shuttle orbiter. They can withstand temperatures as high as 2,300 °F. The black radiative coating applied to these silica tiles allows 90 percent of the heat generated upon reentry to be radiated back out into the atmosphere. The temperatures on the shuttle's aluminum skin never exceed 350 °F.

FRCI-12 was used to replace LI-2200 and by so doing reduced the shuttle weight by 1,000 pounds. FRCI stands for Fibrous Refractory Composite Insulation and weighs 12 pounds per cubic foot. It is just as strong as LI-2200. It is tested up to 2,400 °F with gradual reduction in strength beginning at approximately 1,600 °F.

LI-900 has no organic constituents that will outgas to contaminate scramjet combustion chamber parts or equipment. It also does not weaken with increasing heat loads. It can withstand 2,500 °F and does not degrade until 3,100 °F. It is inert, therefore it does not react with most fluids and substances. Any of these variants will be acceptable for use on the SHMAC.

Flexible external insulation (FEI) was developed as an element for HERMES. Produced in blankets which bond to the primary structure. The bonding surface must not exceed 650 °C during normal flight conditions, a maximum of 800 °C is permitted for short periods of time in case of an emergency. FEI will be dimensioned such that its back

surface does not normally exceed 200 °C. It is sensitive to acoustic loads and tends to exhibit aerodynamic flutter. The density of it is 2,200 Kg/m³.

Honeycomb TPS is applied in panels. It is generally used for hot structures and heat shields which rely on thermally resistant materials and connections between core and cover sheets. Honeycomb TPS is attached by screw connections through the upper plate which have to be protected by ceramic plugs. This structure must be vented to allow for pressure equalization due to altitude and high speeds. The density of this material is 4.43g/m³.

Multiwall TPS is being developed at NASA. This consists of dimple foils made of superplastic forming and shear foils. Used for the heat shield and at the panel back face. Upper surface is coated with highly emissive Al₂O₃. This construction principle can be used with different metallic alloys depending on the temperature range desired. Density: 4.43 g/m³ to 8.98 g/m³.

Ceramic shingles are associated with the HERMES program. This consists of intermediate multiscreen insulation with ceramic and coated screens separating individual layers from quartz silica fibers. Panel mass depends on material thickness which results from a tradeoff between manufacturing technology and mechanical panel design. Still under development in France and Germany. This material has a density of 2.2 g/cm³.

A new thermal protection technology currently under development by the Ames Research Center division of the National Aeronautics and Space Administration is ultrahigh temperature ceramics (UHTC). These ceramics are generally formulated from dibromide compounds. Experiments have validated these ceramics' ability to withstand temperatures up to 3822 °R.

In order to choose a proper thermal protection system, the tradeoff between cost for a UHTC against the effect an ablator will have on aerothermodynamic performance must be weighed. The advantage of the UHTC is that the shape of the leading edges of the missile will not change throughout the course of the flight. A disadvantage is its high cost due to its recent development as a revolutionary technology. Although the cost of ablators is attractive, the drawback is the changing shape of leading edges caused by the ablator burning off throughout the course of the flight and any possible effects this may have on the control and propulsion system of the missile.

Conclusion

For all of the possibilities described throughout this paper, the US needs a flexible, robust, easily planned and executed capability for global reach/global power and for access to space. The SHAAFT would serve as a mobile platform for deploying a widerange of UAV assets. The SHMACs would destroy key targets, including space ports, communications centers, computer centers, time critical targets, etc. The SCREMAR would serve the many war-time applications which require access to space. Thus, the integrated S³ (SHAAFT, SHMAC, SCREMAR) weapons system that has been described can perform Counterspace tasks for Aerospace Control, tasks of Strategic Attack, of C² Attack, of Interdiction for Force Application, Aerospace Replenishment and Space Lift tasks for Force Enhancement, and On-Orbit Support for Force Support.

Furthermore, it is quite possible (perhaps, even likely) that, at the outset of hostilities, our adversary has created significant damage to our space launch complexes (just as we did to theirs with our SHAAFT mission), leaving the United States in an “Infrastructure Poor” situation (the term is attributed to Maj. (sel) M. B. Clapp). Thus, we need to be able to launch our global-range air and space missions from conventional military bases. The integrated, hypersonic weapons system described in this paper allows the US to accomplish a diverse set of missions, with a highly survivable, lethal weapon system capable of deterring and/or punishing adversaries anywhere in the world.

There is still room for further research and development. The first among these areas is the need for study on propulsion systems and the technology development for scramjet/rocket engines. Other areas to consider for further study include enhanced and improved thermal protection systems. Research developments are expected in finding ways to communicate through hot plasma boundary layers for continual data uplinks.

Also included in the need for further research are understanding shock/shock interactions at high speeds that the weapons systems would be operating at. Advances in the capabilities and accuracy of CFD are needed to explore the flight regimes that S³ will operate within.

It is of importance to note that most of these technologies have already been developed or are in the process of being developed. It is also important to realize that each advancement taken in a particular area aids in the development of not just one weapons unit, but to the entire S³ weapons platform, as well as other technology areas that will be important to the growth and survival of the US in the world of 2025.

¹ Frederick S. Billig, "Tactical Missile Design Concept," *Johns Hopkins APL Technical Digest*, 139–54.

Bibliography

- Abbot, Ira H., and Albert E. Von Doenhoff. *Theory of Wing Sections*. New York: Dover Publications, Inc. 1949.
- Anderson, John D. *Introduction to Flight*. New York: McGraw-Hill, Inc. 1989.
- Bertin, John J., and Michael L. Smith. *Aerodynamics for Engineers*. Englewood Cliffs, N.J.: Prentice Hall. 1989.
- Gord, Ron. Personal Communication Concerning the Weight Per Wing Area of Conventional Aircraft. 25 January 1996.
- Grallert, H. and K. Vollmer. *Conceptual Design of the Thermal Protection System for the Reference Concept SAENGER by Means of Advanced Methods*. Deutsche Aerospace AG. 3 December 1993.
- “Spacecast 2020: Spacelift - Suborbital, Earth to Orbit, and on Orbit.” *Airpower Journal*. Summer 1995.
- Waltrup, Paul J. “Hypersonic Airbreathing Propulsion: Evolution and Opportunities.” Applied Physics Laboratory, The Johns Hopkins University, April 1987.
- Waltrup, Paul J., Frederick S. Billig, and Richard D. Stockbridge. “Engine Sizing and Integration Requirements for Hypersonic Airbreathing Missile Applications.” Applied Physics Laboratory, The Johns Hopkins University.

Strikestar 2025



A Research Paper
Presented To

Air Force *2025*

by

Col (Sel) Bruce W. Carmichael
Maj Troy E. DeVine
Maj Robert J. Kaufman
Maj Patrick E. Pence
Maj Richard S. Wilcox

August 1996

Disclaimer

2025 is a study designed to comply with a directive from the chief of staff of the Air Force to examine the concepts, capabilities, and technologies the United States will require to remain the dominant air and space force in the future. Presented on 17 June 1996, this report was produced in the Department of Defense school environment of academic freedom and in the interest of advancing concepts related to national defense. The views expressed in this report are those of the authors and do not reflect the official policy or position of the United States Air Force, Department of Defense, or the United States government.

This report contains fictional representations of future situations/scenarios. Any similarities to real people or events, other than those specifically cited, are unintentional and are for purposes of illustration only.

This publication has been reviewed by security and policy review authorities, is unclassified, and is cleared for public release.

Contents

<i>Chapter</i>	<i>Page</i>
Disclaimer	ii
Illustrations.....	v
Tables.....	vi
Preface.....	vii
Executive Summary	viii
1 Introduction.....	1
2 Historical Development and Employment.....	2
The Early and Cold War Years.....	3
The Gulf War and Its Aftermath.....	6
3 The Need for A Strike Unmanned Aerial Vehicles	13
Current Forces	13
Required Capability.....	16
Milestones	18
4 Developmental Considerations	21
Pro-Pilot Bias.....	22
Budget Competition — Space-Based, Air Breather, or Both.....	24
Public Accountability	27
Imposed Limitations.....	27
Man-in-the-Loop.....	28
Redundancy.....	29
Responsiveness.....	30
Reliability.....	30
Summary	31
Conclusion.....	31
5 StrikeStar Technology.....	33
Airframe Technology.....	36
On-Board Control Systems	38
Propulsion System	40
Weapon Systems.....	41
Communications Systems.....	44
Mission Control Equipment	46
Launch and Recovery Equipment.....	46
6 StrikeStar Concept of Operations.....	50
The Dawn of a New Era for Airpower.....	50

<i>Chapter</i>	<i>Page</i>
Roles and Missions.....	52
Concepts of Employment	54
The System Architecture	54
Autonomous Strike Mission	57
Command Directed Mission.....	59
Critical Tasks and Weapons Employment.....	60
7 Conclusions.....	63
<i>Appendix</i>	<i>Page</i>
A Unmanned Aerial Vehicle Reliability	66
B Worldwide Unmanned Aerial Vehicles.....	71
C Contributors.....	75
Bibliography.....	77

Illustrations

<i>Figure</i>	<i>Page</i>
2-1. D-21 Tagboard	4
2-2. BQM-34 UAV, Tomcat.....	5
2-3. BQM-34 UAV with Stubby Hobo.....	6
2-4. Pioneer on Sea Duty	7
2-5. The Predator UAV	8
2-6. The Global Hawk UAV	9
2-7. The DarkStar UAV	10
3-1. The Shrinking Military Budget.....	14
3-2. Fighter Force Projection for 2025	15
5-1. Twin-Boom Hunter UAV	36
5-2. Notional StrikeStar	37
5-3. StrikeStar Notional Avionics.....	39
5-4. Global HF Network Coverage.....	45
5-5. Rocket-Assisted Hunter UAV Launch.....	47
6-1. StrikeStar Coverage.....	52
6-2. StrikeStar C ² Architecture	55
6-3. A System of Systems Over Time Continuum.....	56
6-4. StrikeStar Mission Profile	59

Tables

<i>Table</i>	<i>Page</i>
1 US UAVs, System Characteristics	34
2 StrikeStar System Characteristics	35
3 Fuel Characteristics	41
4 Ryan Model 147 UAV Flight Statistics	67
5 Pioneer UAV Flight Statistics	68
6 Early Hunter UAV Flight Statistics	68
7 Predator UAV Flight Statistics	69
8 Worldwide UAV Systems	71

Preface

We examined unmanned aerial vehicles (UAV), knowing that similar research had produced naysayers and even some active hostility. However, we are genuinely concerned for future modernization efforts as budgets and manpower decrease. We came to an early conclusion that manned vehicles provide a flexibility and level of accountability far beyond that of unmanned vehicles. But considering our changing world, the use of unmanned vehicles for missions beyond reconnaissance is both technically feasible and cost-attractive. We envision the UAV proposed here to be a force multiplier for the air and space warrior—a new tool in the warrior’s arsenal.

Executive Summary

The United States military of the year 2025 will need to deal with a wide variety of threats in diverse parts of the world. It will be faced with budgetary restraints that will dictate system trades favoring those military elements that offer utility over a wide spectrum of conflict and add to the ability to project power over long distances. The United States military of the year 2025 will also exist in a social and political environment that will dictate the need to minimize United States personnel losses and enemy collateral damage.

An opportunity exists to exploit planned advances in intelligence, surveillance, reconnaissance, and the development of unmanned aerial vehicles (UAV) to address future military needs. Through all-source, coordinated intelligence fusion, it will be possible to supply the war fighter with all-weather, day or night, near-perfect battlespace awareness. This information will be of precision targeting quality and takes advantage of multiple sources to create a multidimensional view of potential targets. Early in the twenty-first century, reconnaissance UAVs will mature to the extent that reliable, long-endurance, high-altitude flight will be routine, and multiple, secure command and control communications links to them will have been developed.

The obvious extension of these developments is to expand UAV use to include lethal missions. In 2025, a stealthy UAV, we refer to as “StrikeStar,” will be able to loiter over an area of operations for 24 hours at a range of 3,700 miles from launch base while carrying a payload of all-weather, precision weapons capable of various effects. Holding a target area at continuous risk from attack could result in the possibility of “air occupation.” Alternatively, by reducing loiter time, targets within 8,500 miles of the launch and recovery base could be struck, thus minimizing overseas basing needs.

A concept of operations for this UAV will include various operation modes using the information derived from multiple sources to strike designated targets. In developing and fielding this type of a weapon system, a major consideration will be carrying weapons aboard unmanned vehicles. However, the StrikeStar

UAV concept has the potential to add new dimensions to aerial warfare by introducing a way to economically and continuously hold the enemy at risk from precision air attack.

Chapter 1

Introduction

The 2025 study was chartered to look at twenty-first century airpower needs and postulate the types of systems and capabilities that would be useful to future war fighters. This paper targets the potential contributions of unmanned aerial vehicles (UAV) to the future war fighter. Specifically, it looks at an expansion of the UAV's role from its present reconnaissance emphasis to encompass a multimission strike role. Although open-source literature speaks of using UAVs in combat support roles, less has been written about the use of such aircraft as lethal platforms. This paper helps to address this shortcoming and should stimulate the thinking necessary to make the organizational and cultural changes that will utilize UAVs in this new role.

The paper is organized to show where we are in the field of UAVs, delineate the need for this new capability, and discuss some nontechnical considerations that must be addressed before this capability is fielded. It then looks at the technology required to bring this concept to fruition, and, finally, shows the ways a lethal UAV could be employed.

It should be understood there is a variety of forms a lethal UAV could take as well as a variety of performance capabilities it could exhibit. The concept of lethal UAVs found in the Air Force Scientific Advisory Board's *New World Vistas: Air and Space Power for the 21st Century* is but one form a lethal UAV could take. Their concept of a high-speed, highly maneuverable UAV capable of performance far greater than current manned fighter aircraft offers one future capability. This paper looks at a different UAV capability emphasizing long-loiter and cost-effectiveness. This is a concept of "air occupation"—the ability to hold an adversary continuously at risk from lethal or nonlethal effects from the air.

Chapter 2

Historical Development and Employment

Unless you plan your strategy and tactic far ahead, unless you implement them in terms of weapons of tomorrow, you will find yourself in the field of battle with weapons of yesterday.

—Alexander de Seversky

The United States Air Force will remain actively engaged in all corners of the globe and at all levels of the conflict spectrum. Yet at the same time, the military budget is decreasing, overseas bases are closing, and there is political and social pressure to keep United States and adversary casualties to a minimum in any future conflicts. The situation, as described, is unlikely to change much in the future. As the Air Force adapts to this new set of realities and meets its commitments to the nation, it will need to look at new ways and methods of doing business. One of the most promising future possibilities is the increased use of unmanned aerial vehicles (UAV) to perform tasks previously accomplished by manned aircraft. Unmanned aircraft have the potential to significantly lower acquisition costs in comparison with manned alternatives, thus enabling the fielding of a more robust force structure within constrained budgets. Unmanned aircraft can also be tasked to fly missions deemed unduly risky for humans, both in an environmental sense (i.e., extremely high-altitude or ultra long-duration flight) as well as from the combat loss standpoint. The Department of Defense (DOD) recognized the potential value of the UAV through its support of the Defense Airborne Reconnaissance Office's (DARO) advanced concept technology demonstrations (ACTDs) of a family of long-endurance reconnaissance UAVs. However, the DARO UAVs, along with other improvements in reconnaissance and communications, will lead to even greater possibilities in the use of UAVs to project precision *aerospacepower*¹ to all parts of the world and to remain engaged at any level of conflict.

The Early and Cold War Years

The use of UAVs is not a new experience for the United States armed forces or those of many other states. The German use of the V-1 in World War II showed that unmanned aircraft could be launched against targets and create a destructive effect.² Unfortunately, the V-1 was a “use and lose” weapon. Once launched, it was designed to destroy itself as well as the target. In the 1950s, the United States developed an unmanned intercontinental-range aircraft, the Snark. Designed to supplement Strategic Air Command’s manned bombers in nuclear attacks against the Soviet Union, this unmanned aircraft also destroyed itself as it destroyed the target. In effect, these were precursors of today’s cruise missile.

In the United States, the UAV has normally been associated with the reconnaissance mission and designed to be a recoverable asset for multiple flight operations. The remotely piloted vehicles (RPV) of the early 1960s were developed in response to the perceived vulnerability of the U-2 reconnaissance aircraft, which had been downed over the Soviet Union in 1960 and again over Cuba in 1962.³ “Red Wagon” was the code name for a 1960 project by Ryan Aeronautical Company to demonstrate how its drones could be used for unmanned, remotely guided photographic reconnaissance missions.⁴ As early as 1965, modified Ryan Firebee drones were used to overfly China with some losses experienced.⁵

In 1962, in conjunction with the development of the Central Intelligence Agency’s manned A-12 (similar to the SR-71 Blackbird) reconnaissance aircraft, Lockheed began development of the D-21 supersonic reconnaissance drone (fig. 2-1). The D-21 (code-named “Tagboard”) was designed to be launched from either the back of a two-seat A-12 (designated M-12 for this project) or from under the wing of a B-52H.⁶ The drone could fly at speeds greater than Mach 3.3, at altitudes above 90,000 feet, and had a range of 3,000 miles.⁷ At the end of the D-21’s mission, the reconnaissance and navigation equipment as well as the exposed camera film could be parachuted away from the airframe and be recovered by a specially equipped aircraft.⁸ The project was canceled in 1971 due to numerous failures and the high cost of operations.⁹

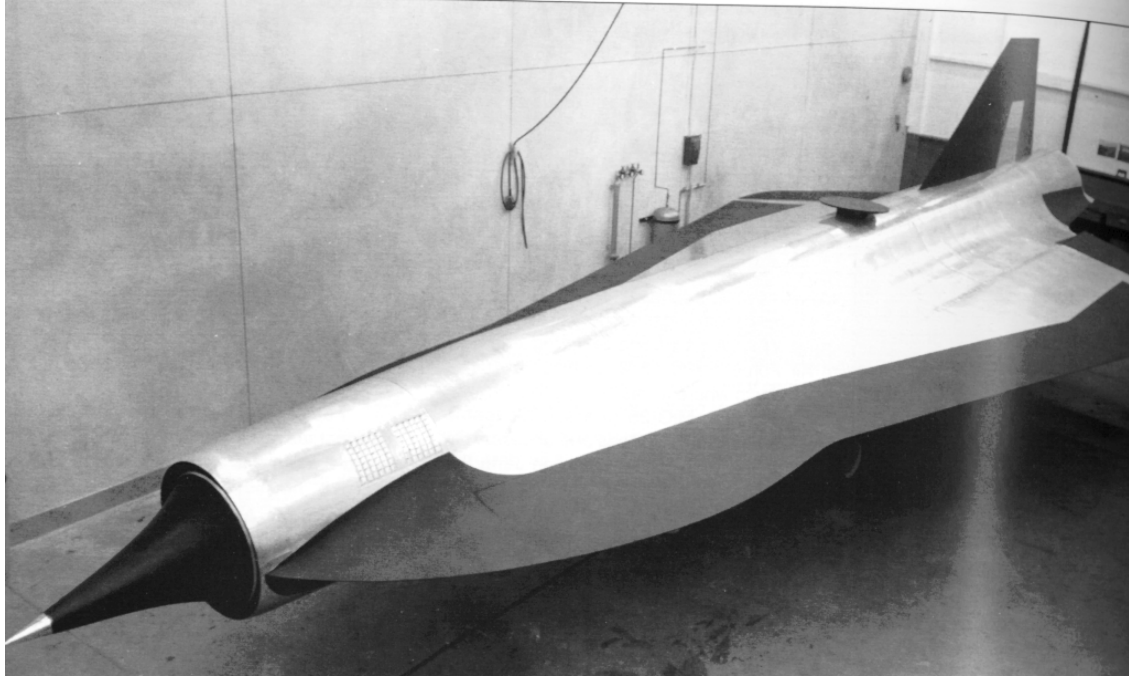

Figure 2-1. D-21 Tagboard

The best known United States UAV operations were those conducted by the United States Air Force during the Vietnam War. Ryan BQM-34 (Ryan designation: Type 147) “Lightning Bug” drones were deployed to the theater in 1964.¹⁰ From the start of operations in 1964 until missions were terminated in 1975, 3,435 operational drone sorties were flown in Southeast Asia by the Strategic Air Command’s 100th Strategic Reconnaissance Wing.¹¹ These air-launched UAVs flew both high (above 60,000 feet) and low (below 500 feet) altitude missions. Mission durations were as long as 7.8 hours. Types of missions flown included photo reconnaissance, leaflet dropping, signals intelligence collection, and the laying of radar-confusing chaff corridors to aid penetrating strike aircraft.¹² The average life expectancy of a drone in Southeast Asia was 7.3 missions with one aircraft, the Tomcat, flying 68 missions before being lost (fig. 2-2). Recovery rates for operational unmanned aircraft in Southeast Asia were approximately 84 percent with 2,870 of the 3,435 sorties recovered.¹³



Figure 2-2. BQM-34 UAV, Tomcat

In addition to the reconnaissance role, Teledyne Ryan also experimented with lethal versions of the BQM-34 drone. In 1971 and 1972, drones were armed with Maverick missiles or electro-optically guided bombs (Stubby Hobo) in an attempt to develop an unmanned defense suppression aircraft to be flown in conjunction with manned strike aircraft (fig. 2-3). The thinking behind this project was that an unmanned aircraft “. . . doesn’t give a damn for its own safety. Thus every unmanned bird is a potential Medal of Honor winner!”¹⁴

The Israelis effectively used UAVs in 1973 and 1982. In the 1973 Yom Kippur War, the Israelis used UAVs as decoys to draw antiaircraft fire away from attacking manned aircraft. In 1982, UAVs were used to mark the locations of air defenses and gather electronic intelligence information in Lebanon and Syria. During the war, the Israelis used UAVs to continually monitor airfield activities and use the information that was gathered to alter strike plans.¹⁵

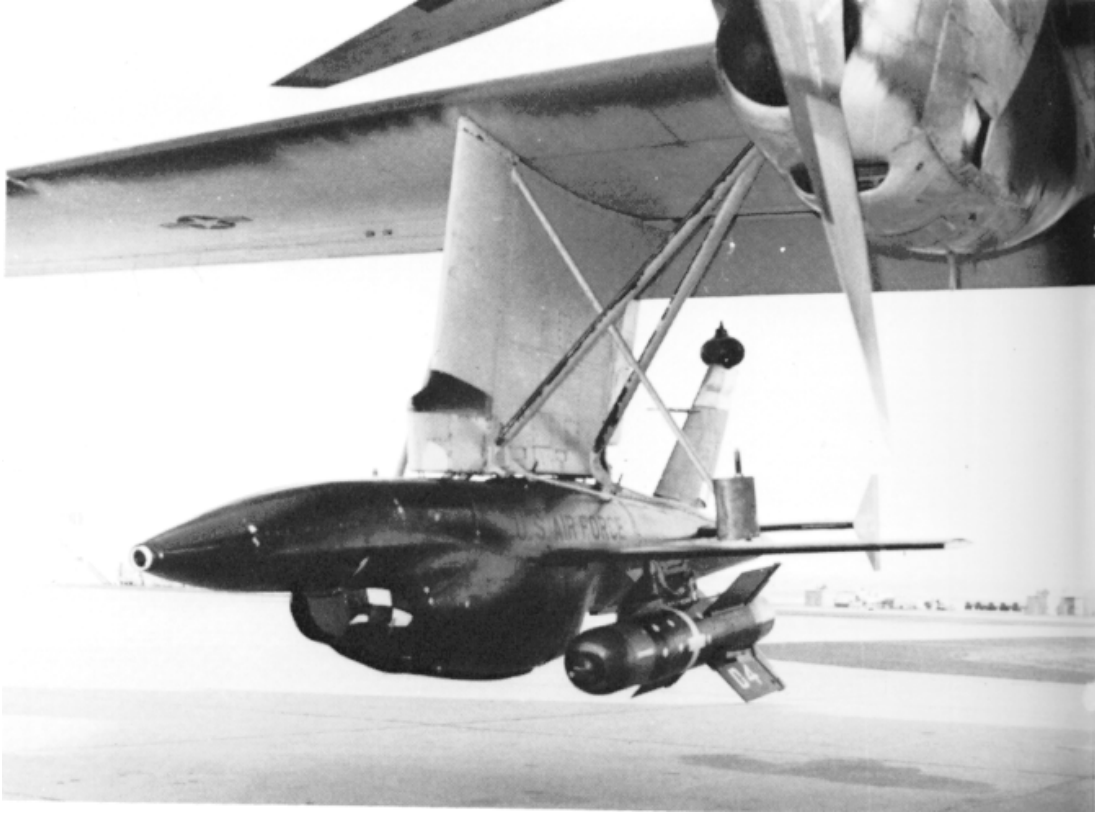

Figure 2-3. BQM-34 UAV with Stubby Hobo

The Gulf War and Its Aftermath

The United States “rediscovered” the UAV in the Gulf War. The Pioneer UAV (fig. 2-4) was purchased by the Department of the Navy to provide inexpensive, unmanned, over-the-horizon targeting, reconnaissance, and battle damage assessment (BDA).¹⁶ The Army purchased the Pioneer for similar roles and six Pioneer systems (three Marine, two Navy, and one Army) were deployed to Southwest Asia to take part in Desert Storm. During the war, Pioneers flew 330 sorties and more than 1,000 flight hours.¹⁷

In the aftermath of the Gulf War, the United States began to look more closely at the use of the reconnaissance UAV and its possible use to correct some of the reconnaissance shortfalls noted after the war. Space-based and manned airborne reconnaissance platforms alone could not satisfy the war fighter’s desire for continuous, on-demand, situational awareness information.¹⁸ As a result, in addition to tactical UAVs, the United States began to develop a family of endurance UAVs that added a unique aspect to the UAV program.¹⁹ Three different aircraft comprise the endurance UAV family.



Figure 2-4. Pioneer on Sea Duty

The Predator UAV is an outgrowth of the CIA-developed Gnat 750 aircraft (fig. 2-5).²⁰ Also known as the Tier II, or medium altitude endurance (MAE) UAV, the Predator is manufactured by General Atomics Aeronautical Systems and costs about \$3.2 million per aircraft.²¹ It is designed for an endurance of greater than 40 hours, giving it the capability to loiter for 24 hours over an area 500 miles away from its launch and recovery base.²² It is powered by a reciprocating engine giving it a cruise speed of 110 knots, loiter speed of 75 knots, ceiling of 25,000 feet, 450 pound payload, and a short takeoff and landing capability. The Predator carries an electro-optical (EO) and infrared (IR) sensor and was recently deployed with a synthetic aperture radar (SAR) in place of the EO/IR sensor. The Predator is also unique in its ability to collect full-rate video imagery and transmit that information in near real-time via satellite or line of sight (LOS) data link.²³ The Predator first deployed to Bosnia in 1994 and has since returned there with two combat-related losses (see appendix A).



Figure 2-5. The Predator UAV

A higher performance vehicle is the Teledyne Ryan Aeronautical Conventional High Altitude Endurance (CHAE) UAV (fig. 2-6). Referred to as the Tier II+, or Global Hawk, it is designed to fulfill a post-Desert Storm requirement of performing high-resolution reconnaissance of a 40,000 square nautical mile area in 24 hours. The Global Hawk is designed to fly for more than 40 hours giving it a 24-hour loiter capability over an area 3,000 miles from its launch and recovery base. It will simultaneously carry a SAR and an EO/IR payload of 2,000 pounds and operate from conventional 5,000 feet runways. The aircraft will cruise at altitudes above 60,000 feet at approximately 340 knots.²⁴ Tier II+ is scheduled to fly in late 1997 and meet a price requirement of \$10 million per unit.



Figure 2-6. The Global Hawk UAV

The low observable high altitude endurance (LOHAE) UAV (Tier III- or DarkStar) is the final member of the DARO family of endurance UAVs (fig. 2-7). DarkStar is manufactured by Lockheed-Martin/Boeing and is designed to image well-protected, high-value targets with either SAR or EO sensors.²⁵ It will be capable of loitering for eight hours at altitudes above 45,000 feet and a distance of 500 miles from its launch and recovery base. DarkStar can be flown from runways shorter than 4,000 feet. DarkStar's first flight occurred in March 1996.²⁶ This UAV is also designed to meet a \$10 million per aircraft unit fly-away price. DARO's new endurance UAVs, along with manned airborne reconnaissance aircraft, are designed to meet Joint Requirements Oversight Council (JROC) desires for the development of reconnaissance systems that are able to "... maintain near perfect real-time knowledge of the enemy and communicate that to all forces in near-real-time."²⁷ DARO's goal is "extended reconnaissance," which is "the ability to supply responsive and sustained intelligence data from anywhere within enemy territory, day or night, regardless of weather, as

the needs of the war fighter dictate.”²⁸ The objective is to develop by the year 2010, a reconnaissance architecture that will support the goal of “extended reconnaissance.”



Figure 2-7. The DarkStar UAV

To do this, DARO will consolidate platforms, introduce endurance and tactical UAVs, emphasize all-weather sensors as well as multispectral optical sensors, improve information systems connectivity to the war fighter through robust line-of-sight and over-the-horizon communications systems, produce scaleable and common-use ground stations, and focus on the benefits of interdisciplinary sensor cueing.²⁹ In conjunction with spaceborne and other surveillance assets, this objective architecture will provide the war fighter and command elements with near-perfect battlespace awareness.

The seamless integration of airborne and spaceborne reconnaissance and surveillance assets, along with robust, on-demand communications links, coupled with the experience in long-endurance, high-altitude UAVs made possible by current DARO efforts, will lead to the next step in the development and employment of

unmanned aerial vehicles—the long-endurance, lethal, stealthy UAV. A possible name for this new aircraft could be “StrikeStar,” and we will refer to it by that name throughout this paper.

StrikeStar will give the war fighter a weapon with the capability to linger for 24 hours over a battlespace 3,700 miles away, and, in a precise manner, destroy or cause other desired effects over that space at will. Bomb damage assessment will occur nearly instantaneously and restrike will occur as quickly as the decision to strike can be made. StrikeStar will allow continuous coverage of the desired battlespace with a variety of precision weapons of various effects which can result in “air occupation”—the ability of *aerospacepower* to continuously control the environment of the area into which it is projected. The next chapter explores the requirements that drive the StrikeStar UAV concept.

Notes

¹ The term “aerospacepower” is used as one would normally use the word “airpower” and reflects the inseparability of air and space assets in 2025. In 2025, there will be no air and space power, only aerospacepower.

² Dr Michael H. Gorn, *Prophecy Fulfilled: Toward New Horizons and Its Legacy* (Air Force History and Museums Program, 1994), 28–35.

³ Paul F. Crickmore, *Lockheed SR-71 - The Secret Missions Exposed* (London: Osprey Aerospace, 1993), 9,16.

⁴ William Wagner, *Lightning Bugs and Other Reconnaissance Drones* (Fallbrook, Calif.: Aero Publishers, Inc., 1982), 15.

⁵ *Ibid.*, 115.

⁶ Jay Miller, *Lockheed's Skunk Works: The First Fifty Years* (Arlington, Tex.: Aerofax, Inc., 1993), 134–135; Ben R. Rich, *Skunk Works* (N.Y.: Little, Brown and Co., 1994), 267.

⁷ Miller, 141.

⁸ Crickmore, *Lockheed SR-71*, 38.

⁹ Rich, 269.

¹⁰ Lt Col Dana A. Longino, *Role of Unmanned Aerial Vehicles in Future Armed Conflict Scenarios* (Maxwell AFB, Ala.: Air University Press, December 1994), 3; Wagner, 52.

¹¹ Wagner, 52, 200.

¹² *Ibid.*, 197.

¹³ *Ibid.*, 200, 213.

¹⁴ *Ibid.*, 185.

¹⁵ *Ibid.*, 6.

¹⁶ *Unmanned Aerial Vehicles*, Defense Airborne Reconnaissance Office Annual Report (Washington, D.C., August 1995), 5.

¹⁷ Longino, *Role of Unmanned Aerial Vehicles*, 9.

¹⁸ *Unmanned Aerial Vehicles*, 7.

¹⁹ Steven J. Zaloga, “Unmanned Aerial Vehicles,” *Aviation Week and Space Technology*, 8 January 1996, 87.

- ²⁰ Ibid., 87.
- ²¹ David A. Fulghum, “International Market Eyes Endurance UAVs,” *Aviation Week and Space Technology*, 10 July 1995, 40–43.
- ²² *Unmanned Aerial Vehicles*, 27.
- ²³ David A. Fulghum, “Predator to Make Debut Over War-Torn Bosnia,” *Aviation Week and Space Technology*, 10 July 1995, 48.
- ²⁴ David A. Fulghum, “International Market, 43.
- ²⁵ Zaloga, *Unmanned Aerial Vehicles*, 90–91.
- ²⁶ “Tier III- DarkStar First Flight Video,” *Lockheed-Martin Skunkworks*, 29 March 1996.
- ²⁷ *Airborne Reconnaissance Technology Program Plan - Executive Summary*, Defense Airborne Reconnaissance Office (Washington, D.C., February 1995), 2.
- ²⁸ *Unmanned Aerial Vehicles*, 1.
- ²⁹ Ibid., 4.

Chapter 3

The Need for A Strike Unmanned Aerial Vehicles

What we need to develop is a conventional deterrence force, similar to our nuclear triad, that we can project and sustain over long distances.

—Gen Ronald R. Fogleman

As 2025 approaches, the use of unmanned aerospace vehicles will be driven by sociocultural, geopolitical, and economic forces. Although it is impossible to see the future, some assumptions can be developed about the year 2025:

1. Americans will be sensitive to the loss of life and treasure in conflict.
2. The US economy will force its military to be even more cost-effective.
3. Technology will give potential enemies the ability to act and react quickly.¹

These strategic assumptions create operational needs the US military must meet by 2025. UAVs are one cost-effective answer to those needs and have the potential for use across the spectrum of conflict. Although the need for advanced capabilities is continually emerging, this concept identifies constraints that create a demand for lethal UAVs in 2025 and a possible solution to that need. By 2025, limitations may cause gaps in US airpower and UAVs offer the ability to bridge them.

Current Forces

Currently, the triad of conventional aerospace forces consists of carrier-based aircraft, land-based strike aircraft, and CONUS-based, long-range bombers. While proven very effective in Desert Storm, this triad has several limitations.² First, the aircraft carrier fleet is limited. Naval aviation lacks stealthy vehicles

and long-range systems.³ Carriers will increasingly be called on for global presence missions, but cannot be everywhere at once.⁴ Second, land-based fighters require forward basing, which could take days or even weeks to develop before employment. Finally, long-range manned bombers require supporting tankers, have limited loiter time over long distances, varying degrees of penetration capability, and can require up to 48 hours to prepare for strikes.⁵ In 2025, these limitations will have a greater effect on US power projection as a result of two factors: the shrinking military budget and a smaller military force (fig. 3-1).⁶

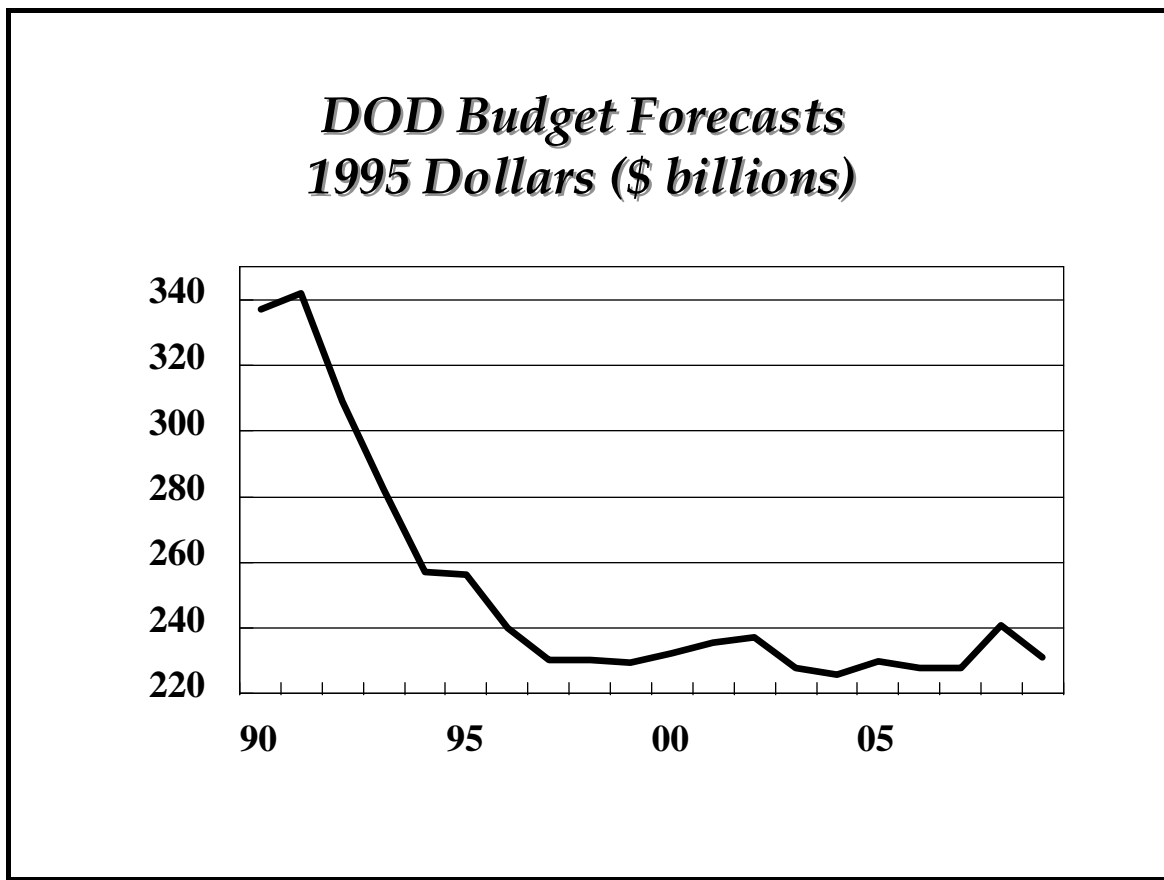

Figure 3-1. The Shrinking Military Budget

The ripple effects of current US government budgetary problems are just beginning to affect US military force levels and strength. Tighter military budgets will continue through 2010, or longer, and fewer new strike aircraft purchases will result as costs increase.⁷

Figure 3-2 represents a possible fighter force of 450 by the year 2025 and takes into consideration one of the alternate futures that might be faced.⁸ It is likely that today's fighter force will be retired by 2018, the

F-22 will begin entering retirement in 2025, and that there will be further reductions in the bomber fleet. These actions will result in a 2025 triad of conventional aerospace strike forces one fourth of the size of the 1996 force.⁹

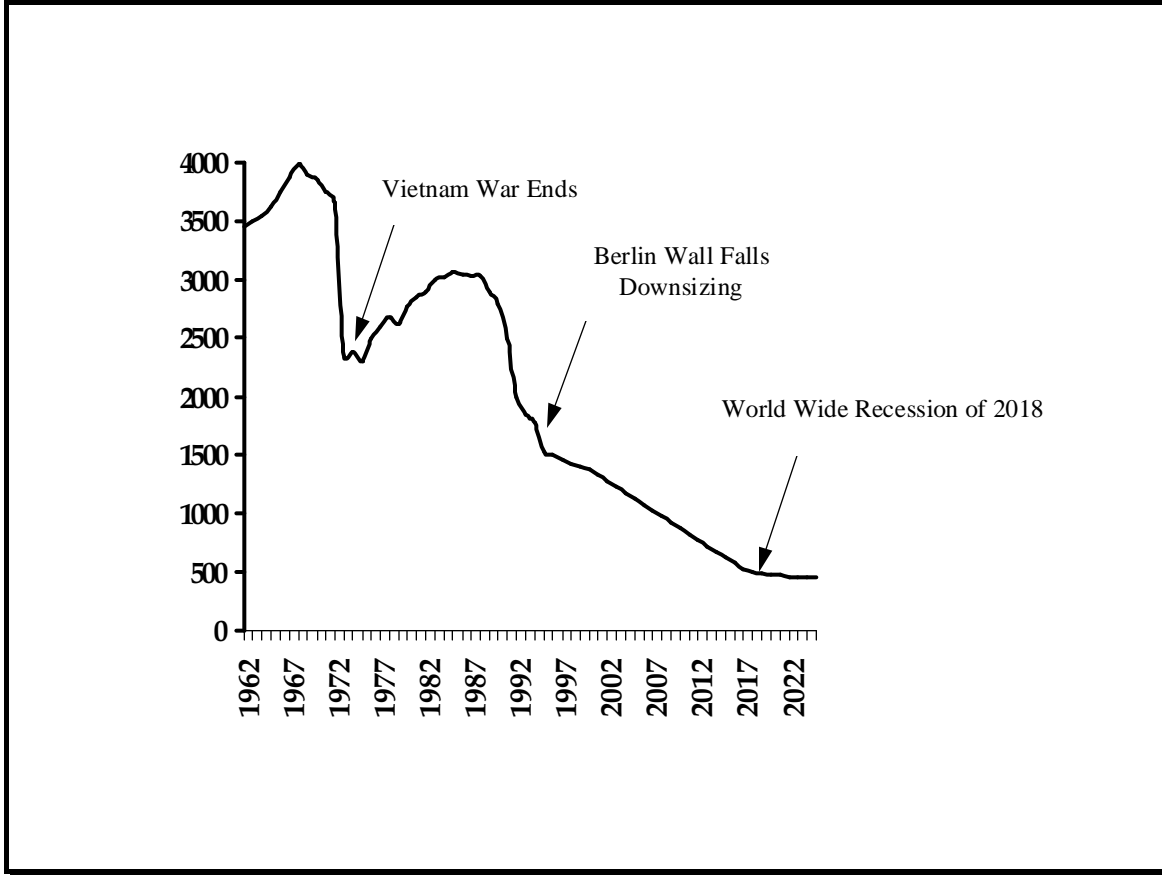

Figure 3-2. Fighter Force Projection for 2025

Unfortunately, the demands on this smaller force will not diminish. To be effective in 2025, our smaller conventional aerospace triad will require a force multiplier that will enable the US military to strike within seconds of opportunities. One way to achieve these results is to get inside our adversary's observation-orientation-decision-action (OODA) loop while reducing the time required for us to observe, and then act.¹⁰ The advent of the capability for dominant battlespace awareness allows us the ability to significantly reduce our observation, orientation, and decision phases of the loop.¹¹ Unfortunately, our current triad of conventional aerospace forces are time-limited in many scenarios due to deployment, loiter, risk, and capability constraints. The concept of a long-loiter, lethal UAV orbiting near areas of potential conflict

could allow us to significantly reduce the OODA loop action phase. In fact, the entire OODA loop cycle could be reduced from days or hours to literally seconds.¹² The lethal UAV offers a variety of unique capabilities to the war fighter at the strategic, operational, and tactical levels of war.

The US strategic triad possesses the capability to hold other countries at risk with a very short (30 minute) response time, but unfortunately, this type of deterrence is only effective against forces similarly equipped. With the exception of current no-fly zones in Iraq and Bosnia, we normally do not have conventional aerospace forces posed for immediate precision strike, nor do we have the capability to exercise this option beyond one or two theaters. Although no-fly zones in Iraq and Bosnia are considered successful operations, the operations tempo and dollar cost of maintaining this deterrence is high. In 2025, a smaller, conventional aerospace triad will be expected to react within seconds over the broad spectrum of conflict from military operations other than war (MOOTW) to major regional conflict (MRC); overcome improved enemy air defense systems; and meet demands for fewer pilot and aircraft losses, all without requiring extremely high operational tempos.¹³ These expectations will demand the development of a force multiplier to overcome the current, conventional aerospace triad limitations.

Required Capability

The force multiplier required for 2025 conventional aerospace triad forces must be capable of exercising the airpower tenets of shock, surprise, and precision strike while reducing the OODA-loop time from observation to action to only seconds. Also, this force must possess the capabilities of stealth for survivability and reliability for a life span equivalent to that of manned aircraft. Many possibilities exist across the spectrum of conflict. This paper develops the concept of a stealthy, reliable UAV capable of precision strike. StrikeStar could act as a force multiplier in a conventional aerospace triad one fourth the size of the 1996 force structure.

The StrikeStar UAV could add a new dimension to the war fighter's arsenal of weapons systems. In a shrinking defense budget, it might be a cheaper alternative to costly manned strike aircraft if today's high altitude endurance UAVs are used as a target cost guide. StrikeStar must rely on a system of reconnaissance assets to provide the information needed for it to precisely and responsively deliver weapons on demand. To

save costs and minimize the risk of losing expensive sensors, StrikeStar itself should have a minimal sensor load. The robust, expensive sensors will be on airborne and space reconnaissance vehicles, feeding the information to the UAV. An air or ground command element located in the theater of operations or continental United States could receive fused reconnaissance data and use it to direct the StrikeStar to its targets. A secure, redundant, communications architecture would connect StrikeStar and the command element, but the communications suite could be rather minimal since the UAV would normally be in a receive-only mode to reduce detectability.

StrikeStar should have a minimum 4,000-pound payload so a variety of all-weather weapons could be employed by the UAV, depending on the target and the effect desired. Lethal weapons could include global positioning satellite (GPS)-guided, 250-pound conventional weapons that would have the effect of current 2,000-pound weapons. Nonlethal weapons such as “Stun Bombs” producing overbearing noise and light effects to disrupt and disorient groups of individuals could also be delivered. Target-discriminating, area-denial weapons, air-to-air missiles, and theater missile defense weapons could be employed to expand StrikeStar’s potential applicability to other mission areas. Finally, the best lethal weapon for StrikeStar might be an all-weather directed energy weapon (DEW) which could allow hundreds of engagements per sortie.

StrikeStar would be designed for tremendous range, altitude, and endurance capabilities. Cruising at 400 knots true airspeed, StrikeStar would have an unrefueled range of almost 17,000 nautical miles, thus minimizing the historical problems inherent in obtaining overseas basing rights that have limited our strategic choices. Translated into a loiter capability, StrikeStar could launch, travel 3,700 miles to an orbit area, remain there for 24 hours and then return to its original launch base. With a cruise altitude above 65,000 feet and a maximum altitude of 85,000 feet, StrikeStar could fly well above any weather and other conventional aircraft. It would fly high enough to avoid contrails and its navigation would not be complicated by jet stream wind effects.

Such capabilities should easily be possible by 2025. Before the year 2000, today’s Tier II+ UAV will have reached nearly the StrikeStar range/endurance and payload capabilities and the Tier III- will have demonstrated stealth UAV value. The issue then revolves around the use of such an unmanned capability and how such a capability could add value to *aerospacepower* of the twenty-first century. Ben Rich, a former president of Lockheed’s “Skunk Works” saw the future of the unmanned strike vehicle:

But even a leader able to whip up sentiment for “sending in the Marines” will find it dicey to undertake any prolonged struggle leading to significant casualties. . . . As we proved in Desert Storm, the technology now exists to preprogram computerized combat missions with tremendous accuracy so that our stealth fighters could fly by computer program precisely to their targets over Iraq. A stealthy drone is clearly the next step, and I anticipate that we are heading toward a future where combat aircraft will be pilotless drones.¹⁴

Coupled with the ability to reduce casualties, StrikeStar and its supporting reconnaissance and communications assets will add new meaning to what the Joint Chiefs of Staff call precision engagement:

Precision engagement will consist of a system of systems that enables our forces to locate the objective or target, provide responsive command and control, generate the desired effect, assess our level of success, and retain the level of flexibility to reengage with precision when required. Even from extended ranges, precision engagement will allow us to shape the battlespace, enabling dominant maneuver and enhancing the protection of our forces.¹⁵

Milestones

Currently, technology is being developed to accomplish this concept. While the technology will exist by the beginning of the twenty-first century, transferring this technology from the laboratory to the battlefield will require reaching three new milestones in aerospace thinking.

First, US military leadership must be willing to accept the concept of lethal UAVs as a force multiplier for our conventional aerospace triad of 2025. They should not deny the opportunity for continued growth in this capability.¹⁶ The issue revolves around the use of an unmanned capability and how such a capability could add value to *aerospacepower* of the twenty-first century.

Second, doctrinal and organizational changes need to be fully explored to ensure this new weapon system is optimally employed. In the context of a revolution in military affairs (RMA), developing a new weapon system is insufficient to ensure our continued prominence. We must also develop innovative operational concepts and organizational innovations to realize large gains in military effectiveness.¹⁷

Finally, a target date not later than 2022 should be set for this refined concept and supporting systems to be operational for combat employment. This will give the US military and contractors time needed to correct deficiencies, leverage new technological developments, and polish capabilities equivalent to or beyond the manned portion of the conventional aerospace triad.¹⁸ The need will exist in 2025 for a cost-effective, reliable force multiplier for the US military aerospace forces. StrikeStar offers a unique combination of

these three requirements and now is the time to begin working toward these milestones to meet conventional aerospace triad needs in 2025.

Notes

¹ Gene H. McCall, Chairman USAF Scientific Advisory Board, presentation to the AF 2025 Study Group, Maxwell AFB, Ala., 6 September 1995.

² Thomas A. Keaney and Eliot A. Cohen, *Gulf War Air Power Survey Summary Report* (Washington, D.C., 1993), 15.

³ John T. Correll, “Deep Strike,” *Air Force Magazine*, April 1996, 2.

⁴ James A Lasswell, “Presence - Do We Stay or Do We Go?,” *Joint Forces Quarterly*, Summer 1995, 84–85; Col Walter Buchanan, JCS/J3, “National Military Command Center,” presentation to Air Command and Staff College, 27 February 1996.

⁵ Maj David W. Schneider, “Heavy Bombers Holding the Line,” *Air Power Journal*, Winter 1994, 45–52.

⁶ Col William Jones, JCS/J8, “JROC and the Joint War fighting Capabilities Assessment Process,” presentation to Air Command and Staff College, 12 February 1996.

⁷ David R. Markov, “The Aviation Market Goes Global,” *Air Force Magazine*, June 1995, 22–28. In this article Mr Markov paints a gloomy picture of total strike aircraft production worldwide due to lower defense budgets and rising costs.

⁸ “AF 2025 Alternate Futures: Halfs and Have Naughts,” April 1996.

⁹ “A New Defense Industrial Strategy,” *Air Power Journal*, Fall 1993, 18–22; Brian Green, “McCain’s Rising Star,” *Air Force Magazine*, April 1996, 9. In this article, Senator John McCain states, “It’s obvious we’re not going to maintain the force structure that was anticipated when the two-MRC scenario was designed.”

¹⁰ John R. Boyd, “The Essence of Winning and Losing,” presentation to the AF 2025 Study Group, Maxwell AFB, Ala., October 1995.

¹¹ “Warfighting Vision 2010: A Framework for Change,” (Ft. Monroe, Va: Joint Warfighting Center, 1 August 1995), 10–11.

¹² Maj James P. Marshall, *Near-Real-Time Intelligence on the Tactical Battlefield*, (Maxwell AFB, Ala.: Air University Press, January 1994), 100. In this report, Maj Marshall proposes a wide range of target lifetimes ranging from several hours to one minute.

¹³ Clark A. Murdock, “Mission-Pull and Long-Range Planning,” *Joint Forces Quarterly*, Autumn/Winter 94–95, 33. Mr Murdock identifies 12 operating environments, more than 60 military missions, and more than 200 critical tasks by the year 2011.

¹⁴ Ben R. Rich, *Skunk Works* (N.Y.: Little, Brown and Company, 1994), 340.

¹⁵ *Joint Vision 2010*, (Washington, D.C.: The Joint Chiefs of Staff 1995), 9.

¹⁶ Jeffrey Cooper, Another View of Information Warfare: Conflict in the Information Age, SAIC, (Publication Draft for 2025 Study Group), 26. In reference to new technologies he states: “These changes, exactly because they are fundamental, threaten all the vested interests and military “rice bowls,” from resource allocation, to roles and missions, to the very nature of command and how control is exercised”; Gene H. McCall, Chairman USAF Scientific Advisory Board, presentation to the AF 2025 Study Group, Maxwell AFB, Ala., 6 September 1995. Dr McCall stated in his presentation: “Most revolutionary ideas will be opposed by a majority of decision makers.”

¹⁷ Jeffrey McKittrick et al., “The Revolution in Military Affairs,” in Barry R. Schieder and Lawrence E. Grinter, eds., “Battlefield of the Future: 21st Century Warfare Issues” (Maxwell AFB, Ala.: Air University Press, September 1995), 71–75; Andrew F. Krepinevich, Jr., “The Military Technical Revolution:

A Preliminary Assessment,” (Maxwell AFB, Ala., Air Command and Staff College, War Theory Course Book, Volume 3, September 1995), 163.

¹⁸ Gene H. McCall, Chairman USAF Scientific Advisory Board, presentation to the AF 2025 Study Group, Maxwell AFB, Ala., 6 September 1995. Dr McCall stated in his presentation: “Early applications of revolutionary concepts should not be required to be complete and final weapon systems.”

Chapter 4

Developmental Considerations

The end for which a soldier is recruited, clothed, armed, and trained, the whole object of his sleeping, eating, drinking, and marching is simply that he should fight at the right place and the right time.

-Carl von Clausewitz *On War*

Clausewitz's statement of the supremacy of purpose for all that we do in the military applies as much today as it did centuries ago. In his day, military leaders concerned themselves with tailoring, building, and sustaining their forces to "fight at the right place and the right time" with the purpose of winning wars. Today, our leaders are faced with a similar challenge. In our increasingly technological age, military leaders are challenged to develop weapon systems that enable our forces to determine the "right place" and move people, equipment, and supplies to be able to fight at the "right time."

Unmanned aerial vehicles offer military leaders the ability to use *Global Awareness* to more accurately apply *Global Reach* and *Global Power* when and where needed. For years, UAVs have had the capability to push beyond the realm of observation, reconnaissance, and surveillance, and assume traditional tasks normally assigned to manned weapon systems. However, several factors influenced decisions that favored manned aircraft development at the expense of UAVs. A 1981 Government Accounting Office report "alleged inefficient management in the Pentagon in failing to field new [UAV] vehicles. The GAO noted several explanations for the inertia: many people are unfamiliar with the technology, unmanned air vehicles are unexciting compared to manned vehicles, the limited defense budget, and user reluctance—the pro-pilot bias."¹

Whether one accepts this assessment or not, there have been limited advancements in military UAV development, but not without prompting from external sources. Since 1981, the US Department of Defense has expended a much greater effort in developing, producing, and employing UAVs in the reconnaissance role. In fact, UAVs proved to be a viable force multiplier in the coalition military efforts in the 1991 Gulf War.² However, some of those problems identified by the 1981 GAO report continue to exist today and, without additional UAV research and education, may severely limit future development of UAV military potential.

Moreover, the “jump” from using UAVs in nonlethal reconnaissance roles to lethal offensive operations is a dramatic change, adding another consideration to deal with—public accountability. It is likely the American public and international community will demand assurances that unmanned UAVs perform at least as safely as manned aircraft. This requirement must be considered in designing, developing, and employing any lethal UAVs.

This section analyzes this accountability issue and two other considerations: (1) an alleged pro-pilot bias that favors development and employment of manned aircraft over UAVs and; (2) a reduced budget that forces choosing space-based or air-breathing systems in a zero sum battle for military budget dollars.

Pro-Pilot Bias

Under the many challenges of their rapidly changing environment, the Air Force leadership may have become more focused on the preservation of flying and fliers than on the mission of the institution.

—Carl A. Builder
The Icarus Syndrome

Nearly every research effort conducted on UAV development in the last 10 years has either referenced or implied the existence of a “pro-pilot bias.” None of those studies, however, defines what constitutes that bias, except in one case where it is described as a “user reluctance.”³ Yet authors state or imply that this bias has been responsible for delaying or undermining efforts in developing and employing operational UAVs since their inception. In the future, to ensure optimization of combat UAVs, underlying concerns must be identified, validated, and dealt with as hurdles to be overcome, not biases.

There are three identifiable concerns that will be analyzed concerning “pro-pilot bias” and its effects on UAV development. First, there is a skepticism that current UAV technology provides the reliability, flexibility, and adaptability of a piloted aircraft.⁴ Basically, this perception implies that UAVs are incapable of performing the mission as well as equivalent manned aircraft since they are unable to respond to the combat environment’s dynamic changes. This incorrectly assumes all UAVs operate autonomously as do cruise and ballistic missiles. These latter systems do lack flexibility and adaptability, and only do what they are programmed to do. Other UAVs, like the Predator, are remotely piloted vehicles, and are as flexible and adaptable as the operator flying them. The operator’s ability to respond to the environment is dependent on external sensors to “see” and “hear” and on control links to provide inputs to and receive feedback from the UAV. Future UAVs using artificial intelligence will respond to stimuli in much the same way as a human, but will only be as flexible and adaptable as programmed constraints and sensor fusion capabilities allow.

In 2025, technology will enable near-real-time, sensor-shooter-sensor-assessor processes to occur in manned and unmanned aircraft operations. The question is not whether either of these systems is flexible and adaptive but whether it is more prudent to have a human fly an aircraft into a hostile or politically sensitive environment, or have an operator “fly” a UAV from the security of a secure site.

Second, there is a perception that UAVs capable of performing traditional manned aircraft missions are a threat to the Air Force as an institution. This perception is deeply rooted in the Air Force’s struggle with its own identity, a struggle lasting since the early Army Air Corps days. Carl Builder, in *The Icarus Syndrome*, describes how the Air Force sacrificed airpower theory (“the end”) in exchange for the airplane’s salvation (“the means”) when challenged by arguably more capable “means.”⁵ Like the intercontinental ballistic missile (ICBM) and cruise missile, the Air Force has struggled against the development of UAVs only to accommodate it when faced with other services’ infringement on traditional Air Force missions. Like the ICBM and cruise missiles before it, the UAV has been assigned a support role, primarily in reconnaissance. The problem, according to Builder, is that the Air Force, when faced with challenges to the “flying machine,” tends to accommodate new systems instead of adapting doctrine to tie the new “means” to its mission and underlying airpower theory.⁶ Thus, Builder asserts the Air Force has been myopic, seeing the “mission” of the Air Force in terms of airplanes, and therefore any system other than an airplane is relegated to mission support, or deemed a threat to the Air Force institution and dismissed. Ironically, the UAV is

following the same development path that the airplane took over 50 years ago when the Army culture relegated it to a reconnaissance and mission support role.

Finally, there is a concern among the Air Force's pilot community that UAVs pose a threat to their jobs and, ultimately, their future Air Force roles.⁷ There is a perception that UAVs will replace the need for pilots to employ aerospacepower, and closely tied to this belief is the resultant threat to the power base and leadership role pilots have held in the Air Force since its birth. It is easy to rationalize an Air Force founded on flying airplanes led by those who fly them. For years, those who protected the preeminence of the airplane also protected the leadership of the pilots and operators, sometimes at the expense of the institution's well being.⁸ If it is right for pilots to lead a "fly, fight, and win" Air Force, then would it be equally right for pilots to step down when the airplane is replaced by cruise missiles, space-based platforms, and UAVs? Pilots, who have held the leadership reins of the Air Force for more than 50 years, are now faced with being replaced with specialists and technologists. This threat and the reaction of today's pilot-laden Air Force leadership will play a major role in determining the UAV's development between now and 2025.

Budget Competition — Space-Based, Air Breather, or Both

Space warfare will likely become its own warfare area only when there is need to conduct military operations in space to obtain solely space-related goals (not missions that are conducted to support earth-based operations).

—Jeffrey McKittrick
The Revolution in Military Affairs

The Air Force is looking to both space and the inner atmosphere for ways to meet future war fighting requirements. At the same time, budget constraints are forcing the Air Force to be selective in determining which system(s) will receive increasingly dwindling dollars. In the past, UAVs lost similar competitions to manned aircraft in the Air Force's constant attempt to modernize its manned aircraft. Future competitions will still face manned aircraft concerns, but the competition will also be between the UAV and an equivalent space-based platform. This section does not provide a thorough comparative analysis of space-based systems and the StrikeStar. It does provide those who will make the decisions that fund one or both of these

systems with (1) an understanding that a competition exists between space-based systems and a StrikeStar concept; (2) some considerations to be used in making those decisions; and (3) recommendations for using the StrikeStar in conjunction with a bolstered space-based system.

Several organizations associated with the Department of Defense's research and development circle are developing space-based systems that can deliver precision lethal and nonlethal force against ground-based targets. Like StrikeStar, these systems have the capability to project power to any point on the earth and do so with a minimal sensor-to-shooter time delay. As orbiting systems, these systems provide decision makers a near continuous coverage of all global "hot spots." In many respects, these systems parallel capabilities provided by a gravity-bound StrikeStar.

Unlike StrikeStar, space-based systems are expensive in research and development, and the space environment provides operational challenges. The budget dollars do not exist now and likely will not exist in the future to fund the simultaneous development of space-based and StrikeStar UAV systems. But more important than lack of money is the waste inherent in simultaneously developing systems that duplicate each other's capabilities without adding any appreciable value.⁹ For years, the Navy and Air Force have done just this by developing very similar frontline fighters. Today, the services and Congress understand that this practice results in great waste and that they can reduce that waste by comparing space-based attack system and UAV development now and determining which strategy will best provide needed capabilities by 2025.

Decision makers must compare space-based and air-breathing systems and determine which will receive development funding. They must consider the capabilities, limitations, and implications of both systems and form a conclusion as to which system or combination of systems provides the needed war fighting capability in 2025. Probably the greatest limitations of space-based systems are the costs associated with transporting the vehicle from the surface to earth's orbit, maintaining it (in orbit or on return), and then transporting it back to the surface. Another significant space-based system limitation is the criticality of the vehicle(s) position or orbit. Space-based systems cannot currently loiter over a target area since orbital mechanics require constant movement around the earth. Therefore, a space-based system needs multiple vehicles to provide constant coverage as well as the ability to position a vehicle when and where needed.

Decision makers must also consider the sociopolitical implications of militarizing space. Some argue control of space is analogous to control of air and that this new frontier should be approached in the same

manner the military approached airpower.¹⁰ But this new frontier is inherently different from the skies overlying the earth's nations, and space cannot be divided up in segments as the international community has done with airspace. In fact, space is rapidly being established as an international domain for commercial interests owned by a combination of nation-states and corporate conglomerates. Establishing space dominance will be costly and threatening to an increasingly interdependent international community. Placing an offensive-capable platform in space that continuously holds any nation or group of individuals at risk will undoubtedly be perceived as a direct threat to friendly or enemy nations.

A less threatening alternative for space is the enhancement of current military capabilities in the areas of reconnaissance, navigation, and communications with concurrent development of space-to-space weapon systems designed to protect our space-based assets. Also, challenges associated with projecting lethal and nonlethal force from space-to-surface targets may be too difficult and costly when compared with inner-atmosphere systems with similar capabilities. Offensive and defensive space-based systems are essential, but primarily for missions that support space requirements and not for direct attack against inner-atmosphere targets.

Probably the greatest limitation of air-breathing UAVs compared to an equivalent space-based system is the time delay required to mobilize and deploy it to a theater of operations. StrikeStar is designed to deploy-loiter-strike-loiter-redeploy from either CONUS or a forward base, but due to fuel limitations, the time required to deploy and redeploy are contingent on the distance to the area of operations and this also directly affects available loiter time. Because StrikeStar cannot stay airborne indefinitely, it may require advanced warning times or an increased number of vehicles to provide continuous coverage of the operations area.

Because of high costs to develop, operate, and maintain space-based systems that might deliver lethal force on the earth's surface, the armed forces should tailor development of space-based platforms to lethal missions that focus on space-only missions and nonlethal missions supporting earth-bound lethal weapon systems. StrikeStar and a new generation of UAVs capable of delivering lethal and nonlethal force provide a low cost, highly mobile platform that will enable the US military and civilian authorities to project power to any point on the globe in minimal time and hold an area at risk for days at a time. StrikeStar is not a threat to space, but simply provides an effective capability that when directed by air, land-based, or space-based command and control can reach out and touch enemies threatening our national interests throughout the world.

Public Accountability

War is a human endeavor, fought by men and women of courage. The machines, the technology help; but it is the individual's skill and courage that makes the crucial difference.

—General Gordon R. Sullivan
Army Focus 1994: Force XXI

The public will demand accountability for lethal UAVs and their operations and StrikeStar's lethal potential requires assurances that prevent inadvertent or unintentional death and destruction to both friendly and enemy troops.

Imposed Limitations

Restrictions must be placed on lethal UAVs because of the potential consequences of an accident or malfunction. Recent history has proven that the American public and the international community hold individuals and organizations accountable for decisions to use force. The downing of two US helicopters supporting Operation Provide Comfort in Northern Iraq and the subsequent loss of 24 lives provide a vivid example of how the public will react to lethal force "accidents" or "mistakes." Today, accident-or mistake-justifications do not warrant death or destruction.

Even in war, use of legitimate lethal force will be questioned. Society has become more sensitive to death and destruction as the information age provides real-time, world-event reporting. Television presents images and political commentary, probing and demanding justification for using lethal force. The intent of those inquiries is to determine accountability when events result in questionable death or destruction. Also, technology has legitimized precision warfare, and "criminalized" collateral death and destruction resulting from the use of lethal force. The perception exists among many press and public that it is now possible to prevent nearly all types of accidents and mistakes and only shoot the "bad guy."

These perceptions place limits on using any system that could deliver lethal force. StrikeStar falls within this category and it is imperative that accountability be built into the system design and concept of operations.

But how do we create accountability? First, a human must be involved in the processes that result in lethal force delivery. Second, redundancy must be designed into the system to ensure a person can exercise control from outside the cockpit. Third, the system must be responsive to the dynamic environment in which it will operate. Finally, reliability must be designed into every StrikeStar system and subsystem to minimize the possibility of inadvertent or unintentional use of lethal force. In total, these measures place a human in the decision-making position when employing lethal force. Thus, when an accident or mistake occurs, a person, not a machine, is responsible and accountable. For claiming a system failure, or “it just blew,” will not suffice.

Man-in-the-Loop

Accountability is not well suited for anything other than a person. When an aircraft crashes, the mishap board’s task is to find causal reasons for the crash. Even when it becomes apparent a broken or malfunctioning part contributed to the crash, the board probes the processes involved in its production, installation, and even documentation. Since processes are created and normally managed by people, accountability is normally given to a person.

So humans must be involved in the decisions that could result in intentional or unintentional death and destruction. But human input is not required in all phases of flight and there are various ways to keep a person in the loop without putting a pilot in a cockpit. However, because of the potential consequences of mistakes or accidents, human input must be involved in target selection and weapons delivery decisions.

The man in the loop can be attained through nearly all of the potential controlling mechanisms available now and forecast into the future. UAV control mechanisms included manned, remotely piloted, semi-autonomous (combined RPV and programmed), autonomous (programmed/drone), and fully adaptive (artificial intelligence). StrikeStar control mechanisms allow for inflight human input, but an autonomous system preprogrammed to hit a prelaunch designated target or target area with minimum human intervention and not normally be changed in flight could be used. Also, a fully adaptive UAV using artificial intelligence could be programmed to mimic the decisions a pilot would make in reacting to environmental changes.

Although it can be suited to some missions, a lethal UAV with autonomous or fully adaptive controls pose significant accountability problems. First, decisions to target and strike are made without regard to a

rapidly changing environment. For example, a tomahawk land attack missile (TLAM) might hit a command post even though, in the time since it was launched, a school bus full of children stopped nearby. An autonomous system has no way of knowing current or real-time information that may affect the decision to target and strike. Second, autonomous UAVs cannot react to internal malfunctions that might affect their ability to perform their prescribed missions. A preprogrammed UAV told to deliver its weapon will do so even though its targeting system has malfunctioned and the result is a bomb dropped with unknown accuracy. The net effect in both situations is inadvertent or unintentional delivery of lethal force and an accountability question.

Obviously, 100 percent reliability is not guaranteed even with a human in the decision making process, but 100 percent accountability must be attempted. The further a person gets away from lethal force accountability, the easier the “fire” decision is and the greater the probability that the wrong target will be hit. As a result of this tendency and the severity of the consequences, our air-to-air rules of engagement favor visual identification over system interrogation and identification. A person must be kept in the loop when using UAVs to deliver lethal force.

Redundancy

To keep man in the loop and maintain this accountability, we must ensure the control links are sufficiently redundant. There are two potential centers of gravity that, if intentionally or unintentionally targeted, would remove or degrade the man in the loop. First, the control links are susceptible to MIJI (meaconing, intrusion, jamming, and interference). In this case, the “lines” between the UAV and the controller are severed or degraded to a point where the UAV is basically autonomous. Second, the controller or the controllers’ C⁴I facilities are also susceptible to physical destruction, equipment malfunctions, and situational dis/misorientation. In this case, the source of the signals or an intermediary relay (e.g., satellite) would be physically incapable of sending or transmitting control signals to the UAV. In either case, the UAV is without a man in the loop.

Controller backup systems need to be able to deal with contingencies that could threaten the UAV’s ability to accurately hit its designated target. The StrikeStar should have triple redundancy built into the controlling system utilizing a ground source, airborne source, and an autonomous backup mode. Should the

UAV detect an interruption of controller signals, it could enter an autonomous mode and attempt to reconnect to its primary controller source. If unable to reconnect, it could search for a predesignated secondary controller input and establish contact with the backup controller. The final option available if the UAV can not regain controller input would be to follow the last known program or abort, depending on its prelaunch abort configuration.

Responsiveness

The StrikeStar system must be responsive to a dynamic environment and design must include flexible C⁴I systems, C² operations, and UAV guidance and fire control systems. It is imperative that a lethal UAV be able to assess its environment and adapt to it accordingly. This requires real-time data and assessment, high-speed data transmission capability, flexible C² procedures, reliable controller capability, and a real-time reprogramming capability.

An advantage of a manned aircraft is that the pilot can make the last-second decision to deliver the weapon, abort the delivery, or change targets as the situation dictates. At the last-second, a pilot can detect an unknown threat preventing him or her from reaching the target, and has the ability to change targets when the original target has moved. Simply, a pilot has the ability to assess and react to a environment characterized by fog and friction.

Lethal UAVs (and/or their controllers) must have the same ability to adapt to an unanticipated or dynamic environment. They must be able to discern the environment, consider the threat (in cost-benefit terms), confirm the intended target, and have the ability to deliver, abort, or change to a new target. The consequences of not having this ability relegates the UAV to an autonomous system and raises accountability questions in the event of an unintentional or inadvertent delivery. Real-time information and control is essential to protecting our accountability in lethal UAVs.

Reliability

The UAV and its many subsystems must have a high operational reliability rate to prevent accidental destruction and collateral damage. Unlike nonlethal UAVs, unmanned systems carrying lethal munitions

could have destructive effects in an accident or systems-related malfunction. Lethal UAVs must have a higher reliability confidence level than a manned system because UAV system malfunction effects could prove to be more disastrous.

Summary

StrikeStar as well as other systems that deliver lethal force will be scrutinized when accidents occur, especially those that result in unintentional or inadvertent loss of life or treasure. The public will demand accountability for lethal UAVs and their operations. Therefore, design, development, and employment of the StrikeStar must integrate the concept of accountability. Humans must remain in the command and control loop, and the internal and external systems and links must be robust enough to keep that loop intact. The sociopolitical implications are too high to ignore these facts.

Conclusion

Although the StrikeStar concept can be proven to meet an operational need, is technically feasible, and fits into a sound concept of operations, it may go the way of previous UAV concepts. Forces exist today that could slow or deny the development of a lethal UAV for use in 2025. Most prevalent are the historical bias for manned aircraft over UAVs, budget competition between space development and the UAV programs, and, finally, the public pressure that increasingly requires accountability when things go wrong. These forces need to be understood and met openly as we start developing a StrikeStar.

Notes

¹ David H. Cookerly, *Unmanned Vehicles to Support the Tactical War* (Maxwell AFB, Ala.: Air University Press, May 1988), 25.

² Lt Col Dana A. Longino, *Role of Unmanned Aerial Vehicles in Future Armed Conflict Scenarios* (Maxwell AFB, Ala.: Air University Press, December 1994), 9.

³ Ibid., 25.

⁴ Ibid., 28.

⁵ Carl H. Builder, *The Icarus Syndrome* (New Brunswick, N.J., 1994), 200.

⁶ Ibid, 205.

⁷ Longino, 13.

⁸ Builder, 200.

⁹ Jeffrey McKittrick et al ., “The Revolution in Military Affairs,” in Barry Schnieder and Lawrence E. Grinter, eds., *Battlefield of the Future; 21st Century Warfare Issues* Maxwell AFB, Ala.: Air University Press, September 1995), 78.

¹⁰ McKittrick, 89.

Chapter 5

StrikeStar Technology

The system was so swift that human beings simply could not handle the target volume without extensive automated support, and the system was designed to fight on full automatic, relying on its human masters for key decisions, for overall guidance, for setting or revising priorities, and for defining operational parameters. Technically, this most potent warfare machine ever built had the capability to carry on the fight indefinitely.

–Ralph Peters
The War in 2020

The war machine described above is fiction, but the technology is within our grasp to make it a reality. In the past, UAV systems have been plagued with reliability problems or by design flaws (see appendix A).¹ Recently, the joint tactical UAV Hunter was canceled due to continuing reliability problems.² Current efforts are producing mature technology that improves overall reliability and functionality. The first DOD UAV master plan was produced to consolidate requirements and integrate efforts across all DOD agencies.³ The Global Hawk and DarkStar UAVs are excellent examples of how quickly UAV systems technology is advancing. Table 1 provides a summary of US UAV characteristics from a system capabilities perspective.

Table 1

US UAVs, System Characteristics

Characteristic	Maneuver UAV	Interim Joint Tactical Pioneer	Joint Tactical Hunter	MAE Predator	CHAE UAV Global Hawk Tier II Plus	LOHAE UAV DarkStar Tier III Minus
Max Altitude (ft)	13000	15,000	25,000	25,000	>65,000	45,000
Endurance (hrs)	3	5	12	> 24	> 24	> 8
Rad. Action (nm)	27	100	> 108	500	3000	> 500
Max Speed (kts)	TDB	110	106	129	> 345	> 250
Cruise Speed	<90	65	> 90	110	345	> 250
Loiter Speed	60-75	65	< 90	70-75	340	> 250
Payload Wgt(lbs)	50	100	196	450	2,140	1287
Max Wgt	200	429	1700	1873	24,000	8,600
Navigation	GPS	GPS	GPS	GPS/INS	GPS/INS	GPS/INS

Source: *Unmanned Aerial Vehicles*, Defense Airborne Reconnaissance Office Annual Report (Washington, D.C., August 1995).

This family of UAVs capitalized on past accomplishments and started the evolutionary process of adapting technologies proven in manned aircraft to UAV platforms. Other countries are also involved in UAV technology and have recognized the roles UAV will have on future battlefields (see appendix B).⁴ Trends indicate a wide range of anticipated technologies will support the StrikeStar concept and provide platform robusting. Some include:

1. airframe technology
2. avionics systems
3. propulsion technology
4. weapon systems
5. communications systems
6. mission control equipment
7. launch and recovery equipment

Sensor technologies are not critical to the construction and design of StrikeStar, but are critical to its operation. We expect reconnaissance efforts for both manned and unmanned aircraft and space platforms will continue to advance. StrikeStar will rely on other platforms for target identification, but could have the

capacity to carry reconnaissance sensors using modular payload approaches. This concept does not advocate combining expensive reconnaissance sensors on the same platform carrying a lethal payload, since separating sensors from the weapon platform lowers costs and lessens the risk of sensor loss.

The technologies noted above have to support the system characteristics shown in table 2 to ascertain current capabilities and identify enabling technologies that support the StrikeStar concept. Our baseline for the system characteristics is based on a melding of the Global Hawk and DarkStar performance attributes. The range and loiter improvements allow us to overcome the basing and response constraints mentioned in chapter 2. Adding stealth characteristics to a Global Hawk-size UAV reduces vulnerability and allows covert operation. Improved payload capacity allows the ability to carry both more and varied weapons. The envisioned altitude improvements allow for airspace deconfliction, self defense, and weapon range and dispersion performance.

Table 2

StrikeStar System Characteristics

Characteristic	StrikeStar
Wingspan (ft)	105
Max Altitude (ft)	>80,000
Endurance (hrs)	> 40
Rad. action (nm)	3700 w/24 hr loiter
Max Speed (kts)	> 400
Cruise Speed (kts)	400
Loiter Speed (kts)	400
Payload Wgt (lbs)	4000
Max Wgt (lbs)	24,000
Navigation	GPS/INS

Airframe Technology

Past UAV systems have used both fixed and rotary wing configuration. Rotary wing systems overcome many of the problems associated with launch and recovery, and optimize sensory payload operations. The Sikorsky Cypher provides a recent, successful demonstration of rotary wing technology.⁵ Unfortunately, most rotary wing systems have limited range and endurance capabilities. Most UAVs fall into the fixed wing category including all those currently in-service worldwide.⁶

Typical low performance fixed wing systems employ rear-mounted pusher propellers, such as the Predator UAV, or tractor propellers. Systems have single or twin tail booms and rely on their relative small radar cross section and low noise generation to avoid detection. The Hunter platform shown in figure 5-1 is a prime example of a UAV using push-pull engine technology on a twin boom airframe.

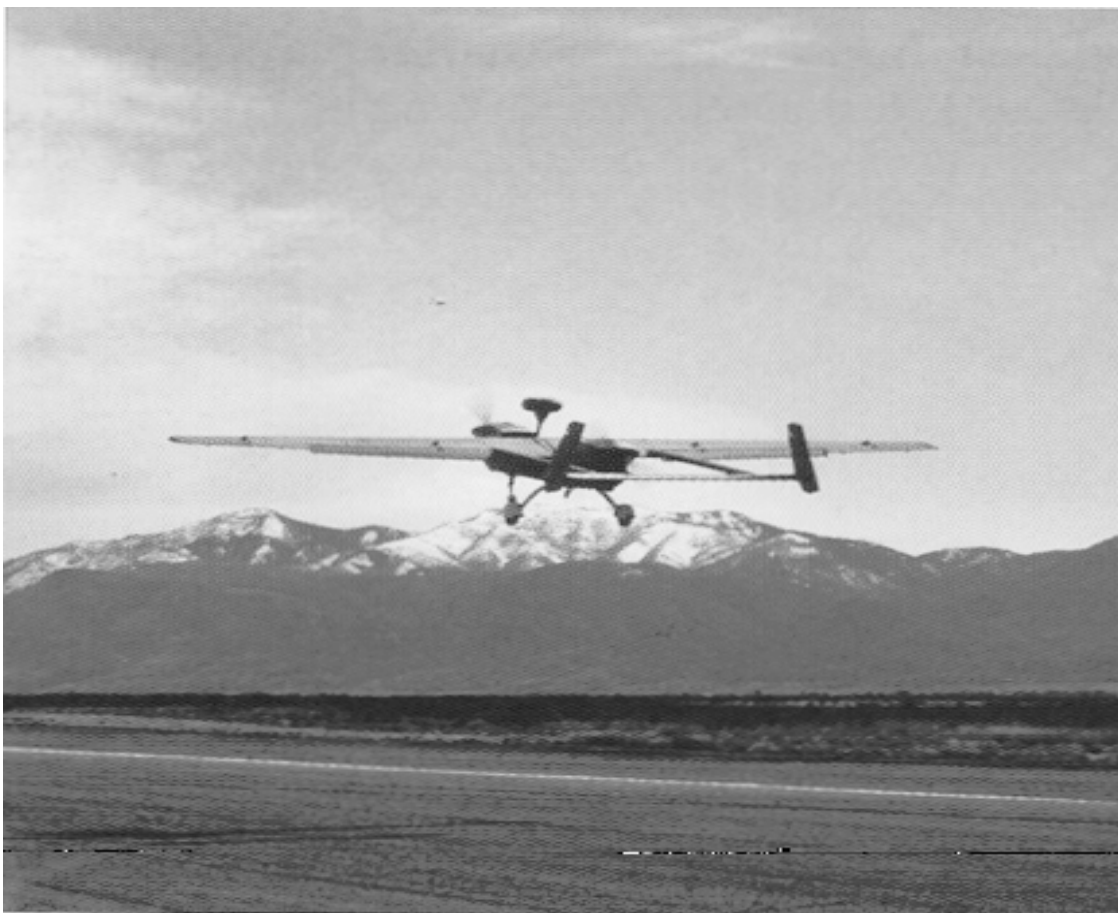

Figure 5-1. Twin-Boom Hunter UAV

Designs to date have focused on using existing manned airframe components or designs to minimize cost or produce operational platforms quickly. These systems support moderate payloads over various ranges despite known aerodynamic deficiencies. The advent of the DarkStar platform demonstrates an innovative approach to improve both aerodynamic efficiency, payload support, and operational radius.⁷ DarkStar's use of a jet engine coupled with a composite flying wing structure will improve aerodynamic efficiencies and significantly decrease the radar cross section.

As currently designed, the DarkStar UAV consists of an internal payload bay capable of supporting a sensor payload which can be swapped in the field. The current payload capacity and platform configuration does not allow DarkStar to function as an efficient strike platform. Skunkworks designers are continuing evolutionary improvements on the DarkStar platform. Their conceptual design in figure 5-2 provides a look at a twin engine platform capable of increased range, speed, and payload capacity that has the potential to function as a UAV strike platform. This design could serve as the basis for future StrikeStar developments.

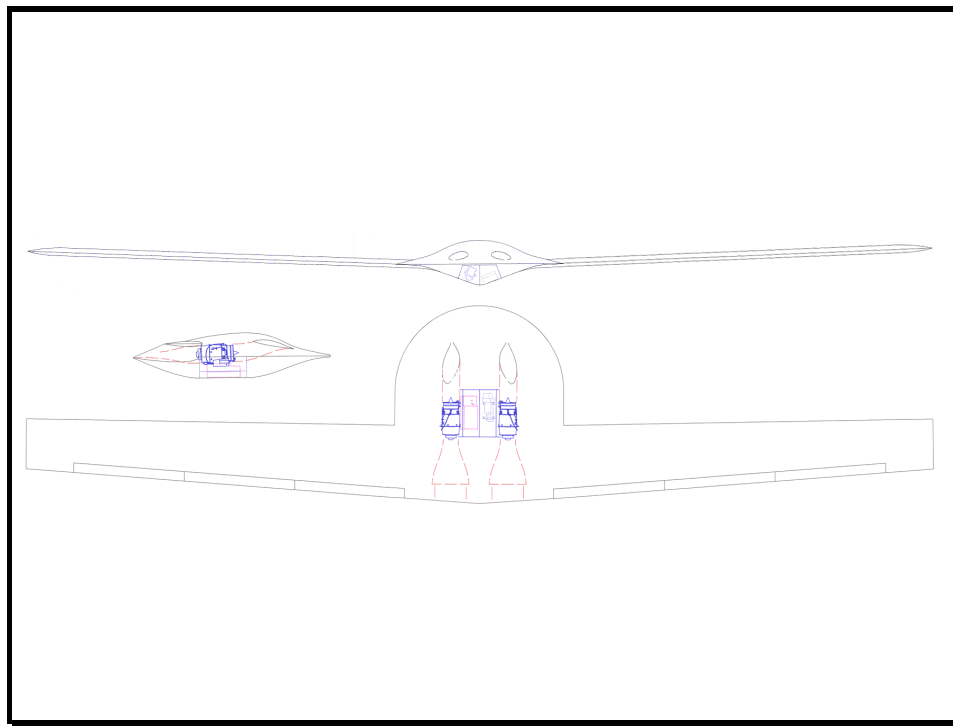

Figure 5-2. Notional StrikeStar

StrikeStar designers could capitalize on DarkStar payload swapping techniques as well as internal weapon carriage technology used for the F-117 and F-22 airframes. Future generations of StrikeStar

airframes would rely on larger payload bays and wider use of composite materials to improve payload capacity and stealthiness without increasing total weight. We anticipate that stealth technologies will mature to the point that cloaking or masking devices could be used to prevent detection or the employment of effective countermeasures.⁸

On-Board Control Systems

The avionics system would support two modes of platform operation: command-directed and autonomous. In command-directed operation, the StrikeStar operator would transmit the desired strike mission way points, cruising speed, and flight altitude to the StrikeStar flight control system to perform normal flight operations. Preprogrammed operations would be possible if all known way points were entered prior to a mission. Default preprogrammed operations would commence if uplink communications were lost and not recovered within a user-selectable time frame. Defaults could include entering preplanned holding patterns or initiating preplanned egress maneuvers as determined by the on-board Virtual Pilot system described later.

The avionics system would be based on concepts embodied in the Pave Pace integrated avionics architecture. Pave Pace is a concept that uses a family of modular digital building blocks to produce tailorable avionics packages. Using this approach on the StrikeStar would allow for future growth and allows the UAV avionics to mirror manned platform components without adding additional avionics maintenance requirements. A notional avionics system, based on the Pave Pace integrated avionics architecture is shown in figure 5-3.

The StrikeStar flight control system would rely on an integrated system consisting of a global positioning system (GPS) receiver, an inertial navigation system (INS), autopilot, and various sensing and control functions. StrikeStar navigation would rely on GPS precision “P” code data. Eventually, as potential enemies develop GPS jamming capabilities to prevent GPS use in target areas, an INS could provide redundancy and allow limited autonomous operation in the event GPS countermeasures are encountered. Other UAVs could also be used to broadcast high power, synchronous broadband satellite signals over target areas to counter GPS countermeasures.⁹

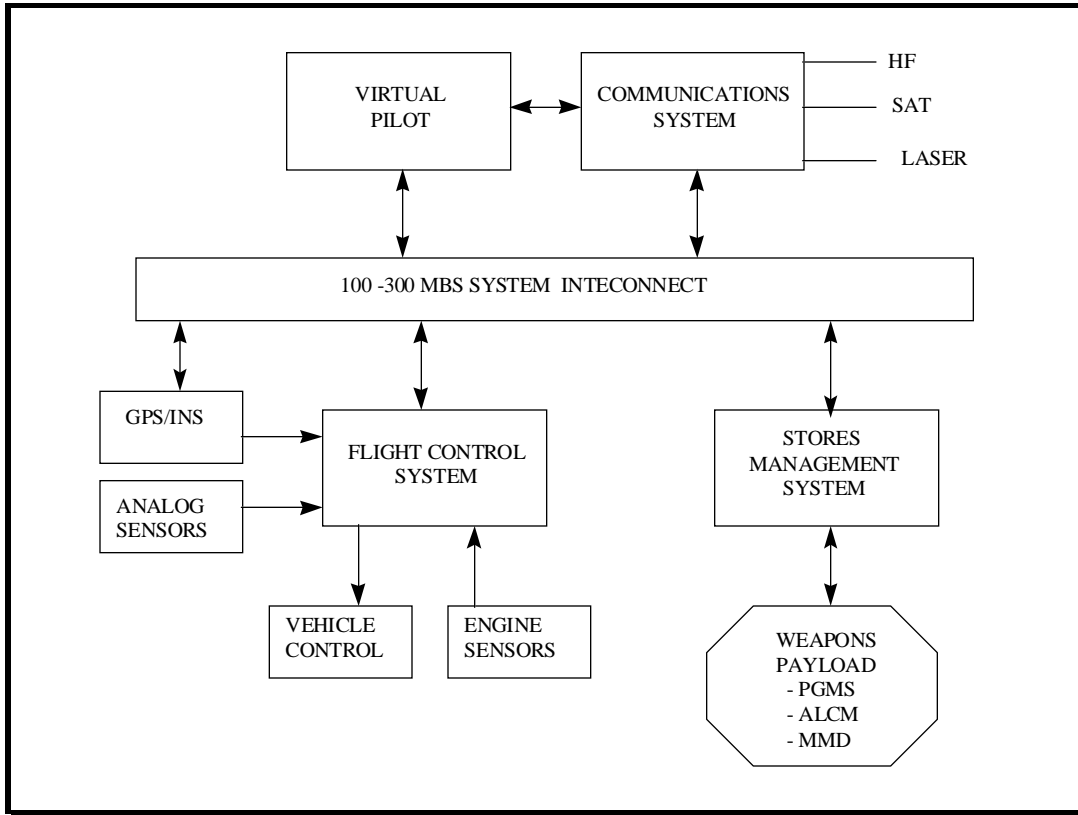

Figure 5-3. StrikeStar Notional Avionics

GPS location data could be transmitted to the control station at all times except in autonomous or preprogrammed operation. Components produced in the Tri-Service Embedded GPS/Inertial Navigation System (EGI) Program, which integrates GPS into the fighter cockpit for better navigation and weapon guidance, could be adapted for use in StrikeStar.¹⁰ In addition to GPS data, StrikeStar would transmit altitude, airspeed, attitude, and direction to control station operators as requested.

The Virtual Pilot provides StrikeStar with a computational capability far exceeding current airborne central computer processing capabilities. Virtual Pilot would consist of an artificial intelligence engine relying on a massively parallel optical processing array to perform a wide range of pilot functions during all operational modes. In addition, the Virtual Pilot could perform self-diagnostic functions during all phases, flight operation phases, and maintenance checks. An antfratricide system would reside in the Virtual Pilot to ensure that combat identification of friendly forces is accomplished before weapon release. This would provide an additional fail-safe to any battlefield awareness systems present in the target area and allow

limited extension of a battlefield combat identification to future allies operating with US forces. StrikeStar would also be capable of interrogating and classifying identification friend or foe transponder-equipped platforms to facilitate use of that data in air-to-air engagements and identify potential airborne threats.

Propulsion System

Many current UAV systems are based on inefficient, propeller-driven airframes powered by internal combustion engines, relying on highly volatile aviation gasoline, which causes military forces significant safety and logistics issues. Propeller improvements are progressing, but the desire for stealthy platforms steers many designers away from these systems with the exception of the Predator. Gas turbine engines have been demonstrated for rotary wing applications and the use of jet engines has been widely demonstrated and proven highly effective in combat operations.¹¹ Significant research has been conducted on electrically powered platforms that rely on expendable and rechargeable batteries. Recently, fuel cell application research increased, as evidenced by demonstrations of the solar rechargeable Pathfinder.¹² Unfortunately battery and fuel cell systems exhibit low power and energy densities relative to hydrocarbon fuels. For that reason, internal combustion engines will continue to be the mainstay for less sophisticated UAV propulsion systems.

Jet engine design is a trade-off between airflow and fuel to maximize performance. Engine designers either enlarge the size of engine intake to increase airflow or provide more fuel to the jet engine combustion chambers to produce the desired propulsion characteristics. Since most jet engines rely on conventional fuels, designers increased intake size to maximize fuel efficiency and improve range and endurance. However, increasing UAV intake size is not desirable since this impacts the stealth characteristics and overall aerodynamic efficiencies of small airframes. Exotic or alternative fuels hold much promise for powering future aircraft and extensive research has been conducted on potential new aircraft fuels. Table 3 provides some potential aircraft fuel characteristics.

Table 3

Fuel Characteristics

Fuel	Btu/lb	Btu/cu ft	lbs/cu ft	Btu/lb of fuel
JP	18,590	940,000	50.5	0.47
Hydrogen	51,500	222,000	4.3	3.20
Methane	21,500	570,000	26.5	0.49
Propane	19,940	720,000	36.1	0.65
Methanol	8,640	426,000	49.4	0.60
Boron	30,000	1,188,000	39.6	0.57
JP from coal	18,830	996,000	53.0	0.47

Source: Senate, Hearings before the Subcommittee on Aerospace Technology and National Needs of the Committee on Aeronautical and Space Sciences, 94th Congress, 2nd sess., 27-28 September 1976.

Exotic fuels have been used for manned platforms in the past, but only in isolated cases because of the risks associated with them. Risk to man is minimized on UAV platforms except during launch and recovery cycles, and while storage of exotic fuels remains a concern, storage technology is improving. Still, exotic fuels represent a viable option for improving enthalpy on UAV platforms. Hydrogen-based fuels provide significant increases in energy density over conventional hydrocarbon fuels, and such fuels could be widely employed in UAVs by 2025 if current research advances continue and a nationwide manufacturing and distribution network emerges.

Weapon Systems

Weapons with current, precision-guided-munitions characteristics, new nonlethal weapons, and directed-energy weapons could provide StrikeStar with the capability to strike at all levels of conflict from military operations other than war to full-scale war. The key to producing a StrikeStar that can hold the enemy at risk is to deploy weapon systems that have all-weather and extremely precise aimpoint capabilities.

Precision-guided munitions are widely accepted as demonstrated during the Persian Gulf War. The family of Launch and Leave Low-level Guided Bombs (LLLGB), Maverick, and homing anti-radiation missiles (HARM) all represent current weapons that could be integrated into a UAV strike platform. Unfortunately, these weapons lack range and poor weather capability. New all-weather seekers are needed to provide desired battlefield dominance. New studies to produce long-range hypersonic PGMs are also underway, which if employed on a StrikeStar could significantly extend the weapon employment zone.¹³ Efforts underway on the should produce weapons technology that not only discriminates against ground targets, but operates in adverse weather conditions.¹⁴

Stores management systems (SMS) used in modern attack aircraft could be integrated into UAV avionics packages to provide required weapon control and release functions. Tight coupling between sensor platforms, the Virtual Pilot and SMS could allow for autonomous weapon selection, arming, and release without operator intervention under certain scenarios. Unfortunately, the weight and large size of current PGMs and limited functionality of current SMS suites could limit conventional weapon employment.

Recent developments on an enhanced 1,000-pound warhead proved that blast performance of 2,000-pound MK-84 is obtainable.¹⁵ Improved explosives are an enabling technology that would reduce weapon size without decreasing blast performance. Guidance and warhead improvements envisioned in the Miniaturized Munitions Technology Demonstration (MMTD) effort could produce a new class of conventional weapons. The MMTD goal is to produce a 250-pound class munition effective against a majority of hardened targets previously vulnerable only to 2,000-pound class munitions.¹⁶ A differential GPS/INS system will be integral to the MMTD munition to provide precision guidance, and smart fusing techniques will aid in producing a high probability of target kill. The kinetic energy gained by releasing these weapons at maximum StrikeStar altitudes would also help improve explosive yield. Improving bomb accuracy, focusing on lethality, and providing an all-weather capability are all technology goals which, when coupled with a StrikeStar platform, could produce a potent strike platform. MMTD advances would significantly improve weapons loading on StrikeStar. Unfortunately, conventional explosives technology has the limitation that once all weapons are expended, the UAV must return to base for replenishment. However, StrikeStar directed energy weapons would allow more strikes and reduce replenishment needs.

Directed energy weapon (DEW) technology is undergoing rapid advances as demonstrated on the Airborne Laser program. The goal to produce a laser capable of 200 firings at a cost of less than \$1,000 per shot is realizable in the near future.¹⁷ The ability for rapid targeting, tracking, and firing of a UAV-mounted DEW could deny enemy forces the ability to maneuver on ground and in the air. If initiated now, expanded research efforts could produce a smaller, more lethal, directed-energy weapon suitable for a StrikeStar platform in 2025.

Capabilities in present air-to-air weapons provide a level of autonomous operations, which if employed on StrikeStar could revolutionize offensive and defensive counter air operations. A StrikeStar loaded with both air-to-ground and air-to-air missiles could be capable of simultaneous strike and self-defense. Additional survivability could be provided by using towed decoys cued by off-board sensors. Advanced medium range air to air missile (AMRAAM) and air intercept missile (AIM-9) weapons are proven technologies already compatible with stores management systems that could be employed on StrikeStar. Internal carriage and weapon release of these missiles from a StrikeStar could rely on experiences gained in the F-22 program. Eventually, a new class of air-to-air missiles could be developed which are significantly smaller and more lethal to allow additional weapon loading.

Nonlethal weapons also present some unique possibilities for use on the StrikeStar. Nonlethal weapons are defined as:

discriminate weapons that are explicitly designed and employed so as to incapacitate personnel or material, while maintaining facilities.¹⁸

Nonlethal weapons that disorient, temporarily blind, or render hostile forces or equipment impotent, provide alternative means for neutralizing future opponents without increasing the political risk death and destruction can bring.¹⁹ Employing these weapons from StrikeStar platforms could be used in prehostility stages to demonstrate resolve and the dominant presence of orbiting weapon platforms with instantaneous strike capabilities.

Communications Systems

“What the warrior needs: a fused real-time, true representation of the Warrior’s battle space—an ability to order, respond, and coordinate horizontally and vertically to the degree necessary to prosecute his mission in that battle space.”²⁰ To provide continuous battlefield dominance, information dominance is critical for StrikeStar operations. Battlespace awareness as envisioned under the *C⁴I for the Warrior Program* will provide the information infrastructure required for command and control (C²) of the StrikeStar platforms. UAV communications systems function to provide a communications path, or data link, between the platform and the UAV control station, and to provide a path to pass sensor data. The goal of the C⁴ system is to have the head of the pilot in the cockpit, but not his body.²¹

StrikeStar communications would provide a reliable conduit for status information to be passed on a downlink and control data to be passed on the uplink in hostile electronic environments. The uplink and downlink data streams would be common datalinks interoperable with existing C⁴ datalinks to maximize data exchange between sensors, platforms, and their users. Status and control information would be continually transferred between StrikeStar and its controller in all cases except during autonomous operation or implementing preprogrammed flight operations. The data link would need to be impervious to jamming, or even loss of control, to ensure weapon system integrity. User-selectable, spread spectrum, secure communications in all transmission ranges would provide redundancy, diversity, and low detection and intercept probability. Both beyond line-of-sight and line-of-sight communications methods would be supported to a variety of control stations operating from aerospace, land, and sea platforms.²²

Command and control of UAVs via satellite links has been demonstrated to be highly reliable.²³ The MILSTAR constellation or its follow-on could serve as the primary C² communications network for StrikeStar platforms. MILSTAR’s narrow-beam antennas coupled with broad-band frequency hopping provides isolation from jammers and a very low probability of detection.²⁴ The Defense Satellite Communications System (DSCS) constellation and Global High-Frequency Network could provide alternate paths for connectivity and redundancy depending on mission profiles. The vast HF network provides nearly instantaneous coverage and redundancy under adverse environmental conditions (fig. 5-4).²⁵ High-Frequency can provide commanders with useful, flexible, and responsive communications while reducing the demand on

overburdened satellite systems.²⁶ The continued proliferation of commercial satellite networks may allow StrikeStar platforms to exploit these networks as viable communications paths as long as C² integrity of on-board weapons is assured.

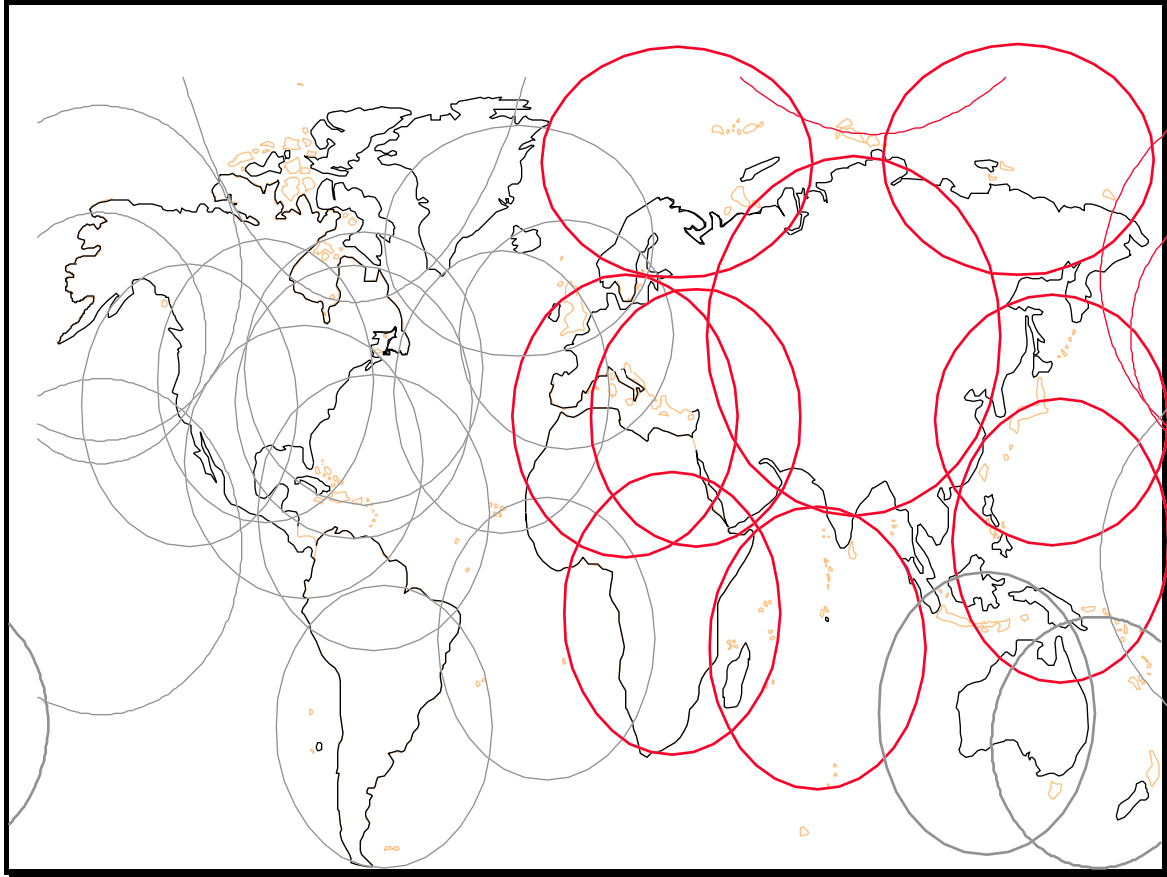

Figure 5-4. Global HF Network Coverage

StrikeStar would rely on other platforms, like Predator, DarkStar, Global Hawk or ground, airborne, or space reconnaissance, to detect and locate potential targets. The StrikeStar could team with any or a combination of all these assets to produce a lethal hunter-killer team. Once geolocated, the target coordinates would be passed to StrikeStar along with necessary arming and release data to ensure successful weapon launch when operating in command-directed mode. In autonomous mode, StrikeStar would function like current cruise missiles, but allow for in-flight retargeting, mission abort, or restrike capabilities. Communications for cooperative engagements with other reconnaissance platforms require minimum bandwidth between StrikeStar and its control station since the targeting platforms already provide the large bandwidth necessary for sensor payloads.

As with any C⁴ system, we anticipate StrikeStar's requirements would grow as mission capabilities and payloads mature. It is possible StrikeStar follow-ons could be required to integrate limited sensing and strike payloads into one platform, thus significantly increasing datalink requirements. In this event, wideband laser data links could be used to provide data rates greater than 1 gigabit per second.²⁷ In addition, a modular payload capability could allow StrikeStar platform to carry multimission payloads such as wideband communications relay equipment to provide vital C⁴ links to projected forces.²⁸

Mission Control Equipment

As mentioned, StrikeStar will be controllable from a multitude of control stations through the common data link use. Control stations could be based on aerospace, ground, or sea platforms depending on the employment scenario. A control station hierarchy could be implemented depending on the employing force's composition and the number of StrikeStars under control. The StrikeStar C² hierarchy and control equipment would allow transfer of operator control to provide C² redundancy. Current efforts by DARO have established a common set of standards and design rules for ground stations.²⁹ This same effort needs to be accomplished for aerospace and sea based control stations.

Significant efforts to miniaturize the control stations would be needed to allow quick deployment and minimum operator support through all conflict phases. Man-machine interfaces would be optimized to present StrikeStar operators the ability to sense and feel as if they were on the platforms performing the mission. Optimally, StrikeStar control could be accomplished from a wide variety of locations ranging from mobile ground units to existing hardened facilities. The various control stations would be capable of selectively controlling StrikeStars based on apriori knowledge of platform C² and identification procedures.

Launch and Recovery Equipment

Launch and recovery are the most difficult UAV operations and are the greatest factors inhibiting wider acceptance.³⁰ A variety of launch and recovery systems are used worldwide. Launchers range from simple hand launchers to sophisticated rocket-assisted take-off systems (fig. 5-5). Recovery systems range

from controlled crash landings to standard runway landings. StrikeStar would launch and recover like manned aircraft, and carrier-based operations could be considered as another viable option to improve loiter times and mission flexibility.



Figure 5-5. Rocket-Assisted Hunter UAV Launch

The goal for StrikeStar launch and recovery would be autonomous launch and recovery via an enhanced landing system (ELS), although it could operate with the current instrument landing system (ILS) and microwave landing system (MLS) equipment under operator control. ILS is prone to multipath propagation and MLS is susceptible to terrain variations and the presence of nearby objects; thus both would not be acceptable for truly autonomous recovery of StrikeStar platforms.³¹ The ELS would overcome these deficiencies by using GPS, high resolution ground mapping techniques, and optical sensing to land without operator control.

Technologies to support the StrikeStar do not appear to represent significant challenges. In most cases proven technologies can be expected to evolve to a level that will overcome all hurdles by the year 2025. Determining the doctrinal and operational changes required to integrate a StrikeStar capability presents more significant challenges, considering the aversion our service has had with UAVs in the past.³² Technology for StrikeStar is evolutionary where as organizational acceptance and employment will be revolutionary.

Notes

¹ Lt Col Dana A. Longino, *Role of Unmanned Aerial Vehicles in Future Armed Conflict Scenarios* (Maxwell AFB, Ala.: Air University Press, December 1994), 3–4; “Unmanned Aerial Vehicles,” *Armada International*, 1990, *Naval Technical Intelligence Translation 910098*, DTIC Report AD - B153696, 10 April 1991, 3.

² Defense Daily, 2 February 1996, 162.

³ Maj William R. Harshman, *Army UAV Requirements and the Joint UAV Program*, DTIC Report AD - A228149 (US Army Command and General Staff College Thesis, June 1990), 4.

⁴ K. Cameron, *Unmanned Aerial Vehicle Technology* (Melbourne Australia: Defense Science and Technology Organization, February 1995).

⁵ *Janes Unmanned Aerial Vehicles, Launchers and Control Systems, 1994* (Surrey, UK: Janes Information Group Limited), 253.

⁶ Cameron, 21.

⁷ *Air Progress*, September 1995, 47-49.

⁸ David A. Fulghum, “McDonnell Douglas JAST Features Expanding Bays,” *Aviation Week and Space Technology*, 19 February 1996, 52. In this article a smart-skin-type experimental coating is discussed. This coating attenuates radar reflections with customized carbon molecules. When activated by an electric charge it can also change the skin’s color from sky blue to earth and foliage-colored hues to fool optical sensors.

⁹ *Ibid.*, 66.

¹⁰ ARPA Technical Abstract, (Internet: December 1995).

¹¹ Longino, 2.

¹² Lawrence Livermore National Laboratory Technical Abstract, *Solar-Electric Aircraft* Internet: January 1996.

¹³ Mr Wayne A. Donaldson, WL/POPA, Fuels Engineer, E-mail, 2 February 1996; AF 2025 Assessor comments, 28 March 1996.

¹⁴ “Smart Bombs get their Ph.D.,” *CNN Interactive Technology*, Internet, 1 February 1996.

¹⁵ “Energetic Materials Branch/High Explosives Research and Development Facility Home Page,” (Eglin AFB, Fla., January 1995).

¹⁶ “Miniaturized Munition Technology Demonstration Abstract,” January 1995, 2.

¹⁷ Suzanne Chapman, “The Airborne Laser,” *Air Force Magazine* January 1996, 54–55.

¹⁸ E. E. Casagrande, *Nonlethal Weapons: Implications for the RAAF* (RAAF Base Fairbarin, Australia: Air Power Studies Center, November 1995), 6.

¹⁹ Peter Petre and H. Norman Schwarzkopf, *It Doesn’t Take a Hero* (N.Y.: Bantam Books, 1992), 468. Considering the death and destruction on the Highway of Death, General Powell informed General Schwarzkopf that the White House was getting nervous: “The reports make it look like wanton killing.”

²⁰ Adm Richard C. Macke, *C4I for the Warrior*, 12 June 1992.

²¹ Robert K. Ackerman, “Tactical Goals Encompass Sensors, Autonomous Arts,” *Signal*, December 1995, 27.

²² USAF Scientific Advisory Board, *New World Vistas: Air and Space Power for the 21st Century*, summary volume (Washington, D.C.: USAF Scientific Advisory Board, 15 December 1995), 27.

²³ Joint Precision Strike Demonstration (JPSD) Beyond Line of Sight UAV Demonstration, JPSD Program Office, March 1994, vi–viii.

²⁴ Adm James B. Busey IV, “MILSTAR Offers Tactical Information Dominance,” *Signal*, July 1994, 11.

²⁵ AFC⁴A Briefing, Global HF Consolidation, November 1994.

²⁶ Michael A. Wallace, "HF Radio in Southwest Asia," *IEEE Communications*, January 1992, 59-60.

²⁷ "Optical Space Communications Cross Links Connect Satellites," *Signal*, April 1994, 38.

²⁸ Col Dale W. Meyerrose, HQ USAFE/SC, E-mail, 21 January 1996. In this E-mail Col Meyerrose explained how a long-loiter UAV capable of relaying combined air operations center communications to pilots over Bosnia would have been a much better solution than building the line-of-sight communications system in enemy territory; Kenneth L. Gainous and William P. Vaughn, *Joint Warrior Interoperability Demonstration 1995 After Action Report for the MSE Range Extension Repeater*, 16 November 1995. In this effort, a UAV was used to extend voice and data communications for US Army Deep Strike Assault Mission.

²⁹ Defense Airborne Reconnaissance Office Annual Report *Unmanned Aerial Vehicles*, (Washington, D.C., August 1995), 28.

³⁰ Cameron, 28-30.

³¹ Aubrey I. Chapman, *Remotely Piloted Vehicle Technology*, DTIC AD-B131985 (Radar Guidance Inc., San Antonio, Tex., 17 April 1989), 17-18.

³² Harshman, 17; Longino, 27-31.

Chapter 6

StrikeStar Concept of Operations

We're getting into UAVs in a big way. We understand they have enormous potential.

—General Joseph W. Ralston

The purpose of the StrikeStar concept of operations is to define the operational application of the StrikeStar by highlighting system advantages, defining future roles and missions, and illustrating interrelationships between intelligence, command and control (C²), the weapon, and the war fighter.

The Dawn of a New Era for Airpower

Historically, America has held expectations for airpower just beyond the limits of available technology, and now a new national expectation is emerging. Today, airpower application is expected to equate to cost-effective, precise, and low-risk victory.¹ These inexorable expectations could be a reality in 2025 because a StrikeStar could hold strategic, operational, and tactical targets at risk with relative immunity to enemy defenses. This platform could operate in high risk or politically sensitive environments, perform its mission, and return to fly and fight again. The StrikeStar would enable the United States military to meet the national expectations and the threats of a changing world.

Underpinning the StrikeStar concept is the platform's ability to deliver increased combat capability with reductions in vulnerability and operating cost. The StrikeStar's 8,000 nautical mile combat radius would have the potential to keep vulnerable logistics and maintenance support far from hostile areas. Also, dramatic savings would be possible in operations, maintenance, personnel, and deployment costs.

Logistically the StrikeStar could be handled like a cruise—missile; stored in a warehouse until needed and then pulled out for a conflict. The potential savings over conventional aircraft could range from 40 percent to as much as 80 percent.² Training could be conducted using computer simulation with actual intelligence, surveillance, and reconnaissance inputs. While potential savings are impressive, the most attractive aspects of this platform and its supporting elements are the capabilities the StrikeStar System could deliver to tomorrow's commanders in chief (CINCs):

1. The StrikeStar could be configured to perform a variety of missions as diverse as surveillance to the delivery of precision weapons.
2. Operating altitudes could make it a true all-weather platform capable of remaining on-station regardless of area of operations (AO) weather.
3. Battlespace presence: depending on the weapons carried, a handful of StrikeStars could equate to continuous coverage of the AO.
4. Power projection: StrikeStar operations need not compete for ramp space with other theater assets. The combat radius would normally facilitate operations from coastal Continental United States locations or strategically located staging bases to improve loiter time (fig. 6-1).
5. Such an aircraft could accelerate the CINC's Observe, Orient, Decide, Act loop (OODA Loop) with immediate battle damage assessment (BDA) and restrike capability.
6. The employment concept of operations could shorten the chain of command, simplifying accountability and improving operations security.
7. A StrikeStar could enable a CINC to operate in environments where casualties, prisoners of war, or overt United State military presence are politically unacceptable.
8. A StrikeStar and its supporting systems could be tailored to have utility across the across the spectrum of conflict.
9. A StrikeStar in a combat environment could "buy back" battlespace flexibility.³

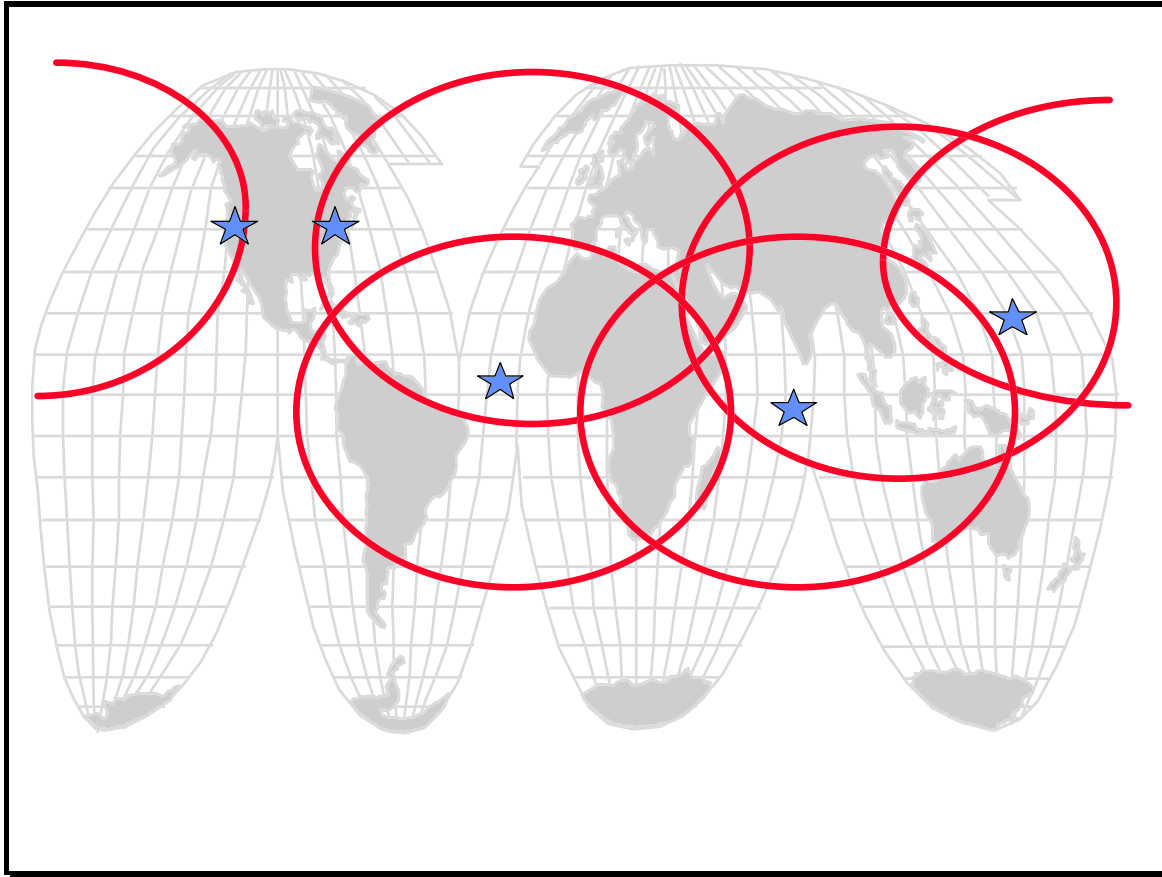

Figure 6-1. StrikeStar Coverage

Roles and Missions

Aerospacepower roles and missions in 2025 are difficult to predict, yet we know they will be tied to the nature of future conflict. Desert Storm has been touted by many as the first modern war and a clear indicator of the nature of future conflict. Others believe that the conflict was not the beginning of a new era in warfare but the end of one, perhaps the last ancient war.⁴ In terms of posing aerospace forces for the future, it is imperative we look for discontinuities in the nature of future war as well as commonalities to past conflicts. It is a fact that our future roles and mission will be a reflection of our technological capabilities and most significant centers of gravity as well as those of our enemies.⁵ It is safe to say the missions that are the most challenging today will be the core requirements of aerospacepower tomorrow.

The StrikeStar complements the current understanding of air roles and missions and could provide a technological bridge to accomplish future roles and missions. The platform's most natural applications would be in aerospace control and force application roles; however, planned versatility also makes it a force multiplier and a force enhancer.⁶ A payload and communications package swap could enable a StrikeStar to perform electronic combat, deception, or reconnaissance missions. A StrikeStar could act as a stand-alone weapons platform or it could multiply combat effectiveness by working in conjunction with other air and space assets. StrikeStar's utility in the performing any future missions would be limited only by its combat payload capacity and this limitation will be offset by revolutions in weapons technology that include light-weight, high-explosive, and directed-energy technology.⁷ Yet, even by today's standards a StrikeStar could match the planned payload capacity of the Joint Strike Fighter (JSF).⁸ Revolutions in conventional warfare will be driven by rapidly developing technologies of information processing, stealth, and long-range precision strike weapons.⁹ A StrikeStar's relative invulnerability, endurance, and lethality would force redefinition of roles and missions and revolutionary doctrinal innovation for airpower employment.

For centuries war fighters labored to find the weapon that gave them a panoptic effect on the battle field.¹⁰ The inherent flexibility and lethality of airpower provided us with great gains toward this long-sought goal. However, limitations in technology, airframes, and the national purse have led to a less than ubiquitous presence over intended areas of operations. A StrikeStar could be the conduit to achieving this goal. The "kill boxes" of Desert Storm would give way to 24-hour "air occupation" of the AO. Airpower theorist Col John Warden states that the primary requirements of an air occupation platform in the future are stealth, long endurance, and precision.¹¹

Not only could a StrikeStar hold the enemy at risk, it could produce unparalleled psychological effects through shock and surprise. In the words of Gen Ronald Fogleman, Chief of Staff, United States Air Force, "So, from the sky in the aerospace medium, we will be able to converge on a multitude of targets. The impact will be the classic way you win battles—with shock and surprise."¹² A StrikeStar could produce physical and psychological shock by dominating the fourth dimension—time.¹³ Future CINC's could control the combat tempo at every level. Imagine the potential effect on enemies who will be unable to predict where the next blow will fall and may be powerless to defend against it.

The possibilities for joint force combat applications of this system are enormous. A StrikeStar could be a multiplier used to increase the tether of naval fleet operations or as a strike platform with marine expeditionary applications. It could be used as a high-value asset (HVA) escort or in combat air patrol (CAP), allowing assets normally tasked for these roles to be retasked for other missions. An example of a StrikeStar force enhancement capability is its potential use in tactical deception. A possible employment scenario could include a StrikeStar releasing air-launched decoys over an area of suspected surface-to-air missiles, and as enemy radars come on line to track the approaching decoys, the StrikeStar would destroy them.¹⁴ It could then follow the strike package of F-22s or JSFs, loiter over the battle area, and perform near real-time restrike as directed.

Concepts of Employment

In this section, concepts of employment describe the architecture required to employ the StrikeStar and detail the concept of operations in two notional operating modes. The final areas covered are critical tasks and weapons employment.

The System Architecture

The StrikeStar is inextricably linked to reconnaissance and command and control systems. The system architecture depicted in figure 6-2 illustrates how a StrikeStar is tied and integrated into the larger battle space systems. Keep in mind that it is the entire architecture, or the system of systems, which enables mission accomplishment.¹⁵ The StrikeStar is a relatively dumb system: it carries few sensors, and it is not designed for a great deal of human interface. The viability of the StrikeStar concept in 2025 depends on its ability to plug into the existing battlespace dominance and robust C².

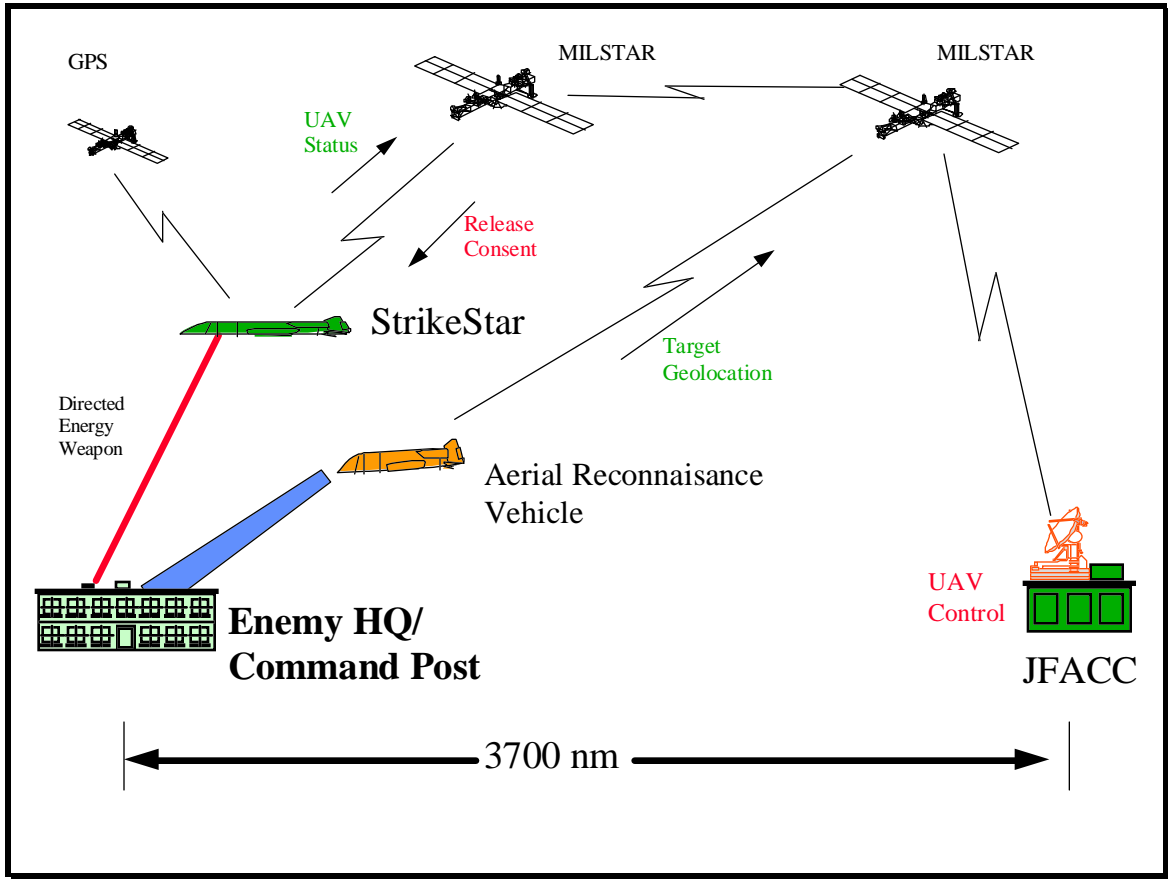

Figure 6-2. StrikeStar C² Architecture

Former Vice Chairman of the Joint Chiefs of Staff Admiral Owen's prediction that the United States military will enjoy dominant battlespace awareness by 2010 is a prerequisite to this concept.¹⁶ Dominant battlespace awareness in 2025 must include near real-time situational awareness, precise knowledge of the enemy, and weapons available to affect the enemy.¹⁷ This intelligence must be comprehensive, continuous, fused, and provide a detailed battlespace picture. The intelligence-gathering net will utilize all available inputs from aerospace assets, both manned and unmanned sensors.¹⁸ The StrikeStar would rely on this integrated information for employment, queuing, and targeting. A StrikeStar in this architecture adds value since it enables an aerospace platform to provide dominating maneuver with lethal and precise firepower in a previously unattainable continuum of time. A pictorial representation of this concept is presented in figure 6-3.

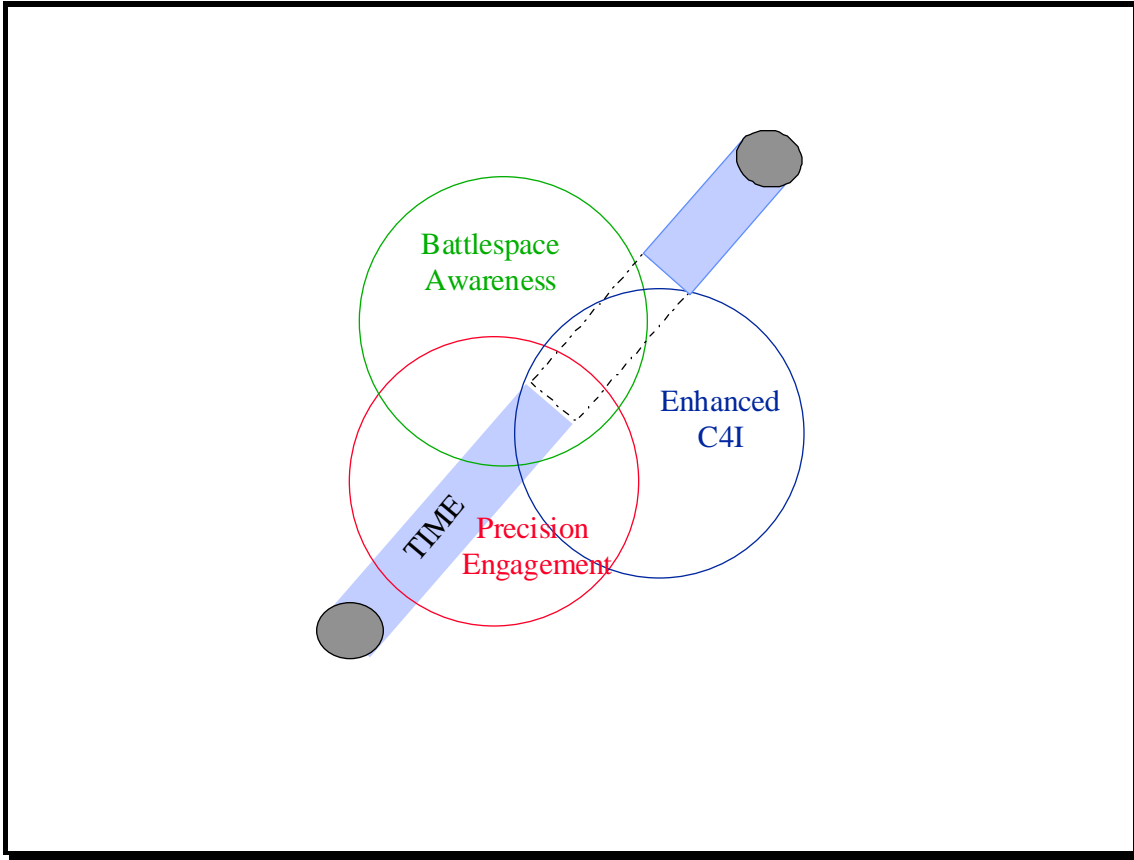

Figure 6-3. A System of Systems Over Time Continuum

Command and control capabilities in 2025 are the defining element in the StrikeStar concept. A StrikeStar would need to be fully integrated into a common C² element that manages all aspects of the air battle in 2025.¹⁹ A StrikeStar places several unique demands on the command and control element. C² personnel would employ a StrikeStar by nominating targets, pulling down required intelligence, and selecting the platform and weapon to be used against them. The command element could then command weapons release or tie the StrikeStar directly to an AO sensor in an autonomous mode. In the autonomous mode intelligence is collected, sorted, and analyzed and then forwarded to a StrikeStar positioned to attack immediately a target by-passing the C² element (sensor-to-shooter).²⁰ To reduce vulnerability of the command center and StrikeStar, data-link emissions should be held to a minimum.

The type and location of the command center used in 2025 will depend on the nature of the conflict. Missions of the most sensitive nature, clandestine operations, or retaliatory strikes are best served by a short and secure chain of command. Therefore, these StrikeStar applications would be best served by a direct link

to the platform from a command center located in the hub of political power. Similarly, if a StrikeStar is utilized in extremely hostile theaters, a command and control center located far from hostilities is most advantageous. In low-intensity conflicts, peace enforcement, or domestic urban applications, the C² center could be moved to the vicinity of the conflict as a mobile ground station, an airborne platform, or even a space-based station.

Autonomous Strike Mission

The strike mission highlights the utility of a potentially autonomous mode of operation. This operating mode could free command and control center personnel to manage other assets. In the strike mode a StrikeStar would capitalize on the principles of simplicity, surprise, offensive, and objective.²¹ The following details an autonomous strike mission (fig. 6-4).

Ground operations. A StrikeStar is tasked from Continental United States or a forward operating location to strike specific AO target(s). Mission specifics including target coordinates, time-on-target, takeoff time, and abort criteria are loaded directly into the aircraft computer via a physical link from the mission-planning computers. (The use of ground crew personnel is possible, however this option introduces potential for human error).

Launch. StrikeStar performs premission diagnostic checks, starts, and taxis to meet its designated takeoff time. The aircraft would require improved taxiways and runways to support a notional, maximum gross operational weight of 24,000 pounds. Taxiways and runways must provide adequate obstacle clearance to accommodate a StrikeStar's 105 feet wing span. The runway length required will be approximately 4,000 feet for takeoff, landing, and abort distances. The StrikeStar would taxi via global positioning and airfield information. Mission support personnel would deconflict operations with ground control and tower or sanitize the airfield during ground operations and takeoff.

Climb Out. When operating in congested or controlled airspace it would be necessary to deconflict a StrikeStar with potential air traffic. In these cases the aircraft would be programmed to perform a spiral climb over the field until above the future equivalent of positive controlled airspace. (This may require coordination for airspace above and around the aerodrome for operations within the United States).

Enroute. The StrikeStar would proceed to the target as programmed unless updated information is passed from the command center. Integrated engine and airframe function indicators would be constantly monitored and adjusted automatically for peak performance by the Virtual Pilot. Engine anomalies will be compared against pre-programmed go/no-go criteria, and in the event an abort criterion is discovered, a message would be automatically passed to the C² center for action.

Ingress. A StrikeStar would proceed to the target via the programmed flight path. Although stealthy technology and altitude reduces vulnerability, flight path programming should integrate intelligence preparation of the battlefield (IPB) to optimize this technology and avoid obvious threats. Once in the AO the StrikeStar would release its weapons or recognize its assigned sensor and establish a “kill box.” The kill box is a block of space where the StrikeStar releases weapons on threats identified by coupled sensors.²²

Egress. StrikeStar would egress the AO using preprogrammed information or remain on-station in a preprogrammed orbit awaiting battle damage assessment (BDA) and potential retargeting information until egress was required.

Recovery. StrikeStar would fly to the airdrome's vertical protected air space, and execute a spiral descent unless otherwise directed. The aircraft would perform a precision approach and landing, taxi clear of the active runway, and return to parking, using the enhanced landing system (ELS) discussed earlier.

Regeneration. Maintenance time would be kept to a minimum through computer diagnostics provided to ground personnel on landing, and blackbox swap technology. The aircraft could be refueled, rearmed, reprogrammed, and "turned" quickly after landing.

System compromise. A StrikeStar is intended to be a durable platform, however system degradation due to battle damage or malfunction could compromise the platform. To ensure that classified programming information remains secure, preprogrammed information will be altitude volatile. Additionally, to prevent reverse engineering or endangerment of friendly forces, the airframe could be destroyed by on-board weapons or another StrikeStar in the event of an inadvertent landing or errant behavior.

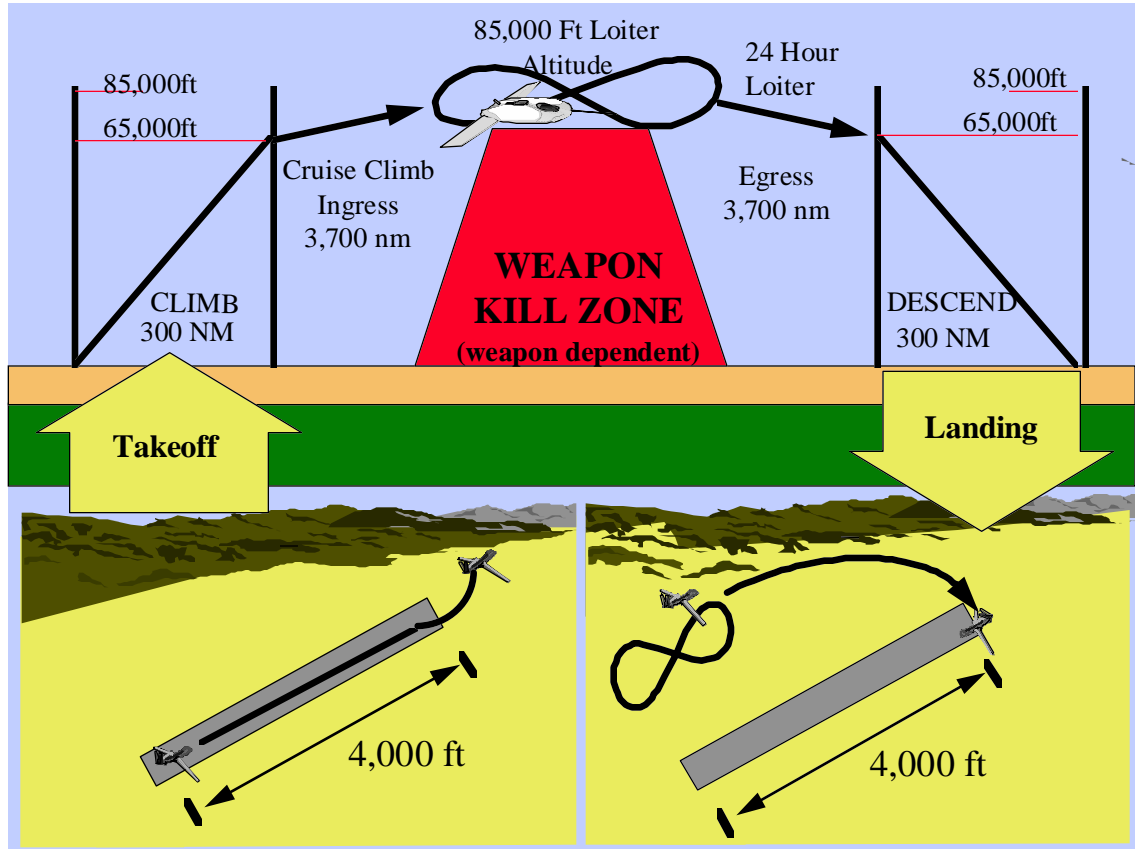

Figure 6-4. StrikeStar Mission Profile

Command Directed Mission

The specifics of the command-directed mission overlap many of the aspects of the autonomous mission. The fundamental distinction between the two operating modes is that the command directed mission requires command center inputs. In this operating mode, the StrikeStar could exploit the principles of unity of command, maneuver, mass, and economy of force. While the StrikeStar employment would naturally mesh with the tenets of aerospace power, this platform would define new limits to the tenets of persistence, flexibility, and versatility.²³ The objective of the command-directed mission is to provide continuous presence over the battle-field and maximize flexibility. Mission areas unique to command-directed missions are delineated below.

Ingress. A StrikeStar would be preprogrammed to a specific orbit where it would await closure of the C² elements OODA loop. This closure would provide the platform with the required information on optimum positioning and targeting commands.

Egress. A StrikeStar would remain on-station until fuel or weapons expenditures require a return to base. Fuel and weapons status will be provided to the command element on request. A return to base message will be transmitted at a predesignated navigation point. Due to the long loiter time in the AO, the planned recovery location may have changed, so updated landing information will be passed to the aircraft as situations dictate.

Critical Tasks and Weapons Employment

The 2025 battle space will have both unique and familiar features. The StrikeStar could leverage available weapons technology to perform many critical tasks. As noted in the *New World Vistas*, there will be a number of tasks that must be accomplished. Among the most pressing tasks in 2025 will be the destruction of short-dwell targets, and theater ballistic missile defense.²⁴ Additionally, the potential of air occupation must be explored. A final task, well suited to a StrikeStar, would be covert action against transnational threats located in politically denied territory or in situations where plausible deniability is imperative.

The ability of a StrikeStar to loiter over an area for long periods and exploit information dominance with precision weapons, would make it a natural Theater Missile Defense (TMD) platform, particularly in boost phase intercept. A StrikeStar could be employed in the AO in a sensor-to-shooter mode looking for ballistic missiles in the first 180 seconds of flight. Intercepting missiles from high altitudes early in the boost phase increases the chances that dangerous debris would fall on enemy territory.²⁵ The weapon employed against TBMs or other short-dwell targets could be directed-energy weapons or hypersonic interceptor missiles.²⁶ The optimum weapons selection for a StrikeStar would match weapons availability to loiter capability. A StrikeStar offers the advantages of a space-based TBM defense weapon in terms of operational reach, a vast distance over which military power can be concentrated and employed decisively, and it extricates the military from the issues of the militarization of space.²⁷

The StrikeStar approach to systems lethality and loiter capability could enable the Air Occupation concept. Because of a StrikeStar's endurance, altitude, and stealth characteristics, it could wait, undetected, over a specific area and eliminate targets upon receiving intelligence cues. If required for plausible deniability, specialized weapons could be used to erase any US finger-print. Uniquely suited to a StrikeStar would be delivery of high-kinetic-energy penetrating weapons. Firing kinetic weapons at StrikeStar's operational altitudes would allow engagements at longer ranges.²⁸

Countries conform to the will of their enemies when the penalty of not conforming exceeds the cost of conforming. The cost can be imposed by destruction or physical occupation of enemy territory. In the past, occupation was conducted by ground forces—because there was no good substitute.²⁹ In 2025, a StrikeStar could send a lethal or nonlethal message to US enemies and enforce the imposition of our national will through air occupation across the battle space continuum.

It is estimated that over half the nations of the world have active UAV programs.³⁰ Because of the proliferation of UAV technologies, the United States may face enemy UAVs similar to StrikeStar in the future. Although beyond the scope of this paper, consideration must be given to how a StrikeStar will fit into, and possibly shape the 2025 battlespace. The broad influence that UAVs could have on military roles and missions will drive evolutionary changes in service doctrine. The issues of how best to employ strike UAVs, the details of the human-system interface, and potential countermeasures must be explored before this weapon system can fulfill its potential.

Notes

¹ USAF Scientific Advisory Board, *New World Vistas: Air and Space Power for the 21st Century*, summary volume (Washington, D.C.: USAF Scientific Advisory Board, 15 December 1995), 60.

² David A. Fulghum, "New Priorities Refocus Ballistic Missile Defense," *Aviation Week and Space Technology*, 19 February 1996, 25.

³ *Ibid.*, 25.

⁴ Gen Merrill A. McPeak, *Selected Works 1990-1994* (Maxwell AFB, Ala.: Air University Press, August 1995), 230.

⁵ Col Phillip S. Meilinger, *10 Propositions Regarding Air Power* (Maxwell AFB, Ala.: Air Force History and Museums Program, 1995), 60.

⁶ AFM 1-1, *Basic Aerospace Doctrine of the United States Air Force*, 2 vols., March 1992, 7.

- ⁷ John Boatman, "Highly Energetic Bomb Studies," *Jane's Defense Weekly*, March 1995, 81.
- ⁸ David A. Fulghum, "Mcdonnell Douglas JAST Features Expanding Bays," *Aviation Week and Space Technology*, 19 February 1996, 52.
- ⁹ James R. Fitzsimuonds and Jan M. Vantol, "Revolution in Military Affairs," *Joint Force Quarterly*, Spring 1994, 27.
- ¹⁰ Col John Warden, USAF Retired, address to Air Command and Staff College, Maxwell AFB, Ala., October 1995. The panoptic effect refers to the power that continuous surveillance and presence has in the ability to control large numbers of people. People begin to react to the pressure of constant surveillance even when it is not present.
- ¹¹ Col John Warden, USAF Retired, video address to Air Command and Staff College, Maxwell AFB, Ala., War Termination, January 1996.
- ¹² Gen Ronald R. Fogleman, chief of staff, United States Air Force, address to the Air Force Association, Orlando, Fla., 24 February 1995.
- ¹³ Col Phillip S. Meilinger, 1, 30.
- ¹⁴ David A. Fulghum, "DarkStar First Flight Possible in March," *Aviation Week and Space Technology*, 19 February 1996, 55.
- ¹⁵ Lt Col Michael R. Mantz, *The New Sword: A Theory of Space Combat Power* (Maxwell AFB, Ala.: Air University Press, May 1995), 17.
- ¹⁶ Adm William A. Owens, USN, Vice Chairman, Joint Chiefs of Staff, address to the AF 2025 Study Group, Maxwell AFB, Ala., 13 August 1995.
- ¹⁷ "Warfighting Vision: 2010 A Framework for Change," (Ft Monroe Va: Joint War fighting Center, August 1995), 10.
- ¹⁸ "Surveillance and Reconnaissance, Real-Time Integration," 2025 concept briefing, Maxwell AFB, Ala., 19 January 1996.
- ¹⁹ Unmanned Aerial Vehicle Technology Report, 2.
- ²⁰ Warfighting Vision: 2010 A Framework for Change, 10.
- ²¹ AFM 1-1, *Basic Aerospace Doctrine of the United States Air Force*, 7.
- ²² Richard P. Hallion, *Storm over Iraq Air Power and the Gulf War* (Washington. D.C.: Smithsonian Institution Press, 1992), 155.
- ²³ AFM 1-1, *Basic Aerospace Doctrine of the United States Air Force*, 9.
- New World Vistas*, summary volume, 36.
- ²⁵ William B. Scott, "Kinetic-Kill Boost Phase Intercept Regains Favor," *Aviation Week and Space Technology*, 4 March 1996, 23.
- ²⁶ Fulghum, 53.
- ²⁷ Joint Pub 3-0 *Doctrine for Joint Operations*, 1 February 1995, III-16.
- ²⁸ William B. Scott, "Kinetic-Kill Boost Phase Intercept Regains Favor," *Aviation Week and Space Technology*, 4 March 1996, 23.
- ²⁹ Jeffrey Mckitrick et al., "The Revolution in Military Affairs," in Barry R. Schneider and Lawrence E. Grinter, eds., *Battlefield of the Future: 21st Century Warfare Issues*. (Maxwell AFB, Ala.: Air University Press, September 1995), 121.
- ³⁰ Air and Missile Threat to the Force," Air and Missile Threat Briefing, Fort Bliss Threat Office, 1996, 14.

Chapter 7

Conclusions

There will always be men eager to voice misgivings, but only he who dares to reach into the unknown will be successful. The man who has been active will be more leniently judged by the future.

—General Heinz Guderian
Armored Forces

Many important issues face our military's leadership over the next 30 years. Continuing to build a reliable force structure amidst shrinking budgets is a challenge that must be met head-on. Recognizing the opportunity for growth beyond the UAV's reconnaissance mission is a must if the US military is to be ready for all aspects of the conflict spectrum. While there are other near-term priorities for military spending, UAV development beyond reconnaissance requires specific funding for research and development, and operations and maintenance. Estimating seven years for development and three years from initial fielding to a full operational capability, the lethal UAV concept should be supported and funded no later than 2015. In reality, this milestone should be achieved earlier, but we live in an imperfect world and funding for our future force is only growing smaller.¹

The technologies discussed here are realizable by 2025. Current UAV advanced concept technology demonstration (ACTD) efforts by Defense Airborne Reconnaissance Office's (DARO) will provide the leverage we need to take the next step in UAV missions. Current efforts to improve conventional weapons and produce an airborne-directed energy weapon will provide the required precision and lethality needed to operate across the full spectrum of conflict. An interconnected, highly distributed infosphere that produces ultimate battlespace awareness will provide the C² reins to provide the conventional deterrence desired.

Conventional fuel sources can provide the desired platform performance between now and 2015, but continued research to provide cleaner fuel sources and improved fuel efficiencies is desirable. StrikeStar technology is a small hurdle—a challenge that can be overcome by funding and support from visionary leaders.

UAVs have a great potential for the strategic and operational commander in the pursuit of national interests. To optimize that potential, the apparent pro-pilot bias that favors manned aircraft over UAVs must be overcome. In addition, leaders must find ways to fund lethal UAV development and support the research and development of doctrine to support it. While doing so, leaders must also ensure that lethal UAVs and their concept of operations comply with the wishes of a public that demands safety and accountability.

Based on these conclusions, the following are recommended:

- Add a budget line in the FY00 POM, or sooner, that provides adequate funding for the ACTD. Based on the ACTD results be prepared to dedicate funding for lethal UAVs.

- Initiate an ACTD effort that picks up where the current DARO ACTDs end. The ACTD will focus on integrating components produced in the Miniaturized Munitions Technology Demonstration, LOCASS, and Pave Pace avionics architecture, with an enlarged variant of the DarkStar platform.

- Investigate a multimission modular payload configuration for UAV use that will allow a quick and economical reconfiguration from strike to reconnaissance missions.

- Continue work on an airborne laser, focusing on miniaturizing the weapon.

- Investigate possible TMD weapons for boost-phase intercept or attack operations for carriage on a long endurance stealthy UAV.

- Initiate a study to determine what doctrinal changes are needed to effectively employ StrikeStar across the conflict spectrum.

- Accelerate efforts to fuse all-source national and theater intelligence technologies .

- Initiate a study to determine how lethal UAVs can be integrated into force structure and the cost benefits of this concept versus alternatives.

- Continue strong support of a global information infrastructure that can provide secure, reliable communications.

The long-endurance multimission lethal UAV offers the war fighter of the Twenty-first century a capability to enforce the concept of “air occupation.” Applicable for use over a wide variety of scenarios and levels of warfare, the StrikeStar would be an affordable power projection tool that overcomes many of the political and social issues that will hinder force projection and force employment in the next century.

Notes

¹ Maj Gen John R. Landry, USA, Retired, National Intelligence Officer for General Purpose Forces, Central Intelligence Agency, address to the AF 2025 Study Group, Maxwell AFB, Ala., 14 February 1996.

Appendix A

Unmanned Aerial Vehicle Reliability

UAV reliability constantly comes up as a major factor when conducting cost performance trade-offs between manned and unmanned aircraft. The sporadic interest in UAVs has resulted in missing reliability data or insignificant data collections due to small UAV test sets, and various measurement techniques. The propensity to link payload performance to UAV platform reliability also led to misconceptions on overall reliability.

Table 4 shows the first data collected on the Air Force's first widespread use of UAVs during the Vietnam War and its aftermath.

Table 4

Ryan Model 147 UAV Flight Statistics

RYAN 147 Model	MIL Model	LT	SP	Mission	Date Opr	Number Launch	Percent Returned	Msn Per Uav
A		27	13	Fire Fly-first recce demo	4/62-8/62			
B		27	27	Lightning Bug First Big-Wing High Alt PhotoBird	8/64-12/65	78	61.5	8
C		27	15	Trng and Low Alt Tests	10/65			
D		27	15	Electronic Intelligence	8/65	2		
E		27	27	High Alt Elect Intel	10/65-2/66	4		
F		27	27	ECM	7/66			
G		29	27	Long body/larger engines	10/65-8/67	83	54.2	11
H	AQM-34M	30	32	High Alt Photo	3/67-7/71	138	63.8	13
J		29	27	First Low Alt Day Photo	3/66-11/77	94	64.9	9
N		23	13	Expendable Decoy	3/66-6/66	9	0	
NX		23	13	Decoy and Med Alt Day Photo	11/66-6/67	13	46.2	6
NP		28	15	Interim Low Alt Day Photo	6/67-9/67	19	63.2	5
NRE		28	13	First Night Photo	5/67-9/67	7	42.9	4
NQ		23	13	Low Alt Hand Controlled	5/68-12/68	66	86.4	20
*NA/NC	AQM-34G	26	15	Chaff and ECM	8/68-9/71			
NC	AQM-34H	26	15	Leaflet Drop	7/72-12/72	29	89.7	8
NC (m1)	AQM-34J	26	15	Day Photo / Training				
S/SA		29	13	Low Alt Day Photo	12/67-5/68	90	63.3	11
SB		29	13	Improved Low Alt Day Photo	3/68-1/69	159	76.1	14
SRE	AQM-34K	29	13	Night Photo	11/68-10/69	44	72.7	9
SC	AQM-34L	29	13	Low Alt Workhorse	1/69-6/73	1651	87.2	68
SC/TV	AQM-34L/TV	29	13	SC with Real-time TV	6/72-	121	93.4	42
SD	AQM-34M	29	13	Low Alt Photo/Real-time Data	6/74-4/75	183	97.3	39
SDL	AQM-34M(L)	29	13	Loran Navigation	8/72	121	90.9	36
SK		29	15	Operation From Carrier	11/69-6/70			
T	AQM-34P	30	32	High Alt Day Photo	4/69-9/70	28	78.6	
TE	AQM-34Q	30	32	High Alt Real-time COMINT	2/70-6/73	268	91.4	34
TF	AQM-34R	30	32	Improved Long-range	2/73-6/75	216	96.8	37
						3435		

Source: William Wagner, *Lightning Bugs and Other Reconnaissance Drones* (Fallbrook, Calif.: Aero Publishers, Inc., 1982).

The percent returned varied significantly from model to model. The fact these UAVs were flying in a war zone probably accounts for many of the losses, but the inability to recover downed UAVs prevented an exhaustive analysis. Using the AQM-34L as the largest statistical data set, it is easy to assert that the percent returned represents a reliability approximation that is good, but does not meet the reliability rates seen in manned aircraft.

Data on the Pioneer UAVs shows the accident rate is still higher than manned aircraft, but some improvement is noted since 1986 as the system matured (table 5).

Table 5

Pioneer UAV Flight Statistics

Year	# Mishaps	Flight Hours	Sorties	Percent Sorties Loss	Percent Sorties Accident
1986	5	96.3	94	2.1	5.3
1987	9	447.1	279	2.5	3.2
1988	24	1050.9	577	1	4.1
1989	21	1310.5	663	1.2	3.1
1990	21	1407.9	668	<1	3.1
1991	28	2156.6	845	1.3	3.3
1992	20	1179.3	676	1	2.9
1993	8	1275.6	703	1	1.1
1994	16	1568.0	862	1	1.8
1995	16	1752/0	692	4	2.3

Source: Cmdr Davison, US Navy's Airborne Reconnaissance Office, 15 March 1996.

Data on the Hunter UAV is shown in table 6. The percentage return rate was 99.7 percent when human error is excluded and only hardware/software causes are used. The data reflects results from both early technical and user testing as well as follow-on early training for the Hunter System. There were a total of 12 strikes (UAVs damaged such that they will never return to flight) out of the total 1,207 sorties flown. Human error was assessed as the primary cause for 66 percent (8) of the 12 strikes/losses. Hardware/software was assessed as the cause for the remaining 34 percent (4) strikes. Of the 12 losses, 66 percent (8) occurred during training flights while 34 percent (4) were lost during the early technical or demonstration tests.¹

Table 6

Early Hunter UAV Flight Statistics

Date of Operations	Number of Sorties	Percent Returned	Average Flight Duration
1/1/91-2/20/96	1207	99.0	2.97 flight hours

The latest Predator UAV data is shown in table 7. The Predator has been supporting reconnaissance missions in Bosnia and two UAVs have been lost: one to ground fire (Predator 8) and one to an engine malfunction (Predator 1). Used for training now, the GNAT-750 was originally developed for the Central Intelligence Agency and was also used in Bosnia.

Table 7

Predator UAV Flight Statistics

Model	Date OPR	Total Flights	Total Flight Hours	Bosnia Flights	Bosnia Flight Hrs	Percent Returned
GNAT-750	9/94 - 2/96	73	161			100
Predator 1	6/94 - 8/95	74	328	10	60	94
Predator 2	9/94 - 8/95	87	452	23	145	100
Predator 3	11/94 - 10/95	50	205	29	128	100
Predator 4	9/95 - 2/96	47	132			100
Predator 5	2/95 - 11/95	99	301			100
Predator 6	3/95 - 2/96	28	90			100
Predator 7	5/95 - 2/96	18	42			100
Predator 8	7/95 - 8/95	11	41	4	20	92
Predator 9	8/95 - 2/96	74	476	49	371	100
Predator 10	8/95 - 10/95	19	147	15	127	100
		580	2375	140	851	

Source: Manny Garrido, Director of Advanced Airborne Systems, Battlespace Inc., Arlington, Va., 22 February 1996.

¹ Mr Bill Parr, US Army Joint UAV Office, Redstone Arsenal, Ala., provided the Hunter data and crash data on 2 April 1996.

Appendix B

Worldwide Unmanned Aerial Vehicles

Steven J. Zaloga's article "Unmanned Aerial Vehicles" in the 8 January 1996 issue of Aviation Week and Space Technology provides a comprehensive listing of ongoing efforts in UAV production (table 8). Thirty-four companies, including 16 US companies, are represented here. Nine countries besides the United States are involved in UAV design and production. Included in this group are many peer competitors or nations involved in arms exports.

Table 8

Worldwide UAV Systems

Manufacturer	Type	Mission	Weight	Payload	Speed	Endurance	Max. Alt
AAI,							
Hunt Valley, MD, USA	Shadow 200	Multimission	250	Various	100+	3+ hr.	15,000
	Shadow 600	Multimission	600	Various	100+	12+ hr.	17,000
Adv Tech & Engr Co.							
(Pty) Ltd., South Africa	UAOS	Multimission	275	Optronic Day Sight	100	3 hr.	16,400
Aero Tech							
of Australia Pty, Ltd.	Jindivik Mk. 4A	Target	4,000	—	M 0.86	115 min.	—
Aerovironment Inc.							
Simi Valley, CA, USA	C. 22	Target	1,210	Radio cmd (R/c)	M 0.95	2.5 hr.	—
	HILINE	HALE Recce	770	Autop. datalink, nav. computer	120	1-2 days	40,000
	Pathfinder	HALE Recce	480	Comm. relay, environ. sensing	—	—	75,000
	Pointer	Multipurpose/Recce	8 lb.	R/c	25-50	2 hr.	2,000
	SASS-LITE	Multimission	800 lb.	Autop.	27	4 hr.	5,000

Manufacturer	Type	Mission	Weight	Payload	Speed	Endurance	Max. Alt
Aurora Flight Systems							
Manassas, VA, USA	Chiron	Marine Science	4,630	Scientific	100	24 hr.	10,560
	Perseus A	Atmo. Science	1,750	Atmospheric sampling	80	5 hr.	74,000
	Perseus B	Atmo. Science	2,500	Atmospheric sampling	80	36 hr.	63,000
	Theseus	Atmo. Science	8,800	Scientific	50	48 hr.	90,000
CAC Systems							
Vendôme, France	ECLIPSE T1	Target	300	IR & RF equip.	M 2.5	ballistic	42,000
	ECLIPSE T2	Target	450	IR & RF equip.	M 4.3	ballistic	70 mi.
	FOX AT1/AT2	Recce/surv.	160/250	R/c, program., track.	160	22 hr./5hr.	10,500
	FOX TS1	Target	160	Autop., GPS	190	1 hr.	10,500
	FOX TS3	Target	240	Autop., Nav., GPS	280	1 hr.	15,800
	FOX TX	Electronic warfare	250	Autop., Nav., GPS	160	5 hr.	10,500
Canadair, Bombardier Inc.							
Montreal, Quebec, Canada	AN/USD-501	Surv./target acq.	238	Programmed	460	75 nm.	—
	AN/USD-502	Surv./target acq.	—	Programmable	—	—	—
	AN/USD-502	Surv./target acq.	—	Programmed	—	—	—
	CL-227	Surv./target acq.	502	R/c, prog.	92	4 hr.	—
	CL 289	Recce and surv. target acquisition	529	Optical camera,	460	1,242 mi.	1,970
Daimler-Benz Aerospace							
Dornier, Germany	DAR	Antiradar	264.5	Pass. radar seeker	155	3 hr.	9,840
	Seamos	Maritime surv.	2,337	Radar, EO	103	4.5 hr.	13,125
	SIVA	Recce, surv., target acq.	441	Flir, CCD, TV	92	8 hr.	8,200
Flight Refueling Ltd.							
Winborne, Dorset, UK	Raven	Surv./Recce	185	Video, Flir	75	3 hr.+.	14,000
Freewing Aerial Robotics							
College Park, MD, USA	Scorpion 60	Multipurpose	110	Various 25 lb.	100	3-4 hr.	5,000
	Scorpion 100	Multipurpose	320	Flir, EO, 50 lb.	172	4 hr.	15,000
General Atomics							
San Diego, CA, USA	BQM-34A	Target	2,500	R/c	690	692 nm.	—
	J/AMQ-2	Target	519	R/c	M 0.9	15.6 min	—
	Altus	High alt. research	1,600	—	130	48 hr.	50,000
	GNAT 750	Recce/surv./target	1,126	Day TV, Flir	150 kt.	40 hr.	25,000
	I-GNAT	Recce/surv./target	1,140	Day TV, Flir	175 kt.	60 hr.	32,000
	Predator	Recce/surv./target	2,085	Day TV Flir, SAR	120 kt.	60 hr.	25,000
	Prowler-CR	Recce/surv./target	200	Day TV, Flir	160 kt.	8 hr.+	20,000
Honeywell, Defense							
Avionics Systems Div	QF-104J	Target	23,690	—	M2.2	—	—
Albuquerque, NM, USA	QF-106	Target	35,411	—	M2.2	—	—
	QR-55	Target	7,000	—	133	—	—
Israel Aircraft Industries,							
Malat Div. Tel Aviv, Israel	Eyeview	Recce, surv., & target acq.	174	Varies	120 kt.	4-6 hr.	10,000
	Helistar	OTH target acq., Recce, & surv.	2,450	computer	100 kt.	4.5 hr.	—
	Heron	Multipurpose	2,400	—	125	52 hr.	32,000
	Hunter	Recce/surv.	1,600	—	110	12 hr.	15,000
	Pioneer	Recce/surv.	430	Computer	90 kt.	6.5 hr.	—
	Searcher	Recce/surv.	700	Computer	110 kt.	24 hr.	—

Manufacturer	Type	Mission	Weight	Payload	Speed	Endurance	Max. Alt
Kaman Aerospace Int. Corp.							
Bloomfield, CT, USA	QUH-1B,C,E,M	Target	9,500	Radar command	126	155 min.	—
				Digital control			
Kamov Design Bureau							
Moscow, Russian Fdr	Ka-37	Recce, comm.	550	Preprog or r/c	59 kt.	4.5 min.	5,200
Lear Astronautics Corp.							
Santa Monica, CA, USA	Skyeye R4E-50	Multipurpose	780	125	8+ hr.	15,000+	—
Lockheed Martin Skunk							
Works Palmdale, CA, USA	Dark Star	Acq./Recce/surv.	8,600	SAR	288+	8+ hr.	45,000+
Lockheed Martin							
Electronics & Missiles	AQM-127A	Target, SLAT	2,400	Inertial, radar	M 2.5	55 nm.	—
Orlando, FL, USA		(Super Sonic Low)					
Meteor Acft & Electronics							
Rome, Italy	Mirach 20	Surv./target/acq.	374	R/c, prog.	120	240+	—
	Mirach 26	Surv./target/acq.	440	R/c, prog.	135	420+	—
	Mirach-70	Target	525	R/c	195	60	—
	Mirach-100/4	Target	594	R/c, prog.	M 0.8	60	—
	Mirach-150	Recce	748	R/c, prog.	M 0.7	80	—
Mission Technologies							
Hondo, TS, USA	Hellfox	Multimission	240	Flir, TV, other	80 kt.	4 hr.	15,000+
Northrop Grumman Corp.							
Los Angeles, CA, USA	BQM-74E	Target	595	R/c	530 kt.	—	—
People's Rep of China							
	B-2	Target	123.5	R/c	149	1 hr.	—
	Changkong IC	Target	5,401	R/c	565	45 min.	—
	D-4	Target	308	R/c	106	2.6 hr.	—
Raytheon Acft Co., (Beech)							
Wichita, KS, USA	AQM-37	Target Variant	620	Radio cmd./prog.	M 4.0	120 nm.	—
	AQM-37A	Target	560	Programmed	M 0.7-2	120 nm.	—
	AQM-37C	Target	581	Radio cmd./prog.	M 1.0-3	120 nm.	—
	AQM-37EP	Target	600	Radio cmd	M 3.0-4	120 nm.	—
				preprog. autopilot			
	MQM-107B/D	Target	977/1012	Radio cmd./prog.	M 0.80	90m/100m	—
	MQM-107D	Target	977/1012	Radio cmd./prog.	M 0.80	100 min.	—
	Upgrade						
	MQM-107E	Target	977/1012	Radio cmd./prog.	M 0.85	100 min.	—
SAGEM							
Paris, France	Crecerelle	Recce/surv./target	265	Flir, EW	155	5 hr.	15,000
	Marula	Recce/surv./target	165	Flir, EW	155	5 hr.	15,000
Scaled Composites							
Mojave, CA, USA	Raptor 2	Environ. research	2000	Environ. sensors	92	10 hr.	65,000
Sikorsky							
Stratford, CT, USA	Cypher	Recce	250	EO, Flir, etc.	60	3 hr./2,500	7,900
Silver Arrow							
Rishon-Lezion, Israel	Colibri	Pilot training	50	—	31-100	2 hr.	10,000
	Hermes 450	Multipurpose	1000	Various up to 350 lb.	57-115	25 hr.	23,000
	Micro-Vee	Tactical UAV	100	Video camera	50-126	5 hr.	15,000
STN Atlas Elektronik							
Bremen, Germany	Brevel	Recce/surv./target	330	Thermal Imaging	136	5.5 hr.	11,500
				camera			
	Luna	Optical Recce	44	TV, Flir	124	2 hr.	3,300
	Tucan-95	Recce/surv./target	330	TV, Flir	155	10 hr.	13,100

Manufacturer	Type	Mission	Weight	Payload	Speed	Endurance	Max. Alt
Strela Production Assn.							
Orenberg, Russian Fed	La-17MM	Target	5,070	Transponder	560	1 hr.	—
	La-17R	Recce	6,835	Camera	560	1 hr.	—
	Dan	Target	760	Transponder	440	40 min.	—
Tadiran Israel Electronic Industries Ltd., Israel	Mastiff Mk. 3	Recce/surv. & target acq.	254	R/c; prog.	100	7+ hr.	—
Target Technology Brux, France & Ashford, UK	Banshee 1	—	190	Flares	54-200	1.5 hr.	23,000
	Banshee 2	—	190	Flares	57-236	1.5 hr.	23,000
	IMP	Operator Training	—	—	15-90	0.5 hr.	—
	Petrel	Ballistic Target	—	—	M 3.0	104 mi.	—
	Snipe Mk 5	Aerial Target	145	Flares	180	1.2 hr.	18,000
	Snipe Mk 15	Aerial Target	—	Flares	130	0.5 hr.	5,000
	Spectre	Surveillance, EW	—	CCD camera	77-150	3-6 hr.	23,000
Teledyne Ryan Aero. San Diego, CA, USA	324	Recce	2,374	Program command	M 0.80	1,400 nm.	—
	Teledyne 410	Recce/surv.	1,800	Program command	169 kt.	14 hr@10K	—
	BQM-34A	Target	2,500	RPV Trk Cntrl Sys.	M 0.97	692 nm.	—
	BQM-34S	Target	2,500	Integ. Trk Cntrl Sys.	M 0.97	692 nm.	—
	MQM-34D	Target	2,500	DTCS	M 0.97	692 nm.	—
	BQM-145A	Recce	2,000	Programmable	M 0.91	700 nm.	—
	Tier 2+	Recce	24,000	—	395	42hr	67,300
	YBQM-145A	Recce	2,000	Program command	M 0.91	700 nm.	—
Tupolev Design Bureau Moscow Russian Fed	DBR-1 Jastreb	Recce	84,875	Camera or Elint	1,740	1.5 hr.	—
	VR-2 Strizh	Recce	15,400	Camera	685	1 hr.	—
	VR-3 Reys-D	Recce	3,110	Camera or TV	595	15 min.	—
Westinghouse Electronic Huntsville, AL, USA	Star-Bird	Recce, surv., C101& target acq.	280	Flir, TV	—	6.5 hr.	—
Yakovlev Design Bureau Moscow Russian Fed	Shmel	Surv., EW	286	R/c uplink	97 kt	2 hr.	9,850
	Yak-060	Recce, EW	225	TV or EW jammer	110	2 hr.	—
	Yak-061	Recce	285	TV	110	2 hr.	—

Source: Tim H. Storey, Director of Operations, Teal Group Corporation, Fairfax Va.

Appendix C

Contributors

Lt Col (Colonel select) Bruce W. Carmichael is a command pilot with more than 4,300 flying hours in T-37, T-38, B-52, and U-2 aircraft. He has a Bachelor of Arts degree in government from Colby College and a Masters in Public Administration degree from Golden Gate University. He is a distinguished graduate of Squadron Officer School and received a National Defense University award as a student at Armed Forces Staff College. Lieutenant Colonel Carmichael is a 1996 graduate of the Air War College. He has commanded the 99th Reconnaissance Squadron (U-2 aircraft) and served on the staff of the United States Pacific Command and on the staff of the Office of the Secretary of Defense in the Defense Airborne Reconnaissance Office.

Maj Troy E. DeVine is a senior pilot with more than 3,000 flying hours in the T-37, T-38, and U-2. She is a United States Air Force Academy graduate with a Bachelor of Science degree in engineering mechanics. Major DeVine is a distinguished graduate of Squadron Officer School and is a 1996 graduate of Air Command and Staff College. She has served as the director of combat operations in the 99th Reconnaissance Squadron (U-2 aircraft) and will be attending the School of Advanced Air Power Studies next year.

Maj Robert J. Kaufman. Major Kaufman received his USAF commission through ROTC upon graduating Clemson University in 1982 with a degree in electrical engineering. He received a Master of Systems Analysis degree from University of West Florida in 1984 and completed postgraduate work in electrical engineering in 1992 at University of Colorado at Colorado Springs. He has served in a variety of positions to include: electronics engineer and program manager at the USAF Armament Laboratory, section chief and commander of an operational test and evaluation detachment, and USAF Academy instructor and coach. Prior to attending ACSC, he served a tour at Headquarters USAFE where he was a branch chief in the MAJCOM's Computer Systems Field Operating Agency and executive officer for the Directorate of Command, Control, Communications, and Computers. Upon graduating from ACSC, he will be assigned as commander, 509th Communications Squadron, Whiteman AFB, Missouri.

Maj Patrick E. Pence. Major Pence graduated from the United States Air Force Academy in 1983 with a degree in electrical engineering. He also holds a Master in systems management degree (1988) from Troy State University in Alabama. After attending pilot training at Laughlin AFB, Texas, Major Pence completed initial F-4 training at Homestead AFB, Florida, and flew the F-4E operationally at Taegu AB, Korea, and Moody AFB, Georgia. After Wild Weasel training at George AFB, California, in 1988, Major Pence flew the F-4G operationally at Clark AB, Philippines; Spangdahlem AB, Germany; and Nellis AFB, Nevada. He flew 37 combat missions in Operation Desert Storm and has flown 118 combat missions in support of Operations Southern Watch, Provide Comfort, and Vigilant Warrior no-fly zones. During this time he served as chief of scheduling and flight commander 81st Fighter Squadron, and as chief of weapons and flight commander 561st Fighter Squadron.

Maj Richard S. Wilcox Major Wilcox earned a Bachelor of Science in computer information systems from Arizona State University in 1983. He is a senior pilot with more than 1,500 hours of fighter time in F-111A, D, E, and F aircraft. Major Wilcox is a distinguished graduate from Air Force ROTC, undergraduate navigator training, undergraduate pilot training, and Squadron Officers School. His assignments have included mission-ready flying duties at Royal Air Force Upper Heyford, United Kingdom and Cannon Air Force Base, New Mexico, where he held every qualification available to an F-111 pilot. As a member of Cannon's 524th Fighter Squadron, Major Wilcox flew 19 combat sorties in support of Operation Provide Comfort II. His last assignment was advisor to the 27th Operations group commander in development of Quality Air Force initiatives for six fighter squadrons and two base-hosted detachments.

Bibliography

Books and Published Sources

- Builder, Carl H. *The Icarus Syndrome*. New Brunswick, N.J.: Transaction Publishers, 1994.
- Cameron, K. *Unmanned Aerial Vehicle Technology*. Melbourne, Australia: Defense Science and Technology Organization, February 1995.
- Casagrande, E. E. *Non-lethal Weapons: Implications for the RAAF*. RAAF Base Fairbarin, Australia: Air Power Studies Center, November 1995.
- Clausewitz, Carl von, *On war*. Edited and translated by Michael E. Howard and Peter Paret. Princeton, N.J.: Princeton University Press, 1984.
- Cookerly, David H. *Unmanned Vehicles to Support the Tactical War*. Maxwell AFB, Ala: Air University Press, May 1988.
- Crickmore, Paul F. *Lockheed SR-71 - The Secret Missions Exposed*. London: Osprey Aerospace, 1993.
- Gorn, Michael H., Dr *Prophecy Fulfilled: "Toward New Horizons" and Its Legacy*. Air Force History and Museums Program, 1994.
- Hallion, Richard P. *Storm over Iraq Air Power and the Gulf War*. Smithsonian Institution Press Washington & London 1992.
- Holley, I. B., Jr., *Ideas and Weapons*. Washington, D.C.: Yale University Press, 1953.
- Hurst, G.R. *Taking Down Telecommunications*. Maxwell AFB, Ala.: Air University Press, September 1994.
- Janes Unmanned Aerial Vehicles, Launchers and Control Systems, 1994*. Surrey, UK: Janes Information Group Limited.
- Keaney, Thomas A. and Cohen, Eliot A. *Gulf War Air Power Survey Summary Report*. Washington, DC, 1993.
- Kuperman, Gilbert G. *Information Requirements Analyses for Transatmospheric Vehicles*. Wright Patterson AFB, OH: Air Force Material Command, June 1992, AL-TR-1992-0082.
- Longino, Dana A. *Role of Unmanned Aerial Vehicles in Future Armed Conflict Scenarios*. Maxwell AFB, Ala.: Air University Press, December 1994.
- Mantz, Lt Col Michael R. *The New Sword a Theory of Space Combat Power*. Maxwell AFB, Ala.: Air University Press, 1995.
- Marshall, James P. *Near-Real-Time Intelligence on the Tactical Battlefield*. Maxwell AFB, Ala.: Air University Press, January 1994.
- McKittrick, Jeffrey, et al. "The Revolution in Military Affairs," in Barry R. Schnieder and Lawrence E. Grinter, eds., *Battlefield of the Future: 21st Century Warfare Issues*. Maxwell AFB, Ala.: Air University Press, September 1995.
- McPeak, Gen Merrill A. *Selected Works 1990-1994*. Maxwell AFB, Ala: Air University Press, August 1995.

- Meilinger, Col Phillip S. *10 Propositions Regarding Air Power*. Maxwell AFB, Ala: Air Force History and Museums Program, 1995.
- Miller, Jay. *Lockheed's Skunk Works: The First Fifty Years*. Arlington, Tex: Aerofax, Inc., 1993.
- Rich, Ben R. *Skunk Works*. New York: Little, Brown and Company, 1994.
- Senate, Hearings before the Subcommittee on Aerospace Technology and National Needs of the Committee on Aeronautical and Space Sciences, 94th Congress, 2nd sess., September 27-28, 1976.
- USAF Scientific Advisory Board. *New World Vistas: Air and Space Power for the 21st Century*, Summary Volume. Washington, D.C.: USAF Scientific Advisory Board, 15 December 1995.
- Wagner, William. *Lightning Bugs and Other Reconnaissance Drones*. Fallbrook, Calif: Aero Publishers, Inc., 1982.

Articles

- "Energetic Materials Branch/High Explosives Research and Development Facility Home Page." Eglin AFB, FL, January 1995.
- "International Market Eyes Endurance UAVs." *Aviation Week and Space Technology*, July 10, 1995.
- "Miniaturized Munitions Technology Demonstration Abstract." Eglin AFB, Fla., January 1995.
- "Optical Space Communications Cross Links Connect Satellites." *Signal*, April 1994.
- "Predator, DarkStar and other cult classics." *The Economist*, 17 June 1995.
- "Smart Bombs get their Ph.D." CNN Interactive Technology, Internet, 1 February 1996.
- "Unmanned Aerial Vehicles." *Armada International*, 1990, *Naval Technical Intelligence Translation 910098*, DTIC Report AD - B153696, 10 April 1991.
- "A New Defense Industrial Strategy." *Air Power Journal*, Fall 1993.
- Ackerman, Robert K. "Tactical Goals Encompass Sensors, Autonomous Arts." *Signal*, December 1995.
- Air Progress*, September 1995.
- Boatman, John. "Highly Energetic Bomb Studies." *Jane's Defense Weekly*, March 1995.
- Busey, Adm James B. IV. "MILSTAR Offers Tactical Information Dominance." *Signal*, July 1994.
- Chapman, Suzann. "The Airborne Laser." *Air Force Magazine*, January 1996.
- Correll, John T. "Deep Strike." *Air Force Magazine*, April 1996.
- Defense Daily*, 2 February 96.
- Fitzsimonds, James R. and Vantol, Jan M. "Revolution in Military Affairs." *Joint Force Quarterly*, Spring 1994.
- Fulghum, David A. "DarkStar First Flight Possible in March." *Aviation Week and Space Technology*, 19 February 1996.
- Fulghum, David A. "International Market Eyes Endurance UAVs." *Aviation Week and Space Technology*, 10 July 1995.
- Fulghum, David A. "New Priorities Refocus Ballistic Missile Defense." *Aviation Week and Space Technology*, 19 February 1996.
- Fulghum, David A. "McDonnell Douglas JAST Features Expanding Bays." *Aviation Week and Space Technology*, 19 February 1996.
- Green, Brian, "McCain's Rising Star." *Air Force Magazine*, April 1996.
- Krepinevich, Andrew F., Jr. "The Military Technical Revolution: A Preliminary Assessment." Maxwell AFB, Ala., Air Command and Staff College, War Theory Course Book, Volume 3, September 1995.

Lasswell, James A. "Presence-Do We Stay or Do We Go?" *Joint Forces Quarterly*, Summary 1995.

Markov, David R. "The Aviation Market Goes Global." *Air Force Magazine*, June 1995.

Murdock, Clark A. "Mission-Pull and Long-Range Planning." *Joint Forces Quarterly*, Autumn/Winter 94-95.

Schnieder, Maj David W. "Heavy Bombers Holding the Line." *Air Power Journal*, Winter 1994.

Tirpak, John A. "The Long Reach of Air Combat Command." *Air Force Magazine*, January 1996.

Zaloga, Steven J. "Unmanned Aerial Vehicles." *Aviation Week and Space Technology*, 8 January 1996.

Lectures

"Surveillance and Reconnaissance, Real - Time Integration." 2025 concept briefing, Maxwell Air Force Base, Ala., 19 January 1996.

Boyd, John R. "The Essence of Winning and Losing." Presentation to the AF 2025 Study Group, Maxwell Air Force Base, Ala., October 1995.

Fogleman, Gen Ronald R. Chief of Staff, United States Air Force, address to the AF 2025 Study Group, Maxwell AFB, Ala., 13 February 1996.

McCall, Gene H. Chairman USAF Scientific Advisory Board, presentation to the AF 2025 Study Group, Maxwell Air Force Base, Ala., 6 September 1995.

Owens, Adm William A. Vice Chairman, Joint Chiefs of Staff, address to the AF 2025 Study Group, Maxwell Air Force Base, Ala., 13 August 1995.

Warden, Col John A. III. "Air Occupation." Video address to Air Command and Staff College, Maxwell Air Force Base, Ala., January 96.

Warden, Col John A. III. Address to Air Command and Staff College, Maxwell Air Force Base, Ala., October 1995.

Regulations, Manuals, Pamphlets

AFM 1-1, *Basic Aerospace Doctrine of the United States Air Force*. 2 Vols., March 1992.

Defense Airborne Reconnaissance Office, *Airborne Reconnaissance Technology Program Plan - Executive Summary*. Washington, D.C., February 1995.

Defense Airborne Reconnaissance Office. *Unmanned Aerial Vehicles Annual Report*. Washington, D.C., August 1995.

Joint War fighting Center, *War fighting Vision 2010: A Framework for Change*, 1 August 1995.

The Joint Chiefs of Staff, *C4I for the Warrior*, Washington, D.C., 12 June 1992.

The Joint Chiefs of Staff, *Joint Vision 2010*. Washington, D.C., 1995.

The Department of the Army, *Army Focus 1994: Force XXI*. Washington, D.C., September 1994.

The Joint Chiefs of Staff, Joint Publication 3-0 *Doctrine for Joint Operations*, 1 February 1995.

Unpublished Sources

"Tier III- DarkStar First Flight Video," *Lockheed-Martin Skunkworks*, 29 March 1996.

ARPA Technical Abstract, Internet Home Page, December 1995.

Buchanan, Col Walter. "National Military Command Center." Unpublished briefing slides, presentation to Air Command and Staff College, 27 February 1996.

- Chapman, Aubrey I. *Remotely Piloted Vehicle Technology*. Radar Guidance Inc., San Antonio, Tex., 17 April 1989, DTIC AD-B131985.
- Cooper, Jeffrey. "Another View of Information Warfare: Conflict in the Information Age." SAIC, Publication Draft for 2025 Study Group.
- Fogleman, Gen Ronald R. Chief of Staff, United States Air Force, Speech to the Air Force Association, Orlando, Fla., 24 February 95.
- Fort Bliss Threat Office. "Air and Missile Threat to the Force." Air and Missile Threat Briefing, 1996.
- Harshman, William R. "Army UAV Requirements and the Joint UAV Program." Unpublished thesis. Fort Leavenworth, Kans.: US Army Command and General Staff College Thesis, June 1990.
- Jones, Col William. "JROC and the Joint War fighting Capabilities Assessment Process." Unpublished briefing slides, presentation to Air Command and Staff College, 12 February 1996.
- JPSD Program Office. *Joint Precision Strike Demonstration (JPSD) Beyond Line of Sight UAV Demonstration*, March 1994
- Lawrence Livermore National Laboratory Technical Abstract. *Solar-Electric Aircraft*. Internet Home Page, January 1996.

Space Operations: Through The Looking Glass (Global Area Strike System)



A Research Paper
Presented To

Air Force *2025*

by

Lt Col Jamie G. G. Varni
Mr. Gregory M. Powers
Maj Dan S. Crawford
Maj Craig E. Jordan
Maj Douglas L. Kendall

August 1996

Disclaimer

2025 is a study designed to comply with a directive from the chief of staff of the Air Force to examine the concepts, capabilities, and technologies the United States will require to remain the dominant air and space force in the future. Presented on 17 June 1996, this report was produced in the Department of Defense school environment of academic freedom and in the interest of advancing concepts related to national defense. The views expressed in this report are those of the authors and do not reflect the official policy or position of the United States Air Force, Department of Defense, or the United States government.

This report contains fictional representations of future situations/scenarios. Any similarities to real people or events, other than those specifically cited, are unintentional and are for purposes of illustration only.

This publication has been reviewed by security and policy review authorities, is unclassified, and is cleared for public release.

Contents

<i>Chapter</i>	<i>Page</i>
Disclaimer	ii
Illustrations.....	v
Tables.....	vi
Executive Summary	vii
1 The World of 2025.....	1
The Space Operations Mission	2
The Topic of Discussion.....	3
Issues Involving Space Operations in 2025	4
Manned Versus Unmanned Systems	4
Large Versus Small Satellites	5
Ground Versus “Anywhere” Processing and Delayed Versus Near Real-Time Information	5
Military Versus Cooperative/Commercial Endeavors	6
2 Required Capability.....	8
Timeliness	8
Responsiveness.....	9
Flexibility	10
Survivability and Reliability	10
Precision and Selective Lethality.....	11
3 The Integrated System-of-Systems	13
Weapon Platforms.....	14
Weapon Classes.....	16
Directed-Energy Weapons—Incoherent Light.....	16
Capabilities.....	17
Countermeasures	18
Evaluation	18
DEW—Coherent Light (Lasers).....	18
Capabilities.....	20
Countermeasures	24
Evaluation	24
Neutral Particle Beam.....	25
Capabilities.....	26
Countermeasures	27
Evaluation	27
Electromagnetic Pulse.....	27
Capabilities.....	28
Countermeasures	30
Evaluation	30

<i>Chapter</i>	<i>Page</i>
High-Power Microwave	31
Capabilities.....	32
Countermeasures	33
Evaluation	33
Illusion.....	34
Capabilities.....	34
Countermeasures	34
Evaluation	35
Projectile Weapons.....	35
Projectile Weapons—Ballistic Missiles	35
Capabilities.....	36
Countermeasures	37
Evaluation	37
Projectile Weapons—Kinetic Energy	37
Capabilities.....	39
Countermeasures	40
Evaluation	40
Space Sortie—Transatmospheric Vehicle	40
Capabilities.....	43
Countermeasures	46
Evaluation	47
Summary —The System-of-Systems	47
Capabilities.....	50
Countermeasures	51
4 Concept of Operations	59
5 Investigation Recommendations	68
Directed-Energy Weapons	69
Projectile Weapons.....	69
Space Sortie.....	70
General Considerations	70

<i>Appendix</i>	<i>Page</i>
A Global Presence	72
Some Important Definitions	73
B The System of Systems	75
SAT/BDA.....	75
Surveillance	77
Acquisition and Targeting	77
Battle Damage Assessment	79
Utilities	79
Communications.....	80
Navigation.....	81
Weather.....	82
Bibliography	84

Illustrations

<i>Figure</i>	<i>Page</i>
1-1. The View from Space.....	4
3-1. A Notional Space-Based Laser	19
3-2. Precision Laser Strike on Aircraft.....	22
3-3. The TAV in its Native Environment	41
3-4. Pop-Up Maneuver.....	45
3-5. Pop-Up Enables Flexible Transpace Operations.....	46
4-1. TAV Employing Kinetic-Energy Weapons	61
4-2. Notional Space-Based Mirror Deployment Using Inflatable Mirror Technology	62
4-3. The Crowded “Skies” of 2025	65
4-4. A TAV in <i>Space-strike</i> Mode.....	66
A-1. Space Operations Missions	73
B-2. Battlespace Awareness.....	76

Tables

<i>Table</i>		<i>Page</i>
1	Summary Evaluation of Potential Weapon Systems	48

Executive Summary

America's capability to operate in space is increasing with every passing day. Space operations are already recognized as a crucial part of all American military operations. Military space operations may be indirect, through such staples as navigation, communications, and surveillance/reconnaissance support to the war fighter, or direct, through development and fielding of a range of responsive directed energy and kinetic energy weapons. A modest fleet of flexible, mission-tailored transatmospheric vehicles (TAVs) has an important place in any thoughtful space operations architecture, providing the only conceivable way to insert human presence rapidly into the fast-breaking crises of 2025. Space represents the future—a future in which aerospace power will increasingly be projected through space systems.

This paper advocates a “system-of-systems” architecture for an American global space-strike capability in 2025. This architecture recognizes the importance of the global information network (surveillance and reconnaissance combined with the intelligence system), the military command and control system, the perennial space “utilities” (communications, navigation, and weather), and a robust readiness and sustainment system to enable the fielding of space-based or space-borne weapon systems. The weapon system itself is described as a smaller system-of-systems composed of the weapon, its platform, and a primarily off-board surveillance, acquisition, and tracking/battle damage assessment capability provided through the global information network.

After a review of the alternatives for a global space-strike system in 2025, the optimum solution appears to be combining a prompt response capability with a complementary flexible response capability. The prompt response capability is best provided by a system of Continental United States(CONUS)-based laser devices that bounce high power directed energy beams off a constellation of space-based mirrors. Inherently precise, megawatt-class, light-speed weapons can potentially act within seconds or minutes to resolve the rapidly developing crises of 2025. Flexible response is best provided with a small CONUS-based fleet of TAVs equipped with a variety of payloads, including kinetic-energy weapons, compact laser

weapons, and special forces squads. Responding within a few hours of notification, a TAV can precisely deliver force and/or adaptable human judgment to crisis locations anywhere on earth.

The balance of influence in the information technologies has shifted from the Department of Defense to commercial organizations. This trend will continue and accelerate between now and 2025. The crucial importance of detailed, timely knowledge and rapid, ultrawideband communications to military space operations will demand the extensive use of commercial (possibly international) space systems and technologies. The world of 2025 will see a crowded “sky” filled with space systems shared by military and government organizations on the one hand and commercial concerns on the other.

Chapter 1

The World of 2025

Once again a small but capably armed country is threatening to seize its smaller but resource-rich neighbor. The Global News Network reports that the border has been violated. The same old story? No, the plot twists as a sophisticated satellite surveillance and reconnaissance system tracks the belligerent nation's leader. As he steps to the podium to incite his troops to greater violence, a blinding light from above vaporizes him and his podium leaving even his bodyguards untouched. His smarter brother, the second in command, countermands the invasion orders and in 12 hours the borders are restored. Stability, if not peace, reigns again.

This is not science fiction, but a mission well within the capabilities of Space Operations in **2025**. By that year space operations will become the key to a wide range of military missions. Current US military space systems are an important force multiplier, but they do “not yet provide the seamless, reliable, rapidly delivered information needed by the modern war fighter.”¹ To resolve this deficiency, space system designers must make a clean break with the expensive, large-scale, hand-built designs of 1996 and move to a new approach that emphasizes economy, efficiency, and operational utility in dynamic balance with rapidly evolving technological developments.

This paper highlights the importance of the full range of space operations while emphasizing the point that, in 2025, the United States must have a global space-strike capability. Why is this capability essential for military operations in 2025? All nations are becoming highly dependent on space assets for communications, weather forecasting, navigation and positioning, and surveillance and reconnaissance, and this dependency is growing at an exponential rate. To preserve the ability to use space and to deny space to aggressors, the US

must have control of space. This need to control space will quickly overcome the political will to oppose weapons in space. Once this line is crossed—and its crossing is inevitable—we must be equipped to make use of space in a variety of novel ways.

The rapidly accelerating rate of technological change virtually assures that, by 2025, even the poorest nations will have access to electronic information and decision-making aids only dreamed of today. The average time required to complete an Observation, Orientation, Decision, and Action (OODA) loop will be much shorter in 2025². In such a world, the US must be able to take rapid action (measured in minutes or perhaps even seconds) to resolve conflict situations before they can grow out of control. The essential capabilities of timeliness or responsiveness can certainly be provided by a properly designed space-strike system and perhaps only by such a space-strike system.

Because the world of 2025 will provide smaller countries and organizations with far greater abilities to disrupt our nation and its allies, we will need measures flexible enough to produce effects across the full range of the “spectrum of force,” ranging from the nonlethal (deceit, delay) to the lethal (damage, destruction). The requirement to produce the right effect on the right target at the right time is as desirable in a space-strike system as it is in today’s more familiar combat systems.

The Space Operations Mission

The heart of the space operations mission is the *global presence* concept as encapsulated in the following summary from the Department of the Air Force Global Presence 1995 document:

“As we peer into the future, we should view *Global Presence* as one route the Services can take to achieve our country’s ever evolving national security objectives. We in the military possess the means, physical and virtual, to provide America continuous awareness of world events and a force capable of projecting military power worldwide, in minutes or hours, with little or no warning.”³

While the notion of global presence is a concept of 1996, its principle will remain a constant for decades to come. The name may change, but the mission will remain crucial as long as the United States wished to remain a world power. Much of America’s global presence already depends on the world’s highest technology systems operating freely from “the high ground of space.” The only essential element missing in 1996 is a force projection capability operating through the space environment. (see appendix A).

In the fast-paced world of 2025, the volume of space near earth (at and below geosynchronous orbit) will be filled with the space assets of many, if not all, nations. The commercial, civil, and military possibilities inherent in the high ground of space will be fully exploited. These future space systems will be distributed and interconnected in ways we can only dimly imagine today. It may even be impossible to point at any single piece of space hardware and say “this belongs to the United States.” Instead, a nation and nongovernmental organizations (NGOs) may use various parts of various space assets at different points in time.

The Topic of Discussion

The military’s space support and space-control missions in 2025 are described in other AF *2025* white papers. The force enhancement mission is addressed from several points of view in other white papers involving surveillance and reconnaissance and information operations.⁴ This paper will concentrate primarily on the space force application mission and those elements of force enhancement which relate directly to the military application of force through the medium of space.

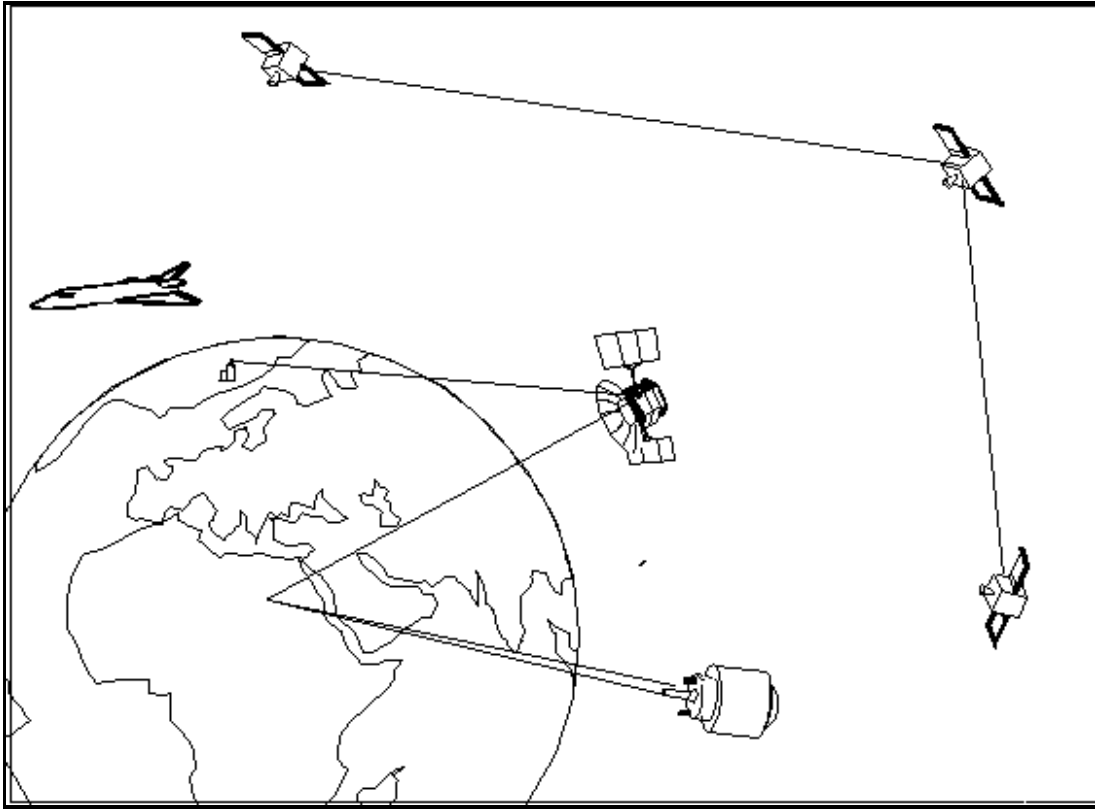

Figure 1-1. The View from Space

Issues Involving Space Operations in 2025

Several trends are already evident in the world of 1996 that will fundamentally influence all future operations in space. Although the precise impact of these trends cannot be predicted with confidence, certain broad conclusions appear inescapable.

Manned Versus Unmanned Systems

For years, the “proper place” for manned and unmanned space vehicles has remained unchanged. Deep space, long-duration planetary exploration has been performed by unmanned robotic space probes. Space-based communication, remote sensing, weather and navigation missions are also performed with sophisticated unmanned platforms well suited to operation in the hostile environment of space. Manned missions are limited to complex scientific and (frankly) public relations endeavors.

Considering the likely advances in telepresence, virtual reality, and wideband communications linked with secure, reliable, remote piloting techniques, there will probably be no requirement for a sustained human presence in space through at least the 2025 time frame, at least in regard to military missions. With the single exception of limited space sorties delivered by transatmospheric vehicles (TAV), all of the space systems discussed in this paper are hosted by unmanned platforms.

Large Versus Small Satellites

The conventional approach to space systems involves large satellites (weight in excess of 500 kilograms) containing as many multimission payloads as will fit on the booster. The emphasis on high-volume, high-weight satellites has contributed to the enormous cost of developing and fielding space systems. A recent, and very attractive, alternative involves the use of small (weight below 500 kilograms) or even micro (weight below 50 kilograms) satellites launched by cost-effective boosters such as the Orbital Sciences Corporation's Pegasus. Commercial remote-sensing satellites are already being developed with a panchromatic spatial resolution as good as one meter and multispectral resolutions below 20 meters.⁵ Other uses for small and microsattellites will develop naturally as an outgrowth of continuing advances in the areas of materials, small sensors, miniaturized electronic and mechanical systems, inexpensive space launch, and packaging.⁶ Soon, satellites will no longer need to be large, heavy structures overloaded with redundant systems. Small and microsattellites will be able to perform all the functions carried out by today's large, "one of a kind" satellites.

Ground Versus "Anywhere" Processing and Delayed Versus Near Real-Time Information

The volume of scientific and intelligence data, including high-resolution imagery, is growing at an alarming rate. To handle this increased traffic, it will be necessary to install ever more capable onboard processing power on satellites equipped with advanced visible, infrared, and radar sensors. By 2025, it should be possible to process even the most complex images onboard in real time.⁷ Full image data sets will no longer need to be transmitted to central ground stations for slow postprocessing. These real-time images can then be "fused" with other forms of militarily significant intelligence information, in near real time, and at

any location desired—all made possible by microprocessors perhaps a million times more capable than anything we possess today. Combined with high-volume, high-bandwidth communications (perhaps laser communications), the military commander's dream of understandable, near-real-time information on demand will finally be possible. The "fog of war" will not be fully lifted in this way, but it will be significantly thinned.

Military Versus Cooperative/Commercial Endeavors.

The end of the cold war and the subsequent decline in military budgets has forced the US Air Force to reconsider its traditional posture on space operations. Every day, more foreign governments and commercial concerns are gaining access to space, turning near-earth orbit into a very busy place. Technologies once driven solely by US government dollars are increasingly dominated by private funding. Clearly, significant opportunities exist for the US Air Force to share the assets (and technological developments) of commercial concerns and even foreign governments to accomplish important missions such as communications and remote sensing.⁸ In particular, the large civilian investments in electronics, sensors, advanced communications, and information systems will soon exceed the military's research budget in these areas. Long before 2025, the US military must learn to adapt the technological developments of others to meet national security needs. This will not exempt us from our need for space superiority, and actually will drive our need for greater technological superiority in a variety of areas.

In the year 2025, military space operations will be augmented by vastly improved passive and active sensors, producing the nearly continuous global surveillance and reconnaissance capability (sometimes called "global awareness") required to project power on a global scale flexibly and effectively. These improvements will include the capability to detect and track fixed and mobile targets in all weather conditions with sensors accurate enough to provide useful battle damage assessment.⁹ This will be possible not through military-specific technological advancements but through synergistic civil, military, and international developments. All of these abilities will again be essential for a nation that desires space superiority and the capability to project force from space.

¹ David J. Lynch, "Spacepower Comes to the Squadron," *Air Force Magazine* 77, no. 9 (September 1994): 66. According to Brig Gen David L. Vesely, first commander of the Air Force Space Warfare Center, "When we got to the war, space resources were available, but were not tailored to the war fighter's problem. Tactical warning was just not there. Likewise, reconnaissance data all arrived, but we did not get what was tactically useful."

² John R. Boyd, "A Discourse on Winning and Losing" A collection of unpublished briefings and essays. Air University Library, Document No. M-U 43947, August 1987.

³ Gen Ronald E. Fogleman, USAF, and Sheila E. Widnall, *Global Presence 1995* (Washington, D.C.: HQ USAF, Pamphlet, 1995), 16.

⁴ Lt Col Bruce W. Carmichael, et al., "Strikestar 2025," AF 2025 Study (Maxwell AFB, Ala.: Air War College, 1996). See also CDR Clarence E. Carter, et al., "The 'Man in the Chair' - Cornerstone of Global Battlespace Dominance," AF 2025 Study (Maxwell AFB, Ala.: Air War College, 1996); Lt Col Edward F. Murphy, et al., "Information Operations: Wisdom Warfare for 2025," AF 2025 Study (Maxwell AFB, Ala.: Air War College, 1996); Lt Col William, Osborne, et al., "Information Operations: A New Warfighting Capability," AF 2025 Study (Maxwell AFB, Ala.: Air War College, 1996); and Maj Michael J. Tiernan, et al., "In-Time Information Integration System (I³S)," AF 2025 Study (Maxwell AFB, Ala.: Air War College, 1996).

⁵ Sarah L. Cain, "Eyes in the Sky: Satellite Imagery Blasts Off," *Photonics Spectra*, (October 1995): 90-104 and Maj Timothy Hawes, USAF, "Commercial Use of Satellite Imagery," *Program Manager* 24, no. 2 (March-April 1995): 44-47.

⁶ Gregory Canavan, and Edward Teller, "Strategic Defense for the 1990s," *Nature* 334 (19 April 1999): 699-704.

⁷ Information obtained from a senior US Air Force professional speaking to the Air War College under the promise of nonattribution.

⁸ Lt Col Larry D. James, USAF, "Dual Use Alternatives for DoD Space Systems," Maxwell AFB, Ala.: Air War College Research Report, April 1993, 31.

⁹ Canavan and Teller, 699.

Chapter 2

Required Capability

The US must ultimately control the high ground of space by attaining and maintaining space dominance through the use of space systems. A system-of-systems space-strike architecture must be developed that consists of five major components: (1) a global information network (surveillance and reconnaissance system, intelligence system), (2) a secure command and control system, (3) certain key utilities (communications, navigation, and weather), (4) a comprehensive readiness and sustainment system, and (5) a space-strike weapon system or combination of weapon systems. The architecture for a particular mission might consist of the weapon plus sensors and/or communications integrated on a single, space-based platform, or all parts of the system might be distributed across a number of platforms based in different mediums (space, air, sea, land, subsurface). The actual location of the various components should be determined by the outcome of a complicated systems analysis process that considers many cost-effectiveness and mission-effectiveness factors. Only mission-effectiveness factors will be addressed in this chapter.

Every weapon system possesses, to greater or lesser degree, the capabilities of timeliness, responsiveness, flexibility, survivability, reliability, precision, and selective lethality. The following discussion centers on these major capabilities required by a global space-strike system in 2025.

Timeliness

The space-based, high-resolution surveillance and reconnaissance, high-bandwidth communications, and ultraprecise navigational systems of 2025 will make it far easier to see, move, talk, and shoot. These space systems will be fully interconnected and, because of broad based commercialization, available to

practically every nation and major organization on the planet. Key aspects of the interconnected system-of-systems will be common spacecraft bus modules, the use of industry (and probably international) standards, small and microsattellites (particularly as a means of improving technology insertion), and fully transparent tasking. The user will interact with information, not with discrete instruments. A real-time, redundant, seamless link will exist between space-based assets and assets operating within the earth's atmosphere.¹ Tailored, near-real-time information will be readily available to war fighters and their weapon systems. Every weapon system in 2025, including the global space-strike system, must be designed to make the best use of this timely information (called in-time information in the AF **2025** white paper entitled "In-time Information Integration System").² A more complete view of the near-real-time information system outlined above is available in various AF **2025** white papers dealing with surveillance and reconnaissance systems and information operations.³

Responsiveness

Force application missions usually begin as contingency operations, which are rapid responses to crises. A crisis may come without any notice and produce a tremendous amount of stress to disseminate information quickly and accurately. Decision makers need complete information on the developing crisis in near real time (the actual speed depends on the time available to decide and take proper action). A near-absolute assurance of connectivity is critical for a distributed information system, because if the total system does not maintain its connections it cannot be effective—in this case, responsiveness is meaningless. The key to an effective global space-strike is, therefore, to affect a crisis or conflict decisively before it can grow out of control. The response action must occur at a rate faster than the opponent can react—"within the enemy's OODA loop" in the words of Col John Boyd.⁴ In the fast-paced world of 2025, the US military's "system-of-systems," and its global space-strike system, must be more responsive than anything that exists today. The United States's OODA loops may well need to "turn" in minutes or even seconds.

Flexibility

The fog and uncertainty of war, ancient and modern, has taught military commanders to always keep their options open. At the tactical level, this means the military commander does not commit to any one course of action, nor to any fixed allotment of forces to any task, until the proper (usually the last) moment. Even then, the effective military commander must always retain the ability to switch forces from one objective to another as the conflict unfolds.⁵ Surprise is an uncomfortable and unwelcome, but sadly ever-present, bedfellow for the commander.

Conflict can be characterized by the level of objective intent. The most common definition of the “spectrum of force” identifies three levels of intensity: low, medium, and high. High intensity is generally characterized by continuous engagement and an exchange of lethal blows between conventional or nuclear-capable forces with the intent of totally destroying the enemy. At the lowest end of the spectrum, the conflict involves the limited uses of force embodied in subversive, partisan, terrorist, and guerrilla tactics. Even in the slower-paced world of 1996, most military missions are at the lower and politically far more sensitive end of the spectrum. The US military must possess flexible combat systems capable of projecting force at all levels of power.

Survivability and Reliability

A system that cannot survive the outbreak of hostilities is not a useful system. A force-application system, in particular, must be “robust”—it must be available to the commander whenever it is needed. The desirable global space-strike system is one that is resistant to the enemy’s attempts to render it inoperative (a survivable system) and that is relatively easy (in terms of cost and effort) to maintain and sustain (a reliable system). This is a particularly sensitive and important issue for space systems, since they are often deployed far from US support bases.

Precision and Selective Lethality

The US public recently discovered (during Operation Desert Storm) what its military has long known: the enormous value of being able to strike military targets with great precision. Precision reduces the total cost required to engage targets for two basic reasons: the total number of munitions assigned to a given target can be reduced once you are assured each attempt will probably strike, and a less active agent (explosive, pyrotechnic, etc.) is required for each munition once you can select the target's most vulnerable point for engagement. More importantly, precision attacks require fewer sorties and thereby reduce the exposure of combat personnel to the danger of injury or death.

An important corollary of precision attacks involves the potential for selective lethality. A selectively lethal attack has two attributes: it strikes the desired target and *only* the desired target (thereby greatly reducing collateral, generally civilian, damage) and it can be “tuned” to levels of less than lethal force. A strategic nuclear bomb can be a precise combat system (fitted with an appropriate guidance system), but it cannot be a selectively lethal combat system—the nuclear bomb can only destroy its target.

An example will make the value of selective lethality clear. Consider the case of an important communications node (e.g., a microwave tower) standing next to a children's hospital. The task at hand is to “put the communications node out of commission.” This can certainly be done by successfully dropping an iron bomb directly on the tower, but only with severe risk to the nearby children's hospital. A selectively lethal combat system might accomplish the same job with greater force economy by precisely striking the tower's antenna feeds and associated electronics and over heating or melting them. The hospital is completely safe and the tower remains standing for potential postconflict use by friendly forces once the feeds and electronics have been replaced.

Notes

¹ *New World Vistas* Study Group Briefing, subject: Surveillance & Warning, April 1995.

² Maj Michael J. Tiernan, et al., “In-Time Information Integration System (I³S),” AF **2025** Study (Maxwell AFB, Ala.: Air War College, 1996).

³ Lt Col Bruce W. Carmichael, et al., “Strikestar **2025**,” AF **2025** Study (Maxwell AFB, Ala.: Air War College, 1996). See also CDR Clarence E. Carter, et al., “The ‘Man in the Chair’ - Cornerstone of Global Battlespace Dominance,” AF **2025** Study (Maxwell AFB, Ala.: Air War College, 1996); Lt Col Edward F. Murphy, et al., “Information Operations: Wisdom Warfare for **2025**,” AF **2025** Study (Maxwell AFB, Ala.: Air War College, 1996); Lt Col William Osborne, et al., “Information Operations: A New Warfighting Capability,” AF **2025** Study (Maxwell AFB, Ala.: Air War College, 1996); and Maj Michael J. Tiernan, et al., “In-Time Information Integration System (I³S),” AF **2025** Study (Maxwell AFB, Ala.: Air War College, 1996).

⁴ John R. Boyd, “A Discourse on Winning and Losing.” A collection of unpublished briefings and essays. Air University Library, Document No. M-U 43947. August 1987.

⁵ Air Force Manual 1-1, Vol. II, March 1992, 283.

Chapter 3

The Integrated System-of-Systems

In this paper, the “weapon system” will be narrowly defined as the weapon itself; the platform on which it is carried; and the autonomous but interconnected surveillance, acquisition, tracking, and battle damage assessment (SAT/BDA) system needed to operate the weapon system in the desired “fire and forget” mode. The weapon system is a system-of-systems (weapon-platform-SAT/BDA) embedded in and interconnected with a much larger system-of-systems. Without a national global surveillance and reconnaissance system and associated intelligence system, no target will ever be found, assessed, and handed off. Without a secure, high-bandwidth global command, control, and communication (C³) system, sensor information and command decisions cannot get where they need to go. Without a robust, distributed information system, the many types of raw sensor data can never become the fused all-source information essential to battle management. Without adequate support in the area of readiness and sustainment, a weapon system can not be counted on to do its job. The weapon system concepts described in this white paper must be understood in this context. By 2025, no weapon system will be truly autonomous— to operate most effectively, the weapon systems of 2025 will depend on the smooth, high-speed functioning of the total US military war-making system.

The distributed nature of the system-of-systems described above can be its greatest strength or its greatest weakness. Any critical physical or intangible nodes in the distributed system could be attacked, rendering the entire system useless. The system-of-systems must be designed carefully to minimize or eliminate all critical nodes. Critical nodes that cannot be eliminated must be protected by deception, added defenses (hardening, placement within a secure environment), or redundancy. Ideally, the space weapon system itself should be so well distributed no sensible adversary would contemplate a preemptive strike.

Only the potential weapon system concepts will be discussed in the Space Operations white paper. Some concepts for integrating the weapon system into the global information network are contained in appendix B. The information, C³, and surveillance/reconnaissance and intelligence systems are addressed in other Air Force *2025* white papers.¹

Weapon Platforms

The weapons themselves may be mounted on or fired from a space-based platform (space-based) or they may be mounted on platforms that traverse the space medium, such as an inter-continental ballistic missile (ICBM) or transatmospheric vehicle (TAV) (space-borne). Each scenario has its advantages and disadvantages, which will be detailed for each weapon system.

The space-based platform is the most responsive, because it operates immediately from the high ground of space. Possessing the unique perspective of space, space-based weapons can immediately cover a large theater of operations. This potential advantage grows as the platform's orbital altitude is increased, reaching its peak with platforms placed at geosynchronous orbit, which effectively provides access to almost half the earth's surface from a single platform. Of course, the higher the orbit, the farther the platform is from its targets. Alternatively, if the platform can be placed in low earth orbit (LOE), the range to the target can be minimized at the cost of reduced ground (and time) coverage for each platform. Given the immense volume of near-earth space, a space-based constellation can consist of many platforms, providing reliability through redundancy. A weapon system with enough space-based platforms at the proper orbital altitude(s) can potentially ensure global, full-time coverage and provide the ability to conduct prompt and sustained operations anywhere on the planet.

As hinted above, space-based platforms are not without their limits. The inexorable laws of physics demand that low earth orbit platforms have orbital periods measured in tens of minutes. Global, full-time coverage for low earth-orbiting systems will therefore require numerous platforms and/or new propulsion concepts, such as the "Hoversat," which could potentially, given enough fuel, provide loiter time by installing a jump-jetlike propulsion system on each platform.² Since orbits are regular and predictable, any gaps in coverage could easily be exploited by a clever adversary. Each platform must also be lifted into orbit at great cost in energy and money, unless inexpensive space lift is available by 2025. Once in orbit, each platform is

automatically difficult to service and maintain. Additionally, a truly effective constellation of platforms could easily become a high-value target in plain sight for a determined adversary. If the US is the only nation possessing such a constellation, this could invite massive active or passive antisatellite (ASAT) countermeasures that would flood near-earth orbit with debris. This debris cloud would threaten the entire world's space assets. By 2025, the ramifications of such a catastrophe would be truly global, affecting every person on the planet. This potential vulnerability could be reduced by miniaturizing and stealthing space-based platforms.³

The class of platforms called “space-borne” platform is the most flexible, since it can potentially begin its operation under direct human control within the terrestrial environment (on land, sea, or in the air). Servicing and maintenance are less difficult for such platforms, because they are much more accessible to human technicians. Space-borne platforms can be less vulnerable, because they can be held within the confines of sovereign US territory. Their vulnerability is also reduced because they can be made highly maneuverable much more easily than a space-based system. Promising lift concepts for space-borne platforms in 2025 are described in the AF *2025* Space Lift white paper.⁴

The most familiar space-borne platform is the ICBM. American ICBMs are currently configured to deliver nuclear weapons to any location on earth within 30 minutes.⁵ Given the apocalyptic nature of this weapon, nuclear-tipped ICBMs are generally regarded as the ultimate weapon of deterrence—a weapon no one really wants to use (ever). American ICBMs already exist with a circular error of probability (CEP) measured in feet.⁶

The debate on the desirability of putting man in space is a long and acrimonious one. No machine can come close to the breadth and depth of mankind's abstract reasoning ability, but it is a very costly task to develop systems to launch and sustain a manned presence in space. A Spacecast 2020 White Paper (section H) makes the argument for a manned space-borne platform called a TAV, the “Black Horse.”⁷ The biggest advantage of the manned TAV is that it is probably the most flexible platform yet proposed for space operations simply because it is under the continuous control of a human. Given an appropriate design, the manned TAV could be quickly reconfigured to deliver special operations teams, high-value equipment and supplies, or a wide variety of munitions (in much the same fashion as a high-speed bomber).⁸ Most important

of all—the TAV can put a few well-trained people at the site of a developing conflict anywhere on Earth within 60 minutes from launch.⁹

The most important disadvantage of space-borne platforms is their relative lack of responsiveness. A TAV can reach anywhere on earth within 40 minutes once it has reached orbit, but this cannot compare with a speed-of-light attack from a directed energy weapon in orbit above a target. If a space-borne platform is not already hovering “near station,” this single disadvantage may be fatal in an era when response times have improved to minutes or even seconds.

Weapon Classes

The potential space-strike weapons can be broadly grouped into four categories: directed energy, projectile, space sortie and information. Information “weapons” are discussed in white papers prepared by other AF **2025** teams.¹⁰ The rest of the weapons systems will be described in terms of their capabilities and shortfalls, and countermeasures for each system, will be discussed. Finally, each system is evaluated in light of timeliness, responsiveness, flexibility, precision, survivability, reliability, and selective lethality (desired capabilities described in chapter 2). The final result will be selection of a credible space-force application system-of-systems.

Directed-Energy Weapons—Incoherent Light

Unfiltered by the atmosphere, the sun provides an enormous flux of natural (incoherent) light in near-earth orbit. Our best measurements of this flux put the available power density at 0.1395 W/cm^2 .¹¹ Currently, this vast power source is tapped with solar arrays to power satellites. It is conceivable that large focusing mirrors equipped with pointing and tracking and maneuvering systems could be placed in orbit to intercept and redirect solar energy onto the battlefield.¹² Single, very large mirrors (on the order of kilometers in diameter) or large arrays of smaller mirrors working in concert would be needed to make this concept useful. Even in LEO orbit, these mirrors would need pointing and tracking accuracies of 10 to 100 nanoradians to qualify as precision aimed weapons.

Optical systems (primarily collecting apertures) currently under study have been limited artificially to a size of four meters for potential launch on the space shuttle.¹³ The optical substrates are made from ultralow-expansion, rigid glasses such as Zerodur^R that are made lightweight with acid-etching techniques.¹⁴ Larger, still lightweight structures could potentially be made from advanced aerogel materials, advanced ceramics (such as SiC), engineered composites, structurally supported optically coated plastics, suspended or spun-reflective liquids (a liquid mirror), or inflatable mirrors (reflective films on an inflatable substrate).¹⁵ All these approaches have been demonstrated at the earth's surface with structures measured in feet or at most a few meters.¹⁶

Capabilities

The most likely incoherent light weapon would consist of an orbiting array of mirrors in the 10-to 100-meter class. With the proper constellation, the orbiting mirrors could intercept and redirect sunlight onto the earth's surface. The simplest use of the system would be to provide battlefield illumination on demand. Depending on the area illuminated, useful illumination could be provided by one to a 100 mirrors operating in concert. By focusing the light from many mirrors onto a single spot or series of spots, battlefield temperature could also be raised (a potential form of weather modification— see the AF *2025* white paper “Weather as a Force Multiplier”) and optical sensors (including human eyes) could be temporarily blinded.¹⁷ Emergency electrical power could be “beamed” to lightweight solar panels erected to intercept the redirected sunlight. To achieve more permanent effects, such as melting, as many as 100 mirrors might need to point and track on a single hardened target for a period ranging from several tens to hundreds of seconds. Spotlight beams from a few mirrors could also be used to aid search and rescue or special operations missions at night. Incoherent light weapon systems are limited in the rate at which they cause permanent damage by the fact that incoherent light, unlike coherent (laser) light, cannot be focused onto extremely small spots.

Countermeasures

Incoherent light is difficult to focus; easy to block with broadband reflective, scattering, or absorptive barriers (such as aerosol clouds); and can be decoupled from target surfaces with reflective coatings. The last two countermeasures can be defeated, however. Reflective coatings tend to degrade naturally, especially in the battlefield environment, and they can be deliberately attacked with abrading materials (sand) or absorptive liquids (paints/dyes). Blocking barriers can be attacked and eliminated by cooperative land, sea, or air forces. In particular, blocking clouds of aerosols (e.g., smoke) can be rapidly eliminated with heavy liquid sprays. A clever adversary can also delay damage to his assets by spreading the absorbed heat through rotating some targets (such as missiles) or by insulating targets with inexpensive materials like cork.¹⁸

Evaluation

The biggest advantage of an incoherent light weapon (if the technology could be adequately developed) is the endlessly available power supply. The range of lethality is also attractive assuming the precision pointing and tracking problems could be conquered. However, the flexibility and survivability of mirrors that may need to be hundreds of meters or even kilometers in size negates this as a viable weapon system. Furthermore, if the constellation were placed in a LEO for better accuracy, sustainment, and reliability, there would have to be many of these very large mirrors just to ensure good timeliness and responsiveness; this is neither practical nor cost-effective.

DEW—Coherent Light (Lasers)¹⁹

Lasers can be built as either continuous wave (CW) or pulsed devices. CW laser effects are generally described in terms of power density on target in W/m^2 ; pulsed laser effects are described in terms of energy density on target in J/m^2 .²⁰ Although significant advances in this technology have been made by both Ballistic Missile Defense Office (SDIO/BMDO) and the USAF Phillips Laboratory Airborne Laser (ABL) organizations, laser technology still needs further development.²¹ To date, ground-based chemical lasers have been built in the megawatt class (the ALPHA laser).²² Phillips Laboratory is also developing a

hundred-kilowatt-class short wave CW chemical laser (SWCL) based on the oxygen-iodine chemical system.²³ Weapons-class pulsed lasers have also been built, but primarily for effects and materials research.²⁴

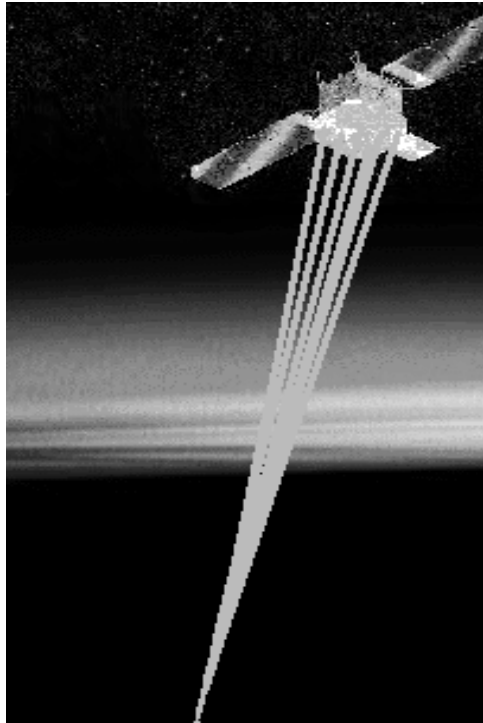

Figure 3-1. A Notional Space-Based Laser

For the space-earth geometry (see fig. 3-1), multimegawatt power is required for a CW weapons laser and hundreds to thousands of joules of energy per pulse is required for a pulsed weapons laser (depends on pulse length and pulse repetition frequency).²⁵ Total power or energy requirements are correspondingly higher for the earth-space-earth geometry. Constellations employing only a few space platforms (e.g., laser stations for the space-earth geometry, laser mirrors for the earth-space-earth geometry) would have to compensate for long slant ranges and correspondingly higher-atmospheric distortion by using even more powerful beams.²⁶ Lasers are not all-weather systems. The laser wavelength, and therefore the laser gain medium and optics train, must be carefully chosen to permit good atmospheric propagation. Clouds absorb and scatter laser light, removing power from the beam and distorting the beam's "footprint."

The size of the optics necessary to point and focus a laser beam depends on the frequency of the laser and the range to the target. For visible and near-infrared lasers, the frequencies under study for use at long

range, optics in the four to 20 meter diameter should suffice for a system in low earth orbit.²⁷ For a brief review of research trends in large optics, see the discussion on incoherent light weapons (see page 20).

To achieve the status of a precision-aimed weapon, laser weapon systems will require pointing and tracking accuracies in the 10 to 100 nanoradian range for systems in low earth orbit.²⁸ The SDIO/BMDO acquisition, tracking, pointing, and fire control program has already demonstrated a pointing stability to “below the program goal of less than 100 nanoradians.”²⁹ It has, however, not yet been proven that large structures in earth orbit can be stabilized to these levels. This is a challenge of particular importance for a distributed laser weapon system consisting of an earth-based laser and a constellation of space-based mirrors. In this scenario, the laser beam must be relayed by several space mirrors before it reaches some targets.

Adaptive optics techniques such as the Guide Star System have been developed to correct atmospheric distortions to low-power laser beams projected from earth to space and back again.³⁰ Adaptive optics systems developed to date depend primarily on deformable mirrors—mirrors with small actuators that change the mirror’s shape to pre-compensate the beam and correct anticipated or premeasured distortions. Further advances will be required in this technology, both in terms of bandwidth and number/size of actuators, to make this technology work for weapons class lasers. Current advances in microelectromechanical machines and nanotechnology show great promise in this area.³¹ The bandwidth problem on the processing side will probably “handle itself,” given the current rate of growth in semiconductor technology and continued commercial/government interest in optical processing techniques.³² Advances in high-speed (10 Gbits/sec and up) laser communication systems are also likely to yield solutions of interest to the laser weapon designer.³³

Capabilities

Lasers are extremely flexible weapons, producing effects that cover the full “spectrum of force.” At low power, laser beams can be used as battlefield illumination devices, but with a potential added benefit over incoherent illumination. Using an invisible laser beam (near infrared) at a specifically chosen wavelength and special tuned vision devices similar to night-vision goggles, one could render the battlefield visible only

to friendly troops.³⁴ At low to medium power, laser beams can be used to designate targets from space, blind sensors in the laser’s optical band, ignite exposed flammable objects, raise the temperature in localized regions (possible weather modification effect—see the AF *2025* white paper “Weather as a Force Multiplier”),³⁵ perform as an emergency high-bandwidth laser communication system, and serve as a laser probe for active remote-sensing systems.³⁶ At slightly higher powers, the enhanced heating produced by the laser can be used to upset sensitive electronics (temporarily or permanently), damage sensor and antenna arrays, ignite some containerized flammable and explosive materials, and sever exposed power and communications lines. The full power beam can melt or vaporize virtually any target, given enough exposure time. With precise targeting information (accuracy of inches) and beam pointing and tracking stability of 10 to 100 nanoradians, a full-power beam can successfully attack ground or airborne targets by melting or cracking cockpit canopies, burning through control cables, exploding fuel tanks, melting or burning sensor assemblies and antenna arrays, exploding or melting munitions pods, destroying ground communications and power grids, and melting or burning a large variety of strategic targets (e.g., dams, industrial and defense facilities, and munitions factories)—all in a fraction of a second.

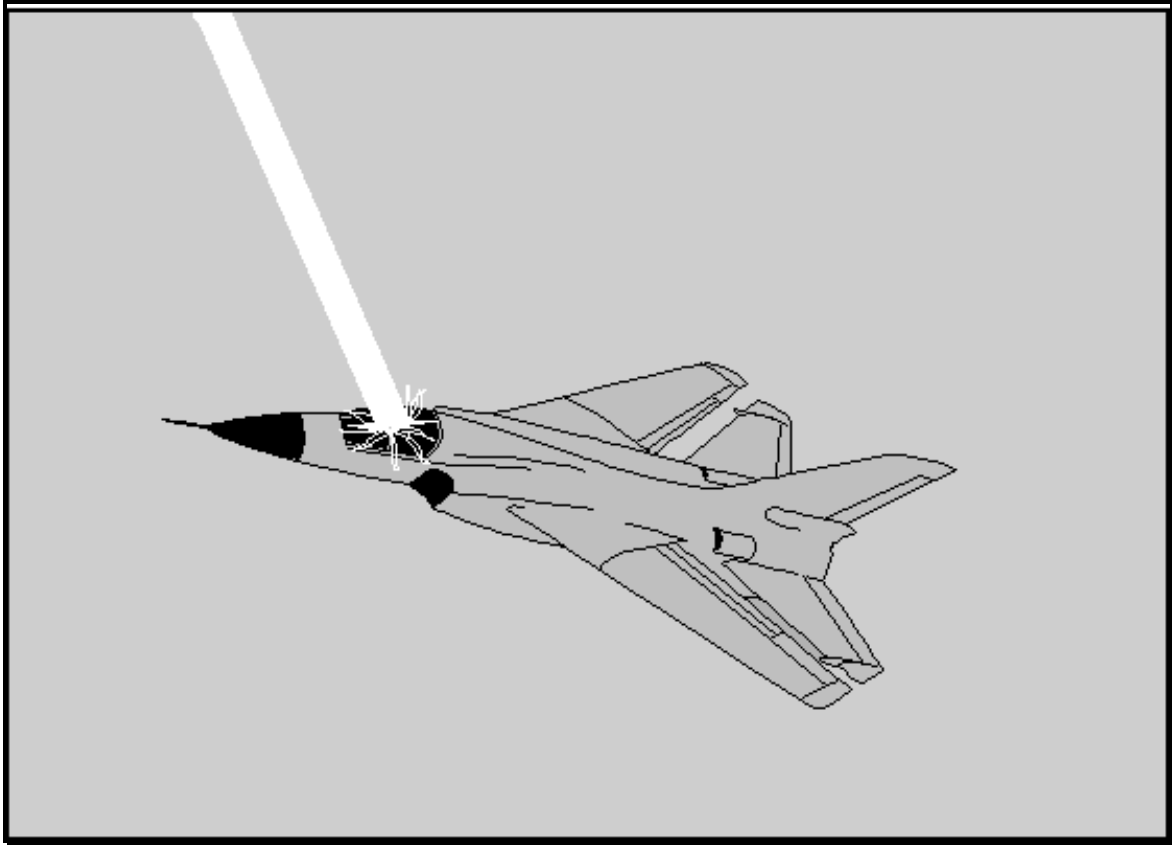

Figure 3-2. Precision Laser Strike on Aircraft

Pulsed lasers can also produce additional effects based on their ability to deliver rapidly a large amount of energy in a small amount of time. Weapons-class pulsed lasers can vaporize target surfaces so rapidly that an effect very like a rocket firing occurs. In essence, the target experiences a shove or impulse with every laser pulse. If a strong enough impulse is delivered, the laser can discriminate between valid air- or space-borne targets and lightweight decoys (although the details of this process are very difficult to satisfy).³⁷ If the impulse can be delivered at an object's resonant frequency, cracking and breaking will occur. Similarly, a pulsed laser trained on an object at the proper pulse-repetition frequency can stimulate infrasound vibrations, a potential form of nonlethal force projection that disrupts a target with penetrating, low-frequency oscillations.

Perhaps more significantly, the large space-based mirrors of a distributed laser weapon system (laser is ground based) can also be used as a high-quality, passive remote-sensing system.³⁸ By training ground-based, high-power optical telescopes on the mirrors, America's "eyes" can literally be carried to every corner of the earth. Cued by a broader area search, this capability could be the primary surveillance, battle

damage assessment, and targeting system for the laser space-strike weapon or a valuable adjunct to America's existing national technical means. With a large constellation of space-based mirrors in LOE, America's opponents could literally never be sure when they are being watched, closing the existing coverage gaps. Rather than depending on a few large, expensive assets that will inevitably become tempting targets, we can protect our surveillance and reconnaissance capability by increasing the number of "eyes" in orbit.

A weapons-class laser is useful only so long as it has fuel. This is a particular problem for a space-based laser, since it can be expensive to lift large quantities of fuel into orbit. This problem could be mitigated by using solid-state or diode laser systems that can be configured to operate on electrical power.³⁹ Such systems are also attractive because of their relatively high efficiency. Diode laser systems have been built with electrical efficiencies as high as 50 percent at room temperature and cooled diodes have demonstrated efficiencies of 90+ percent.⁴⁰ The most powerful contemporary diode laser arrays are still low-power systems (1 - 100 Watts), although the technology appears to be scaleable.⁴¹ Enormously powerful pulsed glass laser systems have been built as elements of the DOE inertial confinement fusion program, but these systems are huge, inefficient, and quite fragile.⁴² Clearly, further technology work is required to make these systems deployable.

Atmospheric interactions are another challenge for weapons class lasers. Aside from the obvious scattering and absorption problems, high-power CW lasers are known to cause "thermal blooming" (e.g., a severe defocusing of the beam) and "beam steering" (unintended shifts in beam direction) when they pass through the atmosphere.⁴³ Pulsed high power lasers, with their attendant powerful electric fields, can stimulate nonlinear optical effects such as "harmonic generation" (e.g., the inadvertent generation of other colors of light) that rob power from the main beam and make it difficult to focus the laser on the target.⁴⁴ Laser beams of higher frequency are more easily focused on the target, requiring smaller control optics and mirrors. Unfortunately, high-frequency lasers are inherently more difficult to develop, usually requiring dangerous exotic fuels and exhibiting much lower efficiencies.⁴⁵ High-frequency lasers, particularly those above the green region of the spectrum, also scatter very strongly in the atmosphere and are increasingly subject to the nonlinear optical effects previously discussed.

Current weapons-class lasers all produce beams in the near infrared (short-wave infrared or SWIR). These frequencies are strongly affected by clouds and suspended particles, and cannot always be depended on to engage targets below the cloud tops at about 30,000 feet.⁴⁶

Countermeasures

Lasers are subject to the same basic countermeasures as incoherent light weapons and can be aided by the counter countermeasures outlined above. An additional phenomenon known as the laser supported combustion (LSC) wave can occur when a high-power laser beam strikes a target surface.⁴⁷ As the laser vaporizes surface material from the target, the hot gas can absorb even more energy from the laser beam. If enough energy is present on a short enough timescale, the hot gas is rapidly ionized, producing a hot, dense plasma. The plasma absorbs all the incident energy, essentially shielding the target surface from the direct effect of the beam. This phenomenon is generally a problem for high-power pulsed lasers and represents the upper limit to the amount of laser power one should generally attempt to put on target. At even higher incident powers, the LSC develops into a detonation wave or LSD that swiftly travels back up the laser beam, further decoupling the laser from the target.

Evaluation

The coherent light laser is an extremely attractive space-strike weapon for several reasons. It is highly responsive and timely (e.g., could strike within seconds after a decision is made to take action), it has already demonstrated high-precision capability (especially in recent ABL and SDIO/BMDO tests), and it has inherently high flexibility and selective lethality (from “lighting the battlefield” to temporarily disturbing sensors and electronics to melting or burning large or small targets). Additionally, the ground-based lasers could be relayed to or independently pointed at the space systems of aggressor nations (or organizations), serving as an important US space-control asset as needed. When not needed as a force-application or space-control weapon system, the space-based mirrors can form the basis for a very effective, survivable space-based global surveillance and reconnaissance system.

In a LEO constellation, a 20-meter mirror is certainly not as daunting as a kilometer sized one, but it is still awkwardly large and therefore expensive and less survivable. In fact, each space-based mirror would need a covering until it is used, lest it be damaged by simple antisatellite attacks or by space debris and contamination (e.g., altering the surface and rendering the mirror useless for relaying high-power laser beams). Reliability is also a concern due to the large amounts of power required by the ground-based laser and the lamentable effect of weather (clouds) on the operational availability of the system. However, a distributed laser space-strike system with ground-based lasers could certainly be maintained and even upgraded much more easily than a completely space-based system, thereby increasing the overall reliability. In sum, ground-based CW lasers coupled to space-based mirrors seem a highly effective and feasible option for a space-strike weapon system in 2025.

Neutral Particle Beam

A Neutral Particle Beam (NPB) weapon produces a beam of near-light-speed-neutral atomic particles by subjecting hydrogen or deuterium gas to an enormous electrical charge.⁴⁸ The electrical charge produces negatively charged ions that are accelerated through a long vacuum tunnel by an electrical potential in the hundreds-of-megavolt range. At the end of the tunnel, electrons are stripped from the negative ions, forming the high-speed-neutral atomic particles that are the neutral particle beam. The NPB delivers its kinetic energy directly into the atomic and subatomic structure of the target, literally heating the target from deep within.⁴⁹ Charged particle beams (CPB) can be produced in a similar fashion, but they are easily deflected by the earth's magnetic field and their strong electrical charge causes the CPB to diffuse and break apart uncontrollably. Weapons-class NPBs require energies in the hundreds of millions of electron volts and beam powers in the tens of megawatts.⁵⁰ Modern devices have not yet reached this level.⁵¹

Particle beams are an outgrowth of conventional atomic accelerator technology. Weapons-class particle beams require millions of volts of electrical potential, powerful magnetic fields for beam direction, and long accelerating tunnels. Current technology accelerator devices with these capabilities weigh in the hundreds of tons and require enormous power sources to operate.⁵² Composed of neutral atoms, NPBs proceed in a straight line once they have been accelerated and magnetically pointed just before neutralization in the

accelerator. An invisible beam of neutrally charged atoms is also remarkably difficult to sense, complicating the problem of beam control and direction.⁵³

Capabilities

Like lasers, NPBs are essentially light-speed weapons. More difficult to control and point than the light weapon, the NPB is strictly a line-of-sight device (cannot be redirected). Moreover, a NPB would be difficult and expensive to place in orbit. Many tons of material must be lifted and a complex device must be constructed under free-fall conditions. This means the power supply, accelerator, beam line, magnetic focusing and pointing device, stripper, maneuvering system, and SAT/BDA system must all be located on a large platform on orbit. A useful constellation of NPB systems in LOW must contain many platforms (dozens) to avoid gaps in coverage. A constellation in higher orbit would require fewer platforms, but it would be correspondingly more difficult to control the beam and put it on target.

In addition, the NPB is strongly affected by passage through the atmosphere, attenuating and diffusing as it passes through dense gas or suspended aerosols (e.g., clouds, and dust).⁵⁴ A space-based NPB is therefore most useful against high flying airborne or spaceborne targets. At relatively low powers, the penetrating beam can enter platforms and payloads, producing considerable heat and uncontrollable ionization. Thus, the NPB is useful at the low end of the spectrum of force, producing circuit disruption without necessarily permanently damaging the target system. At higher powers, the NPB most easily damages and destroys sensitive electronics, although it is fully capable of melting solid metals and igniting fuel and explosives. Like the laser, the NPB is inherently a precision-aimed weapon. To be most effective, an NPB weapon should therefore receive very precise targeting information (inches) and must have a pointing and tracking system with extreme stability (10 to 100 nanoradians). With this level of support, the NPB would be able to quickly disable targets by centering its effect on vulnerable points (e.g., fuel tanks, control cables, guidance and control electronics, etc.).

Like the pulsed laser weapon, the NPB can be used to discriminate against decoys in a ballistic missile defense scenario (e.g., a very difficult, but theoretically possible mission). When the beam penetrates a target, the target's atomic and subatomic structure produce characteristic emissions that could be used to determine the target's mass or assess the extent of damage to the target. The SDIO/BMDO has already

researched and demonstrated detector modules based on proportional counter and scintillating fiber-optics technologies that are reportedly scaleable to weapon-level specifications.⁵⁵

Countermeasures

Rapid maneuvers and dense shields are the best countermeasures for an NPB. If the beam can be generated successfully and pointed at the target, it is difficult to defend against. Since the beam deposits its energy deep into the target's atomic structure, the primary weapon effect is penetrating heat deposited so rapidly it causes great damage.

Evaluation

It does not appear feasible to develop an NPB weapon system as a space-based system even by 2025 due to the weight, size, power, and inherent complexity of the NPB. Also, due to the line-of-sight restrictions, the timeliness and responsiveness would be low to moderate as the weapon "waited" for the target to move within view. The flexibility and selective lethality of the NPB is also moderate in that it can range from temporary to permanent damage. Precision is excellent in theory, but questionable in use due to earth's magnetic field and countermeasures. Since the beam is strongly affected by passage through the atmosphere, ground-or sea-based targets probably could not be targeted. Finally, the reliability of such a complex, easily-affected weapon is moderate at best. The NPB weapon system does not appear to be practical in 2025.

Electromagnetic Pulse

An electromagnetic pulse (EMP) is a sudden, high-intensity burst of broad-band electromagnetic radiation. The range of electromagnetic frequencies present depends on the source of the EMP. The high-altitude airburst of a nuclear weapon produces an intense EMP which, because of the relatively long duration of the explosion, contains strong low-frequency components (below 100 MHz).⁵⁶ Conventional EMP devices built with explosively driven, high-power microwave technology produce a less intense, very short (nanoseconds) burst composed primarily of microwave frequencies (100 MHz - 100 Ghz).⁵⁷ The range of the

EMP effect depends on the strength of the source, as the initial electromagnetic shock wave propagates away from its source with a continuously decreasing intensity.⁵⁸

The gamma radiation produced by a fission or fusion bomb interacts with the atmosphere, creating a large region of positive and negative charges by stripping electrons from atmospheric gasses.⁵⁹ The motion of these charges create the EMP. The pulse enters all unshielded circuits within range, causing damage ranging from circuit malfunction and memory loss to overheating and melting.⁶⁰

Militarily useful EMP can also be created by mating a compact pulsed power source (gigawatt range), an electrical energy converter, and a high-power microwave device such as the “vircator” (virtual cathode oscillator).⁶¹ An advantage of a conventional EMP device is that it can be triggered in a shorter amount of time, thereby putting more output energy into the higher microwave frequencies (above 100 MHz). Since modern electronics operate primarily in these microwave bands, the EMP produced by conventional devices is potentially very effective in shutting down electronics. Explosively pumped EMP devices such as the vircator have another advantage: it is possible to design them to focus their EMP in a particular direction. Even a focused EMP effect produced by a conventional device will probably have a lethal radius measured only in hundreds to thousands of meters, depending upon the strength of the power source and atmospheric absorption (particularly at frequencies above 20 Ghz).⁶²

Finally, the USAF Phillips Laboratory has produced compact plasma toroids with energies in the range of 10 kilojoules.⁶³ Directed at solid targets, the plasma toroids induce rapid heating at the surface, producing extreme mechanical and thermal shock as well as a burst of X rays.⁶⁴ The X-ray burst can also be used to generate EMP. While theory predicts the toroids will be rapidly dissipated by the atmosphere, there may well be a method of delivering high-energy plasmas to the vicinity of a target that does not involve long paths in air.

Capabilities

The few experiments with nuclear bursts in space have revealed that the size of the nuclear EMP effect is related less to the yield of the bomb than to the altitude of the burst. A 100-kiloton burst at an altitude of 60 miles would create damaging EMP over an area equal to half the US. At 300 miles, the same burst would

create EMP over an area equal to the entire US plus most of Mexico and Canada. The gamma burst from a (purely theoretical) microyield nuclear device might be used to create a more manageable EMP effect.⁶⁵

Electrical devices exposed to an EMP burst experience effects ranging from temporary electronic disruption at the outer edge to destructive electrical overvoltages near the center. Modern semiconductor devices, particularly those based on MOS (metal oxide semiconductor) technology such as commercial computers, are easily damaged by these high-voltage transients.⁶⁶ Long ground lines, such as electrical transmission wires, act as enormous antennas for the EMP burst.⁶⁷ Power transmission and communication grids are therefore extremely vulnerable and will probably be destroyed by the burst. Any system containing semiconductor electronics, including airborne platforms, would be shut down or burned out by the burst unless it was completely protected with heavy, expensive electrical and magnetic shields, well designed electrical filters, and careful grounding. An extremely effective area weapon, the EMP produced by a nuclear airburst would undoubtedly produce severe damage to the civilian infrastructure.

A more flexible form of EMP weapon system would employ either a microyield nuclear weapon (yield below two kilotons), a conventional explosively driven EMP device or plasma technology to produce the EMP.⁶⁸ Microyield nuclear weapons or conventional EMP devices could be delivered to the vicinity of the target as a bomb (perhaps by a TAV) or as the warhead of a missile. Given the unpredictable but damaging effect of EMP on electrical and electronic equipment, these EMP “explosions” are best used against enemy platforms and facilities that depend on sophisticated electronics, particularly the enemy’s command, control, and communications system (strategic target) and the enemy’s air defenses (operational target).⁶⁹ Missiles equipped with EMP warheads are also effective weapons in the fight for air superiority, since modern high-performance fighter aircraft depend heavily on sophisticated, and therefore vulnerable, electronics.

The main difficulty with the nuclear EMP effect is its indiscriminate nature. The pulse travels in every direction and covers large areas of the planet, potentially damaging friendly assets just as greatly as those of the enemy. Another impediment to the use of nuclear-driven EMP weapons is the worldwide aversion to nuclear weapons, particularly nuclear weapons on orbit. Once a nuclear bomb explodes in space, the charged particles produced can easily be trapped in the earth’s Van-Allen radiation belts. This would greatly increase the radiation exposure for any satellite passing near the radiation belts, disrupting or destroying poorly

shielded satellites. The charged particles would remain in the radiation belts for an extended period of time, denying the use of space to friend and foe alike.⁷⁰

Countermeasures

Nuclear-driven EMP is omnidirectional, spraying large areas with damaging, broadband electromagnetic radiation. EMP created using more conventional technologies is characterized by directionality, relatively short range, and electromagnetic output centered in the damaging microwave frequencies. Arriving at light speed, the broadband nature of EMP makes it extremely difficult and expensive to defend against.⁷¹ Thus, the primary countermeasure for EMP weapons is electromagnetic shielding. Shielding must be provided separately against the electric and magnetic field components of EMP and it must take into account the broadband nature of the pulse. Since a great range of frequencies are present in EMP, the designer must shield against low, medium, and high frequencies. The designer must also install protective electrical filters wherever an electrically conductive channel enters electrical systems (e.g., power cables, transmission lines, antenna inputs, etc.). Since filters perform differently at different electrical frequencies, this is a difficult task.⁷² A single mistake in grounding, filter design, or shielding geometry is enough to provide entry for damaging amounts of EMP, especially in high-speed computer circuitry. This suggests the appropriate counter countermeasure. The antagonist need only break a few electrical grounds, shift the output spectrum of his EMP attack, or penetrate the shielding at a few critical points to render this countermeasure worthless. Once the energy from an EMP effect has entered a region's power grid, communications grid, or computer grid, the entire network can be disrupted for a period of time or even destroyed.

Evaluation

Due to its indiscriminate nature, nuclear-driven EMP is only appropriate in total war scenarios (zero flexibility). The conventional EMP weapon, on the other hand, shows more flexibility in that it could be directional and its effects could be localized. Both forms of EMP weapons are at least moderate in their timeliness and responsiveness, since an EMP "bomb" could potentially reach its target within 30 minutes after launch (by means of a delivery vehicle similar to the modern ICBM). The precision of the EMP weapon

is relatively low—it is generally useful only for area targets (e.g., enemy towns, large facilities, or a squadron of enemy aircraft). The survivability and reliability of EMP weapons are moderate to high, particularly if the weapons themselves are ground based (as the payload of an ICBM or surface launched ballistic missile [SLBM]). Finally, and most unfortunately, the selective lethality of EMP weapons is low. The effect of an EMP burst on any given electrical system is highly unpredictable, since it depends in great detail on the precise geometry of the engagement, the exact design of the electrical system under attack, and even the current state of the atmosphere. In sum, the conventional EMP weapon has very interesting possibilities as a potential future weapon. However, the currently unpredictable lethality, limited flexibility, and questionable precision make it unattractive as the primary component of a space-strike weapon system in 2025.

High-Power Microwave

A high-power microwave (HPMW) device also employs electromagnetic radiation as its weapon effect. Not as powerful as nuclear-driven EMP weapons, HPMW weapons create a narrower band of microwave electromagnetic radiation by coupling fast, high energy pulsed power supplies to specially designed microwave antenna arrays. Microwave frequencies (tens of megahertz to tens of gigahertz) are chosen for two reasons: the atmosphere is generally transparent to microwave radiation (all-weather capability) and modern electronics are particularly vulnerable to these frequencies. Unlike most EMP weapons, HPMW weapons produce beams defined by the shape and character of their microwave antenna array. HPMW beams are broader than those produced by NPBs and lasers, and this space-strike weapon system does not require extreme pointing and tracking accuracies (100 nanoradian stability and one meter target accuracy are adequate). HPMW weapons can be trained on a target for an extended period of time, provided the power supply and HPMW circuitry can withstand the internal currents. As a rough point of comparison, HPMW systems produce 100 - 1,000 times the output power of modern electronic warfare (EW) systems.⁷³

Capabilities

This light speed weapon can be understood as a microwave “floodlight” that bathes its targets in microwave radiation. More directional and controllable than EMP, the general effect of this weapon on electrical systems is well described in the section on EMP. Unlike conventional EW techniques, the effects of a HPMW weapon system usually persist long after the “floodlight” is turned off (depends on power level employed).⁷⁴

Laboratory experiments have revealed that modern commercial electronic devices can be disrupted when they receive microwave radiation at levels as low as microwatts/cm² to milliwatts/cm².⁷⁵ The more sensitive the circuit, the more vulnerable it is. While many electronic devices can be shielded using the same techniques outlined in the section on EMP weapons, most sensors and high-gain antennas cannot be shielded without preventing them from performing their primary functions.

HPMW weapons are inherently limited by the fundamental laws governing electromagnetic radiation. A space-based HPMW weapon must have an antenna or array of phased antennas with an area measured in acres to point and focus its beam properly on terrestrial targets. The resources necessary to construct such huge structures could be expensive to lift into orbit, and difficult to assemble in the free-fall environment. Like the NPB, the HPMW weapon is a line-of-sight device that must “see” its target before it can fire.

The level of pulsed, electrical power required to produce weapon-level microwave fluxes is now becoming available (for ground-based systems). Compact, scaleable laboratory sources of narrow-band, high-power microwaves have been demonstrated that can produce gigawatts of power for 10 to a few hundred nanoseconds. Ultrawideband microwave sources are less well developed, but research in this area appears promising.⁷⁶ A HPMW weapon should, however, be able to temporarily disrupt circuits and jam microwave communications at low-power levels.

A space-strike HPMW system would consist of a constellation of satellites with very large antennas or arrays of antennas. The farther out in space the constellation resides, the fewer the number of satellites required. However, there is a corresponding increased requirement for more power and larger antennas. Another possibility is to overlap “spot” beams from many smaller HPMW satellites on each target, gaining the benefit of high power on centroid (but a very much larger combined spot) at the cost of satellite proliferation. A useful distributed HPMW weapon system of this type might resemble the Iridium or

Teledesic constellations of LEO communication satellites (many tens to hundreds of satellites; however, the HPMWs would not be small satellites).

At low powers, the HPMW weapon system is fully capable of jamming communications when pointed at the opponent's receiving stations or platforms, in addition to its obvious uses against an enemy's electrical and electronic systems at higher power levels. Since water molecules are also known to absorb certain bands of microwave frequencies, it is also possible a properly designed HPMW weapon system could be used to modify terrestrial weather.

Countermeasures

Modern advances in microelectromechanical devices and nanotechnology could eventually result in devices and sensors so small that they are only a tiny fraction of a microwave wavelength in size. Minute devices, if small enough, could be immune to HPMW weapons simply because microwave frequencies cannot couple enough energy into them to cause damage. Advances in optical computing and photonic communications could also be a useful countermeasure. Optical devices are inherently immune to microwave radiation, although the sections of optical circuits where light is converted back into current would still have to be shielded. The countercountermeasures outlined in the section on EMP weapons are also useful for HPMW weapons.

Evaluation

The all-weather characteristics of the HPMW make it very attractive for a 2025 weapon. With a space-based version, this light-speed weapon would be high in timeliness and responsiveness. However, the flexibility and precision characteristics are similar to the nuclear EMP device—low. In addition, like the NPB, it is limited by line-of-sight restrictions. Moreover, its requirement for acres of antenna for each of the satellites required for a LEO constellation simply make it impractical. Finally, selective lethality is, like EMP, somewhat unpredictable. And by 2025, if nanotechnology is perfected and incorporated widely into electronic systems, this could negate much of the effects of a HPMW. Thus, the HPMW weapon system is not deemed suitable for space-force application in 2025.

Illusion

Sun Tzu said “all war is based on deception.”⁷⁷ Military commanders have always sought to hide their intentions, capabilities, and forces from their opponents. The most prominent modern example of deceptive techniques is stealth technology, which seeks to hide platforms from sensors by reducing the various sensor cross sections (i.e., radar, optical, infrared, acoustic, etc.). Modern advances in holographic technologies suggest another possibility: weapons that project false images to deceive the opponent.⁷⁸

Holograms are produced by scattering laser light or intense bursts of white light off objects and forming three-dimensional interference patterns. The information contained in the interference pattern is stored in a distributed form within solid emulsions or crystals for later projection with a source of light similar to that used to produce the interference pattern.⁷⁹

Capabilities

Full color holograms can only be produced with white light sources, and even the best modern white-light holograms are imperfect.⁸⁰ It is certainly possible to make holograms of troop concentrations, military platforms, or other useful objects, although the larger the scene the more difficult it is to produce the proper conditions to create a convincing hologram. No credible approach has been suggested for projecting holograms over long distances under real-world conditions, although the Massachusetts Institute of Technology’s Media Lab believes holographic color projection may be possible within 10 years.⁸¹ Holographic and other, less high-technology forms of illusion may become a potent tool in the hands of the information warriors (see the AF *2025* information warfare white papers).⁸²

Countermeasures

The best countermeasure for holographic illusions is the use of multiple sensor types. The most convincing optical illusion could easily be exposed by its lack of an appropriate infrared or radar signature. The likely proliferation of sensors and sensor types on the battlefield of 2025 makes the use of merely optical illusions a temporary expedient, at best. Nevertheless, considerable confusion could be created, at least

temporarily, by projecting false infrared signatures (platform exhausts) or radar signatures (missiles) or by concealing one type of platform within the illusion of another type (or of nothing at all— a form of camouflage).

Evaluation

Illusion weapons are and will probably continue to be too limited in the 2025 time frame. The flexibility is low, precision uncertain, survivability and reliability are low, and the selective lethality involves deception only. With the proliferation of sensor devices projected for 2025, the attempt at deception would likely be detected so quickly as to have little effect.

Projectile Weapons

Projectile weapons are most easily described by dividing them into two classes: ballistic missiles (BM) and kinetic-energy weapons (KEW). The ballistic missile is commonly used as a high-speed means of delivering a weapons payload over long distances with adequate precision to strategic targets. The kinetic-energy weapon works on the simple concept of delivering a mass at extremely high velocities to the target. The basic kill mechanism for a KEW is its kinetic energy (KE) as calculated by the simple formula $KE = 0.5 \times (\text{total mass}) \times (\text{velocity})^2$.⁸³ In general, the more kinetic energy delivered, the more damage done to the target. This places a premium on achieving high speeds, since the kinetic energy depends on the square of the weapon's velocity.

Projectile Weapons—Ballistic Missiles

Ballistic missiles are popular with many countries today due to their capability to deliver a payload to the country next door or to a country on the other side of the world. They can even be used to deliver satellites into space (Atlas and Titan IVs are popular in the US). Their fuel can be liquid or solid and they are fairly reliable. The guidance systems can use global positioning system (GPS) receivers or inertial navigation systems and US systems are known to be very precise (measured in feet). Finally there is a wide

range of possible payloads: nuclear warheads, chemical/biological devices, submunitions, solid masses, satellites, nonlethal payloads like foams or a debilitating gas, and so forth.

Capabilities

The modern ICBM/SLBMs are strategic weapons of deterrence. As such, they inevitably carry devastating nuclear payloads. However, this is not the only possibility. With a CEP already measured in feet, ballistic missiles (theater or intercontinental) could be configured to carry more conventional payloads.⁸⁴ The simplest useful payload is a solid tip (essentially a ton of cement in the nose). Few fixed targets could resist the sheer momentum of several tons of material delivered precisely at high speed from space. A simple variation on this approach replaces the solid tip with a high explosive charge. Equipped with the proper high speed fuse and possibly a shaped charge, this weapon could be very effective against many hardened facilities, especially shallowly buried bunkers or tunnels.

A ballistic missile could also be configured to carry a variety of submunitions. A reentry vehicle could be equipped with many long, dense rods that, when properly dispensed at high speed, would be excellent bunker busters. Alternatively, the reentry vehicle could contain hundreds or thousands of metal or ceramic flechettes (darts) designed to shred area targets such as enemy bases, weapon-making facilities, or threatening troop concentrations. The conventional EMP bombs described previously could be delivered to enemy C⁴I, air defense, and industrial facilities, disrupting or damaging all electronics without necessarily exacting a high cost in lives. Finally, a ballistic missile could be configured to deliver some form of nonlethal payload such as hardening foam, irritating gas, or foul smelling liquid.⁸⁵

As regional wars in the Middle East have recently demonstrated, it is also possible to deliver chemical and biological weapons (CBW) with ballistic missiles. These unsettling, but potentially very effective area weapons share several disadvantages with nuclear weapons. CBWs are condemned by most nations as cruel and unusual weapons. Preemptive use of these weapons certainly invites worldwide condemnation. CBW devices are also uncontrollable once released—the areas affected are denied to friend and foe. Worse yet, chemical and biological agents are spread uncontrollably by environmental and natural vectors (e.g., insects and animals). In their current form, CBW devices are decidedly not precision weapons.

Countermeasures

Ballistic missiles, whether theater or strategic in nature, are a particularly high-value target for space-strike laser weapon systems. Ballistic missiles spend tens to hundreds of seconds in the boost phase (theater ballistic missile [TBM] versus ICBM) followed by tens of seconds to tens of minutes in the postboost phase.⁸⁶ These missiles are easily detected by their plumes only during boost phase, the shortest phase of their trajectory. During this brief interval of vulnerability, a light-speed kill by a space-based or space-borne laser weapon system can settle the problem before it has the opportunity to deploy MIRVs (multiple independently targeted reentry vehicles). In general, ballistic missile countermeasures have been addressed in great detail by the Ballistic Missile Defense Organization. The solutions range from direct interception by high-speed rockets and missiles to airborne and ground based-high energy laser strikes.⁸⁷

The appropriate countercountermeasures are obvious. Stealthy reentry vehicles could be built that elude ground- and space-based sensors, although the designer would be forced to address optical, infrared, and multifrequency radar problems simultaneously. Alternatively, very small, very agile reentry vehicles that greatly complicate the problem of terminal defense could be designed.

Evaluation

Most of these missile-delivered weapons could be built today. All of the essential technologies, including precise delivery, are already available. The flexibility of the/a ballistic missile system is moderate, precision good, survivability may be tenuous in 2025, reliability is good, and selective lethality is limited with this system. Because of these limits on selective lethality and potential survivability problems, the ballistic missile will probably not be suitable for space force application in 2025.

Projectile Weapons—Kinetic Energy

This type of projectile weapon is closely related to the solid-tipped ballistic missile. Kinetic-energy weapons come in two classes related to their velocity—the Kinetic Energy Penetrator (KEP) and the Hydrodynamic Penetrator (HP).⁸⁸ The KEP has a maximum impact velocity of 3 kilofeet per second (kfps),

about the maximum speed of an SR-71 Blackbird. The KEP destroys the target by shattering it with an enormous blow. Since some areas of a target are more vulnerable to shattering blows than others, precise targeting is necessary for an effective KEP.

The HP has a minimum impact velocity of 8 kfps. When a penetrator strikes a target at this extreme velocity, both target and penetrator react to the collision as if they were fluids (their behavior described by hydrodynamic equations of motion). The impact attacks the molecular composition of the target, spreading dense impact shocks at enormous speed.

A nagging problem for KEW systems is the heat and shock generated on reentry. This can affect the precise delivery of the weapon. An exciting new concept has been proposed that promises to ameliorate this problem. By concentrating a laser beam in the area immediately in front of the hypervelocity KEW, it is possible to create a laser-supported detonation wave (called an “air spike”) that partially shields the KEW. The air spike transforms the normal conical bow shock into a much weaker, parabolic-shaped oblique shock.⁸⁹ Researchers estimate that a properly designed air spike could decrease the effects of shock and heat on a hypervelocity object by over 75 percent (making Mach 25 seem like Mach 3).

Researchers have also experimented with enhancers for the two basic classes of KEW. Pyrophoric compounds might be added to increase lethality by generating intense heat. Provided extremely high-speed fuses could be developed, explosive charges might be added to increase the weapon’s ability to penetrate the target’s outer shell. The dense rods or flechettes mentioned above as submunitions for ballistic missiles might also be used by a KEW to increase its area of effect, provided the submunitions could be dispersed properly at these enormous velocities. It has been suggested that low-speed submunitions or dispersed EMP bombs might be used to help the KEW penetrator overcome defensive systems and reach the target.⁹⁰

The high velocities needed by KEW systems can be generated chemically (by rockets) or electromagnetically (by the “rail-gun”). The rail-gun consists of a long, usually evacuated, tube containing electrically conducting rails and surrounded by high-power electromagnets.⁹¹ The projectile is the only moving part. The projectile is placed on the rail and a large current is generated within the rail and the projectile. Simultaneously, time-varying magnetic fields are induced in the magnets with powerful pulsed power supplies. The resulting electromagnetic force rapidly accelerates the projectile to extreme velocities. Rail-guns are being actively studied by the US military, although to date researchers have only been able to

accelerate small masses to hypervelocity. Velocities achieved 20 years ago have not been exceeded to this day. Navy technologists report that their main problem lies in developing small, high-power, stress-resistant power supplies.⁹²

Finally, an interesting variation on the HP concept involves the use of meteorites as a weapon.⁹³ Naturally occurring meteorites at least the size of large houses (necessary to survive drag-induced heating in the atmosphere) could be intercepted in space and redirected to a terrestrial target. If done with sufficient stealth and subtlety, the impact could even be “plausibly denied” as a natural occurrence. Meteorites 30 feet in diameter could be counted on to generate nuclear weapon-size explosions (20 kilotons), but without the lingering radiation.⁹⁴

Capabilities

The capabilities of a kinetic-energy projectile would be similar to the better known precision guided missiles (PGMs). The kinetic-energy projectile would most likely be a PGM without explosives, but which travels so fast it can take out surfaces as well as targets buried hundreds of feet underground. Moreover, the kinetic-energy projectile can take out single targets or area targets (using hundreds of flechettes or rods). Besides precision, perhaps its most attractive capability is that it is an all-weather weapon. Finally, KEW are versatile in that they could be safely launched from the US and find their targets anywhere in the world within 30 minutes or they could reside in relatively small satellites (storage containers) in LEO waiting to be dispensed and reach their target within a few minutes. These rather simplistic satellites could easily be integrated with the global information network (GIN), the “utilities,” and a command and control system.

Meteors can be hundreds of magnitudes more deadly than KEW. However, there are several significant shortfalls to meteorites as weapons. They are hardly a timely weapon— the war fighter must patiently wait for nature to deliver his “ammunition.” The uneven shape and heterogeneous composition of meteorites makes it highly unlikely they can be guided precisely to a target. Since it is also impossible to predict how much of the meteorite will survive the fall from space, meteors are best classified as area weapons with a very uncertain radius of effect.

Countermeasures

The countermeasures against KEWs are basically the same as for ballistic missiles, except that the KEWs are envisioned to be considerably smaller. Thus, they would be more difficult, if not impossible, to attack once they begin their descent from space. The countermeasure would best be applied against the KEW delivery platform be it a small satellite, a TAV, or some sort of pod.

If the KEW uses GPS for terminal guidance, it may be possible to jam the GPS signal. This may be especially effective for protecting mobile targets (the KEW GPS receiver would require real-time updates to hit these mobile targets). However, this would do nothing to prevent the use of KEWs that work strictly on trajectory or an internal guidance and targeting system against static targets.

Evaluation

Meteors, as a weapon, are impractical, even in 2025. Of course, since KEW technology is available today, it will certainly be even more precise and deadly in 2025. A few hundred KEW “storage containers” placed in a LEO would make the timeliness and responsiveness very high (within a few minutes). Precision and reliability would also be high. However, the flexibility and selective lethality would be low—total destruction would be the only choice, unless used as a demonstration of power. Thus, the KEW would not be the ideal weapon of 2025. Due to its all-weather capability, however, it would be a good complement to some other weapon capability.

Space Sortie—Transatmospheric Vehicle

There are numerous single-stage-to-orbit (SSTO) vehicle concepts under active study that should result in development of a TAV. These TAV concepts, sometimes referred to as reusable launch vehicles (RLVs), are plausible enough that McDonnell/Boeing, Lockheed/Martin, and Rockwell are all investigating proprietary concepts. Both the Rockwell and Lockheed/Martin RLV concepts are vertical take-off/horizontal landing, have longitudinal payload bays (like the shuttle), and are being designed for commercial payloads. The McDonnell Douglas/Boeing RLV concept is similar except it is a vertical take-off/vertical landing.⁹⁵ The US Government (USAF, NASA) is in partnership with McDonnell/Boeing, Lockheed/Martin, and

Rockwell to develop a military/commercial version currently called the X-33. They expect to fly the X-33 RLV in 1999.⁹⁶ The McDonnell Douglas/Boeing RLV is a vertical take-off/landing system with eight rocket engines. It navigates using GPS, will use 200-foot pads instead of runways, and is designed for low maintenance and infrastructure. Development costs are expected to be about the same as a new commercial airliner (Boeing 777).⁹⁷

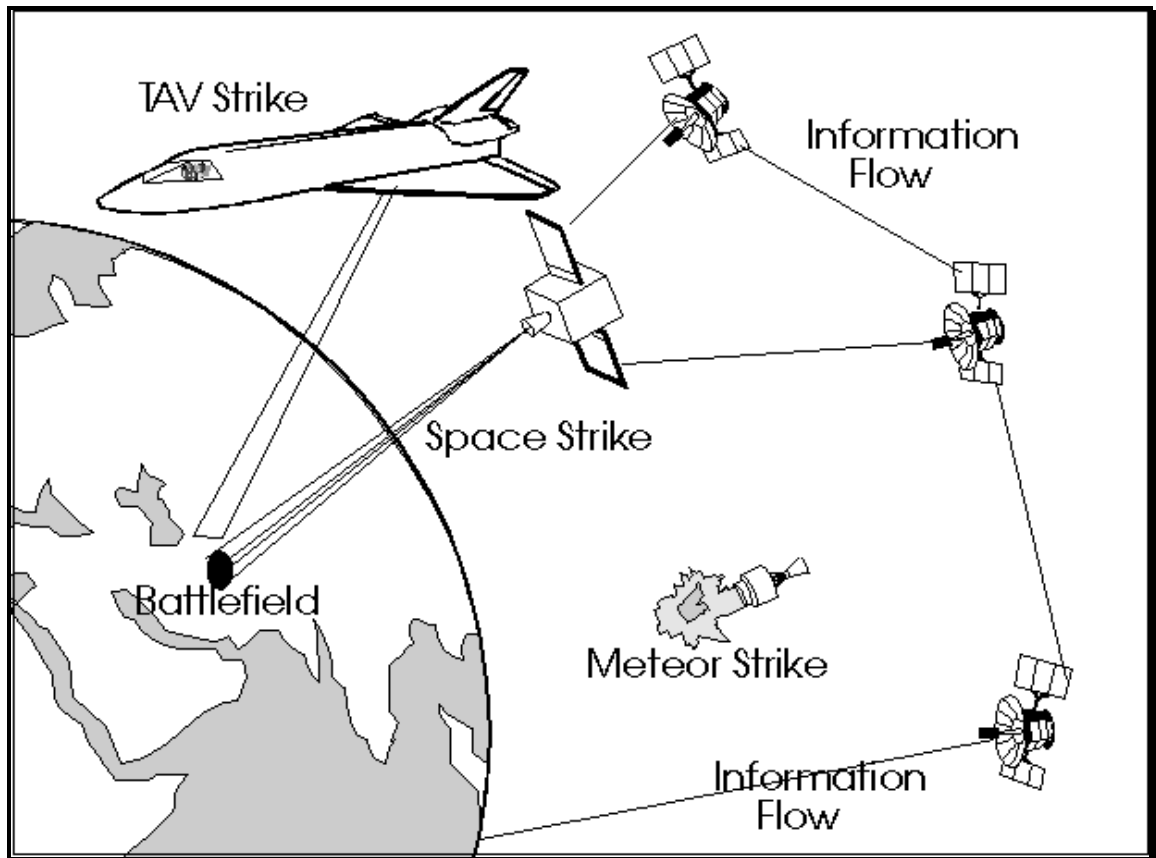

Figure 3-3. The TAV in its Native Environment

Whichever concept the US government and industry decide to pursue, a revolution must occur in TAV engine technology before it becomes viable.⁹⁸ Conventional rockets have low dry weight (without fuel) and high gross take-off weight (lots of fuel and oxygen) to reach the Mach 25 speeds necessary to reach space. Rockets give up maneuverability and ease of handling in the atmosphere by being so configured. Air breathers, on the other hand, have high dry weight and low take-off weight because they use the oxygen in the atmosphere as part of their fuel. They have great maneuverability, but have considerably lower top speeds.

Furthermore, the major costs of a TAV are its dry weight components. Fuel, although relatively inexpensive, consumes 80+ percent of the total gross weight, leaving only 3-6 percent for cargo. The 2025 TAV must have moderate dry weight and gross weight, which may be obtained using a combination of rocket and air-breathing technology called a rocket-based combined cycle air-augmentation.⁹⁹ This will require a revolution in rocket technology. But three pieces of this revolution will very likely be available by 2025.

The first piece of the revolution deals with the advanced technology “pulse detonation wave” combustion process in a rocket instead of the conventional “constant volume combustion” process. Researchers believe this technology would increase the pressure during detonation by 20 to 40 times and significantly increase the specific impulse (I_{sp}) of the fuel. More importantly, it will decrease (by 20 to 40 times) the pressure, heating, and wear and tear on the fuel turbine-feed pumps that are the cost, reliability, and safety concerns of rocket engines.¹⁰⁰ Thus, rocket engines could be made cheaper, smaller, and more reliable by orders of magnitude. Rocketdyne and Adroit have both been working aggressively in this area.

The second piece of the revolution concerns the “air augmentation” portion of the engine. The leading concept involves wrapping sheet metal with an inlet around the base of the engine. This technique, properly applied, should “squeeze” every bit of oxygen possible out of the “sensible atmosphere” and make it available as part of the fuel. This would make the air-breathing part of the engine useful at altitudes of up to 120,000-140,000 feet and increase the thrust by 300 percent. This alone could double the payload.¹⁰¹

The final piece deals with the combustor in the air-breathing portion of the engine. The combustor creates the highest pressure in the engine as the fuel mixes with oxygen, burns, and then provides thrust. As speed increases, between one-third and one-half of the thrust comes not from the fuel, but from the heat and pressure within the engine. Under these conditions, the fuel is not efficient and energy losses increase dramatically, heat increases, and sheer stresses increase resulting in lower final speeds. However, a revolutionary premix, shock-enhanced (oblique standing detonation wave) combustion engine could increase the I_{sp} by 30 percent. This would allow the combustor to be reduced in length by 75 percent, thus decreasing the weight of the engine significantly.¹⁰²

The final design entails placing the rocket engine inside the air breather. At low Mach speeds, the air breather would be used alone. At Mach 15 to 20 during pull up to space, the rocket would light up and pressurize the air breather, keep burning atmospheric oxygen (would not have to carry nearly as much), and

create a synergistic effect using both the rocket and the air breather. The result could be a highly efficient, viable engine for the 2025 TAV.

Lightweight structures are another must for the 2025 TAV. Dr Dennis Bushnell, Chief Scientist for NASA at Langley, Virginia, reported that the Japanese are working on a Carbon-60 (Fullerene) material that is lightweight, but is an order of magnitude stronger than the most modern of composites. He also stated that advances in static stability will help the TAV of 2025.¹⁰³ Currently, spent uranium is placed in the nose of vehicles for ballast (keeps center of gravity forward of center of pressure to prevent tumbling); researchers, however, are investigating placing “longitudinal vortices” and using active controls to maintain this positive stability instead of weights. This would allow designers to move things around for efficiency without worrying as much about the center of gravity. Finally, Dr Bushnell reported that the Navy is aggressively researching “designer aerodynamics” and circulation control of air-breathing vehicles. With sensors and actuators, this could give the TAV “bird-like flight” characteristics. Thus, it truly could become an airplane and a space plane.¹⁰⁴

In addition, the 2025 TAV should be easily upgradeable as technology improves. We must not produce a TAV that will become obsolete and difficult to maintain even as we are trying to build it. Modularity of design will be important. For example, as guidance system technology is improved and further miniaturized, maintenance workers can expect to pull out a “black guidance box” and replace it with a new, improved version (lighter, less volume).

Finally, all the systems of the TAV must be integrated with all the other systems that interface with it. On-board (guidance, maneuvering) and off-board (surveillance, some processing) systems must all work together as a distributed “system-of-systems.”

Capabilities

The TAV “fleet” of 2025 will possess incredible capabilities. The TAVs will have highly efficient, reliable engines that perform equally well in the atmosphere or in space; the TAV structures will be made of strong, lightweight composites that are easily replaceable; and the payload capability (weight and volume) will be versatile and adaptable to many different types of payloads and missions. Commercial carriers will

exist that are capable of lifting 20,000 to 40,000 pounds into LEO.¹⁰⁵ The Black Horse TAV concept calls for a payload of approximately 5,000 pounds into a LEO (although some critics believe that due to design flaws, it cannot take any payload into orbit),¹⁰⁶ whereas the X-33 concept proposes a payload of 10,000 pounds (polar orbit) to 20,000 pounds (eastern LEO).¹⁰⁷ The military requirement will probably be in the 10,000 to 20,000 pound range. A versatile TAV should certainly be able to carry payloads for at least three basic missions: 1) to deploy/retrieve small to medium satellites (large satellites are “dinosaurs”) for many, although not all, missions; the trend is towards small/microsatellites; thus, all of the TAV concepts should suffice for low and medium earth orbit missions; 2) to carry a small team of special operations forces along with their operational gear to crisis spots throughout the world (TAVs would probably need a 2,000 pound capacity to carry four-man teams¹⁰⁸); and 3) to perform as a sensor and weapon platform (for short periods of time analogous to aircraft sorties).

The satellite deployment/recovery capability could be critical for fielding or reconstituting space-based components of weapon systems in 2025. In fact, using a “Pop-up” flight profile (see fig. 3-4), the TAV could potentially launch multiple satellites and grant access to all orbits (e.g., LEO, Polar, Sun Synchronous, Molniya, geosynchronous earth orbit (GEO)). In an eastern LEO, the TAV would be able to deploy 15 1,000-pound small satellites and pick up four to bring back. It could deploy as many as four satellites to a GEO orbit.¹⁰⁹ This capability should make the TAV extremely flexible for space-force applications.

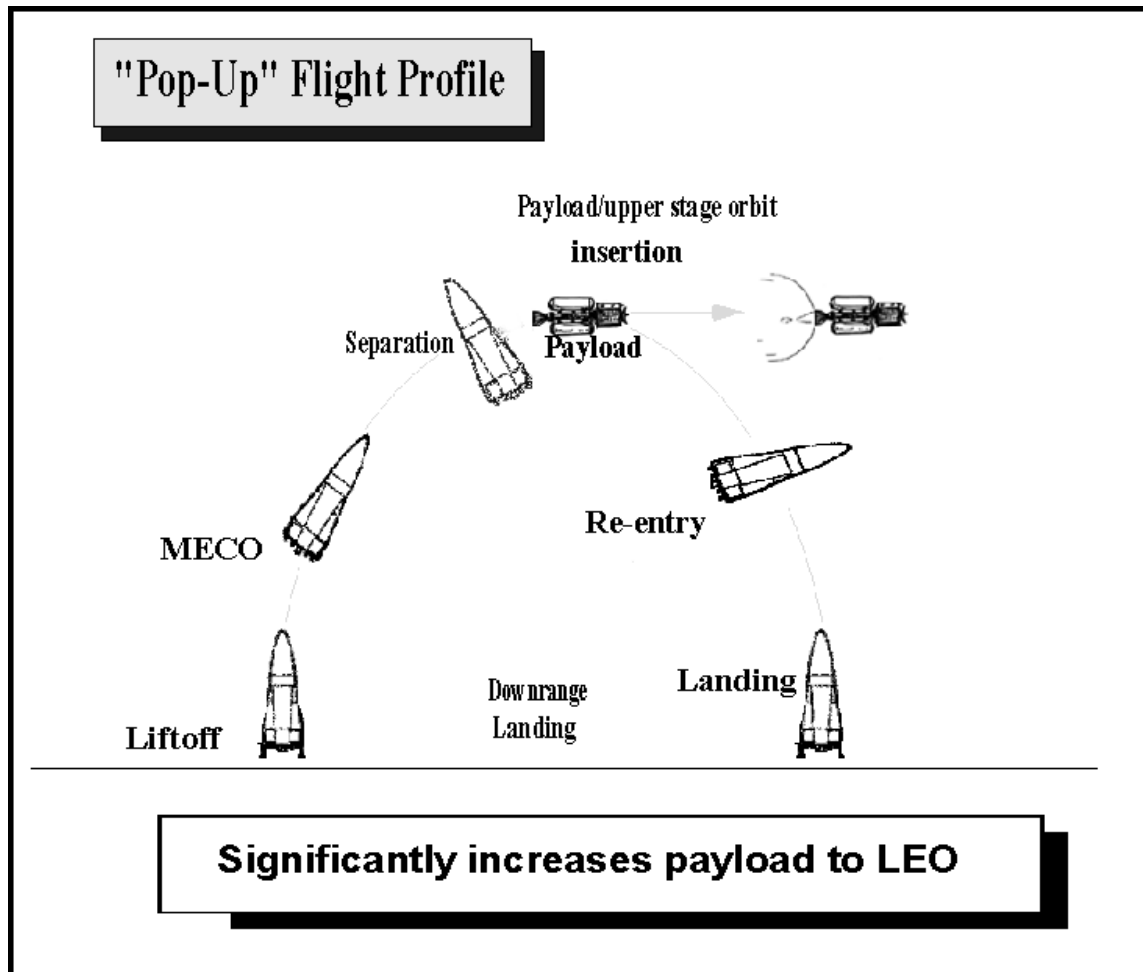

Significantly increases payload to LEO

Source: Briefing, Phillips Laboratory PL/VT-X, "Military Spaceplane Technology and Applications," January 1996

Figure 3-4. Pop-Up Maneuver

Other necessary capabilities/requirements for a TAV-type vehicle include all-weather performance, rapid call-up time, short turn-around time, long service life, low-maintenance engines, vibration-resistant systems and structures (to survive reentry and "hypercruise" speeds near Mach 25), all azimuth earth access, global range of operation, and the ability to be upgraded easily and inexpensively.¹¹⁰ The requirements for all azimuth access and global range of operation mean that the TAV will probably need refueling capability. A study by W. J. Schaeffer Associates (4 February 1994) on the feasibility of an aeri ally refueled "spaceplane" concluded this capability "appears feasible and practical."¹¹¹ Refueling could occur in the atmosphere or in space. Call-up times on the order of a few hours and turn-around times of from six hours

(emergency) to 24 hours (routine) will probably be required.¹¹² More importantly, the TAV of 2025, once launched, will reach anywhere in the world within 60 minutes or less. Of the 60 minutes required, approximately 20 minutes would be from launch to space plus another 40 minutes to the target area (a TAV could be over the most likely target areas after only 20-30 minutes in space).¹¹³ The 2025 TAV could also deliver multiple payloads (e.g., laser, KEW, reconnaissance, satellites, strike team, ASAT weapon, etc.) depending on the mission.

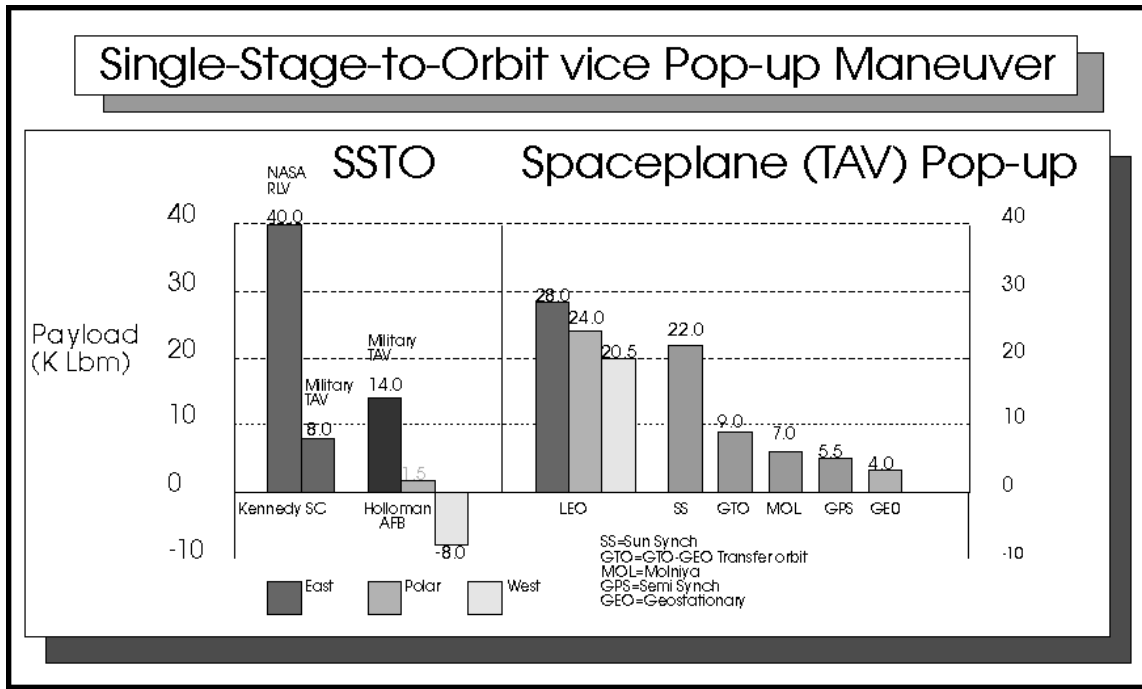

Source: Briefing, Phillips Laboratory PL/VT-X, "Military Spaceplane Technology and Applications," January 1996

Figure 3-5. Pop-Up Enables Flexible Transpace Operations

Countermeasures

Like aircraft, TAVs are naturally vulnerable on the ground and would need protection. Moreover, TAVs emit a variety of easily detected signatures (e.g., radar, enhanced infrared due to high-speed passage through the atmosphere, and acoustic) and are also vulnerable to attack during launch and landing. TAV launch facilities could be safely located in the continental United States (CONUS) but if a team of "space marines" must be landed outside the CONUS, the TAV and its payload would be vulnerable to a variety of weapons (space-based, airborne, or terrestrial) and tactics. Fortunately, a force of three or four TAVs (analogous to a

flight of modern combat aircraft in tactical formation) could be extremely difficult to attack if at least one is used as protection for the others. Another consideration is that, during conflict, any US spacecraft (particularly if it is a manned platform) would instantly become a high-value, high-priority target. Thus, ASAT-type weapons could be directed against a TAV in endo- or exo-atmospheric flight. However, the highly maneuverable TAV, if configured to carry high-speed precision weapons onboard, could itself become an “anti-ASAT” weapon—the attacking ASAT would then become the target.

Evaluation

Flexibility, provided by its ability to put human judgment at the developing crisis location rapidly, is the greatest asset of the TAV. Responsiveness and timeliness, while not in the same class as space-based light-speed weapons, are at least moderate (hours for call up followed by 60 minutes maximum flight time). Since a TAV could carry a broad range of payloads (e.g., many different types of weapons, a special forces unit, or even limited space maintenance and repair facilities), it rates high in precision, survivability, and selective lethality. Reliability as a weapon system for force-application or space-control missions (see AF 2025 counterspace white paper) could be very high, since the TAV could launch active radar or inertially- uided weapons (such as KEW devices) through weather conditions that would baffle directed-energy weapons, provided the developmental problems that have plagued spaceplanes can indeed be solved.¹¹⁴ When not needed as a weapon system, the TAV could “earn its keep” through a variety of useful, nonbelligerent missions such as rapid replenishment/repair of small satellites, high-value airborne/spaceborne surveillance and reconnaissance sortie, emergency clandestine low probability of intercept (LPI) communications or command and control link, or (properly configured) even as a truly high-speed airborne warning and control system (AWACS)/joint surveillance, tracking, and radar system (JSTARS) platform. A small fleet of TAVs would be a highly flexible, adequately responsive component of an effective space-strike system in 2025.

Summary —The System-of-Systems

A careful evaluation of the weapon systems discussed in this chapter leads us to eliminate most candidate systems based on the desired capabilities of timeliness, responsiveness, flexibility, precision,

survivability, reliability, and selective lethality. A summary of the evaluation can be found in table 1, where the following potential weapon systems are listed: the distributed laser (DL) (e.g., earth-based laser or space-based mirror), the space-based laser (SBL), the TAV itself, the space-based HPM, the EMP weapon (as a small, conventionally triggered bomb only), the hypervelocity KEW (as a payload on a TAV), other projectile weapons (ballistic missile payloads or BM), space-based NPB, and the “illusion weapon” concept (ILL). Each potential system’s “score” against a desired capability is given as high, medium, or low.

Table 1

Summary Evaluation of Potential Weapon Systems

	DL	SBL	TAV	HPM	EMP	KEW	BM	NPB	ILL
TIMELINESS	HIGH	HIGH	MED	HIGH	MED	MED	MED	MED	HIGH
RESPONSIVENESS	HIGH	HIGH	MED	HIGH	MED	MED	MED	MED	HIGH
FLEXIBILITY	HIGH	HIGH	HIGH	HIGH	HIGH	LOW	MED	LOW	MED
PRECISION	HIGH	HIGH	HIGH	LOW	MED	HIGH	HIGH	HIGH	MED
SURVIVABILITY	MED	LOW	HIGH	LOW	HIGH	MED	HIGH	LOW	MED
RELIABILITY	MED	MED	MED	MED	MED	HIGH	HIGH	MED	LOW
SELECTIVE LETHALITY	HIGH	HIGH	HIGH	MED	MED	LOW	MED	MED	LOW

Large space-based weapon platforms are eliminated because they are not considered to be survivable in 2025 or practical in terms of weight, cost, size and in most cases power requirements (incoherent light, NPB, HPMW weapons). EMP weapons are eliminated because they lack flexibility, are not precise enough to limit collateral damage, and their selective lethality is at best questionable. Projectile weapons, while very precise, are eliminated because they are not considered to be highly flexible or capable of providing selective lethality. ILLs are ruled out because they do not provide the redundant signatures (e.g., optical, infrared, radar, and so on) that would make them sufficiently believable and because these notional weapons, too, do not provide selective lethality.

As we carefully studied the characteristics and capabilities of the various candidate weapon systems, it became evident there was no one “super weapon system” that could do all the things the US government

would require in 2025. This is not a surprising conclusion—earth-based weapon systems have always complemented each other. We call the weapon system-of-systems that best addresses the US government’s likely requirements in 2025 and incorporates an optimum mix of desirable capabilities the *Global Area Strike System (GLASS)*. GLASS consists of: 1) a directed-energy weapon (DEW) system based on the continuous wave laser described previously, and 2) a TAV system (manned or unmanned), which will be used primarily as a weapons platform. The DEW system is composed of powerful earth-based lasers that “bounce” their high-energy laser beams off of space-based mirrors to reach the target. The desired TAV is a flexible platform capable of employing compact, onboard DEWs and KEWs when the space-based mirrors are out of range, disabled, or otherwise unavailable for use. The TAV can also deliver KEWs to mobile or stationary targets; drop special operations strike teams to any hotspot in the world; carry EMP bombs, jamming devices, or a myriad of more conventional weapons; and carry small satellites into space or retrieve them from orbit. Perhaps most significantly, the TAV can also be used to sustain and maintain the GLASS constellation of space-based mirrors.

What would the GLASS system of systems look like? The DEW system would consist of a distributed complex of earth-based lasers (located in the CONUS) that direct their beams (continuously variable in output power) to a constellation of adaptive, space-based mirrors (10 - 20 meter diameter depending on the laser wavelength and spot size desired at the target). The mirrors would have moveable covers to protect their surfaces when they are not in use, solar cells and/or chemical fuels for prime power (with small, efficient batteries for backup), an advanced pointing and tracking system, an on-orbit attitude control and maneuvering system and adaptive beam-sensing and control system (a more capable version of today’s Guide Star technology), and a communications package for C³ and for linking with the global information network described in appendix B. The mirrors would be placed in one or more low earth orbits (250 - 500 nm) to reduce the target range, thereby minimizing the amount of laser power required to accomplish the mission and decreasing the pointing and tracking requirements. The use of a number of different orbits and inclinations might be necessary to increase the survivability and operational availability of GLASS. According to reputable studies, at least 24 - 32 orbiting platforms would be needed to ensure reasonable global access.¹¹⁵ However, the requirement for near instantaneous response could drive the size of the space-based

constellation to over one 100 mirrors. Obviously, the actual size of the constellation of mirrors must be determined by a detailed technical analysis beyond the scope of this white paper.

Capabilities

The capabilities previously discussed separately for the laser, the KEW, and the TAV apply to the GLASS. It will be able to perform strategic, operational, and possibly tactical missions. All of these will involve targeting and applying force to both static and mobile targets. The effects on and types of targets for the lasers, the KEWs, and other possible weapons (using the TAV as a platform) were discussed at length earlier in chapter 3.

It is important to note that the laser and/or TAV (with KEWs/other weapons) give the GLASS a full range of lethality—from temporary denial and disruption to partial damage to complete destruction (as described in the sections on the laser and KEW weapons). The laser provides near instantaneous response time, a light-speed attack that negates all conceivable forms of active defense, and the ability to strike anywhere on the planet. The requirement for a global, all-weather strike capability might be met by using a different laser wave length to “burn” a hole through clouds, smoke, or aerosols (using the same mirror or a different one) or by employing alternative weather-control techniques before striking for effect. With a well-designed, distributed laser network based in the CONUS, there should always be several ground-based lasers with clear enough skies to fire. However, when times arise when it is impossible to use the laser (e.g., when the target itself is “weathered in”), the TAV will be able to respond to crises on short notice (2 - 6 hours depending on container package required), putting human judgment and human adaptability “on site” as needed.

In the world of 2025, the GLASS can become America’s “forward presence without forward basing.” This system-of-systems can be used to extend America’s eyes and fists around the globe in near real-time while minimizing the need for vulnerable overseas infrastructure and forward deployment of personnel. The GLASS can be global power and global awareness all in one package, and without actually placing any weapons in orbit (TAVs carry weapons *through* space in a manner entirely analogous to the modern ICBM).

The GLASS is a powerful concept, but it cannot function independently. Both the DEW and TAV-mounted KEW will require real-time external handoff of precise target location (and possibly target

characteristics); a credible “identification - friend or foe” (IFF) capability; and a secure command and control system. The DEW will also require real-time information on battlefield, atmospheric, and space weather conditions that could affect beam propagation and target coupling. Beam-control systems with submicroradian pointing and tracking accuracies with active satellite vibration and thermal control systems for space-based platforms will also be needed. Powerful SAT/BDA with onboard processing systems will be essential to acquire and track mobile targets. The TAV will also require real-time information on battlefield conditions (especially to avoid fratricide and “friendly” kills). When the TAV-mounted KEW is used, it will require hypervelocity flight control, high-g and high-temperature flight hardening, and smart fusing. A method for maintaining tracking and control during the terminal phase despite the sheath of hot, shocked gas surrounding the reentry projectile may also be required.

To fully exploit the global omnipresence of sensors and the proliferation of sensor types in 2025, the SAT/BDA system should be given near real-time access to the global surveillance and reconnaissance and communication systems. The ability to receive and interpret other views of the target will greatly enhance the mission success rate, and might prove to be the enabling capability for some weapon concepts.

Countermeasures

The countermeasures previously discussed in this chapter for the coherent light laser and the TAV still apply when they are employed separately to engage targets. However, when employed as a system, the enemy would have to target the ground-based lasers (virtually all of them) and the TAV launch sites (again, nearly all of them) to disable GLASS—a daunting task when you realize that most of GLASS’s components are based in the CONUS. If the enemy only attacked a few space-based mirrors or a few TAVs, the remaining CONUS-based TAV fleet could quickly (within a day) reconstitute a significant portion of GLASS’s constellation of orbiting mirrors. Moreover, the enemy must remember that these two components of the GLASS, the laser and the TAV, are also very robust. That is, not only can they apply force upon the enemy, they can protect each other. The laser can hit targets, in space or on earth, that threaten the TAV launch sites, the ground-based lasers, or the mirrors, and the TAV can likewise respond to these same threats, but with more flexibility (launched quickly into any orbit with a wide variety of weapons).

Weather and atmospheric conditions will always be a concern for the GLASS. As stated before, the laser can be blocked or at least degraded by cloud cover. The weather modification concepts discussed in the associated AF *2025* white paper may therefore be needed to provide all-weather, space-strike capability.¹¹⁶

The cost of the GLASS is a large concern. Space systems are inherently expensive due to the high cost of space lift and the difficulty of designing and building systems to operate for long periods of time in the hostile space environment. Moreover, projecting what a system will cost 30 years in the future is quite risky (especially using technologies yet to be developed) —planners have not had great success in projecting system costs accurately even two to five years in the future.

McDonnell/Boeing claims that the cost of developing a TAV system would be the same as the development cost of the Boeing 777—about \$5 billion. This estimate may be close, considering that a Boeing 777 has about 80,000 parts, whereas a TAV, although operating in space, would only have about 30,000 parts.¹¹⁷ The cost to produce a single TAV would probably be similar to the cost to produce a B-2 bomber—\$750 million to \$1 billion. However, if the government does not drastically improve its cumbersome acquisition process, these costs could rise dramatically in the coming decades. Fortunately, with the many space mirrors and the fleet of TAVs required by GLASS, and the hundreds (if not thousands) of satellites proposed both in other AF *2025* white papers and in advertised commercial space systems (Iridium, Teledesic), government and industry should be able to develop stable production lines that produce relatively inexpensive, identical satellites vice the large, hand-built, unique satellites of today. The US must certainly keep an assembly line (both commercial and military) going for production of the TAV. America's TAV must not become merely an advanced version of the Space Shuttle—available in small numbers at astronomical cost and with limited usability.

The cost of a directed-energy weapon system that includes ground-based continuous wave laser stations and a constellation of space-based mirrors is more difficult to project since there is no present space-based weapon system to use as a baseline. The USAF is currently developing an airborne laser system (ABL) as a boost-phase ballistic missile defense system. The USAF expects to spend approximately \$5 billion to design, test, and field a small number of operational airborne laser systems.¹¹⁸ Development costs alone for a distributed system with a space-based element (the mirrors) would be at least as great as this.

The likely cost of some individual components of the DEW element of the GLASS can also be forecast. A high-quality, properly figured and polished laser mirror about 15 to 20 meters in diameter will cost between \$20 and \$30 million for the substrate alone (coatings will cost more). The total cost of the support structure and mirror will be in the range of \$60 to \$90 million. Provided the technological challenge of power scaling for solid-state and/or diode lasers can be met, the cost of a single ground station including a megawatt-class laser and its associated infrastructure will be on the order of approximately \$100 to \$200 million (USAF experts forecast the cost of a 100 megawatt chemical laser alone at \$50 to \$100 million).¹¹⁹

Notes

¹ CDR Clarence E. Carter, et al., "The 'Man in the Chair' - Cornerstone of Global Battlespace Dominance," AF *2025* Study (Maxwell AFB, Ala.: Air War College, 1996); Lt Col Edward F. Murphy, et al., "Information Operations: Wisdom Warfare for *2025*," AF *2025* Study (Maxwell AFB, Ala.: Air War College, 1996); Lt Col William Osborne, et al., "Information Operations: A New Warfighting Capability," AF *2025* Study (Maxwell AFB, Ala.: Air War College, 1996); and Maj Michael J. Tiernan, et al., "In-Time Information Integration System (I³S)," AF *2025* Study (Maxwell AFB, Ala.: Air War College, 1996).

² *2025* concept, no. 900610, "Hoversatt," *2025* concepts database (Maxwell AFB, Ala.: Air War College/*2025*, 1996).

³ *2025* concept, no. 900338, "Stealth Technology," *2025* concepts database (Maxwell AFB, Ala.: Air War College/*2025*, 1996).

⁴ Lt Col Henry Baird, et al., "Spacelift - Integration of Aerospace Core Competencies," AF *2025* study (Maxwell AFB, Ala.: Air War College, 1996).

⁵ US GAO Report, "Ballistic Missile Defense - Information on Directed Energy Programs for FY 1985 Through 1993" (Washington, D.C.: Government publication, GAO/NSIAD-93-182, June 1993), 13.

⁶ Personal interview with Dr. M. Yarymovitch, 7 February 1996.

⁷ *Spacecast 2020*, "Refueled Transatmospheric Vehicle" (Maxwell AFB, Ala.: Air University Press, 1994), H-1.

⁸ *2025* concept, no. 900046, "Space Marine Operational Theater," *2025* concepts database (Maxwell AFB, Ala.: Air War College/*2025*, 1996); *2025* concept, no. 900202, "Space-based Special Operations Forces," *2025* concepts database (Maxwell AFB, Ala.: Air War College/*2025*, 1996); *2025* concept, no. 900696, "Global, Rapid Response Space Sortie," *2025* concepts database (Maxwell AFB, Ala.: Air War College/*2025*, 1996); *2025* concept, no. 900265, "Space Storage Modules To Establish Space-sourced Air Drop Capability," *2025* concepts database (Maxwell AFB, Ala.: Air War College/*2025*, 1996); *2025* concept, no. 900654, "Parts Locker," *2025* concepts database (Maxwell AFB, Ala.: Air War College/*2025*, 1996).

⁹ Briefing, subject: "Military Spaceplane Technology and Applications," January 1996, Phillips Laboratory PL/VT-X Slide 17.

¹⁰ Lt Col Edward F. Murphy, et al., "Information Operations: Wisdom Warfare for *2025*," AF *2025* Study (Maxwell AFB, Ala.: Air War College, 1996); and Lt Col William Osborne et al., "Information Operations: A New Warfighting Capability," AF *2025* Study (Maxwell AFB, Ala.: Air War College, 1996).

¹¹ Robert C. Weast, Editor-in-chief, *Handbook of Chemistry and Physics*, Boca Raton, Fla.: CRC Press, Inc., 1984), F-162.

¹² **2025** concept, no. 900163, “Solar Energy Weapon,” **2025** concepts database (Maxwell AFB, Ala.: Air War College/**2025**, 1996).

¹³ *Spacecast 2020* “Force Application” (Maxwell AFB, Ala.: Air University Press, 1994), O-18.

¹⁴ Personal observations made one of this paper’s authors at the Litton-Itek Corporation and the University of Arizona in March 1992 and February 1993.

¹⁵ Personal interview with Dr M. Yarymovitch, 7 February 1996.

¹⁶ Information obtained from senior DOD professionals speaking to the Air War College under the promise of nonattribution.

¹⁷ Lt Col Brad Shields, et al., “Weather as a Force Multiplier - Owning the Weather in **2025**,” AF **2025** Study (Maxwell AFB, Ala.: Air War College, 1996).

¹⁸ *Spacecast 2020*, “Force Application” (Maxwell AFB, Ala.: Air University Press, 1994), O-18.

¹⁹ **2025** concept, no. 900181, “Blackhorse Type Outer Atmosphere Low Orbit Vehicle,” **2025** concepts database (Maxwell AFB, Ala.: Air War College/**2025**, 1996); **2025** concept, no. 200018, “Space-Based Laser Designator,” **2025** concepts database (Maxwell AFB, Ala.: Air War College/**2025**, 1996); **2025** concept, no. 900420, “Laser Attack Station,” **2025** concepts database (Maxwell AFB, Ala.: Air War College/**2025**, 1996); **2025** concept, no. 900452, “Space based Satellite Body Guard,” **2025** concepts database (Maxwell AFB, Ala.: Air War College/**2025**, 1996); **2025** concept, no. 200034, “Missile Laser,” **2025** concepts database (Maxwell AFB, Ala.: Air War College/**2025**, 1996).

²⁰ Information from Air Force Institute of Technology (AFIT) graduate course in Laser Effects, Dr William Bradley, 1984.

²¹ “Visions” briefing, slide 21.

²² Briefing, subject: On-going Research in the Directorate, Phillips Laboratory’s Lasers and Imaging Directorate, provided to AF **2025** study team in November 1995.

²³ Ibid.

²⁴ Information obtained through personal interviews obtained by one of this paper’s authors with industrial experts in 1981, 1993, and 1994 under the promise of nonattribution.

²⁵ *Spacecast 2020*, “Force Application” (Maxwell AFB, Ala.: Air University Press, 1994), O-18. Information on energies required for weapons-class pulsed laser obtained from one author’s personal course notes, AFIT graduate course in Laser Effects, 1984.

²⁶ *Spacecast 2020*, “Force Application” (Maxwell AFB, Ala.: Air University Press, 1994), O-18.

²⁷ The aperture sizes were determined by simple optical diffraction calculations at low earth orbit ranges (hundreds of kilometers vertically; a few thousand kilometers slant range) for wavelengths from 5 microns to 0.45 microns assuming a Gaussian beam with 99%+ energy on target and a circular aperture. For more information on how to perform these calculations, see (for example) Anthony E. Seigman, *Lasers*, Mill Valley, Calif.: University Science Books, 1986, Chapter 18.4 (Aperture Diffraction: Circular Apertures), 727. For aberrated beams, even larger mirrors would be required.

²⁸ These numbers obtained by a simple geometric calculation. At an orbital altitude of 300 to 1,000 km, angular accuracies in this range are required to achieve pointing stability on the order of inches.

²⁹ US GAO Report, “Ballistic Missile Defense - Information on Directed Energy Programs for FY 1985 Through 1993” 38.

³⁰ Briefing, subject: On-going Research in the Directorate Phillips Laboratory’s Lasers and Imaging Directorate, provided to AF **2025** study team in November 1995.

³¹ John L. Petersen, *The Road to 2015* (Corte Madera, Calif.: waite Group Press, 1994). 58–60, 297–298. Intriguing ideas based on nanotechnology and microelectromechanical machines (MEMS) were also submitted as **2025** concept, no. 900518, “Electronic Grid - Throwaway Sensors,” **2025** concepts database (Maxwell AFB, Ala.: Air War College/**2025**, 1996); **2025** concept, no. 200023, “Surveillance Swarm,” **2025** concepts database (Maxwell AFB, Ala.: Air War College/**2025**, 1996); **2025** concept, no. 900231, “Gnat Robot Threat Detectors,” **2025** concepts database (Maxwell AFB, Ala.: Air War College/**2025**,

1996); **2025** concept, no. 900288, “Swarms of Micromachines,” **2025** concepts database (Maxwell AFB, Ala.: Air War College/**2025**, 1996).

³² For information on advances in low-dimensional electronic systems see the discussion in Paul Davies ed. *The New Physics*, (Cambridge, UK: Cambridge University Press, 1989), 228–234. The same text has an excellent, very brief discussion of the essential elements of optical computers on page 315. For a nontechnical discussion of trends in microprocessors see Petersen, John L., *The Road to 2015* (Corte Madera, Calif.: Waite Group Press), 1994, 28–32.

³³ Information obtained from senior DOD professional speaking to the Air War College under the promise of nonattribution.

³⁴ Briefing, subject: On-going Research in the Directorate, Phillips Laboratory’s Lasers and Imaging Directorate, provided to AF **2025** study team in November 1995.

³⁵ Lt Col Brad Shields, et al., “Weather as a Force Multiplier - Owning the Weather in **2025**,” AF **2025** study (Maxwell AFB, Ala.: Air War College, 1996).

³⁶ **2025** concept, no. 900426, “Atmospheric Disturbance,” **2025** concepts database (Maxwell AFB, Ala.: Air War College/**2025**, 1996); **2025** concept, no. 900552, “On-demand Tactical Recce Satellite Constellation,” **2025** concepts database (Maxwell AFB, Ala.: Air War College/**2025**, 1996); **2025** concept, no. 200018, “Space-Based Laser Designator,” **2025** concepts database (Maxwell AFB, Ala.: Air War College/**2025**, 1996). See also the briefing by Phillips Laboratory’s Lasers and Imaging Directorate, provided to AF **2025** study team in 1995.

³⁷ US GAO Report, “Ballistic Missile Defense - Information on Directed Energy Programs for FY 1985 Through 1993” 19.

³⁸ The core of this idea can be found in the briefing charts from the 10 April 1995 working session of the New World Vistas team in the section on the Directed Energy group (chairman Donald Lamberson, Maj Gen, USAF (Ret.)). See also briefing by Phillips Laboratory’s Lasers and Imaging Directorate, subject: On-going Research in the Directorate, provided to AF **2025** study team in November 1995.

³⁹ Amnon Yariv, *Introduction to Optical Electronics*, 2nd ed. (New York, N.Y.: Holt, Rinehart, and Winston, 1976), 166–167, 176–186.

⁴⁰ Anonymous assessor comment on first draft of Space Operations white paper, **2025** concepts database (Maxwell AFB, Ala.: Air War College/**2025**, 1996).

⁴¹ Briefing, subject: On-going Research in the Directorate, Phillips Laboratory’s Lasers and Imaging Directorate, provided to AF **2025** study team in November 1995.

⁴² Personal visit by one of the authors to the Lawrence Livermore National Laboratory’s inertial confinement fusion facilities in 1984.

⁴³ Information from Air Force Institute of Technology (AFIT) graduate course in Laser Effects, Dr William Bradley, 1984.

⁴⁴ Amnon Yariv, 210.

⁴⁵ Peter W. Milonni and Joseph H. Eberly, *Lasers* (New York, N.Y.: John Wiley and Sons, 1988), 4.

⁴⁶ US GAO Report, “Ballistic Missile Defense - Information on Directed Energy Programs for FY 1985 Through 1993,” 14.

⁴⁷ Information from Air Force Institute of Technology (AFIT) graduate courses in Plasma Physics, Dr Phillip Nielson, 1978 and Laser Effects, Dr William Bradley, 1984.

⁴⁸ US GAO Report, “Ballistic Missile Defense - Information on Directed Energy Programs for FY 1985 Through 1993,” 28.

⁴⁹ Spacecast 2020 “Force Application” (Maxwell AFB, Ala.: Air University Press, 1994). O-22, O-23.

⁵⁰ US GAO Report, “Ballistic Missile Defense - Information on Directed Energy Programs for FY 1985 Through 1993,” 30.

⁵¹ *Ibid.*, 30.

⁵² Visions briefing, slide 18.

- ⁵³ US GAO Report, “Ballistic Missile Defense - Information on Directed Energy Programs for FY 1985 Through 1993,” 31.
- ⁵⁴ Personal interview with Dr M. Yarymovitch, 7 February 1996.
- ⁵⁵ US GAO Report, “Ballistic Missile Defense - Information on Directed Energy Programs for FY 1985 Through 1993,” 31.
- ⁵⁶ Carlo Kopp, “A Doctrine for the Use of Electromagnetic Pulse Bombs” (Fairbairn ACT, Australia: Air Power Studies Centre (ISBN 0 642 19343 6), July 1993); 1, 11.
- ⁵⁷ Ibid., 3.
- ⁵⁸ J. D. Jackson, *Classical Electrodynamics*, 2nd ed. (New York, N.Y.: John Wiley and Sons, 1975), 271.
- ⁵⁹ John Moyle, memorandum entitled “Thoughts on the Revolution in Military Affairs,” from the Strategic Assessment Center to Mr Jeff McKittrick and Colonel Richard Szafranski, 5 January 1996, 9.
- ⁶⁰ Ibid. 3.
- ⁶¹ Carlo Kopp, 10.
- ⁶² Ibid., 3–5.
- ⁶³ Dr William Balcer, Phillips Lab, “Transient Electromagnetic Technology and Future Space-control,” Briefing on 20 Oct 1993, to AF Spacecast 2020 study. Also see Spacecast 2020 abstract paper AO112 (Compact Toroids).
- ⁶⁴ Spacecast 2020, “Force Application” (Maxwell AFB, Ala.: Air University Press, 1994), O-19.
- ⁶⁵ John Moyle, 9.
- ⁶⁶ **2025** concept, no. 900270, “EMP Pills,” **2025** concepts database (Maxwell AFB, Ala.: Air War College/**2025**, 1996).
- ⁶⁷ Carlo Kopp, “Air Warfare Applications of Laser Remote Sensing” (Fairbairn, Australia: Air Power Studies Centre), 2.
- ⁶⁸ **2025** concept, no. 200009, “Pyrotechnic Electromagnetic Pulse (PEP),” **2025** concepts database (Maxwell AFB, Ala.: Air War College/**2025**, 1996); **2025** concept, no. 900270, “EMP Pills,” **2025** concepts database (Maxwell AFB, Ala.: Air War College/**2025**, 1996).
- ⁶⁹ Carlo Kopp, “A Doctrine for the Use of Electromagnetic Pulse Bombs,” 15.
- ⁷⁰ John Moyle, 10.
- ⁷¹ Carlo Kopp, “Air Warfare Applications of Laser Remote Sensing,” 3.
- ⁷² Carlo Kopp, “A Doctrine for the Use of Electromagnetic Pulse Bombs,” 9.
- ⁷³ Briefing, subject: On-going Research in the Directorate, Phillips Laboratory’s Advanced Weapons and Survivability Directorate, provided to AF **2025** study team on 4 December 1995; 8, 38, and 40. This was extracted from a brief technical note attached to the briefing by Dr John T. Tatum, US Army Research Laboratory, Adelphi, Md. entitled “A New Threat to Aircraft Survivability: Radio Frequency Directed Energy Weapons (RF DEW).”
- ⁷⁴ Ibid., 10.
- ⁷⁵ Information obtained from senior technical and management personnel in the American aerospace industry under the promise of nonattribution.
- ⁷⁶ Briefing, subject: On-going Research in the Directorate, Phillips Laboratory’s Advanced Weapons and Survivability Directorate, provided to AF **2025** study team on 4 December 1995; 10, 32, and 33.
- ⁷⁷ George E. Thibault, *The Art and Practice of Military Strategy* (Washington, D.C.: National Defense University Press, 1984), 47.
- ⁷⁸ **2025** concept, no. 200015, “Distortion Field Projector,” **2025** concepts database (Maxwell AFB, Ala.: Air War College/**2025**, 1996); **2025** concept, no. 900313, “Spaceborne/Airborne Hologram,” **2025** concepts database (Maxwell AFB, Ala.: Air War College/**2025**, 1996); **2025** concept, no. 900570, “Deceptive Holographic Imaging,” **2025** concepts database (Maxwell AFB, Ala.: Air War College/**2025**, 1996); **2025** concept, no. 900390, “Holographic Battlefield Deception,” **2025** concepts database (Maxwell

AFB, Ala.: Air War College/2025, 1996); 2025 concept, no. 900756, "Holographic Deception Operations," 2025 concepts database (Maxwell AFB, Ala.: Air War College/2025, 1996); 2025 concept, no. 900792, "Holographic CCD," 2025 concepts database (Maxwell AFB, Ala.: Air War College/2025, 1996).

⁷⁹ Amnon Yariv, 408–409.

⁸⁰ Peter W. Milonni and Joseph H. Eberly, *Lasers* (New York, N.Y.: John Wiley and Sons, 1988), 606–609.

⁸¹ John L. Petersen, *The Road to 2015* (Corte Madera, Calif.: Waite Group Press, 1994), 62.

⁸² CDR Clarence E. Carter, et al., "The 'Man in the Chair' - Cornerstone of Global Battlespace Dominance," AF 2025 study (Maxwell AFB, Ala.: Air War College, 1996); LtCol Edward F. Murphy, et al., "Information Operations: Wisdom Warfare for 2025," AF 2025 study (Maxwell AFB, Ala.: Air War College, 1996); LtCol William Osborne, et al., "Information Operations: A New Warfighting Capability," AF 2025 study (Maxwell AFB, Ala.: Air War College, 1996); and Maj Michael J. Tiernan, et al., "In-Time Information Integration System (I³S)," AF 2025 study (Maxwell AFB, Ala.: Air War College, 1996).

⁸³ David Halliday, and Robert Resnick, *Fundamental of Physics*, 3d ed. (New York, N.Y.: John Wiley and Sons, 1988), 134.

⁸⁴ Personal interview with Dr M. Yarymovitch, 7 February 1996.

⁸⁵ *Spacecast 2020*, "Force Application" (Maxwell AFB, Ala.: Air University Press, 1994), O-15 and O-8.

⁸⁶ John Moyle, 12–13.

⁸⁷ US GAO Report, "Ballistic Missile Defense - Information on Directed Energy Programs for FY 1985 Through 1993, 12.

⁸⁸ Briefing, subject: "Mission Area Vision - Force Application," 10 November 1992 S. J. Navickas.

⁸⁹ Stanley W. Kandebo, "'Air Spike' Could Ease Hypersonic Flight Problems," *Aviation Week & Space Technology*, 19 May 1995. 66.

⁹⁰ 2025 concept, no. 200010, "Suppression Cloud," 2025 concepts database (Maxwell AFB, Ala.: Air War College/2025, 1996); 2025 concept, no. 900270, "EMP Pills," 2025 concepts database (Maxwell AFB, Ala.: Air War College/2025, 1996).

⁹¹ Personal observation by one of the authors at the AF Phillips Laboratory and the University of Texas, Austin in 1981 and 1989.

⁹² Considerable information on this topic can be found at the following Worldwide Web available from: www.pas.nps.navy.mil/railgun.html.

⁹³ 2025 concept, no. 900168, "Meteors as a Weapon," 2025 concepts database (Maxwell AFB, Ala.: Air War College/2025, 1996).

⁹⁴ William J. Broad "Meteoroids Hit Atmosphere in Atomic-Size Blasts," *New York Times* 25 January 1994.

⁹⁵ Briefing, subject: "Military Spaceplane Technology and Applications," January 1996, Phillips Laboratory PL/VT-X, slides 9,10, 11, and 30.

⁹⁶ Ibid. slide 7.

⁹⁷ Information obtained from the internet, Internet 14 February 1996, available from: <http://www.contribu.cmu.edu/usr/fjo4/>.

⁹⁸ Dr Dennis Bushnell, Chief Scientist for NASA Langley Research Center, telephone interview, 26 Feb 96.

⁹⁹ Ibid.

¹⁰⁰ Ibid.

¹⁰¹ Ibid.

¹⁰² Ibid.

¹⁰³ Ibid.

¹⁰⁴ Ibid.

¹⁰⁵ Briefing, subject: “Military Spaceplane Technology and Applications,” January 1996, Phillips Laboratory PL/VT-X, slide 20.

¹⁰⁶ *Spacecast 2020*, “Space Lift: Suborbital, Earth to Orbit, and On-Orbit,” (Maxwell AFB, Ala.: Air University Press, 1994), H-1.

¹⁰⁷ Briefing, subject: “Future Expansions in Space,” 25 June 1995, McDonnell Douglas/Boeing, chart Y505403.1M18BA76.

¹⁰⁸ Briefing, A Discussion Paper-as-Briefing, 26 January 1996 “Space and the Army’s Future”, slide 5.

¹⁰⁹ Briefing, subject: “Military Spaceplane Technology and Applications,” January 1996, , Phillips Laboratory PL/VT-X, slide 19.

¹¹⁰ Briefing, subject: “Future Expansions in Space,” 25 June 1995 McDonnell Douglas/Boeing,, chart Y505403.1M18BA76. The X-33 program predicts this can be done in from hours to a few days. Briefing, Col Ted Wierzbarowski, subject: “National Aerospace Plane and Airbreathing Single-Stage-to-Orbit,” 19 October 1993, chart D2270.010.

¹¹¹ W. J. Schaeffer Associates, Memorandum to Capt Clapp, USAF, 4 February 1994.

¹¹² Briefing, subject: “Future Expansions in Space,” 25 June 1995, McDonnell Douglas/Boeing, chart Y505403.1M18BA76.

¹¹³ Briefing, subject: “Military Spaceplane Technology and Applications,” January 1996, Phillips Laboratory PL/VT-X, slide 31.

¹¹⁴ Lt Col Robert H. Zielinski, et al., “Star Tek - Exploiting the Final Frontier - Counterspace Operations in **2025**,” AF **2025** study (Maxwell AFB, Ala.: Air War College, 1996).

¹¹⁵ Personal interview with Dr M. Yarymovitch, 7 February 1996.

¹¹⁶ Lt Col Brad Shields, et al., “Weather as a Force Multiplier - Owning the Weather in **2025**,” AF **2025** study (Maxwell AFB, Ala.: Air War College, 1996).

¹¹⁷ Information obtained from the internet, Internet 14 February 1996 available from: <http://www.contribu.cmu.edu/usr/fjo4/> and conversations with representatives at a briefing on the military spaceplane, 6 March 1996.

¹¹⁸ Ralph Vartabedian, “Lasers Next Great Hope to Beam Defense Systems into Future,” *Los Angeles Herald*, 3 December 1995.

¹¹⁹ Maj Michael Roggemann, Air Force Institute of Technology (AFIT) professor, telephone interview with author, 28 March 1996.

Chapter 4

Concept of Operations

The threat-dependent concept of operations for the GLASS is relatively straightforward. Threats could be slowly developing situations, fast developing crises, or surprise attacks from a country or a terrorist-type group (where some quick retaliatory response is required). In addition, the intensity of the threat could vary over a broad range from mere intimidation to an isolated terrorist attack, a small war or battle, or (inevitably) total war. No matter what type of threat or situation develops or what its intensity, the global coverage provided by GLASS will allow decision makers to direct action that is responsive and timely (i.e., near instantaneous), flexible in terms of the full spectrum of lethality (i.e., from “lighting up” the battlefield to destroying platforms and assets), precise (i.e., pinpoint accuracy if necessary), survivable (i.e., dispersion of vulnerable space-based assets, self-protection capability, and CONUS-basing of the highest-value components), and reliable (i.e., TAV will be able to serve as backup). In summary, GLASS provides global coverage and a broad range of nearly instantaneous responses without extensive forward basing.

In the first instance of a slowly developing situation involving the US and its allies, the GLASS would be used primarily as a deterrence weapon. However, it is much more flexible than today’s nuclear-deterrent weapon. The nuclear bomb may well have prevented a catastrophic total world war, but it has not stopped any of the hundreds of relatively minor conflicts (at all levels) that have continued to rage since 1945. The GLASS, able to project force across a wide spectrum of outcomes, could actually be employed in scenarios ranging from humanitarian operations (i.e., in its surveillance or illumination modes) to major regional conflicts (i.e., to disrupt, damage, or destroy the enemy’s strategic assets). These operations do not necessarily have to be lethal. That is, the US could select a benign target, notify the rogue government of the time and place at which the offending item will be neutralized, and then disable or destroy the target (and

only the target) with a laser beam and/or hypervelocity projectile. After a few demonstrations of this capability, even the most isolated totalitarian rogue state would realize none of its offensive assets are safe and (just as important) there will be no collateral damage to show the news cameras. Clearly, in addition to the straight-forward destruction of military targets, the GLASS could be used for deterrence, intimidation, persuasion, or just to forcefully signal America's resolve.

GLASS could also be put to effective use in the most fast-developing crisis. For example, suppose a country in northern Africa masses tanks on its border to invade a nearby country and their leadership will not listen to American or UN requests to reverse this provocative action. A cluster of small projectiles could be dropped from a TAV to destroy a critical tank concentration while laser beams "from heaven" are burning holes through advancing combat aircraft and blowing up fuel storage areas and munitions dumps. Even a modern war machine could be stopped dead in its tracks before it even gets started, since the GLASS can strike strategic, operational, and tactical targets, simultaneously performing strategic attack, interdiction, and even close support missions.

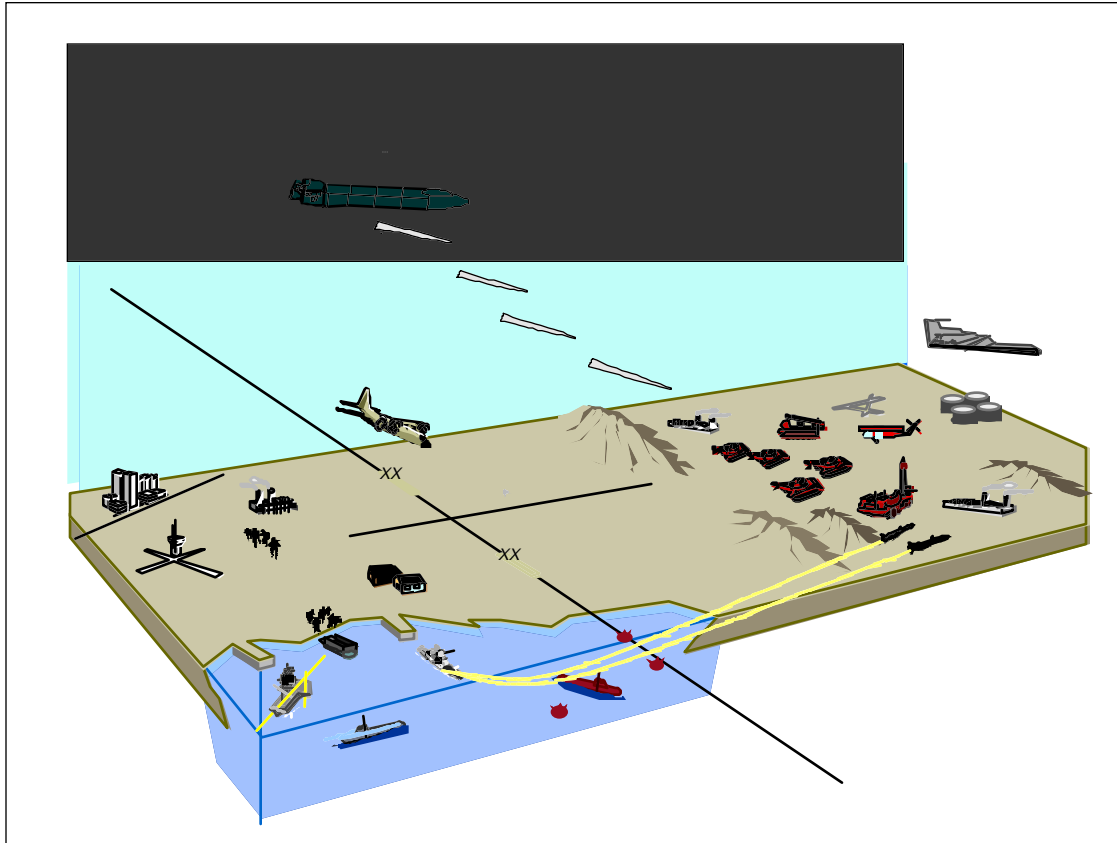

Figure 4-1. TAV Employing Kinetic-Energy Weapons

In the third situation, where an attack has already occurred and a response is required, the GLASS could be used in a myriad of ways to retaliate and with a speed limited only by the time required for US leadership to make its decisions. For example, the mission may be to eliminate the leadership of a terrorist organization located at a “safe house” in the largest city of a rogue state. A precision projectile could be dropped from an orbiting TAV that was launched only an hour before and within minutes, the house along with the leadership would be destroyed. It would not matter if the “safe house” was reinforced with concrete or buried underground; with good intelligence, literally no target on earth would be safe from the GLASS. More importantly, there would be no political fallout from collateral damage. Current weapon systems must generally make do with targeting data accurate to one to 10 meters at best.¹ This is not the optimum situation for precision-guided or precision-aimed weapons. Such enormous destructive power must be controlled precisely to avoid unnecessary collateral damage. Acceptable targeting data in 2025 will be measured in centimeters, not in meters.

If an area is not covered by the weapon constellation (this will occur at times), the TAV would be sent up with a mobile mirror for the ground-based laser and/or a container of hypervelocity projectiles to cover the target area. Although not as responsive as space-based assets, a TAV could reach anywhere on earth within 60 minutes after its crew climbs on board.² The TAV could also carry other types of weapons such as some of those discussed in chapter 3. For deterrence, the US could launch numerous TAVs in unpredictable orbits that remain in space until the crisis is resolved. Three TAVs could provide coverage of most of the earth's current trouble spots every 90 minutes.³ Of course, the TAV would also be ideal for space-control and space superiority. These issues are further explored in other white papers.⁴

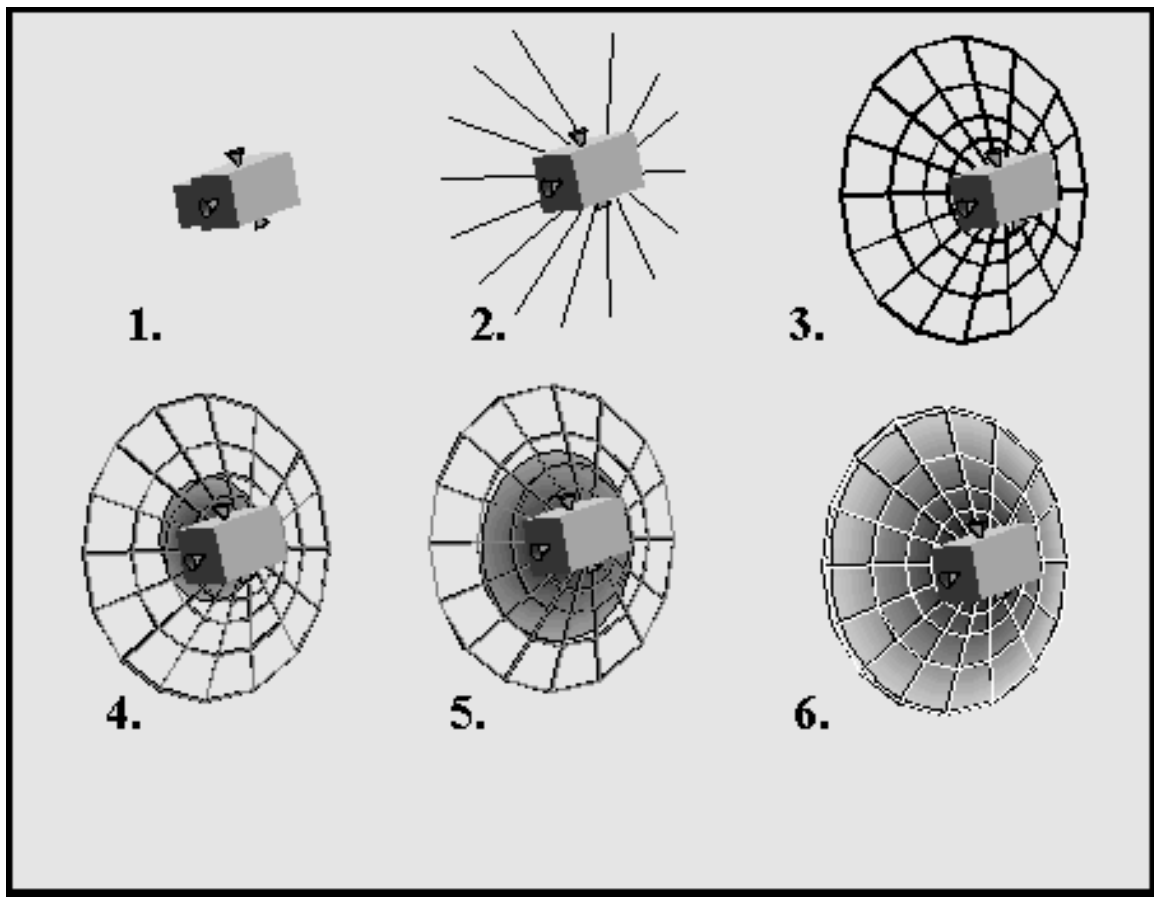

Figure 4-2. Notional Space-Based Mirror Deployment Using Inflatable Mirror Technology

The GLASS would also be ideal for counterproliferation operations. The engagement would involve a system-to-system interaction with fixed or mobile ground targets with support from communication, navigation, and surveillance systems. Using the GLASS, the US would not need permission from neighboring nations for landing or overflight rights and could strike a rogue state with a “launch or lose” mentality without

any prior warning. These desirable functions could be performed without forward deployment of forces, drastically reducing the danger to US military personnel. The flexibility and response time of the GLASS in its role as a counterproliferation asset would be unmatched.⁵

The laser portion of the GLASS has three important characteristics: the weapon itself (photons) travels at light speed, it can be precisely controlled and aimed (not *inherently* a weapon of mass destruction), and it is not necessarily a line-of-sight weapon (i.e., it can be relayed by mirrors). Possession of a light-speed weapon would revolutionize the conduct of future wars. John Moyle of the Strategic Assessment Center describes this capability as the way to “get inside” the opponent’s OODA loop, since, “The means with which one can destroy an enemy’s system . . . operates at the same speed as of the flow of information, the critical component of the enemy’s ability to counter/defend against the strike in the first place.”⁶ It may be impossible to mount an active defense against a light-speed weapon.

Geometry is another aspect of the concept of operations. The question, “from where to where?” captures the essence of military space operations and frames the geometry of different force-application missions. Regardless of the purpose of an operation, its beginning and ending locations have tremendous impact on the nature of the operation and its success. The basic geometries for military space systems include earth-space-earth and space-earth. The GLASS employs the earth-space-earth geometry through both the TAV and the DEW system (which is both distributed and dispersed in two mediums—earth and space). That is, the GLASS begins its mission within the earth’s atmospheric envelope, traverses the space environment, and then applies force to resolve or influence a conflict occurring primarily within the earth’s atmospheric envelope (we do not foresee wars *in space* by 2025). This application of force may involve physical destruction or more subtle effects such as battlefield illumination, support for deceptive information-warfare attacks, or C²W/EW against an adversary’s electronic communications and/or electronic order of battle. The latter distinction is crucial since, in 2025, an adversary’s center of gravity may not be a physical object at all, but rather an intangible communications link, information flow, or public attitude.

Basing is also a prime consideration. The laser beams of the DEW system will originate from powerful facilities dispersed around remote parts of the CONUS. Sunny, clear areas such as the American southwest would be the most likely choices. With a laser system that uses space-based mirrors, there are several advantages to using an earth-based laser located in the US (or its possessions): no forward basing is

required, there are no concerns about foreign governments demanding removal of US assets from their territories, no weapons are actually placed in space, and the most expensive and maintenance-intensive portions of the system are all ideally placed for access by the US sustainment system. Yet the US would still have tremendous capabilities for power projection. Dispersion of the laser stations is also desirable to enhance the security, reliability, and flexibility of the system and to provide concentration of mass in strategic attacks by allowing GLASS to focus several laser beams on a single hardened target simultaneously.

The TAV element of the GLASS is projected to operate out of at least six CONUS locations and seven locations outside the CONUS, including Alaska, Guam, and Hawaii. This also allows for security and flexibility. If TAV take-off/landing is vertical, pads of 200 square feet with airplane-like facilities are required. If the TAV is a horizontal take-off/landing system, then runways of 8,000 feet will probably be required—less than that needed for most modern jets today. Thus, the TAV fleet could be based at many possible locations (with a large number of already existing backup landing sites).⁷

The infrastructure for the TAV would be similar to that of aircraft today. That is, the ground site would need a fueling capability, a loading capability (change containers in and out), maintenance facilities, and 200-foot-square launch pads (if it evolves into a horizontal landing vehicle, it would also require an 8,000 foot runway). With miniaturization of electronics (thus, portable maintenance equipment), “black box” concepts, “containerized” payloads, and so forth, the number of supporting ground personnel and equipment should be greatly reduced in comparison with that required for today’s military aircraft. In short, the logistics tail would be greatly reduced. Thus, the TAV would have “home bases,” but it would be capable of rapidly deploying into many locations during times of tensions and increased hostilities.

The ground-based laser would necessarily require a large power source, a cooling system (possibly employing a high flow of chilled water), and relatively clear skies. This would require relatively isolated basing away from population centers. The power sources would be similar to those that exist today, but they would be more compact, self-contained, and more easily maintained. Of course, the power sources and lasers would be fixed, so significant ground-based security forces, and possibly point defenses against ballistic missiles, would be required. The more ground sites available, the less vulnerable the system is to attacks, the more targets could be hit simultaneously, and the greater the likelihood the system would be available to attack a given target at need. In addition, tracking, monitoring, and control sites would be required for the

mirrors. However, these would not necessarily have to be dedicated sites. That is, they could be integrated into the same system the US uses to track, monitor, and control other space assets. The idea would be to automate as much as possible, build in reliability and maintainability, and standardize procedures and equipment from the beginning of development.

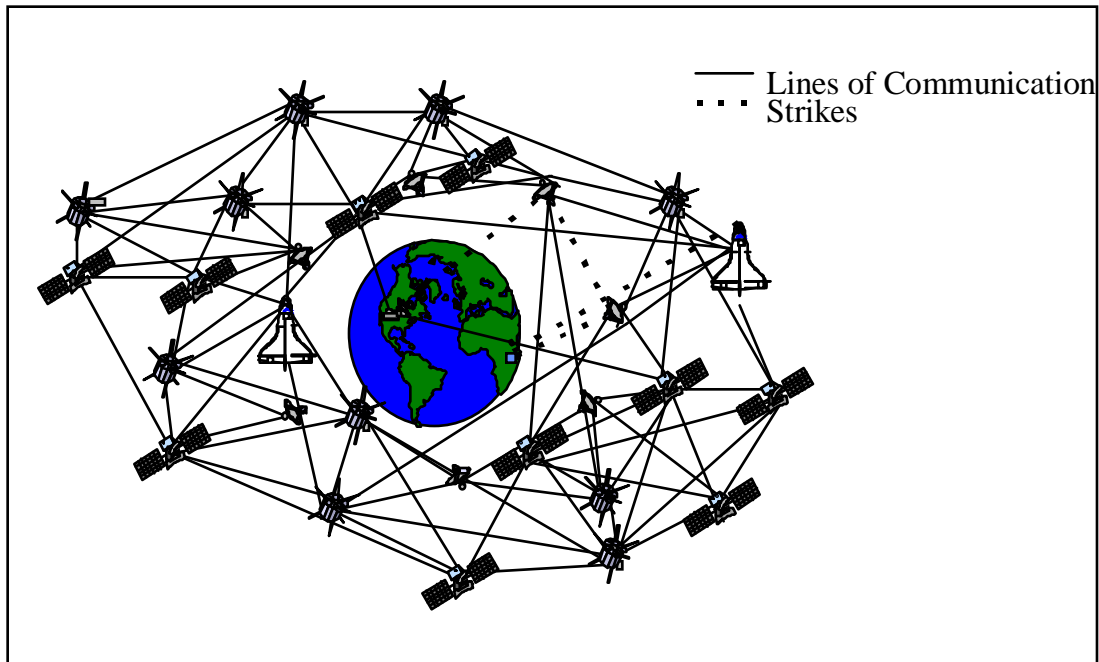

Figure 4-3. The Crowded “Skies” of 2025

The total number of TAVs the US should procure depends upon the other missions, besides GLASS, that are required. For our purposes, however, the US should procure 12 to 16 operational TAVs. These would be divided into three Combat Space Squadrons, each having the following missions: precision attack, reconnaissance/surveillance, space lift, satellite support, and “other missions as required.”⁸ These squadrons would fall under a central controlling authority that would also control the laser stations or bases. Thus, the synergistic effects of the laser and the TAV would be realized.

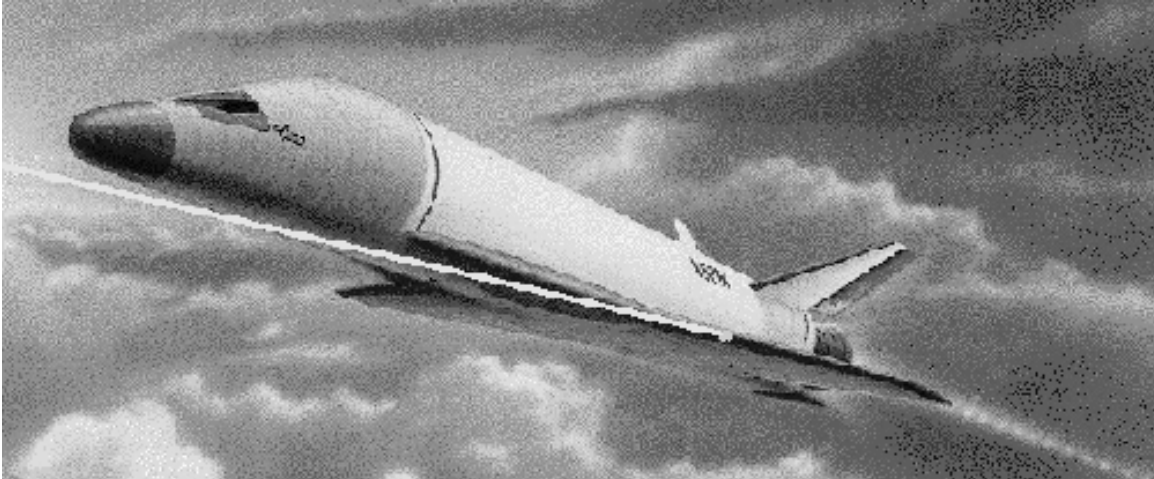

Figure 4-4. A TAV in *Space-strike Mode*

A TAV could be used to perform a myriad of space operations. The possibilities include deployment, repair, or retrieval of satellites (other than just the GLASS); deployment of smart munitions other than the KEW (usually from LEO); and functioning temporarily as a space-borne command post.⁹ TAVs could respond quickly to contingencies with tailored mission packages. Missions ranging from emergency satellite repair/deployment, to dropping a special operations team in the middle of a hostile environment, to mending a gap in a critical satellite constellation would all be possible. In addition, a small fleet of TAVs could allow for the placement of mass (in limited quantities) at critical nodes in a conflict situation. Perhaps the most important advantage might be the psychological effect of possessing such a capability. America's enemies would always have to factor in an almost immediate American response into their hostile actions.

The human in the loop concept is, by itself, neither an advantage nor a disadvantage. That is, humans will certainly be “in the loop” at the critical point in any application of force. This critical point could involve action on the ground or in space. If force is being applied by a light-speed, directed-energy weapon, the delay between the decision to take action and “fire on the target” might only be measured in seconds, but human decision and human judgment would still be intimately involved.

There are decided disadvantages to putting humans in space. To begin with, a human in space would immediately become a prime target during a conflict, especially if the human is the critical link in the weapon system. Moreover, space is a hostile environment—especially near the Van Allen radiation belts; thus, the necessary safety factor increases the overall cost and complexity of the weapon system. In addition, the space

operations missions involving the TAV are limited, since current TAV concepts are designed only for LEO operations (limits access to space assets). Timeliness or responsiveness is also relatively limited for manned space systems. An on-orbit, unmanned space-based weapon could take action in a fraction of a second; a manned TAV might require up to an hour to arrive at the crisis location. The TAV is also extremely vulnerable during takeoff, orbit insertion, and landing. A nation could attempt to keep man in space at all times, but the costs involved are believed greater than those of the TAV, on orbit logistics is extremely expensive, and a permanent manned presence in orbit invites “hostage-taking” via ASAT. Thus, there will always be risks for this integral part of the GLASS weapon system.

Notes

¹ Maj, James G. Lee, USAF, “Counterspace Operations for Information Dominance,” (Maxwell AFB, Ala.: Air University Press, October 1994), 14. See also Capt Kimberly M. Walker, USAF and Capt Tery L. Donelson, “Space Operations Training Course - Chapter 10: Navstar Global Positioning System” (Peterson AFB, Colo.: 1994), 152.

² 1992 Global Reach-Global Power White Paper.

³ Briefing, subject: “Military Spaceplane Technology and Applications,” January 1996, Phillips Laboratory PL/VT-X, slide 27.

⁴ Lt Col Robert H. Zielinski, et al., “Star Tek - Exploiting the Final Frontier - Counterspace Operations in 2025,” AF 2025 study (Maxwell AFB, Ala.: Air War College, 1996).

⁵ Briefing, subject: “Military Spaceplane Technology and Applications,” January 1996, Phillips Laboratory Laboratory PL/VT-X, slide 12.

⁶ John Moyle, Memorandum entitled “Thoughts on the Revolution in Military Affairs,” 1.

⁷ Briefing, subject: “Military Spaceplane Technology and Applications,” January 1996, Phillips Laboratory PL/VT-X, slides 12 and 21.

⁸ Ibid., slide 2.

⁹ 2025 concept, no. 900265, “Space Storage Modules to Establish Space-Sourced Air Drop Capability,” 2025 concepts database (Maxwell AFB, Ala.: Air War College/2025, 1996); 2025 concept, no. 900654, “Parts Locker,” 2025 concepts database (Maxwell AFB, Ala.: Air War College/2025, 1996); 2025 concept, no. 900249, “Geosynchronous Manned Command and Control Module,” 2025 concepts database (Maxwell AFB, Ala.: Air War College/2025, 1996).

Chapter 5

Investigation Recommendations

We know from even the most casual study of military history how fallible man is in matters concerning war and how difficult it has been for him, mostly because of the discontinuity of wars, to adjust to new weapons. Yet compared to the changes we consider now, those of the past, when measured from one war to the next, were almost trivial. And almost always in the past there was time even after hostilities began for the significance of technological changes to be learned and appreciated.

—Bernard Brodie¹

The concepts discussed in this paper directly address the needs of the military’s most forward-thinking senior planners. Volume four (Future Capabilities) of Joint Planning Document FY 98-03 states that, to achieve joint war fighting objectives, we must develop the “capability to destroy selected targets with precision while limiting collateral damage. Includes precision guided munitions, surveillance and targeting capabilities. Requires advances in sensors, guidance and control, and lethality.”² Joint Vision 2010 calls for

“long range precision capability, combined with a wide range of delivery systems . . . the ability to generate a broader range of potential weapons effects, from nonlethal to hard target kill . . . these improvements will result in increasingly discrete and precise capabilities, selected to achieve optimum results and applicable to both combat and other operations.”³

The *New World Vistas* team predicts “space-control and projection of force from space technologies will become as important [as global observation and global situational awareness] in the twenty-first century as global technology for utilization of space becomes more available to many countries of the world.”⁴ Achieving these desirable capabilities will not be easy and it will not happen overnight. We must begin work now if we wish to be ready for the world of 2025.

Directed-Energy Weapons

Directed-energy weapons operating at or near the speed of light offer the greatest opportunity for sudden, precise attacks across the spectrum of force against a wide range of targets. Reliable, effective directed-energy weapons will not be possible without compact, high-capacity power supplies. Today's solar power technology is insufficient—too much time would be required between shots to regenerate the system's energy reserves. Large, light-weight space structures of particular kinds are also critical. Laser space-strike systems require large, light-weight, optically smooth adaptive mirrors capable of correcting beam aberrations.

Current sources of directed energy also require further research. Highpower, solid-state, and diode lasers must be investigated because of their inherent efficiency advantages, their ability to operate without bulky chemical fuels, their potential for operation at shorter wavelengths, and because diode lasers can operate in phased arrays (obvious advantages in pointing and beam combining).

Finally, further work is required in directed-energy beam propagation. The impressive success of modern low-power adaptive optics techniques must be extended to high-power beams if laser space-strike systems are to reach their full potential.

Projectile Weapons

The approaches mentioned in this paper involving long-range ballistic missiles are already possible—the only thing lacking is the will to proceed. Two technologies are desirable to enhance the effectiveness of such weapons: high-speed (submicrosecond) fusing and high-speed dispersal techniques for submunitions in the terminal phase.

The destructive interaction of hypervelocity projectiles with targets has been investigated by the US military and NASA. These investigations must continue, particularly with regard to hydrodynamic penetrators, if we are to understand how to configure and direct hypervelocity projectiles to achieve optimum effect. Terminal guidance techniques must be improved to enable the use of kinetic-energy weapons as true precision-guided weapons.

Space Sortie

The main challenges here lie in propulsion technology (both air breathing and for space) and aerodynamic design for reliable hypersonic flight. Light-weight, high-endurance propulsion systems are needed to operate transatmospheric vehicles (TAVs) for long-range sorties. Light-weight, high temperature materials and high-capacity cooling systems must be developed to form the “skin and bones” of the TAV.

General Considerations

Space-strike weapon systems will not be possible without reliable, affordable access to space. The investigation recommendations of the AF **2025** Space Lift white paper are therefore seconded without reservation in this paper. All the space operations missions—space control, force enhancement, force application, and space support—depend on access to space.⁵

A blind marksman is a contradiction in terms. The space-strike weapon systems of 2025 will depend heavily on America’s global information network.(see appendix B). In this regard, the following areas of study are as critical for this white paper as they are for the surveillance and reconnaissance and information operations white papers: advanced sensors; data fusion techniques; miniaturization (nanotechnologies and MEMS); secure, reliable, wideband communications; reliable distributed networks (particularly distributed networks of small satellites); advanced, high-speed, high-capacity computers; and the combination of hardware and software technologies which will enable true “artificial intelligence.”

The areas recommended for further investigation in this paper must be pursued in full cooperation with industry wherever possible. The days of “fat” defense budgets are long gone—they will not come again in our time. Civilian (domestic and foreign) research dollars will determine the main areas where technology will advance in the twenty-first century. The US military must keep its collective eye on the “main chance,” directing its precious and limited research funds where they will have the greatest effect. Anything less would be irresponsible.

¹ Quoted in Lt Col Charles M. Westenhoff, USAF, compiler. *Military Air Power-The CADRE Digest of Air Power Opinions and Thoughts*, Airpower Research Institute, Air University Press, Maxwell AFB, Ala. October, 1990, 90.

² “Joint Planning Document FY 1998-2003,” 15 December 1995, Vol. 4 (Future Capabilities) 2.

³ “Joint Vision 2010 - America’s Military: Shaping the Future,” a publication of the Joint Staff provided to AF **2025** by AF/XOXS, January 1996, 4.

⁴ USAF Scientific Advisory Board, *New World Vistas: Air and Space Power for the 21st Century*, summary volume (Washington, D.C.: USAF Scientific Advisory Board, 15 December 1995), 60.

⁵ Lt Col Henry. Baird, et al., “Spacelift - Integration of Aerospace Core Competencies,” AF **2025** study (Maxwell AFB, Ala.: Air War College, 1996).

Appendix A

Global Presence

Global presence includes a full range of potential activities ranging from the physical interaction of military forces and targets to the “virtual interaction” between information systems envisioned by the “information warriors.” We will explore the idea of global presence by discussing the strengths and weaknesses of the space systems which could yield “global space presence” in 2025. Key technologies will ultimately be identified that link global space presence to a global space-strike capability and to the integrated network of sensors, communications, and information processing required to collect data from any (and every) area of the planet and convert it into information and knowledge in a suitably short time frame. Along the way, we will emphasize the important synergy and interconnectedness between military and commercial space systems in 2025.

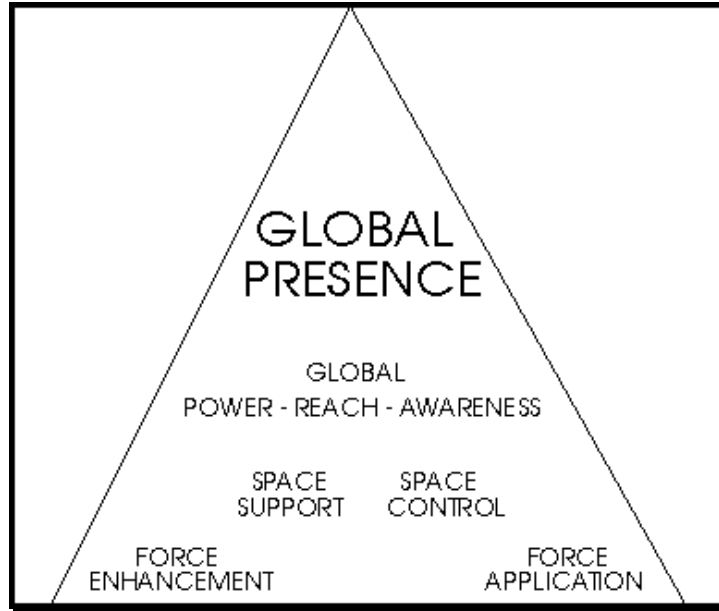

Figure A-1. Space Operations Missions

Some Important Definitions

Global space presence means providing military space capability, including non-belligerent applications and/or leveraging of information, to deter or compel an actor or affect a situation.¹ Through global space reach and global space power, multiplied by global space awareness and backed up by sustainment and readiness, the Air Force can provide an unmatched power projection capability to America's joint force in 2025.²

Global space reach includes those activities conducted from space that improve the operational effectiveness of military forces operating in all mediums (space, air, land, sea, subsurface).

Global space power involves the application of the full spectrum of force, physical and virtual, from space on demand to an adversary's means of pursuing the conflict.

Global space awareness is achieved through the integrated, worldwide acquisition, transmission, storage, and processing of information through space to enhance the employment of all military forces.

Readiness and sustainment means providing the ability to mount and support continuous military operations.³

Global space presence is a vital capability that can only be achieved by a nation with global space reach, global space power, global space awareness, and a robust readiness and sustainment system. By 2025, a nation that hopes to reap the benefits of great power status must possess global space presence.

In 1996, military space operations are organized to perform four core missions.⁴ These mission areas are equally critical to the future success of US military operations at all levels—strategic, operational, and tactical. Space operations have already impacted the combat arms and the combat support elements of all branches of the US military through space reconnaissance, surveillance, and communication. The four core missions focus on enabling or supporting terrestrial (land, sea, air, and subsurface) military operations with assets operating from space (force enhancement); providing freedom of access to and operation in space for friendly forces while denying enemy access (space-control); applying force, both physical and virtual, to terrestrial military targets with weapon systems operating from space (force application); and conducting launch support and on-orbit military command and control for crucial military space assets (space support). Since these mission areas overlap, actual military space operations are broader than any one mission area.⁵

Notes

¹ Gen Ronald E. Fogleman, USAF, and Dr Sheila E. Widnall, *Global Presence 1995* (Washington, DC: HQ USAF, pamphlet, 1995), 3.

² Air Force Doctrine Document 1, Air Force Basic Doctrine, first draft, 15 August 1995, 3.

³ Ibid., 3. Adapted from the discussion documented here.

⁴ AF Manual 1-1, *Basic Aerospace Doctrine of the United States Air Force*, vol. 2, Essay L (Washington, D.C.: HQ USAF, March 1992), 103–111. The missions listed in this paper were adapted from this essay.

⁵ Maj Thomas A. Torgerson, USAF, “Global Power Through Tactical Flexibly Deployable Space Units,” (Maxwell AFB, Ala.: Air University Press, Research Report AU-ARI-93-6, June 1994), 4.

Appendix B

The System of Systems

All the systems of the force application system-of-systems must be integrated with all the other systems that interface with it. On board (guidance, maneuvering) and off board (surveillance, some processing) systems all work together as a distributed system-of-systems.

SAT/BDA

The surveillance, acquisition, and tracking/battle damage assessment(SAT/BDA) requirements fall into the general mission category of force enhancement. The impact of cost constraints and rapidly developing technologies on the Defense Department is moving the initiative in these areas toward the commercial sector. The global positioning system (GPS) is a prominent modern example, with commercial units being bought by the thousands to support Operation Desert Storm. It is very likely, therefore, that a significant amount of surveillance, acquisition, and tracking and battle damage assessment will depend on commercial concepts or commercial assets by 2025. This will be an important factor in two ways. First, a great amount of equipment will be available "off the shelf," and not just in America. Given their high cost, satellite assets will probably be shared, and not always by allies. Who will be in control?

One of the biggest questions in a multinational world, with multinational corporations, is whether we will have access to the information we need. If we do not wish to build duplicate military systems, we must in some way assure ourselves of access to commercial assets while retaining the capability to block an opponent's access. This might be done through treaties or binding business arrangements, but most likely we

will need some built-in capability to literally seize control of the necessary portions of shared commercial satellite assets.

The global information network (GIN) of 2025 is the obvious and probably the only affordable place to perform most of the SAT/BDA function. If the military's relatively limited (a matter of funding, not ingenuity) computers, sensors, and dedicated communications are not linked to the GIN, it will be impossible to assemble an accurate "digital picture of the battlefield" in real time. Linkage to the GIN will also provide ready access to rich sources of information unavailable to the modern war fighter. From the perspective of a space-strike weapon system, the availability of multiple views in many sensory bands of each target is an irresistible advantage. This suggests most SAT/BDA functions in 2025 will be performed "off platform" for space-strike weapon systems, making the development of secure, jam-resistant communication links a top priority. Two possibilities have been suggested in this regard: redundant radio frequency (RF) links in many frequency bands, possibly including spread spectrum techniques, and ultrawideband optical communications.¹

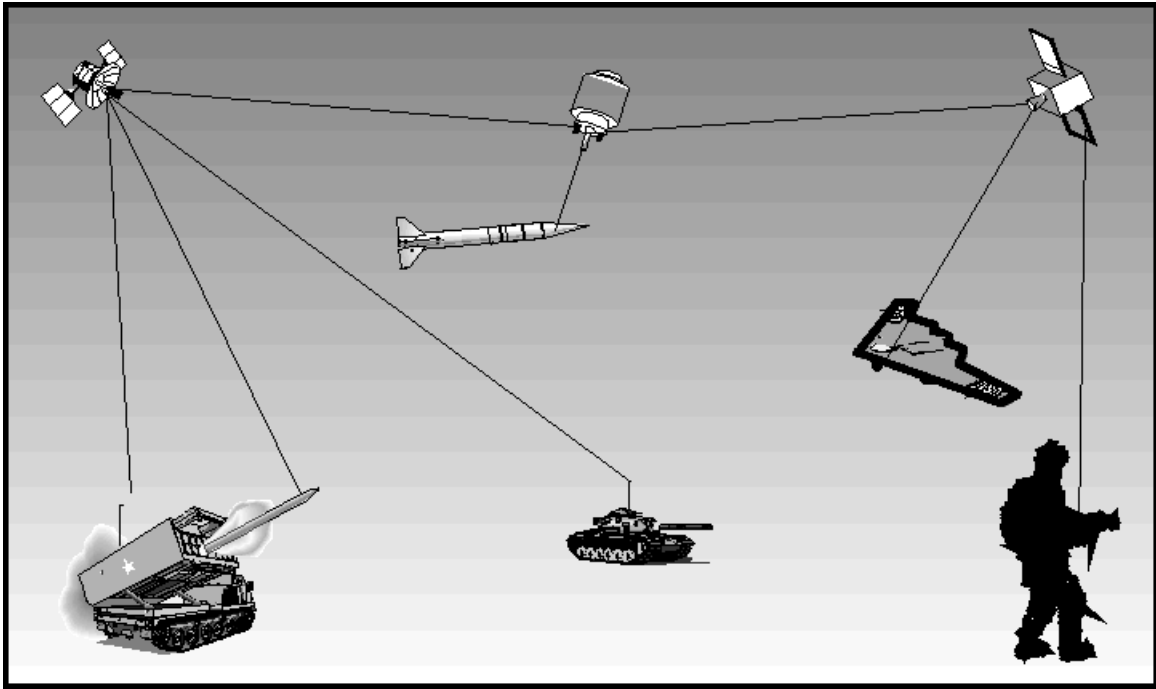

Figure B-2. Battlespace Awareness

Surveillance

Surveillance can be defined as “systematic observation of aerospace, surface, or subsurface areas, places, persons or things by visual, electronic, photographic or other means.”² The requirement for this information seems critical today, but in the much faster world of 2025, real-time information will be an absolute imperative. The most survivable and effective way of obtaining real-time surveillance in 2025 will involve networking and fusing sensory data from a wide variety of military, civil, commercial, and even foreign (allied) assets. This exciting possibility awaits technical advances in wideband communications, wide-area networks, data fusion, and above all a far greater number of fielded sensors. That industry is already moving into the area of high-resolution remote sensing (and especially satellite remote sensing) is obvious from the many recent announcements of commercial satellite imaging systems with a spatial resolution approaching one meter.³

In 2025, surveillance systems operating from space will provide the war fighter with indispensable real-time, accurate, preprocessed information. Satellite systems will provide wide spectrum coverage, including visual, infrared, RF, and active radar, for fusing with air-, sea-, and land-based networks of distributed sensors.⁴ Fusion and dissemination of surveillance data will be handled by a distributed, wide-area network of computers (probably based on microprocessors in a parallel architecture) linked by the communications system described below in the section on “utilities.” The war fighter and his weapon systems, whether air-, sea-, land-, or space-based, will be able to access this information on demand, probably in a graphically oriented format. The *Spacecast 2020* study is correct in its claim that “a system and architecture must exist to provide a high resolution ‘picture’ of objects in space, in the air, on the surface, and below the surface—be they concealed, mobile or stationary, animate or inanimate.”⁵ The real challenge will not be the collection of sufficient data, but its processing into useful, easily digested forms. This will be an ever greater challenge as the amount of types of available information grows between now and 2025.

Acquisition and Targeting

Today “sensors, computers, and communications jointly comprise the essence of targeting.”⁶ America’s main investment in these systems will be commercial by 2025, with a “sprinkling” of important, well-

protected (hardening, stealth, CONUS basing, deception), military-only or military-priority assets. This dispersion of assets will be an advantage, since properly designed, distributed systems are much more survivable than centralized, dedicated systems, and because it may be impossible to determine which portion of which physical asset is being used by the military at any one time. Surveillance and acquisition functions can and should, therefore, be provided by “off platform” distributed systems.

Targeting is a more complex and specialized function. By 2025, automated target acquisition and identification will finally be a reality. The necessary databases and specialized information processing assets can be made available through the GIN, which will also be linked to any specialized military sensor data that might be required to deal with particularly difficult targets. Automated target acquisition and identification is the subject of intense research today, and many promising approaches are being investigated on conventional supercomputers and clever, proprietary combinations of electronic and optical computers.⁷ Commercial satellite remote-sensing systems are already in development with spatial resolutions good enough to identify aircraft, surface ships, land mines, and most smaller vehicles.⁸ The results of the primarily off platform acquisition and targeting functions will then be handed off to the weapon platform, which will provide the tracking and force-application functions.

The Spacecast 2020 special study discusses a similar approach. “With appropriate algorithms and beam selection, it is conceivable that the entire sensor constellation could be available for collection all the time. Fusing of the reflected data from a single “taste” [speaking metaphorically] would take place on a central platform, probably in geosynchronous orbit.”⁹ By 2025, there will be no need for a vulnerable, central collection platform. With the continual miniaturization of computers and electronics, improved network hardware and software, and redundant wideband communication links (both optical and RF) these data collection and fusion can and should be shared among a variety of platforms, space and earth-based.¹⁰ This approach has the enormous advantage of eliminating critical nodes in the US military information system.

Battle Damage Assessment

“BDA has historically been a task of considerable difficulty because the wide range of munitions utilized, the target types attacked and the modes of attack have precluded the application of any single, reliable method.”¹¹ This problem is further complicated by our current strategy of pursuing parallel strategic attacks. By 2025, the solution to this problem will be evident in the “digital picture of the battlefield” assembled from the fused input of myriad sensors of many different types linked wirelessly to the GIN. The very system needed to survey and acquire targets will be used to assess battle damage. The advantages are obvious: cost effectiveness through elimination of redundant sensors and communications, nearly instant assessment of the need for restrike, and economy of force by avoiding the expenditure of unnecessary strikes. Additionally, accomplishing BDA through the GIN would provide instant, automatic feedback to the logistics system of the number and nature of resources expended.¹²

Utilities

During Operation Desert Storm, American and allied forces relied heavily upon space-based systems for navigation, weather information, secure communications and surveillance support. These and other space assets played a key role in the successful prosecution of the Gulf War. The reliance of the American military on these systems will only grow with time.

The quantity and quality of information that can be gained from the vantage of space enhances the power of existing terrestrial forces, both conventional and unconventional, by providing more and better information ever more rapidly. This rapid movement of information, no matter what the source, will become increasingly essential to all aspects of military operations. The near-real-time capability in communication, navigation, and weather sensing offered by the proper utilization of space assets and the opportunities they present make these functions critical to the successful military exploitation of space. No space-strike weapon system can operate without the information provided by communications, navigation, and weather systems. That is why these functions are called “utilities” in this paper.

Communications

The US military has become more and more dependent on radio frequency (RF) communications since World War II. Currently, worldwide military communications depend on several constellations of RF communications satellites, including the high-frequency (HF) and ultrahigh frequency (UHF) Defense Satellite Communications System (DSCS); the UHF, superhigh frequency (SHF), and extremely high-frequency (EHF) Fleet Satellite Communications (FLTSATCOM) and Ultrahigh Frequency Follow-On (UFO) Systems; and the secure, jam-resistant UHF, SHF, and EHF capable Milstar System.¹³ Submarine cables, fiber-optic lines, and microwave radio can compete with satellite communication systems only for geographically fixed, wideband service. Satellites are unchallenged in the area of wideband transmissions to mobile terminals, which is precisely the area of greatest need for the military.

During Operation Desert Storm, even the United States's apparently robust satellite communications architecture was overwhelmed—the coalition was forced to lease time on the INTELSAT and SKYNET systems, although the total capability was still “grossly inadequate.” The total requirement for voice, data, and video links for the Gulf War (“only” a major regional contingency) was staggering. The worldwide network assembled for Operation Desert Storm involved practically every type of commercial, strategic, and tactical telecommunication equipment available. Unsurprisingly, network management and control was “a sub-optimized, manual process—improvised on the spot and under enormous pressure for instant results.” It is now generally agreed that “a mix of military and commercial networks is the only way to provide adequate communications support in the future.”¹⁴

The most likely military communications architecture in 2025 is a shared commercial satellite communications system. This system will be based on a large constellation (hundreds or thousands) of small satellites in low earth orbit. Each satellite will be cross-linked to every other satellite with a mixture of truly wideband solid-state laser communication links (digital data rates in excess of 10 gigabytes/second) and high-speed RF back-up links (60 Ghz or greater). Most downlinks will still involve RF technology, since it is simple and inexpensive, but the most demanding traffic will have to be handled optically. Ground stations will be simple and easily relocatable, since each satellite will carry its own formidable computer brain to manage the communications traffic redundantly (the inevitable consequence of the explosion in computer processing speed and capacity). Ground line communications will be nearly nonexistent (too expensive),

except for emergency back-up systems and a few ultrasecure, jam-resistant communication systems (based on optical fiber as the only way to handle the load). In the world of 2025, every person could contact anyone, anywhere, at any time, if properly equipped.

Navigation

The Navstar GPS satellite navigation system currently provides reliable three-dimensional position information with an accuracy and precision of 16 meters and time with an accuracy of 0.1 microseconds (uncorrupted version).¹⁵ Whenever enough satellites are in view, GPS can even provide velocity and acceleration information. Combined with inexpensive commercial receivers, GPS navigation was critical to the success of coalition forces in the Gulf War. This information is good enough to pilot cruise missiles hundreds of miles to large targets and to provide targeting coordinates for modern PGMs. It is not good enough for many of the space-strike weapons described earlier in this paper, which require extreme time and position accuracies (a few nanoseconds in time, centimeters in position) to be fully effective.

The *Spacecast 2020* special study recognized the need for an improved navigation system in their Super GPS white paper.¹⁶ In 2025, such a system will be owned and controlled by civilian organizations—the Federal Aviation Agency is assuming greater control over the existing GPS constellation every day. The most likely candidates for control of the Super GPS system of 2025 are the Federal Aviation Agency (or more likely an internationalized successor) and one or more international commercial concerns. The system, based on a larger constellation of small satellites in LEO for increased coverage and on-orbit redundancy, will certainly be more accurate and precise. It is difficult to predict where the constantly evolving commercial demand for three-dimensional positioning information will be in 2025, but it is probably safe to forecast performance measured in feet (large fractions of a meter). Military demands in excess of this will be handled either by small military-owned payloads on the commercial satellites or by a small military-funded augmentation to the commercial constellation.

Weather

Military commanders have always needed timely, accurate weather information to mount successful campaigns. This need will be even more urgent in 2025, when optimal use of all forces will require real-time information on all battlefield conditions. Additionally, space-strike weapons need a mixture of space weather data and battlefield environmental data to be effective. Space-based HPMW beams can be disrupted by intense solar winds. Space-strike lasers are dispersed by water clouds and battlefield dust and smoke. Hypervelocity kinetic energy weapons must have good information concerning the state of the atmosphere to reach the proper spot on the target.

Industry is developing smaller and higher performance remote sensors with every passing day.¹⁷ Commercial demand and commercial funding is already out stripping the military's capabilities (everyone needs to know about the weather). The National Oceanic and Atmospheric Administration is already taking charge of what were once military-controlled weather satellites.¹⁸ These trends strongly suggest that long before 2025, weather-related remote sensing will be entirely controlled by industry. The commercially controlled weather monitoring and prediction system in 2025 will probably depend on a sophisticated suite of ultraminiaturized electronics and sensors operating as a secondary payload on a LEO satellite communications constellation, thereby taking advantage of existing down and cross-links. A few small weather satellites will still be parked at geosynchronous earth orbit (GEO) to take advantage of its larger-scale view of earth and to monitor "space weather" at a distance from the less-placid LEO environment. While most requirements for weather-related information in a military theater of operations will be handled by this mix of LEO and GEO weather satellites, some detailed weapon system requirements for data on surface conditions will still have to be handled by a network of ground-based sensors connected to the global information network.

Notes

¹ **2025** concept, no. 900522, "Space-Based AI-Driven Intelligence Master Mind," **2025** concepts database (Maxwell AFB, AL: Air War College/**2025**, 1996); **2025** concept, no. 900283, "Information Supremacy," **2025** concepts database (Maxwell AFB, AL: Air War College/**2025**, 1996); **2025** concept, no. 900335, "Worldwide Military Cellular Phone System," **2025** concepts database (Maxwell AFB, AL: Air

War College/2025, 1996); 2025 concept, no. 900585, "Global Location & Secure Comm," 2025 concepts database (Maxwell AFB, AL: Air War College/2025, 1996).

² Data Fusion Lexicon, Data Fusion Sub-Panel of the Joint Directors of Laboratories, "Technical Panel for C³," 11.

³ Maj James G. Lee, USAF, "Counterspace Operations for Information Dominance" (Maxwell AFB, Ala.: Air University Press, October 1994), 14–16.

⁴ 2025 concept, no. 900414, "Artificial Intelligence: A New Aircrew Member in Tomorrow's Combat," 2025 concepts database (Maxwell AFB, AL: Air War College/2025, 1996); 2025 concept, no. 900263, "The All Seeing Warrior," 2025 concepts database (Maxwell AFB, Ala.: Air War College/2025, 1996).

⁵ Spacecast 2020 study, "Global Surveillance, Reconnaissance, and Targeting System" (Maxwell AFB, Ala.: Air University Press, 1994).

⁶ Briefing by Dr Lowell Wood at Air War College, subject: Special Projects at Lawrence Livermore National Laboratory, 27 October 1993, slide 7.

⁷ Information obtained from senior industry personnel under the promise of nonattribution.

⁸ Maj James G. Lee, USAF, "Counterspace Operations for Information Dominance" (Maxwell AFB, Ala.: Air University Press, October 1994), 15. See Table 5.

⁹ Spacecast 2020 Study, "Global Surveillance, Reconnaissance, and Targeting System," Maxwell AFB, AL: Air University Press, 1994.

¹⁰ 2025 concept, no. 900370, "Molecular Manufacturing and Nanotechnology," 2025 concepts database (Maxwell AFB, AL: Air War College/2025, 1996); 2025 concept, no. 900518, "Electronic Grid - Throwaway Sensors," 2025 concepts database (Maxwell AFB, AL: Air War College/2025, 1996); 2025 concept, no. 200023, "Surveillance Swarm," 2025 concepts database (Maxwell AFB, AL: Air War College/2025, 1996); 2025 concept, no. 900231, "Gnat Robot Threat Detectors," 2025 concepts database (Maxwell AFB, Ala.: Air War College/2025, 1996).

¹¹ Carlo Kopp, "Air Warfare Applications of Laser Remote Sensing" (Fairbairn, Australia: Air Power Studies Centre), 3.

¹² 2025 concept, no. 900672, "Integrated Logistical Battlespace Sustainment," 2025 concepts database (Maxwell AFB, Ala.: Air War College/2025, 1996).

¹³ Kimberly M. Walker, USAF, "Space Operations Training Course - Chapter 9: Introduction to Communications Satellites" (Peterson AFB, Colo.: 1994), 134–148.

¹⁴ Alan Campan, *The First Information War*, AFCEA International Press, 1994; 18, 21.

¹⁵ Capt Kimberly M. Walker, Capt, USAF and Capt Tery L. Donelson, Space Operations Training Course - Chap 10: Navstar Global Positioning System" (Peterson AFB, Colo.: 1994), 152.

¹⁶ *Spacecast 2020*, "Operational Analysis" (Maxwell AFB, Ala.: Air University Press, 1994), 35.

¹⁷ Sarah L Cain, "Eyes in the Sky: Satellite Imagery Blasts Off," *Photonics Spectra*, October 1995. 90.

¹⁸ Conversations with Air Force Colonel Chuck Thompson, Air War College Space Chair, December 4 1995.

Bibliography

- 2025** Concept, No. 200009, "Pyrotechnic Electromagnetic Pulse (PEP)," **2025** Concepts Database. Maxwell AFB, Ala.: Air War College/**2025**, 1996.
- 2025** Concept, No. 200010, "Suppression Cloud," **2025** Concepts Database. Maxwell AFB, Ala.: Air War College/**2025**, 1996.
- 2025** Concept, No. 200015, "Distortion Field Projector," **2025** Concepts Database. Maxwell AFB, Ala.: Air War College/**2025**, 1996.
- 2025** Concept, No. 200018, "Space-Based Laser Designator," **2025** Concepts Database. Maxwell AFB, Ala.: Air War College/**2025**, 1996.
- 2025** Concept, No. 200023, "Surveillance Swarm," **2025** Concepts Database. Maxwell AFB, Ala.: Air War College/**2025**, 1996.
- 2025** Concept, No. 900046, "Space Marine Operational Theater," **2025** Concepts Database. Maxwell AFB, Ala.: Air War College/**2025**, 1996.
- 2025** Concept, No. 900163, "Solar Energy Weapon," **2025** Concepts Database. Maxwell AFB, Ala.: Air War College/**2025**, 1996.
- 2025** Concept, No. 900168, "Meteors as a Weapon," **2025** Concepts Database. Maxwell AFB, Ala.: Air War College/**2025**, 1996.
- 2025** Concept, No. 900181, "Blackhorse Type Outer Atmosphere Low Orbit Vehicle," **2025** Concepts Database. Maxwell AFB, Ala.: Air War College/**2025**, 1996.
- 2025** Concept, No. 900202, "Space-based Special Operations Forces," **2025** Concepts Database. Maxwell AFB, Ala.: Air War College/**2025**, 1996.
- 2025** Concept, No. 900231, "Gnat Robot Threat Detectors," **2025** Concepts Database. Maxwell AFB, Ala.: Air War College/**2025**, 1996.
- 2025** Concept, No. 900249, "Geosynchronous Manned Command and Control Module," **2025** Concepts Database. Maxwell AFB, Ala.: Air War College/**2025**, 1996.
- 2025** Concept, No. 900263, "The All Seeing Warrior," **2025** Concepts Database. Maxwell AFB, Ala.: Air War College/**2025**, 1996.
- 2025** Concept, No. 900265, "Space Storage Modules To Establish Space-sourced Air Drop Capability," **2025** Concepts Database. Maxwell AFB, Ala.: Air War College/**2025**, 1996.
- 2025** Concept, No. 900270, "EMP Pills," **2025** Concepts Database. Maxwell AFB, Ala.: Air War College/**2025**, 1996.
- 2025** Concept, No. 900288, "Swarms of Micromachines," **2025** Concepts Database. Maxwell AFB, Ala.: Air War College/**2025**, 1996.
- 2025** Concept, No. 900313, "Spaceborne/Airborne Hologram," **2025** Concepts Database. Maxwell AFB, Ala.: Air War College/**2025**, 1996.
- 2025** Concept, No. 900335, "Worldwide Military Cellular Phone System," **2025** Concepts Database. Maxwell AFB, Ala.: Air War College/**2025**, 1996.

- 2025 Concept, No. 900338, "Stealth Technology," 2025 Concepts Database Maxwell AFB, Ala.: Air War College/2025, 1996.
- 2025 Concept, No. 900370, "Molecular Manufacturing and Nanotechnology," 2025 Concepts Database. Maxwell AFB, Ala.: Air War College/2025, 1996.
- 2025 Concept, No. 900390, "Holographic Battlefield Deception," 2025 Concepts Database. Maxwell AFB, Ala.: Air War College/2025, 1996.
- 2025 Concept, No. 900414, "Artificial Intelligence: A New Aircrew Member in Tomorrow's Combat," 2025 Concepts Database. Maxwell AFB, Ala.: Air War College/2025, 1996.
- 2025 Concept, No. 900420, "Laser Attack Station," 2025 Concepts Database. Maxwell AFB, Ala.: Air War College/2025, 1996.
- 2025 Concept, No. 900426, "Atmospheric Disturbance," 2025 Concepts Database. Maxwell AFB, Ala.: Air War College/2025, 1996.
- 2025 Concept, No. 900452, "Space based Satellite Body Guard," 2025 Concepts Database. Maxwell AFB, Ala.: Air War College/2025, 1996.
- 2025 Concept, No. 900518, "Electronic Grid - Throwaway Sensors," 2025 Concepts Database. Maxwell AFB, Ala.: Air War College/2025, 1996.
- 2025 Concept, No. 900522, "Space-Based AI-Driven Intelligence Master Mind," 2025 Concepts Database. Maxwell AFB, Ala.: Air War College/2025, 1996.
- 2025 Concept, No. 900552, "On-demand Tactical Recce Satellite Constellation," (PROPRIETARY), 2025 Concepts Database. Maxwell AFB, Ala.: Air War College/2025, 1996.
- 2025 Concept, No. 900570, "Deceptive Holographic Imaging," 2025 Concepts Database. Maxwell AFB, Ala.: Air War College/2025, 1996.
- 2025 Concept, No. 900585, "Global Location & Secure Comm," 2025 Concepts Database. Maxwell AFB, Ala.: Air War College/2025, 1996.
- 2025 Concept, No. 900610, "Hoversatt," 2025 Concepts Database. Maxwell AFB, Ala.: Air War College/2025, 1996.
- 2025 Concept, No. 900654, "Parts Locker," 2025 Concepts Database. Maxwell AFB, Ala.: Air War College/2025, 1996.
- 2025 Concept, No. 900672, "Integrated Logistical Battlespace Sustainment," 2025 Concepts Database. Maxwell AFB, Ala.: Air War College/2025, 1996.
- 2025 Concept, No. 900696, "Global, Rapid Response Space Sortie," 2025 Concepts Database. Maxwell AFB, Ala.: Air War College/2025, 1996.
- 2025 Concept, No. 900756, "Holographic Deception Operations," 2025 Concepts Database. Maxwell AFB, Ala.: Air War College/2025, 1996.
- 2025 Concept, No. 900792, "Holographic CCD," 2025 Concepts Database. Maxwell AFB, Ala.: Air War College/2025, 1996.
- Air Force Doctrine Document 1, Air Force Basic Doctrine, first draft, 15 August 1995, 3.
- Air Force Manual 1-1, *Basic Aerospace Doctrine of the United States Air Force*, vol. 2, essay L, March 1992.
- Anonymous assessor comment on first draft of Space Operations white paper, 2025 Concepts Database. Maxwell AFB, Ala.: Air War College/2025, 1996.
- Baird, Lt Col Henry., et al. "Spacelift - Integration of Aerospace Core Competencies." AF 2025 study. Maxwell AFB, Ala.: Air War College, 1996.

Balcer, Dr Bill. Phillips Lab. briefing, subject: "Transient Electromagnetic Technology and Future Space-control," provided to AF Spacecast 2020 Study, 20 Oct 1993.

Boyd, John R. "A Discourse on Winning and Losing." August 1987. A collection of unpublished briefings and essays. Air University Library, Document No. M-U 43947.

Bradley, Dr William, Laser Effects course, Air Force Institute of Technology (AFIT) Wright-Patterson AFB, Ohio, 1984.

Briefing. McDonnell Douglas/Boeing, subject: "Future Expansions in Space," 25 June 1995.

Briefing. S. J. Navickas, subject: "Mission Area Vision - Force Application," 10 November 1992.

Briefing. *New World Vistas* Directed Energy group briefing (chairman MAJ Gen Donald Lamberson, USAF (Ret), 10 April 1995.

Briefing. *New World Vistas* Surveillance & Warning Panel briefing, 10 April 1995.

Briefing. Phillips Laboratory's Advanced Weapons and Survivability Directorate, subject: On-going Research in the Directorate, 4 December 1995. Provided to AF **2025** study team,

Briefing. Phillips Laboratory's Lasers and Imaging Directorate, subject: On-going Research in the Directorate, November 1995. Present to AF **2025** study team,.

Briefing. Phillips Laboratory PL/VT-X, subject: On-going Research in the Directorate, January 1996. Provided to AF **2025** study team.

Briefing. Wierzbowski, Col Ted, "National Aerospace Plane and Airbreathing Single-Stage-to-Orbit," 19 October 1993. Presented to 2020 study team,

Briefing . Wood, Dr Lowell, Special projects at Lawrence Livermore National Laboratory, 27 October 1993. Provided to Spacecast 2020 study team.

Broad, William J., "Meteoroids Hit Atmosphere in Atomic-Size Blasts." *New York Times*, 25 January 1994.

Cain, Sarah L. "Eyes in the Sky: Satellite Imagery Blasts Off." *Photonics Spectra*, October 1995.

Campan, Alan. *The First Information War*, AFCEA International Press, 1994.

Canavan, Gregory and Edward Teller, "Strategic Defense for the 1990s." *Nature* 334, 19 April 1990.

Carmichael, Lt Col Bruce W. et al. "Strikestar **2025**." AF **2025** study. Maxwell AFB, Ala.: Air War College, 1996.

Carter, CDR Clarence E., et al. "The 'Man in the Chair' - Cornerstone of Global Battlespace Dominance." AF **2025** study. Maxwell AFB, Ala.: Air War College, 1996.

Data Fusion Lexicon. Data Fusion Sub-Panel of the Joint Directors of Laboratories "Technical Panel for C³".

Davies, Paul, ed. *The New Physics*, Cambridge, UK: Cambridge University Press, 1989.

Department of Defense. "Joint Planning Document FY 1998-2003" vol. 4 Future Capabilities. 15 December 1995.

Fogleman, Gen Ronald E., USAF, and Sheila E. Widnall. *Global Presence 1995*, Washington, D.C.: HQ USAF, pamphlet, 1995.

Global Reach-Global Power. Washington, D.C.: HQ USAF, white paper, 1992.

Halliday, David and Robert Resnick *Fundamental of Physics*. 3d ed. New York, N.Y.: John Wiley and Sons, 1988.

Hawes, Maj Timothy, USAF. "Commercial Use of Satellite Imagery." *Program Manager* 24, no. 2 March-April 1995.

Internet. Available from: www.pas.nps.navy.mil/railgun.html.

Internet. 14 February 1996, available from: <http://www.contribu.cmu.edu/usr/fjo4/>.

Jackson, J. D. *Classical Electrodynamics*. 2d ed. New York, N.Y.: John Wiley and Sons, 1975.

James, Lt Col Larry D. USAF, "Dual Use Alternatives for DOD Space Systems," Maxwell AFB, Ala.: Air War College Research Report, April 1993.

"Joint Vision 2010 - America's Military: Shaping the Future," a publication of the Joint Staff provided to AF 2025 by AF/XOXS, January 1996.

Kandebo, Stanley W. "'Air Spike' Could Ease Hypersonic Flight Problems." *Aviation Week and Space Technology*, 19 May 1995.

Kopp, Carlo, "Air Warfare Applications of Laser Remote Sensing" Fairbairn, Australia: Air Power Studies Centre.

"A Doctrine for the Use of Electromagnetic Pulse Bombs." Fairbairn ACT, Australia: Air Power Studies Centre (ISBN 0 642 19343 6), July 1993.

Lee, Maj James G., USAF. "Counterspace Operations for Information Dominance" Maxwell AFB, Ala.: Air University Press, October 1994.

Lynch, David J. "Spacepower Comes to the Squadron." *Air Force Magazine*, vol. 77, no. 9 (September 1994).

Milonni, Peter W. and Joseph H. Eberly. *Lasers*. New York, N.Y.: John Wiley and Sons, 1988.

Moyle, John, Memorandum entitled "Thoughts on the Revolution in Military Affairs," from the Strategic Assessment Center to Mr. Jeff McKittrick and Colonel Richard Szafranski, 5 January 1996.

Murphy, Lt Col Edward F. et al., "Information Operations: Wisdom Warfare for 2025," AF 2025 study. Maxwell AFB, Ala.: Air War College, 1996.

Nielson, Dr Phillip. Plasma Physics course, Air Force Institute of Technology, Wright-Patterson AFB, Ohio, 1978.

Osborne, Lt Col William, et al. "Information Operations: A New Warfighting Capability." AF 2025 study. Maxwell AFB, Ala.: Air War College, 1996.

Petersen, John L. *The Road to 2015*. Corte Madera, Calif.: Waite Group Press, 1994.

Schaeffer Associates. Memorandum to Capt Clapp, USAF. 4 February 1994.

Shields, LtCol Brad, et al. "Weather as a Force Multiplier - Owning the Weather in 2025." AF 2025 study. Maxwell AFB, Ala.: Air War College, 1996.

"Space and the Army's Future." A Discussion Paper-as-Briefing, 26 January 1996.

Spacecast 2020, "Force Application." Maxwell AFB, Ala.: Air University Press, 1994.

Spacecast 2020, "Global Surveillance, Reconnaissance, and Targeting System." Maxwell AFB, Ala.: Air University Press, 1994.

Spacecast 2020, "Operational Analysis." Maxwell AFB, Ala.: Air University Press, 1994.

Spacecast 2020, "Refueled Transatmospheric Vehicle." Maxwell AFB, Ala.: Air University Press, 1994.

Spacecast 2020, "Space Lift: Suborbital, Earth to Orbit, and On-Orbit." Maxwell AFB, Ala.: Air University Press, 1994.

Tatum, John T. "A New Threat to Aircraft Survivability: Radio Frequency Directed Energy Weapons (RF DEW)." US Army Research Laboratory, Adelphi, M.d.

Thibault, George E. *The Art and Practice of Military Strategy*. Washington, D.C.: National Defense University Press, 1984.

Tiernan, Maj Michael J., et al. "In-Time Information Integration System (I³S)." AF 2025 study Maxwell AFB, Ala.: Air War College, 1996.

- Torgerson, Maj Thomas A., USAF, "Global Power Through Tactical Flexibly Deployable Space Units." Maxwell AFB, Ala.: Air University Press, Research Report AU-ARI-93-6, June 1994.
- USAF Scientific Advisory Board. *New World Vistas: Air and Space Power for the 21st Century*, Summary Volume. Washington, D.C.: USAF Scientific Advisory Board, 15 December 1995.
- US GAO Report. "Ballistic Missile Defense - Information on Directed Energy Programs for FY 1985 Through 1993." Washington, D.C.: Government publication, GAO/NSIAD-93-182, June 1993.
- Walker, Capt Kimberly M., USAF. "Space Operations Training Course - Chapter 9: Introduction to Communications Satellites." Peterson AFB, Colo.: 1994.
- Walker, Capt Kimberly M., USAF and Capt Tery L. Donelson, "Space Operations Training Course - Chapter 10: Navstar Global Positioning System." Peterson AFB, Colo.: 1994.
- Weast, Robert C., Editor-in-chief. *Handbook of Chemistry and Physics*. Boca Raton, Fla.: CRC Press, Inc., 1984.
- Westenhoff, Lt Col Charles M., USAF, compiler. *Military Air Power-The CADRE Digest of Air Power Opinions and Thoughts*, Airpower Research Institute, Air University Press, Maxwell AFB, Ala.. October, 1990.
- Yariv, Amnon. *Introduction to Optical Electronics*, 2d ed. New York, N.Y.: Holt, Rinehart, and Winston, 1976.
- Zielinski, Lt Col Robert H., et al. "Star Tek - Exploiting the Final Frontier - Counterspace Operations in 2025." AF 2025 study Maxwell AFB, Ala.: Air War College, 1996.

Weather as a Force Multiplier: Owning the Weather in 2025



A Research Paper
Presented To

Air Force *2025*

by

Col Tamzy J. House
Lt Col James B. Near, Jr.
LTC William B. Shields (USA)
Maj Ronald J. Celentano
Maj David M. Husband
Maj Ann E. Mercer
Maj James E. Pugh

August 1996

Disclaimer

2025 is a study designed to comply with a directive from the chief of staff of the Air Force to examine the concepts, capabilities, and technologies the United States will require to remain the dominant air and space force in the future. Presented on 17 June 1996, this report was produced in the Department of Defense school environment of academic freedom and in the interest of advancing concepts related to national defense. The views expressed in this report are those of the authors and do not reflect the official policy or position of the United States Air Force, Department of Defense, or the United States government.

This report contains fictional representations of future situations/scenarios. Any similarities to real people or events, other than those specifically cited, are unintentional and are for purposes of illustration only.

This publication has been reviewed by security and policy review authorities, is unclassified, and is cleared for public release.

Contents

<i>Chapter</i>	<i>Page</i>
Disclaimer	ii
Illustrations.....	iv
Tables.....	iv
Acknowledgments.....	v
Executive Summary	vi
1 Introduction.....	1
2 Required Capability.....	3
Why Would We Want to Mess with the Weather?	3
What Do We Mean by “Weather-modification”?.....	4
3 System Description	8
The Global Weather Network.....	8
Applying Weather-modification to Military Operations	10
4 Concept of Operations	13
Precipitation	13
Fog.....	16
Storms.....	18
Exploitation of “NearSpace” for Space Control.....	20
Opportunities Afforded by Space Weather-modification.....	20
Communications Dominance via Ionospheric Modification.....	21
Artificial Weather.....	27
Concept of Operations Summary.....	28
5 Investigation Recommendations.....	31
How Do We Get There From Here?.....	31
Conclusions	34
Appendix	Page
A Why Is the Ionosphere Important?	36
B Research to Better Understand and Predict Ionospheric Effects.....	39
C Acronyms and Definitions	41
Bibliography.....	42

Illustrations

<i>Figure</i>	<i>Page</i>
3-1. Global Weather Network.....	9
3-2. The Military System for Weather-Modification Operations.	11
4-1. Crossed-Beam Approach for Generating an Artificial Ionospheric Mirror	23
4-2. Artificial Ionospheric Mirrors Point-to-Point Communications	24
4-3. Artificial Ionospheric Mirror Over-the-Horizon Surveillance Concept.	25
4-4. Scenarios for Telecommunications Degradation	26
5-1. A Core Competency Road Map to Weather Modification in 2025.	32
5-2. A Systems Development Road Map to Weather Modification in 2025.....	34

Tables

<i>Table</i>	<i>Page</i>
1 Operational Capabilities Matrix.....	vi

Acknowledgments

We express our appreciation to Mr Mike McKim of Air War College who provided a wealth of technical expertise and innovative ideas that significantly contributed to our paper. We are also especially grateful for the devoted support of our families during this research project. Their understanding and patience during the demanding research period were crucial to the project's success.

Executive Summary

In 2025, US aerospace forces can “own the weather” by capitalizing on emerging technologies and focusing development of those technologies to war-fighting applications. Such a capability offers the war fighter tools to shape the battlespace in ways never before possible. It provides opportunities to impact operations across the full spectrum of conflict and is pertinent to all possible futures. The purpose of this paper is to outline a strategy for the use of a future weather-modification system to achieve military objectives rather than to provide a detailed technical road map.

A high-risk, high-reward endeavor, weather-modification offers a dilemma not unlike the splitting of the atom. While some segments of society will always be reluctant to examine controversial issues such as weather-modification, the tremendous military capabilities that could result from this field are ignored at our own peril. From enhancing friendly operations or disrupting those of the enemy via small-scale tailoring of natural weather patterns to complete dominance of global communications and counterspace control, weather-modification offers the war fighter a wide-range of possible options to defeat or coerce an adversary. Some of the potential capabilities a weather-modification system could provide to a war-fighting commander in chief (CINC) are listed in table 1.

Technology advancements in five major areas are necessary for an integrated weather-modification capability: (1) advanced nonlinear modeling techniques, (2) computational capability, (3) information gathering and transmission, (4) a global sensor array, and (5) weather intervention techniques. Some intervention tools exist today and others may be developed and refined in the future.

Table 1

Operational Capabilities Matrix

DEGRADE ENEMY FORCES

ENHANCE FRIENDLY FORCES

Precipitation Enhancement

- Flood Lines of Communication
- Reduce PGM/Recce Effectiveness
- Decrease Comfort Level/Morale

Storm Enhancement

- Deny Operations

Precipitation Denial

- Deny Fresh Water
- Induce Drought

Space Weather

- Disrupt Communications/Radar
- Disable/Destroy Space Assets

Fog and Cloud Removal

- Deny Concealment
- Increase Vulnerability to PGM/Recce

Detect Hostile Weather Activities

Precipitation Avoidance

- Maintain/Improve LOC
- Maintain Visibility
- Maintain Comfort Level/Morale

Storm Modification

- Choose Battlespace Environment

Space Weather

- Improve Communication Reliability
- Intercept Enemy Transmissions
- Revitalize Space Assets

Fog and Cloud Generation

- Increase Concealment

Fog and Cloud Removal

- Maintain Airfield Operations
- Enhance PGM Effectiveness

Defend against Enemy Capabilities

Current technologies that will mature over the next 30 years will offer anyone who has the necessary resources the ability to modify weather patterns and their corresponding effects, at least on the local scale. Current demographic, economic, and environmental trends will create global stresses that provide the impetus necessary for many countries or groups to turn this weather-modification ability into a capability.

In the United States, weather-modification will likely become a part of national security policy with both domestic and international applications. Our government will pursue such a policy, depending on its interests, at various levels. These levels could include unilateral actions, participation in a security framework such as NATO, membership in an international organization such as the UN, or participation in a coalition. Assuming that in 2025 our national security strategy includes weather-modification, its use in our national military strategy will naturally follow. Besides the significant benefits an operational capability would provide, another motivation to pursue weather-modification is to deter and counter potential adversaries.

In this paper we show that appropriate application of weather-modification can provide battlespace dominance to a degree never before imagined. In the future, such operations will enhance air and space superiority and provide new options for battlespace shaping and battlespace awareness.¹ “The technology is there, waiting for us to pull it all together;”² in 2025 we can “Own the Weather.”

Notes

¹ The weather-modification capabilities described in this paper are consistent with the operating environments and missions relevant for aerospace forces in 2025 as defined by AF/LR, a long-range planning office reporting to the CSAF [based on AF/LR PowerPoint briefing “Air and Space Power Framework for Strategy Development (jda-2lr.ppt)].”

² General Gordon R. Sullivan, “Moving into the 21st Century: America’s Army and Modernization,” *Military Review* (July 1993) quoted in Mary Ann Seagraves and Richard Szymer, “Weather a Force Multiplier,” *Military Review*, November/December 1995, 75.

Chapter 1

Introduction

Scenario: Imagine that in 2025 the US is fighting a rich, but now consolidated, politically powerful drug cartel in South America. The cartel has purchased hundreds of Russian-and Chinese-built fighters that have successfully thwarted our attempts to attack their production facilities. With their local numerical superiority and interior lines, the cartel is launching more than 10 aircraft for every one of ours. In addition, the cartel is using the French *system probatoire d' observation de la terre* (SPOT) positioning and tracking imagery systems, which in 2025 are capable of transmitting near-real-time, multispectral imagery with 1 meter resolution. The US wishes to engage the enemy on an uneven playing field in order to exploit the full potential of our aircraft and munitions.

Meteorological analysis reveals that equatorial South America typically has afternoon thunderstorms on a daily basis throughout the year. Our intelligence has confirmed that cartel pilots are reluctant to fly in or near thunderstorms. Therefore, our weather force support element (WFSE), which is a part of the commander in chief's (CINC) air operations center (AOC), is tasked to forecast storm paths and trigger or intensify thunderstorm cells over critical target areas that the enemy must defend with their aircraft. Since our aircraft in 2025 have all-weather capability, the thunderstorm threat is minimal to our forces, and we can effectively and decisively control the sky over the target.

The WFSE has the necessary sensor and communication capabilities to observe, detect, and act on weather-modification requirements to support US military objectives. These capabilities are part of an advanced battle area system that supports the war-fighting CINC. In our scenario, the CINC tasks the WFSE to conduct storm intensification and concealment operations. The WFSE models the atmospheric conditions

to forecast, with 90 percent confidence, the likelihood of successful modification using airborne cloud generation and seeding.

In 2025, uninhabited aerospace vehicles (UAV) are routinely used for weather-modification operations. By cross-referencing desired attack times with wind and thunderstorm forecasts and the SPOT satellite's projected orbit, the WFSE generates mission profiles for each UAV. The WFSE guides each UAV using near-real-time information from a networked sensor array.

Prior to the attack, which is coordinated with forecasted weather conditions, the UAVs begin cloud generation and seeding operations. UAVs disperse a cirrus shield to deny enemy visual and infrared (IR) surveillance. Simultaneously, microwave heaters create localized scintillation to disrupt active sensing via synthetic aperture radar (SAR) systems such as the commercially available Canadian search and rescue satellite-aided tracking (SARSAT) that will be widely available in 2025. Other cloud seeding operations cause a developing thunderstorm to intensify over the target, severely limiting the enemy's capability to defend. The WFSE monitors the entire operation in real-time and notes the successful completion of another very important but routine weather-modification mission.

This scenario may seem far-fetched, but by 2025 it is within the realm of possibility. The next chapter explores the reasons for weather-modification, defines the scope, and examines trends that will make it possible in the next 30 years.

Chapter 2

Required Capability

Why Would We Want to Mess with the Weather?

According to Gen Gordon Sullivan, former Army chief of staff, “As we leap technology into the 21st century, we will be able to see the enemy day or night, in any weather— and go after him relentlessly.”¹ A global, precise, real-time, robust, systematic weather-modification capability would provide war-fighting CINCs with a powerful force multiplier to achieve military objectives. Since weather will be common to all possible futures, a weather-modification capability would be universally applicable and have utility across the entire spectrum of conflict. The capability of influencing the weather even on a small scale could change it from a force degrader to a force multiplier.

People have always wanted to be able to do something about the weather. In the US, as early as 1839, newspaper archives tell of people with serious and creative ideas on how to make rain.² In 1957, the president’s advisory committee on weather control explicitly recognized the military potential of weather-modification, warning in their report that it could become a more important weapon than the atom bomb.³

However, controversy since 1947 concerning the possible legal consequences arising from the deliberate alteration of large storm systems meant that little future experimentation could be conducted on storms which had the potential to reach land.⁴ In 1977, the UN General Assembly adopted a resolution prohibiting the hostile use of environmental modification techniques. The resulting “Convention on the Prohibition of Military or Any Other Hostile Use of Environmental Modification Technique (ENMOD)”

committed the signatories to refrain from any military or other hostile use of weather-modification which could result in widespread, long-lasting, or severe effects.⁵ While these two events have not halted the pursuit of weather-modification research, they have significantly inhibited its pace and the development of associated technologies, while producing a primary focus on suppressive versus intensification activities.

The influence of the weather on military operations has long been recognized. During World War II, Eisenhower said,

[i]n Europe bad weather is the worst enemy of the air [operations]. Some soldier once said, "The weather is always neutral." Nothing could be more untrue. Bad weather is obviously the enemy of the side that seeks to launch projects requiring good weather, or of the side possessing great assets, such as strong air forces, which depend upon good weather for effective operations. If really bad weather should endure permanently, the Nazi would need nothing else to defend the Normandy coast!⁶

The impact of weather has also been important in more recent military operations. A significant number of the air sorties into Tuzla during the initial deployment supporting the Bosnian peace operation aborted due to weather. During Operation Desert Storm, Gen Buster C. Glosson asked his weather officer to tell him which targets would be clear in 48 hours for inclusion in the air tasking order (ATO).⁷ But current forecasting capability is only 85 percent accurate for no more than 24 hours, which doesn't adequately meet the needs of the ATO planning cycle. Over 50 percent of the F-117 sorties weather aborted over their targets and A-10s only flew 75 of 200 scheduled close air support (CAS) missions due to low cloud cover during the first two days of the campaign.⁸ The application of weather-modification technology to clear a hole over the targets long enough for F-117s to attack and place bombs on target or clear the fog from the runway at Tuzla would have been a very effective force multiplier. Weather-modification clearly has potential for military use at the operational level to reduce the elements of fog and friction for friendly operations and to significantly increase them for the enemy.

What Do We Mean by "Weather-modification"?

Today, weather-modification is the alteration of weather phenomena over a limited area for a limited period of time.⁹ Within the next three decades, the concept of weather-modification could expand to include the ability to shape weather patterns by influencing their determining factors.¹⁰ Achieving such a highly

accurate and reasonably precise weather-modification capability in the next 30 years will require overcoming some challenging but not insurmountable technological and legal hurdles.

Technologically, we must have a solid understanding of the variables that affect weather. We must be able to model the dynamics of their relationships, map the possible results of their interactions, measure their actual real-time values, and influence their values to achieve a desired outcome. Society will have to provide the resources and legal basis for a mature capability to develop. How could all of this happen? The following notional scenario postulates how weather-modification might become both technically feasible and socially desirable by 2025.

Between now and 2005, technological advances in meteorology and the demand for more precise weather information by global businesses will lead to the successful identification and parameterization of the major variables that affect weather. By 2015, advances in computational capability, modeling techniques, and atmospheric information tracking will produce a highly accurate and reliable weather prediction capability, validated against real-world weather. In the following decade, population densities put pressure on the worldwide availability and cost of food and usable water. Massive life and property losses associated with natural weather disasters become increasingly unacceptable. These pressures prompt governments and/or other organizations who are able to capitalize on the technological advances of the previous 20 years to pursue a highly accurate and reasonably precise weather-modification capability. The increasing urgency to realize the benefits of this capability stimulates laws and treaties, and some unilateral actions, making the risks required to validate and refine it acceptable. By 2025, the world, or parts of it, are able to shape local weather patterns by influencing the factors that affect climate, precipitation, storms and their effects, fog, and near space. These highly accurate and reasonably precise civil applications of weather-modification technology have obvious military implications. This is particularly true for aerospace forces, for while weather may affect all mediums of operation, it operates in ours.

The term weather-modification may have negative connotations for many people, civilians and military members alike. It is thus important to define the scope to be considered in this paper so that potential critics or proponents of further research have a common basis for discussion.

In the broadest sense, weather-modification can be divided into two major categories: suppression and intensification of weather patterns. In extreme cases, it might involve the creation of completely new weather

patterns, attenuation or control of severe storms, or even alteration of global climate on a far-reaching and/or long-lasting scale. In the mildest and least controversial cases it may consist of inducing or suppressing precipitation, clouds, or fog for short times over a small-scale region. Other low-intensity applications might include the alteration and/or use of near space as a medium to enhance communications, disrupt active or passive sensing, or other purposes. In conducting the research for this study, the broadest possible interpretation of weather-modification was initially embraced, so that the widest range of opportunities available for our military in 2025 were thoughtfully considered. However, for several reasons described below, this paper focuses primarily on localized and short-term forms of weather-modification and how these could be incorporated into war-fighting capability. The primary areas discussed include generation and dissipation of precipitation, clouds, and fog; modification of localized storm systems; and the use of the ionosphere and near space for space control and communications dominance. These applications are consistent with CJCSI 3810.01, *“Meteorological and Oceanographic Operations.”*¹¹

Extreme and controversial examples of weather modification—creation of made-to-order weather, large-scale climate modification, creation and/or control (or “steering”) of severe storms, etc.—were researched as part of this study but receive only brief mention here because, in the authors’ judgment, the technical obstacles preventing their application appear insurmountable within 30 years.¹² If this were not the case, such applications would have been included in this report as potential military options, despite their controversial and potentially malevolent nature and their inconsistency with standing UN agreements to which the US is a signatory.

On the other hand, the weather-modification applications proposed in this report range from technically proven to potentially feasible. They are similar, however, in that none are currently employed or envisioned for employment by our operational forces. They are also similar in their potential value for the war fighter of the future, as we hope to convey in the following chapters. A notional integrated system that incorporates weather-modification tools will be described in the next chapter; how those tools might be applied are then discussed within the framework of the Concept of Operations in chapter 4.

¹ Gen Gordon R. Sullivan, "Moving into the 21st Century: America's Army and Modernization," *Military Review* (July 1993) quoted in Mary Ann Seagraves and Richard Szymber, "Weather a Force Multiplier," *Military Review*, November/December 1995, 75.

² Horace R. Byers, "History of Weather-modification," in Wilmot N. Hess, ed. *Weather and Climate Modification*, (New York: John Wiley & Sons, 1974), 4.

³ William B. Meyer, "The Life and Times of US Weather: What Can We Do About It?" *American Heritage* 37, no. 4 (June/July 1986), 48.

⁴ Byers, 13.

⁵ US Department of State, *The Department of State Bulletin*. 74, no. 1981 (13 June 1977): 10.

⁶ Dwight D Eisenhower. "Crusade in Europe," quoted in John F. Fuller, *Thor's Legions* (Boston: American Meteorology Society, 1990), 67.

⁷ Interview of Lt Col Gerald F. Riley, Staff Weather Officer to CENTCOM OIC of CENTAF Weather Support Force and Commander of 3rd Weather Squadron, in "Desert Shield/Desert Storm Interview Series," by Dr William E. Narwyn, AWS Historian, 29 May 1991.

⁸ Thomas A. Keaney and Eliot A. Cohen. *Gulf War Air Power Survey Summary Report* (Washington D.C.: Government Printing Office, 1993), 172.

⁹ Herbert S. Appleman, *An Introduction to Weather-modification* (Scott AFB, Ill.: Air Weather Service/MAC, September 1969), 1.

¹⁰ William Bown, "Mathematicians Learn How to Tame Chaos," *New Scientist*, 30 May 1992, 16.

¹¹ CJCSI 3810.01, *Meteorological and Oceanographic Operations*, 10 January 95. This CJCS Instruction establishes policy and assigns responsibilities for conducting meteorological and oceanographic operations. It also defines the terms widespread, long-lasting, and severe, in order to identify those activities that US forces are prohibited from conducting under the terms of the UN Environmental Modification Convention. Widespread is defined as encompassing an area on the scale of several hundred km; long-lasting means lasting for a period of months, or approximately a season; and severe involves serious or significant disruption or harm to human life, natural and economic resources, or other assets.

¹² Concern about the unintended consequences of attempting to "control" the weather is well justified. Weather is a classic example of a chaotic system (i.e., a system that never exactly repeats itself). A chaotic system is also extremely sensitive: minuscule differences in conditions greatly affect outcomes. According to Dr. Glenn James, a widely published chaos expert, technical advances may provide a means to predict *when* weather transitions will occur and the magnitude of the inputs required to cause those transitions; however, it will never be possible to precisely predict changes that occur as a result of our inputs. The chaotic nature of weather also limits our ability to make accurate long-range forecasts. The renowned physicist Edward Teller recently presented calculations he performed to determine the long-range weather forecasting improvement that would result from a satellite constellation providing continuous atmospheric measurements over a 1 km² grid worldwide. Such a system, which is currently cost-prohibitive, would only improve long-range forecasts from the current five days to approximately 14 days. Clearly, there are definite physical limits to mankind's ability to control nature, but the extent of those physical limits remains an open question. Sources: G. E. James, "Chaos Theory: The Essentials for Military Applications," in *ACSC Theater Air Campaign Studies Coursebook*, AY96, 8 (Maxwell AFB, Ala: Air University Press, 1995), 1-64. The Teller calculations are cited in Reference 49 of this source.

Chapter 3

System Description

Our vision is that by 2025 the military could influence the weather on a mesoscale (<200 km²) or microscale (immediate local area) to achieve operational capabilities such as those listed in Table 1. The capability would be the synergistic result of a system consisting of (1) highly trained weather force specialists (WFS) who are members of the CINC's weather force support element (WFSE); (2) access ports to the global weather network (GWN), where worldwide weather observations and forecasts are obtained near-real-time from civilian and military sources; (3) a dense, highly accurate local area weather sensing and communication system; (4) an advanced computer local area weather-modification modeling and prediction capability within the area of responsibility (AOR); (5) proven weather-modification intervention technologies; and (6) a feedback capability.

The Global Weather Network

The GWN is envisioned to be an evolutionary expansion of the current military and civilian worldwide weather data network. By 2025, it will be a super high-speed, expanded bandwidth, communication network filled with near-real-time weather observations taken from a denser and more accurate worldwide observation network resulting from highly improved ground, air, maritime, and space sensors. The network will also provide access to forecast centers around the world where sophisticated, tailored forecast and data products, generated from weather prediction models (global, regional, local, specialized, etc.) based on the latest nonlinear mathematical techniques are made available to GWN customers for near-real-time use.

By 2025, we envision that weather prediction models, in general, and mesoscale weather-modification models, in particular, will be able to emulate all-weather producing variables, along with their interrelated dynamics, and prove to be highly accurate in stringent measurement trials against empirical data. The brains of these models will be advanced software and hardware capabilities which can rapidly ingest trillions of environmental data points, merge them into usable data bases, process the data through the weather prediction models, and disseminate the weather information over the GWN in near-real-time.¹ This network is depicted schematically in figure 3-1.

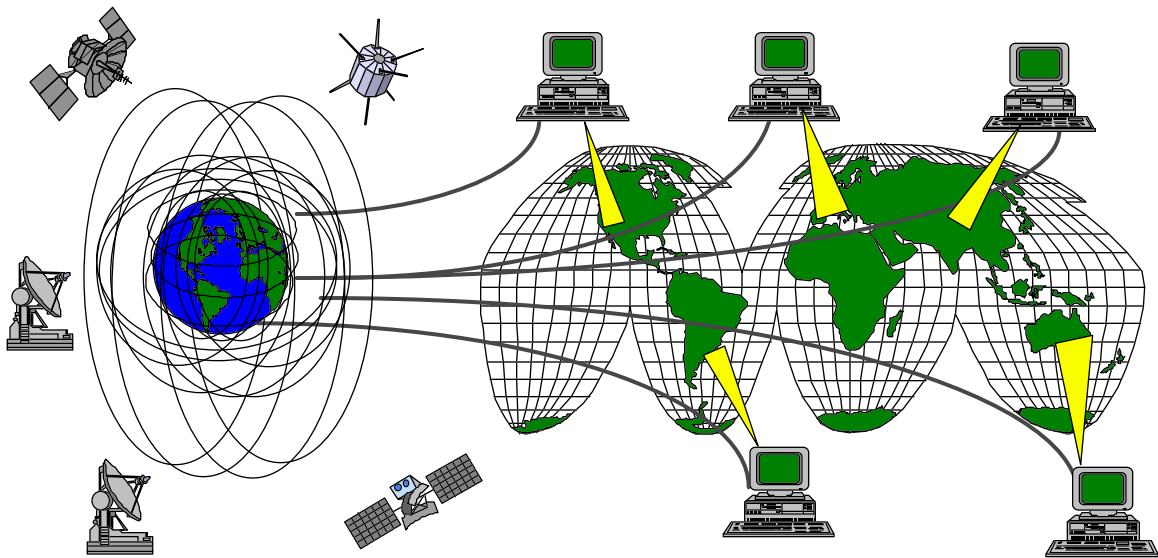

Source: Microsoft Clipart Gallery © 1995 with courtesy from Microsoft.

Figure 3-1. Global Weather Network

Evidence of the evolving future weather modeling and prediction capability as well as the GWN can be seen in the national oceanic and atmospheric administration's (NOAA) 1995–2005 strategic plan. It includes program elements to "advance short-term warning and forecast services, implement seasonal to inter-annual climate forecasts, and predict and assess decadal to centennial change;"² it does not, however, include plans for weather-modification modeling or modification technology development. NOAA's plans include extensive data gathering programs such as Next Generation Radar (NEXRAD) and Doppler weather surveillance systems deployed throughout the US. Data from these sensing systems feed into over 100 forecast centers for processing by the Advanced Weather Interactive Processing System (AWIPS), which will provide data communication, processing, and display capabilities for extensive forecasting. In addition,

NOAA has leased a Cray C90 supercomputer capable of performing over 1.5×10^{10} operations per second that has already been used to run a Hurricane Prediction System.³

Applying Weather-modification to Military Operations

How will the military, in general, and the USAF, in particular, manage and employ a weather-modification capability? We envision this will be done by the weather force support element (WFSE), whose primary mission would be to support the war-fighting CINC's with weather-modification options, in addition to current forecasting support. Although the WFSE could operate anywhere as long as it has access to the GWN and the system components already discussed, it will more than likely be a component within the AOC or its 2025-equivalent. With the CINC's intent as guidance, the WFSE formulates weather-modification options using information provided by the GWN, local weather data network, and weather-modification forecast model. The options include range of effect, probability of success, resources to be expended, the enemy's vulnerability, and risks involved. The CINC chooses an effect based on these inputs, and the WFSE then implements the chosen course, selecting the right modification tools and employing them to achieve the desired effect. Sensors detect the change and feed data on the new weather pattern to the modeling system which updates its forecast accordingly. The WFSE checks the effectiveness of its efforts by pulling down the updated current conditions and new forecast(s) from the GWN and local weather data network, and plans follow-on missions as needed. This concept is illustrated in figure 3-2.

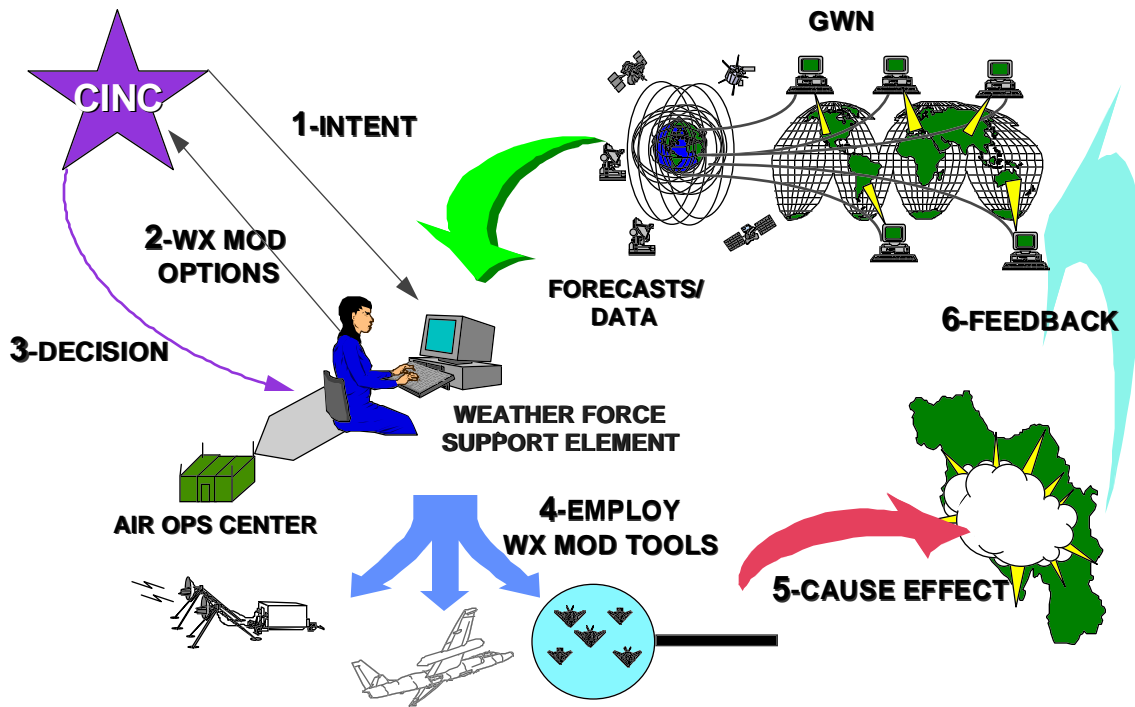

Source: Microsoft Clipart Gallery © 1995 with courtesy from Microsoft.

Figure 3-2. The Military System for Weather-Modification Operations.

WFSE personnel will need to be experts in information systems and well schooled in the arts of both offensive and defensive information warfare. They would also have an in-depth understanding of the GWN and an appreciation for how weather-modification could be employed to meet a CINC's needs.

Because of the nodal web nature of the GWN, this concept would be very flexible. For instance, a WFSE could be assigned to each theater to provide direct support to the CINC. The system would also be survivable, with multiple nodes connected to the GWN.

A product of the information age, this system would be most vulnerable to information warfare. Each WFSE would need the most current defensive and offensive information capabilities available. Defensive abilities would be necessary for survival. Offensive abilities could provide spoofing options to create virtual weather in the enemy's sensory and information systems, making it more likely for them to make decisions producing results of our choosing rather than theirs. It would also allow for the capability to mask or disguise our weather-modification activities.

Two key technologies are necessary to meld an integrated, comprehensive, responsive, precise, and effective weather-modification system. Advances in the science of chaos are critical to this endeavor. Also key to the feasibility of such a system is the ability to model the extremely complex nonlinear system of global weather in ways that can accurately predict the outcome of changes in the influencing variables. Researchers have already successfully controlled single variable nonlinear systems in the lab and hypothesize that current mathematical techniques and computer capacity could handle systems with up to five variables. Advances in these two areas would make it feasible to affect regional weather patterns by making small, continuous nudges to one or more influencing factors. Conceivably, with enough lead time and the right conditions, you could get “made-to-order” weather.⁴

Developing a true weather-modification capability will require various intervention tools to adjust the appropriate meteorological parameters in predictable ways. It is this area that must be developed by the military based on specific required capabilities such as those listed in table 1, table 1 is located in the Executive Summary. Such a system would contain a sensor array and localized battle area data net to provide the fine level of resolution required to detect intervention effects and provide feedback. This net would include ground, air, maritime, and space sensors as well as human observations in order to ensure the reliability and responsiveness of the system, even in the event of enemy countermeasures. It would also include specific intervention tools and technologies, some of which already exist and others which must be developed. Some of these proposed tools are described in the following chapter titled Concept of Operations. The total weather-modification process would be a real-time loop of continuous, appropriate, measured interventions, and feedback capable of producing desired weather behavior.

Notes

¹ SPACECAST 2020, *Space Weather Support for Communications*, white paper G (Maxwell AFB, Ala.: Air War College/2020, 1994).

² Rear Adm Sigmund Petersen, “NOAA Moves Toward The 21st Century,” *The Military Engineer* 20, no. 571 (June-July 1995): 44.

³ Ibid.

⁴ William Brown, “Mathematicians Learn How to Tame Chaos,” *New Scientist* (30 May 1992): 16.

Chapter 4

Concept of Operations

The essential ingredient of the weather-modification system is the set of intervention techniques used to modify the weather. The number of specific intervention methodologies is limited only by the imagination, but with few exceptions they involve infusing either energy or chemicals into the meteorological process in the right way, at the right place and time. The intervention could be designed to modify the weather in a number of ways, such as influencing clouds and precipitation, storm intensity, climate, space, or fog.

Precipitation

For centuries man has desired the ability to influence precipitation at the time and place of his choosing. Until recently, success in achieving this goal has been minimal; however, a new window of opportunity may exist resulting from development of new technologies and an increasing world interest in relieving water shortages through precipitation enhancement. Consequently, we advocate that the DOD explore the many opportunities (and also the ramifications) resulting from development of a capability to influence precipitation or conducting “selective precipitation modification.” Although the capability to influence precipitation over the long term (i.e., for more than several days) is still not fully understood. By 2025 we will certainly be capable of increasing or decreasing precipitation over the short term in a localized area.

Before discussing research in this area, it is important to describe the benefits of such a capability. While many military operations may be influenced by precipitation, ground mobility is most affected. Influencing precipitation could prove useful in two ways. First, enhancing precipitation could decrease the

enemy's trafficability by muddying terrain, while also affecting their morale. Second, suppressing precipitation could increase friendly trafficability by drying out an otherwise muddied area.

What is the possibility of developing this capability and applying it to tactical operations by 2025? Closer than one might think. Research has been conducted in precipitation modification for many years, and an aspect of the resulting technology was applied to operations during the Vietnam War.¹ These initial attempts provide a foundation for further development of a true capability for selective precipitation modification.

Interestingly enough, the US government made a conscious decision to stop building upon this foundation. As mentioned earlier, international agreements have prevented the US from investigating weather-modification operations that could have widespread, long-lasting, or severe effects. However, possibilities do exist (within the boundaries of established treaties) for using localized precipitation modification over the short term, with limited and potentially positive results.

These possibilities date back to our own previous experimentation with precipitation modification. As stated in an article appearing in the *Journal of Applied Meteorology*,

[n]early all the weather-modification efforts over the last quarter century have been aimed at producing changes on the cloud scale through exploitation of the saturated vapor pressure difference between ice and water. This is not to be criticized but it is time we also consider the feasibility of weather-modification on other time-space scales and with other physical hypotheses.²

This study by William M. Gray, et al., investigated the hypothesis that “significant beneficial influences can be derived through judicious exploitation of the solar absorption potential of carbon black dust.”³ The study ultimately found that this technology could be used to enhance rainfall on the mesoscale, generate cirrus clouds, and enhance cumulonimbus (thunderstorm) clouds in otherwise dry areas.

The technology can be described as follows. Just as a black tar roof easily absorbs solar energy and subsequently radiates heat during a sunny day, carbon black also readily absorbs solar energy. When dispersed in microscopic or “dust” form in the air over a large body of water, the carbon becomes hot and heats the surrounding air, thereby increasing the amount of evaporation from the body of water below. As the surrounding air heats up, parcels of air will rise and the water vapor contained in the rising air parcel will eventually condense to form clouds. Over time the cloud droplets increase in size as more and more water vapor condenses, and eventually they become too large and heavy to stay suspended and will fall as rain or

other forms of precipitation.⁴ The study points out that this precipitation enhancement technology would work best “upwind from coastlines with onshore flow.” Lake-effect snow along the southern edge of the Great Lakes is a naturally occurring phenomenon based on similar dynamics.

Can this type of precipitation enhancement technology have military applications? Yes, if the right conditions exist. For example, if we are fortunate enough to have a fairly large body of water available upwind from the targeted battlefield, carbon dust could be placed in the atmosphere over that water. Assuming the dynamics are supportive in the atmosphere, the rising saturated air will eventually form clouds and rainshowers downwind over the land.⁵ While the likelihood of having a body of water located upwind of the battlefield is unpredictable, the technology could prove enormously useful under the right conditions. Only further experimentation will determine to what degree precipitation enhancement can be controlled.

If precipitation enhancement techniques are successfully developed and the right natural conditions also exist, we must also be able to disperse carbon dust into the desired location. Transporting it in a completely controlled, safe, cost-effective, and reliable manner requires innovation. Numerous dispersal techniques have already been studied, but the most convenient, safe, and cost-effective method discussed is the use of afterburner-type jet engines to generate carbon particles while flying through the targeted air. This method is based on injection of liquid hydrocarbon fuel into the afterburner’s combustion gases. This direct generation method was found to be more desirable than another plausible method (i.e., the transport of large quantities of previously produced and properly sized carbon dust to the desired altitude).

The carbon dust study demonstrated that small-scale precipitation enhancement is possible and has been successfully verified under certain atmospheric conditions. Since the study was conducted, no known military applications of this technology have been realized. However, we can postulate how this technology might be used in the future by examining some of the delivery platforms conceivably available for effective dispersal of carbon dust or other effective modification agents in the year 2025.

One method we propose would further maximize the technology’s safety and reliability, by virtually eliminating the human element. To date, much work has been done on UAVs which can closely (if not completely) match the capabilities of piloted aircraft. If this UAV technology were combined with stealth and carbon dust technologies, the result could be a UAV aircraft invisible to radar while en route to the targeted area, which could spontaneously create carbon dust in any location. However, minimizing the number of

UAVs required to complete the mission would depend upon the development of a new and more efficient system to produce carbon dust by a follow-on technology to the afterburner-type jet engines previously mentioned. In order to effectively use stealth technology, this system must also have the ability to disperse carbon dust while minimizing (or eliminating) the UAV's infrared heat source.

In addition to using stealth UAV and carbon dust absorption technology for precipitation enhancement, this delivery method could also be used for precipitation suppression. Although the previously mentioned study did not significantly explore the possibility of cloud seeding for precipitation suppression, this possibility does exist. If clouds were seeded (using chemical nuclei similar to those used today or perhaps a more effective agent discovered through continued research) before their downwind arrival to a desired location, the result could be a suppression of precipitation. In other words, precipitation could be "forced" to fall before its arrival in the desired territory, thereby making the desired territory "dry." The strategic and operational benefits of doing this have previously been discussed.

Fog

In general, successful fog dissipation requires some type of heating or seeding process. Which technique works best depends on the type of fog encountered. In simplest terms, there are two basic types of fog—cold and warm. Cold fog occurs at temperatures below 32°F. The best-known dissipation technique for cold fog is to seed it from the air with agents that promote the growth of ice crystals.⁶

Warm fog occurs at temperatures above 32°F and accounts for 90 percent of the fog-related problems encountered by flight operations.⁷ The best-known dissipation technique is heating because a small temperature increase is usually sufficient to evaporate the fog. Since heating usually isn't practical, the next most effective technique is hygroscopic seeding.⁸ Hygroscopic seeding uses agents that absorb water vapor. This technique is most effective when accomplished from the air but can also be accomplished from the ground.⁹ Optimal results require advance information on fog depth, liquid water content, and wind.¹⁰

Decades of research show that fog dissipation is an effective application of weather-modification technology with demonstrated savings of huge proportions for both military and civil aviation.¹¹ Local

municipalities have also shown an interest in applying these techniques to improve the safety of high-speed highways transiting areas of frequently occurring dense fog.¹²

There are some emerging technologies which may have important applications for fog dispersal. As discussed earlier, heating is the most effective dispersal method for the most commonly occurring type of fog. Unfortunately, it has proved impractical for most situations and would be difficult at best for contingency operations. However, the development of directed radiant energy technologies, such as microwaves and lasers, could provide new possibilities.

Lab experiments have shown microwaves to be effective for the heat dissipation of fog. However, results also indicate that the energy levels required exceed the US large power density exposure limit of 100 watt/m² and would be very expensive.¹³ Field experiments with lasers have demonstrated the capability to dissipate warm fog at an airfield with zero visibility. Generating 1 watt/cm², which is approximately the US large power density exposure limit, the system raised visibility to one quarter of a mile in 20 seconds.¹⁴ Laser systems described in the Space Operations portion of this AF 2025 study could certainly provide this capability as one of their many possible uses.

With regard to seeding techniques, improvements in the materials and delivery methods are not only plausible but likely. Smart materials based on nanotechnology are currently being developed with gigapops computer capability at their core. They could adjust their size to optimal dimensions for a given fog seeding situation and even make adjustments throughout the process. They might also enhance their dispersal qualities by adjusting their buoyancy, by communicating with each other, and by steering themselves within the fog. They will be able to provide immediate and continuous effectiveness feedback by integrating with a larger sensor network and can also change their temperature and polarity to improve their seeding effects.¹⁵ As mentioned above, UAVs could be used to deliver and distribute these smart materials.

Recent army research lab experiments have demonstrated the feasibility of generating fog. They used commercial equipment to generate thick fog in an area 100 meters long. Further study has shown fogs to be effective at blocking much of the UV/IR/visible spectrum, effectively masking emitters of such radiation from IR weapons.¹⁶ This technology would enable a small military unit to avoid detection in the IR spectrum. Fog could be generated to quickly, conceal the movement of tanks or infantry, or it could conceal military

operations, facilities, or equipment. Such systems may also be useful in inhibiting observations of sensitive rear-area operations by electro-optical reconnaissance platforms.¹⁷

Storms

The desirability to modify storms to support military objectives is the most aggressive and controversial type of weather-modification. The damage caused by storms is indeed horrendous. For instance, a tropical storm has an energy equal to 10,000 one-megaton hydrogen bombs,¹⁸ and in 1992 Hurricane Andrew totally destroyed Homestead AFB, Florida, caused the evacuation of most military aircraft in the southeastern US, and resulted in \$15.5 billion of damage.¹⁹ However, as one would expect based on a storm's energy level, current scientific literature indicates that there are definite physical limits on mankind's ability to modify storm systems. By taking this into account along with political, environmental, economic, legal, and moral considerations, we will confine our analysis of storms to localized thunderstorms and thus do not consider major storm systems such as hurricanes or intense low-pressure systems.

At any instant there are approximately 2,000 thunderstorms taking place. In fact 45,000 thunderstorms, which contain heavy rain, hail, microbursts, wind shear, and lightning form daily.²⁰ Anyone who has flown frequently on commercial aircraft has probably noticed the extremes that pilots will go to avoid thunderstorms. The danger of thunderstorms was clearly shown in August 1985 when a jumbo jet crashed killing 137 people after encountering microburst wind shears during a rain squall.²¹ These forces of nature impact all aircraft and even the most advanced fighters of 1996 make every attempt to avoid a thunderstorm.

Will bad weather remain an aviation hazard in 2025? The answer, unfortunately, is "yes," but projected advances in technology over the next 30 years will diminish the hazard potential. Computer-controlled flight systems will be able to "autopilot" aircraft through rapidly changing winds. Aircraft will also have highly accurate, onboard sensing systems that can instantaneously "map" and automatically guide the aircraft through the safest portion of a storm cell. Aircraft are envisioned to have hardened electronics that can withstand the effects of lightning strikes and may also have the capability to generate a surrounding electropotential field that will neutralize or repel lightning strikes.

Assuming that the US achieves some or all of the above outlined aircraft technical advances and maintains the technological “weather edge” over its potential adversaries, we can next look at how we could modify the battlespace weather to make the best use of our technical advantage.

Weather-modification technologies might involve techniques that would increase latent heat release in the atmosphere, provide additional water vapor for cloud cell development, and provide additional surface and lower atmospheric heating to increase atmospheric instability. Critical to the success of any attempt to trigger a storm cell is the pre-existing atmospheric conditions locally and regionally. The atmosphere must already be conditionally unstable and the large-scale dynamics must be supportive of vertical cloud development. The focus of the weather-modification effort would be to provide additional “conditions” that would make the atmosphere unstable enough to generate cloud and eventually storm cell development. The path of storm cells once developed or enhanced is dependent not only on the mesoscale dynamics of the storm but the regional and synoptic (global) scale atmospheric wind flow patterns in the area which are currently not subject to human control.

As indicated, the technical hurdles for storm development in support of military operations are obviously greater than enhancing precipitation or dispersing fog as described earlier. One area of storm research that would significantly benefit military operations is lightning modification. Most research efforts are being conducted to develop techniques to lessen the occurrence or hazards associated with lightning. This is important research for military operations and resource protection, but some offensive military benefit could be obtained by doing research on increasing the potential and intensity of lightning. Concepts to explore include increasing the basic efficiency of the thunderstorm, stimulating the triggering mechanism that initiates the bolt, and triggering lightning such as that which struck Apollo 12 in 1968.²² Possible mechanisms to investigate would be ways to modify the electropotential characteristics over certain targets to induce lightning strikes on the desired targets as the storm passes over their location.

In summary, the ability to modify battlespace weather through storm cell triggering or enhancement would allow us to exploit the technological “weather” advances of our 2025 aircraft; this area has tremendous potential and should be addressed by future research and concept development programs.

Exploitation of “NearSpace” for Space Control

This section discusses opportunities for control and modification of the ionosphere and near-space environment for force enhancement; specifically to enhance our own communications, sensing, and navigation capabilities and/or impair those of our enemy. A brief technical description of the ionosphere and its importance in current communications systems is provided in appendix A.

By 2025, it may be possible to modify the ionosphere and near space, creating a variety of potential applications, as discussed below. However, before ionospheric modification becomes possible, a number of evolutionary advances in space weather forecasting and observation are needed. Many of these needs were described in a Spacecast 2020 study, Space Weather Support for Communications.²³ Some of the suggestions from this study are included in appendix B; it is important to note that our ability to exploit near space via active modification is dependent on successfully achieving reliable observation and prediction capabilities.

Opportunities Afforded by Space Weather-modification

Modification of the near-space environment is crucial to battlespace dominance. General Charles Horner, former commander in chief, United States space command, described his worst nightmare as “seeing an entire Marine battalion wiped out on some foreign landing zone because he was unable to deny the enemy intelligence and imagery generated from space.”²⁴ Active modification could provide a “technological fix” to jam the enemy’s active and passive surveillance and reconnaissance systems. In short, *an operational capability to modify the near-space environment would ensure space superiority in 2025; this capability would allow us to shape and control the battlespace via enhanced communication, sensing, navigation, and precision engagement systems.*

While we recognize that technological advances may negate the importance of certain electromagnetic frequencies for US aerospace forces in 2025 (such as radio frequency (RF), high-frequency (HF) and very high-frequency (VHF) bands), the capabilities described below are nevertheless relevant. Our nonpeer

adversaries will most likely still depend on such frequencies for communications, sensing, and navigation and would thus be extremely vulnerable to disruption via space weather-modification.

Communications Dominance via Ionospheric Modification

Modification of the ionosphere to enhance or disrupt communications has recently become the subject of active research. According to Lewis M. Duncan, and Robert L. Showen, the Former Soviet Union (FSU) conducted theoretical and experimental research in this area at a level considerably greater than comparable programs in the West.²⁵ There is a strong motivation for this research, because

induced ionospheric modifications may influence, or even disrupt, the operation of radio systems relying on propagation through the modified region. The controlled generation or accelerated dissipation of ionospheric disturbances may be used to produce new propagation paths, otherwise unavailable, appropriate for selected RF missions.²⁶

A number of methods have been explored or proposed to modify the ionosphere, including injection of chemical vapors and heating or charging via electromagnetic radiation or particle beams (such as ions, neutral particles, x-rays, MeV particles, and energetic electrons).²⁷ It is important to note that many techniques to modify the upper atmosphere have been successfully demonstrated experimentally. Ground-based modification techniques employed by the FSU include vertical HF heating, oblique HF heating, microwave heating, and magnetospheric modification.²⁸ Significant military applications of such operations include low frequency (LF) communication production, HF ducted communications, and creation of an artificial ionosphere (discussed in detail below). Moreover, developing countries also recognize the benefit of ionospheric modification: “in the early 1980’s, Brazil conducted an experiment to modify the ionosphere by chemical injection.”²⁹

Several high-payoff capabilities that could result from the modification of the ionosphere or near space are described briefly below. It should be emphasized that this list is not comprehensive; modification of the ionosphere is an area rich with potential applications and there are also likely spin-off applications that have yet to be envisioned.

Ionospheric mirrors for pinpoint communication or over-the-horizon (OTH) radar transmission.

The properties and limitations of the ionosphere as a reflecting medium for high-frequency radiation are

described in appendix A. The major disadvantage in depending on the ionosphere to reflect radio waves is its variability, which is due to normal space weather and events such as solar flares and geomagnetic storms. The ionosphere has been described as a crinkled sheet of wax paper whose relative position rises and sinks depending on weather conditions. The surface topography of the crinkled paper also constantly changes, leading to variability in its reflective, refractive, and transmissive properties.

Creation of an artificial uniform ionosphere was first proposed by Soviet researcher A. V. Gurevich in the mid-1970s. An artificial ionospheric mirror (AIM) would serve as a precise mirror for electromagnetic radiation of a selected frequency or a range of frequencies. It would thereby be useful for both pinpoint control of friendly communications and interception of enemy transmissions.

This concept has been described in detail by Paul A. Kossey, et al. in a paper entitled “Artificial Ionospheric Mirrors (AIM).”³⁰ The authors describe how one could precisely control the location and height of the region of artificially produced ionization using crossed microwave (MW) beams, which produce atmospheric breakdown (ionization) of neutral species. The implications of such control are enormous: one would no longer be subject to the vagaries of the natural ionosphere but would instead have direct control of the propagation environment. Ideally, the AIM could be rapidly created and then would be maintained only for a brief operational period. A schematic depicting the crossed-beam approach for generation of an AIM is shown in figure 4-1.³¹

An AIM could theoretically reflect radio waves with frequencies up to 2 GHz, which is nearly two orders of magnitude higher than those waves reflected by the natural ionosphere. The MW radiator power requirements for such a system are roughly an order of magnitude greater than 1992 state-of-the-art systems; however, by 2025 such a power capability is expected to be easily achievable.

NORMAL IONOSPHERIC REFLECTING LAYERS (100-300 km)

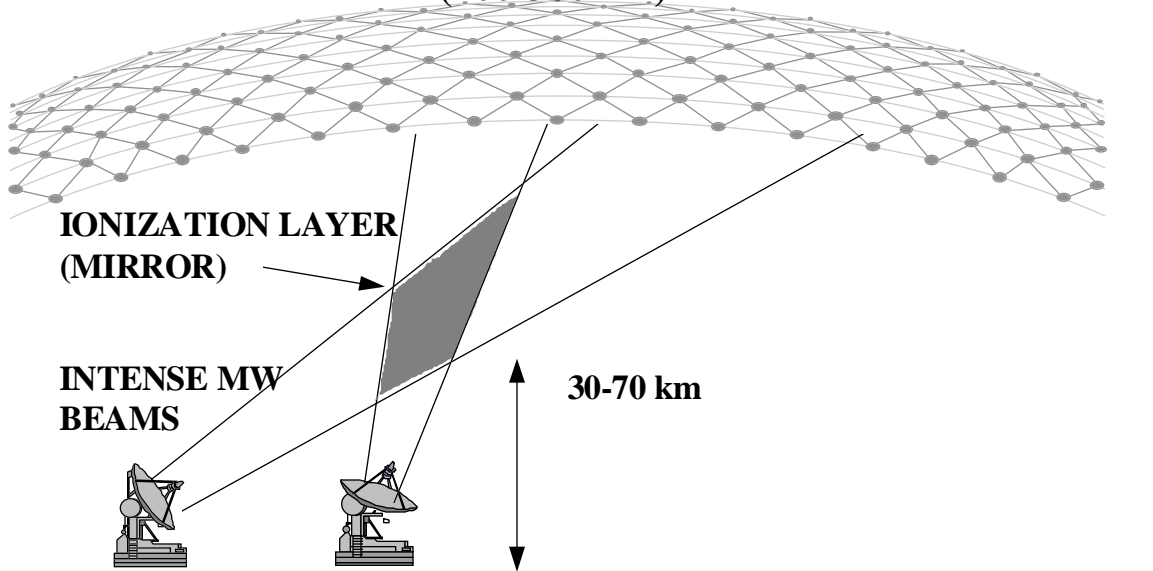

Source: Microsoft Clipart Gallery © 1995 with courtesy from Microsoft.

Figure 4-1. Crossed-Beam Approach for Generating an Artificial Ionospheric Mirror

Besides providing pinpoint communication control and potential interception capability, this technology would also provide communication capability at specified frequencies, as desired. Figure 4-2 shows how a ground-based radiator might generate a series of AIMs, each of which would be tailored to reflect a selected transmission frequency. Such an arrangement would greatly expand the available bandwidth for communications and also eliminate the problem of interference and crosstalk (by allowing one to use the requisite power level).

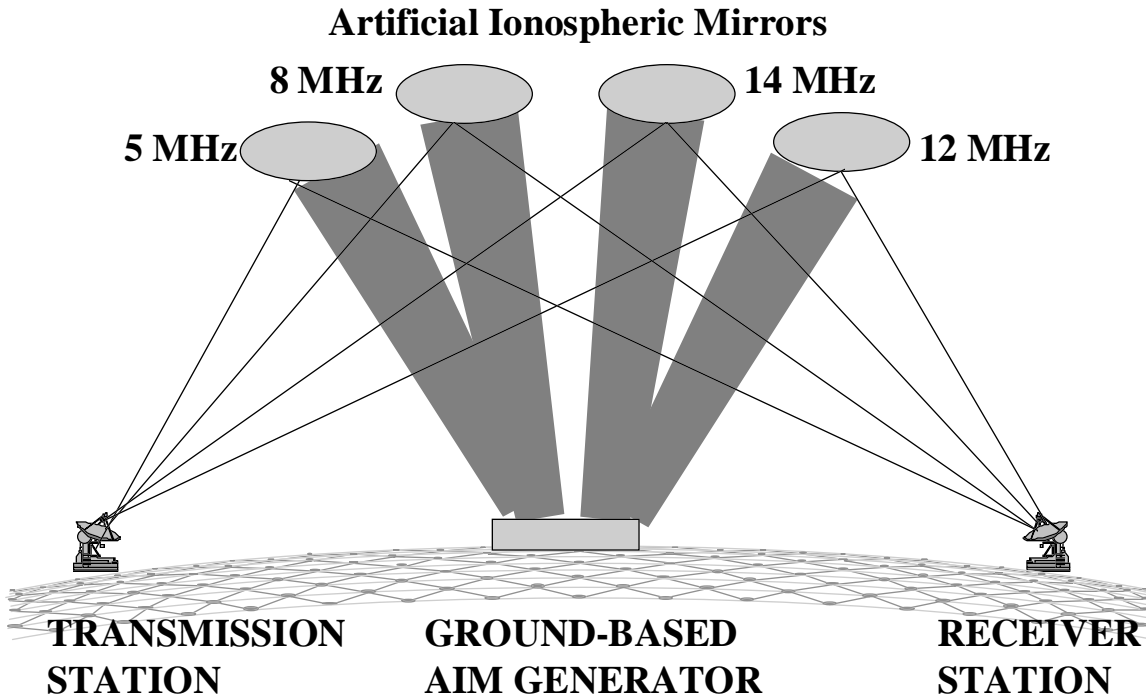

Source: Microsoft Clipart Gallery © 1995 with courtesy from Microsoft.

Figure 4-2. Artificial Ionospheric Mirrors Point-to-Point Communications

Kossey et al. also describe how AIMs could be used to improve the capability of OTH radar:

AIM based radar could be operated at a frequency chosen to optimize target detection, rather than be limited by prevailing ionospheric conditions. This, combined with the possibility of controlling the radar's wave polarization to mitigate clutter effects, could result in reliable detection of cruise missiles and other low observable targets.³²

A schematic depicting this concept is shown in figure 4-3. Potential advantages over conventional OTH radars include frequency control, mitigation of auroral effects, short range operation, and detection of a smaller cross-section target.

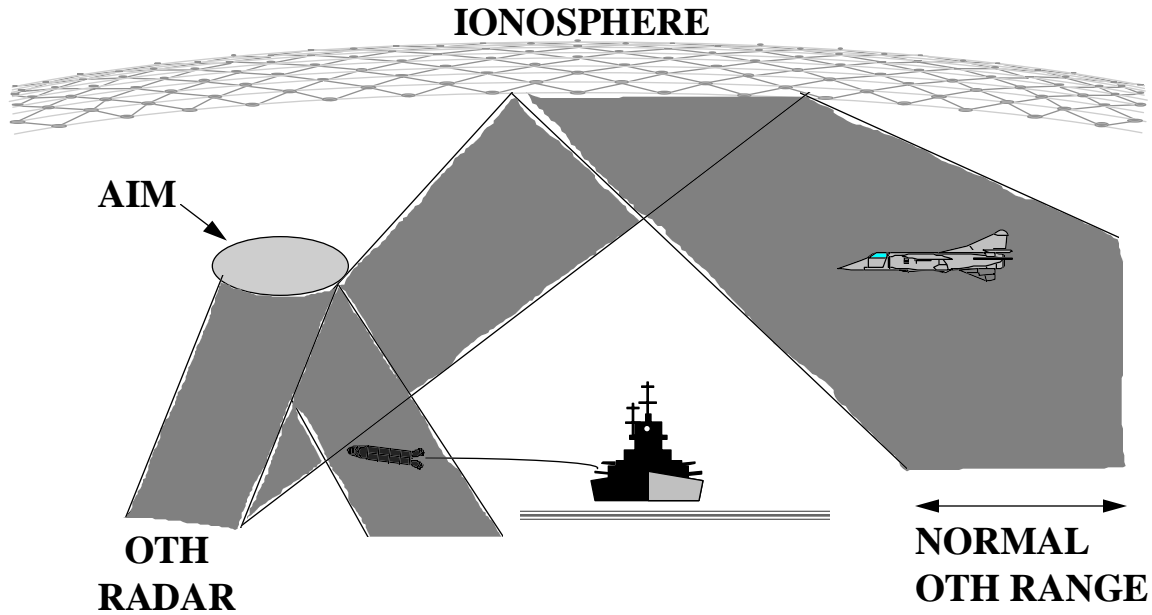

Source: Microsoft Clipart Gallery © 1995 with courtesy from Microsoft.

Figure 4-3. Artificial Ionospheric Mirror Over-the-Horizon Surveillance Concept.

Disruption of communications and radar via ionospheric control. A variation of the capability proposed above is ionospheric modification to disrupt an enemy's communication or radar transmissions. Because HF communications are controlled directly by the ionosphere's properties, an artificially created ionization region could conceivably disrupt an enemy's electromagnetic transmissions. Even in the absence of an artificial ionization patch, high-frequency modification produces large-scale ionospheric variations which alter HF propagation characteristics. The payoff of research aimed at understanding how to control these variations could be high as both HF communication enhancement and degradation are possible. Offensive interference of this kind would likely be indistinguishable from naturally occurring space weather. This capability could also be employed to precisely locate the source of enemy electromagnetic transmissions.

VHF, UHF, and super-high frequency (SHF) satellite communications could be disrupted by creating artificial ionospheric scintillation. This phenomenon causes fluctuations in the phase and amplitude of radio waves over a very wide band (30 MHz to 30 GHz). HF modification produces electron density irregularities that cause scintillation over a wide-range of frequencies. The size of the irregularities determines which frequency band will be affected. Understanding how to control the spectrum of the artificial irregularities

generated in the HF modification process should be a primary goal of research in this area. Additionally, it may be possible to suppress the growth of natural irregularities resulting in reduced levels of natural scintillation. Creating artificial scintillation would allow us to disrupt satellite transmissions over selected regions. Like the HF disruption described above, such actions would likely be indistinguishable from naturally occurring environmental events. Figure 4-4 shows how artificially ionized regions might be used to disrupt HF communications via attenuation, scatter, or absorption (fig. 4.4a) or degrade satellite communications via scintillation or energy loss (fig. 4-4b) (from Ref. 25).

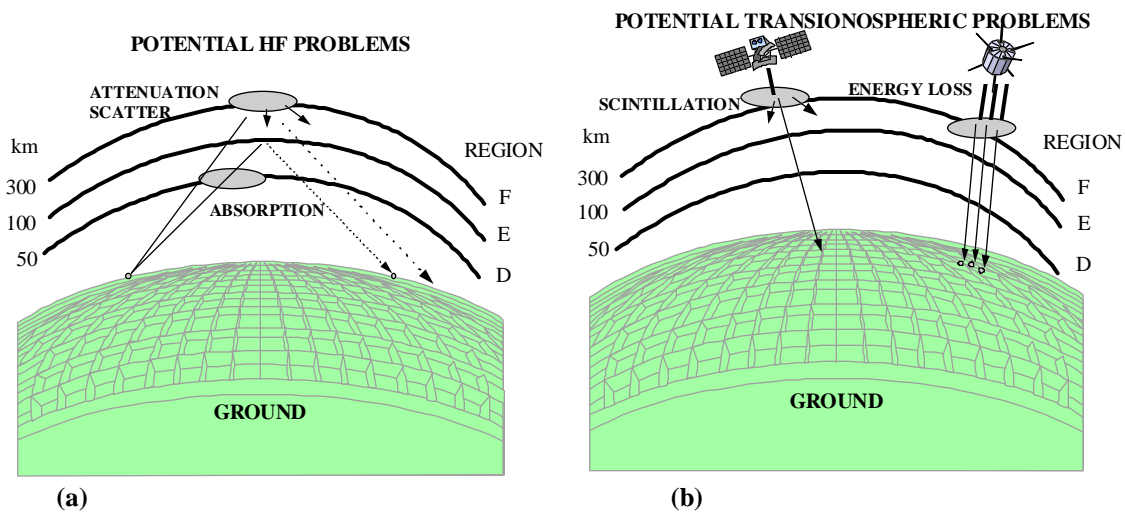

Source: Microsoft Clipart Gallery © 1995 with courtesy from Microsoft.

Figure 4-4. Scenarios for Telecommunications Degradation

Exploding/disabling space assets traversing near-space. The ionosphere could potentially be artificially charged or injected with radiation at a certain point so that it becomes inhospitable to satellites or other space structures. The result could range from temporarily disabling the target to its complete destruction via an induced explosion. Of course, effectively employing such a capability depends on the ability to apply it selectively to chosen regions in space.

Charging space assets by near-space energy transfer. In contrast to the injurious capability described above, regions of the ionosphere could potentially be modified or used as-is to revitalize space assets, for instance by charging their power systems. The natural charge of the ionosphere may serve to provide most or all of the energy input to the satellite. There have been a number of papers in the last decade on electrical

charging of space vehicles; however, according to one author, “in spite of the significant effort made in the field both theoretically and experimentally, the vehicle charging problem is far from being completely understood.”³³ While the technical challenge is considerable, the potential to harness electrostatic energy to fuel the satellite’s power cells would have a high payoff, enabling service life extension of space assets at a relatively low cost. Additionally, exploiting the capability of powerful HF radio waves to accelerate electrons to relatively high energies may also facilitate the degradation of enemy space assets through directed bombardment with the HF-induced electron beams. As with artificial HF communication disruptions and induced scintillation, the degradation of enemy spacecraft with such techniques would be effectively indistinguishable from natural environment effects. The investigation and optimization of HF acceleration mechanisms for both friendly and hostile purposes is an important area for future research efforts.

Artificial Weather

While most weather-modification efforts rely on the existence of certain preexisting conditions, it may be possible to produce some weather effects artificially, regardless of preexisting conditions. For instance, virtual weather could be created by influencing the weather information received by an end user. Their perception of parameter values or images from global or local meteorological information systems would differ from reality. This difference in perception would lead the end user to make degraded operational decisions.

Nanotechnology also offers possibilities for creating simulated weather. A cloud, or several clouds, of microscopic computer particles, all communicating with each other and with a larger control system could provide tremendous capability. Interconnected, atmospherically buoyant, and having navigation capability in three dimensions, such clouds could be designed to have a wide-range of properties. They might exclusively block optical sensors or could adjust to become impermeable to other surveillance methods. They could also provide an atmospheric electrical potential difference, which otherwise might not exist, to achieve precisely aimed and timed lightning strikes. Even if power levels achieved were insufficient to be an effective strike weapon, the potential for psychological operations in many situations could be fantastic.

One major advantage of using simulated weather to achieve a desired effect is that unlike other approaches, it makes what are otherwise the results of deliberate actions appear to be the consequences of natural weather phenomena. In addition, it is potentially relatively inexpensive to do. According to J. Storrs Hall, a scientist at Rutgers University conducting research on nanotechnology, production costs of these nanoparticles could be about the same price per pound as potatoes.³⁴ This of course discounts research and development costs, which will be primarily borne by the private sector and be considered a sunk cost by 2025 and probably earlier.

Concept of Operations Summary

Weather affects everything we do, and weather-modification can enhance our ability to dominate the aerospace environment. It gives the commander tools to shape the battlespace. It gives the logistician tools to optimize the process. It gives the warriors in the cockpit an operating environment literally crafted to their needs. Some of the potential capabilities a weather-modification system could provide to a war-fighting CINC are summarized in table 1, of the executive summary).

Notes

¹ A pilot program known as Project Popeye conducted in 1966 attempted to extend the monsoon season in order to increase the amount of mud on the Ho Chi Minh trail thereby reducing enemy movements. A silver iodide nuclei agent was dispersed from WC-130, F4 and A-1E aircraft into the clouds over portions of the trail winding from North Vietnam through Laos and Cambodia into South Vietnam. Positive results during this initial program led to continued operations from 1967 to 1972. While the effects of this program remain disputed, some scientists believe it resulted in a significant reduction in the enemy's ability to bring supplies into South Vietnam along the trail. E. M. Frisby, "Weather-modification in Southeast Asia, 1966–1972," *The Journal of Weather-modification* 14, no. 1 (April 1982): 1–3.

² William M. Gray et al., "Weather-modification by Carbon Dust Absorption of Solar Energy," *Journal of Applied Meteorology* 15 (April 1976): 355.

³ Ibid.

⁴ Ibid.

⁵ Ibid., 367.

⁶ AWS PLAN 813 Appendix I Annex Alfa (Scott AFB, Ill.: Air Weather Service/(MAC) 14 January 1972), 11. Hereafter cited as Annex Alfa.

⁷ Capt Frank G. Coons, "Warm Fog Dispersion—A Different Story," *Aerospace Safety* 25, no. 10 (October 1969): 16.

⁸ Annex Alfa, 14.

⁹ Warren C. Kocmond, "Dissipation of Natural Fog in the Atmosphere," *Progress of NASA Research on Warm Fog Properties and Modification Concepts*, NASA SP-212 (Washington, D.C.: Scientific and Technical Information Division of the Office of Technology Utilization of the National Aeronautics and Space Administration, 1969), 74.

¹⁰ James E. Jiusto, "Some Principles of Fog Modification with Hygroscopic Nuclei," *Progress of NASA Research on Warm Fog Properties and Modification Concepts*, NASA SP-212 (Washington, D.C.: Scientific and Technical Information Division of the Office of Technology Utilization of the National Aeronautics and Space Administration, 1969), 37.

¹¹ Maj Roy Dwyer, *Category III or Fog Dispersal*, M-U 35582-7 D993a c.1 (Maxwell AFB, Ala.: Air University Press, May 1972), 51.

¹² James McLare, *Pulp & Paper* 68, no. 8 (August 1994): 79.

¹³ Milton M. Klein, *A Feasibility Study of the Use of Radiant Energy for Fog Dispersal*, Abstract (Hanscom AFB, Mass.: Air Force Material Command, October 1978).

¹⁴ Edward M. Tomlinson, Kenneth C. Young, and Duane D. Smith, *Laser Technology Applications for Dissipation of Warm Fog at Airfields*, PL-TR-92-2087 (Hanscom AFB, Mass.: Air Force Material Command, 1992).

¹⁵ J. Storrs Hall, "Overview of Nanotechnology," adapted from papers by Ralph C. Merkle and K. Eric Drexler, Internet address: <http://nanotech.rutgers.edu/nanotech/intro.html>, Rutgers University, November 1995.

¹⁶ Robert A. Sutherland, "Results of Man-Made Fog Experiment," *Proceedings of the 1991 Battlefield Atmospheric Conference* (Fort Bliss, Tex.: Hinman Hall, 3–6 December 1991).

¹⁷ Christopher Centner et al., "Environmental Warfare: Implications for Policymakers and War Planners" (Maxwell AFB, Ala.: Air Command and Staff College, May 1995), 39.

¹⁸ Louis J. Battan, *Harvesting the Clouds* (Garden City, N.Y.: Doubleday & Co., 1960), 120.

¹⁹ Facts on File 55, no. 2866 (2 November 95).

²⁰ Gene S. Stuart, "Whirlwinds and Thunderbolts," *Nature on the Rampage* (Washington, D.C.: National Geographic Society, 1986), 130.

²¹ *Ibid.*, 140.

²² Heinz W. Kasemir, "Lightning Suppression by Chaff Seeding and Triggered Lightning," in Wilmot N. Hess, ed., *Weather and Climate Modification* (New York: John Wiley & Sons, 1974), 623–628.

²³ SPACECAST 2020, *Space Weather Support for Communications*, white paper G, (Maxwell AFB, Ala.: Air War College/2020, 1994).

²⁴ Gen Charles Horner, "Space Seen as Challenge, Military's Final Frontier," *Defense Issues*, (Prepared Statement to the Senate Armed Services Committee), 22 April 1993, 7.

²⁵ Lewis M. Duncan and Robert L. Showen, "Review of Soviet Ionospheric Modification Research," in *Ionospheric Modification and Its Potential to Enhance or Degrade the Performance of Military Systems*, (AGARD Conference Proceedings 485, October, 1990), 2-1.

²⁶ *Ibid.*

²⁷ Peter M. Banks, "Overview of Ionospheric Modification from Space Platforms," in *Ionospheric Modification and Its Potential to Enhance or Degrade the Performance of Military Systems* (AGARD Conference Proceedings 485, October 1990) 19-1.

²⁸ Capt Mike Johnson, *Upper Atmospheric Research and Modification—Former Soviet Union (U)*, DST-18205-475-92 (Foreign Aerospace Science and Technology Center, AF Intelligence Command, 24 September 1992), 3. (Secret) Information extracted is unclassified.

²⁹ Capt Edward E. Hume, Jr., *Atmospheric and Space Environmental Research Programs in Brazil (U)* (Foreign Aerospace Science and Technology Center, AF Intelligence Command, March 1993), 12. (Secret) Information extracted is unclassified.

³⁰ Paul A. Kossey et al. “Artificial Ionospheric Mirrors (AIM),” in *Ionospheric Modification and Its Potential to Enhance or Degrade the Performance of Military Systems* (AGARD Conference Proceedings 485, October 1990), 17A-1.

³¹ *Ibid.*, 17A-7.

³² *Ibid.*, 17A-10.

³³ B. N. Maehlum and J. Troim, “Vehicle Charging in Low Density Plasmas,” in *Ionospheric Modification and Its Potential to Enhance or Degrade the Performance of Military Systems* (AGARD Conference Proceedings 485, October 1990), 24-1.

³⁴ Hall.

Chapter 5

Investigation Recommendations

How Do We Get There From Here?

To fully appreciate the development of the specific operational capabilities weather-modification could deliver to the war fighter, we must examine and understand their relationship to associated core competencies and the development of their requisite technologies. Figure 5-1 combines the specific operational capabilities of Table 1 into six core capabilities and depicts their relative importance over time. For example, fog and cloud modification are currently important and will remain so for some time to come to conceal our assets from surveillance or improve landing visibility at airfields. However, as surveillance assets become less optically dependent and aircraft achieve a truly global all-weather landing capability, fog and cloud modification applications become less important.

In contrast, artificial weather technologies do not currently exist. But as they are developed, the importance of their potential applications rises rapidly. For example, the anticipated proliferation of surveillance technologies in the future will make the ability to deny surveillance increasingly valuable. In such an environment, clouds made of smart particles such as described in chapter 4 could provide a premium capability.

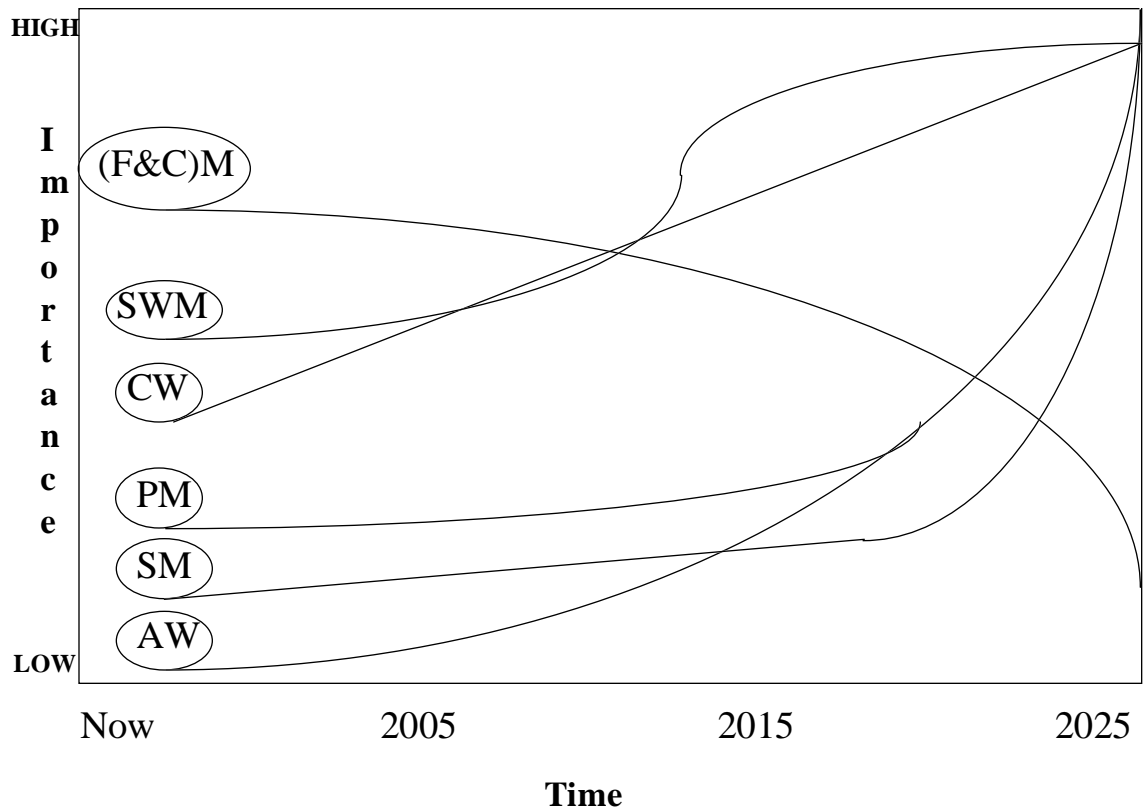

Legend			
PM	Precipitation Modification	(F&C)M	Fog and Cloud Modification
SM	Storm Modification	CW	Counter Weather
SWM	Space Weather-modification	AW	Artificial Weather

Figure 5-1. A Core Competency Road Map to Weather Modification in 2025.

Even today’s most technologically advanced militaries would usually prefer to fight in clear weather and blue skies. But as war-fighting technologies proliferate, the side with the technological advantage will prefer to fight in weather that gives them an edge. The US Army has already alluded to this approach in their concept of “owning the weather.”¹ Accordingly, storm modification will become more valuable over time. The importance of precipitation modification is also likely to increase as usable water sources become more scarce in volatile parts of the world.

As more countries pursue, develop, and exploit increasing types and degrees of weather-modification technologies, we must be able to detect their efforts and counter their activities when necessary. As depicted, the technologies and capabilities associated with such a counter weather role will become increasingly important.

The importance of space weather-modification will grow with time. Its rise will be more rapid at first as the technologies it can best support or negate proliferate at their fastest rates. Later, as those technologies mature or become obsolete, the importance of space weather-modification will continue to rise but not as rapidly.

To achieve the core capabilities depicted in figure 5-1, the necessary technologies and systems might be developed according to the process depicted in figure 5-2. This figure illustrates the systems development timing and sequence necessary to realize a weather-modification capability for the battlespace by 2025. The horizontal axis represents time. The vertical axis indicates the degree to which a given technology will be applied toward weather-modification. As the primary users, the military will be the main developer for the technologies designated with an asterisk. The civil sector will be the main source for the remaining technologies.

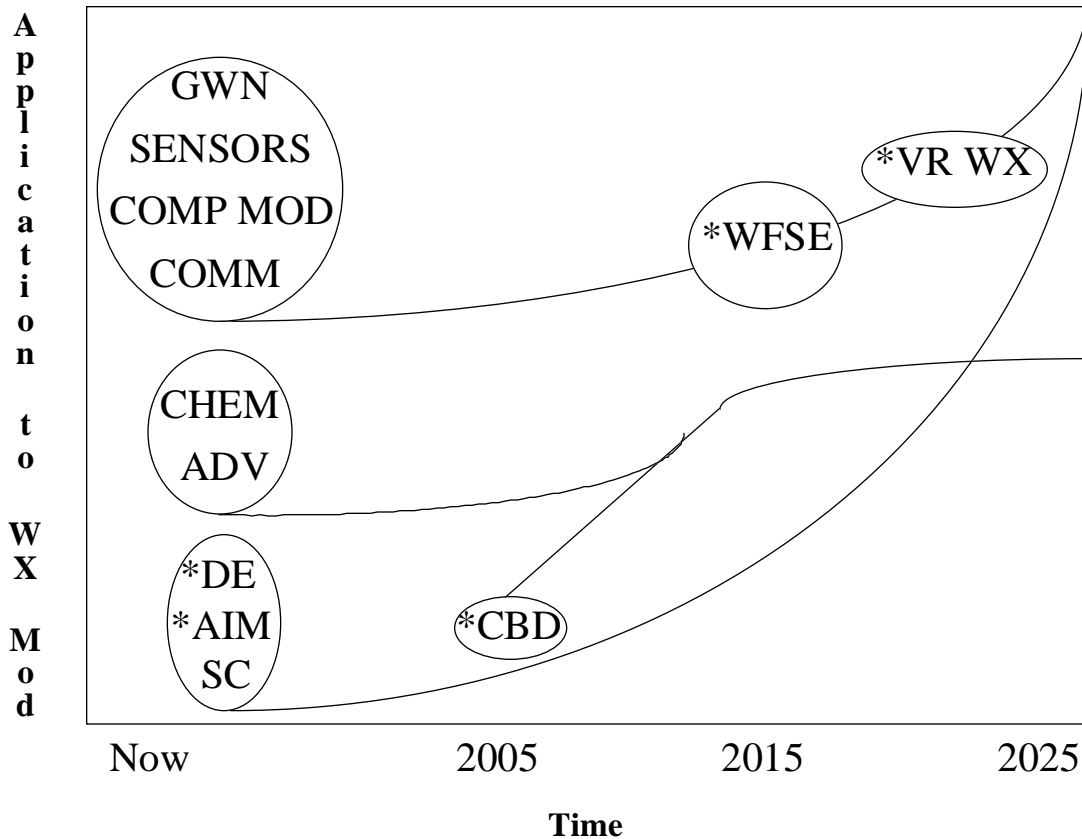

Legend

ADV	Aerospace Delivery Vehicles	DE	Directed Energy
AIM	Artificial Ionospheric Mirrors	GWN	Global Weather Network
CHEM	Chemicals	SC	Smart Clouds (nanotechnology)
CBD	Carbon Black Dust	SENSORS	Sensors
COMM	Communications	VR WX	Virtual Weather
COMP MOD	Computer Modeling	WFSE	Weather Force Support Element

* Technologies to be developed by DOD

Figure 5-2. A Systems Development Road Map to Weather Modification in 2025.

Conclusions

The world's finite resources and continued needs will drive the desire to protect people and property and more efficiently use our crop lands, forests, and range lands. The ability to modify the weather may be desirable both for economic and defense reasons. The global weather system has been described as a series of spheres or bubbles. Pushing down on one causes another to pop up.² We need to know when another power "pushes" on a sphere in their region, and how that will affect either our own territory or areas of economic and political interest to the US.

Efforts are already under way to create more comprehensive weather models primarily to improve forecasts, but researchers are also trying to influence the results of these models by adding small amounts of energy at just the right time and space. These programs are extremely limited at the moment and are not yet validated, but there is great potential to improve them in the next 30 years.³

The lessons of history indicate a real weather-modification capability will eventually exist despite the risk. The drive exists. People have always wanted to control the weather and their desire will compel them to collectively and continuously pursue their goal. The motivation exists. The potential benefits and power are extremely lucrative and alluring for those who have the resources to develop it. This combination of drive, motivation, and resources will eventually produce the technology. History also teaches that we cannot afford to be without a weather-modification capability once the technology is developed and used by others. Even if we have no intention of using it, others will. To call upon the atomic weapon analogy again, we need to be able to deter or counter their capability with our own. Therefore, the weather and intelligence communities must keep abreast of the actions of others.

As the preceding chapters have shown, weather-modification is a force multiplier with tremendous power that could be exploited across the full spectrum of war-fighting environments. From enhancing friendly operations or disrupting those of the enemy via small-scale tailoring of natural weather patterns to complete dominance of global communications and counter-space control, weather-modification offers the war fighter a wide-range of possible options to defeat or coerce an adversary. But, while offensive weather-modification efforts would certainly be undertaken by US forces with great caution and trepidation, it is clear that we cannot afford to allow an adversary to obtain an exclusive weather-modification capability.

Notes

¹ Mary Ann Seagraves and Richard Szymer, "Weather a Force Multiplier," *Military Review*, November/December 1995, 69.

² Daniel S. Halacy, *The Weather Changers* (New York: Harper & Row, 1968), 202.

³ William Brown, "Mathematicians Learn How to Tame Chaos," *New Scientist*, 30 May 1992, 16.

Appendix A

Why Is the Ionosphere Important?

The ionosphere is the part of the earth's atmosphere beginning at an altitude of about 30 miles and extending outward 1,200 miles or more. This region consists of layers of free electrically charged particles that transmit, refract, and reflect radio waves, allowing those waves to be transmitted great distances around the earth. The interaction of the ionosphere on impinging electromagnetic radiation depends on the properties of the ionospheric layer, the geometry of transmission, and the frequency of the radiation. For any given signal path through the atmosphere, a range of workable frequency bands exists. This range, between the maximum usable frequency (MUF) and the lowest usable frequency (LUF), is where radio waves are reflected and refracted by the ionosphere much as a partial mirror may reflect or refract visible light.¹ The reflective and refractive properties of the ionosphere provide a means to transmit radio signals beyond direct "line-of-sight" transmission between a transmitter and receiver. Ionospheric reflection and refraction has therefore been used almost exclusively for long-range HF (from 3 to 30 MHz) communications. Radio waves with frequencies ranging from above 30 MHz to 300 GHz are usually used for communications requiring line-of-sight transmissions, such as satellite communications. At these higher frequencies, radio waves propagate through the ionosphere with only a small fraction of the wave scattering back in a pattern analogous to a sky wave. Communicators receive significant benefit from using these frequencies since they provide considerably greater bandwidths and thus have greater data-carrying capacity; they are also less prone to natural interference (noise).

Although the ionosphere acts as a natural "mirror" for HF radio waves, it is in a constant state of flux, and thus, its "mirror property" can be limited at times. Like terrestrial weather, ionospheric properties

change from year to year, from day to day, and even from hour to hour. This ionospheric variability, called space weather, can cause unreliability in ground- and space-based communications that depend on ionospheric reflection or transmission. Space weather variability affects how the ionosphere attenuates, absorbs, reflects, refracts, and changes the propagation, phase, and amplitude characteristics of radio waves. These weather dependent changes may arise from certain space weather conditions such as: (1) variability of solar radiation entering the upper atmosphere; (2) the solar plasma entering the earth's magnetic field; (3) the gravitational atmospheric tides produced by the sun and moon; and (4) the vertical swelling of the atmosphere due to daytime heating of the sun.² Space weather is also significantly affected by solar flare activity, the tilt of the earth's geomagnetic field, and abrupt ionospheric changes resulting from events such as geomagnetic storms.

In summary, the ionosphere's inherent reflectivity is a natural gift that humans have used to create long-range communications connecting distant points on the globe. However, natural variability in the ionosphere reduces the reliability of our communication systems that depend on ionospheric reflection and refraction (primarily HF). For the most part, higher frequency communications such as UHF, SHF, and EHF bands are transmitted through the ionosphere without distortion. However, these bands are also subject to degradation caused by ionospheric scintillation, a phenomenon induced by abrupt variations in electron density along the signal path, resulting in signal fade caused by rapid signal path variations and defocusing of the signal's amplitude and/or phase.

Understanding and predicting ionospheric variability and its influence on the transmission and reflection of electromagnetic radiation has been a much studied field of scientific inquiry. Improving our ability to observe, model, and forecast space weather will substantially improve our communication systems, both ground and space-based. Considerable work is being conducted, both within the DOD and the commercial sector, on improving observation, modeling, and forecasting of space weather. While considerable technical challenges remain, we assume for the purposes of this study that dramatic improvements will occur in these areas over the next several decades.

¹ AU-18, *Space Handbook, An Analyst's Guide Vol. II.* (Maxwell AFB, Ala.: Air University Press, December 1993), 196.

² Thomas F. Tascione, *Introduction to the Space Environment* (Colorado Springs: USAF Academy Department of Physics, 1984), 175.

Appendix B

Research to Better Understand and Predict Ionospheric Effects

According to a SPACECAST 2020 study titled, “Space Weather Support for Communications,” the major factors limiting our ability to observe and accurately forecast space weather are (1) current ionospheric sensing capability; (2) density and frequency of ionospheric observations; (3) sophistication and accuracy of ionospheric models; and (4) current scientific understanding of the physics of ionosphere-thermosphere-magnetosphere coupling mechanisms.¹ The report recommends that improvements be realized in our ability to measure the ionosphere vertically and spatially; to this end an architecture for ionospheric mapping was proposed. Such a system would consist of ionospheric sounders and other sensing devices installed on DoD and commercial satellite constellations (taking advantage in particular of the proposed IRIDIUM system and replenishment of the GPS) and an expanded ground-based network of ionospheric vertical sounders in the US and other nations. Understanding and predicting ionospheric scintillation would also require launching of an equatorial remote sensing satellite in addition to the currently planned or deployed DOD and commercial constellations.

The payoff of such a system is an improvement in ionospheric forecasting accuracy from the current range of 40-60 percent to an anticipated 80-100 percent accuracy. Daily worldwide ionospheric mapping would provide the data required to accurately forecast diurnal, worldwide terrestrial propagation characteristics of electromagnetic energy from 3-300 MHz. This improved forecasting would assist satellite operators and users, resulting in enhanced operational efficiency of space systems. It would also provide an order of magnitude improvement in locating the sources of tactical radio communications, allowing for location and tracking of enemy and friendly platforms.² Improved capability to forecast ionospheric

scintillation would provide a means to improve communications reliability by the use of alternate ray paths or relay to undisturbed regions. It would also enable operational users to ascertain whether outages were due to naturally occurring ionospheric variability as opposed to enemy action or hardware problems.

These advances in ionospheric observation, modeling, and prediction would enhance the reliability and robustness of our military communications network. In addition to their significant benefits for our existing communications network, such advances are also requisite to further exploitation of the ionosphere via active modification.

Notes

¹ SPACECAST 2020, *Space Weather Support for Communications*, white paper G, (Maxwell AFB, Ala.: Air War College/2020, 1994).

² Referenced in *ibid.*

Appendix C

Acronyms and Definitions

AOC	air operations center
AOR	area of responsibility
ATO	air tasking order
EHF	extra high frequency
GWN	global weather network
HF	high frequency
IR	infrared
LF	low frequency
LUF	lowest usable frequency
Mesoscale	less than 200 km ²
Microscale	immediate local area
MUF	maximum usable frequency
MW	microwave
OTH	over-the-horizon
PGM	precision-guided munitions
RF	radio frequency
SAR	synthetic aperture radar
SARSAT	search and rescue satellite-aided tracking
SHF	super high frequency
SPOT	satellite positioning and tracking
UAV	uninhabited aerospace vehicle
UV	ultraviolet
VHF	very high frequency
WFS	weather force specialist
WFSE	weather force support element
WX	weather

Bibliography

- Appleman, Herbert S. *An Introduction to Weather-modification*. Scott AFB, Ill.: Air Weather Service (MAC), September 1969.
- AU-18, *Space Handbook, An Analyst's Guide Vol. II*. Maxwell AFB, Ala.: Air University Press, December 1993.
- AWS PLAN 813, Appendix I, Annex Alfa. Scott AFB, Ill.: Air Weather Service (MAC), 14 January 1972.
- Banks, Peter M. "Overview of Ionospheric Modification from Space Platforms." In *Ionospheric Modification and Its Potential to Enhance or Degrade the Performance of Military Systems*, AGARD Conference Proceedings 485, October 1990.
- Batton, Louis J. *Harvesting the Clouds*. Garden City, N.Y.: Doubleday & Co., 1969.
- Brown, William. "Mathematicians Learn How to Tame Chaos." *New Scientist*, 30 May 1992.
- Byers, Horace R. "History of Weather-modification." In Wilmot N. Hess, ed., *Weather and Climate Modification*. New York: John Wiley & Sons, 1974.
- Centner, Christopher, et al., "Environmental Warfare: Implications for Policymakers and War Planners." Maxwell AFB, Ala.: Air Command and Staff College, May 1995.
- Coons, Capt Frank G. "Warm Fog Dispersal—A Different Story." *Aerospace Safety* 25, no. 10 (October 1969).
- CJCSI 3810.01, Meteorological and Oceanographic Operations, 10 January 1995.
- Dawson, George. "An Introduction to Atmospheric Energy." In Wilmot N. Hess, ed., *Weather and Climate Modification*. New York: John Wiley & Sons, 1974.
- Duncan, Lewis M., and Robert L. Showen "Review of Soviet Ionospheric Modification Research." In *Ionospheric Modification and Its Potential to Enhance or Degrade the Performance of Military Systems* AGARD Conference Proceedings 485, October 1990.
- Dwyer, Maj Roy. *Category III or Fog Dispersal*, M-U 35582-7 D993a. Maxwell AFB, Ala.: Air University Press, May 1972.
- Eisenhower, Dwight E. "Crusade in Europe" quoted in John F. Fuller, ed., *Thor's Legions*. Boston: American Meteorology Society, 1990.
- Facts on File 55, No. 2866 (2 November 1995).
- Frisby, E. M. "Weather-modification in Southeast Asia, 1966–1972." *The Journal Of Weather-modification* 14, no. 1 (April 1982).
- Frisby, E. M. "Weather-modification in Southeast Asia, 1966-1972." *Journal of Applied Meteorology* 15 (April 1976).
- Gray, William M., et al. "Weather-modification by Carbon Dust Absorption of Solar Energy." *Journal of Applied Meteorology* 15, (April 1976).
- Halacy, Daniel S. *The Weather Changers*. New York: Harper & Row, 1968.

- Hall, J. Storrs. "Overview of Nanotechnology" Adapted from papers by Ralph C. Merkle and K. Eric Drexler. Internet address: <http://nanotech.rutgers.edu/nanotech/-intro.html> (Rutgers University, November 1995).
- Horner, Gen Charles. "Space Seen as Challenge, Military's Final Frontier" (Prepared Statement to the Senate Armed Services Committee) *Defense Issues*, 22 April 1993.
- Hume, Capt Edward E., Jr. Atmospheric and Space Environmental Research Programs in Brazil (U), March 1993. Foreign Aerospace Science and Technology Center, AF Intelligence Command, 24 September 1992. (Secret) Information extracted is unclassified.
- James, G. E. "Chaos Theory: The Essentials for Military Applications" *ACSC Theater Air Campaign Studies Coursebook*, AY96, Vol. 8. Maxwell AFB, Ala.: Air University Press, 1995.
- Jiusto, James E. "Some Principles of Fog Modification with Hygroscopic Nuclei" *Progress of NASA Research on Warm Fog Properties and Modification Concepts*, NASA SP-212. Washington, D.C.: Scientific and Technical Information Division of the Office of Technology Utilization of the National Aeronautics and Space Administration, 1969.
- Johnson, Capt Mike. *Upper Atmospheric Research and Modification—Former Soviet Union* (U) supporting document DST-18205-475-92, Foreign Aerospace Science and Technology Center, AF Intelligence Command, 24 September 1992. (Secret) Information extracted is unclassified.
- Kasemir, Heinz W. "Lightning Suppression by Chaff Seeding and Triggered Lightning." In Wilmot N. Hess, ed., *Weather and Climate Modification*. New York: John Wiley & Sons, 1974.
- Keaney, Thomas A., and Eliot A. Cohen, *Gulf War Air Power Survey Summary Report*. Washington D.C.: GPO, 1993.
- Klein, Milton M. *A Feasibility Study of the Use of Radiant Energy for Fog Dispersal* Abstract. Hanscom AFB, Mass.: Air Force Material Command, October 1978.
- Kocmond, Warren C. "Dissipation of Natural Fog in the Atmosphere," *Progress of NASA Research on Warm Fog Properties and Modification Concepts*, NASA SP-212. Washington, D.C.: Scientific and Technical Information Division of the Office of Technology Utilization of the National Aeronautics and Space Administration, 1969.
- Kossey, Paul A., et al. "Artificial Ionospheric Mirrors (AIM) A. Concept and Issues," In *Ionospheric Modification and its Potential to Enhance or Degrade the Performance of Military Systems*, AGARD Conference Proceedings 485, October 1990.
- Maehlum, B. N., and J. Troim, "Vehicle Charging in Low Density Plasmas" In *Ionospheric Modification and Its Potential to Enhance or Degrade the Performance of Military Systems* AGARD Conference Proceedings 485, October 1990.
- McLare, James. *Pulp & Paper* 68, no. 8, August 1994.
- Meyer, William B. "The Life and Times of US Weather: What Can We Do About It?" *American Heritage* 37, no. 4 (June/July 1986).
- Petersen, Rear Adm Sigmund. "NOAA Moves Toward The 21st Century." *The Military Engineer* 20, no. 571 (June-July 1995).
- Riley, Lt Col Gerald F. Staff Weather Officer to CENTCOM OIC of CENTAF Weather Support Force and Commander of 3d Weather Squadron. In "Desert Shield/Desert Storm Interview Series," interviewed by Dr William E. Narwyn, AWS Historian, 29 May 1991.
- Seagraves, Mary Ann, and Richard Szymer "Weather a Force Multiplier." *Military Review*, November/December 1995.
- SPACECAST 2020. *Space Weather Support for Communications* White paper G. Maxwell AFB, Ala.: Air War College/2020, 1994.

- Stuart, Gene S. "Whirlwinds and Thunderbolts," In *Nature on the Rampage*. Washington D.C.: National Geographic Society, 1986.
- Sullivan, Gen Gordon R. "Moving into the 21st Century: America's Army and Modernization" *Military Review*. July 1993. Quoted in Mary Ann Seagraves and Richard Szymer "Weather a Force Multiplier" *Military Review*, November/December 1995.
- Sutherland, Robert A. "Results of Man-Made Fog Experiment," In *Proceedings of the 1991 Battlefield Atmospheric Conference*. Fort Bliss, Tex.: Hinman Hall, 3-6 December 1991.
- Tascione, Thomas F. *Introduction to the Space Environment*. Colorado Springs: USAF Academy Department of Physics, 1984. Tomlinson, Edward M., Kenneth C. Young, and Duane D. Smith *Laser Technology Applications for Dissipation of Warm Fog at Airfields*, PL-TR-92-2087. Hanscom AFB, Mass.: Air Force Materiel Command, 1992.
- USAF Scientific Advisory Board. *New World Vistas: Air and Space Power for the 21st Century*, Summary Volume. Washington, D.C.: USAF Scientific Advisory Board, 15 December 1995.
- US Department of State. *The Department of State Bulletin* 76, no. 1981 (13 June 1977).

Planetary Defense: Catastrophic Health Insurance for Planet Earth



A Research Paper
Presented To

Air Force *2025*

by

COL (Sel) John M. Urias (USA)
Ms. Iole M. DeAngelis
Maj Donald A. Ahern
Maj Jack S. Caszatt
Maj George W. Fenimore III
Mr. Michael J. Wadzinski

October 1996

Disclaimer

2025 is a study designed to comply with a directive from the chief of staff of the Air Force to examine the concepts, capabilities, and technologies the United States will require to remain the dominant air and space force in the future. Presented on 17 June 1996, this report was produced in the Department of Defense school environment of academic freedom and in the interest of advancing concepts related to national defense. The views expressed in this report are those of the authors and do not reflect the official policy or position of the United States Air Force, Department of Defense, or the United States government.

This report contains fictional representations of future situations/scenarios. Any similarities to real people or events, other than those specifically cited, are unintentional and are for purposes of illustration only. It should be duly noted that at this time Planetary Defense is not an assigned or approved mission for the United States Department of Defense or the United States Air Force.

This publication has been reviewed by security and policy review authorities, is unclassified, and is cleared for public release.

Contents

<i>Chapter</i>	<i>Page</i>
Disclaimer	ii
Illustrations.....	v
Tables.....	vi
Preface.....	vii
Executive Summary	ix
1 Introduction	1
The Threat.....	2
Vulnerability	4
2 Social, Economic, and Political Implications	6
Social Implications	6
Economic Implications	9
Cost.....	10
Investment	10
Political Implications.....	13
Legal Aspects of Planetary Defense.....	14
European Perspective On Planetary Defense	15
Planetary Defense as a European Space Policy Priority	18
Alternate Futures and Political Outlook For Planetary Defense.....	18
3 Planetary Defense System	24
Mission and Required Capability	24
Required Capability.....	24
Detection Subsystems	26
Current Detection Programs	27
Detection, Tracking, and Homing.....	29
Detection Concepts for 2025.....	31
Command, Control, Communications, and Computers, and Intelligence Subsystems.....	34
Unilateral US Command Elements	34
International Command Elements.....	35
Command Responsibilities—US Unilateral Action	35
C ⁴ I for Detection Subsystems	36
C ⁴ I for Mitigation Subsystems.....	36
Research and Development.....	36
Exploration	36
Exploitation.....	37
Command Relationships/Connectivity	37
Communications.....	37
Computers.....	39

<i>Chapter</i>	<i>Page</i>
Intelligence.....	40
C ⁴ I Summary	41
Mitigation Subsystems	41
Concept of Operations—A Three-Tier System.....	54
4 Dual-Use Benefits.....	59
5 Recommendations	61
Benefits.....	61
Issues	61
Investigative Recommendations.....	62
Bibliography.....	65

Illustrations

<i>Figure</i>	<i>Page</i>
1-1. Asteroid Size/Impact vs. Frequency	3
3-1. Current ECO Search and Detection Network.....	28
3-2. Sky Eyes--Deep Space Sentry System CONCEPT	32
3-3. Proposed Unilateral US Command Structure	34
3-4. Potential Mitigation Subsystems	42
3-5. New Potential Mitigation Subsystems	43
3-6. Capability of Kinetic Energy Deflectors.....	48
3-7. Capability of Mass Drivers	50
3-8. Capability of Solar Sails	51
3-9. Asteroid deflection capabilities of solar collectors vs nuclear weapons	52
3-10. Proposed Three-Tier PDS	55
3-11. Proposed three-tier planetary defense system research, development, and deployment timelines	56

Tables

<i>Table</i>	<i>Page</i>
1 Injuries And Deaths Caused by ECO Impacts.....	7
2 Economic Analysis of 2-km dia. M-Class Metal Rich Asteroid.....	13
3 ECO Scenarios	25
4 Detection Technologies	33
5 C ⁴ I Subsystem Characteristics	41
6 ECO Mitigation Systems.....	43
7 Nuclear Charges Required for Various Asteroid Employment Scenarios.....	46
8 Yield Versus Mass for Nuclear Explosive Devices	46
9 Three-Tier PDS	55

Preface

When we learned that our team had been assigned the topic of “Planetary Defense,” we admittedly did what most people do when they first consider the subject: we laughed. This phenomenon is commonly referred to as the giggle factor, and we have seen it many times during the ensuing months of our research and briefings. However, once we immersed ourselves in the data and began to work directly with several of the growing number of astronomers and scientists actively working this problem, our laughs were quickly replaced with concern. Our concern was based not only on the prospects of the earth being confronted with the crisis of an impending impact of a large asteroid or comet but the fact that such impacts occur far more frequently than most people realize, and that the global community, although becoming increasingly serious about this threat, currently lacks the capability to adequately detect or mitigate these extraterrestrial objects. More importantly, however, is the fact that the impact of a relatively small asteroid would, in all likelihood, cause catastrophic damage and loss of life—even the possible extinction of the human race! Once we understood the magnitude and seriousness of the planetary defense problem, our initial laughs were quickly replaced with many hours of research and brainstorming as we pondered the issue of developing and deploying a planetary defense system, a goal that has become our personal crusade.

In accomplishing this team project, we received invaluable help from several people which was critical to the success of our study. We thank our faculty advisors, Col Vic Budura of the United States Air Force Air War College and Maj Doug Johnston of the United States Air Force Air Command and Staff College, for their insight and support throughout the project. We also thank Mike McKim of the Air War College for his dedicated assistance in our research efforts. Additionally, we wish to thank Col Mike Kozak, Lt Col Larry Boyer, Capt John Vice, and SSgt Brian Sommers of the **2025** Support Office for their dedication and responsiveness to our many administrative requirements. We also thank our foreign teammate, Ms Iole De Angelis of the International Space University, for her tireless energy and valuable European perspective, especially regarding the treaty implications of deploying a planetary defense system. From a technical

perspective, we thank Drs Tom Gehrels and Jim Scotti of the Lunar and Planetary Laboratory, University of Arizona, and Ms Shirley Petty and John Plencner of the Lawrence Livermore National Laboratory for their willingness to share results of their recent research and workshops with us as well as to serve as sounding boards for our ideas. Finally, we extend a special thanks to our families for their understanding and patience during our many hours away from home. We could not have succeeded without them.

COL (Sel) John M. Urias (USA)
Maj Donald A. Ahern
Maj Jack S. Caszatt
Maj George W. Fenimore III
Mr Michael J. Wadzinski

Executive Summary

Concern exists among an increasing number of scientists throughout the world regarding the possibility of a catastrophic event caused by an impact of a large earth-crossing object (ECO) on the Earth-Moon System (EMS), be it an asteroid or comet. Such events, although rare for large objects (greater than 1 kilometer diameter), are not unprecedented. Indeed, the great upheaval and resulting ice age that marked the extinction of the dinosaurs is thought to have been caused by the impact of a 10 km diameter asteroid. In 1908 a stony asteroid of approximately 50 meters diameter exploded in the air above the Tunguska River in Siberia, producing an equivalent yield of 15-30 megatons of TNT, and leveling over 2,000 square miles of dense forest. Such an event is thought to occur approximately every century. It is only a matter of time before the world finds itself in a crisis situation—a crisis involving the detection of a large ECO, leaving little time to react and resulting in global panic, chaos, and possible catastrophe.

Collectively as a global community, no current viable capability exists to defend the EMS against a large ECO, leaving its inhabitants vulnerable to possible death and destruction of untold proportion and even possible extinction of the human race. In this regard, a planetary defense system (PDS) capability should be resourced, developed, and deployed. At this time Planetary Defense is not an assigned or approved mission of the Department of Defense or the Air Force. Such a system would consist of a detection subsystem, command, control, communications, computer, and intelligence (C⁴I) subsystem and a mitigation subsystem. There are many potential variations of these subsystems which, with advances in novel technologies, will be available by 2025 to develop a credible PDS. We propose a three-tier system developed sequentially in time and space. Such a system would serve not only as a means to preserve life on earth, but also help to unite the global community in a common effort that would promote peaceful cooperation and economic prosperity as related spin-offs and dual uses of novel technologies evolve.

Chapter 1

Introduction

If some day in the future we discover well in advance that an asteroid that is big enough to cause a mass extinction is going to hit the Earth, and then we alter the course of that asteroid so that it does not hit us, it will be one of the most important accomplishments in all of human history.

—Sen George E. Brown, Jr.

The Earth-Moon System (EMS) and its inhabitants are in danger. It is not the kind of danger that most people are familiar with such as disease, pestilence, or the threat of nuclear war, but one that is rapidly moving to the forefront of scientific research, exploration, and analysis—the very real hazard of a large earth-crossing object (ECO) impacting on the EMS. As the Earth revolves around the Sun, it periodically passes close to orbiting asteroids and comets, producing near-earth-object (NEO) situations. When asteroid or comet orbits intersect the orbit of the earth, they are referred to as ECOs. Clearly, a global effort is needed to deal with this problem and to provide perhaps the only means of preserving the human race from possible extinction.

Building on the 1993 *SPACECAST 2020* Study, this paper describes new research and analysis on the magnitude of the threat and possible mitigation systems.¹ It then proposes a mission statement and outlines the basic capability required in a functional planetary defense system (PDS). This “system of systems” is described in detail, working through the detection, analysis, and mitigation subsystems that comprise the PDS. Included in this development are novel concepts using new technologies and capabilities expected to be available in the years prior to 2025, facilitating a variety of courses of action, and moving the community away from the less-than-desirable nuclear solution. It also provides, an overall concept of operations which

describes how these subsystems work together to provide the needed capability against threat objects from space. A three-tier system is proposed. Several commercial applications and benefits are considered as spin-offs or as dual-use capabilities of the PDS. Finally, specific recommendations are provided which are keyed toward generating increased interest, emphasis, funding, research, development, and deployment of a PDS to deal with this rare but potentially catastrophic problem.

The Threat

The earth lies at the center of a cosmic shooting gallery consisting of asteroids and comets, racing through space at velocities relative to the earth of up to 75 times the speed of sound.² These extraterrestrial objects are material left over from the formation of the solar system; basically, they are material that never coalesced into planets. Asteroids are rocky and metallic objects that orbit the Sun, ranging in diameter from mere pebbles to about 1,000 kilometers. They are generally found in a main orbital belt between Mars and Jupiter. Comets, on the other hand, contain ice, clay, and organic matter and are commonly referred to as “dirty snowballs” because of their opaque appearance. Like asteroids, comets orbit the sun, typically in highly elliptical or even parabolic orbits.

Although ECO impacts involving large asteroids or comets are rare, they do occur. When they do, they have the potential for causing catastrophic destruction and loss of life. It is currently estimated that more than 2,000 ECOs in excess of 0.5 km in diameter do exist. Given the inadequate deep space detection capability, only a small percentage of these objects have been classified. Disturbingly, a sizable number of these potential threat objects are quite large. Ceres, for example, is 974 km in diameter and is currently the largest of the classified asteroids. Approximately 20 other asteroids fall into this mega-threat category. With the natural gravitational perturbations created by the planets, it is inevitable that one or more of these objects will someday impact the EMS.

Geologic history is replete with examples of actual ECO impacts. Indeed, many scientists argue that it was the impact of a huge asteroid, perhaps as large as 10 km in diameter, that created a global dust cloud and ultimately triggered climactic changes that caused the extinction of dinosaurs and up to 75 percent of other species then on earth. This event, called the Cretaceous/Tertiary (K/T) Impact, is believed to have produced

an equivalent yield of 10^8 megatons of TNT.³ Ancient writings and drawings contain numerous accounts of objects falling from the sky, causing death and destruction. A size and impact versus frequency graph is included as figure 1-1.

During the twentieth century, several impacts and near misses have been recorded. In 1908 a stony asteroid of approximately 50 meters in diameter exploded in the air above the Tunguska River in Siberia, producing an equivalent TNT yield of 15-30 megatons (MT) and leveling over 2,000 square miles of dense forest. Needless to say, had the Tunguska event occurred over a populated city, the results would have been catastrophic. In 1937 and again in 1989, large asteroids passed uncomfortably close to the earth. The 1989 asteroid would have unleashed the equivalent of more than 40,000 megaton of TNT had it impacted. More recently, in 1994, astronomers cautiously watched as a small asteroid missed the earth by only 60,000 miles. In 1996 comet Hyakutake passed within 9 million miles of earth (0.1 astronomical units (AU)), the nearest comet approach in six centuries, yet this body was discovered only three months prior to its closest approach to earth.⁴

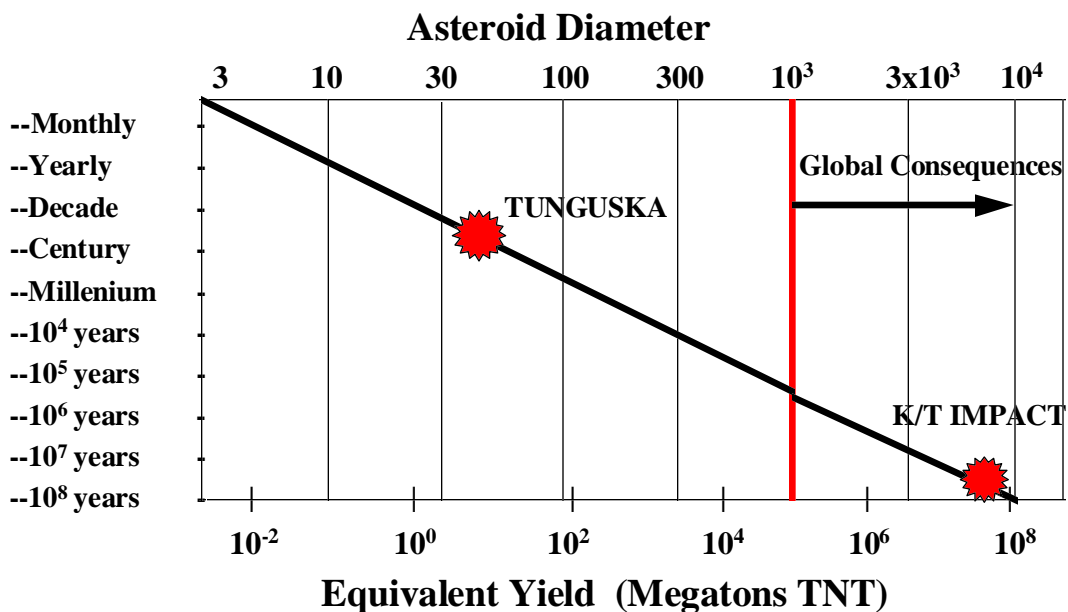

Figure 1-1. Asteroid Size/Impact Versus Frequency

The earth continues to be struck by objects from space at irregular intervals, most of which are small pebble-sized rocks weighing only a few milligrams. Scientists estimate that a large number of meteoroids (asteroids that impact earth) enter the earth's atmosphere daily, amounting to several hundred tons of material

each year.⁵ Based on recent analysis, coupled with the exploration of over 120 impact craters on earth, researchers now believe that collisions involving large objects occur within centuries and millennia versus millions and billions of years, as originally estimated.⁶ Additionally, data now indicates that multiple impacts are more common than previously thought. Although these frequencies of occurrence may seem to be inconsequential, requiring virtually no action or concern, the catastrophic effects associated with only one of these events demand that the global community unite to develop a defensive capability.

Vulnerability

Due to a lack of awareness and emphasis, the world is not socially, economically, or politically prepared to deal with the vulnerability of the EMS-to-ECO impacts and their potential consequences. Further, in terms of existing capabilities, there is currently a lack of adequate means of detection, command, control, communications, computers, and intelligence (C⁴I), and mitigation.

Few people are even aware of an ECO problem, much less the potential consequences associated with its impact on the EMS. However, there are hopeful signs in correcting this deficiency as more frequent Planetary Defense workshops are being conducted with active participation by an increasing number of major countries. Nevertheless, other than a congressional mandate requiring further study of the problem, no further globally sanctioned action has been taken.

In terms of courses of action in the event of a likely impact of an ECO, other than a nuclear option, no defensive capability exists today. However, new technologies may yield safer and more cost-effective solutions by 2025. These authors contend that the stakes are simply too high not to pursue direct and viable solutions to the ECO problem. Indeed, the survival of humanity is at stake.

Notes

¹ Much information was gathered from reports from recent conferences and workshops conducted to increase awareness and incite action in developing a cooperative solution within the global community, including: *The Spaceguard Survey: Report of the NASA International Near-Earth-Object Detection Workshop*, ed. David Morrison, (Pasadena, Calif.: Jet Propulsion Laboratory, 1992); *Proceedings of the Near-Earth-Object Interception Workshop*, eds. G. H. Canavan, J. C. Solem, and J. D. G. Rather (Los

Alamos, N.Mex.: Los Alamos National Laboratory, 1992); *Problems of Earth Protection Against the Impact with Near-Earth-Objects* (Livermore, Calif.: Lawrence Livermore National Laboratory, 1994).

² Peter Tyson, "Comet Busters," *Planetary Defense Workshop: An International Technical Meeting on Active Defense of the Terrestrial Biosphere from Impacts by Large Asteroids and Comets*, (Livermore, Calif.: Lawrence Livermore National Laboratory, 22–26 May 1995).

³ Tom Gehrels, "Collisions with Comets and Asteroids," *Scientific American*, (March 1996), 57.

⁴ "C/1996 B2 (Hyakutake)," n.p.: on-line, Internet, 30 May 1996, available from http://medicine.wustl.edu/%7Ekronkg/1996_B2.html.

⁵ Bob Kobres, "Meteor Defense," *Whole Earth Review* (Fall 1987): 70–73.

⁶ Victor Clube and Bill Napier, *Cosmic Winter* (Basil Blackwell, June 1993), 1–15.

Chapter 2

Social, Economic, and Political Implications

Nearly every century, the earth is impacted by an asteroid large enough to cause tens of thousands of deaths if they were to hit densely populated areas. On millennial time scales, impacts large enough to cause destruction comparable to the greatest known natural disasters may occur.¹

Social Implications

Most of the world's population does not know or care about the prospect of cosmic collisions, although this hazard from space is a subject of deadly concern to humanity. Unfortunately, there are fewer than a dozen people currently searching for ECOs worldwide, fewer people than "it takes to run a single McDonalds."²

Many experts wrongly believe there have been no recorded deaths due to asteroid strikes, acknowledging only that there have been some close calls from small meteorites striking cars and houses.³ However, planetologist John S. Lewis asserts in recent research that meteorites have in fact caused thousands of deaths throughout recorded history. Lewis details 123 cases of deaths, injuries, and property damage caused by ECO impacts reported over approximately a two-hundred-year period alone. Table 1 reflects known cases which caused injury or death.⁴

Table 1

Injuries and Deaths Caused by ECO Impacts

1420 BC	Israel - Fatal meteorite impact.
588 AD	China - 10 deaths; siege towers destroyed.
1321-68	China - People & animals killed; homes ruined.
1369	Ho-t'ao China - Soldier injured; fire.
02/03/1490	Shansi, China - 10,000 deaths.
09/14/1511	Cremona, Italy - Monk, birds, & sheep killed.
1633-64	Milono, Italy - Monk killed.
1639	China - Tens of deaths; 10 homes destroyed.
1647-54	Indian Ocean - 2 sailors killed aboard a ship.
07/24/1790	France - Farmer killed; home destroyed; cattle killed.
01/16/1825	Oriang, India - Man killed; woman injured.
02/27/1827	Mhow, India - Man injured.
12/11/1836	Macao, Brazil - Oxen killed; homes damaged.
07/14/1847	Braunau, Bohemia - Home struck by 371 lb meteorite.
01/23/1870	Nedagolla, India - Man stunned by meteorite.
06/30/1874	Ming Tung li, China - Cottage crushed, child killed.
01/14/1879	Newtown, Indiana, USA - Man killed in bed.
01/31/1879	Dun-Lepoelier, France - Farmer killed by meteorite.
11/19/1881	Grossliebenthal, Russia - Man injured.
03/11/1897	West Virginia, USA - Walls pierced, horse killed, man injured.
09/05/1907	Weng-li, China - Whole family crushed to death.
06/30/1908	Tunguska, Siberia - Fire, 2 people killed. (referenced throughout paper)
04/28/1927	Aba, Japan - Girl injured by meteorite.
12/08/1929	Zvezvan, Yugoslavia - Meteorite hit bridal party, 1 killed.
05/16/1946	Santa Ana, Mexico - Houses destroyed, 28 injured.
11/30/1946	Colford, UK - Telephones knocked out, boy injured.
11/28/1954	Sylacauga, Alabama, USA - 4 kg meteorite struck home, lady injured.
08/14/1992	Mbole, Uganda - 48 stones fell, roofs damaged, boy injured.

More recently, on 8 December 1992, a large asteroid named Toutatis missed earth by only two lunar distances. This was a fortunate day for everyone on earth, because this asteroid was nearly 4 kilometers in diameter.⁵ If Toutatis had impacted earth, the force of the collision would have generated more energy than all the nuclear weapons in existence combined—equal to approximately 9×10^6 megatons of TNT.⁶

Finally, if you were standing on Kosrae Island, off the New Guinea coast on 1 February 1994, you would have witnessed a blast in the sky as bright as the sun. A small meteor traveling at approximately 33,500 miles per hour had entered the earth's atmosphere. Fortunately, the meteor exploded at high altitude, over a sparsely populated region; the blast equaling 11 kilotons (KT) of TNT.⁷

Regardless of the tendency to downplay the ECO threat, the probability of an eventual impact is finite. When it happens, the resulting disaster is expected to be devastatingly catastrophic. Scientists estimate the

impact by an asteroid even as small as 0.5 kilometers could cause climate shifts sufficient to drastically reduce crop yields for one or several years due to atmospheric debris restricting sunlight. Impacts by objects one to two kilometers in size could therefore result in significant loss of life due to mass starvation. Few countries store as much as even one year's supply of food. The death toll from direct impact effects (blast and firestorm, as well as the climatic changes) could reach 25 percent of the world's population.⁸ Although it may be a rare event, occurring only every few hundred thousand years, the average yearly fatalities from such an event could still exceed many natural disasters more common to the global population.

Because the risk is small for such an impact happening in the near future, the nature of the ECO impact hazard is beyond our experience. With the exception of the asteroid strike in Shansi, China, which reportedly killed more than 10,000 people in 1490, ECO impacts killing more than 100 people have not been reported within all of human history.⁹ Natural disasters, including earthquakes, tornadoes, cyclones, tsunamis, volcanic eruptions, firestorms, and floods often kill thousands of people, and occasionally several million. In contrast to more familiar disasters, the postulated asteroid impact would result in massive devastation. For example, had the 1908 Tunguska event happened three hours later, Moscow would have been leveled. In another event occurring approximately 800 years ago on New Zealand's South Island, an ECO exploded in the sky, igniting fires and destroying thousands of acres of forests.¹⁰ If such an event were to occur over an urban area, hundreds of thousands of people could be killed, and damage could be measured in hundreds of billions of dollars.¹¹

A civilization-destroying impact overshadows all other disasters, since billions of people could be killed (as large a percentage loss of life worldwide as that experienced by Europe from the Black Death in the 14th century).¹² As the global population continues to increase, the probability of an ECO impact in a large urban center also increases proportionally.

Work over the last several years by the astronomical community supports that more impacts will inevitably occur in the future. Such impacts could result in widespread devastation or even catastrophic alteration of the global ecosystem.

During the last 15 years, research on ECOs has increased substantially. Fueled by the now widely accepted theory that a large asteroid impact caused the extinction of the dinosaurs, astronomy and geophysics communities have focused more effort on this area. Astronomers, with more capable detection equipment,

have been discovering potentially globally catastrophic 1 km and larger ECOs at an average rate of 25 each year.¹³

The combined results of these efforts help us to realize that there is a potentially devastating but still largely uncharacterized natural threat to earth's inhabitants. A disaster of this magnitude could put enormous pressure on the nations involved, destabilizing their economic and social fabrics. Certainly, such a disaster could affect the entire global community. Historically, governments have crumbled to lesser disasters because of a lack of resources and the inability to meet the needs of their people. Often only the infusion of external assistance has prevented more severe outcomes.

What will happen when a significant portion--such as one-quarter--of the world's population is in need of aid, especially when it is not known how long the effects may last? Thus, the time has come to investigate development of the necessary technologies and strategies for planetary defense. While living in day-to-day fear is not the answer, there is a sizable danger to our planet from an ECO impact. Numerous other species may now be extinct because they could not take preventive steps. We must avoid delusions of invincibility. Humans must acknowledge that, as a species, we may not have existed long enough to consciously experience such a catastrophic event. But we currently have the technological means for detecting and possibly mitigating the ECO threat. We would be remiss if we did not use it.

Economic Implications

The cost for a PDS system could be compared to buying a life insurance policy for the world. Applying our three-tier defensive plan could offer the best answer in convincing the world purseholders to invest in a long-term program. Gregory H. Canavan, senior scientific advisor for defense research at Los Alamos National Laboratory, and Johndale Solem, coordinator for advanced concepts at Los Alamos National Laboratory, suggested a possible graduated funding approach. A few million dollars each year could support necessary observation surveys and theoretical study on mitigation efforts. A few tens of millions each year could support research on interception technologies and procure the dedicated equipment needed to search for large earth-threatening ECOs. And a hundred million dollars could create a spacecraft, such as in the

Clementine I and *II* projects to intercept ECOs for the necessary characterization and composition analyses of ECOs of all sizes.¹⁴

Cost

Millions of dollars each year are spent to warn people of hurricanes, earthquakes and floods.¹⁵ Tens of millions of dollars to warn and mitigate a potential asteroid impact will be minor compared to what the costs will be in response to even a relatively small impact in a populated area. Responding to such an impact will require a concerted effort from many nations and will strain severely strain on the economic resources of the international community.¹⁶

In fact, recognizing the potential seriousness of such events, the Congress in 1990 mandated that the National Aeronautics and Space Administration (NASA) conduct two workshops to study the issue of NEOs. The first of these workshops, the International NEO Detection Workshop or "*Spaceguard Survey*," held in several sessions during 1991, defined a program for detecting kilometer-sized or larger NEOs. The second workshop, the NEO Interception Workshop, held in January 1992, studied issues in intercepting and deflecting or destroying those NEOs determined to be on a collision course. In related action, Congress also funded two asteroid intercept technology missions: *Clementine I* and *Clementine II*. *Clementine I* was launched in 1994 to demonstrate space-based interceptor "Brilliant Pebbles" technology. *Clementine II* is scheduled for launch in 1998. The United Nations has directed national labs, corporations, and universities to accomplish other studies.

Investment

Building a complicated PDS crash program at a cost of billions may not hold the answer. A proposed program of Air Force space surveillance and monitoring as well as such intercept tests as *Clementine II* will be considered.¹⁷

No known ECOs are projected to impact the earth today. However, our inadequate detection capability due to inadequate resourcing and technology limitations place humanity at significant risk. The bottom line is

the finite probability that we eventually will have a significant ECO impact. Indeed, one day it will be exactly equal to one. A modest but prudent program is justified and may buy us all substantial peace of mind.

The *Spaceguard Survey* Workshop's proposed observation network consists of six dedicated astronomical telescopes widely dispersed worldwide with all sites data-linked to a central survey clearinghouse and coordination center. The proposal offers a good start, but the limited rate of detection it can support would mean that the comprehensive census of 1 kilometer and larger ECOs would take 20-25 years. Development and operational costs for this system are estimated at \$50 million (a one-time cost) and \$10-15 million (annually), respectively. It is reasonable to assume these costs will be shared by the minimum of five nations where observatories are located and other where other states are directly involved.¹⁸

Development of this system will benefit from the experience gained by numerous space surveillance missions from man-made Earth-orbiting satellites, which in turn will benefit from technology developed specifically for detection and tracking of asteroids. Once such a system is in full operation and completes the initial catalogue, it may detect most large ECOs years or even decades in advance, which will provide time to prevent a collision. Then, the primary attention of the system may be changed to the hundreds of thousands of smaller near-earth asteroids and comets which also will cause considerable concern, while maintaining a perpetual watch for elusive long-period comets of any threatening size.

However, the system may also alert us to the prospect that our doomsday is closer at hand than we currently realize. Since the 1994 comet Shoemaker-Levy 9 impact on Jupiter, many experts have recognized that collisions with objects larger than a few hundred meters in diameter not only can threaten humanity on a global scale but have a finite probability of occurring. This recent public exposure to the consequences of a major planetary impact should encourage some willingness to invest more money into detection and mitigation technologies.

We should also realize that the technology required for a system to mitigate the most likely of impact scenarios is, with a little concerted effort, within our grasp. There are no current means for preventing many such natural disasters as earthquakes, tornadoes, and typhoons. Some of these disasters can not even be detected in time to give adequate warning to the affected population. Such is not the case with ECOs. Humanity certainly has the technology that, with a relatively modest investment, to warn of an impending

catastrophe, maybe years or decades in advance. In most cases, an associated mitigation system could use the latest nuclear explosives, space propulsion, guidance, and sensing and targeting technologies, coupled with spacecraft technology. These technologies already are related to defense capabilities, but how they are developed for use in space (and what effects they have) will offer invaluable experience for defense efforts.

We can maximize our investment by turning to the commercial world for technology development and highlight opportunities for dual-use possibilities.¹⁹ Space operations will continue to grow at a rapid rate as a factor in United States military capabilities limited primarily by affordable access.

It is quite possible that the current assumption of “anything in space costs more than it would on the ground” may no longer hold true in 2025. With rapid progress being made in miniaturization and with a downward trend in spacelift costs, the option of placing detection system components in orbit rather than on earth may be a money saver. The orbiting components can be tasked around the clock without regard for the weather conditions on the surface.

Large savings in Department of Defense (DOD) spending could result by stopping military-only launch access to space and reducing investment in technologies the commercial world can develop.²⁰ Beyond deflecting or fragmenting a threatening ECO, there may be some great advantage in capturing an asteroid into earth orbit. In addition to the scientific lessons learned in such a mission, many benefits could be gained by mining the asteroid's natural resources. Large-scale mining operations, from a single asteroid, could net upwards to twenty-five trillion dollars in nickel, platinum, or cobalt metals to offset the cost of the mitigation system (table 2).²¹

Parking an asteroid in orbit slightly higher than geosynchronous might be an ideal base of operations to maintain and salvage geosynchronous communication and surveillance systems used in surveillance of the near-earth environment.

Table 2

Economic Analysis of 2-km diameter M-Class Metal Rich Asteroid²²

Component	Fraction of Metal by Mass	Mass	Estimated Value \$/(Kg)	Estimated Current Market Dollar Value (in trillion)
Iron	0.89	2.7×10^{13}	0.1	3
Nickel	0.10	3.0×10^{12}	3	9
Cobalt	0.005	1.5×10^{11}	25	4
Platinum-group metals	15ppm	4.5×10^8	20,000	9
Total Value				25

Orbits occupying Lagrange points, L4 and L5 (to be discussed later), offer the most cost-effective orbits due to minimum energy required to maintain orbit. A captured asteroid also could be used for large space-based manufacturing or even as a space dock for buildup of interplanetary missions, eliminating the expensive need to launch large systems out of the earth's gravity.

Political Implications

Since planetary defense is a relatively new subject, there are no existing international treaties that specifically address it. However, in this section, we look at existing space treaties that offer relevance to planetary defense.²³ The Treaty on Principles Governing the Activities of States in the Exploration and Use of Outer Space, Including the Moon and Other Celestial Bodies, legally prohibiting weapons in space, provides perhaps the greatest restrictions to the concept of employing a Planetary Defense System (PDS).²⁴ Article 4 of this treaty, which became effective on 10 October 1967, states:

Parties to the Treaty undertake not to place in orbit around the Earth any object carrying nuclear weapons or any other kinds of weapons of mass destruction, install such weapons on celestial bodies, or station such weapons in outer space in any other manner.²⁵

Additionally, the *Agreement Governing the Activities of States on the Moon and Other Celestial Bodies*, enacted on 11 July 1979, applies to the Moon and other celestial bodies within the solar system.²⁶

Article 3 specifically restricts the use of nuclear weapons in space, stating:

Parties shall not place in orbit or around the Moon objects carrying nuclear weapons or any other kinds of weapons of mass destruction or place or use such weapons on or in the Moon.²⁷

Legal Aspects of Planetary Defense

Therefore, even though no existing treaties specifically prohibit the employment of a PDS, collectively, they provide enough legal restrictions to seriously affect the ability of operators to use it effectively when faced with a major extraterrestrial threat. In our extreme case involving the impending impact of an asteroid or comet and where the survival of the human race is potentially at risk, we assume that appropriate exceptions would be approved, allowing the use of nuclear weapons or other weapons of mass destruction to mitigate the threat. Indeed, these weapons could serve as the only means of saving the earth.

Fortunately, none of the existing treaties restrict the employment of detection devices-- whether they be earth-, space-, or planet-based--that would serve as major components of the PDS. As discussed in the "Concept of Operations (CONOPS)" section, our three-tier PDS concept includes near-, mid-, and far-range detection systems. Obviously, early detection and classification of an asteroid or comet as an ECO allows more reaction time and permits greater flexibility in developing viable courses of action. Therefore, our PDS concept places significant emphasis on detection at the greatest possible range.

A decision to develop and ultimately deploy a planetary defense system will involve numerous developmental tests, both at the system and subsystem levels. Inevitably, however, politicians and engineers will be faced with the dilemma involving the need to test the system under realistic conditions using weapons in space. A limited number of these tests will involve nuclear weapons, predictably against a simulated or actual ECO. Such tests are currently banned by the Treaty Banning Nuclear Weapons Tests in the Atmosphere, in Outer Space, and Underwater, which became effective on 10 October 1963 and stated:

Parties to undertake to prohibit, prevent and not to carry out any nuclear weapon test explosion, or any other nuclear explosion, at any place under its jurisdiction or control:

- (a) In the atmosphere, beyond its limits, including outer space, or under water, including territorial waters or high seas; or
- (b) In any other environment if such explosion causes radioactive debris to be present outside the territorial limits of the State under whose jurisdiction or control such explosion is conducted.²⁸

One of the biggest objections against nuclear testing in space involves radioactive fallout reentering the atmosphere with deleterious effects. In the case involving a nuclear intercept of an actual ECO, the potential

for death or injury due to fragmented asteroid impacts poses equal concern. The decision to use such weapons of mass destruction (WMD) would obviously involve much dialogue and debate, but, from an acquisition standpoint, such testing would be necessary to validate system credibility. With the united commitment of the global community, it is anticipated that the treaty restrictions mentioned earlier could be waived to permit such a test.

As the planetary defense problem becomes better understood and accepted within the global community, and as potential solutions, including a PDS, are developed, it will likely become necessary to selectively renegotiate existing treaties that currently prohibit testing and using weapons in space. Perhaps a treaty specifically tailored to the evolutionary development of a planetary defense system as well as its use during an ECO threat crisis will be needed. Regardless of the outcome, however, it is safe to say that the use of weapons in space, especially WMD, will remain highly restricted.

European Perspective On Planetary Defense

If one nation, such as the US, attempted to place weapons in space, the world would likely oppose such an attempt. Therefore, the US would not likely attempt to forge a PDS alone. Realistically, the US would require a coalition with other nations, such as the Europeans, Russians, Japanese, and other aerospace nations of the future, before placing weapons in space. While discussing the interaction of each of these nations is beyond the scope of this paper, the political and economic issues are worthy of comment since these factors will affect all participants. In this section, our Italian co-author, Ms Iole M. DeAngelis, offers insight into this area, especially, from a European point of view.²⁹

In analyzing the political structure and processes of the European continent, the first and most significant factor noted is that Europe is not a single political entity; hence policies reflect consensus among many different European countries. Similar to the democratic process in the United States, the European political organization allows for free-flowing discussion as issues are openly debated and agreements are ultimately reached. As is the case in the US, debate can be an extremely time-consuming process. In Europe, countries such as the United Kingdom (UK), have long enjoyed a close relationship and spirit of cooperation with the United States, while others, like France, have historically rejected US influence in European policy-making.

As discussed in this paper, the development, testing, and deployment costs of a planetary defense system likely will be staggering, especially if the three-tier PDS concept is adopted. However, we believe the catastrophic results of a large asteroid or comet impact, including the potential extinction of the human race, justify such an expenditure, especially if it can be incrementally funded. Obviously, since the planetary defense problem is global in nature, one should not expect that the PDS costs will be borne by one or even a few countries. Indeed, such an endeavor will certainly fail without the cooperation and commitment of the entire global community. In this sense, Europe must be a major player in the successful implementation of a PDS.

When considering future European involvement in space-related issues, it is important to include the activities of the European Space Agency (ESA), with its international perspective and influence. Without a doubt, the ESA will be critical to the successful development and deployment of the PDS, especially with its close ties to France as one of ESA's most influential members.

Since France does not favor the influence of the US on European policy decisions, the US should use caution as it identifies requirements and ideas for a PDS. However, considering the need for global funding to support the development of the technologies and capabilities required for such a system, the US also must maintain open lines of communication with every major player to achieve a viable solution to the planetary defense problem. Given the normal reluctance of most countries to accept solutions or direction originating from a superpower such as the US automatically, it may be more effective to use a neutral element as the lead to pull the global community together and develop a strategy that all parties can support. Further, since there will likely be reservations, mistrust, and possibly even rejection due to the dual-use potential of the PDS as a strategic weapon, a neutral element would help to alleviate such fears.

Because of its global charter, the United Nations is probably the best organization to assume the leadership role in pulling together the global community, educating it about the planetary defense problem, garnering support for the development of a global PDS strategy, and ultimately serving as the primary advocate for the evolution of a functional planetary defense system to protect the EMS against ECO impacts. Clearly, the international influence of the UN will serve as an important foundation for the global community to implement the PDS strategic plan.

Both education and communication will be crucial to the success of the PDS developmental process. The ECO threat must be presented in layman's terms, not using complex scientific jargon, for the program to gain public support. For example, an 80- year-old grandmother must be able to understand why a part of her pension will be used to pay for this system. Public opinion will influence political decisions regarding funding and research and development commitments.

In any case, it is important to distinguish between education and information, because, while we need to make people aware of ECO problem, we do not want to create panic or anxiety. One way to promote awareness is through the use of thought-provoking television documentaries and movies such as *Meteor*.³⁰ The Internet offers another way to educate the public about planetary defense issues. However, since many people do not own a computer it is not as effective as television yet for reaching the large numbers we will need to educate.

Communication problems commonly exist between politicians, scientists, engineers, and the general public, not because these groups lack the desire to work together, but because of their inherent language differences. Realizing that the scientific community alone will not bring the PDS program to fruition, these groups must resolve their communication problems as early as possible and ultimately speak with one voice, especially when it comes to justifying commitments of limited resources.

Since private enterprises and not governments produce systems, it will be important to achieve the cooperation of the global community to ensure that the economic needs of these enterprises are fulfilled. In this regard, it may be beneficial to adopt the ESA policy of *juste retour*, despite its inherent drawbacks in efficiency and economies of scale, to promote global commitment and cooperation.³¹

Considering the general willingness of governments to participate in large space projects and with the ever-present uncertainty of the budget process, it is conceivable that a consortium-based PDS effort could become another International Space Station (ISS). In the latter case, the ISS project ended up with many ideas, studies, and proposals, but offered little to nothing in the way of actual development due to normal budget fluctuations, infighting, and the resulting inability of the participants to absorb the exorbitant developmental costs. Like ISS, a repeat of this approach might also cause the PDS project to be added to the list of failures.

Planetary Defense as a European Space Policy Priority

In this section, we will take a look at planetary defense as a European space policy priority.³² The ESA currently does not have an ECO detection program. A possible near-term solution might be the Infrared Space Observatory (ISO). The ISO is a long-duration observatory of celestial radiation sources. Using this system, astronomers will be able to observe low-temperature stars (stars hidden by dust that only infrared light can penetrate) and can even detect planetary systems similar to earth by searching for life forms outside the solar system.

Initially, ISO will analyze the planets of the solar system and their satellites. In particular, it will focus on *Titan*, because astronomers suspect that its atmosphere may host complex chemical processes similar to those supporting life on earth. ISO will eventually be added to the growing number of observatories actively involved in detecting and classifying ECOs.³³

Planetary defense is not a high priority in the minds of many Europeans today. This lack of concern is true especially at the political level, even with the projected ISO capabilities. Although ISO will serve as a valuable means of ECO detection, there is generally little awareness about the ECO impact threat within the European region. Yet, within Europe, there are significant scientific talents and resources that need to be integrated into the overall global effort. Hopefully, greater participation in planetary defense workshops will help to increase European awareness and, ultimately, stimulate interest in achieving a viable solution to the problem. Communications and education will be critical to obtaining European support and commitment and establishing planetary defense as a European space policy priority.

Alternate Futures and Political Outlook For Planetary Defense

We believe it is realistic to assume that the treaties governing operations and activities in space will change before 2025, because, like the treaties previously discussed, they depend on the international environment. They also depend on the evolution of technologies and changes in resource availability, as well as other needs, including for example, economic exploitation of NEOs for minerals and scarce resources.

The 2025 Project developed five alternate futures for the year 2025, plus one possible scenario for 2015, and based on that work, it is possible to imagine how treaties may evolve and whether the international environment will be favorable to the implementation of a planetary defense system.

In the first future scenario “Gulliver’s Travails,”³⁴ there is no place for a PDS, because each country is busy defending itself from the others, and there is no possibility for cooperation. There is not enough money for space exploration or issues as the states are too busy with national and international problems. In fact, this scenario suggests that the existing treaties are sufficient.³⁵

In the second scenario, “Zaibatsu,”³⁶ planetary cooperation is led by the UN to counter an asteroid threat to the earth in the year 2007.³⁷ In this scenario the international situation is favorable to cooperation, mostly in the economic field, and it is rational to think that the treaties on outer space will change to allow economic exploitation of space and allow for a PDS to evolve. As the world was able to survive an asteroid threat due to technological development, it is logical to assume that the world will be able, sometime during the 1997 to 2007 time frame, to deploy a PDS to mitigate the asteroid.

In the third scenario, “Digital Cacophony,”³⁸ it is difficult to envision a global PDS, because power is dispersed among many actors and governments. However, it is rational to suppose that more than one actor or government has developed a PDS because of the ultrahigh-technology capabilities. Furthermore, in this scenario, national defense tactics are based upon a strong strategic defense. Therefore, it is reasonable to foresee technical capability to deal with and survive an ECO encounter.³⁹

Planetary defense in the fourth scenario, “King Khan,”⁴⁰ strongly depends on the political will of the superpowers. The technological capability is present, but the ECO threat is unimportant to the elites who are more worried about maintaining the international equilibrium. It is possible to presume the existence of some kind of WMD deployment in outer space.⁴¹

In the fifth scenario, “Half & Half-Naughts,”⁴² there is a PDS system jointly developed by the US, China, Russia, and European Union. However the reexplosion of war in the Balkans, earthquakes in California, wars in Africa, crisis in Cuba--all happening at the same time--make the coordination difficult among these countries.⁴³ But in case of a real and urgent menace, it is possible to insure the survival of the earth, thanks to the high level of technology.

In the 2015 scenario, “Crossroads,”⁴⁴ the world seems to favor cooperation after the success of several UN operations. This international organization acquires new respect and new power that enables it to lead a cooperative effort to deploy a PDS and promote the exploitation of outer space.

In any case, these scenarios are just scenarios, and thus, they do not represent what will necessarily happen. They do provide options, however, and remind us that humanity still has time to choose a path of survival or a way of living and thinking about the environment, especially in regards to developing a PDS. The implementation of a PDS will offer nations a unique opportunity to cooperate in a legal fashion to provide for the survival of the EMS.

Planetary defense efforts need to be consolidated, coordinated, and expanded under international leadership. The US should not go it alone. The threat is global; detection efforts will require observation sites throughout the world, and other nations possess unique technologies, spacelift, and other space-related capabilities which also could be used to develop and deploy a PDS.

Any action should involve the international community. This thinking is particularly important as mitigation efforts could require nuclear capabilities, and these intentions could violate current arms control treaties. Furthermore, a handful of the thousands of nuclear weapons being deactivated under the Strategic Arms Reduction Talks (START) agreement might offer the most expeditious solution to this problem. START implications would require DOD involvement.

Why should the DOD take an active interest in the planetary defense issue? Given such a scenario, the effects could threaten the national security of the US, even if it were not physically impacted. Certainly, the international community cannot deal with a disaster in which a significant portion the world is destroyed. All surviving nations would be affected. The devastating blows to governmental and societal structures could be equivalent to those thought of when talking about a post-global-nuclear war holocaust, but lacking perhaps the lethal radiation effects. More importantly, once a threat is detected in advance, the nation and perhaps the entire planet will quite naturally look to the DOD to provide the means, technical expertise, and leadership, in addition to the required forces, to counter such a threat to its citizens’ lives and well-being. A number of other US organizations and agencies will certainly be involved, including NASA, Department of Energy (DOE), Federal Emergency Management Agency (FEMA), and Office of Foreign Disaster Assistance (OFDA) and national laboratories and universities.

There will also most likely be an international effort to include the United Nations. Currently, Russia, Great Britain, France, Canada, Japan, Australia, China, Italy, the Czech Republic, and other nations have shown an interest in this topic. However, few organizations other than the DOD have the experience and capability to even attempt such an effort.

Russia, with its military and space infrastructure, is probably the only other nation capable of the task, but a consolidated effort will offer the best chance of survival. Suffice it to say that the DOD will form the core around which the others could organize.

The fact that it may only happen once in several lifetimes does not absolve the current defense team of at least a moral responsibility if it does happen, particularly if it had the means to prevent or at least mitigate it. Perhaps for the first time in not only human history but the entire history of the planet, the inhabitants of earth are on the verge of having such capability. Currently, the chemical and nuclear propulsion systems now in development offer the best options for planetary defense. Employment of nuclear devices in a standoff mode represents the gentle nudge of all the options available. Though technically much more difficult, nuclear devices exploded on or beneath the object's surface impart 10 or more times the impulse of a standoff explosion.⁴⁵

International concern for use of these weapons leads to many political questions and misgivings. Ironically, these devices "could be notably straightforward to create and safe to maintain because they derive from vast research and development expenditures and experience accumulated during the forty-five years of the Cold War."⁴⁶ Technically, without an appropriate reentry vehicle, these devices could not be used as ballistic weapons, though there is always the possibility of terrorism or misuse. In any event, effective international protocols and controls could be established through the United Nations to minimize downside potential.

The debate will certainly continue, however, as evidenced in *The Deflection Dilemma: Use vs. Misuse of Technologies for Avoiding Interplanetary Hazards*: "The potential for misuse of a system built in advance of an explicit need may in the long run expose us to a greater risk than the added protection it offers."⁴⁷ The greatest challenge involves the building of international coordination, cooperation, and support. The threat of ECOs is a global problem and one which the entire world community should be concerned with. Coordination between nations, international organizations, DOD, NASA, DOE, academia,

and others in the scientific community is essential in establishing the building blocks for a credible PDS. It is necessary to build trust, coordinate resources, consolidate efforts, and seek cooperation with and support for similar efforts in the international community.

Notes

¹ The NASA Ames Space Science Division, *The Spaceguard Survey, Hazard of Cosmic Impacts* (1996), 2.1.

² Steve Nadis, "Asteroid Hazards Stir Up Defense Debate," *Nature* 375 (18 May 1995): 174.

³ "Meteorite House Call," *Sky & Telescope* August 1993, 13.

⁴ John S. Lewis, *Rain of Iron and Ice* (Reading, Mass.: Addison-Wesley, 1996), 176–82.

⁵ A. Whipple and P. Shelus, "Long-Term Dynamical Evolution to the Minor Planet (4179) Toutatis," *Icarus* 408 1993, 105.

⁶ C. Powell, "Asteroid Hunters," *Scientific American*, April 1993, 34–40.

⁷ "Satellites Detect Record Meteor," *Sky & Telescope*, June 1994, 11.

⁸ Clark R. Chapman and David Morrison, "Impacts on the Earth by asteroids and comets: assessing the hazard," *Nature* 367 (6 January 1994): 35.

⁹ Lewis, 176–82.

¹⁰ Jeff Hecht, "Asteroid 'airburst' may have devastated New Zealand," *New Scientist*, 5 October 1991, 19.

¹¹ *The Spaceguard Survey: Report of the NASA International Near-Earth-Object Detection Workshop*, ed. David Morrison (Pasadena, Calif.: Jet Propulsion Laboratory, 1992), 8.

¹² The NASA Ames Space Science Division, 2.4.

¹³ Lewis, 83.

¹⁴ Gregory H. Canavan, "The Cost and Benefit of Near-Earth Object Detection and Interception" in *Hazards Due to Comets and Asteroids*, ed. Tom Gehrels (Tucson, Ariz.: University of Arizona Press, 1994), 1157–88.

¹⁵ Chapman & Morrison, 39.

¹⁶ Gregory H. Canavan, 1157–88.

¹⁷ Ibid.

¹⁸ The NASA Ames Space Science Division, 8.1 and 9.3.

¹⁹ Ronald R. Fogleman and Sheila E. Widnall, memorandum to Dr McCall, *New World Vistas*, 15 December 1995, attach 1.

²⁰ USAF Scientific Advisory Board, *New World Vistas: Air and Space Power for the 21st Century* (unpublished draft, the recommended actions executive summary volume, 15 December 1995), 63.

²¹ W. K. Hartmann and A. Sokolov, "Evaluating Space Resources," in *Hazards Due to Comets and Asteroids*, ed. Tom Gehrels (Tucson, Ariz.: The University of Arizona Press, 1994), 1216.

²² Ibid.

²³ This section was contributed by Ms Iole De Angelis, a graduate student at the International Space University, Strasbourg, France. Her participation in the *2025 Project* came at the request of Air University to provide expertise in the areas of space treaties and international law. In addition, her insights lend an international flavor to a truly global problem.

²⁴ “Treaty on Principles Governing the Activities of States in the Exploration and Use of Outer Space, Including the Moon and Other Celestial Bodies,” *Arms Control and Disarmament Agreements* (Washington D. C.: United States Arms Control and Disarmament Agency, 1982), 48–50.

²⁵ *Ibid.*, 52.

²⁶ “Agreement Governing the Activities of States on the Moon and Other Celestial Bodies,” 1979, n.p.; on-line, Internet, 30 May 1996, available from gopher://gopher.law.cornell.edu:70/00/foreign/fletcher.

²⁷ “Treaty on Principles.

²⁸ “Treaty Banning Nuclear Weapon Tests in the Atmosphere, in Outer Space and Under Water,” 1963, n.p.; on-line, Internet, 30 May 1996, available from gopher://gopher.law.cornell.edu:70/00/foreign/fletcher.BH454.txt.

²⁹ This section was contributed by Ms Iole De Angelis.

³⁰ *Meteor*, dir. by Ronald Neame, prod. by Arnold Orgoline and Theodore Pareign (Hollywood: Orion Studios, 1979). The motion picture depicts a nuclear weapon system used to mitigate an ECO predicted to impact Earth.

³¹ The *juste retour* policy forces the governmental and private interests into cooperation: from a given amount of money one government puts in the common project, private enterprises of its country receive comparable amounts to build the components. For example, there is a project that costs \$100; country “A” finances for \$50; country “B” for \$30; and country “C” for \$20. So the enterprises of country “A” will receive contracts for \$50, the enterprises of country “B” will receive contracts for \$30, and the enterprises of country “C” will receive contracts for \$20.

³² This section was contributed by Ms Iole De Angelis.

³³ “ISO, unique explorer of the invisible cool universe,” *ESA Presse*, no. 21-95, 07 October 1995, n.p.; on-line, Internet, 30 May 1996, available from <http://isowww.estec.esa.nl/activities/info/info2195e.html>.

³⁴ “Alternate Futures,” *2025: CSAF Directed Study on Air and Space Power*, Draft 2, 11 March 96, 36.

³⁵ *Ibid.*, 37.

³⁶ *Ibid.*, 55.

³⁷ *Ibid.*, 57.

³⁸ *Ibid.*, 67.

³⁹ *Ibid.*, 68.

⁴⁰ *Ibid.*, 83.

⁴¹ *Ibid.*, 84.

⁴² *Ibid.*, 99.

⁴³ *Ibid.*, 101.

⁴⁴ *Ibid.*, 111.

⁴⁵ *Proceedings of the Near-Earth-Object Interception Workshop*, eds. G. H. Canavan, J. C. Solem, and J. D. G. Rather, (Los Alamos, New Mex.: Los Alamos National Laboratory, 1992), 117.

⁴⁶ *Ibid.*, 120.

⁴⁷ Alan Harris et al., *The Deflection Dilemma: Use vs. Misuse of Technologies for Avoiding Interplanetary Hazards* (Ithaca, N.Y.: Cornell University Center for Radiophysics and Space Research, 3 Feb 1994).

Chapter 3

Planetary Defense System

Mission and Required Capability

Before describing the capability required in a PDS, it is important to define its intended mission. Simply stated, the PDS mission is “to defend the Earth-Moon system against all Earth-crossing-object threats.”¹ At this time, Planetary Defense (detecting, tracking, cataloging, or mitigating ECOs) is not an assigned or approved mission of the Department of Defense or the Air Force.

Required Capability

The capability required of a PDS varies with the scenarios that may occur. Table 3 provides four different scenarios which depend upon the path of the ECO.² The ECO scenario reveals time available for action, nature of action required, probabilities of detection (percentage of currently estimated known ECOs greater than 1 kilometer diameter and percentage of those yet to be detected), distances at which they will likely be detected, deflection velocities (ΔV) required to mitigate, and likely type of ECO (an ECA is an earth-crossing asteroid). An ideal PDS would provide adequate defense for all four scenarios.

Table 3

ECO Scenarios

ECO Scenario	Time	Action	>1 km ECO	Distance (AU)	ΔV (cm/s)	ECO
1. Well-Defined Orbit	10+ Years	Long term	5/95%	2	1	ECAs
2. More Uncertain Orbit	Years	Urgent	Unknown	2	10-100	New ECAs, Short-period comets
3. Immediate Threat	1-12 Mos.	All-out effort	95/5%	0.1 (comet) 0.1-1 (ECA)	>1,000@0.1 AU >100@1 AU	Long-period comets, Small new ECAs
4. No Warning	0-30 Days	Evacuate	Unknown	0	10-40 km/s impact	Long period comets, Rogue ECAs

One only has to watch Star Trek to imagine the ultimate system to be used to detect and mitigate ECOs—the *Enterprise*. The *Enterprise's* on-board detection systems, command, control, communications, and computer, intelligence systems, photon laser systems, and capability to travel at 10 times the speed of light would enable it to protect the earth from all but the least likely of scenarios such as multiple or large ECOs. Limits to advances in technology and spending make it unlikely that such a system would be developed by 2025.

The *Enterprise*, however, does provide an advanced system model from which we can deduce current or future systems capable of yielding similar results. Such a system can be broken down into three main subsystems: detection, C⁴I, and mitigation.

The earlier an ECO is detected, the more time is available for mitigation action. Thus, of the three subsystems, detection subsystems appear to be the most critical at the present time. It is the first system that should be funded, researched, developed, and deployed. Fortunately, some initial steps in the correct direction already have been taken with regard to detection. The most notably has been initial components of the Spaceguard Detection Network (described in a later section). By 2025 the PDS detection subsystem must be much improved in regards to search (sky coverage), focusing speed, range, and resolution.

Command, control, communications, and computer subsystems are the glue to hold the PDS together. Advanced command, control and computers systems will be necessary to optimize scanning, tracking, and orbit determination for the detection system. Intelligence systems are necessary to determine the

composition, strength, and other physical characteristics of ECOs. Advanced command, control, communications and computer systems are required to direct the mitigation systems to their targets and perform their mission. As detection capabilities improve, C⁴I must keep pace with the expanding volume of data that must be shared among globally dispersed observation sites. Present coordination methods using the telephone, fax, and electronic mail for follow-up will be grossly inadequate. Follow-up notification must be immediate, and search data must be updated and shared globally in real-time. Fortunately, communications bandwidth and data storage technologies are expanding at a breathtaking rate even without the concern of planetary defense. Required system capabilities should be available prior to 2025.

Ready-to-go subsystems with ECO mitigation capabilities do not currently exist, though many scientists believe nuclear weapons could provide near-term protection with modification. Many potential nonnuclear defense subsystems have been identified in the past, and we have proposed several more, though we admit they are on the fringe between reality and imagination. Regardless of type, we are not convinced that mitigation subsystems need to be developed in the near term or even prior to 2025. It is perhaps better for us to encourage and wait for technology breakthroughs to drive the direction of these subsystems. If we develop a capable detection subsystem and it detects an ECO of concern, then a timetable for complete mitigation subsystems development and deployment will be necessary and priority for funding will be justified. By 2025 safer, cheaper, and more politically acceptable mitigation systems than the current nuclear systems should be available.

Detection Subsystems

Humanity has observed and often recorded the phenomena of comets, meteors, and meteorites throughout the recorded history, however little was understood. In 616 AD the Chinese reported the crushing of 10 people by a meteorite. The idea that comets might possibly strike the earth was first considered by Jakob Bernoulli a millennium later, in 1682. Fourteen years later, William Whiston predicted that the comet of 1680 would next return in 2255, when it would impact the earth and cause the end of the world. Nearly a century later, in 1777, Anders Lexell showed that the comet observed seven years earlier had made what is

still the record confirmed closest approach to earth, little more than 1.2 million miles. And in 1801, *Ceres*, the first asteroid was discovered.³

Little concern with the prospect of an ECO impact seemed evident, however, until the near-earth passage of the asteroid *Icarus* in 1968. Although the orbit was carefully monitored to bring it no closer than 3.6 million miles from earth, professors at the Massachusetts Institute of Technology challenged 21 students in the Advanced Space Systems Engineering course to propose what could be done if *Icarus*, the 13th known near-earth asteroid, happened onto a collision course with earth. At least 30 newspapers and other print media published sensationalized and often distorted accounts of the project and the circumstances of the asteroid impact. As a result, many Americans for the first time became aware of both the possibility of an ECO impact and the possibility that something could be done about it.⁴ In 1980, when a new theory explained the extinction of dinosaurs due to a gigantic asteroid impact, the attention of the scientific community was at an all-time high. The concept of planetary defense began to move appreciably forward, at least in the sense of determining the level of an ECO threat.

Current Detection Programs

By 1982 the discovery rate of NEOs reached 10 each year as several systematic photographic search programs were established. The greatest leap forward thus far in the area of ECO detection occurred in 1989, when the Spacewatch program began operation. Conceived and directed by Tom Gehrels at the University of Arizona, Spacewatch incorporates modern electron charge-coupled detectors (CCD) and computers to automate much of the discovery process. Digital intensity information is read from a 2,048 x 2,048 pixel array and is used to build an exhaustive catalogue of all objects, including stars, galaxies, belt asteroids, comets, and NEOs in the image. The data is stored magnetically, and later the same night, the computer directs the 36-inch telescope back to the same area for a second image. The computer instantly compares the objects in the second image with the first, checking off each object against what is stored in the catalogue and notes any feature that only appears in one image. Finally, the computer takes a third image to verify that objects that seem to move between the first two images, continue to do so.⁵ On a good clear night, as many as 600 new asteroids are discovered, and on average, one in 900 of these is a NEO.⁶

With planned improvements to the Spacewatch network including a new 1.8-meter mirror telescope at Kitt Peak and electronics upgrades in Australia and in France, Mr Gehrels estimates that if there are any 1 kilometer or larger asteroids on a collision course with the EMS, we should know of them by the year 2008. Unfortunately, though, Spacewatch will not be sufficient to entirely rule out the threat of smaller but still dangerous asteroids and of long period comets.⁷

Figure 3-1 shows the locations worldwide of the four current ECO search programs. (At Palomar, California: the Palomar Asteroid and Comet Survey and Palomar Planet-Crossing Asteroid Survey surveys; at Kitt Peak, Arizona: Spacewatch; in Western Australia: Anglo-Australian Near-Earth Asteroid Survey.⁸)

Note that only one survey is currently operational in the Southern Hemisphere. The 1991 *Spaceguard Survey* Workshop recommended a \$50 million up-front and \$10-15 million per-year program.⁹ With six globally dispersed Spacewatch-type telescopes, scientists expect to achieve a discovery rate of one object for every two seconds of observation time.¹⁰ (In addition to Kitt Peak and Palomar, other Northern Hemisphere observatories would be located, possibly in India and France. In the Southern Hemisphere, in addition to Australia, Chile would be an ideal site.¹¹)

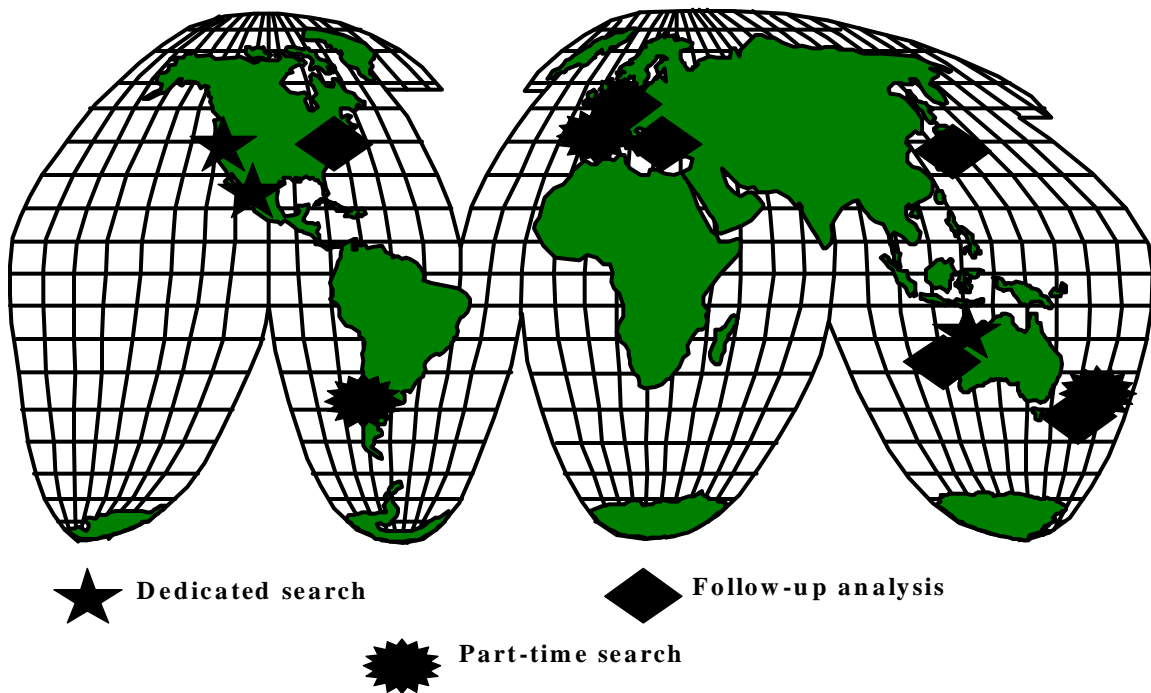

Source: *Hazards*, 129–136.

Figure 3-1. Current ECO Search and Detection Network

Detection, Tracking, and Homing

The detection subsystem of the 2025 PDS is comprised of three, broad functional roles, each of which can be further subdivided into several discrete tasks. The roles, in sequence include detection, tracking, and homing.

The detection role is comprised of two tasks: discovery and discrimination. The PDS detection subsystem detects all potential ECOs at a maximum distance from the EMS. Long-range detection equates to advance warning time. Advance notice of a potential impactor is the single most important variable in the PDS problem. The earlier an ECO is discovered, the more options are available to mitigate the threat. The detection system or systems should continuously search the total volume of space for all asteroids and comets that exceed a size and mass that can be assured to burn up during descent through the earth's atmosphere.

It is of great importance also to quickly determine whether the just-detected object is a true, first-time discovery, or whether it has been previously discovered, catalogued, and then lost for a period of time because of obstructions or excessive distance from earth.

The problems of long range and discrimination are not the only major detection obstacles to overcome. The volume of sky is perhaps the greatest obstacle. Present telescope capabilities only can search approximately 6,000 square degrees of the night sky each month. Total sky coverage is 41,000 square degrees.¹²

For 2025 we have specified a required capability to search the entire volume of space on a daily basis, to detect an object of a minimum size of 100 meters in diameter at a minimum distance of 2.5 astronomical units (AU) (slightly more than the average distance to the main asteroid belt between Mars and Jupiter of 2.2 AU from Earth), and to confirm within seconds whether the object is a new discovery or is an object that is already cataloged.¹³ Current Spacewatch capabilities require 150 telescopes to discover all 200,000 (or more) 250 meter ECOs within 20 years and orders of magnitude more of them to discover 100 meter objects.¹⁴ Obviously, this is not the solution. Computers must be harnessed to modern telescopes in a way to dramatically reduce the time it takes to make initial and follow-up observations.

Tracking, the second broad role, begins as soon as it is determined that an object has the potential to impact the EMS. The tracking role encompasses the follow-up functions of astrometric analysis and the constant awareness of the object's whereabouts. Astrometric analysis refers to the precise calculation of

position and velocity. These aspects are discussed in detail in the later C⁴I section. The tracking subsystem should strive to use an independent means of orbit calculation to confirm the initial diagnosis of an earth-crossing orbit or dangerously close passage. Calculation of an EMS threatening orbit must be completed with sufficient advance notice to still permit selection of the most benign and most cost-effective approach to mitigate the threat.

For 2025 our tracking requirements are that astrometric analysis be completed within hours of discovery, the ability to know an ECO's whereabouts at all times regardless of whether it may be visually blocked by other celestial objects in the foreground or background, the ability to track an ECO regardless of meteorological conditions and the effects of daylight and moonlight, and, the ability to feed targeting information in realtime, or near real-time, to the mitigation system throughout application.

The last broad role of detection is homing/results assessment. In one sense it can be thought of as targeting and battle damage assessment (BDA). However, in planetary defense, destruction of an ECO is only one possible response to the situation.

Specific 2025 tasks and requirements encompass the ability to accurately guide a spacecraft to the ECO, to observe on earth the mitigation actions as they are applied, immediate feedback of the success or failure of the mitigation action, and, if mitigation is unsuccessful or only partially successful, continued observation until successful hand-off to the detection or tracking subsystem.

In summary, detection is currently the most advanced portion of the PDS by far. The seven-year-old Spacewatch program is currently searching space for 1 kilometer and larger ECOs, and all earth-crossing asteroids should be known by 2008. However, several major shortfalls exist with Spacewatch. First, the Spacewatch ECO size cut-off at 1 kilometer and greater is an order of magnitude larger than we feel can be safely ignored. Secondly, the current rate of discoveries is barely acceptable at the 1 kilometer size cut-off (given a total estimated population of approximately 2,000). To search for all objects greater than 100 meters the estimated population climbs to several hundred thousands, thus a significantly faster detection rate must be achieved.

Detection Concepts for 2025

So, how can the greater rates of discovery necessary in 2025 be achieved? One way of substantially increasing ECO discovery rates is by using the current capability of the USAF's Ground-Based Electro-Optical Deep Space Surveillance System assets. It is estimated that a single GEODSS telescope could improve upon the Spacewatch program's discovery rate by a factor of 20.¹⁵ To speed tracking solutions, increased access to the large planetary radars at Puerto Rico and California is also recommended.¹⁶

One 2025 concept is to employ change detection sensors. Rather than scrutinizing all objects in space, the sensors would search only for movement ("change") in space. With movement sensitivity properly gauged to eliminate distant bodies, observation devices could concentrate only on near-earth and thus potentially earth-crossing objects.¹⁷

How also will daily total sky coverage and constant, real-time tracking occur? Use of only ground-based optical assets is insufficient to search the total sky. While ground-based optical can currently detect 100 meter ECOs in opposition (on the side of the Earth opposite from the Sun), they are blinded when objects are in conjunction (sun side). Emerging technologies available in 2025 should be better able to handle this problem.

Use of space for basing space observation platforms makes good sense for 2025. While it is currently much more expensive to use a space-based platform rather than a ground-based one, the cost difference should be less pronounced in 2025, particularly when effectiveness and lack of downtime are factored in. Space-based systems will not have to deal with clouds, weather, and pollution, for example.

Figure 3-2 shows one detection concept suggested by the Lawrence Livermore National Laboratory. By placing sensors in space, operational time is substantially increased, surface weather conditions are eliminated as an obstacle to viewing faint objects, and a larger unobstructed field of view is possible.

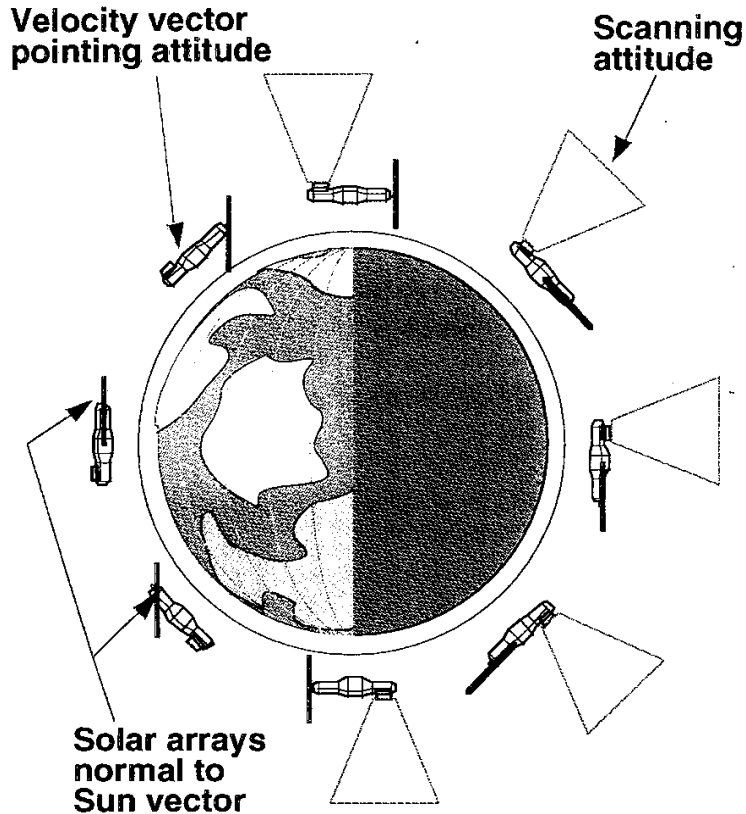

**Velocity vector pointing
Minimize cross-section
exposed to airstream (drag)**

Source: L. L. Wood, et al., “Cosmic Bombardment IV: Averting Catastrophe in the Here-and-Now,” Presentation to Problems of Earth Protection Against the Impact with Near-Earth Objects (SPE-94) (Chelybinsk, Russia: Russian Federal Nuclear Center, 26–30 September 1994).

Figure 3-2. Sky Eyes—Deep Space Sentry System Concept

Table 4 summarizes potential detection technologies and systems with respect to their technology availability, ECO scenario applicability, risk level, problems, maintenance requirements, and cost.

Borrowing from the *New World Vistas* study, distributed constellations of lightweight and relatively inexpensive sensing satellites could be deployed and linked to each other by laser data links.¹⁸

Table 4

Detection Technologies

System	Tech	ECO Scenario Application *	Risk Level	Problems	Maintenance	Cost in Millions of Dollars
Ground-based Optical & Radar	Now	1,2,3,4 (Detection, Tracking, Homing)	N/A	Sunlight, Weather	Low-Med	10+
Space-based Optical	Now	1,2,3,4 (Detection, Tracking, Homing)	N/A	Earth, Moon, other obstr.	N/A	TBD
Ground-based Infrared	Now	1,2,3,4 (Detection, Tracking, Homing)	N/A	Weather, Horizon	Low-Med	10+
Space-based Infrared	Now	1,2,3,4 (Detection, Tracking, Homing)	N/A	Earth, Moon, other obstr.	N/A	TBD
Ground-based Radar	Now	1,2,3,4 (Tracking, Homing)	N/A	Weather, Horizon	Low-Med	10+
Space-based Radar	2025	1,2,3,4 (Detection, Tracking, Homing)	N/A	Size, Limited Range (space loss)	N/A	TBD
Space-based LIDAR/LADAR	2010	1,2,3,4 (Tracking, Feedback)	N/A	Field of View Limits	N/A	TBD

* ECO Scenarios 1-4 are described in Table 3

Active sensing systems on these satellites would potentially use infrared, light detection and ranging (LIDAR), radar, laser detection and ranging (LADAR), and radio array to detect the radiation and low-frequency radio emissions caused by object movement in the solar winds.

Satellite constellations might best be placed in orbits other than around the earth. For example, Aten asteroids, which threaten the earth from the sunward side, could be detected by satellites in orbit around Venus, Mars, or Jupiter or by satellites in a halo orbit around the Lagrangian point between the Earth and the Sun, or in solar orbit above the main asteroid belt between Mars or Jupiter.¹⁹

Command, Control, Communications, and Computers, and Intelligence Subsystems

The defense of the Earth-Moon system requires a global outlook, in spite of limitations in international cooperation. *Leadership* of a planetary defense program is a critical issue which must be established both nationally and globally. However some nations may possess the capability to unilaterally defend the planet, their own territory, or the territory of selected allies. This paper suggests a possible leadership framework. This section presents a command and control system based on that proposed framework. Command and control of a system of systems to detect and mitigate ECO threats poses many challenges—especially command relationships among international organizations.

Unilateral US Command Elements

By 2025 the United States could certainly possess the capability to defend the planet either through an expedient, ad hoc effort or through a deliberately planned, funded, and coordinated program. With either possibility the US could take the lead by default or by its own initiative. The proposed command structure will allow the United States to unilaterally lead and execute the effective detection and mitigation of an ECO threat (fig. 3-3).

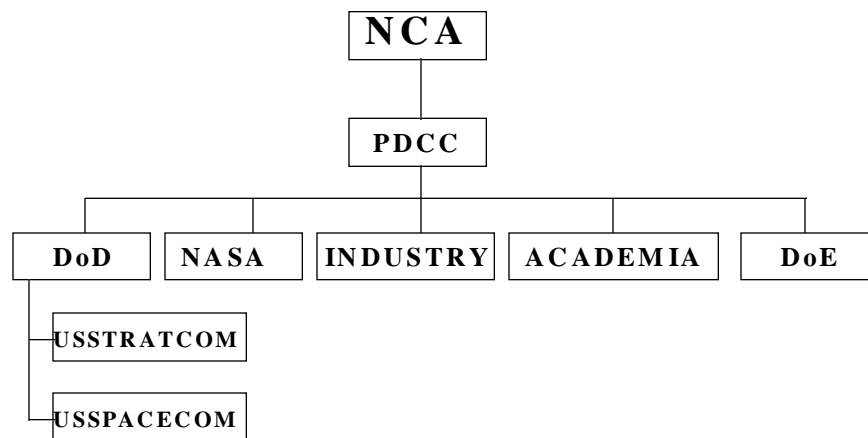

Figure 3-3. Proposed Unilateral US Command Structure

The National Command Authority (NCA) would oversee the efforts of the primary players in the PDS and coordinate their activities. This coordination would take place through a new entity, the Planetary Defense Coordination Council (PDCC). The PDCC would in turn work with the European Space Agency and the Council of International Cooperation in the Study and Utilization of Outer Space—European Agencies with similar interests and capabilities. Although American private industry and academia are not subject to the strict command relationships of federal bureaucracies, during a time of global crisis they would likely adhere to the direction of the NCA—much in the same way they did during World War II—by banding together to combat a threat to all Americans and possibly to all other humanity.

International Command Elements

The alternate futures developed for the *2025* study pose varying degrees of global leadership; that is, the role of the United Nations varies greatly with the alternate future. This section assumes that the UN has no strict governmental authority—only its mandate over its member nations. This situation is similar to what exists in 1996. In that light, no nation has subjugated its sovereignty to the UN. So with respect to the world powers, the UN acts with little higher authority. There is no hierarchical structure. But regional organizations such as the European Union will have increased clout as some European nations will have banded together for increased influence. Other possibilities include regional alliances in other areas of the world, including Africa, Asia, and the Middle East. Countries in these areas may form coalitions to increase their political, economic, and military power.

Command Responsibilities—US Unilateral Action

With respect to planetary defense in 2025, there will be no official global government power to unilaterally organize, develop, deploy, and operate a planetary defense system. The planet will be forced to rely on voluntary cooperation of countries for defense against ECO impacts. But under the threat of such a catastrophe, the cooperation among nations to the decisions of the United Nations probably would run akin to the cooperation of American academia and private industry to decisions of the National Command Authority. An ECO could bring together and coalesce the nations of the world under one authority for the common good.

C⁴I for Detection Subsystems

Three entities would hold primary responsibility for detection of ECOs: international observatories (generally managed by academia in coordination with government), the US Air Force, and NASA. During normal times, these entities would conduct operations without requiring significant outside direction. Should an emergency posture be required due to a possible ECO impact, sites would coordinate their efforts under the direction of the US National Command Authority or UN as appropriate.

C⁴I for Mitigation Subsystems

Two US governmental departments would be responsible for mitigating an ECO threat: the Departments of Defense and Energy. Depending on the mitigation strategy, the NCA would direct either or both of these organizations to engage the ECO as described in the mitigation sections.

Research and Development

Research and development would fall into various realms. Specifically, the DOD and DOE would perform their own organic research but also contract out to academia and private industry for inputs. In addition, technological advances developed independent of the planetary defense initiative would be incorporated into the effort.

Exploration

Responsibility for physical exploration of space has fallen primarily into the lap of NASA and its association with academia. Manned occupation of space has been a responsibility primarily of NASA. Unmanned occupation of space has spread from NASA to the Department of Defense (and the National Reconnaissance Office) and rapidly to private industry (commercial satellites). There will be a growing trend towards the civilianization and privatization of space. But for the US unilateral defense of the planet, the federal government will continue to carry the lead for space exploration.

Exploitation

Private industry will retain its role as the primary exploiter of space. But governmental development of exploitation technologies will be critical. Moon-based manufacturing and mining for federally sponsored space occupation will fuel a growing trend of the private exploitation of space. Private industry will find uses for space resources or unoccupied expanses for its own use. These technologies will be directly applicable to the exploitation of ECOs. With the development of such technologies, ECOs will become attractive sources for minerals and other valuable resources.

Command Relationships/Connectivity

Command relationships and connectivity among units within the PDS subsystems have unique requirements to consider. The detection systems operated by USAF, academia (observatories), and NASA will all be tied into Space Command headquarters rapidly providing information on ECOs. These detection systems then cross check each other to determine the accuracy of the observation and its resulting prediction.

Detection groups share information on asteroids in a centralized database, storing asteroid orbit, composition, and proximity data. Private industry would then be able to determine which bodies to seek and potentially exploit.

For the mitigation systems, connectivity is not as complicated as for the detection systems. Commander in Chief, US Space Command, would possess the responsibility to engage ECOs under direction from the NCA. From a military planning standpoint, commander-in-chief, United States Space Command would periodically perform a deliberate planning process to establish a plan to engage a ECO. The CINC's cosmic area of responsibility possesses few threats other than ECOs, and prudence dictates establishment of an operations plan to defend against potential ECO impacts. This plan would include the mitigation options described later.

Communications

Communication among the players who study the potential threat that ECOs pose is growing. In 1996 the detection system is loosely and informally integrated through the Internet. The earth's sentries scan small

portions of the skies at a time and deposit their data on the Internet for other sentries to verify. Their techniques are rather basic and heavily dependent on computing power. An appropriate analogy here is the air defense network employed by the British during the Battle of Britain. Many observers deployed along the coast of the English Channel scanned the skies for formations of German planes and, once detecting them, identified their size and composition. These forward observers relayed their information to the centralized command centers where their information would be integrated into the big picture with radar and other observations.²⁰ So those who scan space for ECOs would benefit greatly from an improved communication network.

In 2025 the communication links among observatories will be well-meshed to cross feed and up-channel ECO data. Speed of data transfer is not a critical technology, and current capabilities are adequate to perform this function. But the integration of this information is what is lacking in 1996. Currently no person or agency officially possesses the chartered job to collect, analyze, and disseminate all ECO data. In 2025 a system to collect and analyze the data provided by the observatories will be essential. This becomes less of a technology issue than a functional, command and control issue. In 2025 that responsibility could fall on CINCUSSPACECOM.

Communications between command facilities and space vehicles may greatly benefit from technological advances. The concept describing faster-than-light communications (currently thought to be beyond current understanding of physics) is one which would benefit, though is not necessary for, mitigation systems that must physically intercept the ECO.²¹ Instantaneous communications between the earth and the space vehicle would facilitate endgame decision making—where and how to engage the ECO, for example. Not having to enlarge the space vehicle with computer hardware containing preprogrammed or automated engagement phase capabilities will allow larger payloads, faster engagement speeds, and farther engagement distances. The faster-than-light communications concept hinges on a concept of the conservation of quantum properties. If the sender alters the quantum properties of his transmitter, the receiver instantaneously is altered to compensate for the change in quantum properties.

Additionally, very high rate (gigabyte per second) communications for data relay would greatly benefit deep space control of intercept vehicles. Combined, these two concepts of high-speed and high-rate communications could have far-reaching effects.

Computers

Probably the biggest area in which great strides can be made is in the computer processing of observation data. The degree volume of space scanned is limited by scan resolution and processing capability. Faster computers coupled to more capable telescopic devices allow larger sky volumes to be searched for ECOs. Comparing new scans with archive scans at resolutions required for early detection of ECOs requires rapid database management tools and sophisticated analysis programs. In 1996 the shift from photographic to digitized techniques is almost complete. By 2025 the expansion of archive data and advances towards finer scan resolutions will make detection of ECOs far more complete and accurate.

Improved computing capabilities is also important in the astrometry realm. Astrometry currently relies upon optical and radar for the follow-up tracking that permits refinement of the orbit necessary to identify an ECO. With better orbit-calculating models that account for orbit perturbations induced by planetary gravity (e.g., by Jupiter) and with better computing power (e.g., more significant digits), orbits can be predicted more accurately and farther into the future than with current systems. The orbital chaos contributed by Jupiter's gravitational pull to the mechanical calculations can be minimized by better modeling and greater computational power. Also, in 2025 we anticipate a combination of ground- and space-based remote sensing devices for astrometric calculations. On the ground there likely would be optical (telescope) and radar devices; in the air there would likely be optical (Hubble-like) telescopes, radar, radio array, infrared, LIDAR, and LADAR sensors.

Finally, as the database of main belt asteroids grows, data management becomes critical. Keeping track of hundreds of thousands of asteroids and comets calls for improved computing power, faster processing, and larger memory. Fortunately, this power appears to be achievable in time.

As chip technology improves, memory capacity surpasses the 1 gigabyte threshold, providing an enormous capacity to store huge amounts of data. But along with these advances, the chips and their ability to perform becomes more susceptible to space radiation. Space vehicles using these advanced chips will require hardening from cosmic radiation.²²

Intelligence

Much intelligence is required regarding NEOs, but relatively little is presently known. This intelligence becomes vitally important to decide which mitigation system(s) can best be used against them and to predict the probability of mitigation success.

Specific intelligence necessary for all NEOs includes, but is not limited to, individual physical shape, size, mass, structure, surface and interior material compositions, brittleness, terrain, velocity, and inherent motion (e.g. spinning or wobbling). Specific intelligence necessary for targeted ECOs includes the aforementioned properties and particular weak points and maybe landing sites.

Several satellites have been used to perform NEO flybys, either as primary or secondary missions. Much data has been obtained; however, there is much more to be gained. The recently launched Near Earth Asteroid Rendezvous (NEAR) satellite will rendezvous with an asteroid to characterize its physical and geological properties (elemental and mineralogical composition, density, shape, spin state, interior structure, and surface morphology).²³ Other planned satellite missions include *Clementine II*; a comet rendezvous mission by ROSETTA--a European Space Agency program; Imaging of Near Earth Objects (INEO)--an NEO flyby mission by the German Center of Applied Space Technology and Microgravity; and a yet-to-be-named near-earth asteroid rendezvous mission by the Japanese Institute of Space and Astronomical Science (ISAS).

Clementine II is a congressionally directed technology demonstration satellite designed to test state-of-the-art sensors, components, and subsystems in the deep-space environment. Presently, the directed baseline mission is to fly by three near-earth asteroids (NEA) in quick succession. Several hours prior to the NEA flyby, a small (less than 20 kilograms) probe will be released from the mothership and directed to intercept the asteroid using onboard autonomous navigation techniques.²⁴

The planned ISAS satellite will map the surface and hover within one foot of an asteroid.²⁵ These and other missions are of critical importance if our mitigation systems are to be designed to work effectively. Other missions are suggested by various authors.²⁶

C⁴I Summary

Table 5 summarizes the technical hurdles that must be overcome to implement the ideas outlined in this section effectively. Overall, there are few showstoppers that prevent the implementation of a workable C⁴I planetary defense subsystem. Cost of the C⁴I subsystem is relatively low. Current systems and capabilities are nearly sufficient to perform the mission.

Table 5

C⁴I Subsystem Characteristics

System	Tech	ECO Scenario Application *	Risk Level	Problems	Maintenance
C2 for Detection Systems	Now to 2025+	1,2,3,4	Low	Large volume of sky to scan.	Low-Med
C2 for Mitigation Systems	Now to 2025+	1,2,3,4	Low	High-speed intercept of ECO	Low-Med
High-Speed, High-Memory Computers	Now to 2025+	1,2,3,4	Low	Requires precise calculation of ECO orbits	Low-Med
Communications	Now	1,2,3,4	Low	Relatively few	Low-Med
Intelligence-gathering sensors, systems	Now to 2025+	1,2,3,4	Low	Requires detailed knowledge of ECO properties	Low-Med

* ECO Scenarios 1-4 are described in Table 3.

Mitigation Subsystems

Potential mitigation subsystems are as numerous as there are science fiction novels, ranging from near-current capability to the near impossible. Mitigation subsystems typically fall into two categories--those that destroy the ECO to the point where it is no longer a hazard and those that deflect the ECO such that it would not impact the EMS. Primary factors affecting the suitability of the mitigation subsystem are the distance at which engagement with the ECO is desired, shape, size, composition, and inherent motion (e.g., spin) of the ECO. (Note: These “primary factors” will be mentioned several times in our discussion.) Popular potential mitigation subsystems addressed by current literature include, but are certainly not limited to, rocket propulsion systems; rockets with chemical, nuclear, or antimatter warheads; kinetic energy systems; high-

energy lasers; microwave energy systems; mass drivers/reaction engines; solar sails; and solar collectors as shown in figure 3-4.

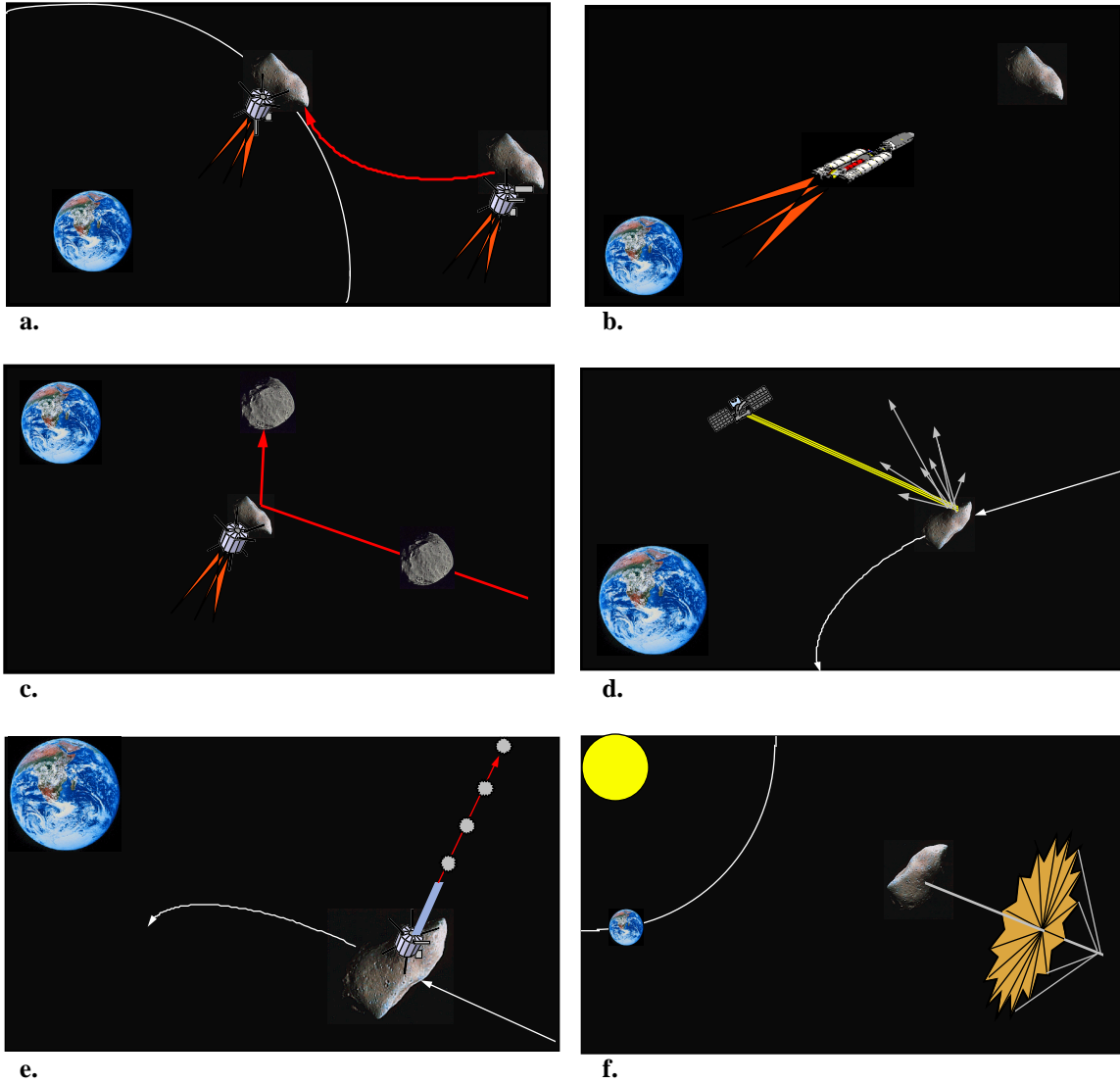

Legend: a. Rocket Propulsion; b. Rocket-Delivered Chemical/Nuclear/Antimatter Warheads; c. Kinetic Energy; d. Directed Energy; e. Mass Driver; f. Solar Sail

Figure 3-4. Potential Mitigation Subsystems

In addition, we propose several new ideas, including biological/chemical/mechanical ECO eaters, supermagnetic field generators, force shields, tractor beams and gravity manipulation (fig. 3-5).

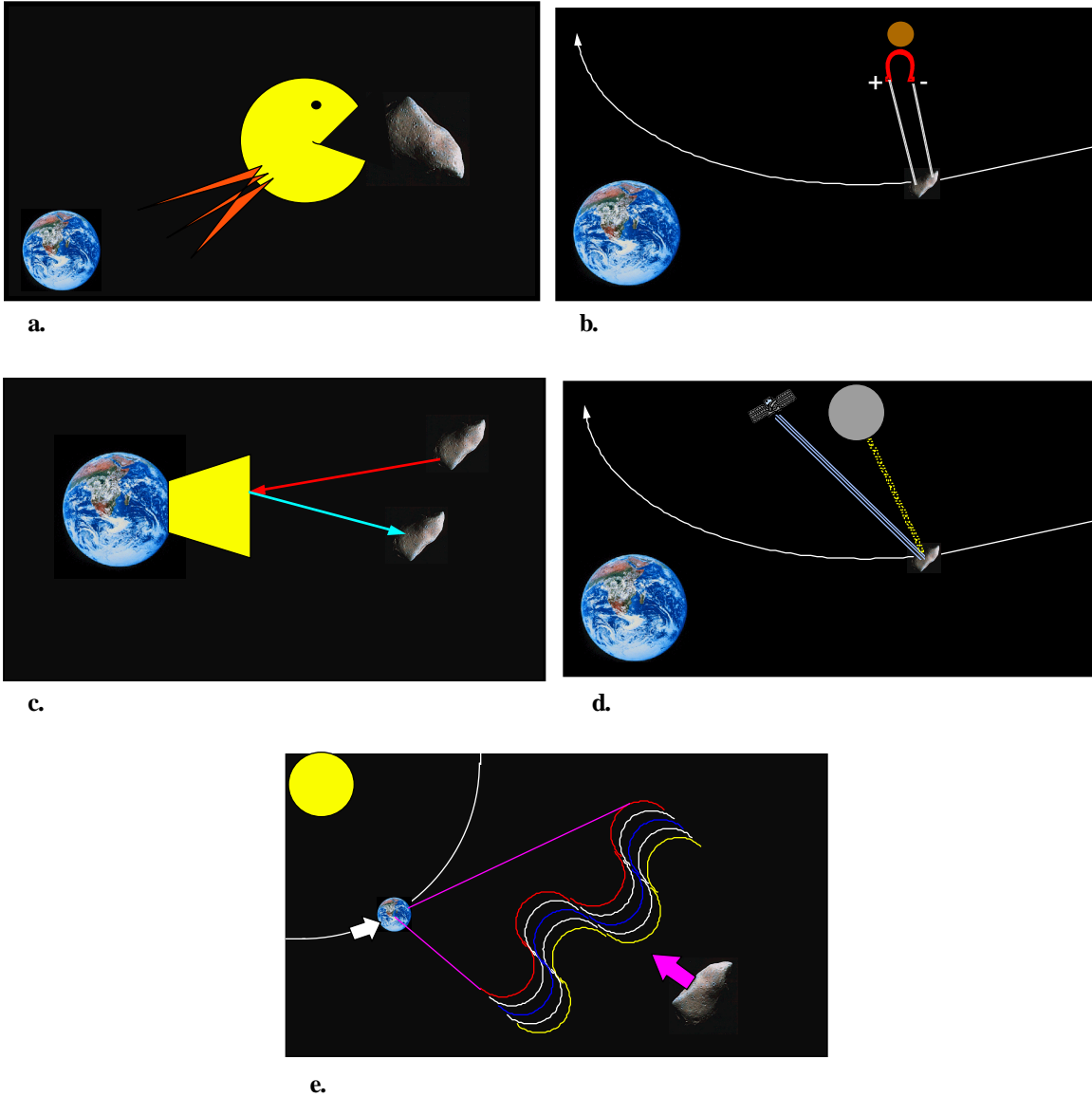

Legend: a. Biological, Chemical, Mechanical ECO Eaters; b. Supermagnetic Field Generators; c. Force Shields; d. Tractor Beams; e. Gravity Manipulation

Figure 3-5. New Potential Mitigation Subsystems

Table 6 summarizes the aforementioned mitigation systems according to technology, ECO scenario applicability, risk, potential problems, required maintenance, and cost. Evaluations are provided by the authors based on their limited knowledge of the potential systems at the present time, similar evaluations provided in various literature, and likely availability by 2025.²⁷ Costs do not reflect added cost to transfer systems into space (other than rocket-based systems) or manned operations to assemble or operate systems

in space unless otherwise noted. Maintenance requirements and estimated cost for some systems are not provided because they are too far beyond current technologies to provide this data.

Rocket propulsion systems could be employed directly to guide an ECO out of its EMS-crossing orbit. Further, many of the subsequently discussed defense systems require delivery to or near the ECO and thus would require a space lift system to get them there. A variety of propulsion systems including, but not limited to, chemical, nuclear, antimatter, laser pulse detonators, ion-electricity, spark gun, super orion, DHe₃ fusion drivers, and magnetohydrodynamics have been proposed by various authors.²⁸ These systems range from current capability to possible capability by 2025. (It is not the intent of this paper to discuss the variety of propulsion systems in detail, as they are a topic of many other studies.) The main problem with the direct method would involve attaching the rockets to the ECO. Range is a relatively simple scale-up problem for existing propulsion systems or a change to advanced propulsion systems. Intercept capability has been improved for missile systems recently primarily due to research in strategic defense initiative (SDI) and theater missile defense (TMD). Safety issues for launching larger rockets and some of the advanced propulsion systems must be considered. Development costs are estimated to range from \$5 to \$20 billion.²⁹

Table 6

ECO Mitigation Systems

System	Tech	ECO Scenario Application *	Risk Level	Problems	Maintenance	Cost in billion (dollars)
Propulsion	Now to 2025+	1, 2, 3, 4	Low-High	Safety	Low-High	5-20
Nuclear/ Chemical/ Antimatter Explosives	Now/ Now/ 2025+	1, 2, 3, 4	Medium/ Low/ High	Space Treaties, ECO Breakup/ Efficiency, Storage	Low/ Low/ High	1+ 1+ 10+
Kinetic Energy	Now	1, 2, 3, 4	High	Long lead, ECO Breakup	Low	10+
Laser	2005	1, 2, 3	Low	ABM Treaty, High power requirements	Medium	10-20
Microwaves	2015	1, 2, 3	Low	System size, power requirements	High	20+
Mass Driver/ Reaction Engine	2015	1, 2	Low	May require manned assembly	Medium	5+
Solar Sails	2025	1, 2, 3	Low	May require manned assembly	Medium	1+
Solar Collectors	2025	1, 2, 3	Low	May require manned assembly	Medium	5+
ECO Eaters	2025	1, 2	Low	Slow. Quantities required.	None	1+
Magnetic Field	2025+	1, 2, 3	Low	High-power requirements	TBD	TBD
Force Shield	2020	1, 2, 3, 4	Low	Environment-al effects	Low	TBD
Tractor Beam	2025+	1, 2, 3, 4	Low	Undeveloped technology	TBD	TBD
Gravity Manipulator	2025+	1, 2	Low	Undeveloped technology	TBD	TBD

* ECO Scenarios 1-4 are described in Table 3.

Rockets employing chemical (conventional) or nuclear warheads already exist. They fall short, however, in terms of range, megatonnage of yield, and ECO intercept capability. Many scientists believe that nuclear weapons systems are currently the only feasible method for planetary defense for most situations, and much analysis and research has gone into the subject. Depending on the primary factors, the rocket(s) would be launched to deflect the ECO that it would not impact the earth or to fracture the ECO into sufficiently small pieces. The rockets may be earth- or space-based. Actual employment of the weapon system would involve either a single or multiple proximal burst(s), surface burst(s) or subsurface burst(s). In general, in the deflection mode, proximal bursts minimize the potential danger of fragmentation of the ECO but at a penalty of greater required yield when compared to surface or subsurface bursts. Surface bursts could be used to

deflect or destroy the ECO. Subsurface bursts would be used only to fragment the ECO. Table 7 lists the required nuclear explosive yields necessary to perturb the velocity of various size asteroids by 1 centimeter per second (sufficient time if a decade is available to achieve deflection), or, in the case of subsurface bursts, to fragment the asteroid into pieces less than 10 meters in diameter, as estimated by T. J. Ahrens and A. W. Harris.³⁰

V.A. Simonenko et al. estimate a 1 MEGATON nuclear charge detonated on the surface can deflect a 300 meter 'astral assailant' if it is engaged at a distance about equal to the earth's orbital radius.³¹ Roderick Hyde et al. estimate that hundreds of gigatons of energy will be required to deflect an asteroid of 10 kilometers by about 10 meters a second at a time greater than two week's distance from earth.³²

Table 7

Nuclear Charges Required for Various Asteroid Employment Scenarios

Asteroid Size	Proximal Burst (With radiative efficiency of 0.3-0.03)	Surface (With radiative nuclear charges*)	Subsurface (Optimally buried charges)	Subsurface - soft rock (Optimally buried charges)	Subsurface-hard rock (Optimally buried charges)
0.1 km	0.1-1 kt	500 kg	800 kg	1 kt	3 kt
1 km	100 kt-1 mt	90 kt	22 kt	1 mt	3 mt
10 km	100 mt-1 gt	200 mt	0.6 gt	1 gt	3 gt

* Based on extreme extrapolation of the effect of gravity on gravity dependent cratering.

Other scientists have done similar work.³³ Table 8 provides necessary payload mass to be delivered for required nuclear yields.³⁴ Note that we have extrapolated the mass required for 1,000 megaton yield.

Table 8

Yield Versus Mass for Nuclear Explosive Devices

Yield	Mass
1 mt	0.5 ton
10 mt	3-4 ton
100 mt	20-25 ton
1000 mt (1 gt)	120-150 ton

Additional megatonnage is a relatively simple scale-up problem. Safety concerns exist. Though improbable, any accident with a nuclear weapon of the size to be used, particularly during launch, obviously

could be catastrophic. Technically, developing and deploying such a nuclear system is possible now at an estimated cost of \$1+ billion.³⁵ Use of antimatter or other warheads, such as the proposed concept of a high-explosive driven particle beam warhead, is technologically not likely to be available until beyond 2025.³⁶ Estimated costs for antimatter warhead systems exceed \$10 billion.³⁷

Kinetic energy systems would use the mass and velocity of a projectile to either shatter the ECO into smaller pieces or redirect its path. Projectiles must be of sufficient energy and size to do the job. Projectiles would be a rocket, rocket-powered object, or, as a bizarre twist, even another asteroid. The major problem associated with this system is the relatively large mass of projectile required to be propelled at the ECO. Heavy spacelift systems would be required. Figure 3-6 describes the capability of 1-, 10-, and 100-meter-diameter projectiles.³⁸ According to J. C. Solem and C. M. Snell, kinetic energy deflection is practical only for ECOs of 100 m or less in diameter for the case of terminal intercept of less than one orbital period warning; furthermore, it may be an effective method for ocean diversion of rocky asteroids smaller than 70 meters in diameter if the interceptor encounters the ECO at a distance of greater than 1/30 AU.³⁹ Ahrens and Harris agree that it is feasible to deflect 100 meter ECOs by way of direct impact.⁴⁰ Another variation of the kinetic energy solution would be to use a system of small penetrators, arranged in lattice fashion, and placed in the path of the ECO which would use the kinetic energy of the ECO against itself.⁴¹ Costs of kinetic energy systems are estimated to exceed \$10 billion.⁴² At first glance, high-energy lasers would appear to be a feasible defense system against ECOs, especially prior to 2025, at the current rate of laser development. Laser systems, however, are currently limited by extreme size, expense, and atmospheric beam divergence.⁴³ A sufficient ground-based or space-based laser would offer the shortest response times to the ECO threat.

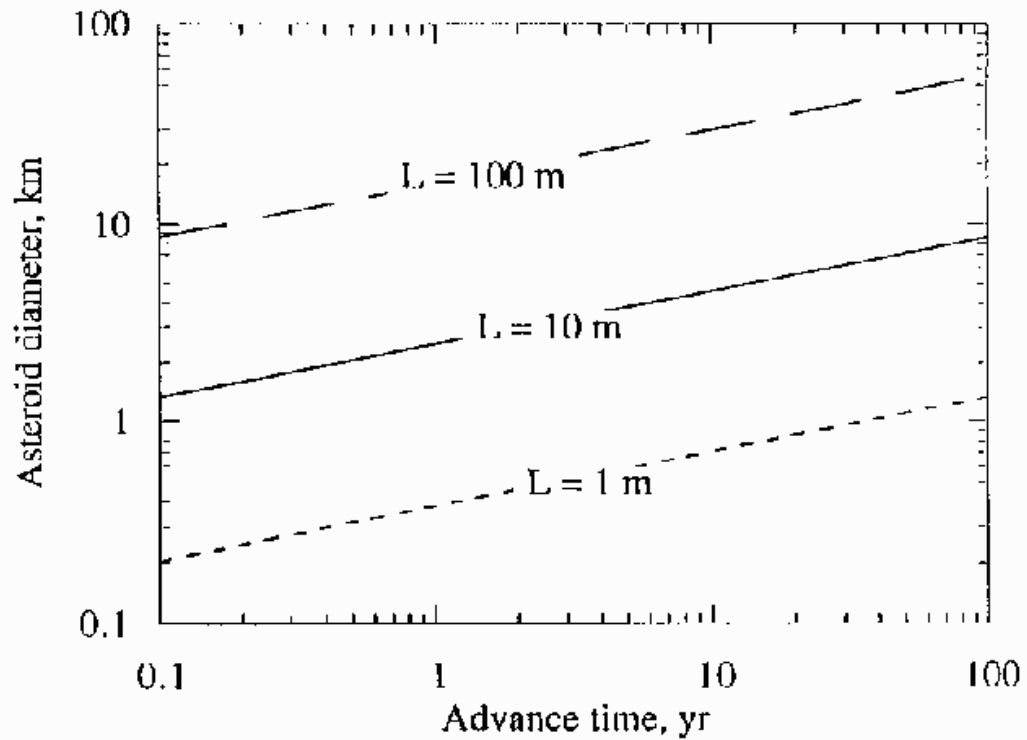

(Note: The three lines represent impacts by projectiles of 100, 10, and 1 meters in diameter and show how large an asteroid may be deflected from a collision with the earth as a function of the time elapsed between the impact on the asteroid and the predicted collision with earth)

Figure 3-6. Capability of Kinetic Energy Deflectors

A laser deflection system based near the Earth or Moon is well suited to the deflection of small bodies (100-200 meters in diameter) which are more difficult to detect at large distances from Earth.⁴⁴ Employment depends on the primary factors, especially the composition of the ECO, but regardless of composition, the laser would have to either cut the ECO into smaller pieces, heat it up until it explodes from internal pressure, melt it, or deflect it by imparting impulse energy on it. The latter option appears to be the most feasible. The required power for a system capable to accomplish such feats may be well beyond current capability, especially at the ranges at which the system must work if the system is earth-based. B. P. Shafer et al. estimate that an earth-based laser beam output necessary to match the energy of a 1 megaton nuclear blast (deflection mode) is roughly 1 gigajoule(s) for an uninterrupted period of 12 days, neglecting beam losses.⁴⁵ Such a laser would require relatively enormous optics, but innovative large optics technologies are currently being investigated, such as 20+ meter thin film mirrors and other techniques. New technology phase conjugation correctors, shorter wavelengths, more accurate pointing and tracking techniques will also

increase the feasibility of such systems.⁴⁶ Longer radiation times or a more powerful laser would be required to account for beam losses. Space-based systems may reduce required optics size and beam losses and thus the power required, but these advantages may be offset by the cost associated with delivering and maintaining such systems in space. Development costs for an earth- or space-based system are estimated to range from \$10 to \$20 billion.⁴⁷

Microwave energy systems are similar to lasers in that they are also directed energy systems. Phased array antennas would be used to focus microwave beams which would then deflect the ECO by, depending on the composition of the ECO, heating the surface or subsurface, resulting in reaction to the resultant expanding vapor plumes. Narrow band systems have a long way to go to achieve power required, but introduction of new materials is expected to improve high-voltage performance, cathode emission, and pulse lengths.⁴⁸ Ultra-wide band (UWB) class systems with greater power capability are current technology, but the energy flux delivered is not concentrated enough. A UWB source capable of delivering 25 gigawatts (gW) of peak power has been demonstrated, a 100 gW pulser will be demonstrated within the year, and a terawatt machine is on the drawing board.⁴⁹ The likely limiting factor of these systems is the massive antenna arrays that would be required. To focus microwaves on a spot 100 meters in radius at a distance of only .003 AU requires a phased array 160 kilometers in diameter. The total radiated power would require 10 gW for energy fluxes on the asteroid to reach 10^6 Wm^{-2} , which would lead to sufficient deflection.⁵⁰ To deflect ECOs greater than 100-200 meters in diameter, the system would likely have to be space-based. Estimated development costs exceed \$20 billion.⁵¹

A mass driver and reaction engine requires interfacing with the ECO in such a manner that it can be anchored to the surface. Reaction mass must be removed from the ECO then propelled into space in the required direction, resulting in a propulsive effect in the opposite direction. Since the thrust to be developed is proportional to the mass removal rate and the ejection velocity, a power plant able to provide sufficient energy (estimated at 300m/s) is required; a nuclear plant or a solar energy plant would suffice.⁵² Figure 3-7 depicts the capability of a mass driver using a solar energy plant operating at a realistic 10 percent efficiency with solar collectors of 1 and 10 kilometers in diameter at a distance of 1 AU from the ECO.⁵³ This system is favorable for ECOs at greater distances, which allow for greater time to influence. The mass driver

system itself is within current technology. The long pole in this system appears to be the ability to rendezvous with the ECO, attaching the mass driver and ejecting the mass in the desired direction. This would be especially difficult if the ECO has an unstable surface or any inherent motion such as a spin. Manned installation and operation may be required. Estimated development costs exceed \$5 billion.⁵⁴

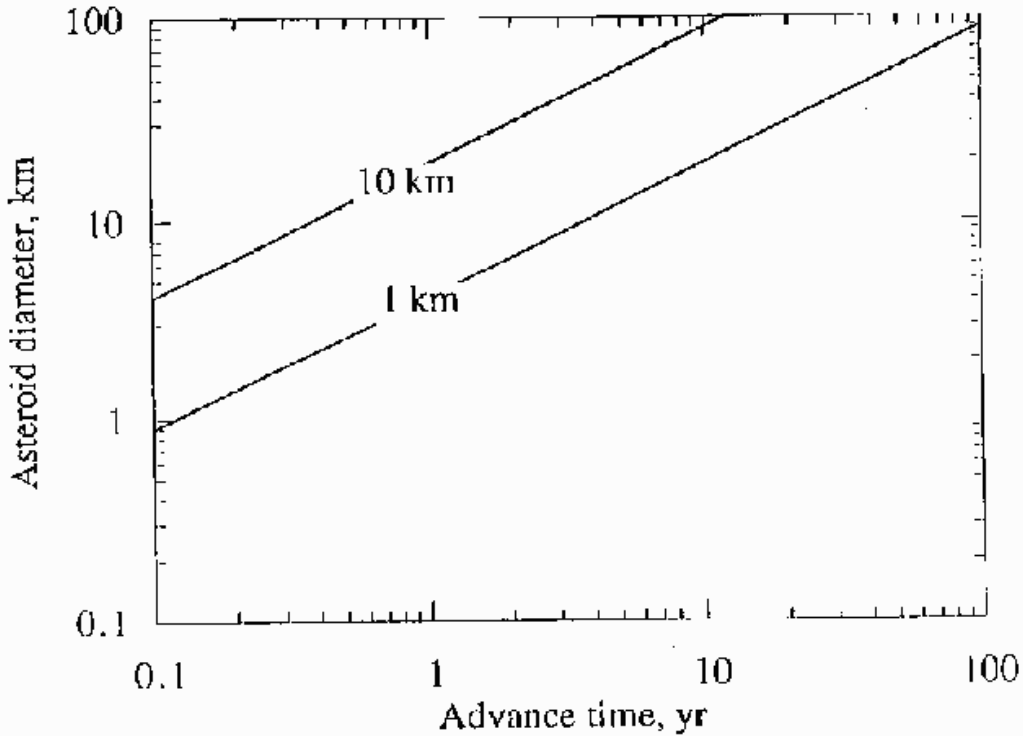

(Note: The mass driver is categorized by the diameter of a solar collector (at 1 AU) needed to supply operating power at 10 percent overall efficiency. The lines for 1 and 10 km diameter circular collectors show that modest-size systems may be capable of diverting asteroids in the 1 to 10 kilometer range.)

Figure 3-7. Capability of Mass Drivers

Solar sails would be employed in a manner similar to a sail on a sailboat or a paraglider using solar radiation as “wind.” The required sail sizes are enormous even to deflect relatively small ECOs (fig. 3-8).⁵⁵ Further, solar sails would have to be attached to the ECO, and manned assembly likely would be required. Though this system probably has the lowest risk and would be the most environmentally friendly, the space construction effort is likely beyond our capability for at least several decades or more. The estimated cost for developing solar sails is \$1-2 billion.⁵⁶

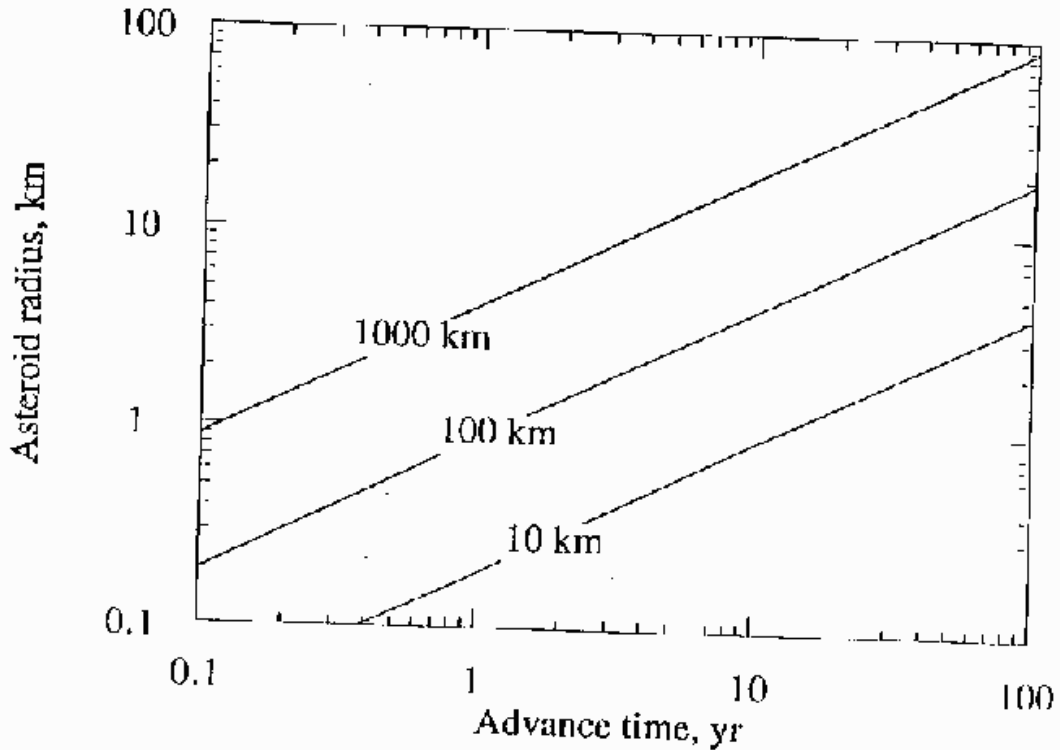

(Note: The three lines are for different solar sail diameters. Even small asteroids require enormous solar sails (10 - 1,000 km in diameter) which, along with the technical difficulty of tethering them to the asteroid, makes such a deflection system look very unfavorable.)

Figure 3-8. Capability of Solar Sails

Solar collectors would use solar sails as a solar energy collector, focus light onto the surface of the ECO with a secondary mirror, and generate thrust on the ECO from the vaporization of the ECO. It is estimated that a solar collector of 1 kilometer in diameter could deflect ECOs up to 3.4 km if continuously operated for a year.⁵⁷ Figure 3-9 summarizes the capabilities of solar collectors.⁵⁸ Solar collectors suffer from similar problems as the solar sail system, though also require additional hardware. Manned assembly and operation also would likely be required. Costs for development of the system are estimated to exceed \$5 billion.⁵⁹

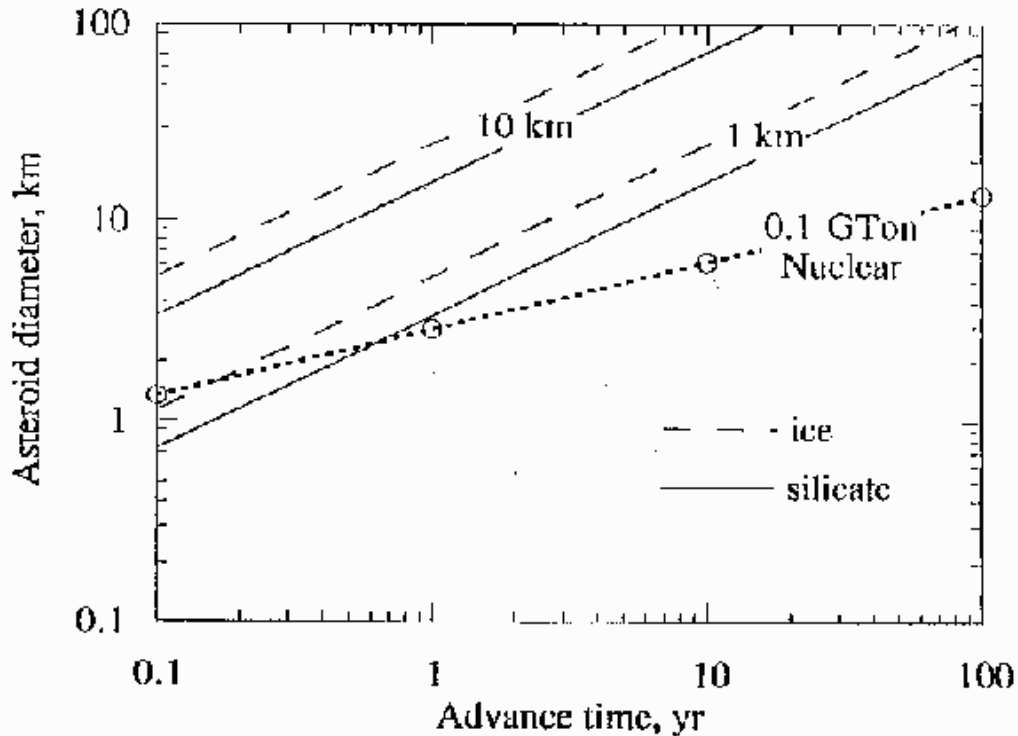

(Note: This plot shows the diameter of the asteroid (or comet) that can be deflected as a function of the time before impact. The pairs of solid and dashed lines are for silicate and icy bodies, respectively, that can be deflected by either 1 km or 10 km diameter solar collectors. The heavy dotted curve with representative points is for the nuclear stand-off scenario employing a 0.1 gt neutron bomb with an [optimistic] assumed conversion of 0.3 into neutron energy.)

Figure 3-9. Asteroid deflection capabilities of solar collectors versus nuclear weapons.

Biological/chemical/mechanical ECO eaters, as the name suggests, would “eat” ECOs.⁶⁰ Since this would likely be a slow process, all primary factors must be considered, but the composition of the ECO is most important, as these systems would only work on particular compositions. Biological/chemical/mechanical eaters would have to digest or react with the ECO material in such a manner to produce primarily a gas which would result in a net loss of mass of the ECO, or to fracture the ECO into smaller pieces, or to make the ECO more susceptible to destruction by the earth’s atmosphere. The mechanical eater would have to fracture the ECO or to make the ECO more susceptible to destruction by the earth’s atmosphere. These types of systems may have more success on comets, which are known to contain large amounts of ice. Stony/metallic asteroids would be more difficult to attack but not impossible. The biological and chemical agents are not envisioned to be exotic, and some related research has been done for other purposes. A related, though more unlikely proposed concept, is a chemical morphing system, which

would change the physical characteristics of material.⁶¹ These systems would have to be deposited on the surface of an ECO in sufficient quantities to have an effect on them. This would probably require heavy spacelift system with the chemical/biological agent as the payload/warhead. The mechanical systems may have to be more complex. Self-replicating mechanical systems have been envisioned.⁶² There may be safety issues associated with accidental release of potentially toxic or otherwise dangerous biological/chemical eaters. Cost estimates are unavailable.

Supermagnetic field generators could be effective against iron containing ECOs, though ineffective against comets. In its simplest terms, this system would be a magnet in space activated to attract or repel an ECO out of its orbit. The system could be based on the moon, or it could be a stand-alone satellite system or even deployed on a “captured” asteroid. Potential electromagnetic interference with earth-based electrical systems or satellites systems and environmental damage on the earth may further reduce the utility of such a system close to earth. The required power and likely bulk of such a system make it unrealistic at the present time. Heavy space lift may be required. No research was discovered regarding such a system. The idea is presented for further investigation. Estimated costs are unavailable.

Star Trekian force shields are a figment of our imagination, but if perfected they would be the ideal system against ECOs. We currently have a pseudo force shield for the earth—our atmosphere—effective enough to repel or destroy ECOs up to about 50 m (stony asteroids) and 100 meters (comets) in diameter.⁶³ We are concerned with ECOs of larger size. Perhaps temporarily augmenting our atmosphere by changing its characteristics or extending it out further would enable us to mitigate larger ECOs. (Once again the concept of chemical morphing may apply.) Ionizing a path in the atmosphere to an asteroid may induce destructive lightning strikes, though the effects are debatable. If we can cause holes in the ozone, we ought to be able to do similar things in reverse. Potential effects on the earth’s environment would be of great concern. No dedicated research was discovered for such a system. The ideas are presented for further investigation. Development costs are unknown.

A tractor beam is a system common in science fiction stories, but an equivalent system may not have to be limited to fiction. The similar system would create a vacuum greater than that of space or implosion rather than explosion to move the ECO out of its orbit. No research was discovered regarding such a system.

In general, it is beyond the present understanding of physics. The idea is presented for further investigation. Estimated costs are unavailable.

Similar to a tractor beam is a gravity manipulator. If we can manipulate, or somehow take advantage of the gravity of the Earth, the Moon, or other celestial bodies such as black holes (with enormous gravitational fields), we can perhaps affect the orbit of an ECO.⁶⁴ A captured asteroid of sufficient mass could be steered to a position where its gravitational pull could be used against ECOs. No research was discovered regarding such a system. In general, it is beyond the present understanding of physics. The idea is presented for further investigation. Estimated costs are unavailable.

Concept of Operations—A Three-Tier System

To defend the EMS from ECOs, our concept of operations proposes a three-tier PDS to be deployed by 2025. The far tier would be forward deployed in or above the asteroid belt, the midtier deployed somewhere between the asteroid belt and the EMS, and the near tier deployed within the EMS (Earth, Moon, or space-based). Each tier would have overlapping ranges and capabilities. Such a system would allow us to mitigate all four ECO scenarios. Further, with such a system, we would have maximum warning times, the ability to intervene at the earliest possible times, and, in some cases, the ability to reengage the ECO should the far and/or mid tier(s) fail. Finally, such a system would take advantage of the best available subsystems for each tier. Table 9 summarizes our proposed three-tier PDS based on expected development of technologies at the times of expected deployment. Figure 3-10 provides a notional picture of the three-tier proposal. As time goes on and technologies expand, new systems undoubtedly will be more effective and less costly and may replace the recommended systems. Figure 3-11 is a proposed research, development, and deployment timeline for a three-tier PDS.

Table 9

Three-Tier PDS

Tier	Deployment Zone	Detection Subsystem(s)	C ⁴ I Subsystem(s)	Mitigation Subsystem(s)
Near	Within EMS	EMS-based optics, radar, and infrared	Primarily conventional Earth-based	EMS-based rockets with nuclear warheads
Mid	Between EMS & Jupiter Asteroid Belt	Space-based optics, radar, radio array, infrared & LADAR	Conventional Earth and space-based	Space-based kinetic energy systems
Far	Within or around the Main Asteroid Belt between Mars and Jupiter	Space-based miniature remote sensing satellite constellations	Conventional Earth and space-based & forward-deployed comm. relay satellites	Space-based laser systems

Each tier would be developed sequentially from near to far, with the detection systems developed and deployed first, in parallel with and followed by C⁴I systems and in parallel with and followed by mitigation systems.

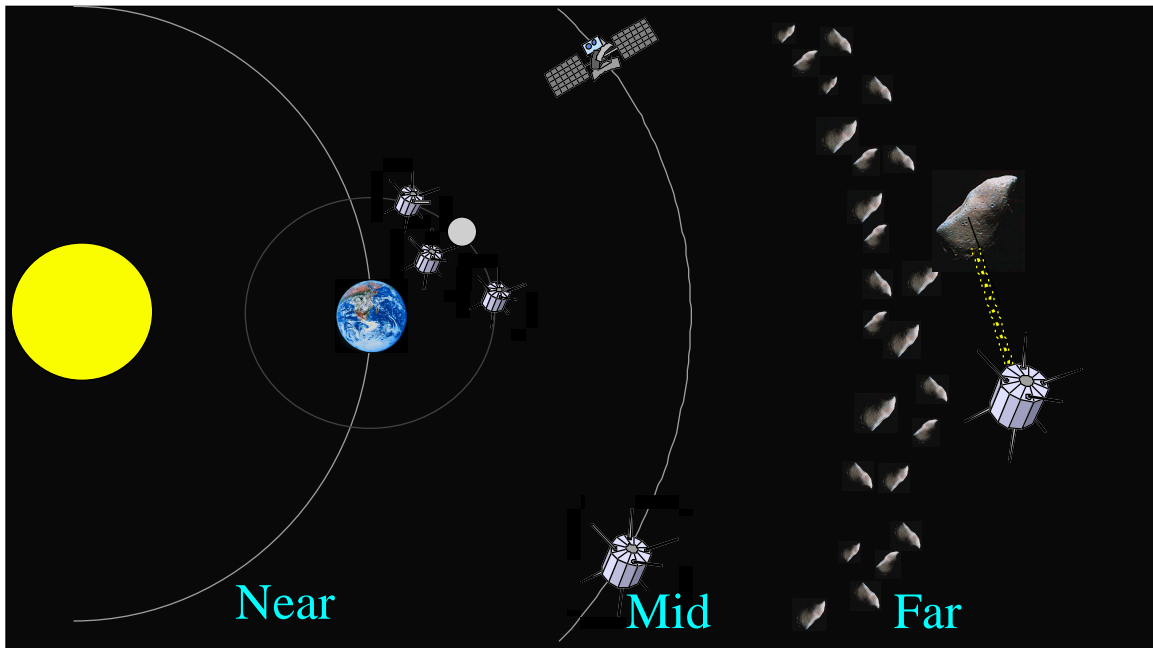

Figure 3-10. Proposed Three-Tier PDS

Such a timeline allows us to detect potential ECOs and verify the need for mitigation systems prior to their deployment. Further, such a system would allow us to be protected from all ECO scenarios at the earliest possible time with the near tier, while allowing the technological advances and cost reductions to allow us to deploy the more challenging mid and far tiers in the future.

- ⁹ The NASA Ames Space Science Division, *The Spaceguard Survey: Hazard of Cosmic Impacts* (Moffett Field, Calif.: San Juan Capistrano Research Institute, 1996), 93.
- ¹⁰ Edward Bowell and Karri Muinonen, "Earth-Crossing Asteroids and Comets: Groundbased Search Strategies," in *Hazards Due to Comets and Asteroids*, ed. Tom Gehrels (Tucson, Ariz.: University of Arizona Press, 1994), 185.
- ¹¹ The NASA Ames Space Science Division, 8.1.
- ¹² *Ibid.*, 5.1.
- ¹³ *Ibid.*, 5.3.
- ¹⁴ Lewis, *Rain of Iron and Ice*, 212.
- ¹⁵ J. H. Darrah, "Near Earth Object Search with Ground Based Electro-Optical Space Surveillance System (GEODSS)," A Presentation Prepared for *Plenary Session I: Threat Workshop* (Livermore, Calif.: Lawrence Livermore National Laboratory, 22 May 1995).
- ¹⁶ *Proceedings of the Near-Earth-Object Interception Workshop*, eds. G. H. Canavan, J. C. Solem, and J. D. G. Rather (Los Alamos, N. Mex.: Los Alamos National Laboratory, 1992), 18.
- ¹⁷ **2025** Concept, No. 900412, "Change Detection," **2025** Concepts Database (Maxwell AFB, Ala.: Air War College/**2025**, 1996).
- ¹⁸ USAF Scientific Advisory Board, *New World Vistas: Air and Space Power for the 21st Century*, summary volume (Washington, D.C.: USAF Scientific Advisory Board, 15 December 1995), 20.
- ¹⁹ *Proceedings of the Near-Earth-Object Interception Workshop*, 238.
- ²⁰ *Air Superiority*, B. F. Cooling, ed. (Washington, D.C.: Center for Air Force History, 1994), 115–78.
- ²¹ **2025** Concept, No. 200013, "Quantum Effect Communications," **2025** Concepts Database (Maxwell AFB, Ala.: Air War College/**2025**, 1996).
- ²² *Ibid.*
- ²³ A. F. Cheng *et al.*, "Missions to Near Earth Objects," in *Hazards Due to Comets and Asteroids*, ed. Tom Gehrels (Tucson, Ariz.: University of Arizona Press, 1994), 651–69.
- ²⁴ Anonymous, *Clementine II* WWW Page, n.p.; on-line, Internet, 30 May 1996, available from <http://trex.atsc.allied.com>.
- ²⁵ A.F. Cheng *et al.*, 668.
- ²⁶ A.F. Cheng *et al.*; S. Nozette *et al.*, "DoD Technologies and Missions of Relevance to Asteroid and Comet Exploration" and T. D. Jones *et al.*, "Human Exploration of Near Earth Asteroids" from *Hazards Due to Comets and Asteroids*, ed. Tom Gehrels (Tucson, Ariz.: University of Arizona Press, 1994), 651–710.
- ²⁷ *Proceedings of the Near-Earth-Object Interception Workshop*, 234; H. J. Melosh, I.V. Nemchinov and Yu. I. Zetzer, "Non-Nuclear Asteroid Diversion," in *Hazards Due to Comets and Asteroids*, ed. Tom Gehrels (Tucson, Ariz.: University of Arizona Press, 1994), 1111–31.
- ²⁸ LCDR Mark J. Hellstern *et al.*, "Spacelift - Integration of Aerospace Core Competencies," A **2025** White Paper (Maxwell AFB, Ala.: Air War College, 1996), 17–36; *Proceedings of the Near-Earth-Object Interception Workshop*, 229-232.
- ²⁹ *Proceedings of the Near-Earth-Object Interception Workshop*, 234.
- ³⁰ T. J. Ahrens and Alan W. Harris, "Deflection and Fragmentation of Near Earth Asteroids," in *Hazards Due to Comets and Asteroids*, ed. Tom Gehrels (Tucson, Ariz.: University of Arizona Press, 1994), 922–23.
- ³¹ V.A. Simonenko *et al.*, "Defending the Earth Against Impacts from Large Comets and Asteroids," in *Hazards Due to Comets and Asteroids*, ed. Tom Gehrels (Tucson, Ariz.: University of Arizona Press, 1994), 949.
- ³² Roderick Hyde *et al.*, "Cosmic Bombardment III: Ways and Means of Effectively Intercepting the Bomblets," A Presentation Prepared for the NASA NEO Workshop, 14 January 1992.
- ³³ Lowell L. Wood *et al.*, "Cosmic Bombardment IV: Averting Catastrophe In the Here-And-Now," A Presentation to Problems of Earth Protection Against the Impact With NEOs, 26-30 September 1994; B.P.

Shafer et al., “The Coupling of Energy to Asteroids and Comets,” in *Hazards Due to Comets and Asteroids*, ed. Tom Gehrels (Tucson, Ariz.: University of Arizona Press, 1994), 955–1012; and Johndale C. Solem and Charles M. Snell, “Terminal Intercept for Less Than One Orbital Period Warning,” in *Hazards Due to Comets and Asteroids*, ed. Tom Gehrels (Tucson, Ariz.: University of Arizona Press, 1994), 1013–33.

³⁴ L. R. Sikes and D. M. Davis, “The Yields of Soviet Strategic Weapons,” *Scientific American* (1987): 29–37.

³⁵ *Proceedings of the Near-Earth-Object Interception Workshop*, 234. The figure reflected in the reference is actually \$0, however, we felt modifications to existing systems would be necessary at a cost of at least \$1B.

³⁶ Director, Test and Evaluation and Technology Requirements and US Naval War College, “High Energy Particle Beam (HEPB) Warhead,” *Technologies Initiatives Game 95 (Systems Handbook)*, 59–61.

³⁷ *Proceedings of the Near-Earth-Object Interception Workshop*, 234.

³⁸ Melosh, Nemchinov and Zetzer, 1116.

³⁹ Solem and Snell, 1030–32.

⁴⁰ Ahrens and Harris, 904.

⁴¹ Hyde et al.

⁴² *Proceedings of the Near-Earth-Object Interception Workshop*, 235.

⁴³ *New World Vistas*, (unpublished draft, the space applications volume), 113.

⁴⁴ Melosh, Nemchinov and Zetzer, 1130.

⁴⁵ Shafer et al., 965.

⁴⁶ *New World Vistas*, (unpublished draft, the space applications volume), 81.

⁴⁷ *Proceedings of the Near-Earth-Object Interception Workshop*, 234–35; *New World Vistas*, (unpublished draft, the directed energy volume), 24. USAF Scientific Advisory Board estimates laser energy costs at \$1-\$2 per joule up to the megajoule range.

⁴⁸ *New World Vistas*, (unpublished draft, the directed energy volume), 59.

⁴⁹ Ibid.

⁵⁰ Melosh, Nemchinov and Zetzer, 1129–30.

⁵¹ *Proceedings of the Near-Earth-Object Interception Workshop*, 234. The directed energy cost was doubled to account for the large phased array required.

⁵² Melosh, Nemchinov and Zetzer, 1117–18.

⁵³ Ibid., 1119.

⁵⁴ *Proceedings of the Near-Earth-Object Interception Workshop*, 234.

⁵⁵ Melosh, Nemchinov and Zetzer, 1120.

⁵⁶ *Proceedings of the Near-Earth-Object Interception Workshop*, 234.

⁵⁷ Melosh, Nemchinov and Zetzer, 1125.

⁵⁸ Ibid., 1126.

⁵⁹ *Proceedings of the Near-Earth-Object Interception Workshop*, 234. This figure was obtained by averaging the cost of solar sails and the cost for directed energy systems.

⁶⁰ Director, Test and Evaluation and Technology Requirements and U.S. Naval War College. “Anti-Material Biological Agents,” *Technologies Initiatives Game 95 (Systems Handbook)*, 148–51.

⁶¹ **2025** Concept, No. 900393, “Chemical Morphing Weapon,” **2025** Concepts Database (Maxwell AFB, Ala.: Air War College/**2025**, 1996).

⁶² Preparing for Planetary Defense, Spacecast 2020 White Paper, R-29.

⁶³ D. Morrison, C. R. Chapman, and Paul Slovic, “The Impact Hazard,” in *Hazards Due to Comets and Asteroids*, ed. by Tom Gehrels (Tucson, Ariz.: University of Arizona Press, 1994), 64.

⁶⁴ **2025** Concept, No. 900394, “Gravity Manipulation,” **2025** Concepts Database (Maxwell AFB, Ala.: Air War College/**2025**, 1996).

Chapter 4

Dual-Use Benefits

A PDS system has many potential dual-use capabilities, with or without modification, such as earth and space surveillance, space debris detection and mitigation, ballistic missile defense, and as a space-based offensive weapons system. The overall system is, however, only one of many benefits of a decision to embark on a PDS research, development, and deployment effort.

The technologies required for the PDS would be, in of themselves, major benefits of such a program. Indeed, revolutionary deep-space detection methods, quantum communications, ultra-fast computer processing, large data-storage capabilities, high specific impulse propulsion, high kinetic energy systems, high power-directed energy systems, mass driver/reaction engines, solar sail and collector systems, chemical, biological, and mechanical “eaters,” magnetic and force field generation, tractor beams and gravity manipulators, and the ability to manhandle large objects in space and move them into more desirable orbits present significant technical challenges. Once developed, however, these new technologies will, in effect, change our lives, as military and commercial spin-offs and dual-use capabilities from these new technologies will dramatically stimulate the global economy. As deep-space detection allows us to reflect, we may find answers to energy shortages and sources of dwindling critical resources.

It is conceivable that not only would the PDS serve as a defensive system for EMS protection, it also could be used to maneuver selected asteroids into stable earth orbits for various operations. A particularly interesting benefit involves mining asteroids for their rich deposits of metals and other valuable minerals. A thought brings into focus a space mining company making frequent trips into space to mine the asteroid that presented the original global threat. Further, controlled asteroids could be used as space bases or platforms

for space stations or space colonies. Indeed, such possibilities would enhance the attractiveness of the PDS effort due to their economic potential.

Chapter 5

Recommendations

As we bring our discussion to a close, we issue the recommendations that follow. We also advance the caveat that simply because meteorologists include no data regarding planetary defense in their evening forecast is no reason to disregard or minimize such a significant issue.

Benefits

The Planetary Defense System (PDS) will provide a functional defensive capability against threat objects from space by 2025—a capability that may prevent catastrophic destruction and loss of life and even save the human race from extinction. Obviously, there is no guarantee that an asteroid or comet will pose a threat before, during, or even after this time frame, but, in any case, the global community will be prepared once the PDS is developed and deployed. The previous chapter also listed numerous dual-use benefits for the PDS.

Issues

Although promising signs exist in terms of more frequent workshops, technical discussions, and increased international cooperation, we must address several issues to resolve the planetary defense problem by 2025. First and foremost, does the global community believe that an unacceptable risk to the EMS exists, and, if so, is it committed to developing a solution? Obviously, the concepts presented in this paper require many new technologies that will take much time, talent, and resources to develop. Commitment does not

equate to paper studies alone—it must be supported by substantial research and funding for these studies to be followed up with action. In an era of declining budgets, this issue presents a significant dilemma for leaders across the world. It should be remembered, however, that the threat of nuclear war was uncertain and even improbable during the cold war period; yet, the US spent more than \$3 trillion over this 50-year time frame to maintain its strength against this uncertainty. These authors suggest that one needs only to consider the potential catastrophic effects from a large (>1 km diameter) ECO impact to conclude that humanity has a moral obligation to protect humanity.

Second, once a PDS becomes functional, especially if nuclear weapons are used, who controls it? Is it the United States, the United Nations or, perhaps, a consortium of world leaders that contributed to its development? These authors contend that the UN should be the controlling authority for the PDS. We acknowledge that such countries as the US, Russia, China, and possibly members of the European Union should carry greater weight and provide primary leadership for an effort of this magnitude. To gain the support of other nations, however, it will likely be necessary to use the UN as the controlling authority.

Third, some alternate future worlds developed during the *2025* study present a bleak outlook for enhanced technical development and resourcing during the next 30 years. Although these worlds are not predictive in nature, they do highlight that, if global conditions do not favor large monetary expenditures and committed focus on technical development, including the US itself, needs and ideas will never result in the required technologies to support a PDS.

Investigative Recommendations

The planetary defense problem is real and deserves serious attention. In this regard, we provide the following recommendations.

1. It is imperative that the global community unite to discuss, debate, and agree upon a plan to deal with the planetary defense problem. The participation by an increasing number of countries during technical workshops is highly encouraging. However, it must be noted that this is only an initial step in a long-term process. It is recommended that these workshops continue at all costs, since they require commitment and support by all nations.

2. Recommend that a team of engineers and scientists from the US, Russia, China and the European Union brief Congress on the results of the planetary defense studies, emphasizing the ECO threat, by Spring 1997. Additionally, to garner support from other countries, recommend that this team, led by the deputy undersecretary of defense for space and the deputy director of space policy, present the planetary defense topic at a future combined session of the United Nations, preferably within the same timeframe. Hopefully, such an effort will lead to a cooperative spirit among these nations.

3. Working closely with other nations, recommend that the US take the lead in developing and executing a program to educate the public about the ECO threat problem. This program is not intended to create anxiety or panic; rather, it seeks to reduce them through increased awareness. As discussed earlier, television documentaries and such computer links as the Internet will serve as the best educational media. Properly developed and presented, these tools would also serve as means of increasing support for further research, resourcing, and, ultimately, the development of a PDS.

4. We recommend the formal establishment of a global PDS consortium, perhaps at the next ECO workshop or during the proposed UN session, to commit required research and development funds for initial studies and PDS strategy development that will be required for the ultimate production of a three-tier PDS for EMS defense against ECOs. As a sign of good faith, we also recommend that the US immediately restore the \$20 million to support *Clementine II* and sign-on as a primary stockholder for planetary defense.

5. Recommend that a phased acquisition strategy be adopted and implemented, leading to the ultimate development and deployment of a complete three-tier (consisting of detection, C⁴I and mitigation subsystems at each tier) PDS by 2025. For the near term, recommend that most of the available resources be used to upgrade detection capabilities worldwide, enabling scientists to more efficiently detect, and classify unknown ECOs.

Historically, humankind has used ingenuity and cunning to develop solutions to life-threatening challenges. Some of these threats have been immediate; others possible but not probable; and still others extremely remote. But, although planetary defense falls into the latter category, one must consider the extreme consequences that would likely result from an ECO impact. The issue is not *if*, but *when* an asteroid or comet will suddenly be detected as an EMS threat, causing global chaos and panic and ultimately placing all of humanity at risk. Obviously, our forefathers thought highly enough about our species to invest in

capabilities to ensure its survival. The obvious question, then, is: Do today's leaders possess the same conviction towards preserving the human race, and, are they willing to invest in the PDS as a "catastrophic health insurance policy" for planet Earth?

Bibliography

- “Agreement Governing the Activities of the States on the Moon and Other Celestial Bodies” 1979. On-line, Internet 1979, available from: gopher://gopher.law.cornell.edu:70/00/foreign/fletcher/BH766.txt.
- Ahrens, T. J. and Harris A. W. “Deflection and Fragmentation of Near Earth Asteroids,” in Tom Gehrels, ed., *Hazards Due to Comets and Asteroids*. Tucson, Ariz.: University of Arizona Press, 1994.
- Brown, Sen George E. Jr. *The Threat of Large Earth-Orbit Crossing Asteroids: Hearings before the House Sub-Committee on Science, Space, and Technology*. 103d Congress, 1st sess., 1993.
- Bowell, Edward and Karri Muinonen. “Earth Crossing Asteroids and Comets: Ground-based Search Strategies,” in Tom Gehrels, ed., *Hazards Due to Comets and Asteroids*. Tucson, Ariz.: University of Arizona Press, 1994.
- Canavan, Gregory H. “The Cost and Benefit of Near-Earth Object Detection and Interception,” in Tom Gehrels, ed., *Hazards Due to Comets and Asteroids*. Tucson, Ariz.: University of Arizona Press, 1994.
- Carusi, A. et al. “Near Earth Objects: Present Search Programs,” in Tom Gehrels, ed., *Hazards Due to Comets and Asteroids*. Tucson, Ariz.: University of Arizona Press, 1994.
- Chapman, Clark R. and David Morrison. “Impacts on the Earth by asteroids and comets: Assessing the hazard.” *Nature*. 6 January 1994, 33–40.
- Clube, Victor and Bill Napier. *Cosmic Winter*. Basil Blackwell, 1993.
- Cooling, B. F., ed. *Air Superiority*. Washington, D. C.: Center for Air Force History, 1994.
- “C/1996 B2 (Hyakutake),” n.p.: on-line, Internet, 30 May 1996, available from http://medicine.wustl.edu/%7Ekronkg/1996_B2.html.
- Darrah, J. “Near Earth Object Search with Ground-Based Electro-Optical Surveillance System (GEODSS).” A Presentation Prepared for *Plenary Session I: Threat Workshop*, 22 May 1995.
- Director, Test and Evaluation and Technology Requirements and U.S. Naval War College. “High Energy Particle Beam (HEPB) Warhead.” *Technologies Initiatives Game 95 (Systems Handbook)*, 18–22 September 1995.
- Director, Test and Evaluation and Technology Requirements and U.S. Naval War College. “Anti-Material Biological Agents.” *Technologies Initiatives Game 95 (Systems Handbook)*. 18–22 September 1995.
- Gehrels, Tom. “Collisions with Comets and Asteroids.” *Scientific American*. March 1996, 57-59.
- Gehrels, Tom. “Spacewatch.” A Presentation Prepared for Plenary Session I: Threat Workshop. 22 May 1995.
- Gehrels, Tom, ed. *Hazards Due to Comets and Asteroids*. Tucson, Ariz.: University of Arizona Press, 1994.
- Harris, Alan et al. *The Deflection Dilemma: Use vs. Misuse of Technologies for Avoiding Interplanetary Hazards*. Ithaca, N.Y.: Cornell University Center for Radiophysics and Space Research, 3 Feb 94.
- Hartmann, W. K. and A. Sokolov. “Evaluating Space Resources,” in Tom Gehrels, ed., *Hazards Due to Comets and Asteroids*. Tucson, Ariz.: University of Arizona Press, 1994.
- Hecht, Jeff. “Asteroid ‘airburst’ may have devastated New Zealand.” *New Scientist*. 5 October 1991, 19.

- Hellstern, LCDR Mark J. et al. "Spacelift - Integration of Aerospace Core Competencies." A **2025** White Paper. Maxwell AFB, Ala.: Air War College, 1996.
- Hyde, Roderick et al. "Cosmic Bombardment III: Ways and Means of Effectively Intercepting the Bomblets." A Presentation Prepared for the NASA International NEO Workshop, 14 Jan 1992.
- "ISO, unique explorer of the invisible cool universe," *ESA Presse*, no. 21-95, 07 October 1995. On-line, Internet, available from <http://isowww.estec.esa.nl/activities/info/info2195e.html>.
- Kobres, Bob. "Meteor Defense." *Whole Earth Review*. Fall 1987, 70-73.
- Lewis, John S. *Rain of Iron and Ice*. Reading, Mass.: Addison-Wesley, 1996.
- Johnson, L. et al. "Preparing for Planetary Defense." A **Spacecast 2020** White Paper. Maxwell AFB, Ala.: Air War College, 1995.
- Melosh, H. J., I. V. Nemchinov and Yu. I. Zetzer, "Non-Nuclear Asteroid Diversion," in Tom Gehrels, ed., *Hazards Due to Comets and Asteroids*. Tucson, Ariz.: University of Arizona Press, 1994.
- "Meteorite House Call." *Sky & Telescope*. August 1993, 13.
- Morrison, David et al. "The Impact Hazard," in Tom Gehrels, ed., *Hazards Due to Comets and Asteroids*. Tucson, Ariz.: University of Arizona Press, 1994.
- Nadis, Steve. "Asteroid Hazards Stir Up Defense Debate." *Nature* 375. 18 May 1995, 174.
- NASA Ames Space Science Division. *The Spaceguard Survey: Hazard of Cosmic Impacts*. 1996.
- Powell, C. "Asteroid Hunters." *Scientific American*. April 1993, 34-40.
- Proceedings of the 1993 Space Surveillance Workshop*. Lexington, Mass.; R. W. Miller and R. Lincoln Laboratory, 1993.
- Proceedings of the Near-Earth-Object Interception Workshop*. Edited by G. H. Canavan., J. C. Solem, and J. D. G. Rather, Los Alamos, N. Mex.; Los Alamos National Laboratory, 1992.
- "Satellites Detect Record Meteor." *Sky & Telescope*. June 1994, 11.
- Shafer, B.P. et al. "The Coupling of Energy to Asteroids and Comets," in Tom Gehrels, ed., *Hazards Due to Comets and Asteroids*. Tucson, Ariz.: University of Arizona Press, 1994.
- Sikes, L. R. and D. M. Davis. "The Yields of Soviet Strategic Weapons." *Scientific American*. January 1987, 29-37.
- Simonenko, V.A. et al. "Defending the Earth Against Impacts from Large Comets and Asteroids," in Tom Gehrels, ed., *Hazards Due to Comets and Asteroids*. Tucson, Ariz.: University of Arizona Press, 1994.
- Solem, Johndale C. and Charles M. Snell. "Terminal Intercept for Less Than One Orbital Period Warning," in Tom Gehrels, ed., *Hazards Due to Comets and Asteroids*. Tucson, Ariz.: University of Arizona Press, 1994.
- The Spaceguard Survey: Report of the NASA International Near-Earth-Object Detection Workshop*. Edited by David Morrison. Pasadena: Jet Propulsion Laboratory, 1992.
- Treaty Banning Nuclear Weapon Tests in the Atmosphere, In Outer Space and Under Water (1963)*. On-line Internet, date, available on: gopher://gopher.law.cornell.edu:70/00/foreign/fletcher/BH454.txt.
- Treaty On Principles Governing The Activities Of States In The Exploration And Use Of Outer Space, Including The Moon And Other Celestial Bodies (1967)*, in Arms Control and Disarmament Agreements. Washington, D.C.: United States Arms Control and Disarmament Agency, 1982.
- 2025** Concept, No. 200013. "Quantum Effect Communications." **2025** Concepts Database. Maxwell AFB, Ala.: Air War College/**2025**, 1996.
- 2025** Concept, No. 200045. "Defending the High Ground of the Earth-Moon System." **2025** Concepts Database. Maxwell AFB, Ala.: Air War College/**2025**, 1996.

- 2025 Concept, No. 900393 “Chemical Morphing Weapon.” 2025 Concepts Database. (Maxwell AFB, Ala.: Air War College/2025, 1996.
- 2025 Concept, No. 900394 “Gravity Manipulation.” 2025 Concepts Database. Maxwell AFB, Ala.: Air War College/2025, 1996.
- 2025 Concept, No. 900412 “Change Detection.” 2025 Concepts Database. Maxwell AFB, Ala.: Air War College/2025, 1996.
- Tyson, Peter. “Comet Busters.” *Planetary Defense Workshop: An International Technical Meeting on Active Defense of the Terrestrial Biosphere from Impacts by Large Asteroids and Comets*. Lawrence Livermore National Laboratory, 22–26 May 95.
- United Nations Office for Outer Space Affairs. *International Conference on Near-Earth-Objects*. United States, 1995.
- USAF Scientific Advisory Board. *New World Vistas: Air and Space Power for the 21st Century*, Summary Volume. Washington, D.C.: USAF Scientific Advisory Board, 15 December 1995.
- USAF Scientific Advisory Board. *New World Vistas: Air and Space Power for the 21st Century*. Unpublished drafts, the Directed Energy Volume, the Recommended Actions Executive Summary Volume, the Space Applications Volume, and the Space Technologies Volume. 15 December 1995.
- Whipple, A. and P. Shelus. “Long-Term Dynamical Evolution to the Minor Planet (4179) Toutatis.” *Icarus* 408. 1993, 105.
- Wood, Lowell L. et al. “Cosmic Bombardment IV: Averting Catastrophe In the Here-And-Now.” A Presentation to Problems of Earth Protection Against the Impact With NEOs, 26–30 September 1994.