

from: www.zamandayolculuk.com/Cetinbal/HTMLdosya1/vriltechnology.htm

Viktor Schauberger

The UFO's Of Nazi Germany

Viktor Schauberger - May 18, 2007
The Repulsive, UFO's and Flying Saucers of Nazi Germany

It was nearly the end of WWII. At that same time, scientist Viktor Schauberger worked on a secret project. Johannes Kepler, whose ideas **Schauberger** followed, had knowledge of the secret teachings of **Pythagoras** that had been adopted and kept secret. **It was the knowledge of Implosion** (in this case the utilization of the potential of the inner worlds in the outer world). Hitler knew - as did the Thule and Vril people - that the divine principle was always constructive. A technology however that is based on explosion and therefore is destructive runs against the divine principle. **Thus they wanted to create a technology based on Implosion. Schauberger's theory of oscillation** (principle of the overtone sequence, monochord) takes up the knowledge of Implosion. To put it simply: **Implosion instead of Explosion!** Following the energy paths of the monochord and the implosion technology one reaches the realm of antimatter and thus the cancellation of gravity.

Whatever might have been thought of Viktor Schauberger in Austria, word of his abilities and the statements contained in his new book, "Our Senseless Toil - the Source of the World Crisis", evidently reached others ears, including those of Adolf Hitler. At a time when the relations between Austria and Germany were at an all-time low, **Viktor Schauberger was summoned to an audience with the Reich Chancellor Hitler, in Berlin. Special papers were arranged and all the documentation carried out within one day. Suddenly Viktor Schauberger left for Berlin and a meeting with Hitler, who greeted him warmly as a fellow countryman, telling him that he had studied all the reports about his work thoroughly and was very impressed with what he had learned.**

Thirty minutes had been allocated for the discussions, which Prof. Max Planck had been requested to attend as scientific adviser shortly before he was rudely deposed from his

position as Privy Counselor. **This exchange of views eventually lasted 11 hours, during which Schauberger explained the destructive action of contemporary technology and its inevitable consequences.** He contrasted this with all the processes of natural motion and temperature, of the vital relation between trees, water and soil productivity, indeed all the things he considered had to be thoroughly understood and practiced in order to create a sustainable and viable society.

When Viktor had finished his explanations, Max Planck, who had remained silent, was asked his opinion about Viktor's natural theories. His response was the remarkable and revealing statement that "*Science has nothing to do with Nature*". Pausing for a moment to take in this astonishing admission, **Viktor then referred to the proposed four-year plan, the so-called Goering Plan, stating that,**

"not only was the time frame far too short, but, if instituted, it would gradually undermine and ultimately destroy Germany's biological foundations. As a result, the Third Reich would last only ten instead of the boasted 1,000 years." (Viktor was not far out in his estimate!)

During the earlier part of the discussion, Hitler had been enthusiastic, but he became greatly perturbed at what he had just heard and ordered his technical and economic advisers, Keppler and Wiluhn, to discuss with Schauberger what could be done. Once outside the door, these two men demanded to know how Viktor had got in there in the first place. Angered at their truculently condescending air, he replied "***Through the same door I've just come out!***" Seeing that his ideas had no hope of acceptance, and leaving them gaping, he returned to his hotel and left for Austria the following morning. Keppler and Wiluhn, however, were to get their revenge later, after the Anschluss on March 13th, 1938.



Once again he was the victim of deceit and his ideas were usurped, for, in a later letter to his son Walter, he wrote that copies of the preliminary application had been fraudulently obtained by **Prof. Ernst Heinkel**, the famous aircraft designer, through a firm of patent attorneys, Lehmann-Harlens in Berlin. By mining the information contained in this document, Heinkel obtained insights into how a jet-engine could be produced, even though he misinterpreted its findings; his first prototype exploded due to his lack of proper understanding. With a certain absence of principle, he then sought Viktor's collaboration in the project. Although some initial discussion eventually took place, Viktor did not cooperate, having become aware of what Heinkel had done, and further contact between the two men ceased. Using his ill-gotten gains, however, Heinkel persevered with his research, which culminated in the construction of the first successful jet-plane, its first flight being on August 27th, 1939.

Although Heinkel never had the honesty to reveal the source of the ideas for his invention, keeping all the kudos for himself, this jet plane was nevertheless built as a direct result of Viktor's theories. **Viktor Schauberger is therefore the real father of the present jet age.** He even went as far as to state that in order to develop and build fast-flying, supersonic aircraft successfully, the bodily forms of deep-sea fish should be copied. Today's

'stealth bombers' very much emulate these forms. In 1939 Viktor's personal research virtually came to an end, all the materials he needed being appropriated for war production. In 1941, however, he was summoned by Air Marshal Ernst Udet to discuss the growing crisis of energy production and means of solving it. Premises were subsequently set up near Augsburg for research and development, all of which came to nothing partly due to the death of Udet and partly because it was bombed by the Allies in 1942.

In 1943, despite his incapacitating war wounds and 58 years of age, **Viktor was declared fit for active duty and was inducted into the Waffen-SS, very much under duress. He came under the control of Heinrich Himmler, who forced him into research to develop a new secret weapon.** Provided with suitable accommodation at Schloss Schonbrunn, the nearby Mauthausen Concentration Camp to supply the workforce of prisoner engineers, Viktor was threatened with his life if he did not comply with orders and carry out this research. In spite of these threats, however, **Viktor put his foot down and demanded from the SS Command the absolute right to select the various engineers he needed.** He further demanded that any technicians he chose were to be removed entirely from the camp, fed properly, dressed in normal civilian clothes and billeted in civilian accommodation, otherwise they would be unproductive. As he explained, people who live in fear of their lives and under great emotional stress could work neither consistently nor creatively. Surprisingly the SS agreed and so Viktor selected somewhere between twenty and thirty engineers, craftsmen and tradesman from Mauthausen, to be accommodated in various houses near the plant.

When they were all assembled, Viktor exhorted them to work as hard as they could, but under no circumstances were they to attempt to escape, otherwise his own life would be forfeit. They set to work with a will, and, while not understanding what Viktor was trying to achieve, they nevertheless carried out his instructions faithfully. Two machines were eventually built, one called a **'Repulsator'** and the other a **'Repulsine'**, reflecting their forces of recoil. Accurate information about them is difficult to obtain, because after the end of the War all top-secret information was confiscated by the Allies - the Russians, French, English and Americans - and is therefore no longer available to the general public. Let's run this by again, with particular emphasis on the Repulsine, both the A & B models.

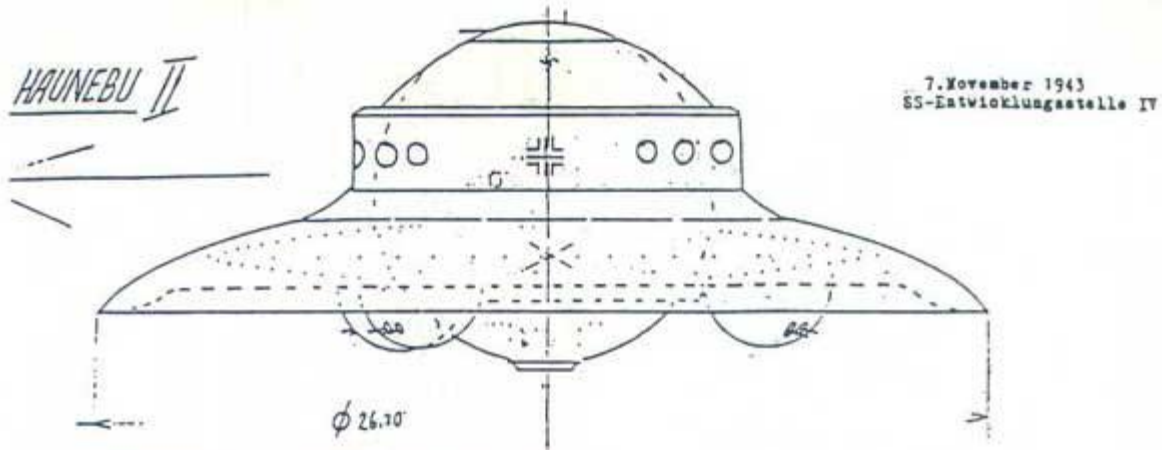

MITTELSCHWERER BEWAFFNETER FLUGKREISEL, TYPE „HAUNEBU II“

Durchmesser: 26,7 Meter
 Antrieb: „Thule“-Taobymotor 70 (gepanzert; Ø TY.-Scheibe: 23,1 Meter)
 Steuerung: Mag-Feld-Impulsor 4a
 Geschwindigkeit: 6000 Kilometer p. Stunde (rechnerisch bis ca. 21000 möglich)
 Reichweite (in Flugdauer): ca. 55 Stunden
 Bewaffnung: 6 8 cm KSK in drei Drehtürmen, unten, eine 11 cm KSK in einem Drehturm, oben
 Außenspannung: Dreieckst-„Victoria“
 Besatzung: 9 Mann (arg. Transportverm. bis zu 20 Mann)
 Weltallfähigkeit: 100 %
 Stillschwebefähigkeit: 17 Minuten
 Allgemeine Flugvermögen: Tag und Nacht, Wetterunabhängig
 Grundsätzliche Einsatztauglichkeit (VT): 85 %
 Verfügbarkeit „Haunebu II“ (bei weiter gutem Erprobungsverlauf wie VT) ab Oktober.
 Dann Serienherstellung ab Jahreswende 1943/44, jedoch noch ohne verbesserte Kraftstrahl-
 kasson „Doaar-Iak IIIV“, deren Prototypen nicht vor Frühsommer 1944 angenommen werden
 kann.
 Von Führer verlangte hundertprozentige Einsatzreife rundum kann allerdings
 nicht vor Ende nächsten Jahres erwartet werden. Erst ab etwa Serie 9.
 Begerkung zuständige SS-Entwicklungsstelle IV: Die neue deutsche Technik- und
 damit vor-Allen Flugkreisel und KSKs-wird wegen der noch zeitraubenden „Herstel-“

Disc Aircraft of The Third Reich

Introduction by Rob Arndt

Probably the most misunderstood and problematic of all terrestrial-based disc technology lies at the heart of the German disc programs that started with the birth of the NSDAP (**Nazi Party**) in 1920- a full 13 years before **Adolf Hitler** came to power as the leader of the **Third Reich**.

To fully comprehend the depth of these programs requires the knowledge that above all else the **NSDAP** was founded from the onset by the occult **Thule** (1917) and **Vril** (1919) **Gesellschafts** (**Societies**), and other occult groups like the **DHvSS** (**Men of the Black Stone**) that stretched back to the turn of the 20th century with the old **German Order** (a.k.a. **Order of Teutons**).

As such the very first disc project in Germany built in 1922 was not even an aircraft but an [inter-dimensional flight machine](#) in disc form- the **JFM** built by **Thule-Vril**.

When **Adolf Hitler** (a **Thule member** along with **Goering**, **Himmler**, and various other top Nazi officials) became chancellor in Germany in 1933 the 11 year occult metaphysical science of **Thule-Vril** became strengthened by official state backing for the continued disc development programs starting with an **RFZ** (**RundFlugZeug**), or "**Round Aircraft**" series of discs that utilized levitators developed by **W.O. Schumann** of the Technical University of Munich who worked on the **JFM**.

1934 saw the first **RFZ discs** built which led in five short years to two vast programs of highly advanced disc aircraft overseen by **Himmler's** SS- specifically, the **SS technical branch Unit E-IV** (**Entwicklungsstelle 4**) which was created to explore various alternative energies. This unit was tasked

with developing both the [Haunebu](#) and [Vril disc](#) designs that utilized the world's first electro-magnetic-gravitic drive systems: the [Vril](#) and [Thule Triebwerks](#). These drives relied on [Hans Coler's](#) free energy Konverter coupled to a [Van De Graaf](#) band generator and [Marconi](#) vortex dynamo (a huge spherical tank of mercury) to create powerful rotating electromagnetic fields that affected gravity.

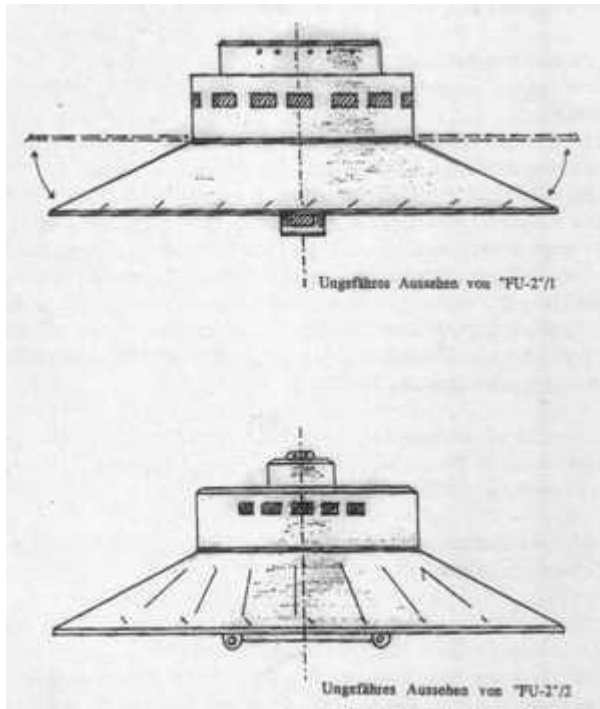

Many have often inquired why then when war started in 1939 did Germany not use these advanced and unique machines in air combat? The simple truth lies in the fact that these machines, despite their superior overall performance to conventional piston-engined aircraft and early jets, could not be realistically adapted to any useful military role other than the most basic transport and recon work. The strong **EM engines** were difficult to control and could not hope to imitate the flight characteristics of high performance fighters like the Me BF 109 or Fw 190. There was very little room for either offensive or defensive armament in these designs except for a few experimental light MG and MK cannons that proved impractical in flight and a rather large experimental Donar (**Thunder**) Kraftstrahlkanone (**Strong Jet Cannon**). These guns tended to destabilize the disc badly and were eventually removed. The disc bodies themselves were not capable of carrying any ordnance at all internally or externally (no bombs, unguided rockets, or missiles) and could only make turns of 22.5, 45, and 90 degrees.

Nevertheless, the SS pursued an aggressive policy of theft, forced cooperation, and strong internal development of these types of machines due to the increasing Allied bombing offensive that made conventional aircraft take-offs and landings highly dangerous. **VTOL** was seen as the logical solution to this problem. If the SS could develop a production machine that in the future could be armed (with cannon, missiles, or even an electrostatic weapon) then Germany might be able to turn the air war.

To shorten the time of finding **VTOL** solutions, the SS robbed both Germany's patent office and every patent office in occupied Europe. Those with aeronautical skill enough to contribute to the SS effort were either arrested or coerced into participating in the programs- among them **Viktor Schauburger** of Austria and **Henri Coanda** of Rumania. The SS also used its large slave labor force to assist in construction of large underground facilities for these discs and often for production of components to these machines.

Although the SS requested additional slave laborers from Armaments Minister **Albert Speer**, **Speer** himself was not told what war projects the laborers would be used for; indeed, **Speer** was deliberately

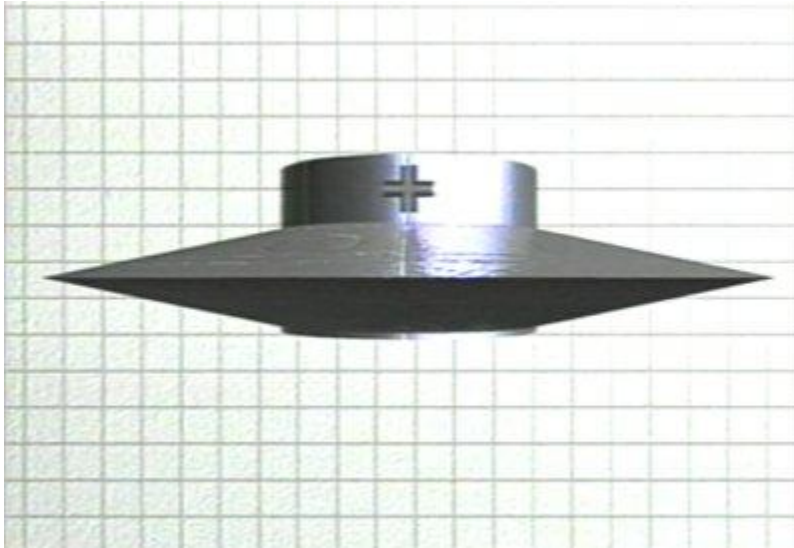

Due to round-the-clock bombing the SS was forced to try even more drastic measures, launching unmanned interceptor discs from the **Schwarzwald**. These discs were known as the "**Feuerball**" weapon, sometimes erroneously referred to as the mystery "**V-7**" weapon (of which there never was an official designation). The **WNF Feuerball** relied on a rocket motor for launch, a plume sensor for aerial detection, and an electrostatic field weapon invented at **Messerschmitt's Oberammergau** facility. Production of these craft was initially performed by **WNF**. Because the discs burned chemicals around its ring to create the electrostatic field necessary to disable Allied bomber engines and radar the object was soon nicknamed the "**Foo Fighter**" by the Allies who sighted this fiery halo weapon approaching them by day or night. **FOO** was a take on the French word Feu (Fire) and from the Smokey Stover comic of a bumbling fireman that actually started fires!

Naturally, **WNF** observed the burning effect too and soon nicknamed their weapon the **WNF Feuerball** (Fireball). The Feuerballs plagued the 415th NFS from November 1944 to April 1945. By that time production had been shifted to the Zeppelin Werk that nicknamed the larger improved weapon as "**Kugelblitz**" (**Ball Lightning**). The Allies seemed confused by these weapons which ranged in size from small to large and attacked in singles or multiples. The Germans further confused the Allies by launching "Seifenblasen" along with the **Feuerballs**. **Seifenblasen** (Soap Bubbles) were large weather balloons trailing metal strips that confused Allied radar. Their large round shape reflecting in daylight gave them the appearance of a shining globe similar to the Feuerball. The Germans further complicated the identification of the "Foo Fighters" with a range of smaller purely spherical aerial probes that were used as psychological weapons. These "**KugelWaffen**" (**Ball weapons**) played aerial games with the Allied bomber gunners that would have in time distracted them from the real threat of larger approaching **Kugelblitz discs**.

But by the spring of 1945 the war was lost regardless and most of the remaining disc programs were halted. **Henri Coanda** had been arrested in Paris in 1940 and forced to work on a disc under SS supervision. His design for a lenticular disc that benefited from his own "Coanda effect" was a masterpiece of jet disc design. But because it required 12 JUMO 004 jets to power the huge machine the project never got past the wind tunnel testing phase. Likewise, **Andreas Epps** independent **Omega Diskus** which utilized two Pabst ramjets and 8 Argus lift fans was also confined to 1/10th scale model testing.

Dr. Alexander Lippisch had also studied disc aerodynes back in 1941 but was too involved in the ME-163 Komet and DM-1 delta glider programs to produce anything more than brief design concepts based on the Gottingen K 1253 disc wing profile. The **Horten brothers**, experts with flying wings, also studied circular wing designs but did not actually work on any in Nazi Germany. They did so for the US Govt.

postwar in late 1945-46 producing what is now believed to be the craft that crashed at **Roswell** in 1947- a spy craft parabolic lifting body carried by a large meteorological balloon.

In the face of imminent defeat BMW destroyed all their Flugelrads. Schriever's Flugkreisel was also destroyed. Miethe's disc may have been captured as Miethe went to Canada postwar to work on AVRO's designs.

Habermohl was captured by the Russians while **Dr. Belluzzo** returned to Italy. **Schauberger's Repulsins** were also captured by the Allies while most of the SS scientific branch records still intact were captured by the British who postwar attempted to create a working design through **AVRO** Canada with eventual US assistance.

One very little known **Peenemunde disc project** under **Heinrich Fleissner** was the last disc to take off from Berlin in late April 1945 on an official mission. But details of the "Dusenscheibe" (**Devils Disc**) remain clouded in mystery.

Meanwhile, the **Feuerball** attacks that stopped in April 1945 in Germany resumed in August 1945 in Japan- an obvious technology transfer from Germany to Japan via U-Boat. The Japanese, however, lacked all the documentation for this weapon and only launched a few. It is said that the Japanese were frightened by this "demonic thing" and destroyed the remaining **Feuerballs** by dynamiting them in a pit. Photographic evidence also seems to identify "**Kugelwaffen**" sent to Japan as well as several are seen trailing Sally bombers, probably for flight testing.

But the **Third Reich** story ends as strangely as it had begun. What about the mysterious **Thule-Vril discs** which were actually built in small numbers? By 1945 there were quite a few **Haunebu II** and **Vril 7** discs flying. **Vril** had even tested the **Vril 8 Odin** and possibly the even more streamlined **Vril-9 Abjager**. These craft were not destroyed but evacuated from March 1945 to an area safe from Allied bombing or capture.

In the year preceding the start of WW2 Germany sent an expedition to **Antarctica** to scout out a location for a military base there. The Germans found such a location in the former **Queen Maud Land** which Germany renamed **Neu Schwabenland**. There, in secret during 1942-43, a base was built in the **Muhlig-Hoffman mountains**. **Base 211** (or **Station 211**). The base was supplied with slave laborers shipped by sea and U-boats to construct an elaborate cave complex deep within the mountains- an impregnable fortress. Hot internal springs were found there, iron ore deposits, vegetation and access was achieved primarily through an underwater trench that ran through the area.

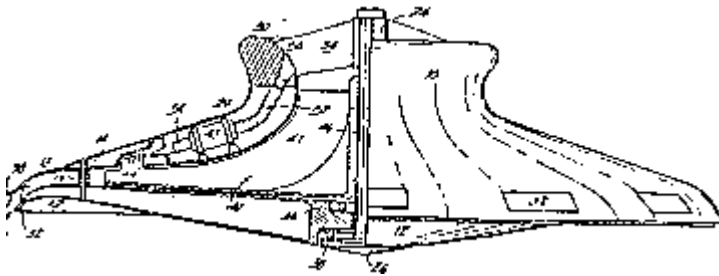
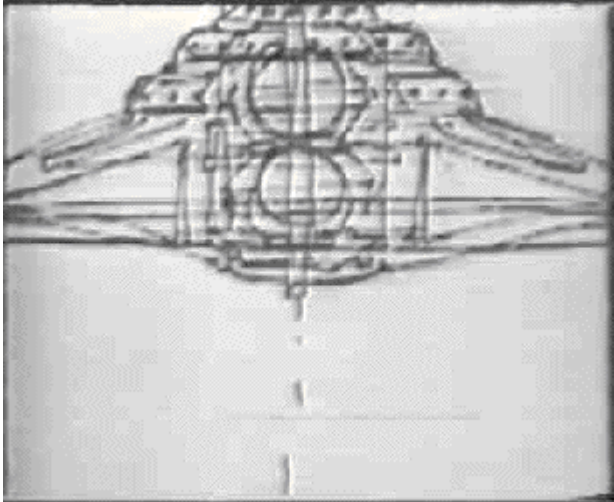

During the war, especially the latter part, German U-boats made frequent trips to the **South Atlantic**, **South America**, and **Antarctica**. Germany also set up floating meteorological buoys in Antarctic waters and weather stations on islands located between Antarctica and the tip of South America. The **SS RuSHA**, (Rasse und SeidlungsHauptAmt- Race and Settlement Bureau) began in 1942 to take women of **Aryan** decent (Volksdeutsch) from the Ukraine solely for the purpose of transporting them to **Base 211**. Ten thousand women between the ages of 17-24, blonde and well proportioned, were recruited for the project along with 2,500 Waffen SS soldiers serving in Russia. The goal of this massive undertaking was to create a colony at **Base 211** suitable for habitation and continued development of the **Thule-Vril technology**. It is believed that both the **Thule** and **Vril Gesellschafts** evacuated that technology to **Base 211** at the close of the war under **SS General Kammler**, who was in charge of Germany's most secret weapons programs. Two U-boats that surrendered after the war in Argentina are also believed to have carried cargo and high-ranking SS to **Base 211**. Both boats were empty upon surrender with the crews refusing to disclose their cargos and destinations.

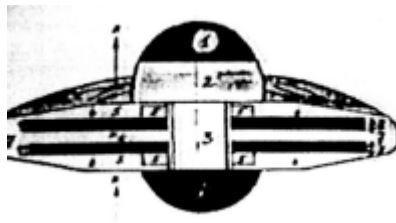
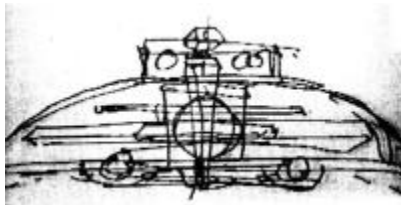

It became apparent in 1946 that 54 U-boats and over 6,000 technicians and scientists were "missing" from Germany- especially from the **SS Technical Branch**. There were also 40, 000 slave laborers and between 142,000-250,000 German citizens unaccounted for. Despite simply writing these off as probable losses and deaths of the war, Washington suspected that a large number of these missing actually escaped to South America and **Base 211** (if such a base existed). The US then went on a hunt using the "war criminal" propoganda to cover up the search for technology akin to a South American version of "**Operation Paperclip**".

The United States was so concerned about the secret base that in 1947 with the first Antarctic summer "[Operation Highjump](#)" was launched with a full military task force headed by [Admiral Byrd](#). The task force was to head straight for [Neu Schwabenland](#) and recon the area for a base. If one was found 4,700 armed troops would have been sent to capture it or destroy it. The task force performed the aerial recon, trailing magnetometers to detect any magnetic anomalies under the ice... but several of [Byrd's](#) planes were lost. The aircraft had run into enemy opposition. "[Operation Highjump](#)" ended in failure as [Byrd](#) headed back after several weeks, far short of the 8 months that was intended. In his unofficial comments to the South American press [Byrd](#) stated that he was attacked by "enemy aircraft" that "[could fly from pole to pole at incredible speed](#)". Subsequently, the modern [UFO](#) phenomenon sprang up in 1947 and concentrated disc development programs were initiated in the '50s that have continued on to present-day "[black project](#)" aircraft operated by the [CIA](#), [NSA](#), and [NRO](#).

So the story of the [Third Reich disc programs](#) does not end with the collapse of the [Third Reich](#) itself. It continues unresolved...

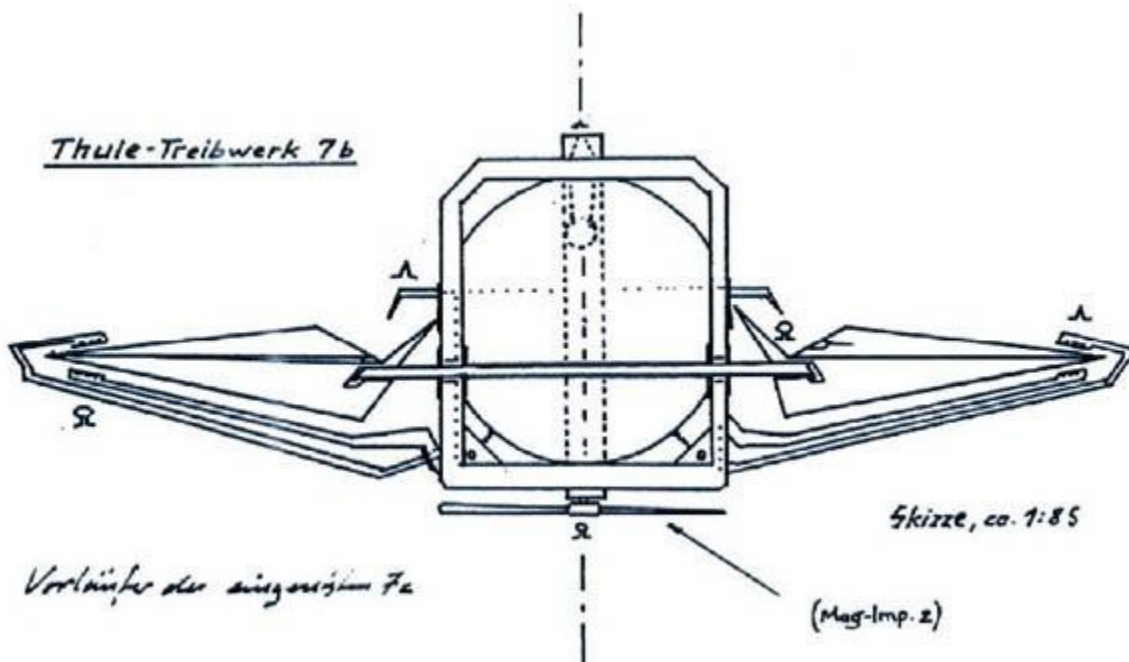

Vril 1 "Jager (Hunter)"

(1941)

The [Vril](#) motto "[Not all good comes from above](#)" summarizes the entire history of the [Vril Gesellschaft](#) ([Society](#)) from its inception to the final days of WW2 when this occult group seemed to vanish right off the face of the earth.

The name [Vril](#) is the shortening of "[VRI-IL](#)" which means "[Like God](#)". Officially [Vril](#) was "[The All German Society for Metaphysics](#)" which merged with the [Thule Gesellschaft](#) and the obscure [DHvSS](#) ([Men of the Black Stone](#)) in the year 1919.

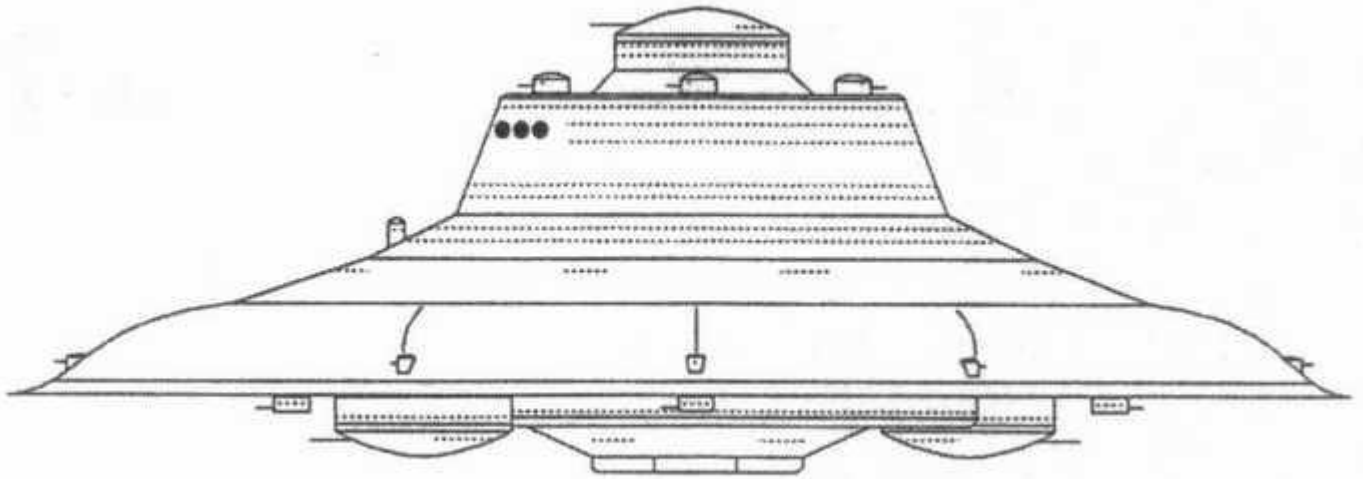

Each **occult group** had its own distinct beliefs and origins. The DHvSS (1912) worshipped the German mountain goddess **Isias** and the **Schwarz Stein** (black stone). The Thule Gesellschaft (1917) believed in the hollow earth theory and derived its name from **Ultima Thule** the ancient capital of Hyperborea at the top of the world. Vril worshipped **the Black Sun** (the invisible inner light of the Godhead) which supposedly gave or generated incredible power and communicated with Aryan aliens through psychic channeling.

But unlike the other two groups the **Vril Gesellschaft** were an inner circle of women who were also fighting against their times and culture. They were psychic mediums that wore a horse-tail hairstyle. They believed that their long hair acted as cosmic antennae to receive **alien communication** from beyond. So this is where the Vril disc story begins.

Despite their distrust of men, the **women of Vril** joined with the Thule Gesellschaft and DHvSS in order to construct an inter-dimensional channeled flight disc known as the **Jenseitsflugmaschine** (JFM). By 1922 the odd disc shaped machine was constructed in Munich and tested for two years. It is not known if any success with channeled flight was ever achieved but a certain **W.O. Schumann** of the *Technical University of Munich* invented a levitator from the channeled JFM information provided by the mediums **Maria Orsic** and **Sigrun**. By 1924 the JFM project was scrapped but work continued on perfecting **the levitator** unit known by then as the Schumann SM-Levitator.

With the **Nazi Party** in power in 1933 (which itself originated from the Thule Gesellschaft) the occultists now received official backing for their continued development of the flight discs. **Thule** and **Vril** started with the **RFZ** (Rundflugzeug, or Round Aircraft) series from 1934-41.

As war had started in 1939 the RFZ-5 became **the Haunebu I** and by 1941 the RFZ-7 had become the **Vril 1 Jager** (Hunter). The reason for the changes were due to Thule's revolutionary Triebwerk (Thrustwork) engine that used rotating electro-magnetic-gravitic fields to affect gravity. **Vril** had by 1941 perfected the SM-Levitator as well and thus two new series entered limited construction, but with slightly different goals.

Thule wanted to develop both a production combat craft and a functional Raumschiff (Spaceship). **Vril**, by comparison, only wanted to develop Raumschiffen to reach **Aldebaran** in the Taurus Constellation 68 light years from earth.

As **Hitler** had forbid secret societies in Germany from 1941 forward, both Thule and Vril were documented under the SS Technical Branch Unit E-IV (Entwicklungsstelle 4) tasked with developing alternative energies. This unit had already helped with the RFZ series but now “officially” Thule and Vril did not exist. **Vril** became known secretly as “the chain”. Vril members wore a Doppelsignet disc that represented the two mediums **Maria Orsic** and **Sigrun**.

The first purely Vril disc - **the Vril 1 Jager** (Hunter) was constructed in 1941 and first flew in 1942. It was 11.5 meters in diameter, had a single pilot, and could achieve 2,900 km/h - 12,000 km/h! It flew with a metal dome at first but subsequent test versions had a heavily reinforced glass dome and could seat two crew. Flight endurance was 5.5 hrs. It was planned to arm this craft with two MK-108 cannon plus 2 MG-17 machineguns. Seventeen of these craft were constructed and tested between 1942-44 with 84 test flights

The **Vril 2 Zerstoror** (Destroyer) was a highly advanced oval shaped disc that was much too complex for the time period; thus it was projected for 1945/46, so no construction was started. **The Vril 3 and 4** have been photographed but no surviving information is found on them. **Vrils 5 and 6** likewise do not show up and may have only been projects. The **Vril 7 and 8**, however, were constructed.

The **Vril 7 Geist** (Ghost) was 45 meters in diameter and crewed by fourteen men. It was built in 1944 and tested at Arado-Brandenburg using Vril's own Triebwerk.

Vril's medium **Sigrun** made frequent trips to the facility to oversee construction and testing. In 1944, Arado engineers approached her with a request. They wanted to know if the Vril Triebwerk could be adapted to one of their projects- the Arado E.555 strategic bomber. They were abruptly told , “No” and returned to their designs which resulted in eleven different versions of the bomber.

Sigrun was actually insulted because the entire purpose of the Vril discs was aimed at space flight. No conventional bomber could withstand the heat of the velocity achieved by these machines which were constructed of hulls specially made of an advanced metal called **Viktalen** (in some sources Victalen or Viktalon). The **Vril 1** had a single hull of this type, the **Vril 7** two. The large **Haunbeu III** had three!

With the SS supervising all aspects of the disc programs every model had to have at least theoretical provision for armament. In the **Vril 7 Geist** it would have been four MK-108 cannon.

The **Vril 8 Odin** was the last official Vril disc that was flight tested in the spring of 1945 during the collapse. This disc had an automatic Oberon upward-firing gun installation on top of the control center.

The Vril Gesellschaft had started evacuating to Base 211 in Neu Schwabenland Antarctica in March 1945 so it would seem like the Vril 8 Odin was the last Vril disc actually tested. However, some weeks after Germany surrendered both Haunebu and Vril craft were spotted in the skies over occupied Germany. Although the **Vril 9 Abjager** (Universal Hunter) was show as a design on paper, a craft identical to it was photographed postwar.

Vril's final plan was the construction of a large 139 meter long cylindrical Raumschiff known by the SS E-IV Unit as **the Andromeda-Gerat**. Work on this “flying cigar” was to commence in 1945 at a huge, sheltered above-ground Zeppelin-like hangar. Once completed it could internally accommodate one large Haunebu IV and two Vril 2 craft, making the journey to Aldebaran, the ultimate dream of the Vril Gesellschaft.

Although these mysterious craft seem to come from the realm of *science fiction* it is interesting to note that once Germany was occupied and the military Intel teams swept through the defeated nation all documentation and evidence of **the Vril Gesellschaft** was destroyed by the Allies. If the occult Society and craft never existed and did not represent any threat to the Allies then why has all trace of their existence been forcefully carried out by the victors?

“Not all good comes from above”. For **Vril** it came “from beyond... 68 light years from earth” and it was this obsession that lead to ALL of the occult German disc programs. One can only wonder if any of them truly made it to their ultimate destination?

THE NAZI BELL

THE GERMAN HAUNEBU I
(circa 1940's)

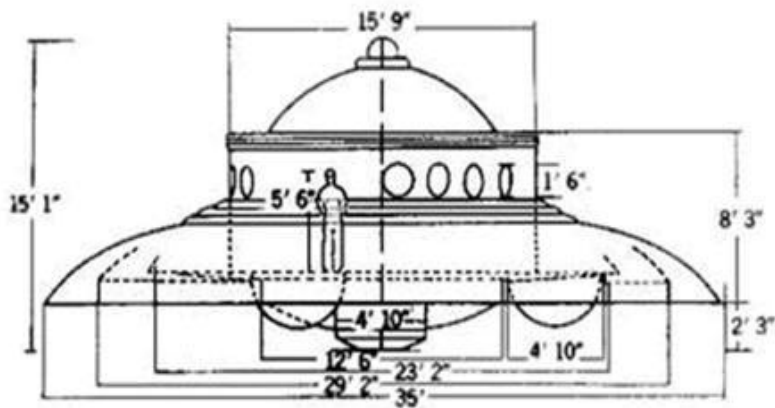

HAUNEBU DESIGN USING AN
ARRAY OF ROTATING GYROSCO

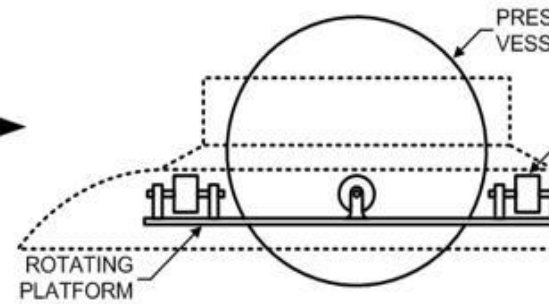

© INTALEK, INC., 2007

Das **HAUNEBU III** mit 71 m Durchmesser wurde nur einmal gebaut und stieg zu mindestens 19 Flügen auf (ca. 7,000 km/h).

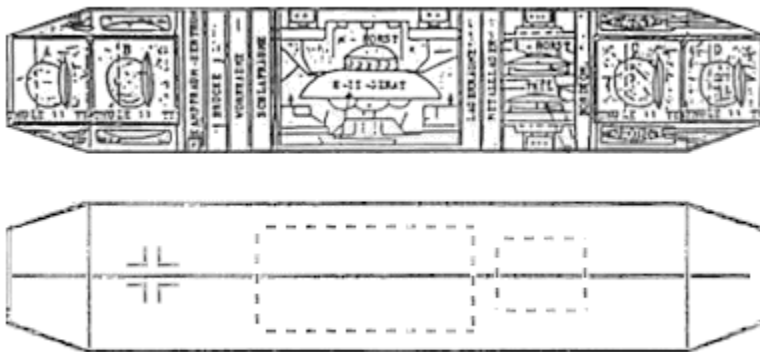

Und in Form von Plänen existierte das »**ANDROMEDA-GERÄT**«, das 139m lange Mutterschiff mit Hangarn für einen Haunebu II, zwei VRIL I und zwei VRIL II.

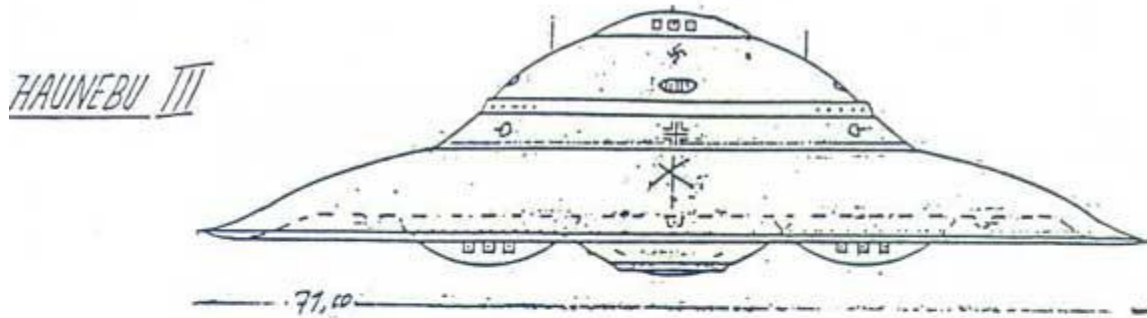

SCHWERER BEWAFFNETER FLUGKREISSEL „HAUNEBU III“

Durchmesser: 71 Meter
 Antrieb: Thule-Tachyonator 70 plus Schumann-Levitatoren (gepanzert)
 Steuerung: Mag-Feld-Impulsor 4a.
 Geschwindigkeit: ca. 7000 Kilom.p.Stunde (rechnerisch bis zu 40000)
 Reichweite (in Flugdauer): ca. 8 Wochen (bei S-L-Flug 40% mehr)
 Bewaffnung: 4 x 11cm KSK in Drehtürmen (3 unten, 1 oben), 10 x 8cm KSK in Drehringen plus 6 x MK 108, 8 x 3cm KSK ferngesteuert
 Außenpanzerung: Dreischott-Victalen
 Besatzung: 32 Mann (erg. Transportverm. max. 70 Personen)
 Weltallfähigkeit: 100 %
 Stillschwebefähigkeit: 25 Minuten
 Allgemeines Flugvermögen: Wetterunabhängig Tag und Nacht
 Grundsätzliche Einsatztauglichkeit: Etwa 1945.
 Bemerkung: ES-IV hält den Hinweis für notwendig, daß in „Haunebu III“ ein großartiges Werk deutscher Technik im Entstehen ist, wegen der allgemeinen Materiallage aber alle Kräfte auf das schneller verfügbare Haunebu II gesetzt werden sollten.
 Gemeinam mit dem leichteren Flugkreisel „Vril“ der Schumann-Gruppe könnte „Haunebu II“ die von Führer aufgestellten Forderungen sicherlich erfüllen.

Haunebu III Technische Daten:

Durchmesser: 71 Meter

Antrieb: Thule Tachyonator 70 plus Schumann SM-Levitatoren (gepanzert)

Steuerung: Magnetfeld-Impulsator-4a

Geschwindigkeit: 7000 Stundenkilometer (40.000 Km/h möglich)

Reichweite: (in Flugdauer) ca. 8 Wochen

Bewaffnung: 4 x 11cm KSK (**KraftStrahlKanonne**) in vier Drehtürmen. 10 x 8cm KSK in Drehringen plus 6 x MK 108 und 8 mal 3cm KSK ferngesteuert.

Außenpanzerung: Dreischott "Victalen"

Besatzung: 32 Mann (bis zu 70 Mann möglich)

Weltallfähigkeit: 100%

Stillschwebefähigkeit: 25 Minuten

Allgemeines Flugvermögen: Tag & Nacht, Wetterunabhängig

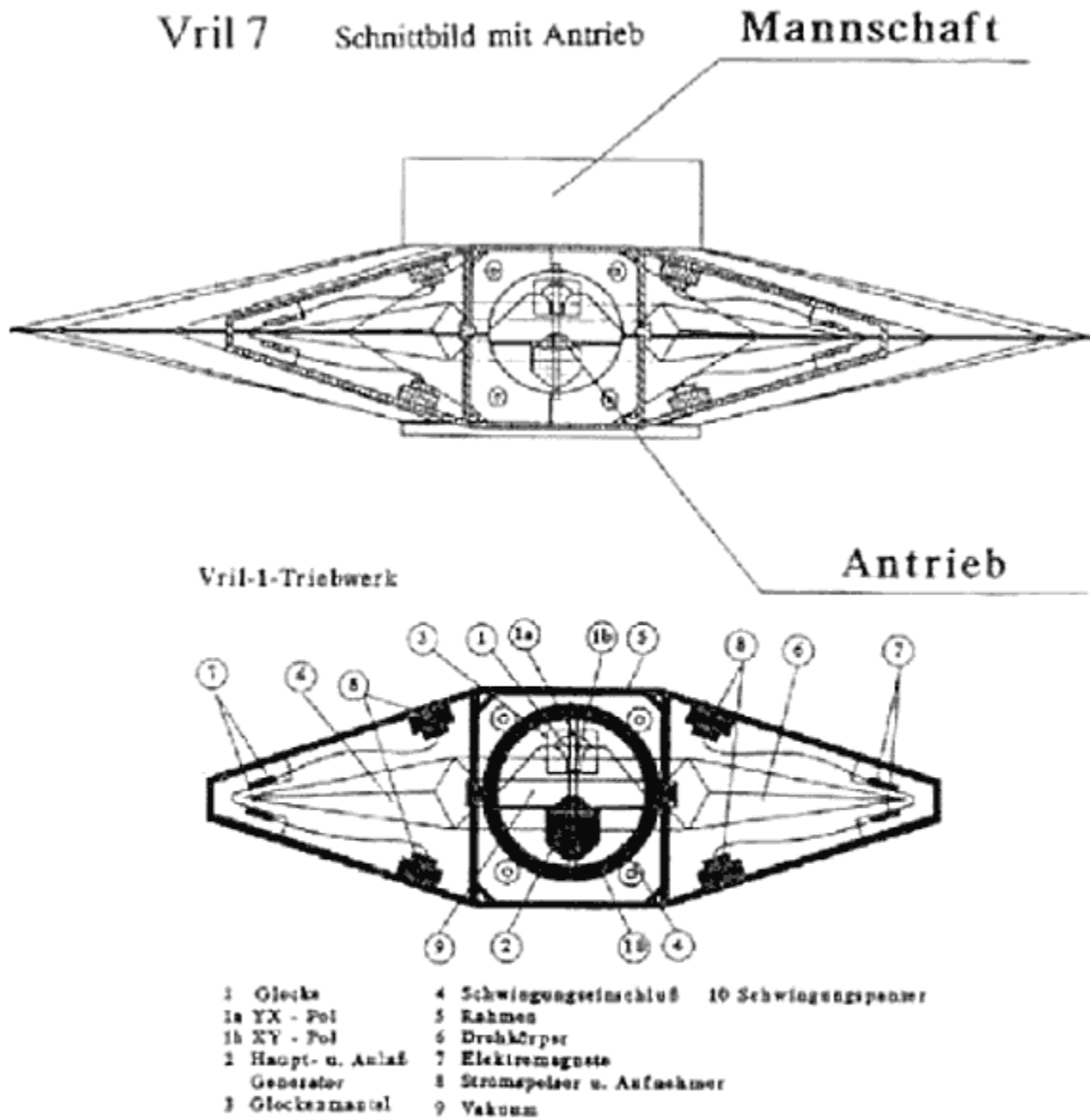

Gemeinschaft des Schwarzen Steins



Rekonstruktionsversuch

Durchmesser des Geräts ca. 45 m

What happened to these flying machines after the war?

It cannot be excluded that a small series of the Haunebu II might have been built. The several photographs of UFOs that emerged after 1945 with the typical features of these German constructions suggest as much.

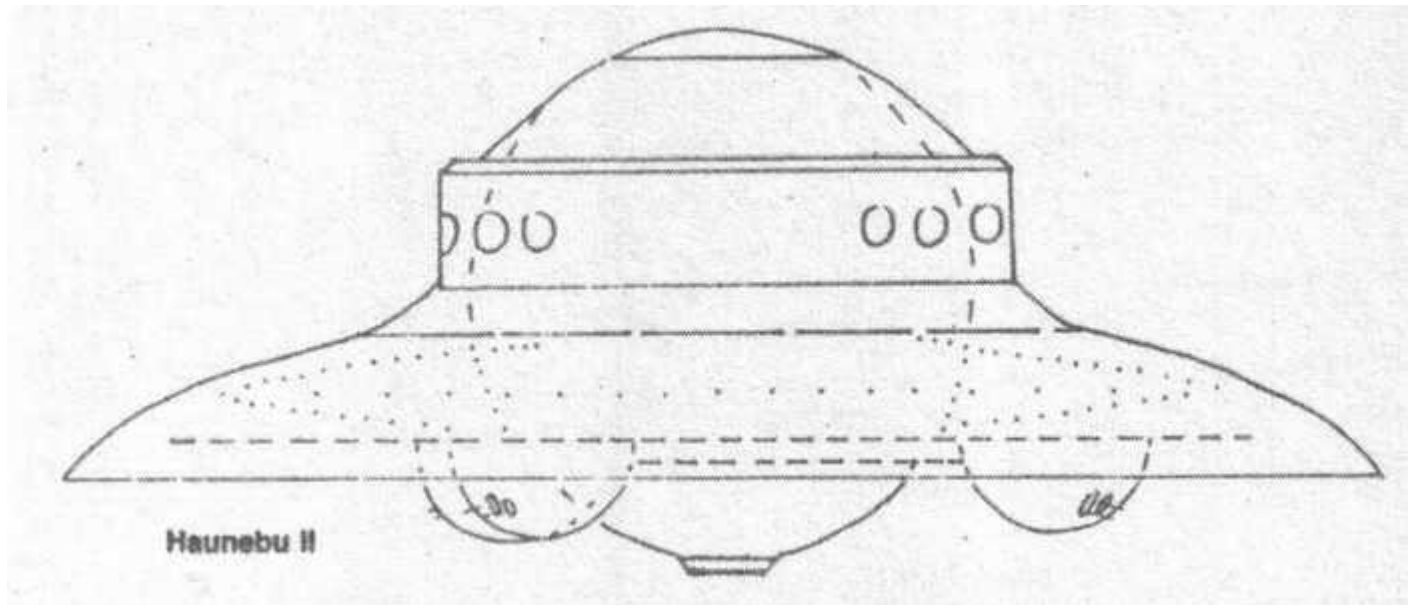

Some say that some of them had been sunk into the Austrian Mondsee, others maintain that they were flown to South America or brought there in parts. It is certain though that if the crafts didn't get to South America, the plans that did allowed for new ones to be built and flown there, for an important part had been used in 1983 in the "Phoenix Project", the follow-on project of the 1943 "Philadelphia Experiment". This was a teleportation, materialization and time travel experiment of the U.S. Navy that was more successful than you could imagine in your wildest dreams. There is enough material for another book, but it does not fit too well into our subject here. See the literature list.

In 1938 a German expedition to the ANTARCTIC was made with the aircraft carrier *Schwabenland* (Swabia). 600,000 km² of an ice-free area with lakes and mountains were declared German territory, the "NEUSCHWABENLAND" (New Swabia). Whole fleets of submarines of the 21 and 23 series were later headed towards *Neuschwabenland*.

Today about one hundred German submarines are still unaccounted for, some equipped with the *Walter snorkel*, a device that allowed them to stay submerged for several weeks, and it can be assumed that they fled to *Neuschwabenland* with the dismantled flying disks or at least the construction plans. Again it must be assumed that since the test flights had been very successful some so-called flying saucers have flown directly there at the end of the war.

Perhaps some may think these assumptions to be a bit on the daring side, but there are strong indications that this may well have happened that way. (For example the video-production UFO-SECRETS OF THE THIRD REICH - which so clear shows the story here - why is this production never shown in our traditional tv-stations?? Because it shows the whole secret - and why the americans after ww2 had to secure this information for their own increasing of power and PREVENT THIS INFORMATION TO REACH OUT - THIS WOULD SABOTAGE THEIR CONTROL OF THE WORLD THROUGH MONEY AND ENERGY CONTROL).

There is the question why in 1947 [ADMIRAL E. BYRD](#) led an invasion of the ANTARCTIC, why he had 4,000 soldiers, a man-of-war, a fully equipped aircraft carrier and a functioning supply system at his command if it was a mere expedition? He had been given eight months for the exercise, but they had to stop after eight weeks and high losses of planes undisclosed even today. What had happened?

Later Admiral [Byrd](#) spoke to the press:

"It is the bitter reality that in the case of a new war one had to expect attacks by planes that could fly from Pole to Pole." Further he added that there was an advanced civilization down there that used their excellent technologies together with the SS.

Norbert-Jurgen Ratthofer writes about the whereabouts of the Haunebu developments in his book "Zeitmaschinen" . Time Machines:

"The Haunebu I, II and III space gyros and the VRIL I space flying disk had disappeared after May 1945... It is very interesting to note in this context that after its nineteenth test flight, the German Haunebu III is said to have taken off on April 21, 1945, from Neuschwabenland, a vast, officially German territory in the Eastern Antarctic, for an expedition to Mars, about which there is nothing further known...

One year later, in 1946, the many sightings that suddenly occurred in Scandinavia of shining objects of unknown and definitely artificial origin caused a great stir among the Allies in East and West. Again one year later, in 1947, and well into the Fifties, a rising number of shining unknown flying objects, doubtlessly steered by intelligent beings, mostly round, disk- or bell-shaped, sometimes cigar-shaped, so-called UFOs appeared over North America."

The text goes on to say that as a rule these objects were unlike the German developments. I beg to differ. Good photographic material proves that the Haunebu II version especially had been sighted very often since 1945. If you have wrestled with what is available in the UFO world for ten years as I have, that in a significantly high percentage of the cases where personal contacts with the people from the so-called UFOs was made, these were with especially beautiful Aryan types, blond and blue-eyed and that they either spoke fluent German or another language with a German

accent (for insiders I would refer to the Adamski case of 1952, the Cedric Allingham case of 1954 and the Howard Menger case of 1956).

It is further said that colour photographs taken by a night guard in West Germany in the Seventies exist of a landed and restarted flying disk that had both a knight's cross and a swastika on its hull.

The flying machines just mentioned are well documented on photographs and films. There is the 60 minutes documentary "UFO - Secrets of the Third Reich". The American Vladimir Terziski gave a three-hour speech at the September 1991 UFO conference in Phoenix, Arizona, where he showed slides of German saucers, construction plans and subterranean German bases. Also of interest are the book by the Italian air force commander Renato Vesco and the book by Rudolf Lusar "Die deutschen Waffen und Geheimwaffen des Zweiten Weltkrieges und ihre Weiterentwicklung" (The German Arms and Secret Weapons of the Second World War and Their Development), J. F. Lehmanns Verlag, Munich 1971.

Do you see now why the subject of UFOs is treated as nonsense by the media, especially in Germany? Upon this German background it becomes evident that the news and media world controlled by the Illuminati through the Anglo-American Zionist lobby shirks no costs to keep the German citizens from research in this area.

The Question arises from where the Thule and Vril secret societies got their knowledge about the construction of these flying machines? Also their knowledge of gene technology in which area the Germans were also way ahead of other countries?

According to Herbert G. Dorsey and other researchers they had, besides the construction plans the Vril-Gesellschaft had received through telepathic contact with extra-terrestrials, a non-terrestrial saucer that had crashed in the Black Forest in 1936 and whose undamaged drive had proved a great help to the Germans. But there is practically no proof of that, and no living eye witnesses are known.

But these exist in America, and in large numbers. For around the same time the Americans recorded quite a number of crashes that could not be kept entirely secret. More of that later.

Back to the political arena. Apart from the fact that I. G. Farben supported Hitler, their cartel partner "Standard Oil" (Rockefeller) fanned the flames against the Nazis. The "Ford Motor Company" for instance helped to build up the American army while at the same time producing in Germany military vehicles for the Nazis. Ford and Opel (subsidiary of General Motors that is controlled by J. P. Morgan) were the two largest producers of tanks in Hitler's Germany.

Whatever the outcome of the war, these multinational companies had already made their cuts. Many enterprises followed this principle during the Second World War.

Why is there nothing about all this in schoolbooks or encyclopaedias? Especially in Germany where the freedom of the press is apparently honoured and the *truth* is taught?

One of the reasons is that the Rockefeller Foundation spent US\$ 139,000 in 1946 to present an official history of the Second World War which covered up the whole story of the U.S. bankers building up the Nazi regime as well as the occult and mystical background of the Nazis. One of the main sponsors was Rockefeller's own "Standard Oil Corp."

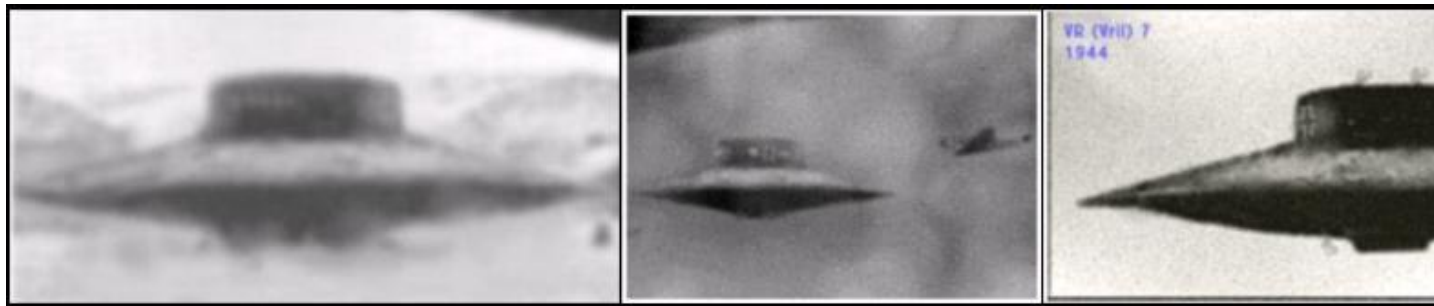

Extract from the book SECRET SOCIETIES of jan van hilsing (pseudonym)

From page 179(some headlines added here):

THE DEVELOPMENT OF THE GERMAN UFOs FROM BEFORE WW2.

THE VRIL-GESELLSCHAFT OR

"NOT ALL GOOD COMES FROM ABOVE"



PICTURES - ART OF JIM NICHOLS

The VRIL-GESELLSCHAFT (VRIL Society) does not exactly fit our subject which has a more political slant, but it is indeed one of the most interesting secret societies that ever existed. Therefore it just has to be mentioned here. In Germany there is not a single book, or indeed any material, to be found that would show up an organization of this name, the Allies successfully removed it all. But as you will see, not all the material has actually disappeared.

And I am very pleased that I can uncover this subject here, because you will see which "non-German" power circles have an interest to keep these events from the German people.

In 1919 Karl Haushofer founded a second order, the "BRUDER DES LICHTS" (Brothers of the Light) that later was renamed "VRIL-GESELLSCHAFT". In this united the new Templar order "DIE HERREN VOM SCHWARZEN STEIN" (DHvSS, The Lords of the Black Stone) that emerged in 1917 from the Teutonic

Order, and the "SCHWARZE RITTER" (Black Knights) of the Thule and SS elite "SCHWARZE SONNE" (Black Sun).

To compare the THULE and the VRIL-GESELLSCHAFTEN, it is easiest said the Thule-Gesellschaft dealt with material and political interests, while the Vril-Gesellschaft was more oriented towards the OTHER SIDE. But many concepts they shared, like Atlantis, Thule, the basic connection between the Teutons and Mesopotamia, but also the old sacred places like the "Externsteine" (external stones) or the Hausberg at Stronegg were areas of common research.

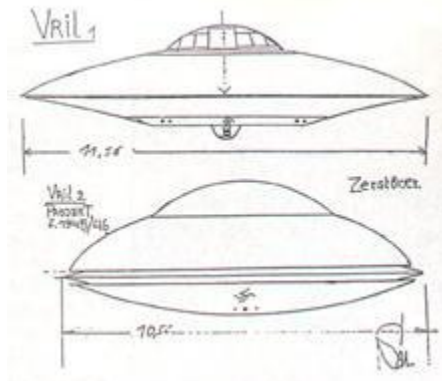
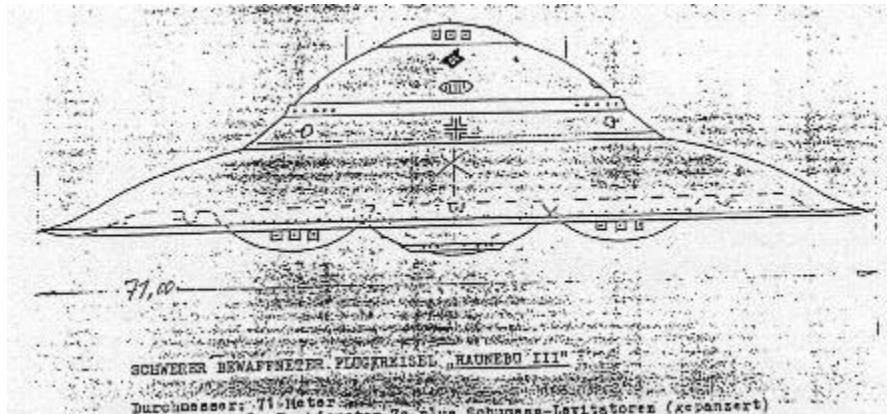

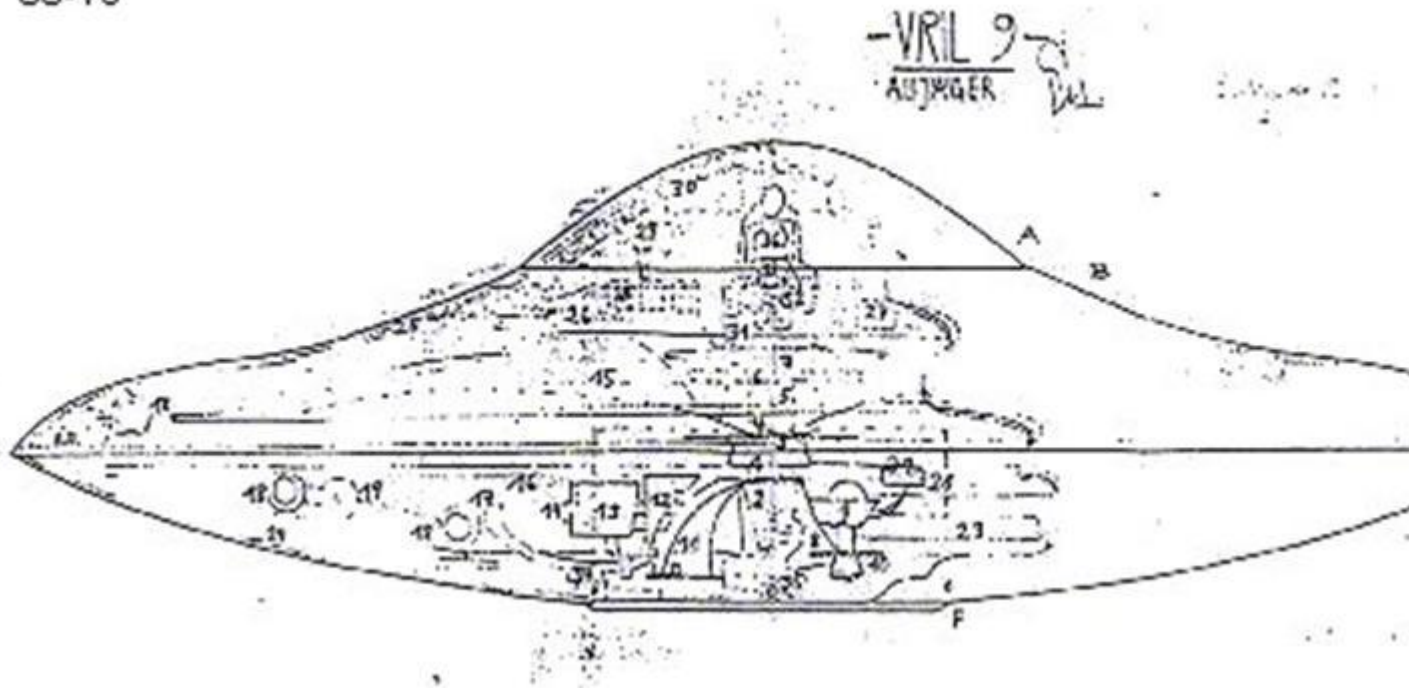

Cosmic communication through mediums:

In December 1919 a small circle of persons from the Thule, the Vril and the DHvSS met in a specially rented forester's lodge near Berchtesgaden (Germany). They were accompanied by the medium Maria Orsic and another medium only known as Sigrun. Maria had mediumistically received transmissions in a secret Templar script - a language unknown to her - with the technical data for the construction of a flying machine. According to Vril documents these telepathic messages came from the solar system Aldebaran which is sixty-eight light-years away in the constellation Taurus.

I would like to present here a short summary of the messages the Vril mediums had received over the years and which formed the basis for all further actions by the Vril-Gesellschaft:

"The solar system Aldebaran has a sun around which revolve two inhabited planets that form the empire "SUMERAN". The population of the Aldebaran system is divided into the master race of "light God people" (Aryans) and several other human races that had developed by negative mutation from the "God people" because of climatic changes upon the planets. The coloured mutant races apparently are on a lower stage of spiritual development. The more the races intermixed, the lower the spiritual development of these peoples sank, which led to the situation that when the sun *Aldebaran* began expanding they could no longer maintain the space travel technology of their forefathers and could not leave the planets by their own means. The lower races, totally dependant upon the master race, had to be evacuated and were

brought to other inhabitable planets. Despite their difference all the races respected one another and did not interfere with each other, neither the so-called God people nor the lower races. Each respected that the others just made their own developments (in contrast to what happens on Earth).

Around 500 million years ago the "light God people" started to colonize other Earth-like planets, after the expansion of the sun Aldebaran and the resulting heat had made the original planets uninhabitable. It is said that in our system they first colonized the planet *Mallona* (also called Maldek, Marduk or - by the Russians - Phaeton) which existed in the area of today's asteroid belt, then between Mars and Jupiter. Mars was next.

The proof for a highly developed race on Mars is run by the well-known face on Mars and the pyramid city which has been photographed by the Mars probe *Viking* in 1976. It is assumed that the master race of Sumeran-Aldebaran then also came to Earth for a first visit, witnessed by the petrified impression of a shoe found to be about 500 million years old, and squashed under the heel a trilobite, a little crayfish that lived then upon Earth and became extinct about 400 million years ago.

The Vril people thought that later, when Earth became slowly habitable, the race of the Aldebarans landed in Mesopotamia and formed the master caste of the SUMERIANS which were described as fair, white God people. The Vril telepaths also found that the Sumerian language was not only identical with that of the Aldebarans, but also that it sounds like unintelligible German and that the language frequency of German and Sumerian-Aldebaranian were almost identical.

We cannot know whether these statements about Aldebaran were based on facts, but the construction plans and the technical details that the Vril telepaths received - wherever they came from - were so accurate that they led to the most fantastic idea men ever begot: the construction of a "Jenseitsflugmaschine", a "flying machine for the other side"!

The concept of an "alternative science" emerged (today one would say "alternative energy forms") But they only started on the project three years later.

During this early phase of "alternative science" Dr. W. O. Schumann of the Technical University in Munich, both a Thule and a Vril member, held a speech a section of which is reproduced here:

"In everything we recognize two principles that determine the events: light and darkness, good and evil, creation and destruction - as in electricity we know plus and minus. It is always: either - or."

These two principles - the creative and the destructive - also determine our technical means...

Everything destructive is of Satanic origin, everything creative is divine... Every technology based upon explosion or combustion has thus to be called Satanic. The coming new age will be an age of a new, positive, divine technology!..." (from the German SS secret archives).

At the same time the scientist **VIKTOR SCHAUBERGER** worked on a similar project. Johannes Kepler whose ideas Schauberger followed had knowledge of the secret teachings of Pythagoras that had been adopted and kept secret by the **KNIGHTS TEMPLAR**. It was the knowledge of **IMPLOSION** (in this case the utilization of the potential of the inner worlds in the outer world). Hitler knew - as did the Thule and Vril people - that the divine principle was always constructive. A technology however that is based on explosion and therefore is destructive runs against the divine principle. Thus they wanted to create a technology based on **IMPLOSION**. Schauberger's theory of oscillation (principle of the overtone sequence, monochord) takes up the knowledge of Implosion. To put it simply:

IMPLOSION instead of EXPLOSION!

Following the energy paths of the monochord and the implosion technology one reaches the realm of antimatter and thus the cancellation of gravity.

Saucer-shaped flying machines

In the summer of 1922 the first saucer-shaped flying machine was built whose drive was based on implosion (the "other side flying machine"). It had a disk eight metres across with a second disk with a diameter of six and a half metres above and a third disk of seven metres diameter below. These three disks had a hole at the centre of one metre eighty across in which the drive which was two meters forty high was mounted. At the bottom the central body was cone-shaped, and there a pendulum reaching the cellar was hung that served for stabilisation. In the activated state the top and bottom disk revolved in opposing directions to build up an electromagnetic rotating field.

The performance of this first flying disk is not known. But experiments were carried out with it for two years before it was dismantled and probably stored in the Augsburg works of Messerschmidt. In the books of several German industrial companies entries under the codename "JFM" (for Jenseitsflugmaschine) can be found that show payments towards financing this work. Certainly the **VRIL DRWE** (formally called "Schumann SM-Levigator") emerged from this machine.

VRIL₁

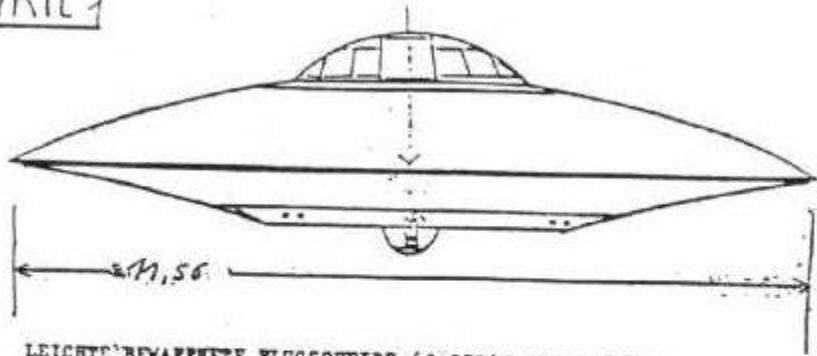

LEICHTE BEWAFFNETE FLUGSCHREIBE (JAGER); TYPE „VRIL“
(Schumann-Gruppe)

Durchmesser: 11,50-Meter
Antrieb: Schumann-Lavitator (gepanzert)
Steuerung: Mag-feld-impulser 3a
Geschwindigkeit: 2900 Kilometer p. Stunde (bisher), bis zu ca. 12000 mögl.
Reichweite (in Flugdauer): 5 1/2 Stunden ((Plug-Aufladung mittels KS von
Haunebu aus, wird erprobt))
Bewaffnung: 1 Bcm KSK, fernsteuerbar, unten, + 2 x Mk 108 u. 2 x Mk 17
Außenpanzerung: Doppel-Viktalen
Besatzung: (je nach Einsatzart) 1 bis 3 Mann
Weltallfähigkeit: 100 %
Stillschwebefähigkeit: 12 Minuten
Allgemeine Flugfähigkeit: Wetterunabhängig Tag und Nacht
Grundsätzliche Einsatzzeit: ca. Sept. 1944, ev. früher.

Vril1 from sept 44

diam.11.5 m

Drive:Schuman levitator (antigravitation eqpm.)

Steuerung/steering: mag-feld-impulser

Velocity: 2900-12000km/h

Capacity: 5.5 h in air

Haunebu 1 from dec.44

diam.25 m

Drive:Thule tachyomator 7b (antigravitation eqpm.)

Steuerung/steering: mag-feld-impulser

Velocity: 4800-17000km/h

Capacity: 18 h in air

Crew 8 people

Haunebu II From 43-44

diam.26,3 m

Drive: Thule tachyomator 7b (antigravitation eqpm.)

Steuerung/steering: mag-feld-impulser

Velocity: 6000-21000km/h

Capacity: 55 h in air

Crew 9 people

Haunebu III From sometimes in-45

diam.71 m

Drive:Thule tachyomator 7b and Schuman levitators (antigravitation eqpm.)

Steuerung/steering: mag-feld-impulser

Velocity: 7000-40000km/h

Capacity: 8 weeks in air

Crew 32 people

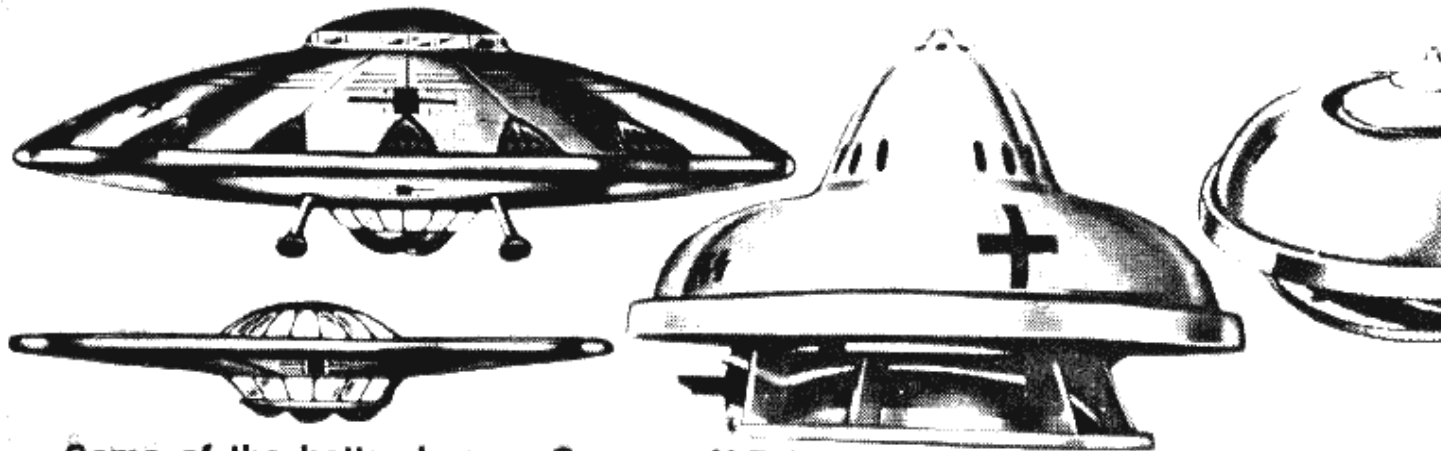

Some of the better known German U.F.O. prototypes.

In principle the "other side flying machine" should create an extremely strong field around itself extending somewhat into its surroundings which would render the space thus enclosed including the machine a microcosm absolutely independent of the earthbound space. At maximum strength this field would be independent of all surrounding universal forces - like gravitation, electromagnetism, radiation and matter of any kind - and could therefore manoeuvre within the gravitational or any other field at will, without the acceleration forces being effective or perceptible.

In June 1934 VIKTOR SCHAUBERGER was invited by HITLER and the highest representatives of the Thule and Vril societies and from then on worked with them.

After the initial failure the first so-called German UFO also came out in June 1934. Under the leadership of Dr. W. O. Schumann the first experimental round flying machine, the RFZ 1 (Rundflugzeug 1) was developed on the grounds of the aircraft factory *Arado* in Brandenburg. In its first and only flight it rose vertically to around 60 metres, then wobbled and danced in the air for minutes. The *Arado 196* guiding system was utterly useless. The pilot Lothar Waiz just managed somehow to bring it down to the ground, jump out and run away before it began to act like a spinning top, turned over and literally ripped to pieces. That was the end of the RFZ 1, but the beginning of the VRIL flying machines.

Before the end of 1934 the RFZ 2 was ready, with a Vril drive and a "magnetic field impulse steering unit". It had a diameter of five metres and the following flying characteristics: With rising speed the visible contours became blurred and the craft showed the colours typical for UFOs: depending on the drive setting red, orange, yellow, green, white, blue or purple. It worked - and it should meet a remarkable destiny in 1941, during the "Battle of Britain", when it was used as transatlantic reconnaissance craft, because for these flights the German standard fighters ME 109 had an insufficient range.

By the end of 1941 it was photographed over the southern Atlantic on its way to the German cruiser *Atlantis* in Antarctic waters. It could not be used as a fighter though. The impulse steering allowed it only changes of direction at 90gr 45gr or 22.50 gr, but that is exactly the right-angled flying pattern associated with and typical for UFOs today!

After the success of the small RFZ 2 as a distant reconnoitre craft the VrilGesellschaft got its own test area in Brandenburg. By the end of 1942 the lightly armed "VRIL-1-Jager" (VRIL-1 fighter) was airborne. It measured 11.5 metres across, carried one person, had a "Schumann-Levigator" drive and a "magnetic field impulse steering unit". It reached speeds of 2,900 to 12,000 km/h, could change direction at a right angle at full speed without affecting the pilot, could fly in any weather and had a 100% space capability. *Seventeen VRIL-1's were built and some versions had two seats and glass domes.*

Also during this time an own project was worked on, the V-7. Several disks were built under this code, but with conventional jet engines. ANDREAS EPP had designed a combination of levitating disk and jet propulsion, the RFZ 7. The design groups SCHRIEVER-HABERMOHL and MIETHE-BELLUZO worked on it. The RFZ 7 had a diameter of forty-two metres, it crashed on landing at Spitzbergen. A second craft was later photographed outside Prague. According to Andreas Epp this craft was to be armed with nuclear heads to attack New York.

In July 1941 SCHRIEVER and HABERMOHL built a vertical take-off round craft with jet propulsion, but it had severe shortcomings. They went on to develop an "electro-gravitational flying gyro" with a "tachyon drive" which proved more successful. Then Schriever, Habermohl and Belluzo built the RFZ 7 T that was fully functional. The V-7 flying disks however were mere toys compared to the Vril and Haunebu disks.

Within the SS there was a group studying alternative energy, the SS-E-IV (Development Group IV of the Black Sun) whose main task was to render Germany independent of foreign oil. The SS-E-IV developed from the existing Vril drives and the tachyon converter of Captain Hans Coler the "THULE DRIVE" which later was called the "THULE TACHYONATOR".

44 Geheimkommandofolge

44

Flugkreisel-Erprobung, Stand / Anzahl Erprobungsflüge:

HAUNEBU I (vorhanden 2 Stück)	52	E-IV
HAUNEBU II (vorhanden 7 Stück)	106	E-IV
HAUNEBU III (vorhanden 1 Stück)	19	E-IV
(VRIL I) (vorhanden 17 Stück)	84	(Schumann)

Empfehlung:

Beschleunigen von Abschlusserprobung
und Produktion „Haunebu II“
+ „VRIL I“

HAUNEBU I

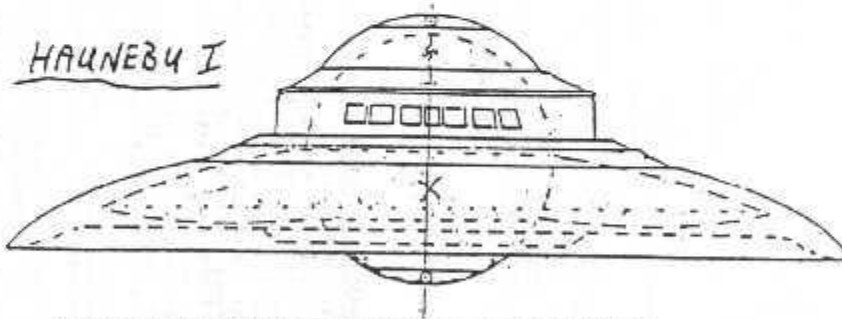

MITTELSCHWERER BEWAFFNETER FLUGKREISEL, TYPE „HAUNEBU I“

Durchmesser: 25 Meter
Antrieb: Thule-Tachyonator 7b
Steuerung: Mag-Feld-Impulsor 4
Geschwindigkeit: 4800 Kilo.p.Std. (recha. bis 17000)
Reichweite in Flugzeit: 18 Stunden
Bewaffnung: 2 x 8cm KSK in Drehtürmen und 4 x MK 108, starr nach vorn
Außenansteuerung: Doppel-Victales
Besatzung: 8 Mann
Weltallfähigkeit: 60 %
Stillstandszeitfähigkeit: 8 Minuten
Allgemeine Flugfähigkeit: Tag wie Nacht
Grundsätzliche Einsatztauglichkeit: 60 %
Frontverfügbarkeit: Nicht vor Jahresende 44

Bemerkung: Die K3-E-IV hält Konzentration auf bereits im Versuch stehende „Haunebu II“ für sinnvoller als an beiden Typen parallel weiterzuarbeiten. „Haunebu II“ verspricht entscheidende Verbesserungen in nahezu allen Punkten. Höhere Herstellungskosten scheinen gerechtfertigt - besonders mit Blick auf Führer-Sonderbefehl, Flugkreisel betreffend.

In August 1939 the first RFZ 5 took off. It was an armed flying gyro with the odd name "HAUNEBU I". It was twenty-five metres across and carried a crew of eight. At first it reached a speed of 4,800 km/h, later up to 17,000 km/h. It was equipped with two 6 cm KSK ("Kraftstrahlkanonen", power ray guns) in revolving towers and four machine guns 106. It had a 60% space capability.

By the end of 1942 the HAUNEBU II was ready. The diameters varied from twenty-six to thirty-two metres and their height from nine to eleven metres. They carried between nine and twenty people, had a Thule Tachyonator drive and near the ground reached a speed of 6,000 km/h. It could fly in space and had a range of fifty-five flying hours.

At this time there existed already plans for a large-capacity craft, the VRIL 7 with a diameter of 120m. A short while later the HAUNEBU III, the showpiece of all disks, was ready, with seventy-one meters across. It was filmed flying. It could transport thirty-two men could remain airborne for eight weeks and reached at least 7,000 km/h (according to documents in the secret SS archives up to 40,000 km/h).

Virgil Armstrong, former CIA member and green beret, writes about German flying machines during World War Two that could take off and land vertically and fly at right angles. They were measured at 3,000 km/h and had a laser weapon (probably the so-called KSK power ray gun) that could pierce four inch armour.

Professor J. Hurtak, UFO-logist and author of "The Keys of Enoch" writes that the Germans were in the process of building what the Allies called "the wonder weapon system". Hurtak got protocols that described two events:

1. the erection of a space city at Peenemunde and
2. the enlistment and transport to the U.S. of the best technicians and scientists from Germany.

He also mentions the meticulous examination of the so-called "FOO FIGHTERS". The CIA and the British secret service knew already in 1942 about the construction and the use of these flying objects, but they were off in their evaluation. *Foo fighters* actually was the Allies' name for all glowing German flying machines. Probably there were two inventions that actually corresponded to the term *foo fighters*: the *Flying Turtle* and the *Soap Bubble*. Two completely different objects that the Allies held for one.

The FLYING TURTLE was developed by the SS-E-IV at Vienna-Neustadt. Its outer shape recalled the shell of a turtle. They were unmanned probes that could cause disruptions in the electric ignition systems of the enemy. They carried advanced "Klystronrohren" (clystron tubes) that the SS called death rays. The ignition disrupter did not work perfectly at the outset, later follow-up versions did, however, and the UFO-logists will confirm that disruption of ignition, the cutting of electrical power to equipment is a typical sign when a UFO is near. Wendelle C. Stevens, U.S. Air Force pilot during the Second World War, describes the foo fighters as sometimes grey-

green, the red-orange, they approached his aircraft to about five metres and then stayed there. They could not be shaken off nor shot down and often they caused squadrons to turn back or land.

The SOAP BUBBLES that were also called *foo fighters* were something completely different, though. They were simple balloons in which there were metal spirals that disturbed enemy radar. The success probably was very limited, disregarding the psychological effect.

At the beginning of 1943 it was planned to build in the Zeppelin works a cigar-shaped mother ship. The ANDROMEDA DEVICE of a length of 139m should transport several saucer-shaped craft in its body for flights of long duration (interstellar flights).

By Christmas 1943 an important meeting of the VRIL-GESELLSCHAFT took place at the seaside resort of Kolberg. The two mediums Maria Ortic and Sigrun attended. The main item on the agenda was the ALDEBARAN PROJECT. The mediums had received precise information about the habitable planets around the sun Aldebaran and one began to plan a trip there. At a January 22, 1944 meeting between HITLER; HIMMLER, Kunkel (of the Vril Society) and Dr. Schumann this project was discussed. It was planned to send the VRIL 7 large-capacity craft through a dimension channel independent of the speed of light to Aldebaran. According to Ratthofer a first test flight in the dimension channel took place in the winter of 1944. It barely missed disaster, for photographs show the Vril 7 after the flight looking "as if it had been flying for a hundred years". The outer skin was looking aged and was damaged in several places.

On February 14, 1944, the supersonic helicopter - constructed by Schriever and Habermohl under the V 7 project - that was equipped with twelve turbo-units BMW 028 was flown by the test pilot Joachim Roehlike at Peenemunde. The vertical rate of ascent was 800 metres per minute, it reached a height of 24,200 metres and in horizontal flight a speed of 2,200 km/h. It could also be driven with unconventional energy. But the helicopter never saw action since Peenemunde was bombed in 1944 and the subsequent move to Prague didn't work out either, because the Americans and the Russians occupied Prague before the flying machines were ready again.

In the secret archives of the SS the British and the Americans discovered during the occupation of Germany at the beginning of 1945 - photographs of the Haunebu II and the Vril I crafts as well as of the Andromeda device. Due to President Truman's decision in March 1946 the war fleet command of the U.S. gave permission to collect material of the German high technology experiments. Under the operation PAPERCLIP German scientists who had worked in secret were brought to the U.S. privately, among the VIKTOR SCHAUBERGER and WERNHER VON BRAUN.



A short summary of the developments that were meant to be produced in series:

The first project was led by Prof. Dr. mg. W. O. Schumann of the Technical University Munich. Under his guidance seventeen disk-shaped flying machines with a diameter of 11.5 m were built, the so-called **VRIL-1-Jäger** (Vril-1 fighters), that made 84 test flights. At least one VRIL-7 and one VRIL-7 large capacity craft apparently started from Brandenburg - after the whole test area had been blown up - towards Aldebaran with some of the Vril scientists and Vril lodge members.

The second project was run by the SS-W development group. Until the beginning of 1945 they had three different sizes of bell-shaped space gyros built:

The **Haunebu I**, 25m diameter, two machines built that made 52 test flights (speed ca. 4,800 km/h).

The **Haunebu II**, 32m diameter, seven machines built that made 106 test flights (speed ca. 6,000 km/h). The Haunebu II was already planned for series production. Tenders were asked from the Dornier and Junkers aircraft manufacturers, and at the

end of March 1945 the decision was made in favour of Dornier. The official name for the heavy craft was to be DO-STRA (Dornier STRATospheric craft).

The **Haunebu III**, 71m diameter, only one machine built that made at least 19 test flights (speed ca. 7,000 km/h).

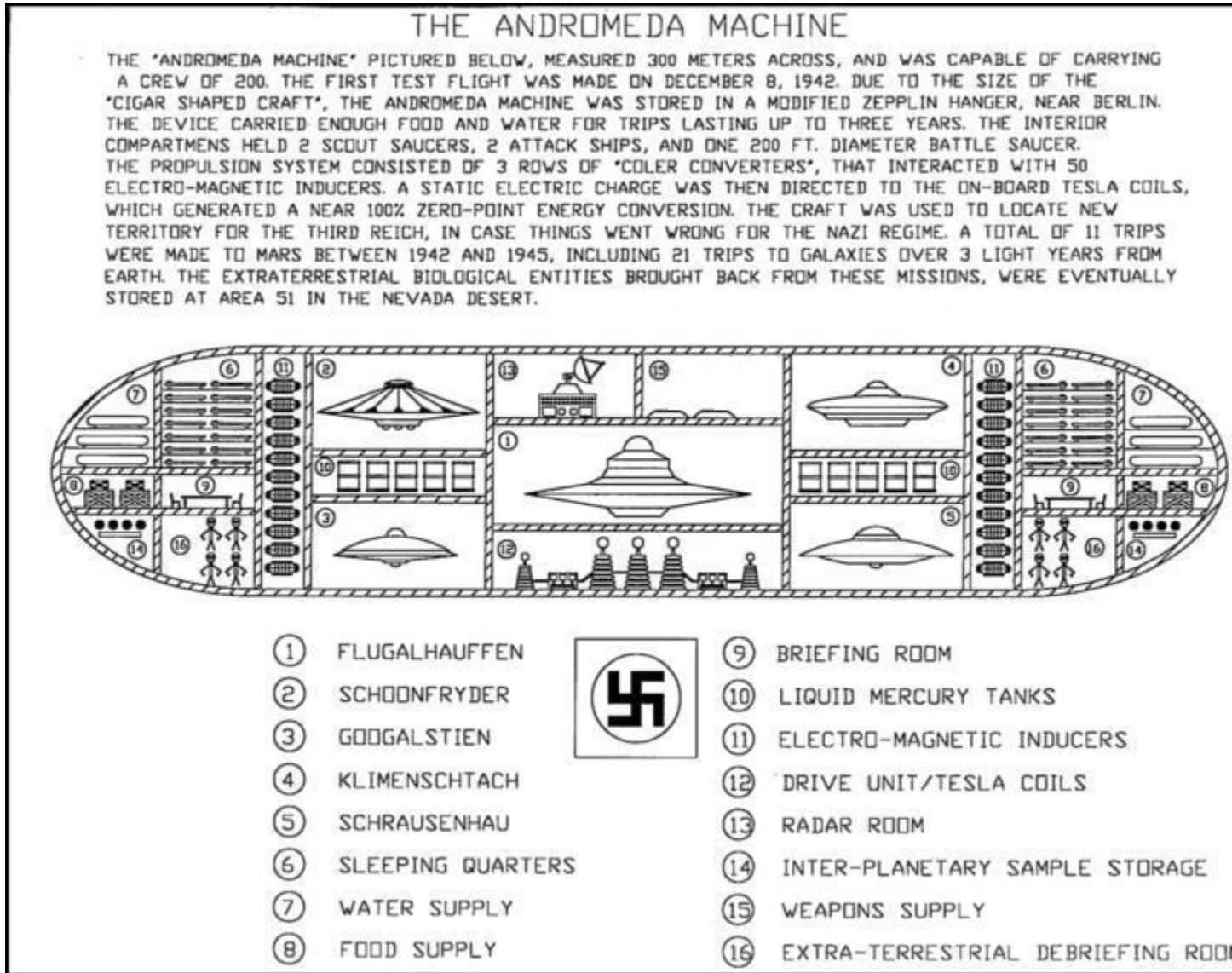

ANDROMEDA-GERÄT

E-V, 2. Dez. 44

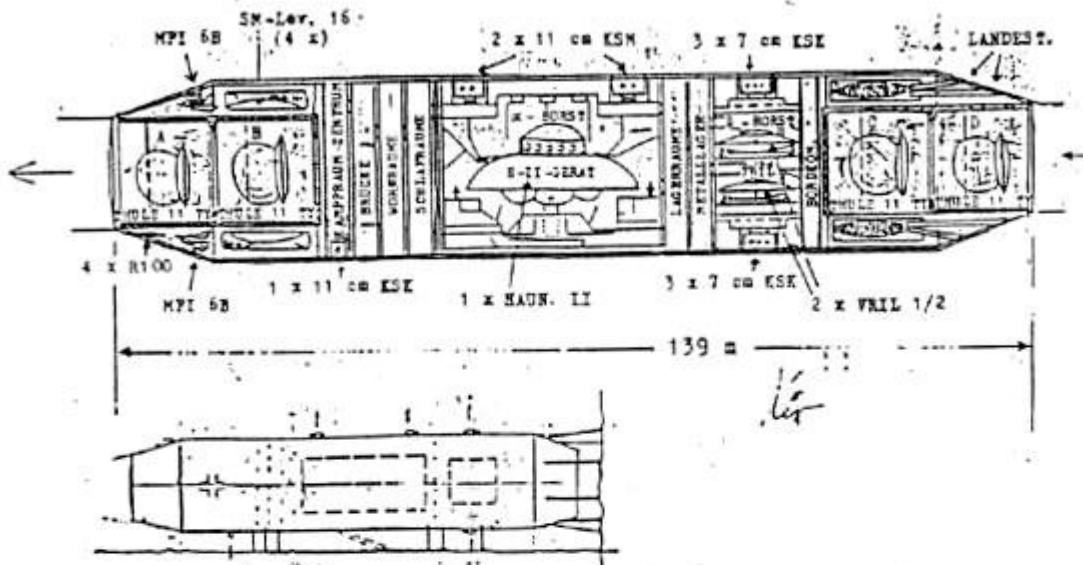

BEWAFFNETES TRÄGER- UND LANGSTRECKENRADMSCHIFF "ANDROMEDA-GERÄT"

Länge : 139 Meter
 Durchmesser : 30 Meter (in der Mitte, errechnet)
 Antrieb : 4 x Thule-Fachgeneratoren II, 4 x Schumann-Levitatoren 16
 (gepannert)
 Steuerung : Mag-Feld-Impulsor 6b
 Geschwindigkeit : Keine Angaben, theoretisch müßten fast 300 000
 Kilometer p. Sekunde möglich sein
 Reichweite : Keine Angaben, rein theoretisch unbegrenzt
 Bewaffnung : 2 x Drehtürme n. 2 x 2 x 11cm KSK,
 1 x Drehturm n. 1 x 1 x 11cm KSK,
 2 x Drehtürme n. 2 x 3 x 7cm KSK,
 4 x R100
 Außenpanzerung : Unbekannt, vermutlich Protechtart-Fiktalen wie bei
 Haunebu-III
 Besatzung : 130 Mann (errechnete Durchschnittszahl)
 Vertikalität : 100 %
 Stillsetzbarkeit : Unbekannt, vermutlich 25 Minuten wie bei
 Haunebu-III
 Allgemeines Flugvermögen : Unbekannt, vermutlich wie bei Haunebu-III
 wetterunabhängig bei Tag und Nacht
 Grundtastliche Eisentauglichkeit : Unbekannt, doch vermutlich war
 1945/46 geplant.
 Heliboote : A - Horst = 1 x Haunebu-II, B - Horst = 2 x Vrill-1 + 2 x Vrill-2

Aus reichsdeutschen SS-Geheimarchiven (Planskizzen, Beschriftung aus Fragmenten rekonstruiert).

The **ANDROMEDA DEVICE** existed on the drawing board, it was 139m long and had hangars for one Haunebu II, two Vrill I's and two Vrill II's.

There are documents showing that the VRIL 7 large capacity craft has started for secret, still earth-bound, missions after it was finished and test flown by the end of 1944:

1. A landing at the Mondsee in the Salzkammergut in Austria, with dives to test the pressure resistance of the hull.
2. Probably in March and April 1945 the VRIL 7 was stationed in the "Alpenfestung" {Alpine Fortress} for security and strategic reasons, from whence it flew to Spain to get important personalities who had fled there safely to South America and "NEUSCHWABENLAND" (explanation follows) to the secret German bases erected there during the war.



3. Immediately after this the VRIL 7 is said to have started on a secret flight to Japan about which however nothing further is known.

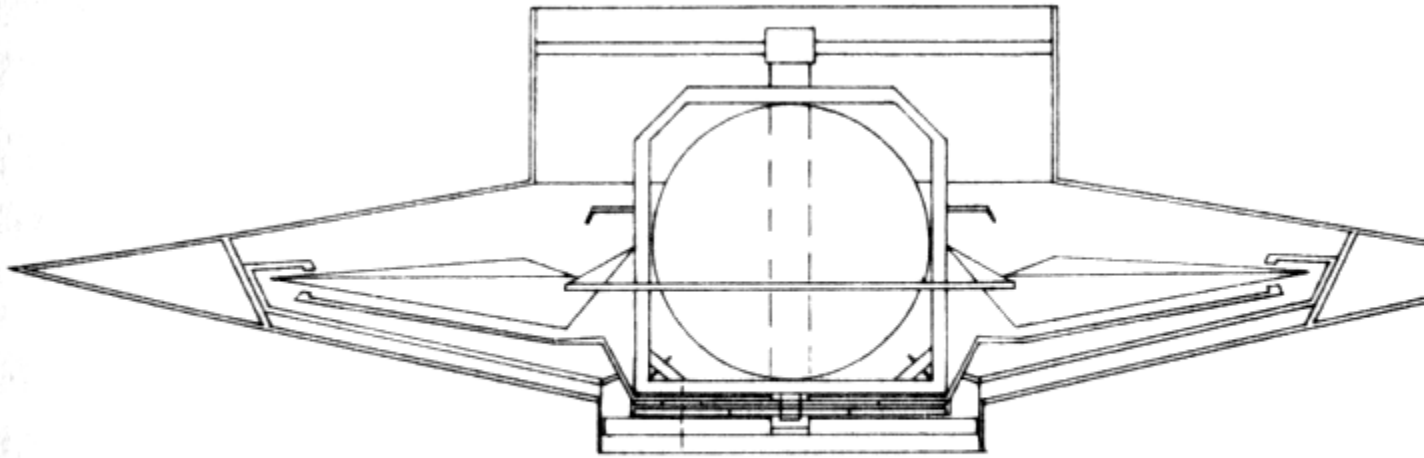

Напнебу (вариант)

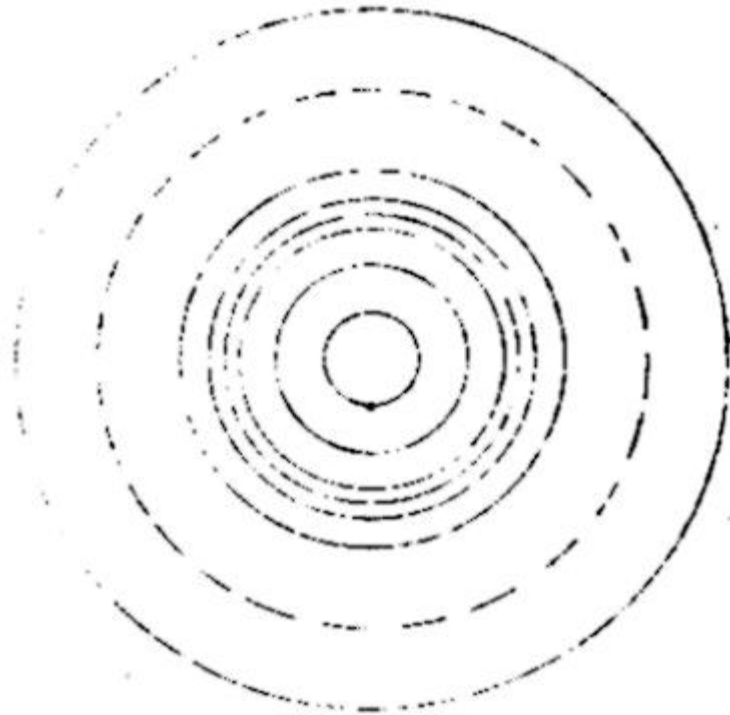
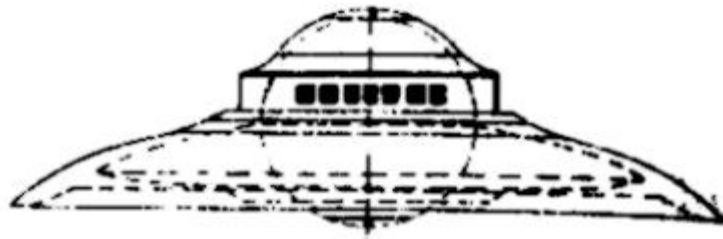

The THULE GESELLSHAFT

Extract from the book

SECRET SOCIETIES of jan van hilsing (pseudonym)

From page 167:

In 1917 the occultist BARON RUDOLF VON SEBOTTENDORF, the Gurdjeff disciple KARL HAUSHOFER, the ace pilot LOTHAR WAIZ, PRELATE GERNOT of the secret "Societas Templi Marcioni" (The Inheritors of the Knights Templar) and MARIA ORSIC, a transcendental medium from Zagreb met in Vienna. They all had extensively studied the "Golden Dawn", its teachings, rituals and especially its

knowledge about Asian secret lodges. Sebottendorf and Haushofer were experienced travellers of India and Tibet and much influenced by the teachings and myths of those places. During the First World War Karl Haushofer had made contacts with one of the most influential secret societies of Asia, the Tibetan Yellow Hats" (dGe-lugs-pa). This sect was formed in 1409 by the Buddhist reformer Tsong-kha-pa. Haushofer was initiated and swore to commit suicide should his *mission* fail. The contacts between Haushofer and the yellow Hats" led in the Twenties to the formation of Tibetan colonies in Germany.

The four young people hope that during these meetings in Vienna they would learn something about the secret revelatory texts of the **Knights Templar** and also about the secret fraternity DIE HERREN VOM SCHWARZEN STEIN ("The Lords of the Black Stone"). Prelate Gernot was of the "Inheritors of the Knights Templar", which to my knowledge are the only true Templar society. They are the descendants of the Templars of 1307 who passed on their secrets from father to son - until today. Prelate Gernot apparently told them about the advent of a new age - the change-over from the Age of Pisces to the Age of Aquarius.

They discussed that our solar year - according to the twelve revolutions of the moon - was divided into twelve months and thus the revolution of our sun around the great central sun (the **Black Sun** of ancient myths) was also divided into twelve parts. Together with the precession of the cone-shaped proper movement of the Earth due to the inclination of the axis this determines the length of the world age. Such a "cosmic month" is then 2,155 years, the "cosmic year" 25,860 years long. According to the Templars the next change is not just an ordinary change of the age, but also the end of a cosmic year and the start of an absolutely new one.

By completing the 25,860 years the Earth is changing from the age with the weakest (Pisces) to the age with the strongest radiation (Aquarius). Indo-Aryan definition call this the end of the Kali Yuga, the age of sin. All age changes have led to political, religious, social and also geological upheavals of great impact. The time of change-over from the old to the new age is called in Mesopotamian teachings the three "double steps of Marduk", of 168 years duration, at the mid-point of which the ILU ray, the Divine Ray, is expected to reach the Earth.

The Templars did careful calculations and concluded that February 4,1962 was the date the ray would reach Earth. This gave the mid-point of the 168 years change-over phase and the years 1934 and 1990 as other important dates.

The main part of the discussions dealt with the background of a section of the New Testament, Matthew 21:43. For there Jesus addressed the JEWS:

"Therefore I tell you that the kingdom of God will be taken away from you and given to a people who will produce its fruit."

The complete original text that is kept in the archives of the "Societas Ternph Marcioni" says it even more clearly. But the point is: In that text Jesus actually names the "people", He talks to Teutons serving in the Roman legion and he tells them that it is THEIR people that he had chosen. That was what Sebottendorf and his friends wanted to know for sure: That the Teutonic, i.e. the German, people was commissioned to form the realm of light upon Earth - in the "Land of the Midnight Mountain" (Germany). The place where the ray would meet the Earth was given as the Untersberg near Salzburg.

At the end of September 1917 Sebottendorf met with members of the "Lords of the Black Stone" at the Untersberg to receive the power of the "Black-Purple Stone" after which the secret society was named.

The "Lords of the Black Stone" who formed out of the Marcionite Templar societies in 1221 and were led by Hubertus Koch had set as their aim the fight against evil and the building of Christ's realm of light. This dark power they were to fight had revealed himself in the so-called Old Testament through Moses and other mediums as God, starting with the words by YHWH = JAHVEH - Jehovah to Abraham: "I am God Almighty!"

(Dette var en av de Lyransk/pleiadiske autorative ledere som hadde utviklede åndelige krefter, og som ble kjent som Ishwish'er - som betyr gud eller visdomskonger. De omtales også altså med betegnelsen JHWH, og sporene etter disse finnes i den jødiske bibel. Bare i den hebraiske delen av Bibelen, forekommer dette ordet nesten 7000 ganger! Deres åndskraft tillot dem å leve i årtusener, og de hersket over talløse sivilisasjoner - men dengang med brutal makt. Menneskene på Jorden var enda i høy grad instinktledet, og måtte som "flokkdyr" ledes av sterke ledere. R.Ø.anm.)

In Hebrew: "Ani ha El Shaddai", translated: I am El Shaddai - the "out-cast Archangel (Shaddai El) - Sheitan or Satan" (see the original translation of Genesis 17:1, e.g. in: The Bible, New International Version).

Sebottendorf clearly recognized: The Shaddai, the God of the Old Testament, is the destroyer, the antagonist of God. His followers therefore sought to destroy the Earth, Nature and humanity. And the followers were the believers in Mosaic Law, the Hebrews. (Remember the tenets of the Talmud!)

In the Gospel of John, 8:39-45, Jesus states this directly. There he addresses the Jews:
Abraham is our father,' they (the Jews) answered.

'If you were Abraham's children,' said Jesus, 'then you would do the things Abraham did. As it is, you are determined to kill me, a man who has told you the truth that I heard from God. Abraham did not do such things. You are doing the things your own father does.'

'We are not illegitimate children,' they protested. 'The only Father we have is God Himself'

Jesus said to them, 'If God were your Father, you would love me, for I came from God and now am here. I have not come on my own; but He sent me. Why is my language not clear to you? Because you are unable to hear what I say. You belong to your father, the devil, and you want to carry out your father's desire. He was a murderer from the beginning, not holding to the truth, for there is no truth in him. When he lies, he speaks his native language, for he is a liar and the father of lies. Yet because I tell the truth, you do not believe me!' (this is right according to the information on this stuff brought forth thorough the [pleiadian contact-team](#) - who informed Meier that the ancestors of "the jews" was procreated through the pleiadian scientist Semjasa - who was one of the subleaders of the powergreed leader ARUS - and therefor this group was given preferential treatment and guarded - also the reason why the "jews" are more intelligent than the average earth-man)

Today still many people naively ask: But why then did Hitler go against the Jews? I hope that the last few lines have shown you. In the eyes of the THULE-GESELLSCHAFT, from which later emerged the DAP (German Workers' Party), the NSDAP (National Socialist German Workers' Party), the SS (Schutzstaffel), the Jewish people who had been charged by the Old Testament god JAHVEH to "raise havoc on Earth" were the reason why the world was always caught up in war and discord.

The Thule people knew about the Jewish banking systems, i.e. Rothschild and allies, and the "Protocols of the Elders of Zion" and felt it was their task to fight the Jewish people, but especially their banking and lodge system, in accordance with the Revelation of Sahaja, and to erect the realm of light upon Earth.

Author's Comment:

As you can see, these people were just as incapable to remedy the cause as their Lord Jesus had told them how - to change the world with love for creation, for oneself and for the neighbour (and that neighbour can also be of another race or religion). But they had relinquished self-responsibility and gave it to a *guilty* one, a SATAN. Their hatred made them so blind that they never realized that they used the same weapons as the purportedly satanic god Jahveh they wanted to fight. They should have known though that one cannot achieve peace by war.

A circle formed around BARON RUDOLF VON SEBOTTENDORF that via the "Teutonic Order" in 1918 in Bad Aibling became the "THULE-GESELLSCHAFT".

The themes they tried to link to politics were scientific magic, astrology, occultism and Templar knowledge as well as "Golden Dawn" practices like Tantra, Yoga and Eastern meditation.

The Thule-Gesellschaft believed, following the Revelation of Isais, in a Coming Saviour (German: Heiland = the Holy One), the "Third Sargon" who would bring to Germany glory and a new Aryan culture. Dietrich Bronder ("Before Hitler Came") and E. R. Carmin ("Guru Hitler") named the leading members as follows:

1. Baron Rudolf von Sebottendorf, Grand Master of the Order
2. Guido von List, Master of the Order
3. Jörg Lanz von Liebenfels, Master of the Order
4. Adolf Hitler, "Führer", German Chancellor, SS Superior
5. Rudolf Hess, Vice Führer, and SS Obergruppenführer
6. Hermann Göring, Reichsmarschall and SS Obergruppenführer
7. Heinrich Himmler, Reichsführer SS and Reichsminister
8. Alfred Rosenberg, Reichsminister and NS-Reichsleiter
9. Hans Franck, Dr. Dr. h. c., NS-Reichsleiter and Governor General of Poland
10. Julius Streicher, SA-Obergruppenführer and Gauleiter of Franken
11. Karl Haushofer, Prof. Dr., Major General ret.
12. Gottfried Feder, Prof. Dr., Secretary of State ret.
13. Dietrich Eckart, Editor in Chief of the "Völkischer Beobachter"
14. Bernhard Stempfle, father confessor and confidant of Hitler
15. Theo Morell, personal physician of Hitler
16. Franz Gurtner, president of the police, Munich
17. Rudolf Steiner, founder of the antroposophic teaching
18. W. O. Schumann, Prof. Dr. at the Technical University Munich
19. Trebisch-Lincoln, occultist and traveller to the Himalayas
20. Countess Westrap

and many others

Later the Thule-Gesellschaft split in two, the esoterics (Greek: esoteris = the inner), among which counted Rudolf Steiner, and the exoterics (Greek: exoteris = the outer), who later were led by Hitler. The Thule-Gesellschaft in its inner core was peaceful in nature, besides knowing about the Illuminati and El Shaddai. It was Hitler who became more radical. When Hitler had taken over the NSDAP, he prohibited the Thule and the Vril Gesellschaften after they had helped him to his position. Towards the end of the war he contacted them again, especially the Vril-Gesellschaft, because of their advanced technology and their special contacts.

Some of the most important teachings influencing the Thule-Gesellschaft was the Aryo-Germanic construction of religion (Wihinei) by the philosopher Guido von List, the Glacial Cosmology by Hans Hørbiger and a leaning towards the anti-Old Testament early Christianity of the Marcionites. The innermost circle at any rate had vowed to fight World Judaism and Freemasonry and its lodges.

Some authors claim that there was also a completely different ideology of the Thule-Gesellschaft. I would like to share this with you, even if it can't be one hundred percent ascertained. The reader may judge.



An short history of "THULE"

"ULTIMA THULE" apparently was the capital city of the first continent peopled by Aryans. This was called HYPERBOREA and was older than Lemuna and Atlantis (see link to more on [this](#) here) (continents with advanced cultures since submerged). The Scandinavians have a tale of "Ultima Thule", the wonderful land in the high North, where the sun never sets and the ancestors of the Aryan race dwell.

Hyperborea was up in the North Sea and sank during an ice age. It is assumed that the Hyperboreans came from the solar system Aldebaran which is the main star in the constellation Taurus, and that they were about four metres tall, white, blond and blue eyed. They knew no war and were vegetarians (so was Hitler). According to alleged Thule texts they were technically very advanced and flew "Vril-ya", flying machines that today we call UFOs.

These flying disks were capable of levitation, extreme speeds and the manoeuvres known from today's UFOs due to two counter-rotating magnetic fields and they used the so-called Vril power as energy potential or fuel (Vril = ether, Od, Prana, Chi, Ki, cosmic force, Orgon..., but also from the academic "vri-IL" = as the highest deity = god-like), i.e. they take the energy from the Earth's magnetic field (free energy) like the "tachyon converter" of Captain Hans Coler.

When HYPERBOREA began to sink, the Hyperboreans are said to have burrowed (grave/borre) with huge machines - gigantic tunnels into the Earth's crust and settled under the Himalaya region. The subterranean realm is called AGHARTA and its capital SHAMBALLAH. The Persians call this land "Aryana", the land of origin of the Aryans.

Here we should mention that Karl Haushofer claimed that Thule was actually Atlantis and - contrary to all other researchers of Tibet and India - he said that the surviving Thule-Atlanteans were separated into two groups, a good one and an evil one. Those who called themselves after their oracle *Agharti* - were the good and settled in the Himalaya region, the evil ones were the *Shamballah* - who wanted to subjugate humanity and they went West. He maintained that the fight between the people of Agharta and Shamballah had been going on for thousands of years and that in the Third Reich, the Thule Gesellschaft as Agarthas representative -continued it against the representatives of Shamballah, the Freemasons and the Zionists. This perhaps was his mission.

The head of this subterranean region he said was Rigden Iyepo, the king of the world, with his representative upon the Earth's surface, the Dalai Lama. Haushofer was convinced that the land below the Himalayas was the birthplace of the Aryan race, which he claimed to have confirmed during his Tibet and India travels.

The symbol of Thule was the swastika counter clockwise. Tibetan lamas and the Dalai Lama personally testified that people from Agartha were still living today. The subterranean land that is anchored in almost all Eastern traditions has spread over the millennia under all of the Earth's surface with huge centres under the Sahara desert, the Matto Grosso and the Santa Catarina mountains in Brazil, Yucatan in Mexico, Mount Shasta in California, England, Egypt, Czechoslovakia...

It seems that Hitler especially sought to discover the entrances to the subterranean world *Agartha* and to get in contact with the descendants of the Aryan "God people" from Aldebaran-Hyperborea. In the myths and traditions of the subterranean world it is often said that the world's surface was yet to suffer a terrible world war (Third World War) which would though be ended by earthquakes, other natural disasters and a *switching of the poles* and the deaths therefrom of two thirds of humanity.

Time Travel Research Center © 2005 Cetin BAL - Turkey/Denizli

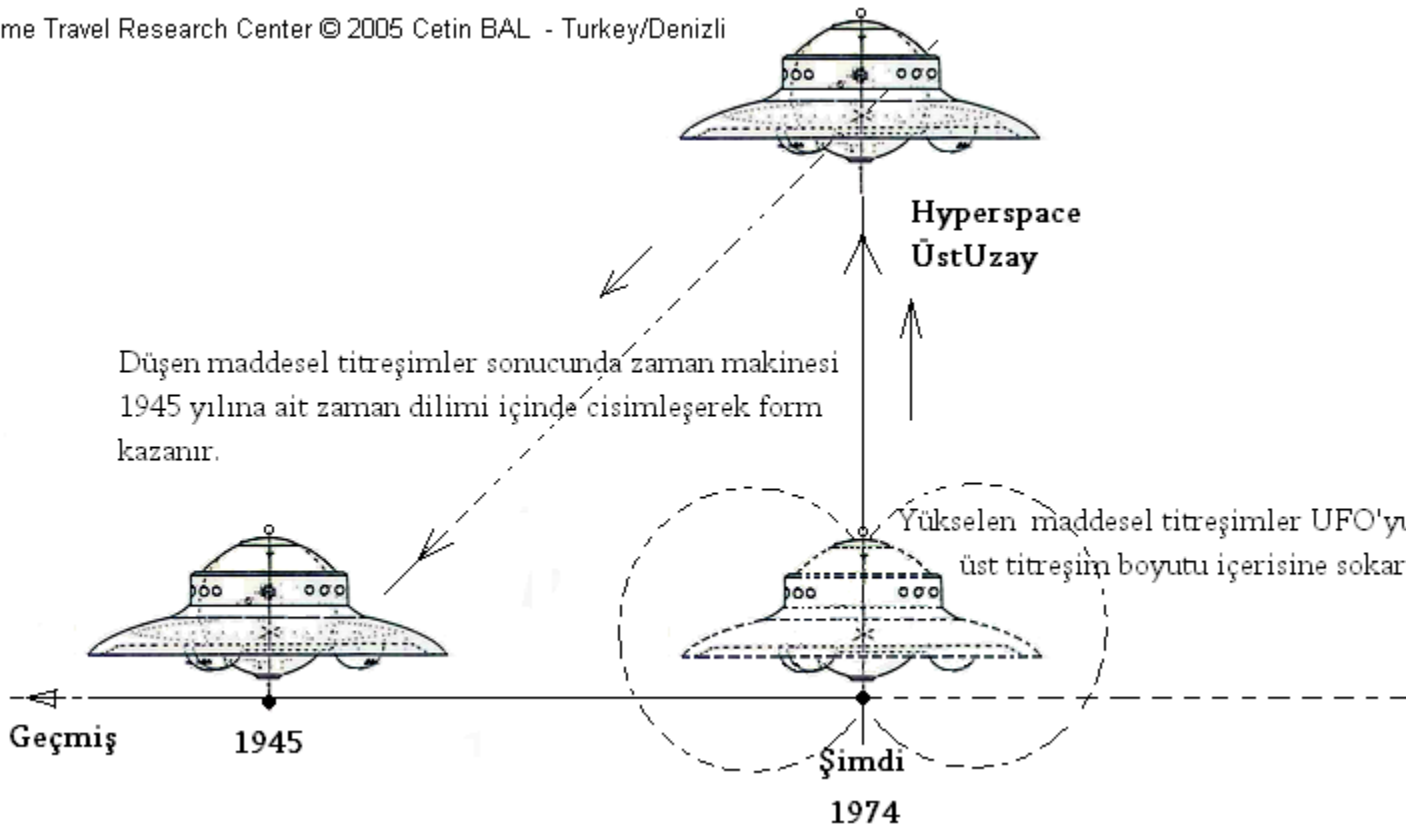

After this "last war" the several races of the inner Earth would reunite with the survivors on the surface and the thousand-year GOLDEN AGE (age of Aquarius) would be rung in. Hitler wanted to build an outer "Agartha" or "Aryana" with the Aryan master race, and Germany should be its home. During the existence of the "Third Reich" two large expeditions were sent by the SS to the Himalayas to find those entrances. Further expeditions searched in the Andes, the Matto Grosso

mountains in the North and the Santa Catarina mountains in the South of Brazil, in Czechoslovakia and parts of England.

Some authors claim that the Thule people believed that - quite independently of the subterranean tunnel and city system - the Earth was HOLLOW, with two great openings at the poles. Natural laws were quoted, "As above, so below". Since blood, body or egg cells, a comet or an atom all have a nucleus and a hollow space surrounding it that is enclosed by a "corona radiata", an envelope, and the actual "life" is taking place in the core, one has deduced that the Earth was built after the same principles. Druses confirmed this, as they were hollow and the "life", the minerals and crystals, were in the interior. (also the tibetan rampa described some trips into tunnels ending into the interior of earth - but those was sealed from inside - see link [here](#) and [here](#)).

Therefore the Earth also had to be hollow - apparently agreeing with the views of the Tibetan Lamas including the Dalai Lama - and had a nucleus, the *central sun* (also called the "Schwarze Sonne", the Black Sun) that gave the interior an even climate and permanent sunlight, corresponding in the microcosm to the central sun of the galaxy in the macrocosm.

They maintain that the actual life of our planet takes place in the interior - the master race lives inside and the mutants on the surface - and that this was also the reason why we wouldn't find any life upon other planets of our solar system, because their inhabitants live inside. The main entrances are at the North and South poles through which the central sun is shining and producing the aurora borealis. In the interior the land mass was exceeding the water mass. The polar explorer Olaf Jansen and others said that the water in the interior was fresh, which could explain why the ice of the Arctic and the Antarctic is made of freshwater, not salt water. It is interesting to note that this view of the make-up of the world is shared and supported by the polar explorers Cook, Peary, Amundsen, Nansen and Kane and, last but not least, Admiral E. Byrd. All had the same, strange experiences contradicting existing *scientific* theory:

All confirmed that after 76 gr latitude the winds became warmer, that birds flew north over the ice, that animals like foxes also went north, that they found coloured and grey snow which when thawed left coloured pollen or volcanic ash. The question arises: where do flower pollen or volcanic ash near the North Pole come from, as not a single volcano is marked on any of the accessible maps? Further some of the explorers found themselves in freshwater seas, and all say that at a time during their travels they had seen two suns. Mammoths were found whose flesh was still fresh and whose stomachs contained fresh grass.

If you are further interested in the hollow Earth and the experiences of the different explorers, some titles are listed under "Further Reading" at the back of this book.

The "Hollow Earth" theory has so far remained just a theory to the public, although some authors and explorers claim to have visited there and even - like Admiral E. Byrd - had taken numerous pictures. It cannot be denied that all the Arctic explorers had had extraordinary experiences that so far cannot be explained, which points to something strange happening there. But the theory that the Earth had a molten core has equally remained just a theory. The fact remains though that the subterranean man-made tunnel and cave systems do exist. They can be found in almost any country of the world and by the largely still existing light source (a greenish glow that gets brighter the deeper one enters the tunnels), by the smooth walls and the unknown machinery that was found in the Boynton Canyon in Sedona, Arizona, are witness to a technically advanced culture that existed millions of years before. Relevant literature is listed at the back.

The myths of a "Hollow Earth" were enough for the Thule people to go on to start a serious study of the phenomenon. Therefore there was at least one expedition to the Antarctic during World War Two. (Details follow).

To show that the story of the Aryan Hyperboreans was not entirely invented I would like to mention two examples: When the Spaniards under Pizarro came to South America in 1532, the natives called them "*vicarochas*" (white lords). According to their legends there was a master race of very tall white people who centuries before had descended in "flying disks" from heaven. They had long ruled in some of the towns and when they disappeared had promised to return. When the fair-skinned Spaniards arrived, the natives thought them to be the *vicarochas* coming back and therefore in the beginning willingly gave them their gold.

Similar occurrences took place when the first white travellers arrived in Tibet and other Himalayan regions. They were scrutinized (gransket) in astonishment by the Tibetans and asked why they came from *below* (the foot of the mountains) rather than from *above* as they usually did.

It is a pity that most Germans have never heard about these things, since the ideology of Nazi Germany was based on the El Shaddai theme and the resulting persecution of Jews, the Revelation of Isais, the knowledge of the Templars and possibly on the tales just told. All their actions including the Second World War were based thereupon. There are two possibilities to deal with this:

- 1 You think all the leaders of the "Third Reich" were mentally disturbed and drug addicts and you simply ignore all of this or
2. You try to find out whether perhaps something of all this is true after all.

But to find literature about this subject you should not look in so-called "free" Germany, for the Allies had cleaned up very thoroughly after the war!!!

Viktor Schaubberger's Repusline A & B (1940-1945)

Viktor Schaubberger, an Austrian forester who observed the effects of nature - especially of water, privately met Adolf Hitler in 1934 to discuss the fundamental principals of agriculture, forestry, and water engineering. While Hitler was impressed by Schaubberger's radical ideas for utilizing water power in new and dynamic ways, he was also displeased that Schaubberger was not willing to participate in work for the Third Reich. Subsequently and unfortunately for Schaubberger this meant that once Austria was annexed in 1938 and war broke out in 1939 the SS would come searching for him and his ideas based on his patents for an "air turbine" and "procedure for lifting liquids and gases" from 1935 and the "warm-cold" machine built for Siemens in 1937 but destroyed in an unauthorized test.



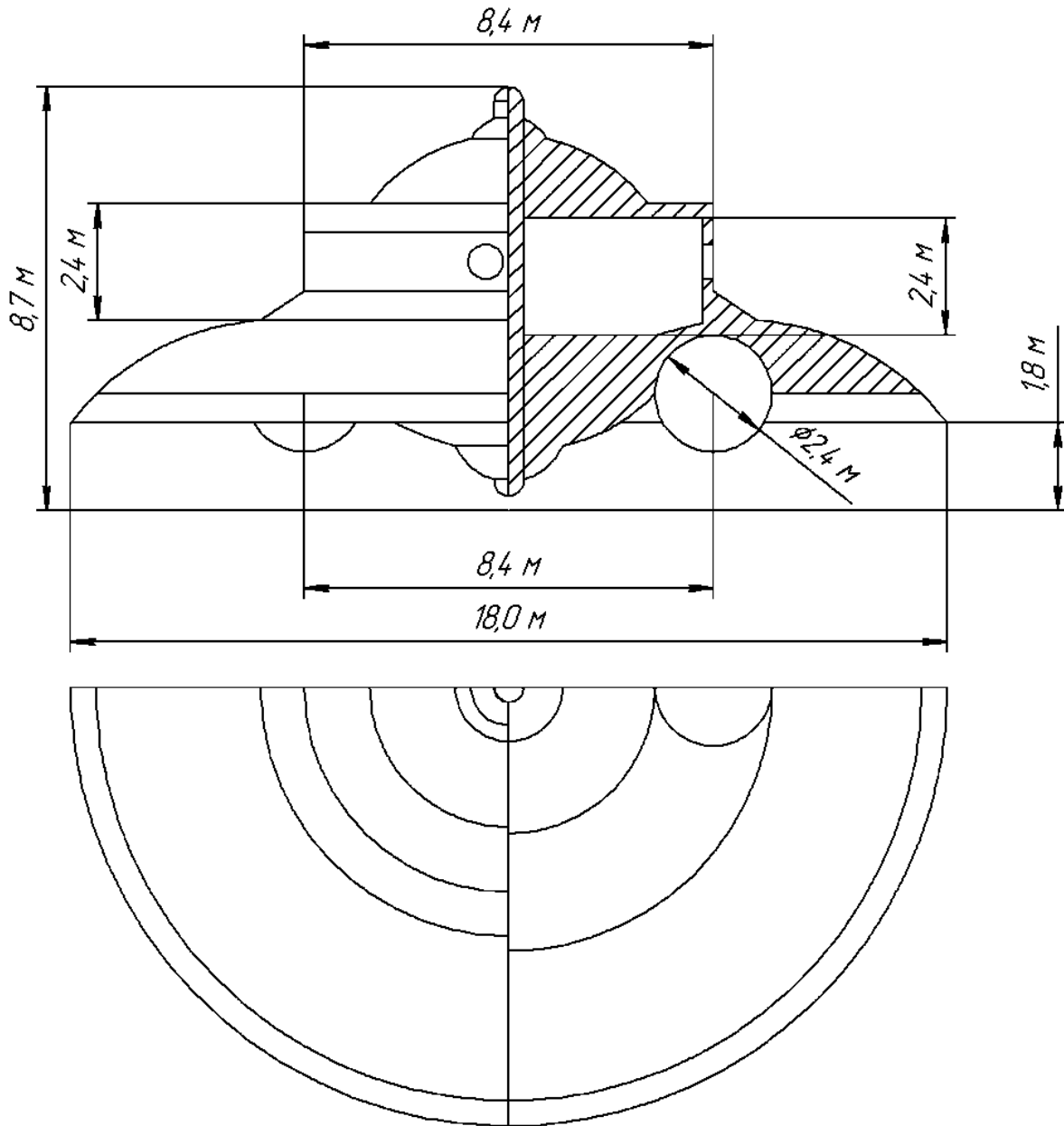

In 1940, Schauberger began construction of the Repulsin(e) discoid motor in Vienna with help of the Kertl company. He patented his idea on March 4, 1940 in Austria under patent 146,141. But very soon afterwards he was reported by the Viennese Association of Engineers to the SS who placed Schauberger in a mental hospital in Mauer-Ohling. Schauberger was then forced to work with Messerschmitt on liquid vortex cooling systems and Heinkel concerning applications of water towards aircraft engines. At this point Heinkel received reports on the early **Repulsin A**. At Mauthausen, under orders from Heinrich Himmler himself, Schauberger was to carry out research and development for the Third Reich war effort. He was given approximately 20-30 prisoner engineers to proceed with his research into what was termed "higher atomic energies". For this Schauberger was given special dispensations from the SS for both himself and fellow engineers.

The construction and perfection of the Repulsin A model discoid motor continued until one of the early test models was ready for a laboratory test that ended in disaster. The model was 2.4 meters in diameter with a small high-speed electric motor. Upon initial start-up the **Repulsin A** was set in motion violently and rose vertically, quickly hitting the ceiling of the laboratory, shattering to pieces. The SS were not pleased and even threatened Schauberger's life, suspecting deliberate sabotage. Replacement models were built, but by 1943 a more improved design, the **Repulsin B** model was constructed with the SS objective of developing this motor for an odd SS bio-submarine which Schauberger named the "Forelle" (Trout) due to its configuration of a fish with a gaping mouth!

The Repulsin models operated in the following way:

When the main electric engine is started, the ***Coanda effect begins to create a differential aerodynamic pressure between the outer and inner surface of the primary hull.*** At a higher speed, the vortex chamber becomes a type of high electrostatic generator due to the air particles, in high speed motion, acting as an electrical charge transporter. **The Repulsin A will begin to glow due to strong ionization effect of the air.** Now we have all the ingredients for a continuous and strong Aether flow along the main axis from the top to the bottom of the craft. ***The radial air pressure required for lifting 1 kg with the Coanda Effect is roughly 1.4 kg/cm².***



In the Repulsin B the vortex turbine has been *improved for increasing the "Implosion Effect" and thus the lifting force.* **In the Repulsin B the upper membrane is fixed and the lower rotates at high speed.** On the edge rim there are special shaped blades of boomerang configuration. There are 120 blades that are 3 degrees spaced around the rim. **The enhanced vortex turbine increases significantly the "implosion" effect in the vortex chamber.** This contributes to it being able to generate a stronger thrust than the centrifugal turbine used in the **Repulsin A.** By means of **suction screw-impeller (which revolved from the outside towards the inside along a cycloid, spiral space curve)** the same type of force is generated which creates twisters, cyclones, and typhoons through the effect of either suction or implosion.

Work on the Repulsin B continued in 1944 at the Technical College of Engineering at Rosenhugel in Vienna. Schauberger was finally released back to Leonstein, Austria that same year. It appears that the SS had discarded the idea of applying the Schauberger motor to a submarine when the benefits would greatly improve their work on the secret Flugkreisel which was taken from Rudolf Schriever back in 1941. **By 1943 the machine had flown but proved to be unstable.** The leader of the SS replacement team was Dr. Richard Miethe who proposed several Flugkreisel replacements with varied power plants, most of which relied on jets or rocket power, until it was learned that **Schauberger had engineered a type of turbine machine that would create an up-current of axially-spinning air so powerful that the up-current's drag force would speed the whole machine higher and higher into the air with a thrust equal to 10,000 hp simply by moving "air".** The turbine was considered a priority for flight development into a manned machine by the SS. It is speculated that Miethe's final design built in Breslau that **flew in 1944 was an enlarged manned Repulsin-type craft.**

Schauberger meanwhile had his remaining discoid motors confiscated by the Russians and Americans at the end of the war. While AVRO Canada approached Schauberger for disc development along with a team led by Dr. Richard Miethe, Schauberger refused and instead devoted his remaining life to peaceful uses of his vortex technology by working on various civilian projects which included generators, and both water and air purification systems. In the late 1950s Schauberger visited the US and was again pressured into working on military disc designs. **The pressure was even greater due to the fact that Schauberger's original Repulsin motors had fallen into Russian hands and the US suspected Schauberger's technology would appear as a nuclear armed aircraft over US soil.** Schauberger refused to participate again but had his designs forcibly signed over to a powerful US consortium. He returned to Austria and died there 5 months later having been robbed of everything. **A tragic end of life for the man everyone named the "Water Wizard".** Compliments: **Rob Arndt.**

Antriebstechnische Werkstätten / Arado, VR ("Vril") 7, Brandenburg 1944

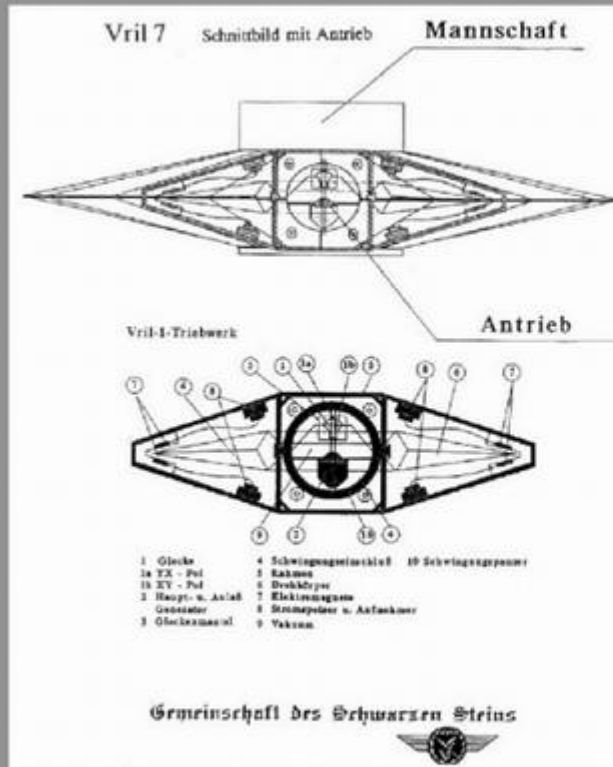

Rekonstruktionsversuch

Durchmesser des Geräts ca. 45 m



VR 7
Von allen mitunter besprochenen diskusförmigen deutschen Fluggeräten aus der Zeit des Zweiten Weltkriegs dürfte VR 7 am ehesten dasjenige Gerät gewesen sein, das bis zur Einsatzreife fertiggestellt und auch noch mit neuartiger Bewaffnung bestückt wurde.



VR ("Vril") 7 auf dem Versuchsgelände in Brandenburg 1944.

Das Antriebsverfahren dieser Geräte ist nach wie vor unergründet, obwohl es tatsächlich funktioniert zu haben scheint. Sicher bekannt ist lediglich, dass die Ausnutzung von "Schwingungsaffinität" eine maßgebende Rolle spielte. Es handelte sich also wohl nicht nur um eine reine Elektrogravitationstechnologie.

"VRIL-ODIN"

Vereinfachte Planskizze (Querschnitt) eines Elektrogravitationsraumschiffes nach dem Dynamoprinzip

- α) Kommando- und Steuerraum des Raumschiffes
- β) Mannschaftsräume
- I Vertikaler Magnetring
- II Energiespeicher
- III Dreiphasenspulen
- IV Erregerspule
- V Drei Kondensatoren
- VI Ausgangsspule
- VII Ferritring
- VIII Barium-Strontium-Titanat-Ring

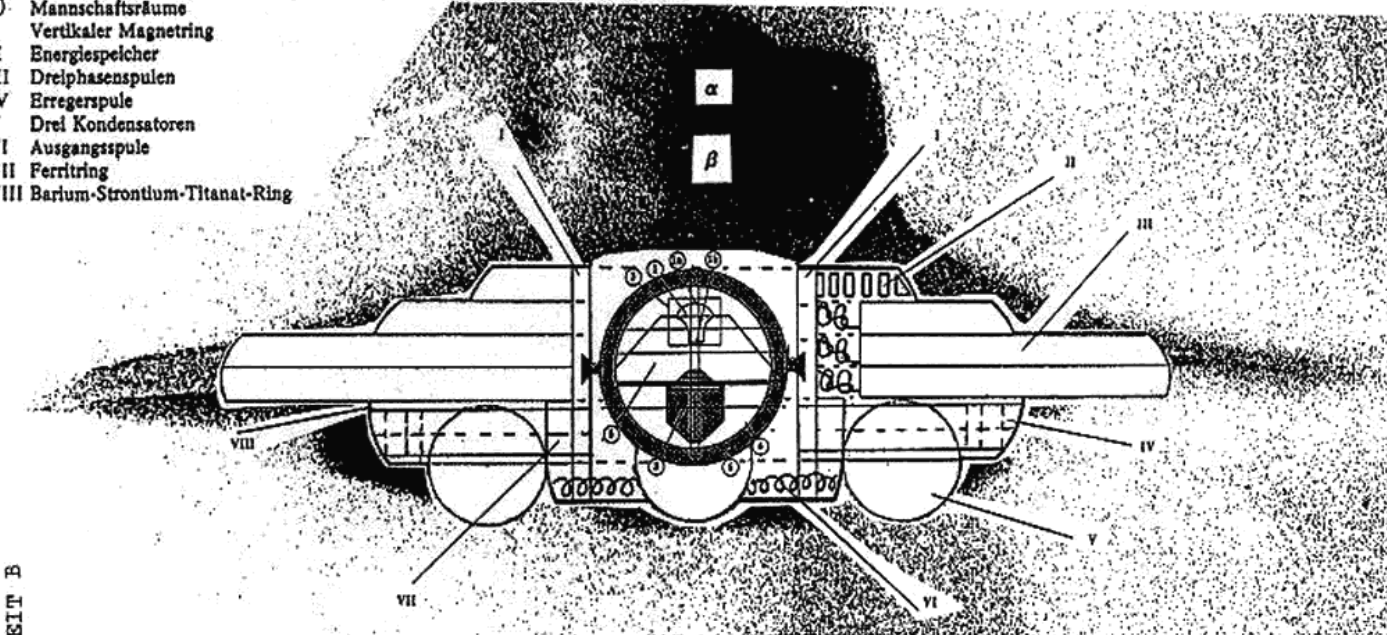

MÖGLICHKEIT B

- 1 Glocke
- 1a YX - Pol
- 1b XY - Pol
- 2 Haupt- u. Anlaß Generator
- 3 Glockenmantel
- 4 Schwingungsanschluß
- 5 Vakuum
- 6 Schwingungspanzer

So, just what the happened to these flying machines after the war???

That is indeed a tough question to answer. It cannot be excluded that a small number of these craft/disks might have been built. The several photographs of UFOs that emerged after 1945 with the typical features of these German constructions suggest as much. Some say that some of them had been sunk into the Austrian Mondsee, others maintain that they were flown to South America or brought there in parts. It is certain though that if the crafts didn't get to South America, the plans that did allowed for new ones to be built and flown there, for an important part had been used in 1983 in the "Phoenix Project", the follow-on project of the 1943 "Philadelphia Experiment". This was a teleportation, materialization and time travel experiment of the U.S. Navy that was more successful than you could imagine in your wildest dreams. There is enough material for another book, but it does not fit too well into our subject here. It all makes sense.



As far back as 1938, a German expedition to the Antarctic was made with the aircraft carrier Schwabenland (Swabia). 600,000 km² of an ice-free area with lakes and mountains were declared German territory, the "Neuschwabenland" (New Swabia). Whole fleets of submarines of the 21 and 23 series were later headed towards Neuschwabenland. *Today about one hundred German submarines are still unaccounted for, some equipped with the Walter snorkel, a device that allowed them to stay submerged for several weeks, and it can be assumed that they fled to Neuschwabenland with the dismantled flying disks or at least the construction plans.* Again it must be assumed that since the test flights had been very successful some so-called flying saucers have flown directly there at the end of the war.

There is the question raised as to why in 1947, Admiral E. Byrd led an invasion of the Antarctic, why he had 4,000 soldiers, a man-of-war, a fully equipped aircraft carrier and a functioning supply system at his command if it was a mere expedition? He had been given eight months for the exercise, but they had to stop after eight weeks and high losses of planes undisclosed even today. What had happened? Later Admiral Byrd spoke to the press: ***"It is the bitter reality that in the case of a new war, one had to expect attacks by planes that could fly from Pole to Pole."*** Further he added that there was an advanced civilization down there that used their excellent technologies together with the SS. Is this report true? Who really can answer that question?!



Norbert-Jurgen Ratthofer writes about the whereabouts of the Haunebu developments in his book **"Zeitmaschinen" . Time Machines:** *"The Haunebu I, II and III space gyros and the VRIL I space flying disk had disappeared after May 1945... It is very interesting to note in this context that after its nineteenth test flight, the German Haunebu III is said to have taken off on April 21, 1945, from Neuschwabenland, a vast, officially German territory in the Eastern Antarctic, for an expedition to Mars, about which there is nothing further known. One year later, in 1946, the many sightings that suddenly occurred in Scandinavia of shining objects of unknown and definitely artificial origin caused a great stir among the*

Allies in East and West. Again one year later, in 1947, and well into the Fifties, a rising number of shining unknown flying objects, doubtlessly steered by intelligent beings, mostly round, disk- or bell-shaped, sometimes cigar-shaped, so-called UFOs appeared over North America." Today, we simply refer to flying saucers as UFO's. It is also true today that making mention of seeing an actual UFO is almost an act of ridicule, and throws serious doubt as to the person's credibility.



Good photographic material proves that the flying saucers had been sighted often since 1945. In a significantly high percentage of the cases where personal contacts with the people from the so-called UFOs was made, were with especially beautiful Aryan types, blond and blue-eyed and that they either spoke fluent German or another language with a German accent (reference: the Adamski case of 1952, the Cedric Allingham case of 1954 and the Howard Menger case of 1956). It is further said that color photographs taken by a night guard in West Germany in the Seventies exist of a landed and restarted flying disk that had both a knight's cross and a swastika on its hull.



The flying machines are well documented in photographs and films. There is the 60 minutes documentary "**UFO - Secrets of the Third Reich**". The American, Vladimir Terziski gave a three-hour speech at the September 1991 UFO conference in Phoenix, Arizona, where he showed slides of German saucers, construction plans and subterranean German bases. Also of interest are the book by the Italian air force commander Renato Vesco and the book by Rudolf Lusar "Die deutschen Waffen und Geheimwaffen des Zweiten Weltkrieges und ihre Weiterentwicklung" (The German Arms and Secret Weapons of the Second World War and Their Development), J. F. Lehmanns Verlag, Munich 1971. Also, we have the preceding articles from Author Rob Arndt. Makes ya wonder, doesn't it?

For the reader: "Ultima Thule" apparently was the capital city of the first continent peopled by Aryans. The Scandinavians have a tale of "Ultima Thule", the wonderful land in the high North, where the sun never sets and the ancestors of the Aryan race dwell. Hyperborea was up in the North Sea and sank during an ice age. According to alleged Thule texts they were technically very advanced and flew "Vril-ya", flying machines that today we call UFOs.

These flying disks were capable of levitation, extreme speeds and the maneuvers known from today's UFOs due to two counter-rotating magnetic fields and they used the so-called Vril power as energy potential or fuel (Vril = ether, Od, Prana, Chi, Ki, cosmic force, Orgon..., but also from the academic "vri-IL" = as the highest deity = god-like), *i.e. they take the energy from the Earth's magnetic field (free energy) so the story goes...or does it?! (Click [To continue](#))*

Why have only few people heard of these things, or of the developments of [Nikola Tesla](#), and [Viktor Schauburger](#) among which were free energy machines, energy

transfer without cables, antigravitation and the changing of the weather by the aimed use of "standing waves"? What consequences would the knowledge about free energy forms and about the use of flying saucers, which only use a magnetic field for an energy source, have? Especially if every citizen would have access to it, for their cars for example? No more "Fill'er up!" No pollutants, no pollution of the environment. No nuclear power stations any more, people could no longer be kept locked within the boundaries of a country, and we all would have more free time because we wouldn't have to work to pay for heating, petrol and electricity (in this time one could think a lot, perhaps about the meaning of life). ***And these energy forms exist! The have been existing for at least ninety years and have been kept secret all this time. Why were they kept secret?***

I leave it to the reader to ascertain the truth, if any, from this document. I find the information on **Viktor Schauberger** during the WWII era simply fascinating. Of course, a picture is worth a thousand words, and boy oh boy, do those pictures resemble Schauberger's Repulsine! The rest, take it for what it's worth...interesting reading, although no documented scientific facts can be ascertained.

Some of this information leaves one wondering what the heck is really flying around out there...are the UFO's that we have reports of seeing, even to this day, the remnants of this super-secret technology?! If so, then why are they only seen on rare occasions? One would think that if any country had this amazing technology at their disposal, that it would be implemented for the benefit of mankind. Even from just the standpoint of big-business and/or greed, the entity holding this technology would revolutionize transportation as we know it. ***Just ramblings from a very tired brain...time to go to sleep and dream of UFO's and of alien abductions, hopefully from a race of young, beautiful, voluptuous and sex-starved blond women. LOL. Hey! A guy's allowed to dream, right?! I just had to end with a joke, didn't I...***

German Haunebu II in action.



RFZ / Haunebu

Under the leadership of Dr W.O. Schumann, the first round experimental flying machine, the 'RFZ 1' or 'Haunebu ' was developed on the grounds of the aircraft factory Arado in Brandenburg. In its first flight it rose vertically to around 60 metres, then wobbled and danced in the air for minutes. The pilot Lothar Waiz just managed somehow to bring it down to the ground, jump out and run away before it began spinning like a top, turned over and literally ripped into peices. In 1934 another prototype was ready, the 'RFZ 2', this time with a magnetic field impulse steering unit. It had a diametre of five metres and with rising speed the visible contours became blurred and the aircraft showed the colours of red, orange, yellow green, white, blue or purple depending on the drive setting. This craft made its remarkable debut during the "Battle of Britain" in 1941 when it was used as a transatlantic reconnaissance craft because the standard German fighters had insufficient range. It could not be used as a fighter craft as its impulse steering only allowed changes in direction at 90, 45 and 22.5 degrees.

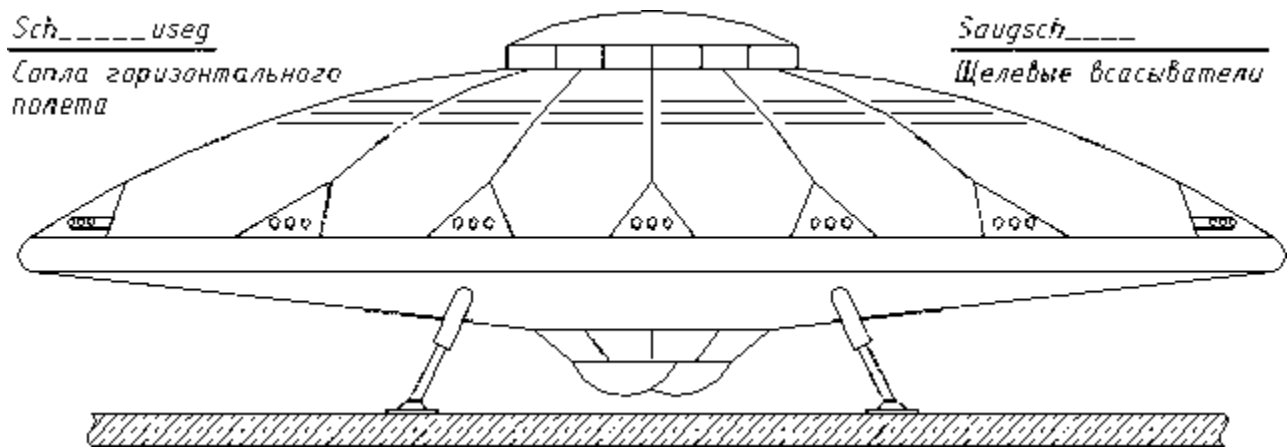

TULE Y VRIL

El año 1.919 se fundó en Alemania la sociedad secreta, Haushoffer, fundador de la Sociedad de *Thule*, que fue el lugar donde se conocieron muchos de los jefes alemanes, era un personaje que influyó en mucho de los diseños de Hitler. A este individuo se le debe la elección de la esvástica como símbolo máximo del nazismo. Se eligió una esvástica colocada detrás de una reluciente espada dispuesta verticalmente:

El nombre de "*Thule*" fue elegido en recuerdo del legendario (y para ellos existente) reino de *Thule*, que es simple y llanamente otro nombre para designar la legendaria Atlantis, pensaba que en el desierto de Gobi había existido una avanzada civilización, destruida por una gran catástrofe. Sus habitantes habían tenido que emigrar al Norte de Europa y otros hacia el Cáucaso. Estos habitantes de esta civilización destruida eran la raza primigenia de la humanidad, o sea los primeros arios puros. Su ideal era retornar a los orígenes y realizar las correspondientes conquistas para hacer renacer esta civilización, tronco inicial ario. Sus creencias lo llevaron a tener un conocimiento y contacto bastante estrecho con colonias hindúes y sobre todo con ciertos círculos tibetanos que tenían una visión muy próxima a sus principios. *THULE*, la cual se ramificó por todo el País. La central de la sociedad se encontraba en Munich. Gran número de miembros de la sociedad se alzaron en clara oposición contra la República Socialista de Baviera. Fundaron un partido político y el año 1.921 nombraron un portavoz político que fue Adolf Hitler. Un joven conocido por sus creencias ocultistas.

Llamo la atención para lo que escribió *TREVOR RAVENSCROFT* en el libro "*The Spear of Destiny*" ("Trazar el Destino"), y que años más tarde fue consejero del Primer Ministro inglés *WINSTON CHURCHILL*, que "...a los veinte años Hitler ya era un discípulo del ocultismo y del misticismo intentando llegar a través de drogas, a estados de conciencia superiores..."

El plan de Hitler de fundar un imperio milenario que le fue inspirado por miembros de la sociedad *-THULE*. Las ambiciones políticas de la sociedad generaron la formación de pequeños grupos independientes uno de los cuales fue la sociedad "*Hermanas de la luz*" llamada internamente –



A finales de 1.919 un selecto grupo compuesto por miembros de la sociedad *-THULE* y *VRIL* -, celebraron una reunión en una antigua masía. Llevó la voz cantante el Doctor Shuman, su especialidad eran las energías alternativas. Presidió la reunión la médium María Ostiz, también estaba presente otra médium, la joven Sira de 18 años. María Ostiz mostró unos textos que según ella había recibido de unos espíritus de Aldebarán –

Uno estaba escrito en idioma Sumerio (Antiguo egipcio) y el otro estaba cifrado en el código secreto de la Orden Templaria

Ambos textos fueron traducidos, eran planes para el desarrollo de una tecnología avanzada que permitiría el poder llegar a las estrellas.

Situación de Aldebarán

Mitología Germánica y Templaria de Tule y Viril

A partir de estos momentos los miembros de la sociedad - *VRIL*, se consagraron a la realización de una de las ideas que nunca jamás habría podido concebir la mente humana.- La propulsión por levitación -.

Después de la llegada al poder del partido Nacional Socialista. Las sociedades ocultistas pasaron a la clandestinidad. La sociedad *THULE* creó en el interior de la "SS" una organización secreta llamada –

La sociedad *VRIL* continuó sus investigaciones científicas, por lo que parece ser, que esta sociedad a mediados del año 1.934 creó su primera nave circular experimental propulsada por energía antigravitatoria. La "*RFZ-1*". Los responsables de su construcción fueron el profesor Shuman y un ingeniero de vuelo.

En Junio de 1934 *VICTOR SCHAUBERGER* fue invitado por Hitler y otros elementos de *VRIL*, para trabajar en aquella organización secreta por forma a poder desarrollar una máquina voladora que pudiera superar los límites del sistema solar. *VICTOR SCHAUBERGER* juntamente con el *Dr. SCHUMANN* ya referido terminaron, al finales del año de 1934, la construcción de un nuevo artefacto en forma de disco a que llamaron *RFZ 2* cuyo principio de funcionamiento era similar al que ya habían testado, pero más mejorado. Usando un motor *VRIL* (conocido por *SSM-L*, esto es, *Schumann SM-Levigator*) la máquina, con 5 metros de diámetro, generaba un campo electromagnético que hacía con que se moviera con facilidad, cambiando de color cada vez que su velocidad oscilaba. **Con un sistema de propulsión muy mejorado y por primera vez un sistema de dirección por impulsión magnética.** Tenía unos cinco metros de diámetro, a más, poseía una de las características peculiares de los Ovnis; desaparición óptica de su entorno a causa de su aceleración y variación de su color según el nivel de su potencia, rojo, naranja, amarillo, verde, azul, blanco o violeta. A pesar de su sofisticación técnica las naves circulares llamaron muy poca la atención a los políticos de aquella época.

La sociedad -Sol Negro vio los resultados obtenidos por la sociedad - *VRIL* y empezó la fabricación de su propia nave circular. A finales de 1.938 y habiendo

combinado varias tecnologías, entre ellas la de los motores construidos por la sociedad - *VRIL*, fabricaron una nave circular de reducidas dimensiones propulsada por hélices, la "*RFZ-4*".

El año 1.939 la sociedad -*Sol Negro* ya había construido otra nave circular la "*RFZ-5*" la primera gran nave espacial de 26 metros de diámetro y 9 metros de altura con el nombre de - *Haunebu I*-. El primer vuelo de esta nave se desarrollo bajo fuertes medidas de seguridad en el mes de Agosto de 1.939.

Plano Haunebu I SS y ensayo RFZ Haunebu

En el mes de Julio del año 1.942 se empezó a hablar de una nave circular de ascensión vertical propulsada a reacción, a finales de este mes se hicieron los ensayos prácticos en el mar báltico. En el primer vuelo de prueba alcanzo a una altura de 23.800 metros y en su segunda elevación alcanzo los 24.200 metros.

En el invierno del año 1.942 una nueva nave circular atravesó el campo de pruebas de la sociedad *VRIL*, se la llamo la "*VRIL -1*".

Con un solo tripulante y once metros de diámetro, estaba equipada con dos cañones *CMK 108*, calibre 300 y dos ametralladoras *MG 17*. Al mismo tiempo que se estaba probando esta nave. Se intentaron hacer contactos sobrenaturales y ya tenían los planos para la construcción de una nave mucho más grande la "*VRIL -7*".

Modelos y Prototipos RFZ Haunebu y Vril

A finales del año 1.942 el departamento de investigación de la "*SS*" comenzó a trabajar en una versión más sofisticada del *Haunebu I*. El *Haunebu II*, tenía 31 metros de diámetro y 11 de altura. Su velocidad en vuelo tenía que ser de 6.000 kilómetros hora dentro de la atmósfera terrestre y se creía que podría viajar por el espacio exterior. La "*SS*" aun tenía planes mucho más atrevidos, habían diseñado una nave la *Haunebu III* de 120 metros de diámetro, e incluso diseñaron una estación espacial gigante a la cual llamaron "*Maquina Andrómeda*" su peso era de 100 toneladas y 139 metros de largo, parece ser que el peso no les era problema para ponerla en órbita.

ANDROMEDA-GERÄT

E-V, 2. Dez. 44

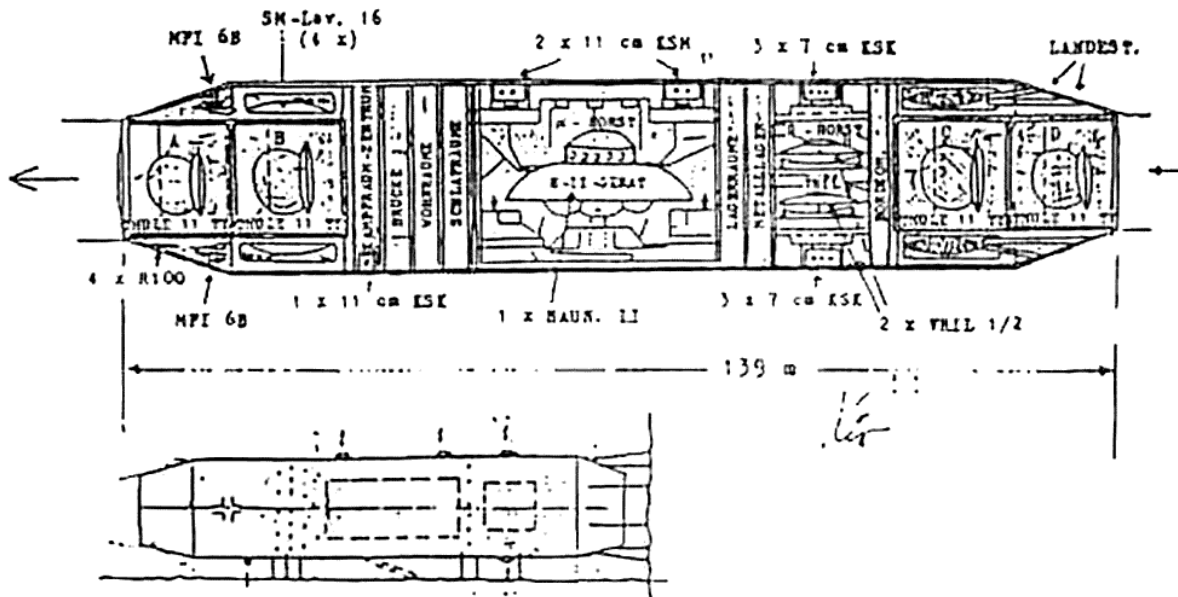

BEWAFFNETTES TRÄGER- UND LANDUNGSGERÄT ANDROMEDA-GERÄT:

Länge : 139 Meter

Durchmesser : 30 Meter (in der Mitte, erweitert)

Antrieb : 4 x Thilo-Fachmotoren II, 4 x Strömungs-Luftstrahler 16
(gepanzert)

From Reichs-German secret SS archives

Planos y Prototipos

ANDROMEDA GERAT > RFZ HAUNEBU >

HAUNEBU II (DoStra) >

HAUNEBU III >

Los días 3 y 4 de Enero de 1.944 Adolfo Hitler se reunió con los miembros de la sociedad VRIL para abordar el gran proyecto VRIL, el lanzamiento de una enorme nave espacial a través de un canal dimensional, llamado en el argot científico “agujero de gusano” un espacio franco a la velocidad de la luz hacia el Universo...

*Plano Proyecto Espacio Franco “Agujero de Gusano” hasta Aldebarán
Prototipos*



DAS "THULE-TRIEBWERK"

Im Wettbewerb mit dem Vril - Triebwerk - aber sicherlich in einem kameradschaftlichen Wettbewerb mit Erfahrungsaustausch - entwickelte die von den Thule - Leuten ins Leben gerufene "esoterische" SS-Formation "Schwarze Sonne" (später SS-E-IV u. SS-E-V) ebenfalls ein unkonventionelles Antriebsaggregat: Das "Thule - Triebwerk" - später sollte es die Bezeichnung "Thule - Tachyonator" erhalten.

Anfangs stand diese Entwicklung aber sicherlich nicht in Konkurrenz zu den Vril - Triebwerken Vielmehr war das Ziel, Deutschland eine rohstoff - unabhängige

Energiequelle zu schaffen. Deutschland war ja weitgehend vom Rohöl aus dem Ausland abhängig. Die Benzingewinnung aus Braunkohle stellte bereits einen Schritt in Richtung Unabhängigkeit vom Öl dar - jedoch reichte das bei weitem noch nicht aus. Im übrigen ging es um die weltanschaulich begründete Idee der "gottigen Kraftquelle". - Viele Gedanken, die in gewisser Weise heute hochaktuell wirken!

Trotz aller anderen Schwierigkeiten und der gewaltigen zahlenmäßigen Übermacht des Gegners kann wohl gesagt werden, daß Deutschland den Krieg insbesondere an der "Rohstoff - Front" verloren hat.

Es waren also volkswirtschaftliche Überlegungen, die zum Thule - Triebwerk führten. Hätte die Erzeugung von Flugscheiben im Vordergrund gestanden, so wären diese vermutlich schon 1943 verfügbar gewesen. Denn bereits 1941 flog das "Haunebu 1". Wenn die Informationen zutreffend sind, ging dieses große Rundflugzeug bei einem Aufklärungsflug über der Irischen See verloren.

Das Hauptaugenmerk der SS-E-IV dürfte aber noch lange Zeit über weniger den Flugscheiben als der Energiequelle an sich gegolten haben.

So kam es erst verhältnismäßig spät zum gezielten Flugscheibenbau seitens der "Schwarzen Sonne" - wahrscheinlich erst, als man schon nach allerletzten Möglichkeiten suchen mußte.

Retention gas storage
VERY SECRET

THIS DOCUMENT IS VERY CLASSIFIED. IF PLANTER ORIGIN IS KNOWN BY, IT MUST BE KEPT SECRET AND NOT DISCLOSED TO ANY OTHER PERSON UNLESS THE DISCLOSURE IS NECESSARY FOR THE PROSECUTION OF THE CASE.

- Classification (Security level) [redacted]
- Classification (Security level) [redacted]

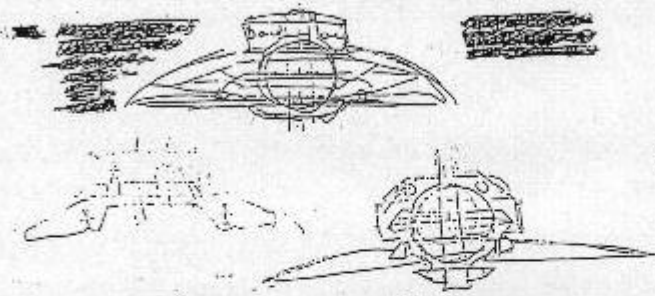

Vorbericht
In, über
Lokation der
500 ist die
gerade die
tritt zu
haben die
gerade, die
von, so ist
"Struktur" ist.

D. I. I. (U. I.)
Information Report

DEUTSCHES ORIGINAL-PAPIER "HAUNEBU 1"

MITTELSCHWERER BEWAFFNETER FLÜGGERZEUG, TYPE "HAUNEBU I"

- Durchmesser: 25 Meter
- Antrieb: Duple-Tachycastor-17b
- Steuerung: [redacted]
- Geschwindigkeit: 4800 Kilow. p. Std. (rechnerisch bis 17000)
- Reichweite in Flugzeit: 18 Stunden
- Bewaffnung: 2 x 500 mm in Drehturm "M" 4 x M 100, stark nach vorne
- Außenpanzerung: Doppelt
- Besatzung: 8 Mann
- Wartzeit: 30 Minuten
- Stillstandszeit: 0 Minuten
- Allgemeine Flugfähigkeit: Tag wie Nacht
- Grundsätzliche Einsatzmöglichkeit: 60 %
- Frontverfügbarkeit: Nicht vor Jahresende 44

Bemerkung: Haunebu II mit Konzentration auf bereits im Versuch stehende Haunebu II für einvoller als an beiden Typen parallel weiterzuarbeiten. Haunebu II verspricht entscheidende Verbesserungen in nahezu allen Punkten: Höhere Herstellungskosten scheinen gerechtfertigt - besonders mit Blick auf Führer-Sonderbefehl, Flugkreisel betreffend.

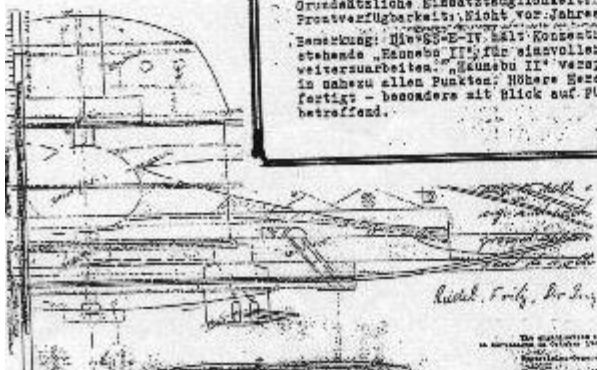

Richard F. Wolf, Dr. Ing.

Das Dokument ist
in der Anlage zu
[redacted]
[redacted]

Die Briten verfügten frühzeitig - nämlich schon ab 1941 über Informationen (durch Verrat oder Spionage), die sie offenbar zunächst nicht ernstnahmen.

RFZ 2

On June 1934 VICTOR SCHAUBERGER was invited by Hitler and other members of VRIL society, to work with them to develop a flying machine that could fly and jump the limits of solar system. At its book "The Spear of Destiny", TREVOR

RAVENSCROFT, describes "...with twenty years age Hitler was already a adept of the concealed and the mysterious in trying amount to right through drugs, higher consciousness estates..."; In those days that secret society Hitler, created a special group designated for SS "SCHWARZE SONNE" (Black Sun) of which left emissaries for Tibete, with some frequency whose primordial subject was it of they know the techniques of the meditation for communication with extraterrestrial entities. This fact came to confirm when Soviet soldiers found in Berlin on April 25, 1945 the bodies of 6 monks of Tibet, in circle. Contained this small parenthesis, retake. VICTOR SCHAUBERGER together with the Dr. SCHUMANN already, previously referred, they got in the ends of that year of 1934 has just built a new object in disk form, the one that they designated for RFZ 2 whose operation beginning was already previously identical to the tested but improved. Using a propeller VRIL (also known by SSM-L, that is Schumann SM-Levigator) the machine, with 5 diameter meters, it generated a electromagnetic field that moved easily, alternating of color every time that its speed oscillated.

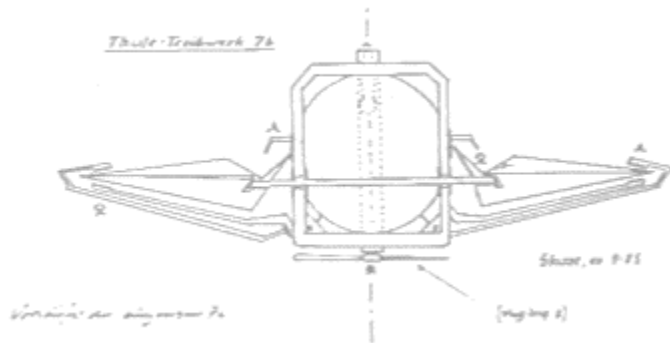

Eine Risszeichnung des Vril Triebwerk-Testgerätes, ohne die Verkleidung.
(Hier stimmt der Grössenvergleich.)



Haunebu II 1944



Haunebu III, Dmr. über 70 m, rechts am Bildrand ein Düsenjäger, halbrechts hinten im Hangar ei



Mehrere Haunebu III im Testflug, begleitet von mehreren Nurflüglern



Computerunterstützte Illustration Haunebu III

The Andromeda Machine

At the end of the war the SS constructed the Andromeda Machine, a UFO space station.

It employed the Vrill Gravitation System.

UFO's and Suppressed German Technology

A detailed expose of the Suppressed German Technology including: **Weather Control, Time Travel, Anti-Gravity, Virus Creation, UFO's, and Alien collaborations.** After looking a this Rare Video you will know that...

...We are not alone!



Part 1

According to **Billy Meier**, there are **1,600,000 races found in the Pleiadian travels**. They (the Pleiadians) have 1,600 Anti-Gravity technologies, and there are over 700,000 x (10 to the power of 10) galaxies that exist according to contactee Billy Meier (that's 7,000,000,000,000,000 galaxies!). There are 7.5 billion inhabited planets.

When the tabloids debunk something, then you know it is important. The reason is that the tabloids are known to "exaggerate the truth", and so they basically can print anything.

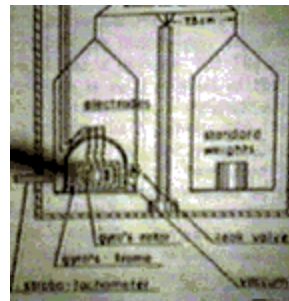
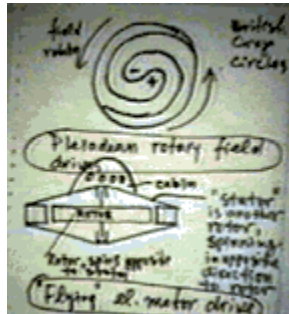
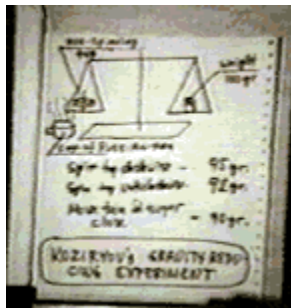

What the tabloids say will not affect the regulation of the 'Controllers' of our country. *So when they say something, it may very well be true, but written in a fashion that is acceptable to societies 'comic' humor.*

The Government has been experimenting with **weather control**, **time travel**, and **antigravity** for many years. **Alien visitations are common place.** Just because you don't see them, that doesn't mean that they are not there - It simply means that you did not see them! They are very selective in who they choose to see them.

NAZI UFOS

& the ILLUMINATI CONSPIRACY

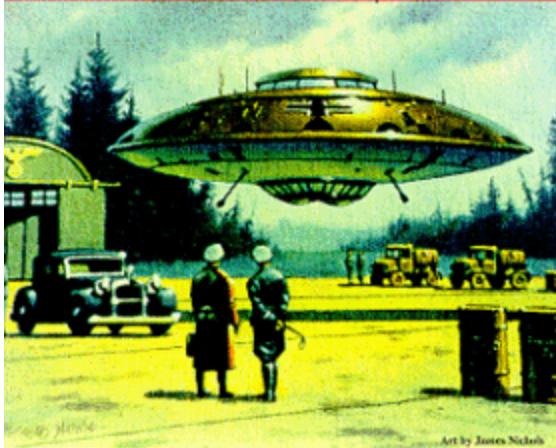

as told by **VLADIMIR TERZISKI**

WARNING

This video contains weird science! Some of the stories related may be fact, speculation or just tall tales. Underground Video® will not be responsible for any headaches, moments of brilliance, uncontrollable laughter, shock, disgust, emotional glitches, or loss of sanity (temporary or permanent) this video may cause.

View at your own risk!

UFO

Geheimnisse des dritten Reichs



PolyGram Video

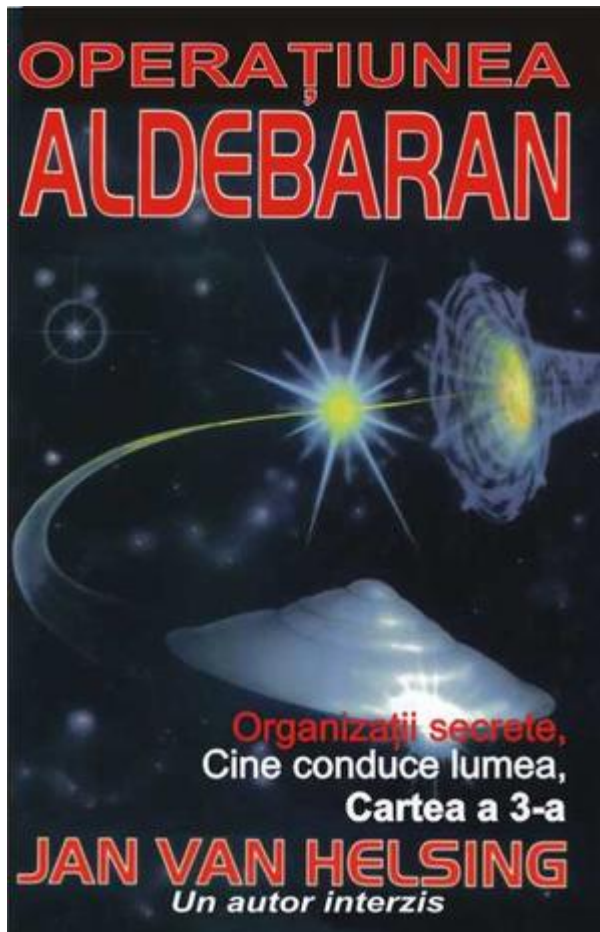

Nazi UFOs & The Illuminati
Secret Archives of the 3rd Reich

See dozens of saucer-shaped aircraft from German war archives, & hidden photos of German Panzer tank turrets and cannons mounted on the belly of disc-shaped flying vehicles! Joint Nazi-Japanese Mars flight, Free-Energy, Anti-Gravity, and the secret international organization known only as the Illuminati. Discover their diabolical plot contrived to control the world.

How were these UFO defy gravity? **The secrets of the flying machines was first hinted from ancient anti gravity scriptures.** All terrestrial vehicles have only one symmetry in common - the wheel. The wheel, along with the spire, occurs quite often in nature. The hair on your head is a result of the charkas of the head. The non-physical energy causes the hair to grow circular. This can be seen in crop circles also.

Foo engines More banned books Victor Schaubereger - a **Free Energy** genius Nicola Tesla. Spinning discs
Floating bowling ball **Alien visitations** Antigravity Magnetic to electrical Hydrogen engines Gravitation to energy UFO's to the moon Thermos jet Saucers Interplanetary Craft Cigar mothership Photo south pole hole and Aliens..

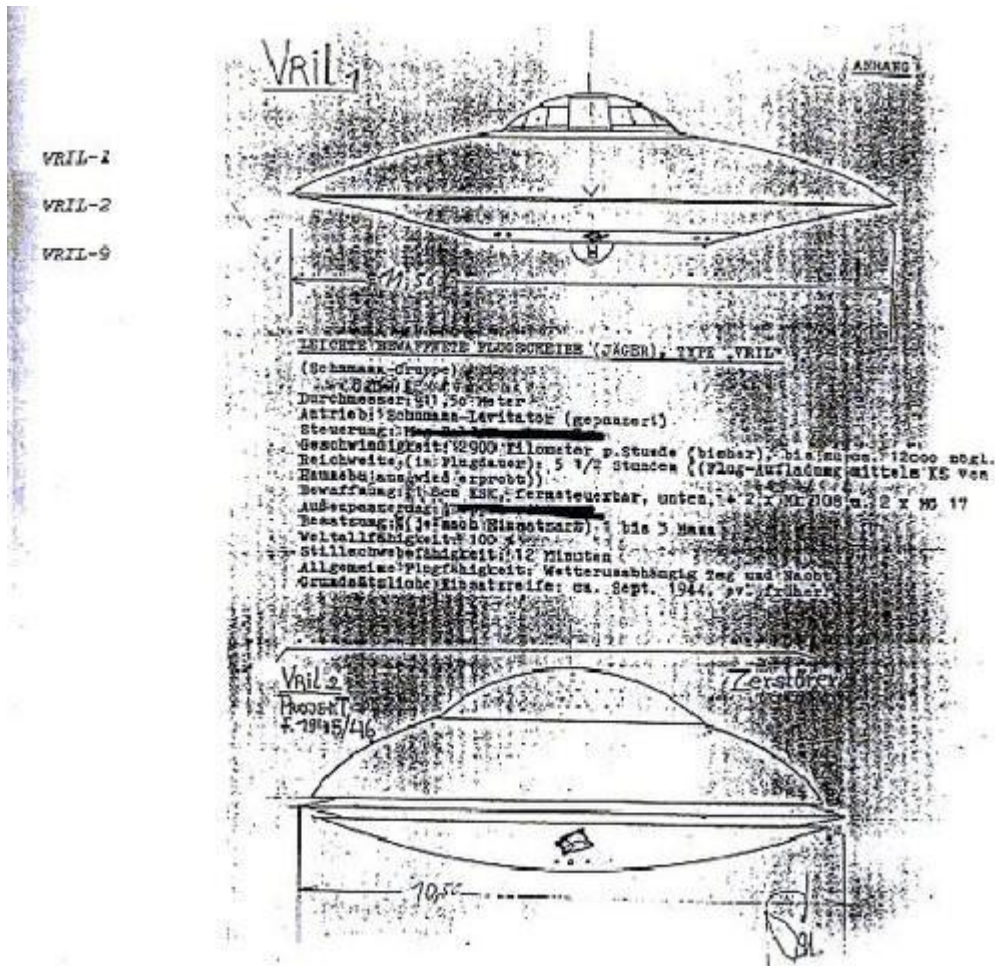

Secrets of the Third Reich

Part II

"He had one already off of the drawing board and flying and it was capable of 1200 miles an hour. Vertical take-off, 90° changes, much like a helicopter, and of course was far superior to anything the Allies powers had at that time. Secondly they knew he had another craft about to be up and going it was capable of doing 2500 miles per hours, which was double the original. Not only did it have the characteristics of the original craft, but it also had a laser weapon aboard it which capable of penetrating four inches of armour. Needless to say that really spooked the allied forces into making a redemptive attempt against him and bringing him ... into a state of capitulation." (6)

Bulgarian Physicist Vladimir Terziski also wrote the following about these Nazi UFOs. "According to Renato Vesco ... Germany was sharing a great deal of the advances in weaponry with their allies the Italians during the war. At the Fiat experimental facility at Lake La Garda, a facility that fittingly bore the name of Air Marshall Hermann Goering, the Italians were experimenting with numerous advanced weapons, rockets and airplanes, created in Germany. In a similar fashion, the Germans kept a close contact with the Japanese military establishment and were supplying it with many advanced

weapons. I have discovered for example a photo of a copy of the manned version of the V-1 – the Reichenberg – produced in Japan by Mitsubishi. The best fighter in the world, the push-pull twin propeller Dornier-335 was duplicated at the Kawashima works."

This appears to be the extent of information that can be verified to a degree. However there is much more that 'fits' within the known facts, but cannot be verified independently and therefore may well be fiction portrayed as fact. That said, much of the following information does flow with the themes explored further in the subsequent chapters of this book.

Claims have also been made that Nazi Occult societies were involved in the development of such unconventional saucer craft. One such, the 'Vril Society' was allegedly 'channelling' messages from an alien civilisation in the Aldebaran solar system and planned to develop a craft that could make physical contact with the civilisation there. This may or may not be true; but there was certainly a high level of occult activity in mid-Europe at that time, and no doubt organisations did exist then with unconventional beliefs just as they do today.

Whatever the truth of this, by 1934 the Vril Society had apparently developed its first UFO shaped aircraft, known as the Vril 1, which was propelled by an anti-gravity effect. (This was the same year as Viktor Schauberger discussed his flying disk ideas with Hitler.)

The society then allegedly went on to develop this craft, and later - and again allegedly - produced the RFC-2. This craft was apparently 16 feet long and fitted with an improved propulsion system and for the first time, magnetic impulse steering. Interestingly, when in flight, it reportedly produced colour effects normally associated with UFOs.

Yet the RFC-2 was largely ignored with only the SS showing an interest in the Vril Society's work. An inner organisation of the SS then set up its own SSE-4 department to develop new alternative technologies to ensure Germany no longer had to be dependent on external sources of energy and it began work on its own version of the RFC or Vril.

By 1939 the SS had produced the RFC-5, which it called the Haunebu 1. In August 1939 the machine made its maiden flight and proved its viability, being more than 65 foot in diameter and offering considerable storage space. By the end of 1940 the RFC-2 (Haunebu II) had entered service as a reconnaissance aircraft and there is certainly photographic evidence to support this, for example an RFC-2 was photographed near Antarctica in 1940 (see next chapter.) It should be noted that there is scant corroborative and historically verifiable information to support these claims, however the design of the Haunebu II should be noted for future reference.

VRIL SOCIETY

or "NOT ALL PROPERTY COMES FROM ABOVE"

...probably is with the most interesting secret company, which ever existed.

...you will determine directly with own eyes, which power circles of "non-German" nature are interested in it, this happening before the German people to keep secret.

Karl Haushofer created a second medal, which "BROTHERS of the LIGHT" before 1919, which was renamed later into the "VRIL SOCIETY". In this united itself likewise the 1917 from the Teuton medal Templar reestablishment "the MR. OF BLACK STONE" (DHVSS) and the "BLACK KNIGHTS" of the Thule and SS elite "BLACK SUN" come out.



In order to employ a comparison with the Thule society, one could seize the difference most simply, if one says that the Thule society dedicated itself to the material and political things and the Vril society was essentially JENSEITIG oriented. But nevertheless numerous connecting factors between Vril and Thule society remained, e.g. Atlantis, Thule, the "island of the blessed ones" of the Gilgamesch, were the Urverbindung between Germanien and Mesopotamien, in addition, old Heiligtuemer like the external stones or the house mountain of Stronegg topics of common Forschung.(83)

In December 1919 met a close circle from Thule -, DHVSSund Vril people in a forestry house in the RAM sow, rented in addition, with Berchtesgaden. Among them Maria Orsitsch was still another further apart from the medium, who admits only as Sigrun is. Maria had in mediale way notified in a Templergeheimschrift received - the medium completely unknown a language - with technical data for the building of a flight machine.

The telepathischen messages came to statement of the Vril writings of the solar system Aldebaran, which 68 light-years far away from us in the constellation bull is to be found. Here I

would like to present a short summary of the messages, which received the Vril Telepathen over the years and which were the basis of all further actions of the Vril society:

The solar system Aldebaran is therefore 68 light-years from the earth far away and their sun of two inhabited planets circles its, which form the realm "SUMERAN". The mankind of the solar system Aldebaran is itself into a gentleman people of "light God human being" (Arier) and different other human races to have partitioned, which are to have developed by negative mutations of these "God people" due to the climatic changes on the individual planets.

These colored mutanten races are to have had a smaller mental entwicklungsstufe. The more it for race mixture came, the more is to have down-sunk also the mental development of these peoples, which had as a consequence that, when the sun began to expand Aldebaran these no more were not able to receive the space travel technology of their ancestors and to leave personally the planets. Thus the low races, on the gentleman race completely dependently, are to have been evacuated with spaceships and have been brought to other habitable planets.

Despite these race differences itself however the different races are to have absolutely respected and in other habitat not have intervened, neither the so-called God people at the other races, still differently. Each respected simply that the others made their own development (in contrast to the earth). The gentleman race of the "light God people" is then approximately 500 million years ago with it to have begun, after the expansion of the sun

Aldebaran and the increasing heat resulting from it made the planets uninhabitable, to colonize other earthsimilar planets. It means that they settled the planet Mallona (also mark DEK, Marduk or with the Russians phaeton mentioned) in our solar system first, which was to have existed in place of the today's planetoiden at that time between Mars and Jupiter. Afterwards Mars, from whose highly developed inhabitants the large pyramid cities and the well-known Mars face witness, which were taken up 1976 by the Mars probe Viking.

And one assumed that the gentleman people of Sumeran Aldebaran came also to this time the first time on earth, on which approximately 500 million years point old petrified shoe-pure with from the paragraph zertretenen just as petrified Trilobiten, one at that time on earth living and 400 million years ago become extinct Urkrebs.

The Vril people were the opinion that the race of the Aldebaraner was to have landed therefore later, than the earth became slowly habitable in Mesopotamien and the ruler caste of the SUMERER, which as bright white God people were designated, to have formed. The moreover the Vril Telepathen came to the realization that Sumeri is identical not only to the language of the Aldebaraner, but also the fact that Aldebaranisch Aldebaranisch-Sumeri sounds like an incomprehensible German and also the speech frequency of both languages of the German and Sumeri - is nearly alike.

Whether these statements about Aldebaran correspond to the fact, is undecided, the structural drawings and technical data, which received the VrilTelepathen - where always these data also came - was however so exact that they led to one of the most fantastic ideas, which was probably devised e von Menschen: to the building of the "the other world flight machine". It matured the concept of "other science" near (today one would say "alternative forms of energy"). But it lasted over three years, until the project was tackled.

In this early phase of the "other technology" or "other science" Dr. W held. O. Schumann, Thule and Vril member, at which TH Munich a lecture, from which some sentences are to be shown here: "we know two principles, which the things in everything and each the happening determining light and darkness, property and bad, work and destroying - like we also with the electricity pluses and minus know. It always means: Either - or! "these two principles - concretely to designate as the work and the destroying - determine also our technical means... "all destroying is satanischen origin - all developing goettlicher origin... Each on the explosion principle or also the burn which is based technology can be called therefore satanische technology.

The forthcoming new age will become one age of new, positive, goettlicher technology!..., (out: Realm-German SSGeheimarchiv). At same time the scientist VIKTOR SCHAUBERGER worked on a similar project. Johannes Kepler, whose teachings Schauberger used, was in the possession of the secret teachings of the Pythagoraer, whose knowledge was kept secret and taken over over the **TEMPLE KNIGHTS**. It was the knowledge around the "**IMPLOSION**" (implosion in this case = the utilization of the potential of the internal worlds in the outside world).

It knew Hitler, like also the Thule and VrilLeute, that the goettliche principle is constructional always constructing, i.e.. A technology, which is based against it on the explosion and is destructive therefore, is against the goettliche principle. Therefore one wanted to create a technology, which was based on the **IMPLOSION**. Schaubergers oscillation teachings (principle of the overtone row = mono cord) ties to the knowledge around the implosion. Simplified one could say: **IMPLOSION instead of EXPLOSION!** On the basis the energy courses of the mono cord and the implosion technology one arrives into the range of the **antimatter** and thus at the **dissolution of the force of gravity**.

In the summer of the yearly 1922 at the first untertassenfoermigen flight ship, its drive on the implosion technology was built was based (the the other world flight machine). It consisted of a disk of eight meters diameters, over which a parallel-stored disk of six and a half meters of diameters was, and among them a further disk of seven meters diameters. These three disks were broken through in the center by a 1.80m measuring hole, in which the 2.40m high power supply unit was installed.

Down the centerbody ran out in a conical point, from which a pendulum hanging into the basement provided for the stabilization of the equipment. In the activated condition the lower and the upper disk turned in direction moving in opposite directions, in order to develop first an electromagnetic rotation field. This first flight disk furnished which achievements, is unknown.

One experimented anyhow two years long with it, before it was however again dismantled and probably stored in the Augsburg Messerschmidt works. Financial aids for this project dip the **Vril engine**, which is however formally led as "Schumann SM Levitator" under the code "JFM" in the bookkeeping of several German industrial companies on with security came out from the the other world flight machine.

In principle the other world flight machine should over sees and its direct environment an extremely strong field producing, which that of it umschlossenen space sector with the machine and its users a mikrokosmos perfectly independent of the this-lateral cosmos become let. This

field would be completely independent with maximum field strength of all this-lateral universal forces and influences - as for instance gravitation, electromagnetism and radiation, as well as subject of any kind -, surrounding it, and could move within each gravitation and other field at will, without in it any acceleration forces became effective or noticeable.

In June 1934 VIKTOR of SCHAUBERGER of HITLER and the highest representatives of the Vrill and Thule societies was invited and co-operated from then on with them. The birth of the first so-called German UFOs struck however then, after this first miss, in June 1934. Under the direction of Dr. W O. Schumann developed the first experimental round airplane that RFZ 1, on the area of the German aircraft factory Arado in Brandenburg. During its first and also at the same time last flight it rose perpendicularly to a height of approx. 60m, began in air to then tumble however for several minutes and dance. The tail unit Arado 196 attached for control proved as completely ineffective. With trouble and emergency it succeeded to pilot Lothar Waiz to bring the RFZ 1 back on the soil to jump out and away-run, before it began to behave itself like a gyroscope then tilted and proper zerfetzte. That was the end of the RFZ 1, but the at the beginning of the VRIL missiles.

Vril-1-Triebwerk

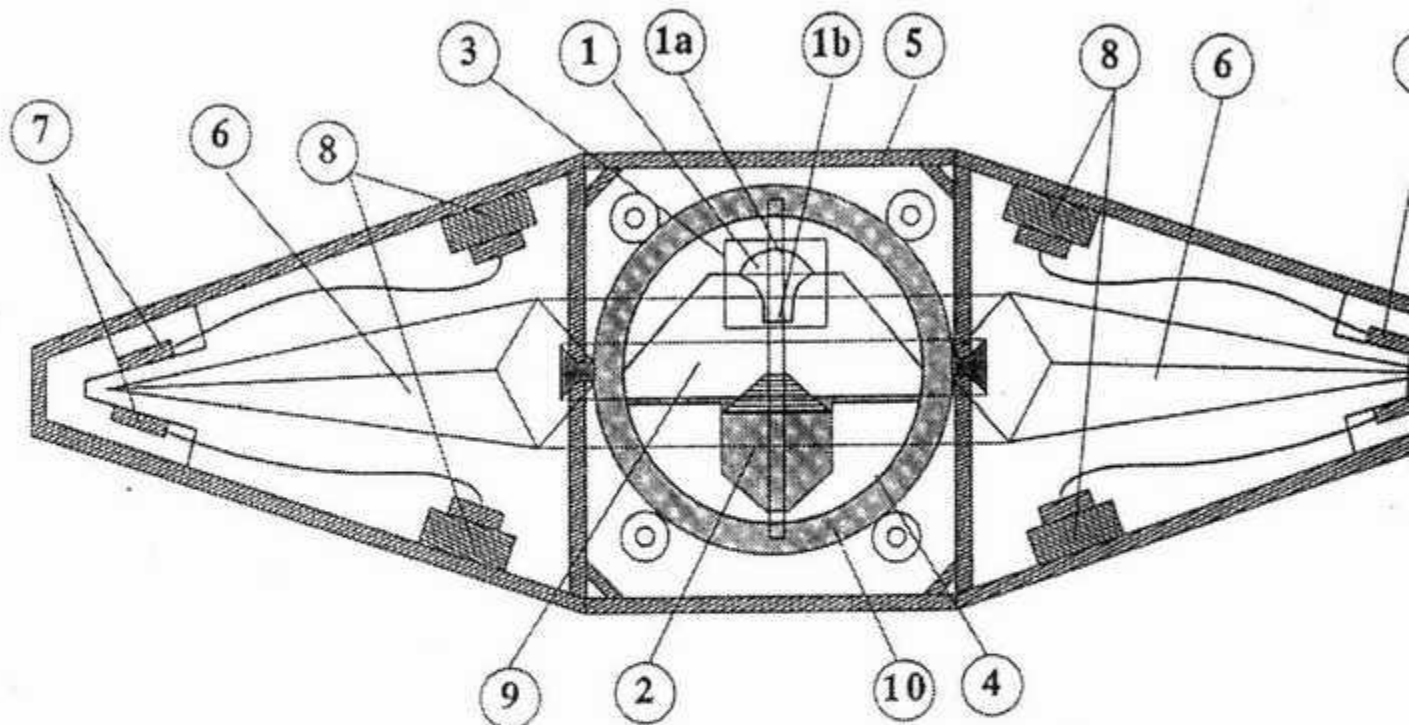

- | | | |
|--------------------------------|-----------------------------|------------------|
| 1 Glocke | 4 Schwingungseinschluß | 10 Schwingungspa |
| 1a YX - Pol | 5 Rahmen | |
| 1b XY - Pol | 6 Drehkörper | |
| 2 Haupt- u. Anlaß
Generator | 7 Elektromagnete | |
| 3 Glockenmantel | 8 Stromspeiser u. Aufnehmer | |
| | 9 Vakuum | |

Still before at the end of 1934 the RFZ 2 was finished, which had a Vril drive and a "**magnet impulse control**". It corresponded to 5m in the diameter and had the following flight characteristics: Optical blurring of the outlines at increasing speed and that for UFOs typical colored lights. Depending upon booster stage red, orange, yellow, green, white, blue or violet. It functioned thus - and it should have 1941 still another remarkable fate before itself.

It was used during the "air battle around England" war phase mentioned, when the German standard hunters ME 109 for transatlantic clearing-up flights showed themselves because of their to short range as unfit, as long-range reconnaissance aircraft. At the end of 1941 was photographed it over the south Atlantic, when it was on the way to the auxiliary cruiser Atlantis in Antarctic waters. The reason, why it could not be used as fighter, was because of the fact that the RFZ could implement 2 because of its impulse control only changes of direction of 90', 45'

and 22,5'. Unbelievably some will think - however exactly these right-angled flight changes are for so-called uFOs absolutely typical flight behavior.

After the success of the small RFZ 2 as long-range reconnaissance aircraft the Vril society got its own testing ground in Brandenburg. At the end of 1942 flew the easily armed flight disk "VRIL-1-Jaeger". It was 11,5m in the diameter, a single-seater, had a "Schumann Levitator drive" and a "magnetic field Impulsor control". It reached speeds of 2,900 up to 12,000 km/h, could accomplish at full speed changes of flight in the right angle, without the pilots were impaired of it, was weather-independent and had an universe ability of 100%.

By Vril 1 and gave also several two-seat variants equipped with a glass dome were built for 17 pieces. Likewise to this time its own project, V-7 developed. Under this designation several flight disks built however with conventional jet propulsions. On the bases of ANDREAS EPP the RFZ 7, a combination of a levitierenden flight disk with jet propulsion developed. On this the groups of developments worked SCHRIEVER HABERMOHL and MIETHE BELLUZO. The RFZ 7 had a diameter of 42m, went however with a landing in Spitzbergen to break. Later however a copied RFZ 7 was photographed outside of Prague. According to statement of Andreas Epp should be equipped this with atomic sprengkoepfen and bombarded New York.

In July 1941 built and HABERMOHL a perpendicularly starting round airplane with jet propulsion, which exhibited however heavy lack. One developed however a further "electrical gravitation flight gyroscope" with "Tachyonen drive" was more successful. Whereupon the RFZ 7 T, built by, followed Habermohl and Belluzo and likewise fully functionally. The V-7 flight disks was however, compared with the Vril and Haunebu disks to describe rather as a kind toy.

Within the SS there was a group, which was concerned with the production of alternative energy, the SS-E-IV = RESEARCH CENTER IV the **BLACK SUN**, whose main objective it was, to make Germany independent of foreign crude oil. Hans Coler the "THULE ENGINE" developed S SE-IV from the existing Vril engines and the Tachyonenkonverter of captain, which was designated later than THULE TACHYONATOR.

In August 1939 the first RFZ 5 started. It was a moderately severe armed flight gyroscope with the strange name "**HAUNEBU I**". It had a crew of eight men, measured 25m in the diameter, reached at the beginning a speed of 4,800 km/h and later up to 17,000 km/h. It was equipped with two 6 cm KSK (force jet cannons) in rotating turrets and four MK 106 and had a space ability of 60%.

At the end of 1942 had likewise developed the "**HAUNEBU II**". The diameter varied from 26 to 32m and in the height between 9 and 11m. It could transport a crew between 9 and 20 persons. It was propelled with a Thule Tachyonator and reached at perigee a speed of 6,000 Km/h. It was universe suited and had a range of 55 flying hours.

Plans for the **VRIL-7-Grossraumschiff** with a diameter of 120m already existed, should transport whole crews at this time.

Short time was flown later the "**HAUNEBU III**", the absolute piece of splendor of all disks, finished with 71m diameter and also filmed. It could transport a crew of 32 men, had a range in flight duration of over 8 weeks and reaches a speed of at least 7.000 km/h (after documents from SS Geheimarchiven up to 40,000 Km/h).

Virgil Armstrong, former CIA member and Green Beret a.D., describes German missiles during 2. World war, which land vertically and to start and right angles fly could. They were fast measured up to 3,000 km/h and had a laser weapon as cannon (supposed the so-called KSK force jet cannon), which could break through 4 tariff armoring.

Professor J. J. Hurtak, Ufologe and Autor of "the keys of the Enoch," describes that the Germans were busy to build something what the allied ones as "miracle weapon system" designated. Hurtak got minutes into the hands, which described two circumstances:

1. the structure of the space city "Peenemuende" and
2. the Herueberholen of the best technicians and scientists from Germany. Mentioned likewise the more exact investigation was the so-called "**FOO FIGHTERS**" (feuerkugel). The building and employment of such flying objects were the CIA like also the British secret service around already 1942 well-known, were however not correctly estimated.

Foo Fighter was actually the name of the allied ones for all bright German aircraft. In particular were however probably two inventions, which fell under the term Foo Fighters: The **flying turtle** and those **Seifenblase**, two completely different things, which were rated however of the allied ones as belonging together.



The "**FLYING TURTLE**" was developed of the SS-E-IV in Viennese new city. Their outside form reminded of a turtle tank. Were unmanned flight probes, which should cause disturbances

with the electrical ignition systems of the hostile armed forces. They had inserted to further developed klystron tubes, which were called of the SS death jets. The effective ignition disconnection did not function however at the beginning yet so perfectly. Later it gave will be able to confirm advancements of this technology and the UFO connoisseurs that the "ignition disconnection", which is failing electrical system one of the typical characteristics when emerging a uFOs.

Wendell C Stevens, US air Force US-Air-Force-Pilot during 2. World war, the Foo Fighters describes red orange, which approached up to 5m to the airplanes and remained there then as sometimes grey-green or. They could be shaken off nor shot neither and forced flight relays partially to turning or landing. Completely different thing were those often than Foo Fighters designated seifenblasen. With these it concerned simple balloons, in which see thin metal spirals for the disturbance of the hostile airplane radar found. The success of this idea might have been small apart from the psychological effect once.

At the beginning of of 1943 one planned likewise a zigarrenfoermiges parent ship that in the Zeppelinwerften should be built, the so-called "and Rome since equipment" (139 m long). In it several untertassenfoermige flight ships for (interstellar) long-duration flights should be transported.

Around Christmas 1943 was an important meeting of the **VRIL SOCIETY** in the North Sea bath Kolberg. Also with it likewise the media Maria and Sigrun. Main topic of this meeting was the "**ALDEBARAN ENTERPRISE**". The media had gotten exact data concerning the inhabited planets around the sun **Aldebarans** and one began a journey there to prepare.

On 2 January 1944 a discussion between HITLER, HIMMLER, Kuenkel (VrilGesellschaft) found and Dr. Schumann (Vril society), in whom it concerned the **VRIL PROJECT**. One wanted to penetrate with the Vril-7-Grossraumschiff by an speed of light-independent dimension channel into Aldebaran.

After Ratthofers statement is to have taken place in the winter 1944 the first dimension channel test flight. This is to have led past allegedly scarcely a disaster, because photos show the Vril-7 after this flight, on which it looked, "as if it 100 years would on the way have been". The outside cell lining worked therefore strongly aged and was damaged in several places.

On 14 February 1944 the supersonic helicopter, which was equipped with 12 turbo aggregates BMW 028, designed under the project V-7 von Schriever and Habermohl, was test-flown by the test pilot Joachim Roehlike to Peenemuende. The senkrechte rate of climb amounted to 800m in the minute, it reached a height of 24,200 m and in the horizontal flight a speed of 2,200 km/h. This could be likewise propelled with unorthodox energy. He was not used however any longer, since Peenemuende 1944 and also the misalignment was bombarded to Prague nothing more brought. Because before the flight disks were operational, the Americans and Russian Prague had occupied.

The British and American discovered, during the occupation of Germany at the beginning of of 1945, in SS Geheimbildarchiven among other things also photos of the Haunebu IL and Vril I types, like also the and Rome since equipment.

Vril (1934/1945)



President Truman's resolution in March 1946 led to the fact that the Flottenkriegskomitee of the USA gave permission to collect German material to the experiments of high technology. Under the operation "**PAPER TIE-CLIP**" in secret one working German scientist was brought privately into the USA. Among them **VIKTOR SCHAUBERGER** and **WHO AGO OF BROWN**. Here again a short summary of the developments, which should be produced in series:

The first project became of at the TH Munich active Professor Dr. Ing. W O. Schumann led, within whose framework to at the beginning of of 1945 allegedly 17 diskusfoermige 11,5 meters through-measuring space flight disks, which are to have ascended to altogether 84 test flights, the so-called "**VRIL-1-JaeGER**". At least a VRIL-7 and a VRIL-7-Grossraumschiff with the name "**ODIN**", which is to be started in April 1945 with a part of the Vril scientists and Vril Logenmitgliedern from Brandenburg - after the breakup of the entire test area - after Aldebaran.

The second project stood under the line of the research center IV the SS, which let 1945 three differently large bell-shaped space flight gyroscope types build up to beginning: The **HAUNEBU 1**, 25 m in the diameter, by which two copies were built and to altogether 52 test flights had ascended (approx. 4.800 km/h).

By the **HAUNEBU II**, with up to 32 m diameters, were built seven copies and tested on altogether 106 flights (approx. 6.000 km/h). The Haunebu type of ii was actually already intended for series production. Between the airplane companies Dornier and Junkers an advertisement is to have taken place, the at the end of March 1945 in favor of of Dornier failed. The official designation of the heavy flight gyroscopes should read DO-STRA (= Dornier stratosphere airplane).

The **HAUNEBU III** with 71 m diameters was built only once and rose to at least 19 flights to (approx. 7.000 km/h). And in the form of plans ", there", existed the 139m long parent ship, with Hangarn for one Haunebu II, two VRIL 1 and two VRIL II. Further there are documents that the VRIL-7-GROSSRAUMSCHIFF after its completion at the end of of 1944 and unite flight tests to first, still on earth limited secret in corroding to be already started is:

1. Landing with the moon lake in the salt chamber property, with diving tests for the statement of the pressure strength of the flight cell,

2. from March to April 1945 the stationing of the Vril-7 probably took place in the "alpine fortress", according to which from here from Spain out one approached, in order to fly over and set here fled important realm-German personalities off surely here to South America and "**NEW SWABIA COUNTRY**" (explanation follows) into secret realm-German bases put on during the war, for safety and strategy reasons

3. immediately after it the Vril-7 is to be started on a secret flight to Japan, over which however far nothing admits became. Which happened with the flight ships after the war. The fact that it came to the production of a Kleinstserie of the Haunebu II can be excluded not completely. The different UFO photos, which emerged after 1945 with the completely typical appearance of these German constructions, suggest this possibility. Some say, some of it would have been sunk in the upper-Austrian moon lake, others says, they had been flown to South America or brought in individual parts there.

Safe it is here that, if also not absolutely the missiles arrived to South America at least on the basis structural drawings new were built however there and flown, since an important part of this technology was used with the "**Phoenix experiment**" 1983, which was the subsequent result "**Philadelphia of the experiment**" from 1943. (here it concerns Teleportations -, materialisations and time journey experiments of the USNAVY, which were more successful, than you would introduce yourselves it in their boldest dreams. Also concerning this sufficient material does not exist, in order to fill a new book with it, it fits however directly into our topic. See bibliography) 1938 were accomplished a German **ANTARCTIC EXPEDITION** with the aircraft carrier swabia country.

600.000 was explained qkm as German country, "**NEW SWABIA COUNTRY**". An ice-free area with mountains and lakes. Whole fleets of submarines of the types 21 and 23 were later on the way to new swabia country. Are missed until today still over 100 German submarines, which were equipped with the walter snorkel among other things also, them permitted to remain several weeks under water and it is to be accepted that they fled with the divided flight disks or at least with the structural drawings to new swabia country.

It is to be accepted again strongly, since the test flights were successful that the saucers mentioned flew directly with end of war there. This acceptance may appear daring some probably something, it gives however strong references on the fact that it could have like that been.

The question arises, why the allied ones under **ADMIRAL E. BYRD** accomplished 1947 an **INVASION of the ANTARCTIC**. Why did Byrd have scarcely 4.000 soldiers available, a warship, a fully equipped aircraft carrier including a complete utility system, if it should be nevertheless only one expedition? It had eight months available, had however after eight weeks and a high and never number publicly specified at airplane losses to break off. What had happened? Admiral Byrd explained to fly afterwards before the press, "it is bitter reality that in the case of a renewed war on attacks of fliers had to be counted, those from a pole on the other hand can."

Further it mentioned those that there was a advanced civilization there, with the SS together its outstanding technologies benuetzten.(84) Norbert Juergen Ratthofer writes over the later whereabouts of the Haunebu developments in its book "time machines" as follows: "the Haunebu I, II and III space flight gyroscope and the Vrill i space flight disks remained however disappeared starting from May 1945 first without trace... In this connection it is most interesting that the realm-German Haunebu III is to be started after its nineteenth test flight then on 20 April 1945 of, "new swabia country" out, an enormous at that time officially realm-German territory in the east Antarctic, to a space expedition to Mars, over whose exit however nothing admits is...

One year later, 1946, numerous sighting of shining objects of unknown quantities origin and clearly artificial origin ensured then however suddenly for substantial excitement with the allied ones in east and west over Scandinavia. Again one year later, 1947, now zigarrenfoermige "unknown flying objects" emerged, briefly uFOs mentioned,, over North America first into the fifties-years in constantly rising number again without doubt of Intelligenzen steered shining flying objects with mostly more approximately, diskus to bell-similar form, occasionally in addition,

One continues to write that these "UFOS" did not resemble usually the realm-German developments. In this point am I other opinion. Well documented photo material proves that particularly the Haunebu ii-version was sighted even very frequently since 1945. If you will state yourselves, how I, one decade by the UFO professional world fought, you likewise that an unusually high prozentzahl of the cases, with which it came to personal contacts with passengers of so-called uFOs concerned it particularly beautiful copies of the species "Arier", blond and naive, and these spoke either flowing German or another language with German accent (for Insider here the case of Adam AI was 1952, which mentions Cedric Allingham case 1954 and the case of Howard Menger 1956).

One tells also that color photos of a manned landed and again started Flugdiskus exist, which asked both a bar cross as well as a swastika up-painted, which was taken up in the seventies by a night watchman to West Germany. Over the evenly specified missiles excellent film and photo material exist, for example the 60 min documentation of "UFO secrets of the 3. Rich "(MGA Austria/ Royal Atlantis film GmbH). Likewise the material of the American Vladimir Terziski,

that to the conference of UFO in September 1991 in Phoenix, Arizona a 3-Stunden dia. lecture with photos of German saucers, structural drawings and underground German Basen napkin.

The material, that is interesting the Italian commander of Air Force Renato Vesco in its book likewise gathered and Rudolf Lusar's book: The German weapons and secret weapons of the Second World War and its advancement, J. F. Lehmanns publishing house, Munich 1971.

Do you understand now, why the topic of the uFOs in the mass media, particularly in Germany, when Humbug is dismissed? After this German Background it is clear that the medium and message world controlled by the **Illuminati** by the zionistisch anglo American lobby do not shrink from costs to hold the German citizen from investigating in this area.

[...devised by German naval engineer and inventor, Hans Coler (or Kohler). Entitled "The Invention of Hans Coler, Relating to an Alleged New Source of Power," B.I.O.S. Final Report no 1043, Item No. 31, Summer 1946, this report consisted of tests and findings on two strange circuits conducted at the University of Berlin between the World Wars under the auspices of none other than Dr. Schumann, discoverer of the Schumann resonance of the earth.⁴⁷ A mere glance will explain why the device attracted the immediate attention of the German Navy, which classified it as a possible source of quiet and limitless energy for submarine propulsion.

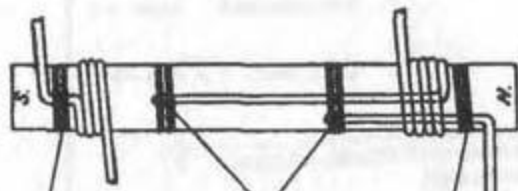

binding soldered & bound binding
 Note: Paper insulation between magnet and coil.
 Rys.1

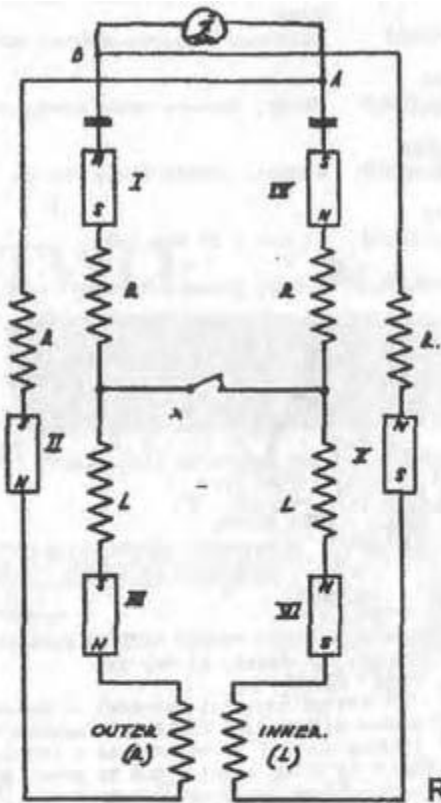

Rys.3

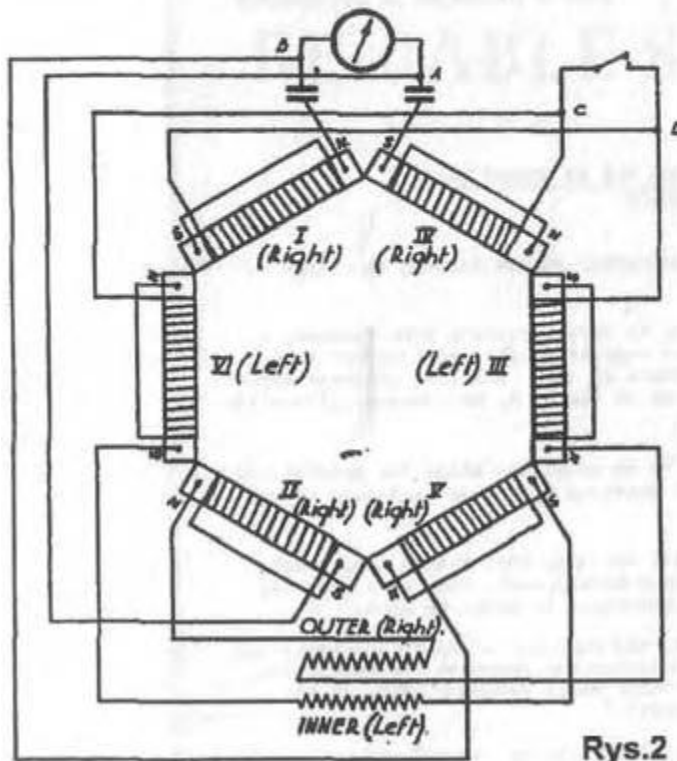

Rys.2

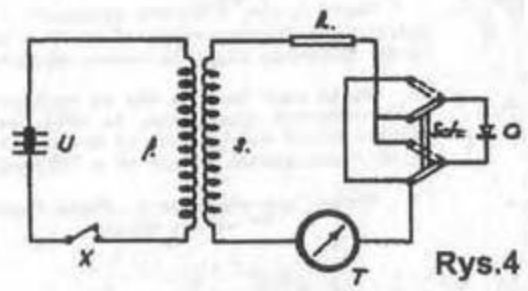

Rys.4

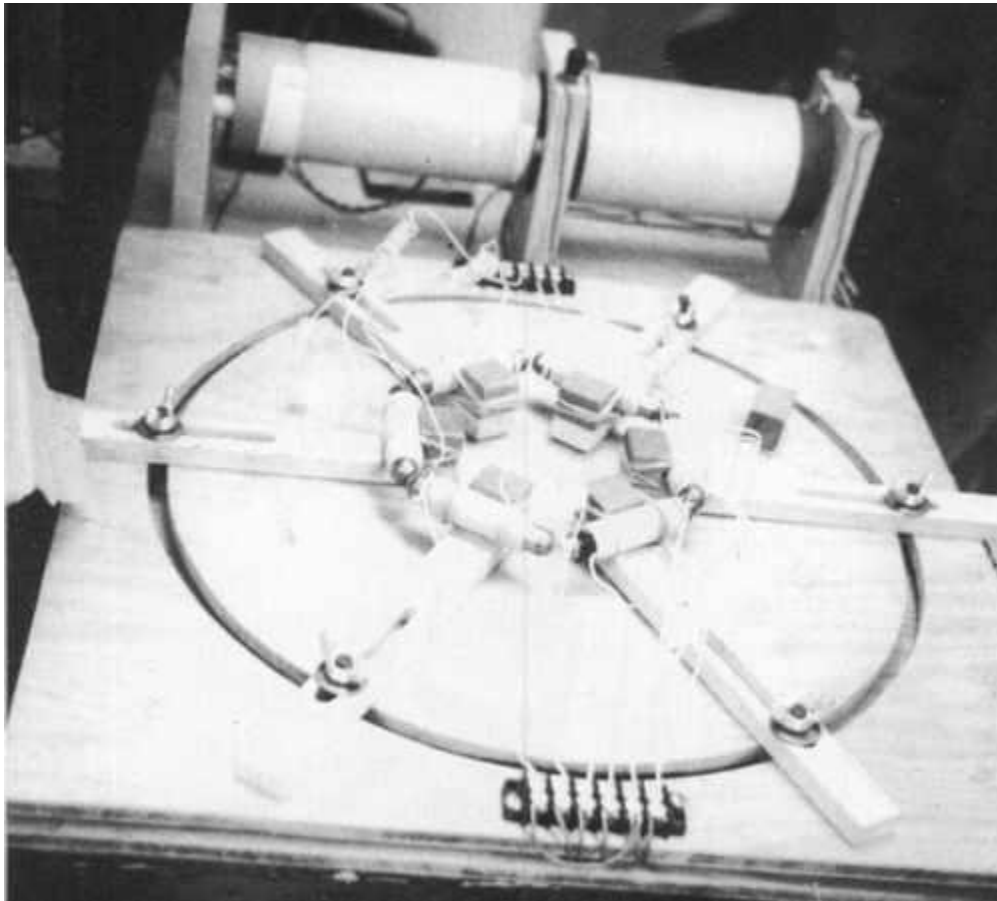

It will be noted that this hexagonal construction of coils and magnets and two "rotating" sub-circuits has absolutely no source of power. Yet, to the mystified Coler and Dr. Schumann, it

47 The report is reprinted by the Integrity research Institute, 1422 K Street NW, Suite 204, Washington, D.C. 20005.

nevertheless managed to produce, or better, transduce, power seemingly from nowhere.

Little is known how much farther the Germans took this device, or for that matter, how far the British took it for the two decades and a half after the war that they had to work on it until its declassification. What is unusual is that Dr. Schumann was involved with secret German research on "batteries" as late as 1943, and was subsequently brought to the United State as part of Operation Paperclip. It was this same Dr. Schumann who had noted in 1926 that Hans Coler's device exhibited "no fault, hoax, or fraud on the part of its inventor."⁴⁸ Such "free energy" devices seemed to have come very early to the attention of the leadership of the Third Reich - witness the meeting between Hitler, Planck, and Schauburger - and more especially to the attentions of the SS. Devices involving pulsed Tesla coils, suspiciously similar to Tesla's own "Impulse Magnifying Transformer" were constructed.

One such device, the so-called Karl Schappeller Device, bears close scrutiny, since it bears resemblances to another device found by Nick Cook and described in his Hunt for Zero Point. This odd device is described by Henry Stevens as follows:

The Schappeller device is really composed of two separate units, the rotor and the stator. The stator is constructed as follows: its surface is round or ball-shaped, being composed of two half-shells of steel. These half-shells contain the internal structure and are air tight. Attached at each "pole" of each half-shell is an iron bar magnet, most of whose structure is internal. This means that the bulk of the magnet is inside the steel ball, one opposite the other. There is a space between the two bar magnets at the very center of the sphere.

Insulation, a ceramic material, is placed on the inside of the steel ball leaving a hollow central area. Within this hollow area and around the space between the magnets are wound two internal coils. These originate at the bar magnet poles and each terminate at the center of the sphere with a connection leading out of the sphere to the rotor. These coils are composed of a hollow copper tube filled with a special and secret substance called the "electret". Upon leaving the sphere the electret filled copper tubes are replaced by conventional copper wire.]

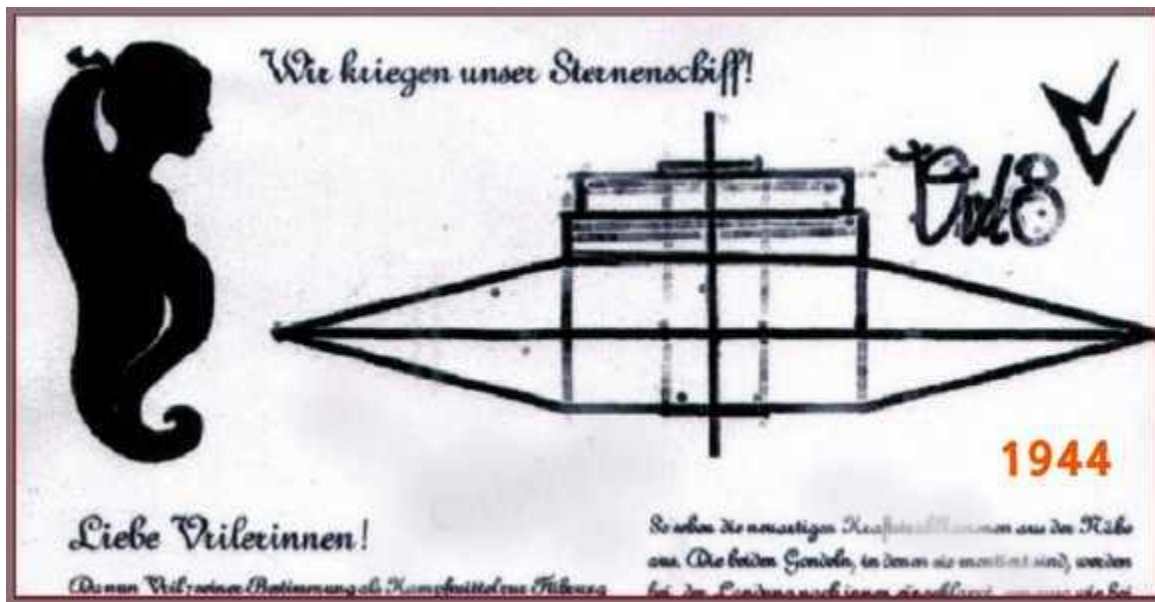

The question arises here, from where Thule and Vril the knowledge for the building of these missiles had the German secret companies? Likewise the knowledge for the genetic engineering, in which the Germans were again different nations ahead around lengths?

According to statements of Herbert G. Dorsey and other researchers is beside the structural drawings of the Vril society, by the telepathischen contact with the extraterrestrial ones, the intact drive in the year 1936 of a not-terrestrial saucer the German fallen in the Black Forest a large assistance to have been. For this it gives however as well as no proofs to be silent from still living eye-witnesses completely.

But this gives it to America, a lot. Because at the same time the Americans had to announce a whole set of crashes, which could not be kept also completely secret. But in addition we come

only later. Back to the political happening. Apart from the fact that supported the Ith G. Farben Hitler, it schuerte its trust partner, the "standard oil" (Rockefeller), against the Nazis. Or for example developed the "Fords engine company with the military apparatus for the American army, produced however at the same time in Germany military vehicles for the Nazis. Fords and Opel (daughter the general of engine, who is controlled by J. P. Morgan) were the two largest tank manufacturers in Hitler Germany. No matter how the war would go out, these multis had from the beginning already won. According to this principle many enterprises worked in 2. World war. Why doesn't one read anything over these things in the school books or the encyclopedias? Particularly in Germany, where nevertheless apparent pressefreiheit prevails and is taught the truth? That is among other things because of it that the Rockefeller Foundation had spent 1946 139.000 US dollar, around an official version 2. World war for the Offentlichkeit to present, those the entire structure of the Nazi regime by the US Banker, like also the okkultmystischen background the Nazis, cover. One the main donor of the funds was Rockefellers own standard oil Corp.(85)

Nazi Flying Saucers Part II

Milton Keynes, England, it's not the kind of place where we expect to get new information on real life flying saucers. But after our recent report on a shaped aircraft in Canada, top secret American saucer projects and Germany's development of craft like this during World War II, a SIGHTINGS Researcher received A letter from viewer D. Robin Stowell.

A typesetter by trade, Stowell alerted us to the book, Brighter Than A Thousand Suns. An authoritative history of the race to build the first Atomic Bomb. Stowell typeset the original manuscript nearly forty years ago. And never forgot this brief reference to a Nazi Saucer that could out-maneuver any allied aircraft.

Four decades after publication, Stowell found a copy of the out of print reference book and confirmed what he had long remembered. The footnote describes German Saucers that were forty five yards across, capable of reaching speeds over Mach One and climbing to an elevation of nearly eight miles. Some experts believe that these Nazi Saucers could have been responsible for the legendary Foo Fighter sightings over Europe late in World War II. But if they were, it still does not explain Foo Fighters spotted over the Pacific during the same period.

There were a number of brilliant German scientists and engineers working on flying disc-shaped craft, many of which used traditional rocket/jet propulsion techniques...but some, apparently used methods far in advance of anything commonly known at that time. Or now, for that matter

Dr. Richard Miethe whose group allegedly built saucer craft at Breslau, came to Canada after the war and worked on saucer designs with the A.V. Roe Company on a joint American-Canadian project which 'officially' produced only a barely functional 'hovercraft' type 'saucer.' Most researchers today consider the Roe 'saucer' nothing less than a diversion. What was Miethe really working on?

Another highly-advanced group was led by Dr. Viktor Schauberger, who worked in Austria at the Kertl factory in Vienna. **Schauberger's incredible craft allegedly utilized a tornado-like vortex which produced magnetic effects said to cause levitation.** Two Schauberger models, both made of copper, were said to have been built with one of them successfully test flown. The story goes that it flew so well, in fact, that it impacted the inside roof of the hangar and was destroyed.

The SS which was apparently overseeing this and all German saucer research, allegedly stopped further experimentation after accident, dismissed Schauberger, and took all of his work and wizardry to some other location for further development. After the war, Schauberger was lured to

the US by an alleged CIA front company and was then duped into signing a contract in English (he knew only German) giving the company all rights and title to his inventions, concepts, and designs. He was then returned to Austria...and died five days later.

As stated earlier, many of the German saucer craft were predicated upon known, if quite exotic, technology. Our source for the extraordinary drawing below has been thoroughly interviewed over a lengthy period of time and is known to be of impeccable integrity. We have seen some of the hundreds of wartime documents from his long service with the Horten brothers, including personal correspondence from them to him.

When queried as to how he was able to obtain the drawing of the disc craft below, he would only say, "Sneaky...sneaky. No one was ever to know anything about this...I had to get the drawing from a friend who was very close to the project." He said he would never compromise his friend by disclosing his identity.

Haunebu1 (1939)



Probably a model from the Haunebu series. The Nazis built their first Haunebu in 1939

Hitler's Secret Flying Saucers

Editorial Reviews:

Description

DID THE ALLIES REALLY WIN WORLD WAR II? Aerospace writer and engineer Wm Lyne,

offers striking testimony that: O Adolf Hitler had at least 7 body doubles and was able to escape from his Berlin "death bunker from which he fled with other Nazis to South America to start a Fourth Reich. O The true history of flying saucers is a big lie, full of deceit and government disinformation, created to conceal one basic truth...**THAT MOST UFOS ARE MAN-MADE CRAFT BASED UPON GERMAN WORLD WAR TWO ANTI-GRAVITY TECHNOLOG AS FIRST DEVELOPED BY NIKOLA TESLA!** O Werner von Braun, top German rocket scientist, was present in New Mexico as early as 1937, and the "Roswell Crash" may have been a staged hoax to hide the truth about our government's involvement in alternative methods of propulsion, including free energy.

Secrecy and Deception and Flying Saucers

Former Disney animator Paul Scarzo is the producer, director and host of a series of DVDs and videos produced under the banner "The 33rd Parallel," which deal with such fascinating topics as UFOs, government conspiracies, and occult lore and symbolism. For this particular DVD, Scarzo conducts an absorbing interview with author and researcher William R. Lyne, who spins one tale after another about the secret truth behind the modern flying saucer phenomenon and its origins deep inside Nazi Germany.

Lyne says at the outset that he believes the UFO phenomenon is very real, but also something entirely manmade. He eschews any belief at all in the better-known "**extraterrestrial hypothesis**," which posits that flying saucers are the vehicles of aliens from outer space or some other mystical dimension. Lyne has authored several books that lay out this same non-extraterrestrial scenario, including "Pentagon Aliens" and "**Occult Ether Physics**."

But what Lyne focuses on throughout most of the interview is the nature of secrecy and deception, especially in terms of the Nazis' warmongering and dreams of conquest as well as our own CIA's collaboration with the clandestine but still operational German military colossus in the year's following World War II. Lyne was himself a member of the Army-Air Force, and had contacts within the U.S. intelligence community, many of whom passed along secret information about the technological advances being made in the development of saucer-shaped aircraft and the use of the alien explanation as a clever smokescreen. Lyne even asserts that the UFO community as it exists today is entirely a creation of the CIA, arguing that they are a tightly knit group who continually interview and research only each other in a sort of self-perpetuating incestuous attempt to deceive UFO believers and nonbelievers alike.

Lyne goes on to declare that there are CIA operatives embedded directly within the news media doing the bidding of their dark masters as they leak portions of classified documents combined with other forms of disinformation, using elements of a bought-and-paid-for "friendly media" to spread the kind of lies and half-truths useful to duping the public about where we are technologically and to conceal the future fascism awaiting us when the conspiracy finally comes out in the open.

A lot of that can be seen as typical paranoid ranting, but ah, the stories Lyne tells as he makes his points. One engrossing anecdote after another pours forth from him, including his meeting with someone he believed was the still-living Hitler when Lyne was an art student in San Antonio in the 1960s. As Lyne explains, Hitler actually escaped death in Berlin at the end of the war, and

the corpses found in the bunker were look-alikes and misidentifications of other Nazi officials. Lyne also contends that the Nazis were developing their own nuclear technology and even issued morale boosting postcards to the German troops showing an atomic bomb exploding over New York City. Whether the stories are factual or not, it's worth the purchase price of the DVD just to listen to the tales. One should of course form one's own opinion as to their veracity, but they appeal to the imagination in any case.

As for Paul Scarzo, the mastermind of "The 33rd Parallel" DVD and video series has fallen on hard times recently. After losing his job at Disney Studios, he began to suffer from paranoia and depression, even having nightmares of being attacked by armies of mice. According to a recent article in "The Conspiracy Journal," this is a common affliction suffered by laid off Disney employees, something called "Mickey Mouse Syndrome." In Scarzo's case, he ended up threatening to shoot his girlfriend and himself, and was taken into custody at the Los Angeles County Jail after a confrontation with police. Scarzo has reportedly gone underground since being released and his whereabouts remain unknown as of this writing.

So the mystery just gets deeper and more involving as time passes. With "Hitler's Secret Flying Saucers," you get not just a wonderful smorgasbord of espionage and conspiracy folklore, as told by William Lyne, but also a glimpse into a still-unfolding human drama of another, more personal kind. Will Scarzo ever show his face again? Is he the victim of the same conspiracies he fought to expose? This DVD will make you care about the answers to those and so many other vital questions.

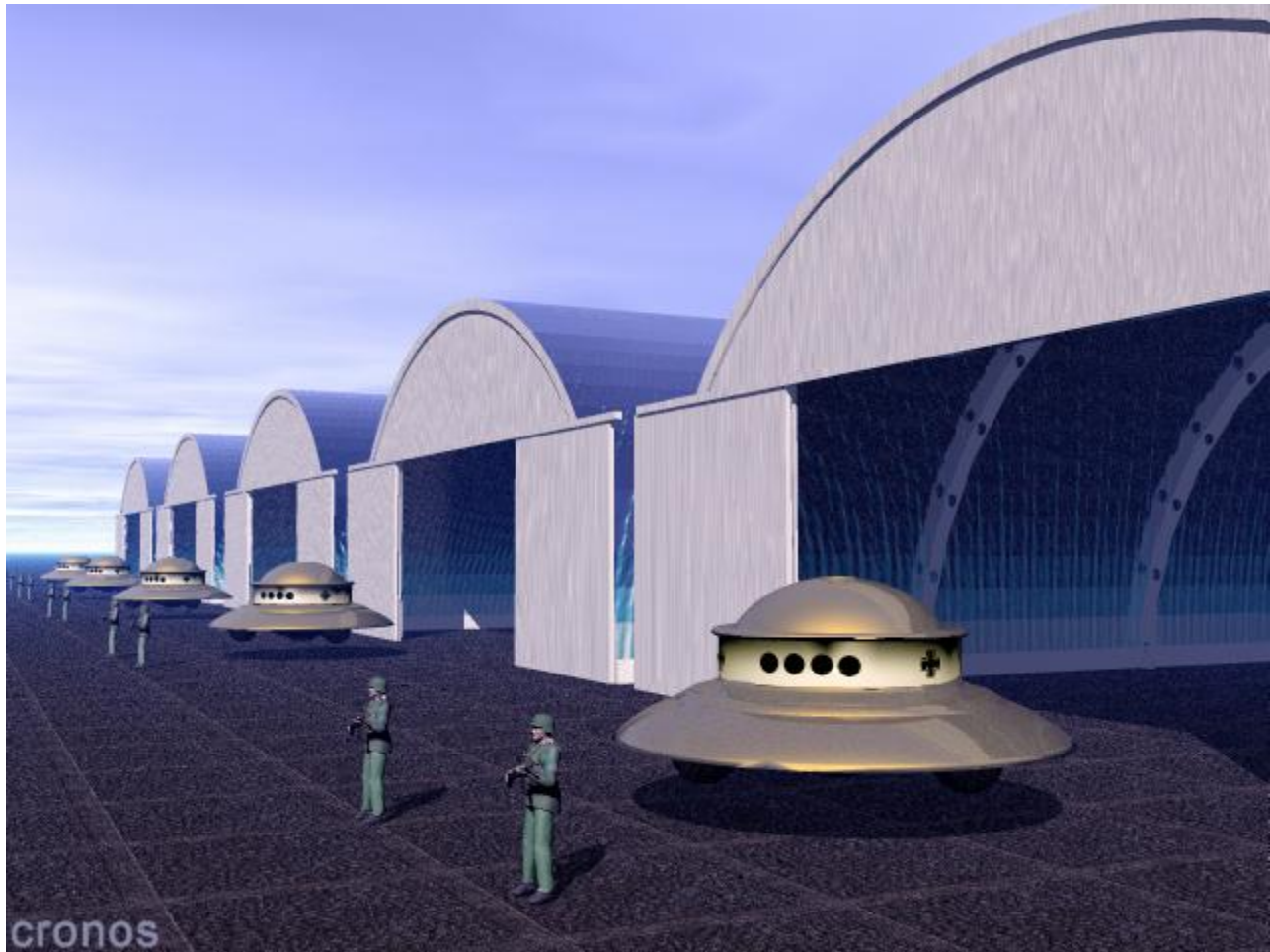

THULE-TRIEBWERK, "HAUNEBU" UND "DO-STRA"

Ganz im Gegenteil zur Vril - Gesellschaft dürften die aus dem Thule - Kreis inspirierten Fluggeräte mit dem "Thule - Triebwerk" sich starker Förderung durch die Führung erfreut haben, obgleich ihre Herstellungsweise sehr viel zeitraubender und in jeder Hinsicht aufwendiger war. Die bei der aus dem Thule - Kreis hervorgegangenen "SS - Entwicklungsabteilung IV" -SS-E-IV - Rundflugzeuge der "Haunebu" - Typenreihe (von den Alliierten ‚Hownebol‘ genannt) besaßen jedoch gegenüber der Vril - Technik den Vorteil, aufgrund des raumsparenden Thule - Triebwerks wesentlich höhere Nutzlasten zu gestatten. Auch die Zellenbauweise war eine völlig andere.

Der Thule/SS - E - IV - Typ "Haunebu II" war in der Tat schon für die Serienfertigung vorgesehen. Zwischen den Flugzeugfirmen Dornier und Junkers soll eine Ausschreibung stattgefunden haben, die Ende März 1945 zugunsten von Dornier ausfiel. Die offizielle Bezeichnung der schweren "Flug kreisel" sollte Do-Stra (= DORNier-STRATosphärenflugzeug) lauten. Es ist aber bekannt, daß es zu dieser Serienfertigung

nicht mehr kam. Die Vor-"Serien" deutscher "UFOs" waren im Grunde bloß hinsichtlich der Triebwerke Serien, während die äußeren Merkmale sich stets unterschieden.

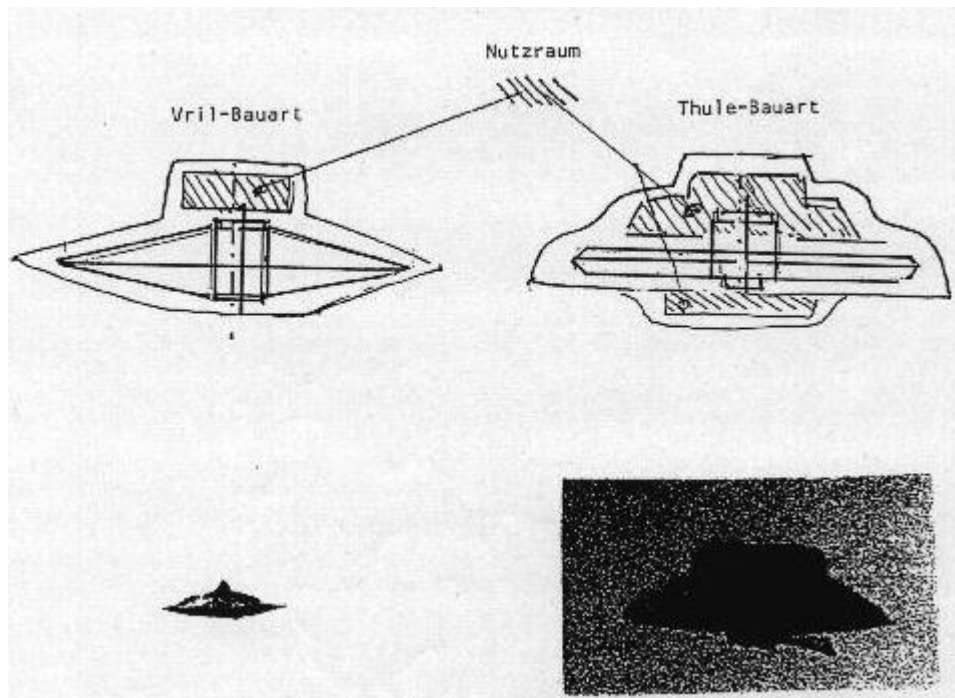

Ganz ausgeschlossen werden kann jedoch nicht, daß der Beginn einer Kleinstserie Haunebu - II/Do-Stra noch gelang. Die verschiedenen "UFO" Fotos, die nach 1945 mit dem ganz typischen Aussehen dieser deutschen Konstruktion auftauchten, legen diese Möglichkeit nahe.

Advanced Propulsion Systems Exposed.



Electrifying Times has published its annual 2001 "Inside Edition" which focuses on technology beyond fuel cells. Advanced propulsion systems include revolutionary magnetic motors and solid-state devices that trap neutrinos from the cosmos to generate unlimited amounts of electricity to propel electric cars worldwide. Tesla used this technology to propel a 1934 Pierce Arrow 80 mph and unlimited range. Similar technology allows UFO's to absorb neutrinos, which are essentially gravity particles that hold the universe together, amplify and manipulate them for unlimited propulsion drive systems for antigravity propulsion and to warp time and space for instiller travel.

Work drawing/plan of the first Haunebu model, built in 1939... It had a diameter of 25m. It flew thanks to what the Germans called a "Magnetic Field Impulser", as specified on the plan

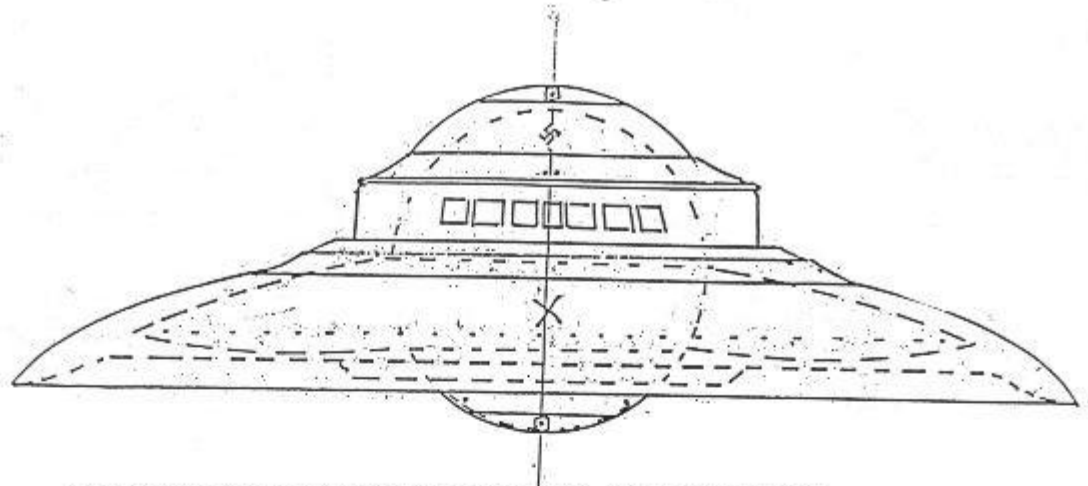
HAUNEBU IMITTELSCHWERER BEWAFNETER FLUGKREISEL, TYPE „HAUNEBU I“

Durchmesser: 25 Meter
 Antrieb: Thule-Tachyonator 7b
 Steuerung: Mag-Feld-Impulser 4
 Geschwindigkeit: 4800 Kilom.p.Std. (recha. bis 17000)
 Reichweite in Flugzeit: 18 Stunden
 Bewaffnung: 2 x Bom KSK in Drehtürmen und 4 x Mk 108, starr nach vorn
 Außenpanzerung: Doppel-Victalen
 Besatzung: 8 Mann
 Weltallfähigkeit: 60 %
 Stillschwebefähigkeit: 8 Minuten
 Allgemeine Flugfähigkeit: Tag wie Nacht
 Grundsätzliche Einsatztauglichkeit: 60 %
 Frontverfügbarkeit: Nicht vor Jahresende .44

Bemerkung: Die SS-E-IV hält Konzentration auf bereits im Versuch stehende „Haunebu II“ für sinnvoller als an beiden Typen parallel weiterzuarbeiten. „Haunebu II“ verspricht entscheidende Verbesserungen in nahezu allen Punkten. Höhere Herstellungskosten scheinen gerechtfertigt - besonders mit Blick auf Führer-Sonderbefehl, Flugkreisel betreffend.

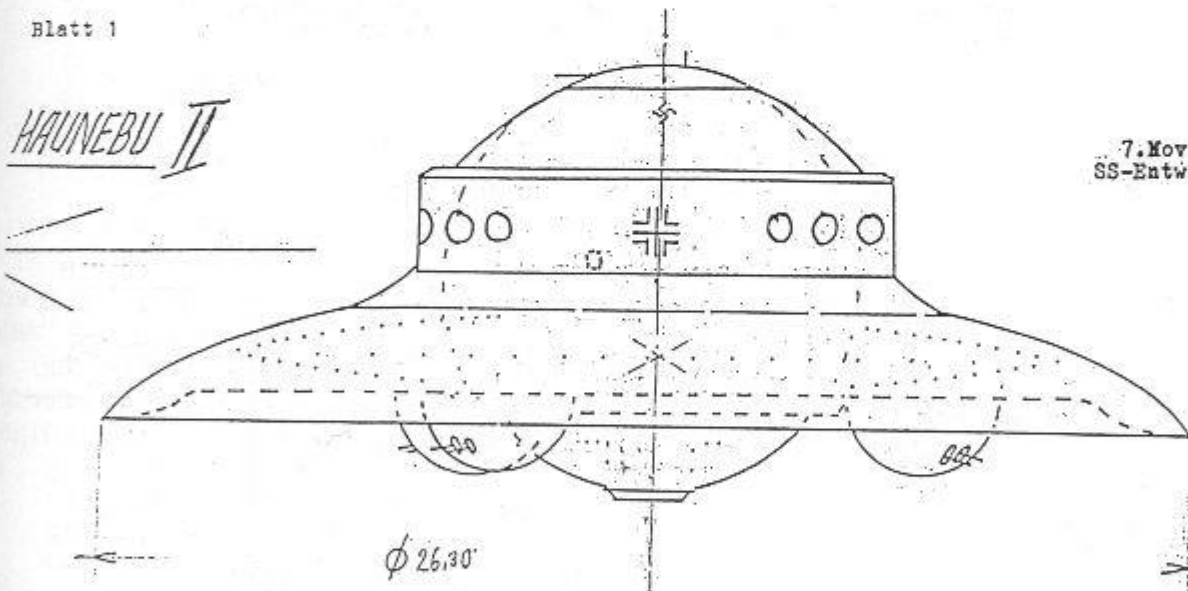
HAUNEBU II

7. November 1943
SS-Entwicklungsstelle IV

MITTELSCHWERER BEWAFNETER FLUGKREISEL, TYPE „HAUNEBU II“

Durchmesser: 26,3 Meter
 Antrieb: „Thule“-Tachyonator 7c (gepanzert; Ø TY.-Scheibe: 23,1 Meter)
 Steuerung: Mag-Feld-Impulser 4a
 Geschwindigkeit: 6000 Kilometer p.Stunde. (rechnerisch bis ca. 21000 möglich)
 Reichweite (in Flugdauer): ca. 55 Stunden
 Bewaffnung: 6 8 cm KSK in drei Drehtürmen, unten, eine 11 cm KSK in einem Drehturm, oben
 Außenpanzerung: Dreischott-„Victalen“
 Besatzung: 9 Mann (erg. Transportverm. bis zu 20 Mann)
 Weltallfähigkeit: 100 %
 Stillschwebefähigkeit: 15 Minuten
 Allgemeines Flugvermögen: Tag und Nacht, Wetterunabhängig
 Grundsätzliche Einsatztauglichkeit (V7): 85 %

Verfügbarkeit „Haunebu II“ (bei weiter gutem Erprobungsverlauf wie V7) ab Oktober.

Enigma Issue 7: Nazi UFO Research

by Paul Vigay | Autumn 1995

The following report was obtained from the Internet and consists of a small extract from the book, "Secret Societies in the Twentieth Century." containing some interesting links between modern occultism and Nazi activities of World War II.

The Occult societies of England and Germany were interlinked in various ways between 1880 and 1920. The influence was mainly from the London Golden Dawn society to Berlin.

Members of the Golden Dawn were among others, Florence Farr, W.B. Yeats, Bram Stoker, Gustav Meyrink, Aleister Crowley and Rudolf Steiner. Members were recruited mainly from the Masonic Lodge in London, and the Rosicrucians. There were also members from the Illuminati. A junior member of the Masonic Lodge in London was a Mr. Winston Churchill who later became a prime minister. And perhaps an instrument of the Golden Dawn.

In 1917 a sort of Golden Dawn colony was founded in Wien, members were Rudolf von Sebottendorf, Karl Haushofer, Lothar Waiz, Gernot, Maria Orsitsch. This society was connected to Gurdijeff, and to a Tibetan holy order (the followers of Tsongkapa), and the order of the Knights of the Temple. This Golden Dawn colony had contact with the order Herren vom Schwarzen Stein (HvSS)

In 1918 the order Thule Gesellschaft was formed. From this grew the DAP, the NSDAP and the SS. A junior member of the Thule Gesellschaft was a young Adolf Hitler, who was a keen occultist, experimenting with Mescaline and other drugs to gain mystical insight. Hitler was later to become an instrument of the Thule Order as the Reichsführer. The beliefs and ideas of the Thule Order remained more or less those of the Golden Dawn.

In 1919 the Thule Order held meetings in Ramsau where the Yugoslavian medium Maria Orsitsch received a technology offer from space aliens from Aldebaran. They gave the Thule Order plans for a time machine, or rather a dimension machine. Important components were counter-rotating magnets. Dr. W. O. Schumann from the Munchen Technical University worked on the plans for 3 years, and a first model was built in 1922, with unknown results. The Austrian Schapeller seems to have developed the ideas further during the next 10 years.

June 1934 flew the first German built flying saucer, the model RFZ1, which was built in the airplane factory Arado in Brandenburg. The saucer levitated to an altitude of 60m, lost stability, and was dancing around in the air for a few minutes. The control machinery model Arado 196 was quite unsatisfactory, but the test pilot (Lothar Waiz) managed to set the machine down. He jumped out and ran away, while the saucer began to slide around on the ground until it went apart.

Later, in 1934 the second saucer, RFZ 2, was ready with a new control system. It was 5m in diameter, emitted a coloured light, and the contour became hazy when it flew. It could fly. In the years until 1940 prototypes were further developed. It had long distance capabilities, and did a flight to South America in 1941. It lacked the manoeuvrability of the ME109, and it was unarmed. It wasn't built in quantity.

1942 saw the lightly armed Vril-1-Jaeger flying. It was 11.5m in diameter, was one seated, could reach supersonic speeds, could do 90 degree turns at full speed, and could leave the atmosphere. 17 copies were built of this model.

A two seated variety was also built.

Around 1940 a jet propelled saucer version, the V-7 was built. This was a totally different design by Andreas Epp. This had no magnetic propulsion. Several copies were built.

A combination was the RFZ 7. It had a dual propulsion system, jet motors and a magnetic motor. It was on this model that Schriever, Habermohl, Miethe and Belluzo were working. The diameter was 42m, and the prototype was lost on a flight to Spitzbergen. This model was intended to eventually carry nuclear weapons. The RFZ 7 was unsatisfactory. A second prototype flew outside Prague. A third prototype was the RFZ 7 T, which was better, but still not performing well, compared to the RFZ 2.

A SS-special task force, the SS-E-IV, the development group of the black sun, had the task of researching alternative energy sources, which did not require the scarce fuel oil. In this group the magnet motor, and the tachyon converter invented by Hans Coler were developed and combined. As early as 1939 the first prototype flew with this motor, under the name RFZ 5 or Haunebu I. It carried a crew of 8, was 25 m diameter, and was supersonic. It had 6 cm machine-guns type KSK, and 4 smaller machine-guns type MK 106. It could not fly at high altitudes.

In 1942, a prototype HAUNEBU II was ready. Diameter 30m, it carried a crew of minimum 9, maximum 20. It was supersonic and could fly 55 hours.

A prototype HAUNEBU III had 71 meter diameter, had a crew of 32, was supersonic, and could fly for more than 24 hours.

The foo fighters was a general allied name for all saucers. The above mentioned saucers were rarely observed by allied fliers. What they mainly saw was a small unmanned 'Schildtkrote' developed by SS-E-IV. This was supposed to interfere with electrical installations in the allied planes, but was no success.

Another object reported by allied fliers as a foo fighter was the 'Seifenblasen', which was simply a conventional balloon with metal strips, which was designed to interfere with the allied airborne radar. The balloons were no success.

Some of the saucer types could travel interplanetarily, and are alleged to have reached Mars. The first time travel took place in 1944, shortly before the allied conquered Prague. It is rather unclear what were the results of the time travel experiments. The Americans seemed to do similar experiments at the same time.

The Miethe-Belluzzo Disc--Designs Two And Three

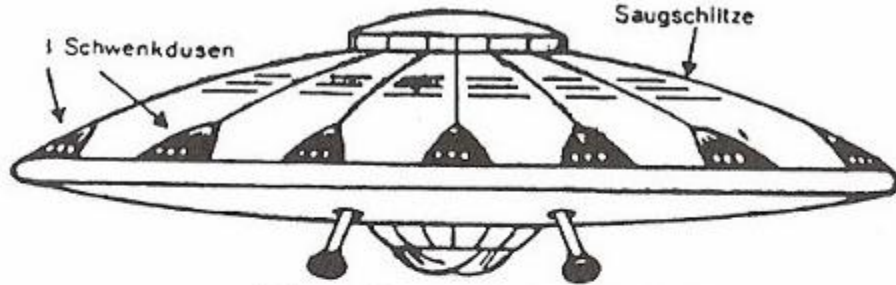

Ballen - Schriever - Miethe - Diskus
Start- und Landebeine, unten aufblasbare
Gummipuffer, ein- und ausfahrbar
Ingenieurszeichnungen

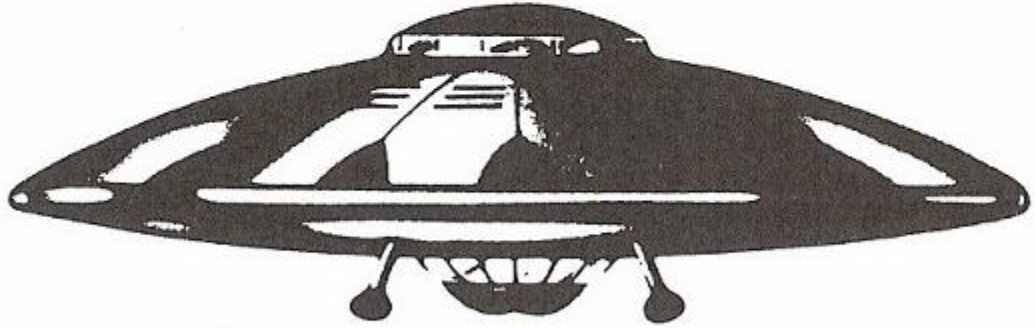

On the top is Miethe-Belluzzo design two. Note rotating disc (2) and stabilizing wheel (7) acting as a gyroscope. (Courtesy of Klaus-Peter Rothkugel) It is the author's opinion that this design was never built. On the bottom is Miethe-Belluzzo design three, capable of vertical take-off.

The Time Machine Project © 2005 Cetin BAL - GSM+90 05366063183

Hiçbir yazı/ resim izinsiz olarak kullanılamaz!! Telif hakları uyarınca bu bir suçtur..! Tüm hakları **Çetin BAL**' a aittir. Kaynak gösterilmek şartıyla siteden alıntı yapılabilir.

The Time Machine Project © 2005 Cetin BAL - GSM:+90 05366063183 -Turkiye/Denizli

[Ana Sayfa](#) / [Index](#) / [Roket bilimi](#) / [E-Mail](#) / [CetinBAL](#) / [Quantum Teleportation-2](#)

[Time Travel Technology](#) / [Ziyaretçi Defteri](#) / [UFO Technology](#) / [Duyuru](#)

Kuantum Teleportation /Kuantum Fizigi /Uçaklar(Aeroplane)

New World Order(Macro Philosophy)/Astronomy

from; <http://www.zamandayolculuk.com/Cetinbal/HTMLdosya1/vriltechnology.htm>
(special thanks to the folks who made this available at the web site!)