

The road to 5G LTE-A evolution, Internet of Things and first 5G aspects

Reiner Stuhlfauth

Technology Marketing Manager

Subject to change – Data without tolerance limits is not binding.
R&S® is a registered trademark of Rohde & Schwarz GmbH & Co. KG. Trade names are trademarks of the owners.
© 2016 ROHDE & SCHWARZ GmbH & Co. KG
Test & Measurement Division

ROHDE & SCHWARZ GmbH reserves the copy right to all of any part of these course notes. Permission to produce, publish or copy sections or pages of these notes or to translate them must first be obtained in writing from
ROHDE & SCHWARZ GmbH & Co. KG, Mühldorfstr. 15, 81671 Munich, Germany



ROHDE & SCHWARZ

5G Standardization

3GPP 5G Standardization Schedule

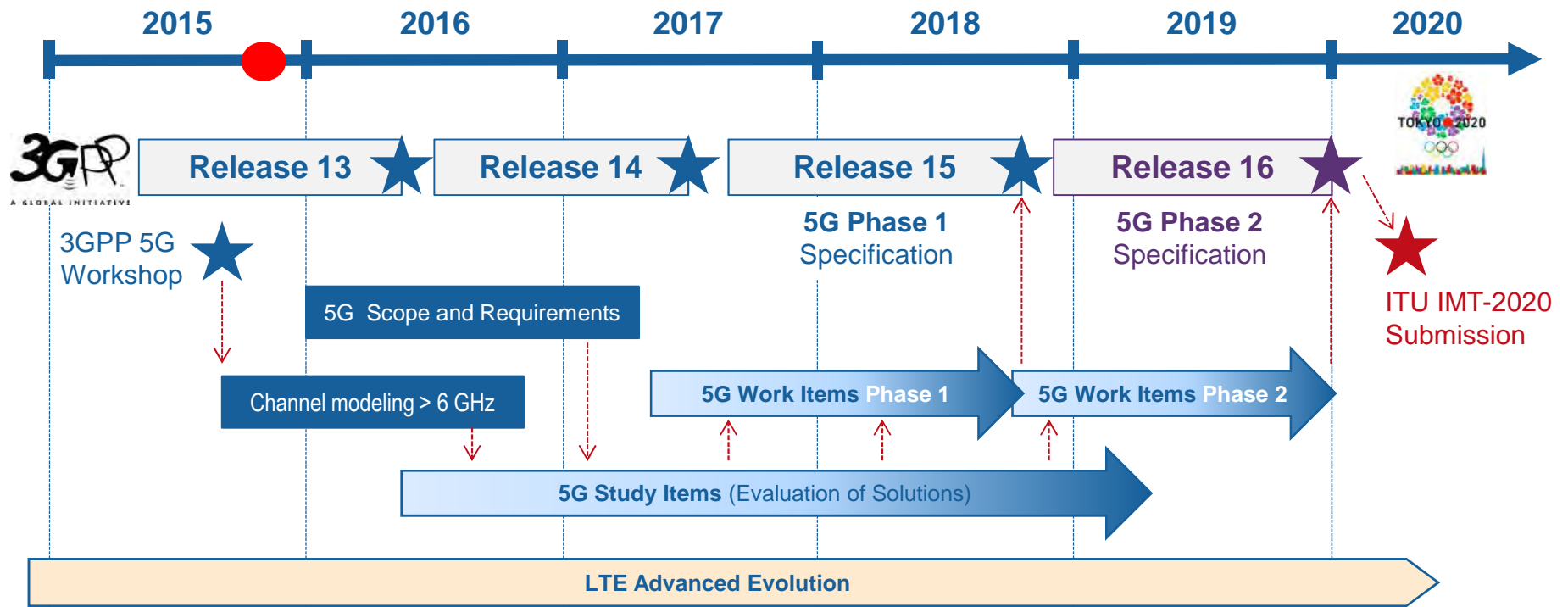

IMT 2020 - services

- Human-centric use cases for multi-media content
- Come with new application areas and requirements for improved QoE
- Cover a ranges of coverage, mobility, and data rate

eMBB

Enhanced Mobile Broadband

- Stringent requirements for throughput, latency and availability
- Covering industrial manufacturing, production processes, remote medical surgery, and transportation safety

- Typically transmitting a relatively low volume of non-delay-sensitive data
- Requiring low cost and a very long battery life

mMTC

Massive Machine Type Communications

Future IMT

Ultra-reliable and Low Latency Communications

uMTC

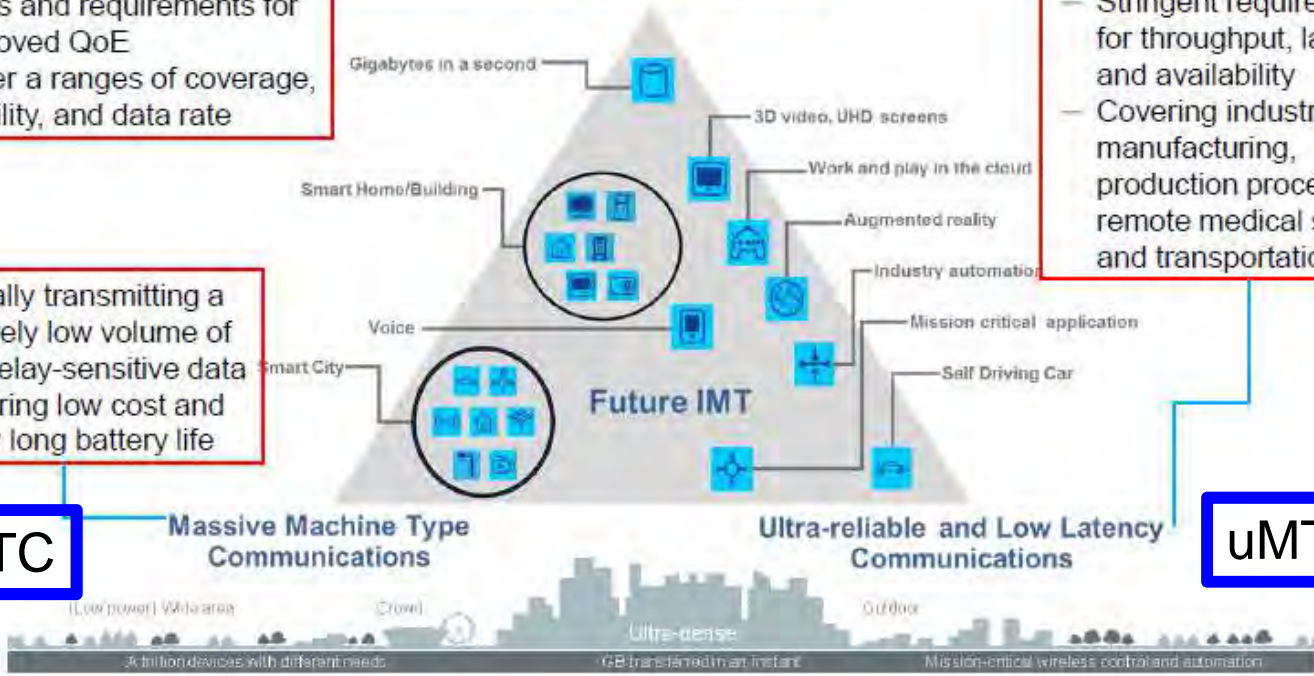

From Link Efficiency to System Efficiency

Legacy focus



One RAT: link adaptation with coding + modulation to send as much data as possible

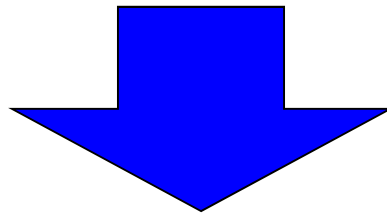

Future focus

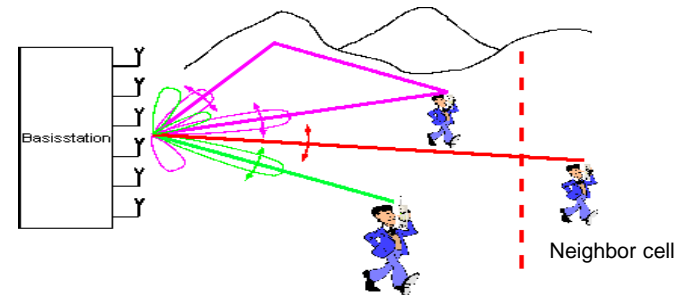
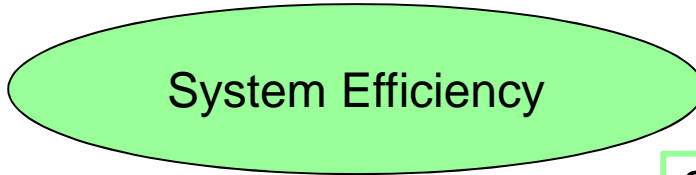

System adaptation, to select the RAT that offers the best data transmission according to the requested quality of service for each service

Air interface framework for 5G

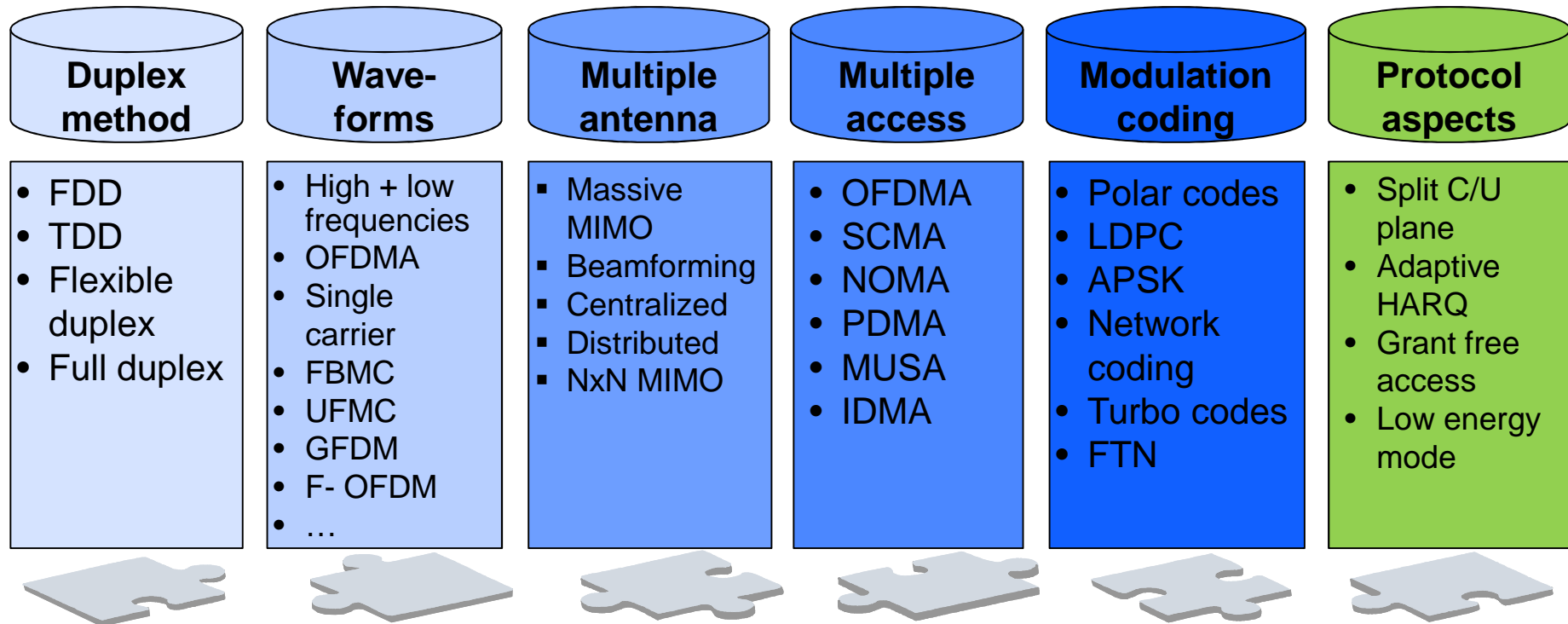

Various combinations of above methods to fulfill multiple scenarios

Information about UE

UE sends
Capability information
to the network

today

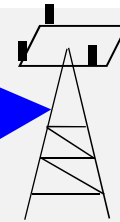
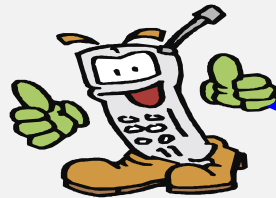

e.g. max power,
RAT support,
bands supported
etc. mainly RF
aspects

You Tube



icloud



Google maps

Werbung bei Spielen

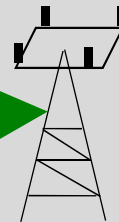
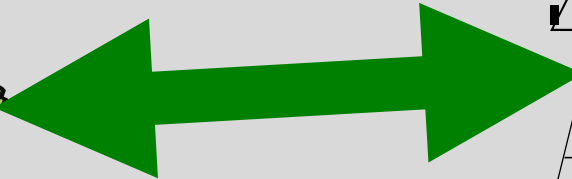

Network may
now conclude
how the UE
may behave,
e.g. mobility,
activity,
bursted traffic

UE sends
Information about installed
applications and behavioural
aspects

future

Technology framework: Protocol aspects / targets

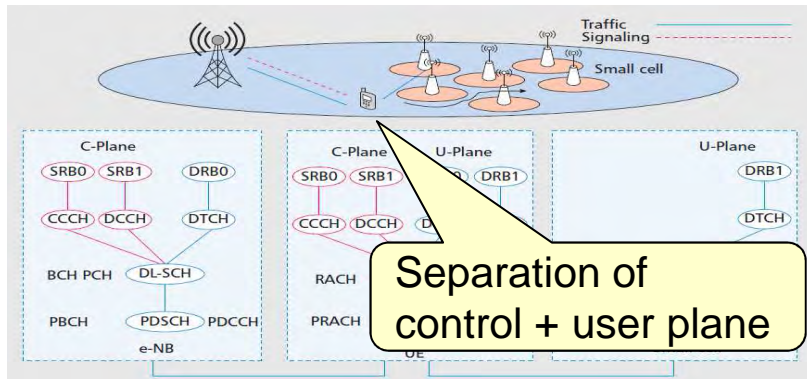

→ Multiple radio connections in parallel

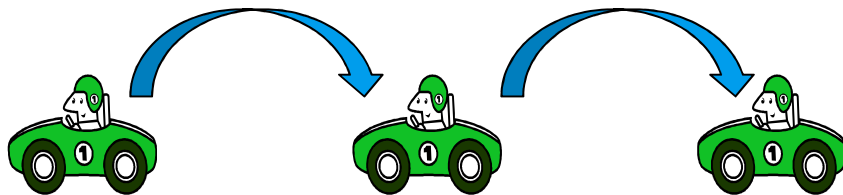

Mesh networks: multihop and device to device

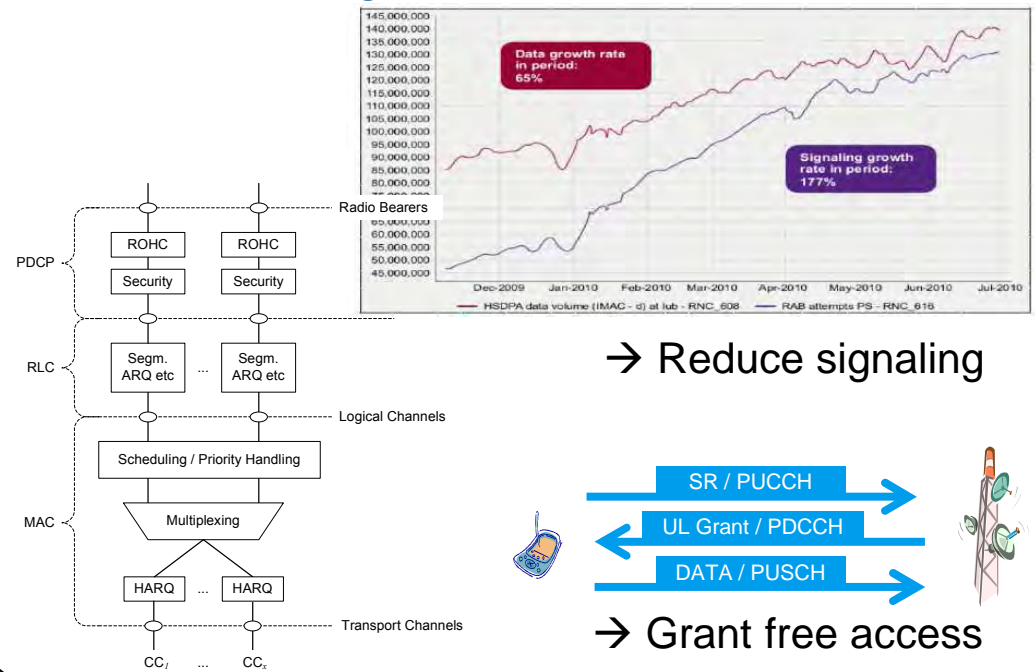

→ Reduce signaling

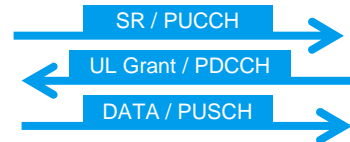

→ Grant free access

→ Light MAC and RRM for energy saving modes

Technology framework: Duplex methods

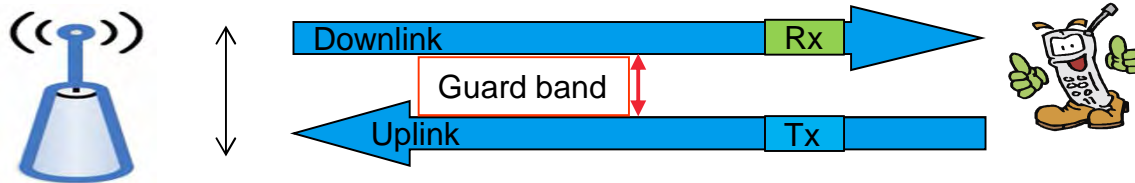

The classics: FDD (guard band) and TDD (guard time)

Duplex = how to separate Rx and Tx?

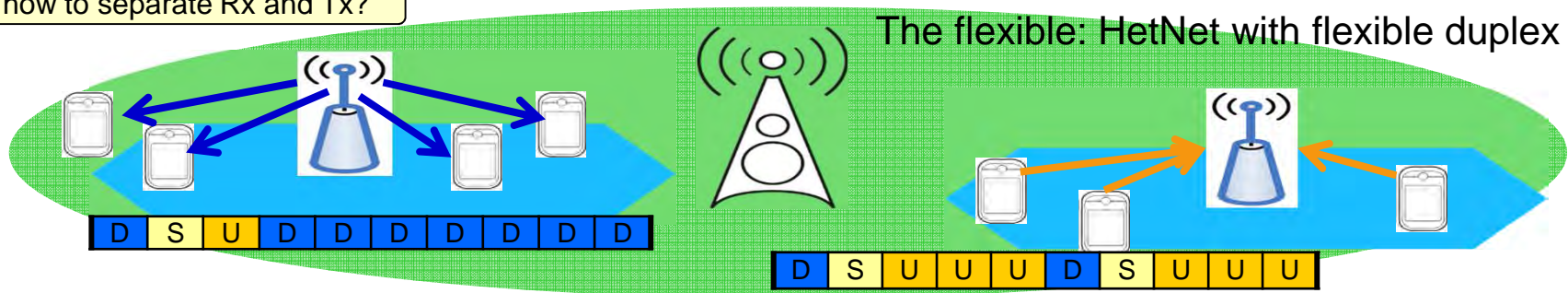

The future outlook:
Full duplex to obtain higher Capacity
(at costs of higher complexity)

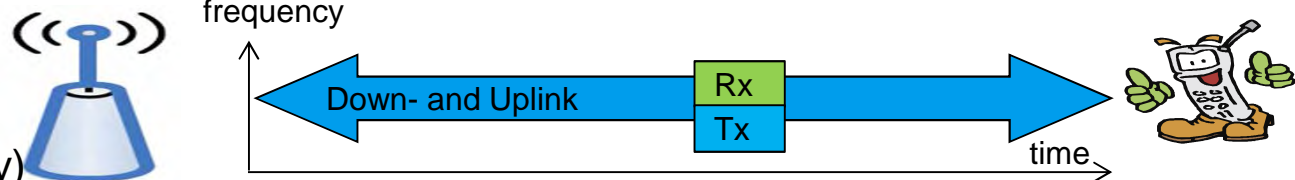

Technology framework: Modulation & Coding

16QAM

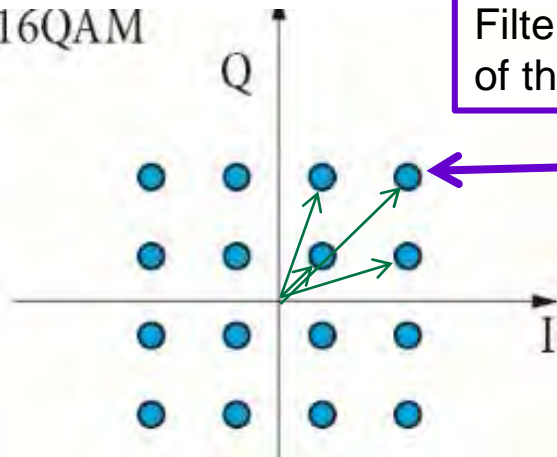

Filter edges may curtail the constellation of the QAM symbols

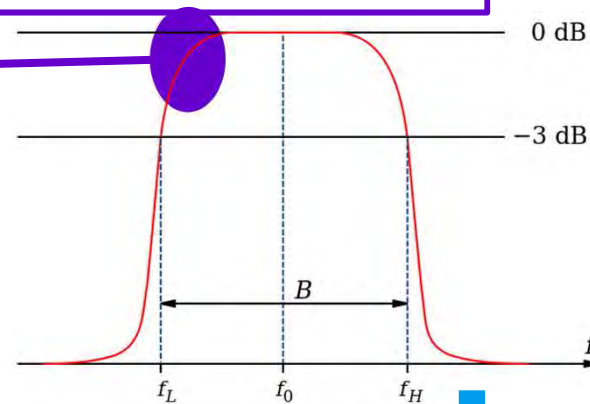

Example: in QAM there are multiple amplitude values
 → dynamic range of power amplifier + Crest factor

Compare to
 e.g. 12 + 4 PSK
 → less amplitude values

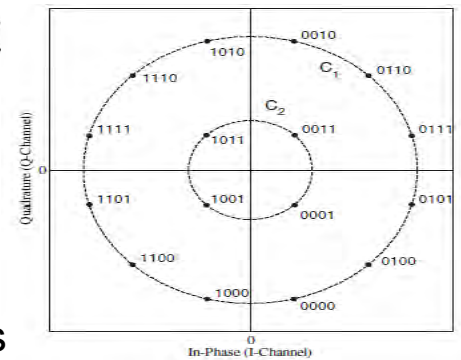

Technology framework: Modulation & Coding

Inter-symbol
Interference free
in time,
Pulses fulfill
Nyquist criterion.

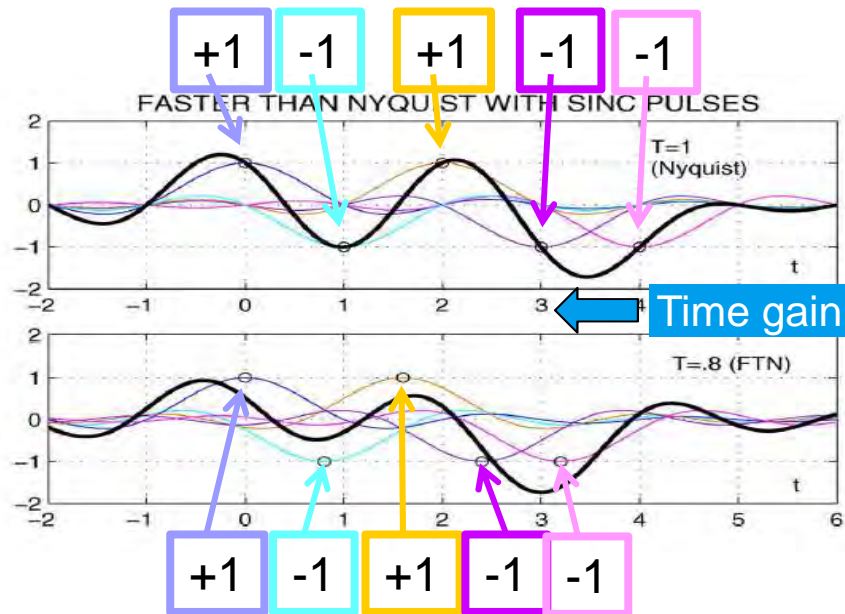

Pulses are no
longer orthogonal.

Coding trends:

- low complexity → energy efficient
- fast decoding → high data rate
- hardware implementation → low latency

But: there is no code supporting all the requests → it looks like multiple codes will coexist depending on the service: LDPC codes, Turbo codes; Polar codes etc.

Pulses are no longer orthogonal, faster symbol rate → Receiver has to remove ISI !
Faster than Nyquist → idea to shorten pulse length and send more data per spectrum

Massive MIMO / mm-Wave MIMO

Beamforming is one important aspect

■ Massive MIMO characterized by

- Very large (i.e. number of Tx elements) antenna array at the base station.
- Large number of users served simultaneously (choosing the right group of antenna elements for the specific users)
- TDD allows channel estimation without UE feedback.
- Leveraging the multiplicity of (uncorrelated) propagation channels to achieve high throughput.



■ mm-Wave MIMO/beamforming characterized by

- Very small (in terms of dimensions) antenna arrays possible
- Highly directional transmission is needed to compensate severe path loss (beamforming used at Tx and Rx)
- Dynamic beam adaptation is essential

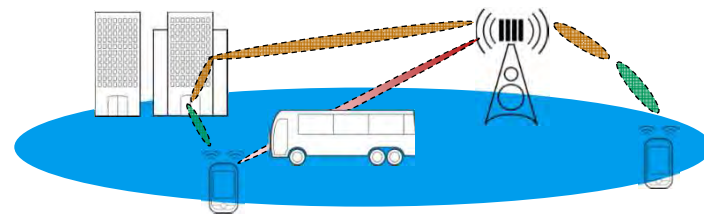

- ▶ Over the air measurements will become much more important
- ▶ Dynamic beamforming verification requires enhancement of the existing test procedures



Architecture outlook, vision from NGMN

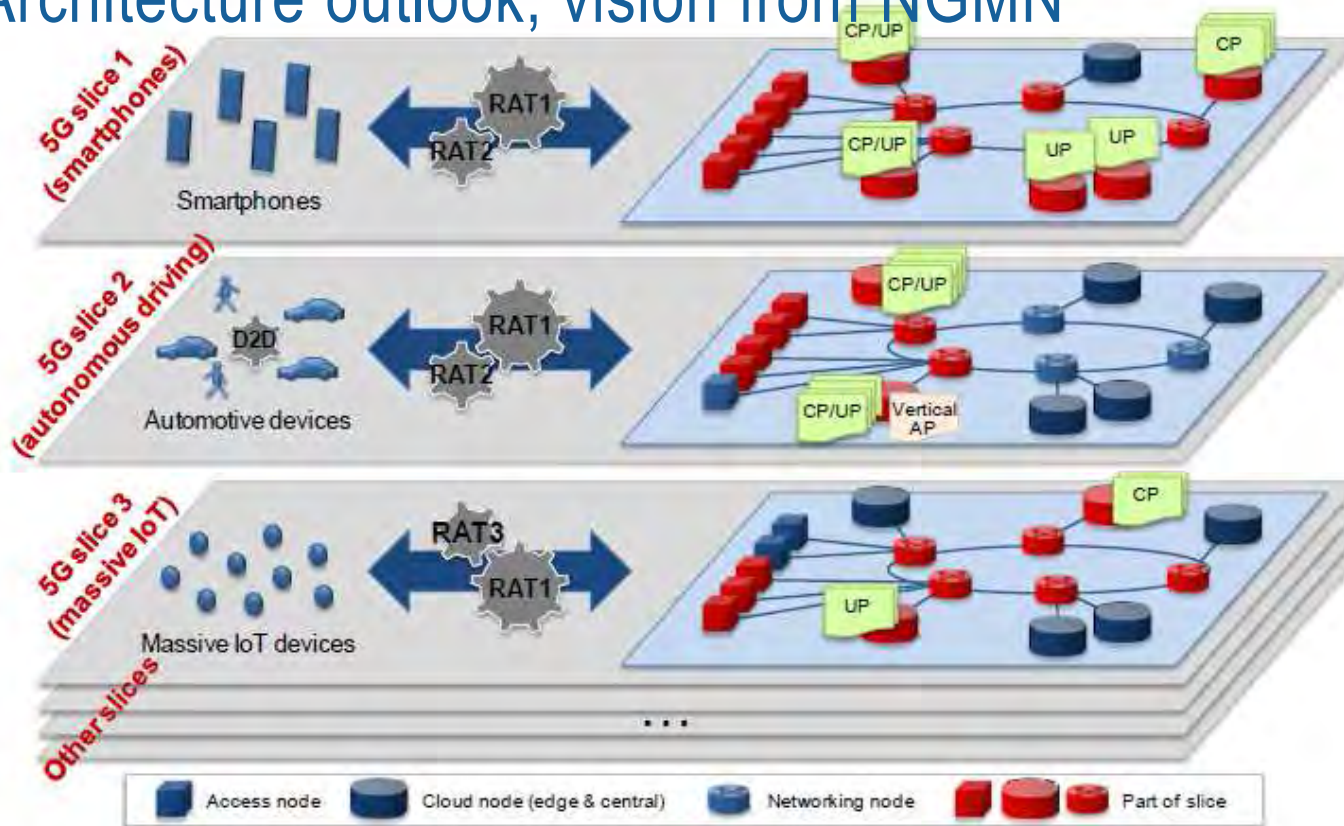

idea of network slicing

3GPP terminology

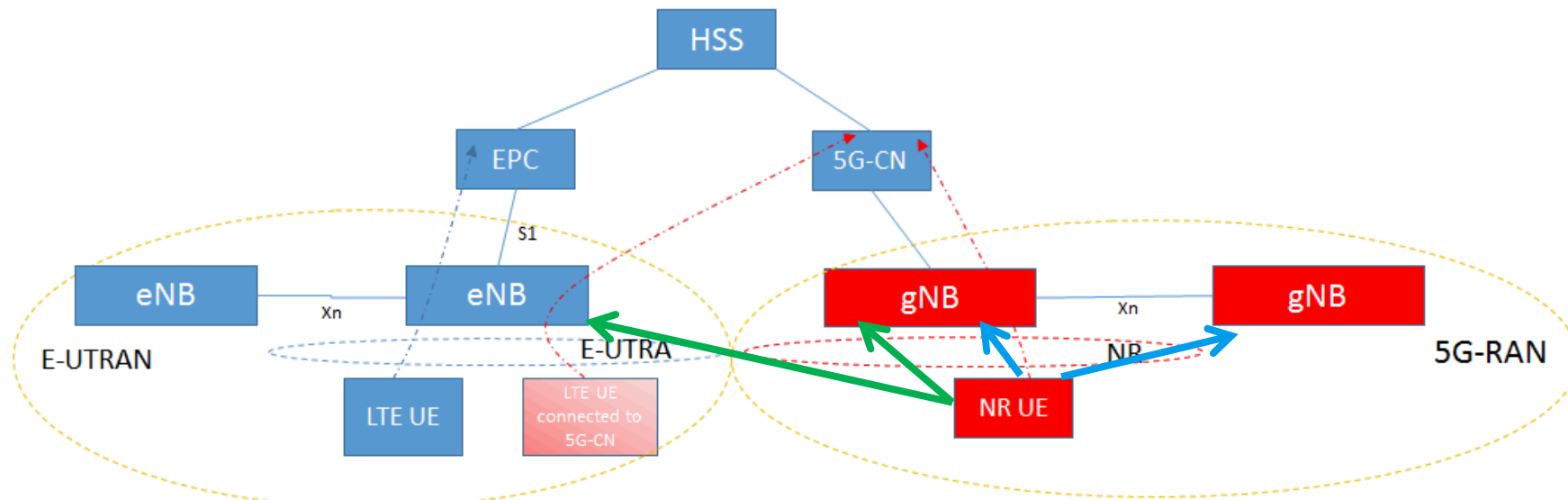

NR DC = new radio dual connectivity

EN- DC = EUTRA + new radio dual connectivity

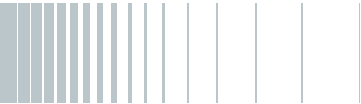

Deployment scenarios

Source: 3GPP TR 38.913 Version 0.3.0 (2016-03)

Scenario	Indoor hotspot	Dense urban	Rural	Urban macro	High speed ⁶⁾ (500 km/h)
Carrier frequency range (aggregated system BW)	4GHz (200MHz) 30GHz ³⁾ (1GHz) 70GHz ⁴⁾ (1GHz)	4GHz (200MHz) 30GHz (1GHz)	700MHz+2GHz (20MHz) 4GHz (200MHz)	2GHz (TBD) 4GHz (200MHz) 30GHz (1GHz)	4GHz (200MHz) 30GHz (1GHz) 70GHz (1GHz)
BS / UE antenna elements ²⁾	256/32 256/8 (4GHz)	256/32 (30GHz) 256/8 (4GHz)	256/8 (4GHz) 64/4 (700MHz)	256/32 (30GHz) 256/8 (4GHz)	256/32 256/8 (4GHz)
Coverage range (indoor/outdoor user distribution in %)	20 m 100%/0%	200 m Macro (3 micro TRPs ⁵⁾ per macro) 80%/20%	1732 / 5000 m 50%/50%	500 m 80%/20%	1732 m 100% users in train
Scenario	Extreme rural ⁷⁾	Urban coverage for mMTC	Highway	Urban grid for connected car ⁹⁾	Air to Ground
Carrier frequency range (aggregated system BW)	< 3GHz (40MHz)	700 MHz (TBD) 2.1GHz (TBD)	< 6GHz (200MHz)	< 6GHz (200MHz)	tbd
BS / UE antenna elements ²⁾	<TBD>	2, 4, 8 (optional) / 1	32/32 (RSU ⁸⁾) 32/8 (in vehicle UE)	32/32 256/8 (4GHz)	[40MHz]
Coverage range (indoor/outdoor user distribution in %)	100 km (even up to 300 km)	500 / 1732 m 80%/20%	500 m 100% in vehicles	500 m Vehicles, bicycles, pedestrian	[100km]

- Frequency range beyond 6 GHz:
- 24 – 40 GHz and 66 – 86 GHz
- Maximum total modulation BW:
- 1 GHz
- Maximum number of UE antenna elements: 32
- Maximum number of BS antenna elements: 256



FCC opens up cm- and mm-Wave spectrum for 5G

- FCC adds additional spectrum for 5G wireless by an anonymously vote on July 14, 2016
- Total of 10.85 GHz will be made available:
 - 28 GHz: 27.5 to 28.35 GHz
 - 37 GHz: 37.0 to 38.6 GHz
 - 39 GHz: 38.6 to 40 GHz
 - 64 to 71 GHz.

Licensed

Unlicensed



2x 425 MHz blocks for the 28 GHz band, country-wide available. Remaining, licensed bands are organized as 200 MHz blocks.

Dedicated to Shared Spectrum Use

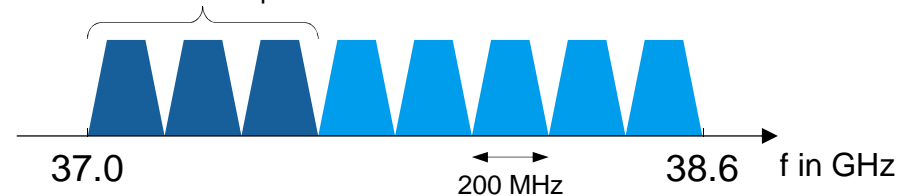

Source: http://transition.fcc.gov/Daily_Releases/Daily_Business/2016/db0714/DOC-340310A1.pdf



Frequency spectrum considerations for 5G in Europe



Measures to support 5G roll-out in EU **"A 5G-ready Europe": Key pre-requisites - spectrum & fibre connectivity**

Info from NGMN at Brussel, EU commission conference, Oct 16

- *Fast track for EU spectrum identification, pioneer bands based on RSPG opinion, 2016;*
- *Full set of bands by end of 2017, technical usage options*
- *Mapping required fiber capillarity towards coordinated investment planning to increase fibre capacity for 5G backhauling, using political target for 5G connectivity along route corridors and train connections by 2025*
- *Best practice for cost reduction of dense cell deployment (emission limits, local taxes, etc), leveraging CODE general authorisations*

Frequency spectrum considerations for 5G in Europe

"The RSPG agreed that the next phase of the multiannual spectrum policy program should be more a **generic programme addressing the spectrum needs of various sectors and not be mainly focussed on wireless broadband only**"

"The RSPG recommends maintaining the possibility to trade and lease the rights of spectrum use in the following frequency bands: 790-862 MHz, 880-915 MHz, 925-960 MHz, 1 710-1 785 MHz, 1 805-1 880 MHz, 1 920-1 980 MHz - 2 110-2 170 MHz, 2.5-2.69 GHz, and 3.4-3.8 GHz (see Article 6.8 of the current RSPP). The RSPG recommends adding any new ECS harmonised band to that list so that every new harmonised band can benefit from this regime."

"The RSPG will continue its efforts and develop recommendations to support the development of 5 G."

"The RSPG recommends the following actions to prepare Europe for new spectrum for 5G above 6 GHz:

- The RSPG should develop **before the end of 2017 an Opinion addressing bands suitable for 5G above 6 GHz**, focusing on those having the best potential for harmonisation. In addition, the RSPG analysis could address the challenges such as: spectrum sharing, network densification, usage conditions, policy implementation, incentive regulation practices. "

Info from NGMN
at Brussel,
EU commission
conference, Oct 16



Frequency spectrum considerations for 5G in Europe

- **700MHz spectrum in particular for IoT use cases (like sensing) requiring good coverage**
- **3.4 - 3.8GHz spectrum for eMBB use cases supporting existing cell deployments (micro/marco cell deployment)**
- **24.25 - 27.5GHz spectrum for eMBB use cases in small cell deployments**

Info from NGMN
at Brussel,
EU commission
conference, Oct 16



New waveform candidates

Comparison: Filter concept

FBMC + GFDM

Individual filter per subcarrier

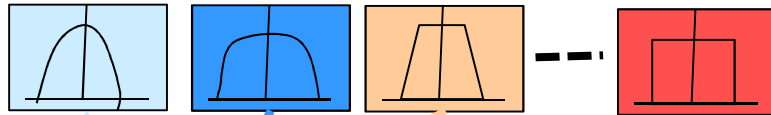

UFMC + F-OFDM

Individual filter per subband

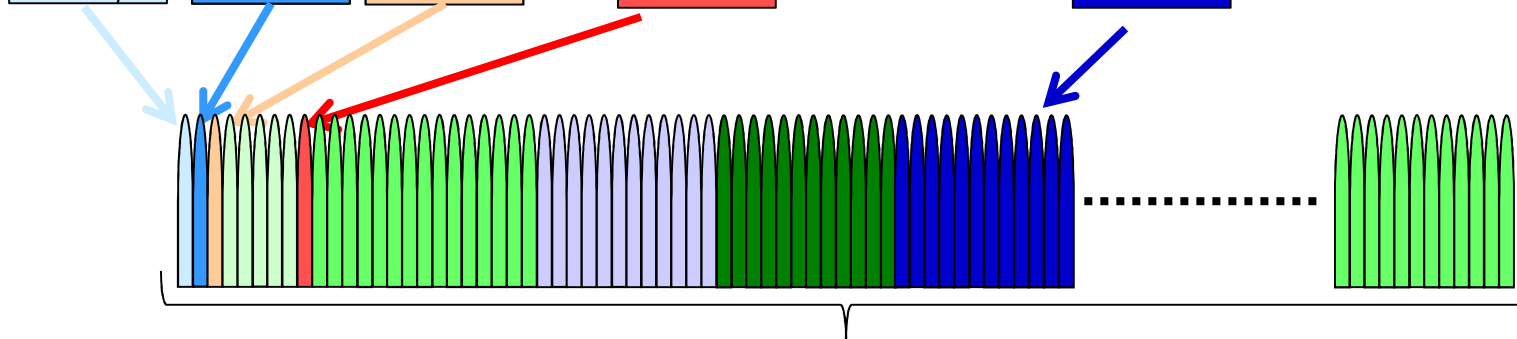
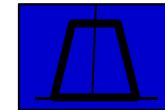

OFDM:

Single filter per whole bandwidth

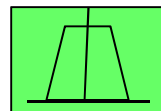

FBMC

Filterbank Multicarrier

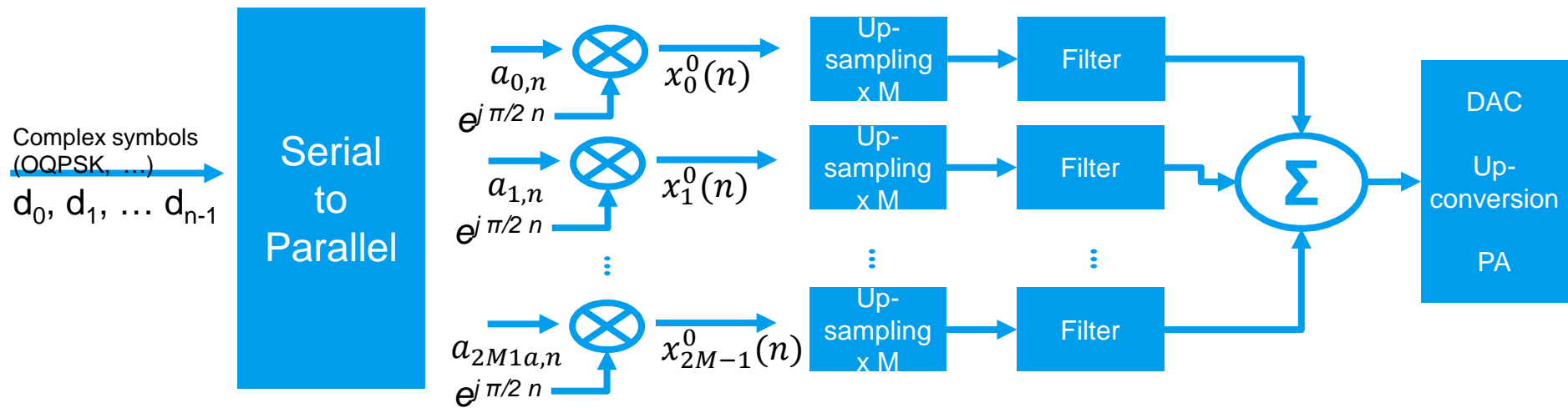
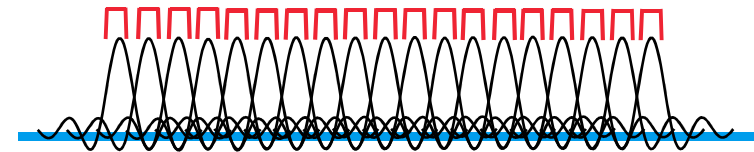

- Each sub-carrier is filtered individually, typically long filter duration
- Typically orthogonality has to be relaxed by using Offset-QAM (OQAM)



UFMC

Universal Filtered Multi-Carrier

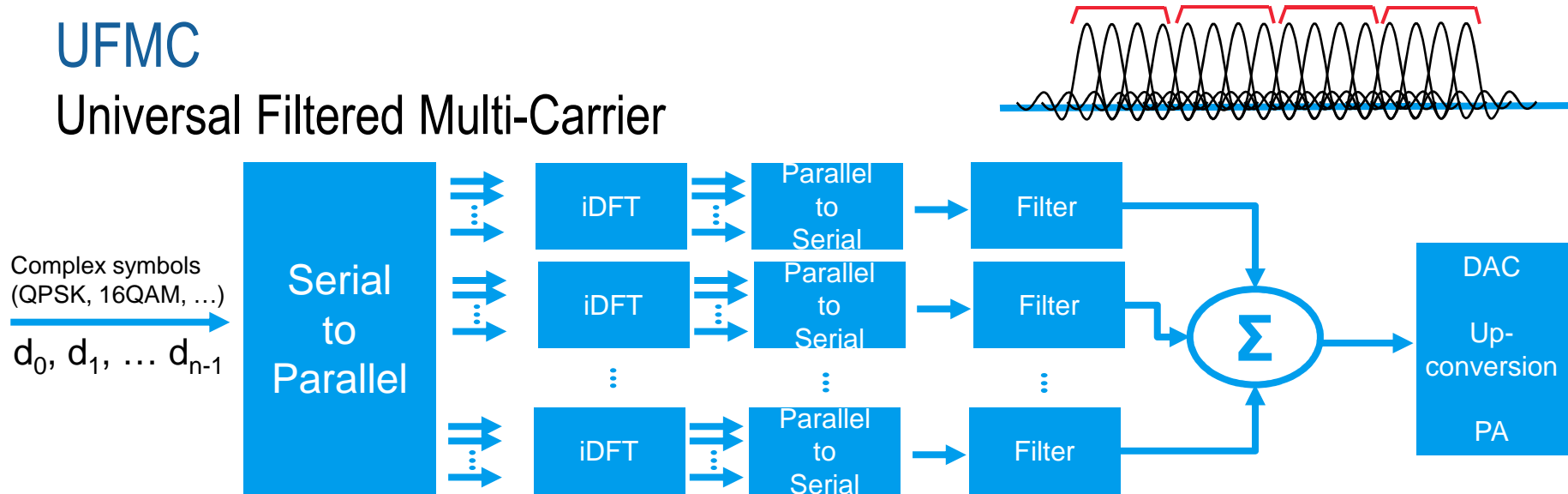

- Groups of carriers (sub-bands) are filtered, typically shorter filters
- Common number of carriers per subband and filter parameters
- Equally sized sub-bands to prevent aliasing
- Non-contiguous sub-bands possible
- Special cases: Only 1 sub-band = OFDM. 1 carrier / sub-band = FBMC

GFDM

Signal Generation

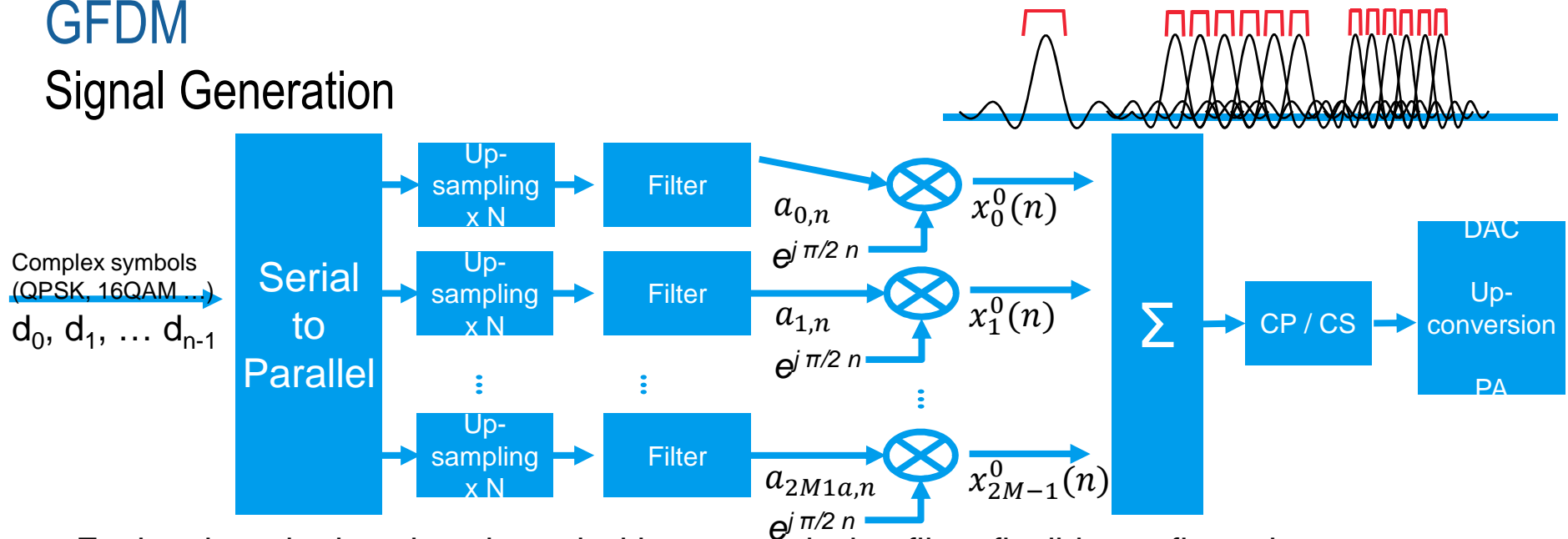

- Each subcarrier is pulse-shaped with a transmission filter, flexible configuration
- Each subcarrier may have a different bandwidth, typical, overlapping -> Rx more difficult
- Filtering by circular convolution to keep sequence length (Tail biting)
- OFDM can be seen as a special case of GFDM.
- Transmission based on a block structure definition, typically short frame length

f-OFDM

Filtered OFDM

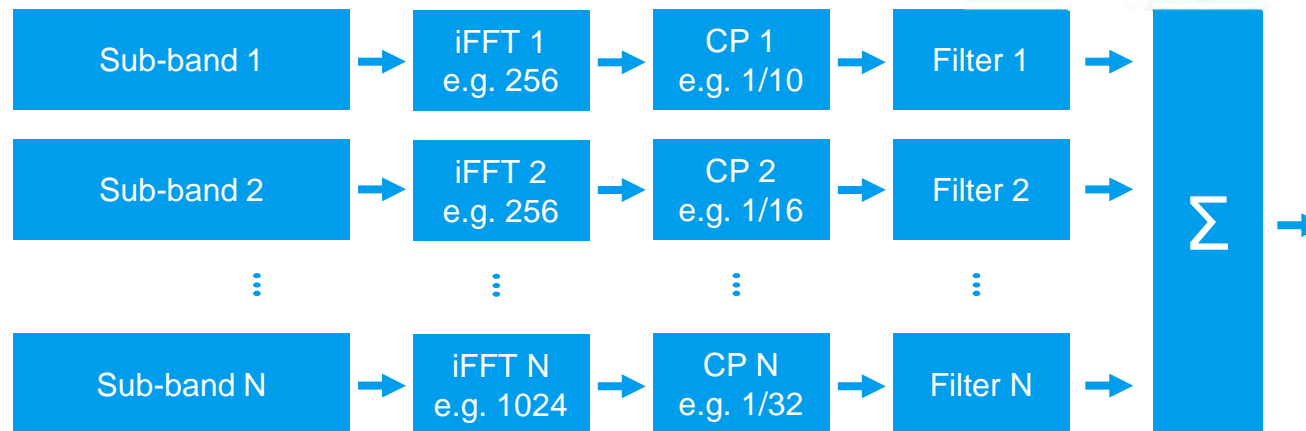
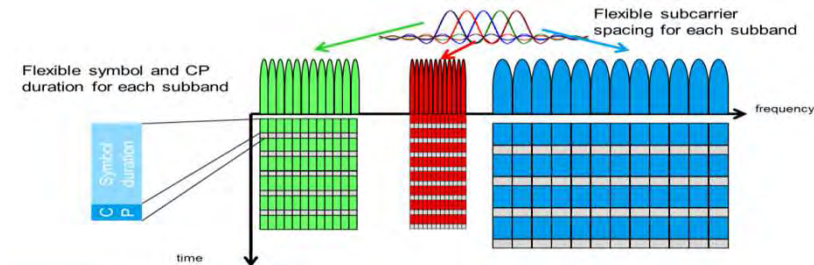

- f-OFDM applies subband specific filtering, various characteristics possible
- Based on OFDM numerology
- Completely different parameter set for each sub-band
 - Sub-carrier spacing, FFT-size, filter, cyclic prefix length

Waveform – summary

- “What is the best waveform for 5G?” => it depends on which scenario is prioritized
- Using the same abbreviation does not implicitly mean we have the same waveform

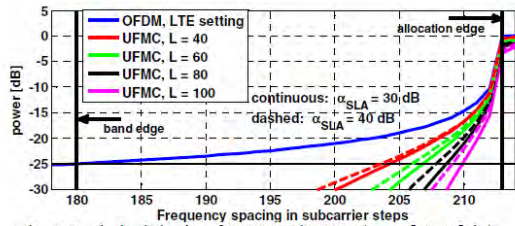
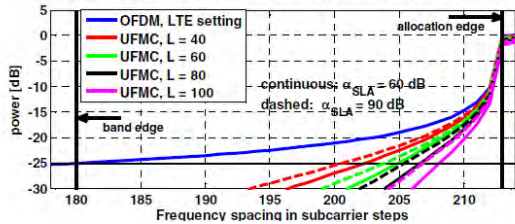
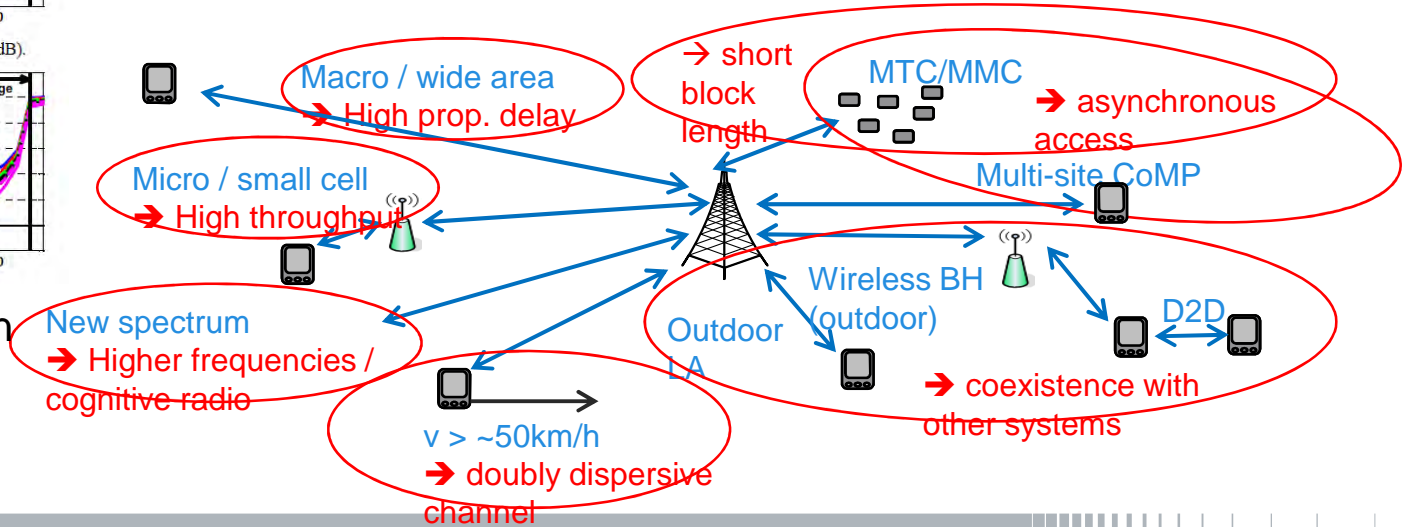

Fig. 6: Band edge behavior of OFDM and UFMC ($\alpha_{SLA} = [30, 40]$ dB).



e.g. out of band emission
 UFMC using
 different filter types



Test Solution for 5G: Waveform candidates

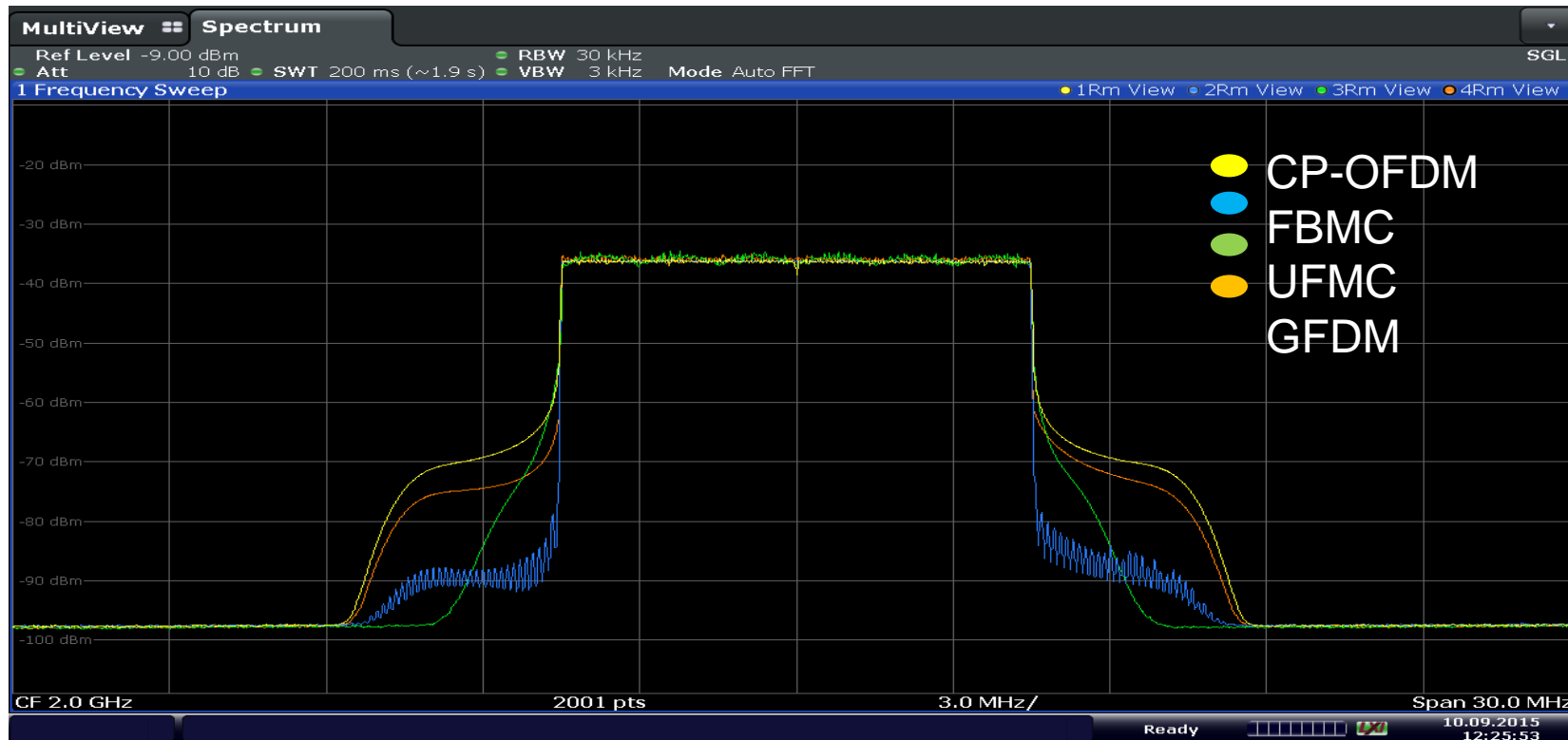

Test Solution for 5G waveform candidates

Spectral measurements with non-linear DUT

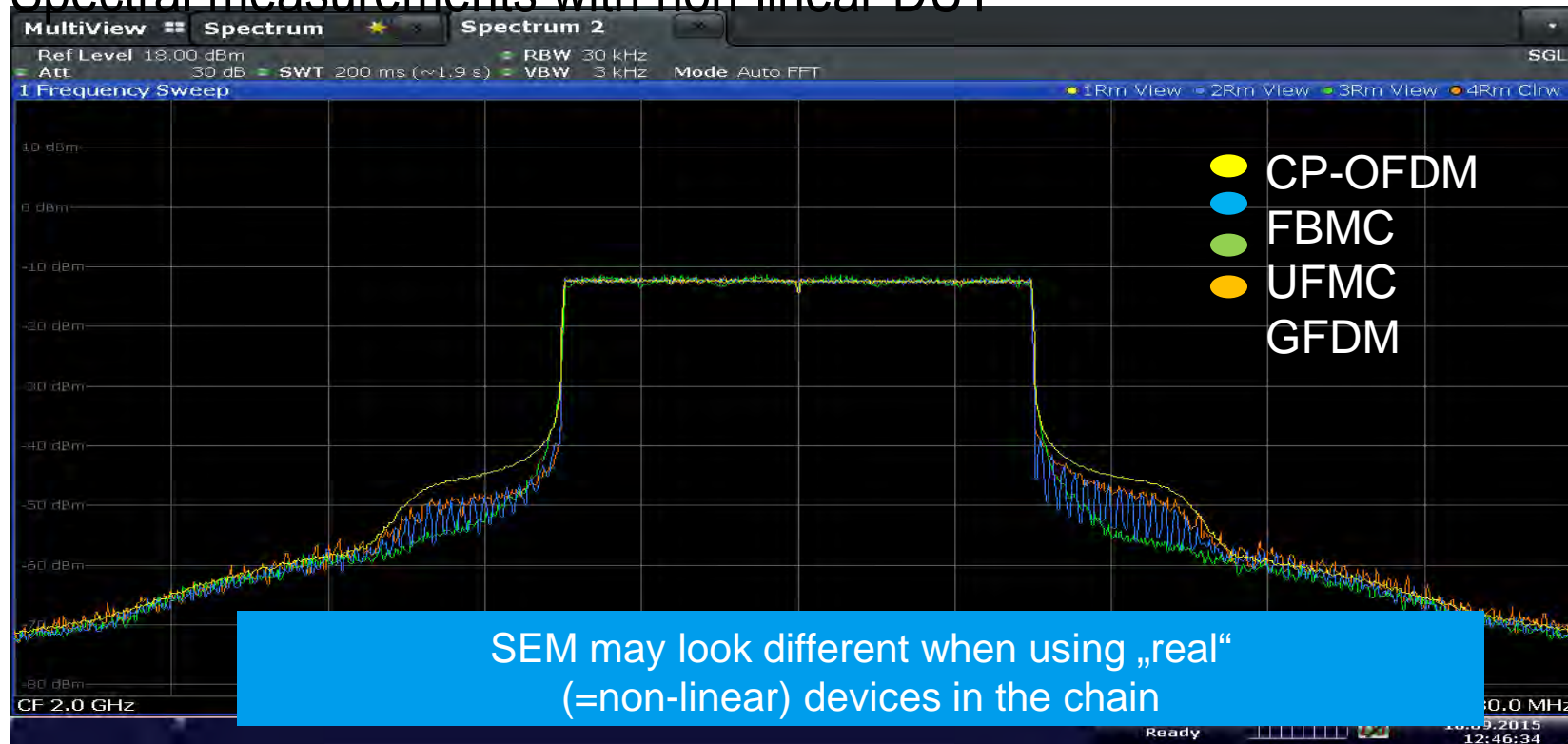

Waveform Gains: From Theory to Reality

From: Waveform theory and simulation

To: Real devices with non-linear elements

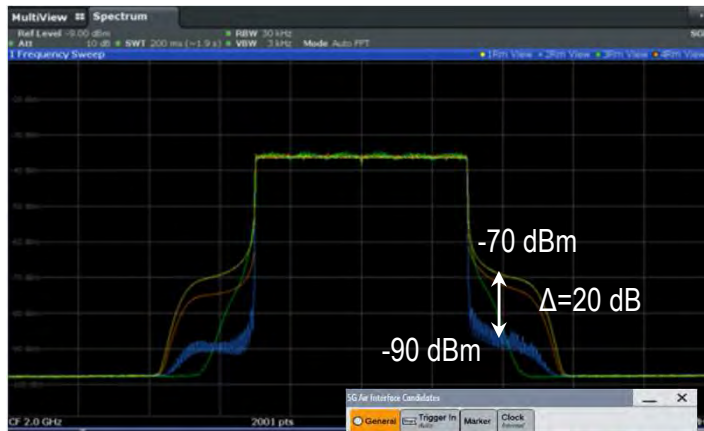

- OFDM
- FBMC
- UFMC
- GFDM

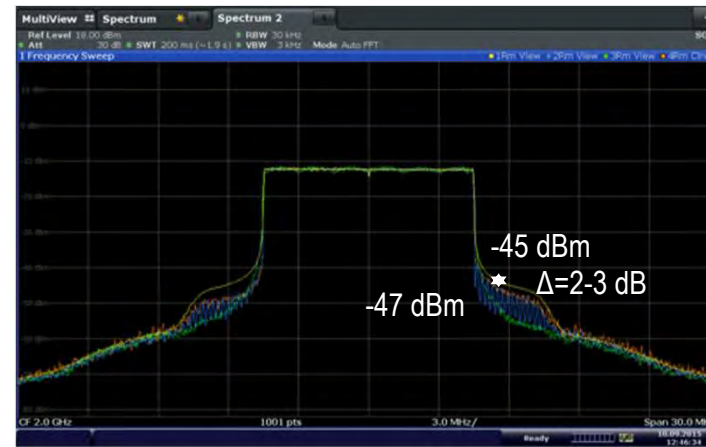

R&S[®]SMW200

R&S[®]FSW85

ARB
Waveform Files

DUT: Power Amplifier

Two use cases: 5G Trial Services, Fixed Wireless Access (FWA)

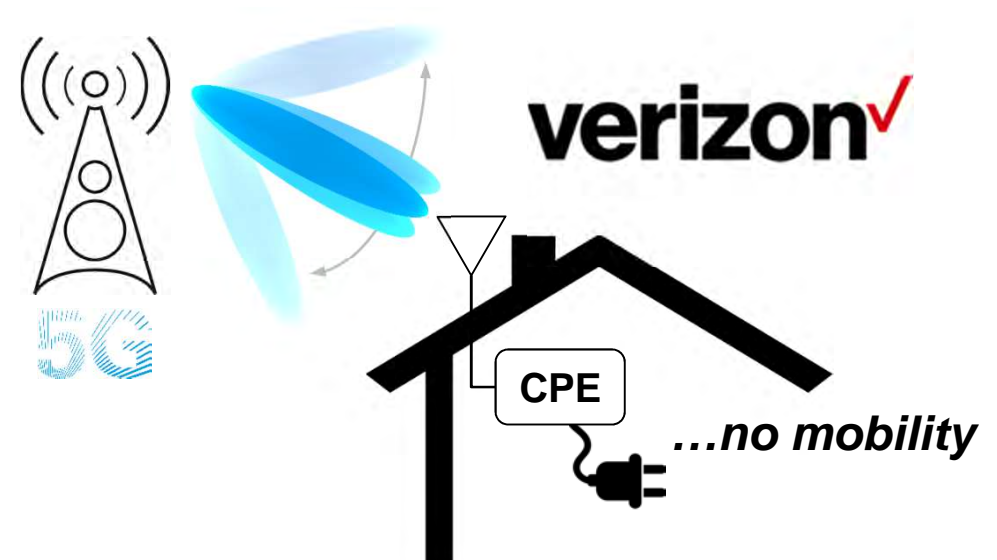

Verizon's Shammo: 5G pilot in 2017 is all about fixed wireless, not mobility

April 21, 2016 | By Monica Allevan

<http://www.fiercewireless.com/tech/story/verizons-shammo-5g-pilot-2017-all-about-fixed-wireless-not-mobility/2016-04-21> [April 2016]



Different network architectures for 5G NR due to SA and NSA (1)

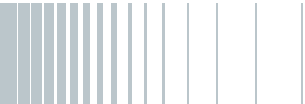
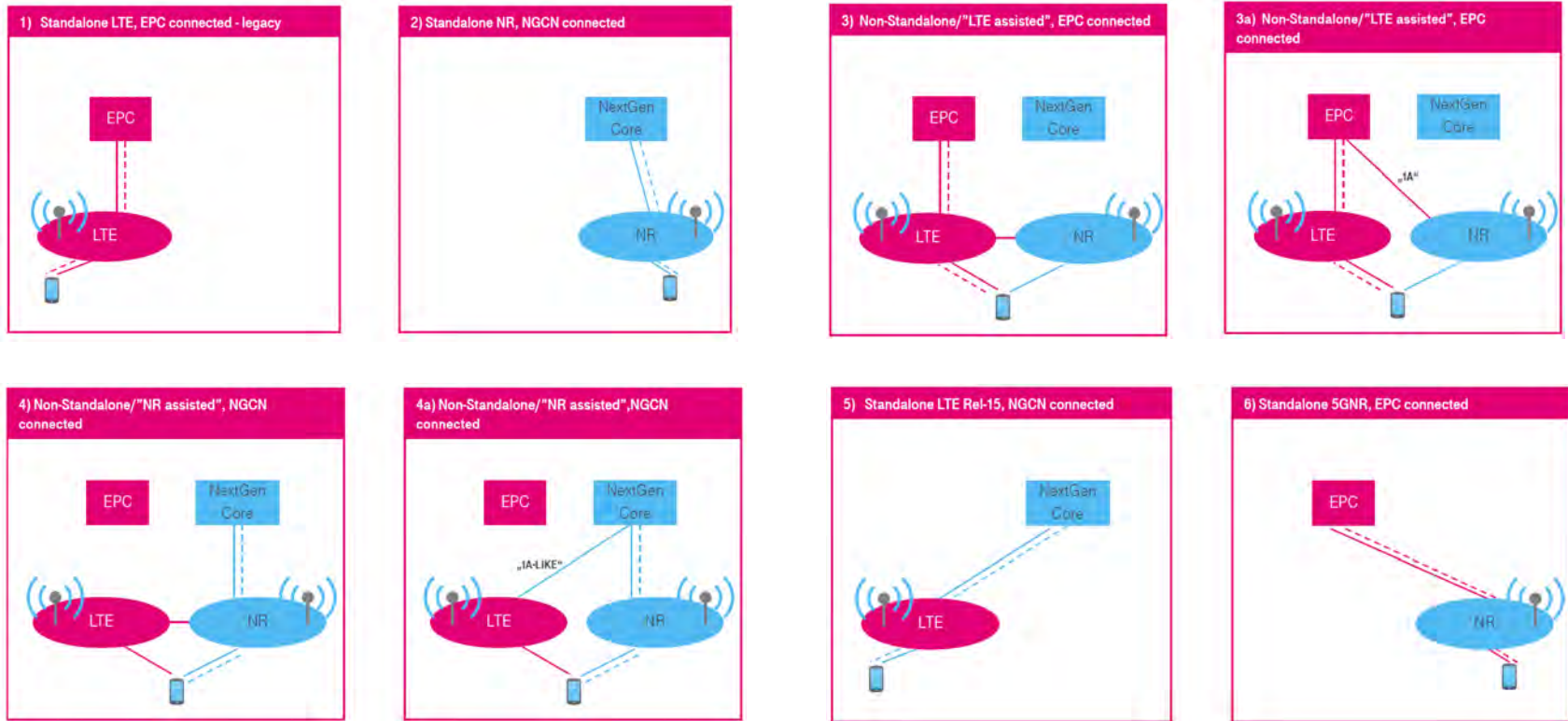

Different network architectures for 5G NR due to SA and NSA (2)

- There are 8 major options possible.
 - Option #1 corresponds to legacy deployed LTE
 - Option #6, #8 will not be studied due to irrelevance, Option #5 is not applicable from RAN2 perspective.
 - Leaves Option #2, #3, #4, #7.

	RAN2	RAN3
Scenario 1	-	-
Scenario 2	YES	YES
Scenario 3 / 3a	YES	YES
Scenario 4 / 4a	YES	YES
Scenario 5	NO	YES
Scenario 6	NO	NO ?
Scenario 7 / 7a	YES	YES
Scenario 8 / 8a	NO	NO

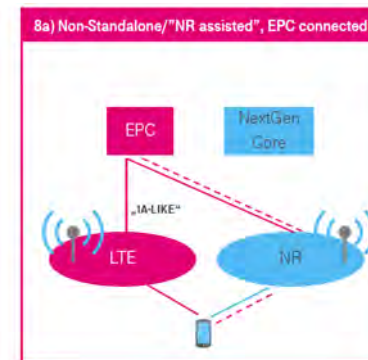
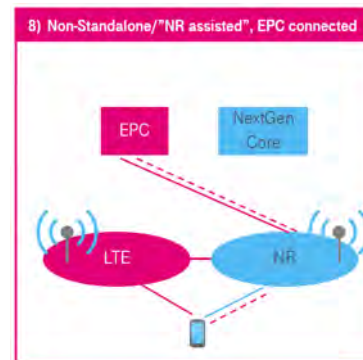
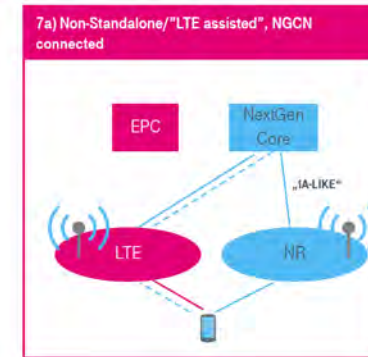
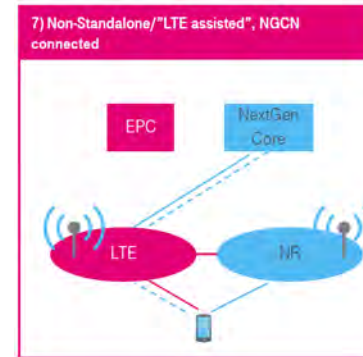

...many operators clearly announce their favor for NSA as a transition from 4G to 5G

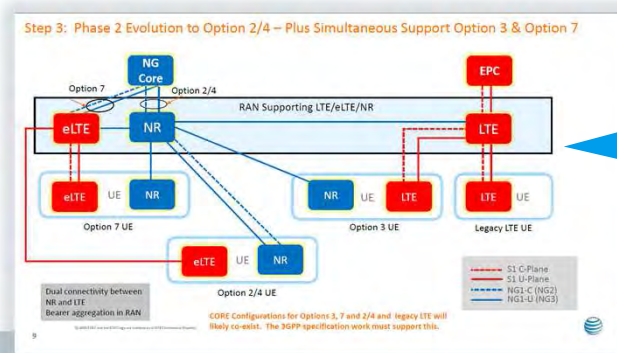
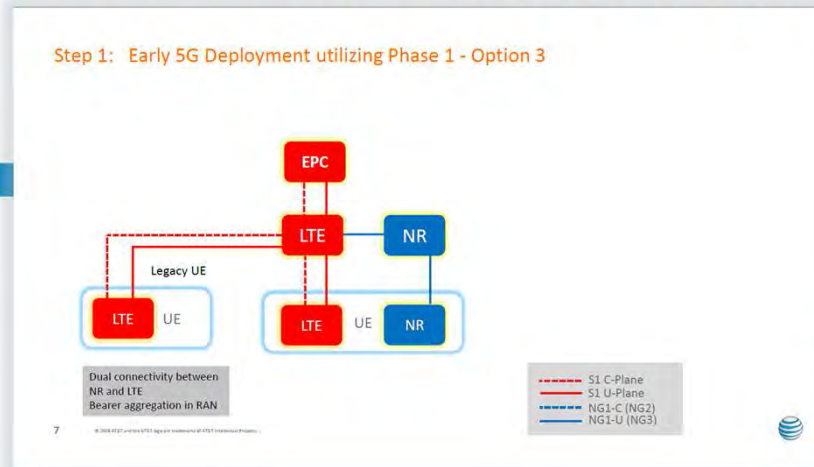

Source: [R3-161772](#) [June 2016]

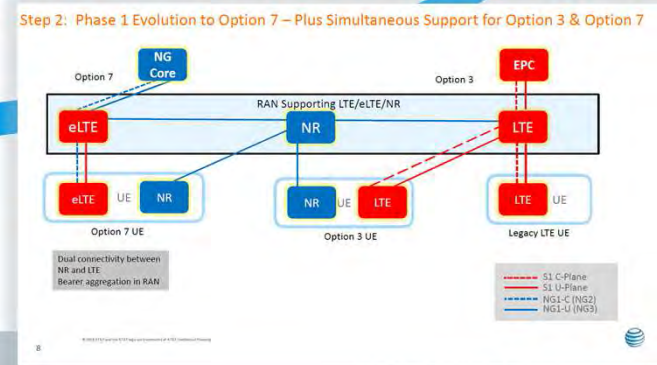

KT's version of 5G Dual Connectivity based on Non-Standalone mode



Control plane

User plane

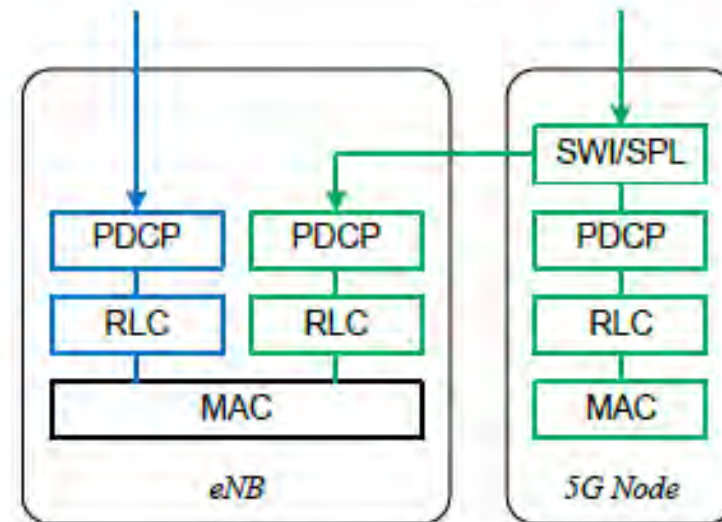
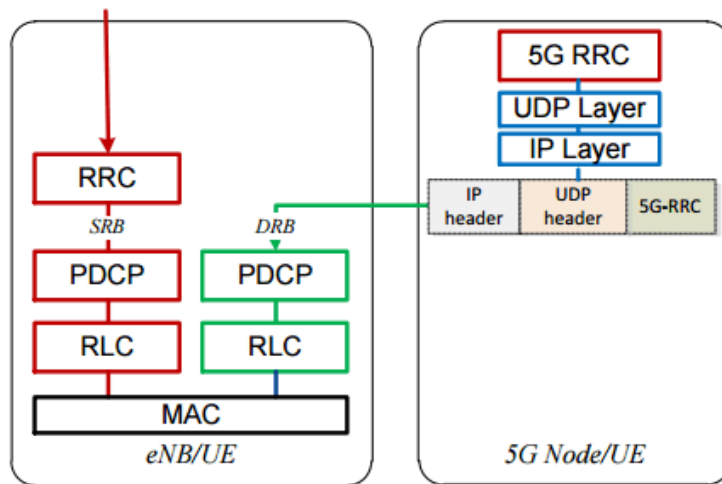

...compare 3GPP's version of 5G NR NSA mode using dual connectivity approach (Rel-12)

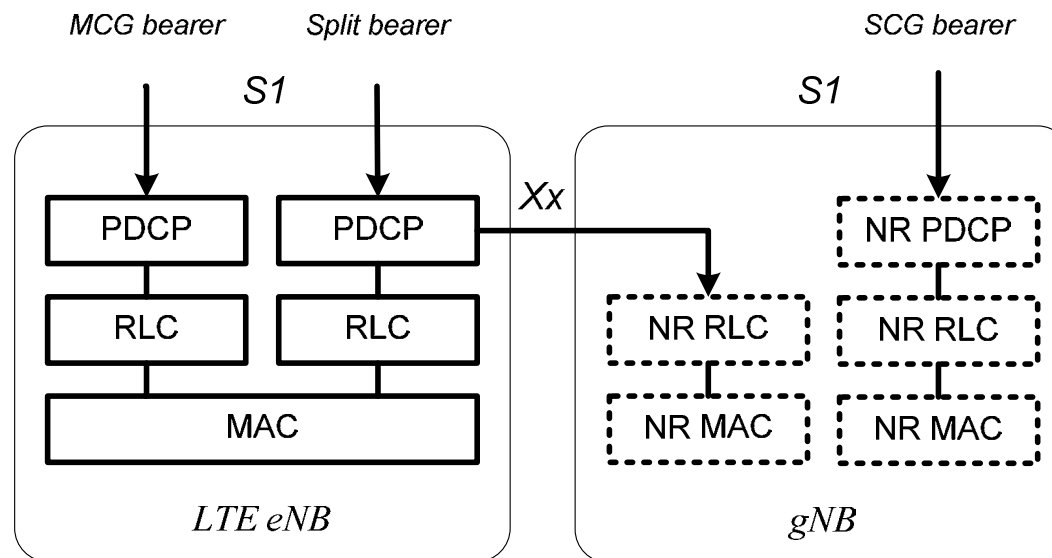

5G scenarios: latency requirements for URLLC

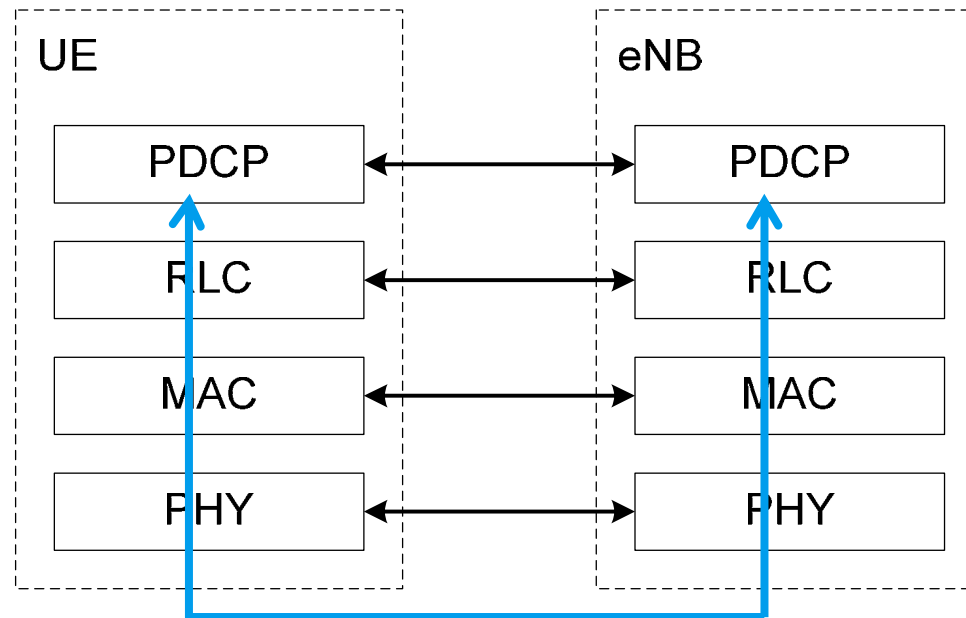

Latency request: radio protocol layer 2/3 SDU ingress point to the radio protocol layer 2/3 SDU egress point via the radio interface ≤ 0.5 msec



Latest RAN#86bis (October 2016) Discussion

Channel Coding

■ Agreement:

- The channel coding scheme for eMBB data is LDPC, at least for information block size $> X$
- FFS until RAN1#87 one of Polar, LDPC, Turbo is supported for information block size of eMBB data $\leq X$
- The selection will focus on all categories of observation, including overall implementation complexity, regardless of the number of coding schemes in the resulting solution (except if other factors are generally roughly equal)
- The value of X is FFS until RAN1#87 (Nov 2016), $128 \leq X \leq 1024$ bits, taking complexity into account
- The channel coding scheme(s) for URLLC, mMTC and control channels are FFS

- Huawei has a concern on the upper value of the range of X to be considered.



Way Forward on Waveform for NR Uplink (RAN1#86bis)

■ Agreement:

- NR Support DFT-S-OFDM based waveform complementary to CP-OFDM waveform, at least for eMBB uplink for up to 40GHz
 - FFS additional low PAPR techniques
 - CP-OFDM waveform can be used for a single-stream and multi-stream (i.e. MIMO) transmissions, while DFT-S-OFDM based waveform is limited to a single stream transmissions (targeting for link budget limited cases)
 - Network can decide and communicate to the UE which one of CP-OFDM and DFT-S-OFDM based waveforms to use
 - **Note: both CP-OFDM and DFT-S-OFDM based waveforms are mandatory for UEs**
- RAN1 should target for a common framework in designing CP-OFDM and DFT-S-OFDM based waveforms (without compromising CP-OFDM performance/complexity), e.g., control channels, RS, etc.
- Discuss further offline for possible refined evaluation assumptions/methodology for waveform



3GPP covers 5G NR in 38er series

spec number	title	notes
TR 38.801	Study on New Radio Access Technology: Radio Access Architecture and Interfaces	
TR 38.802	Study on New Radio Access Technology Physical Layer Aspects	
TR 38.803	TR for Study on New Radio Access Technology: RF and co-existence aspects	
TR 38.804	TR for Study on New Radio Access Technology Radio Interface Protocol Aspects	
TR 38.900	Study on channel model for frequency spectrum above 6 GHz	
TR 38.912	Study on New Radio (NR) Access Technology	
TR 38.913	Study on Scenarios and Requirements for Next Generation Access Technologies	



5G New Radio (NR) numerology



- Current working assumption (WA) based on 3GPP RAN1#85 is that subcarrier scaling is based on $f_0 * 2^m$ with $f_0 = 15$ kHz and scaling factor is 2^m with $m \{-2, 0, 1, \dots, 5\}$

m =	-2	0	1	2	3	4	5	...
Subcarrier Spacing [kHz]	3.75	15	30	60	120	240	480	...
Symbol Length [μ s]	266.67	66.67	33.33	16.67	8.333	4.17	2.08	...
Component Carrier BW [MHz]	FFS							
Cyclic Prefix Length [μ s]	FFS							
Subframe Length [ms] (= $1/2^m$)	4	1	0.5	0.25	0.125	0.0625	0.03125	
Radio Frame Length [ms]								

- Agreements based on RAN1#86 (08/2016)
 - More than one CP length should be studied for a given subcarrier spacing
 - The different CP lengths for a given subcarrier spacing can be of substantially different lengths
 - FFS whether all of subcarrier spacing's support more than one CP length or not.



Comparison LTE and Verizon Wireless 5G

PHY parameterization (1/2)

PHY parameter	LTE (Rel.8-14)	Verizon 5G
Downlink (DL)	OFDM	OFDM
Uplink (UL)	DFT-s-OFDM (SC-FDMA)	OFDM
Subframe Length	1ms	0.2ms
Subcarrier Spacing	15 kHz	75 kHz
Sampling Rate	30.72 MHz	153.6 MHz
Bandwidth	20 MHz	100 MHz
NFFT	2048	2048
OFDM symbol duration, no CP	66.67 us	13.33 us
Frame Length	10 ms	10 ms
#Subframes (#slots)	10 (20)	50 (100)
CP Type	Normal & Extended	Normal Only
Multiplexing	FDD / TDD	Dynamic TDD
Max RBs	6,15,25,50,75,100	100
DL/UL Data coding	Turbo Code	LDPC code



Comparison LTE and Verizon Wireless 5G PHY parameterization (2/2)

- Aggregation of up to 8 carriers 100 MHz each.
 - LTE: 3GPP Rel.10-12: only 5 carriers 20 MHz each.
 - LTE: 3GPP Rel.13: 32 carriers up to 20 MHz each.

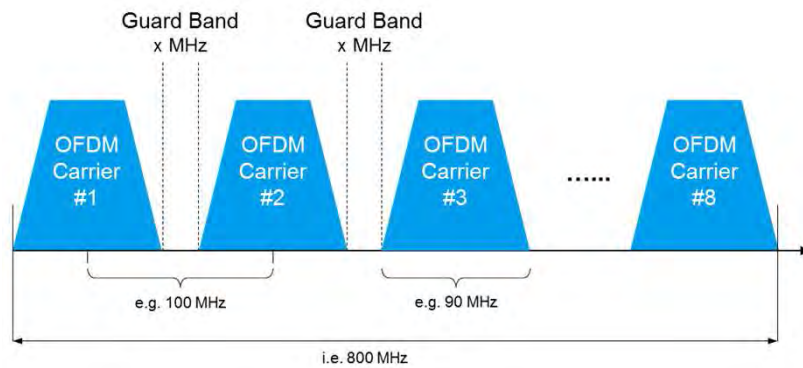

- New PHY signals and new or modified PHY channels, supporting additional capabilities.

Dynamic switch on a subframe basis from downlink to uplink transmission.

- 4 possibilities:

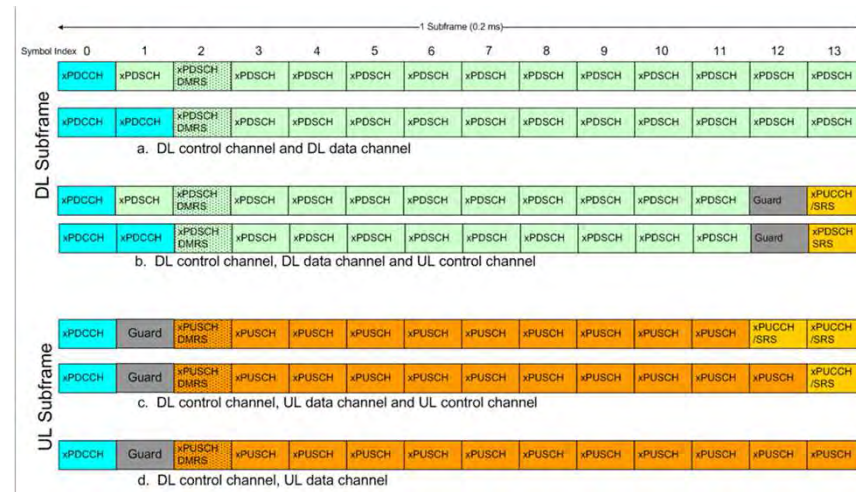

Verizon's and KT's version of 5G

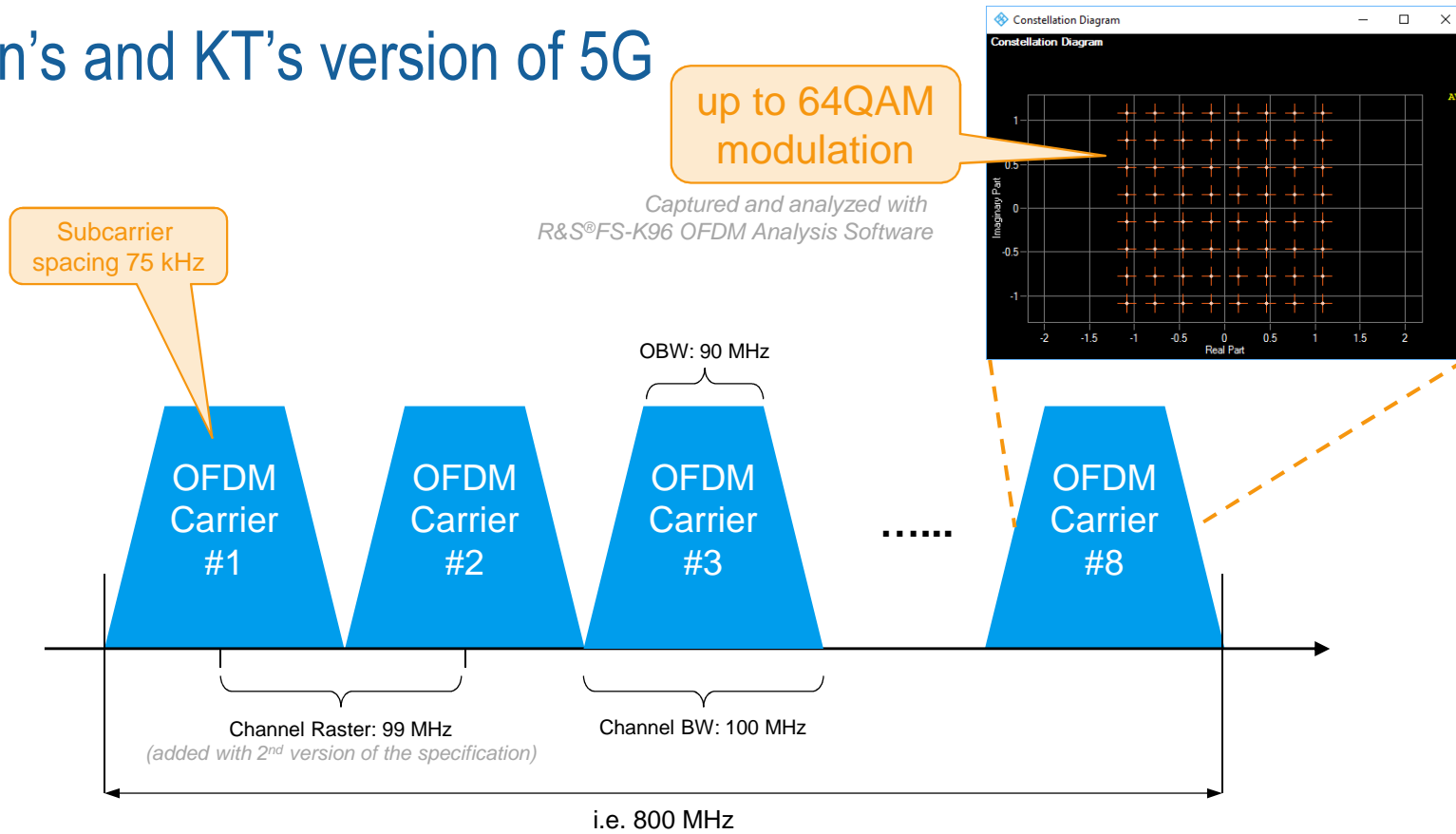

Verizon 5G specification

Basic principles: Downlink and Uplink

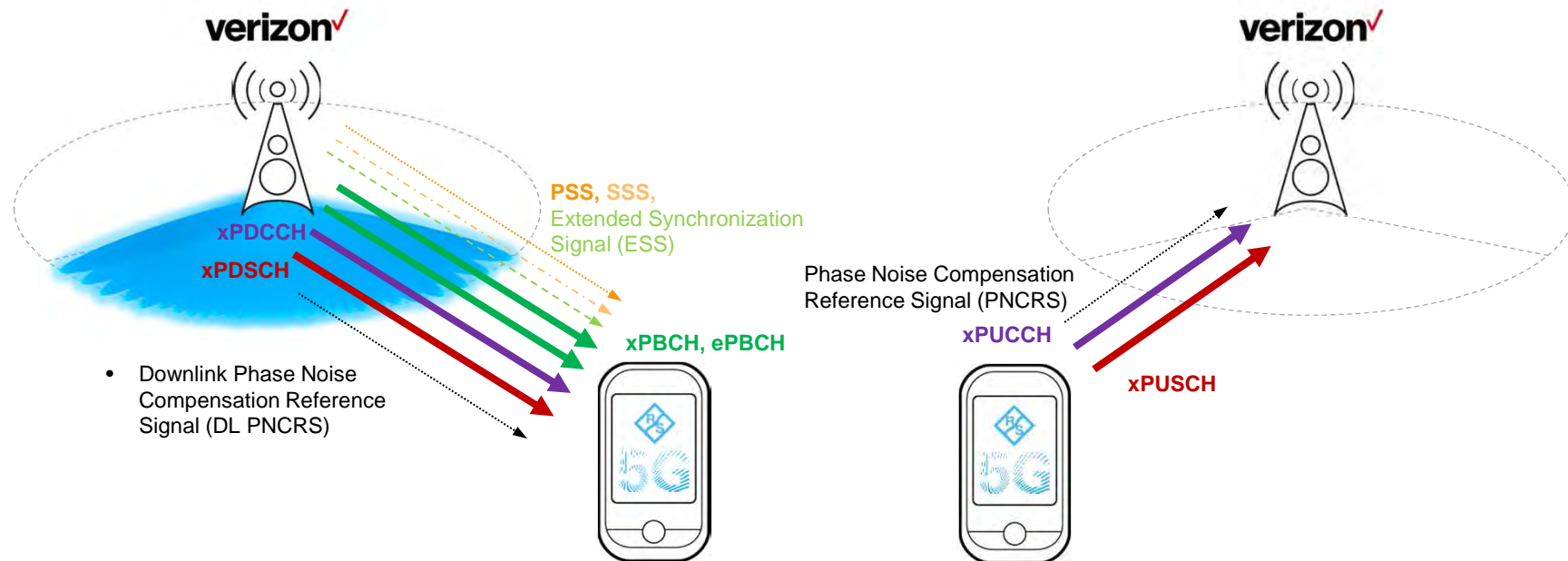

Verizon 5G vision: mapping of phase noise reference signals

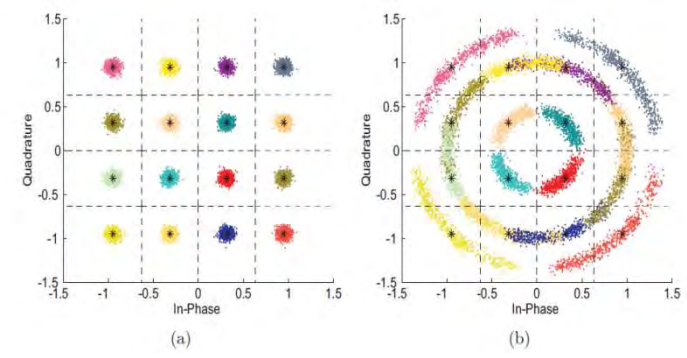
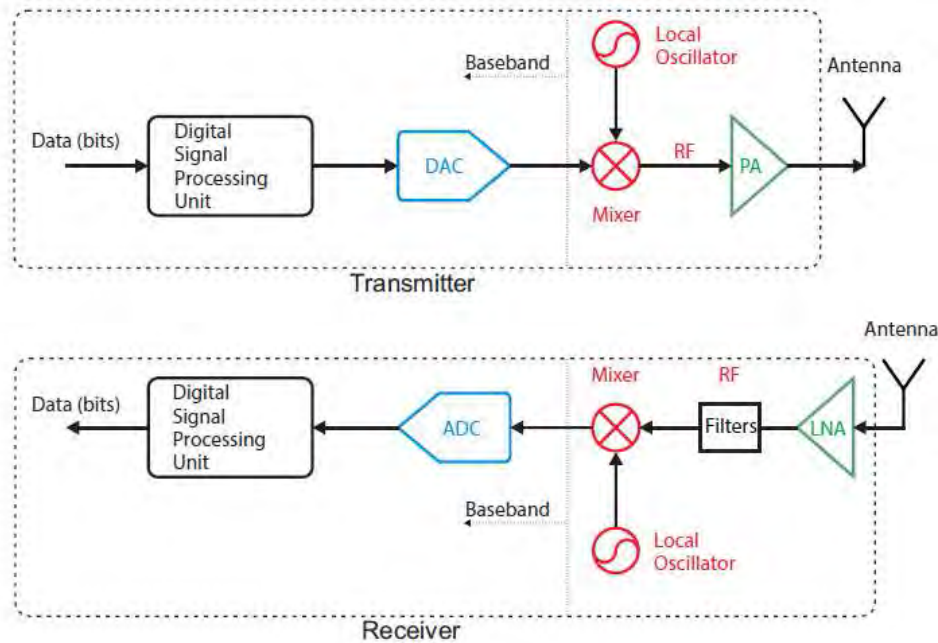

effect of phase noise as an example of 16 QAM.



5G scenarios: dual link scenario between LTE and 5G NR

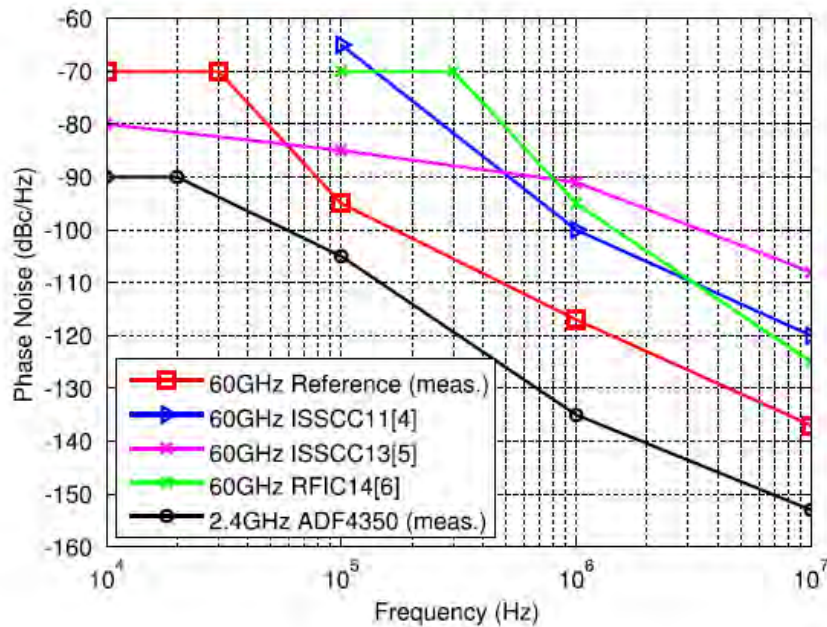

At higher frequencies, the Rx is affected by phase noise



$$r = s * H + n$$

our receiver equation becomes more complex



$$r_i = e^{j2\pi\phi_i} \left(\sum_{k=0}^{N_{CIR}-1} s_i h_{i-k} \right) + w_i,$$

idea is to remove the phase noise influence with the help of additional reference symbols



5G air interface: impact of phase noise

improving achievable SNR
=> widening Δf

phase noise channel model: limited SNR for narrow Δf at higher frequencies

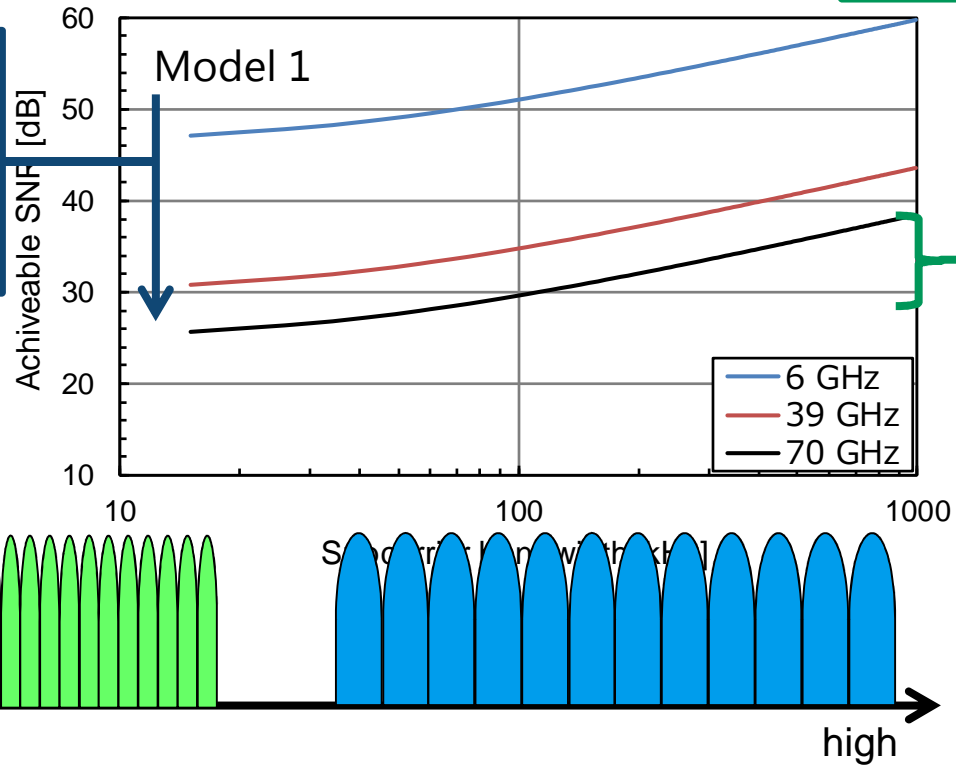

5G scenarios: dual link scenario between LTE and 5G NR

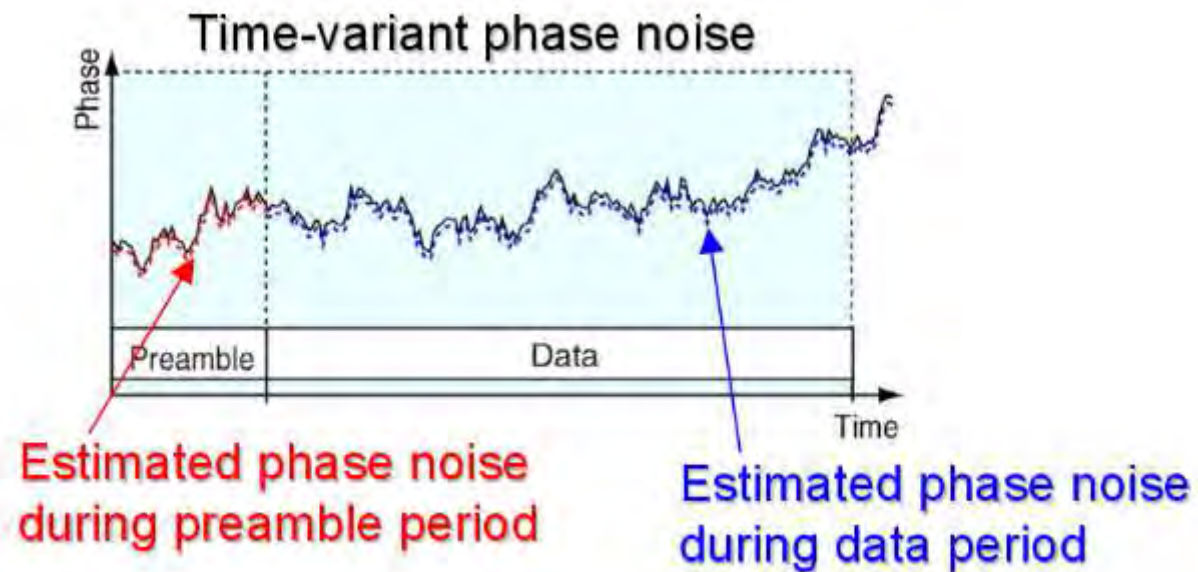

5GTF : mapping of phase noise reference signals, e.g. xPUSCH

$$r(m) = \frac{1}{\sqrt{2}}(1 - 2 \cdot c(2m)) + j \frac{1}{\sqrt{2}}(1 - 2 \cdot c(2m + 1))$$

mapping of a constant envelope demodulation reference signal for phase noise estimation into the data flow
 reference signal is based on a PN sequence linked to physical Cell ID

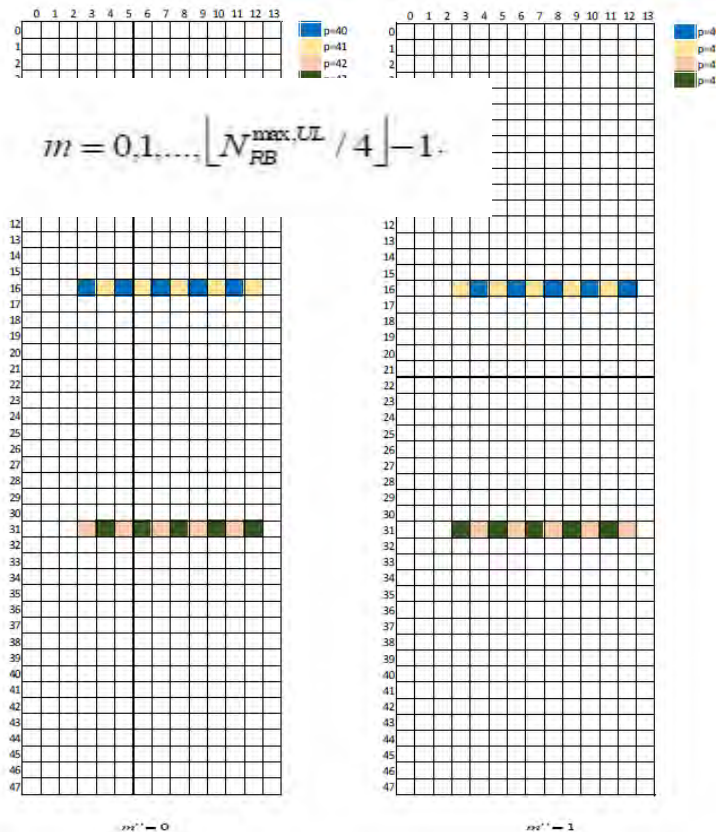

Old and new synchronization signals

PSS/SSS, Extended Synchronization Signal (ESS)

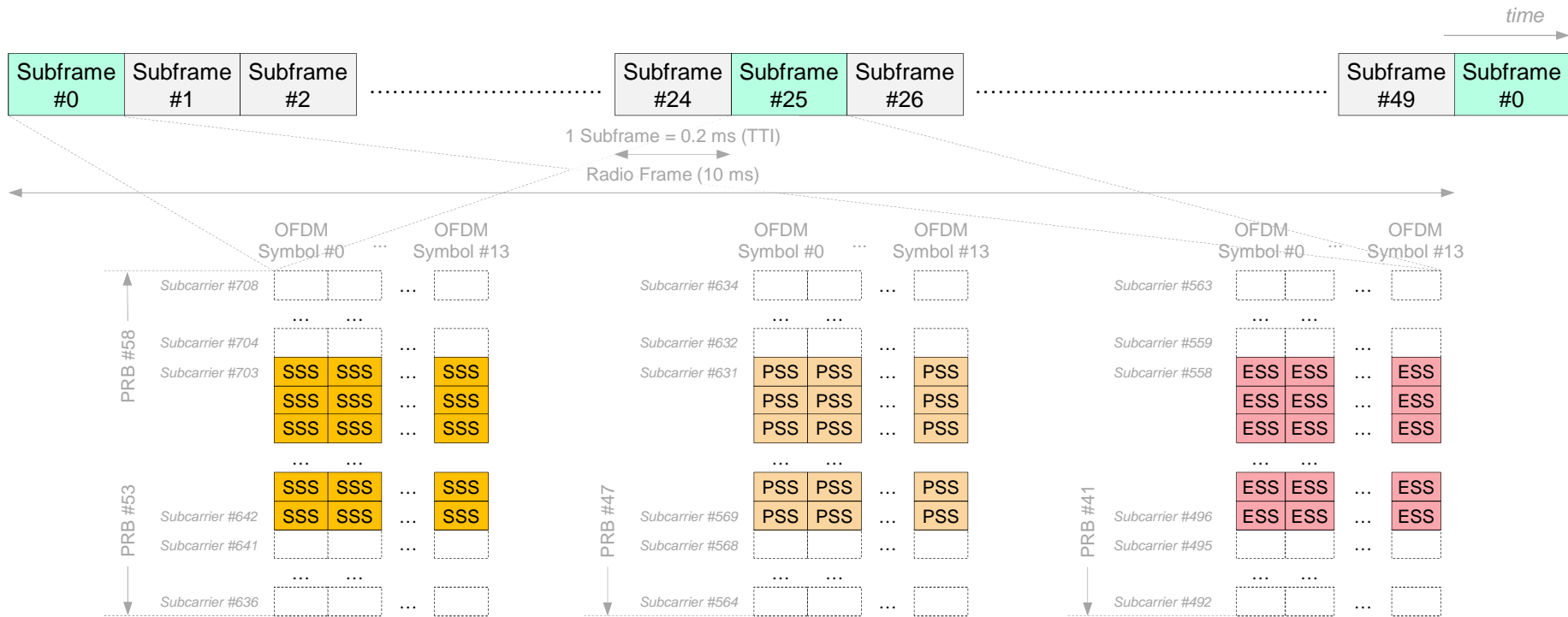

xPBCH, ePBCH – Where are the broadcast channels transmitted?

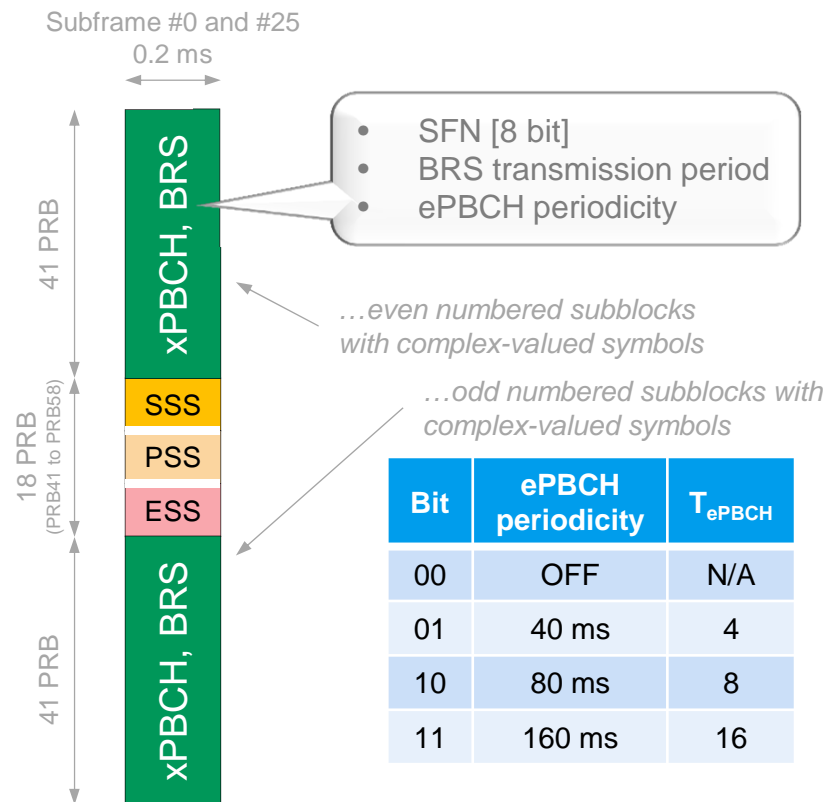

- xPBCH transmitted on 4 consecutive radio frames.
 - Occupies subframe #0, #25 with PSS/SSS/ESS and BRS; BRS are used to demod xPBCH.
 - Transmitted info (MIB): SFN (8 bits), BRS period, ePBCH transmission periodicity.
- ePBCH carries System Information Block (xSIB) and is transmitted on pre-defined or configured subframe.
 - Subframe depends on BRS transmission period.
 - Periodicity is (none, 4, 8, 16) radio frames (xPBCH).

BRS transmission period	# of subframes	Subframes within radio frame
1 slot < 5 ms	1	49 th
1 subframe = 5 ms	2	48 th , 49 th
2 subframes = 10 ms	4	46 th , 47 th , 48 th , 49 th
4 subframes = 20 ms	8	42 nd , 43 th , ..., 48 th , 49 th

Initial synchronization aspects in 5G NR: LTE reminder

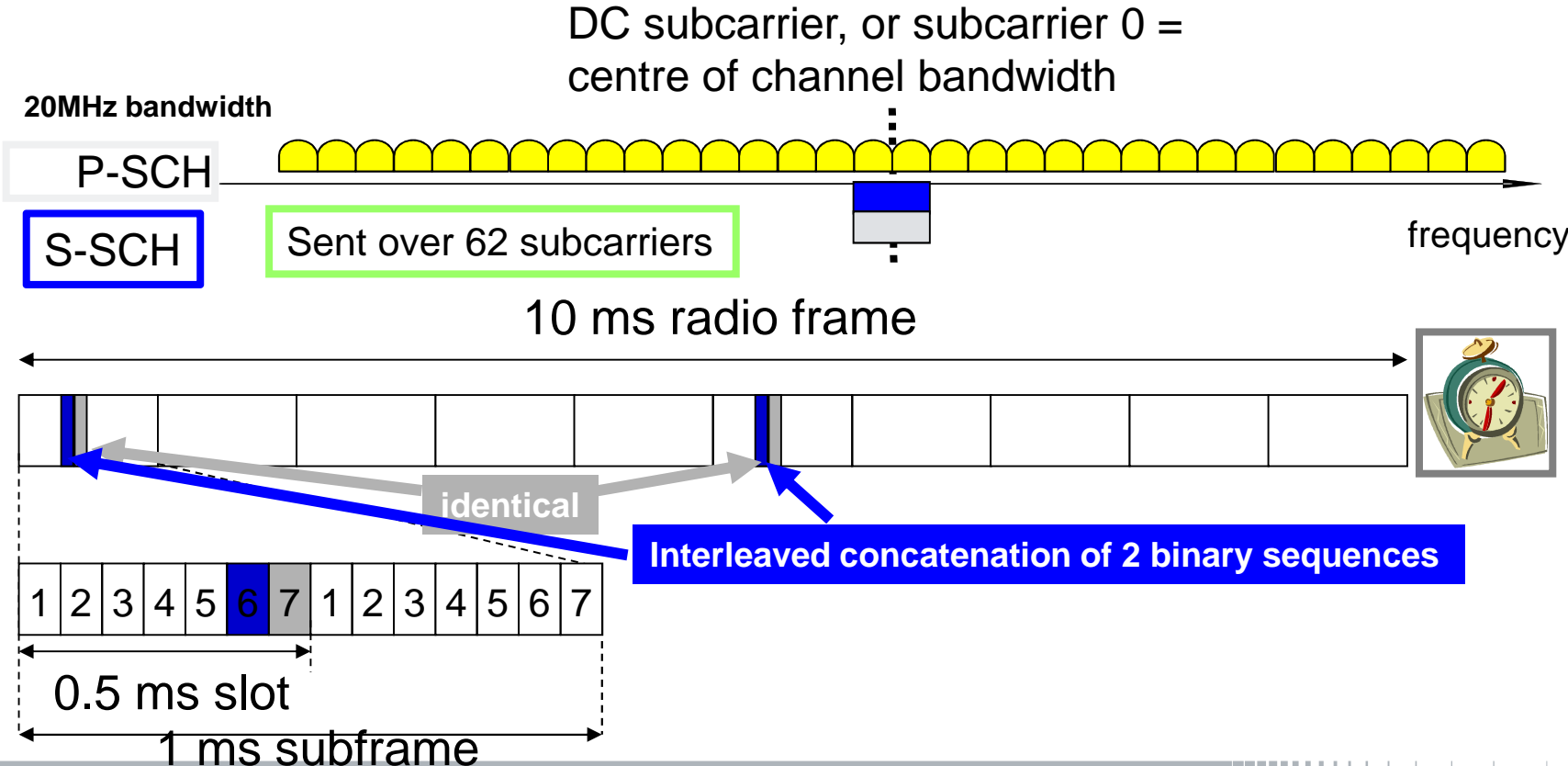

5GTF: concept of extended synchronization signal ESS

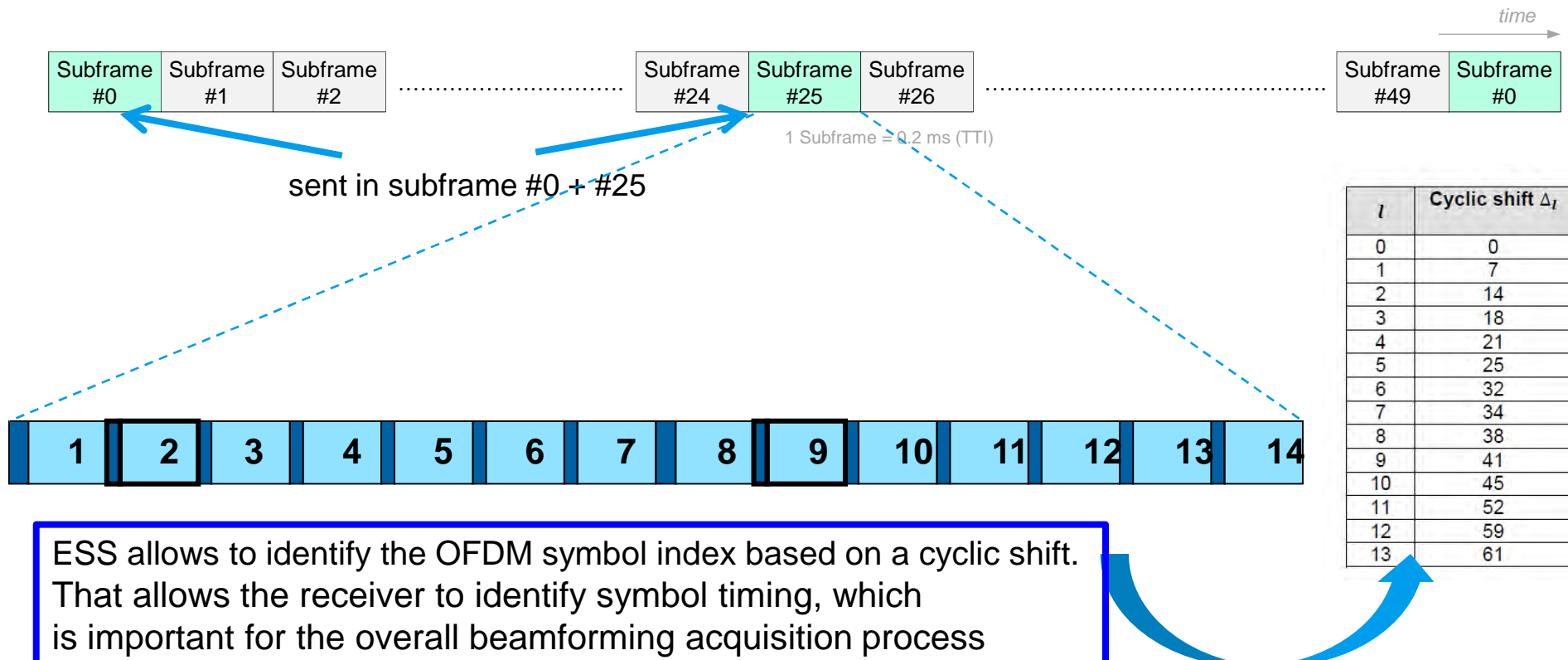

xPBCH, Beamforming Reference Signal (BRS)

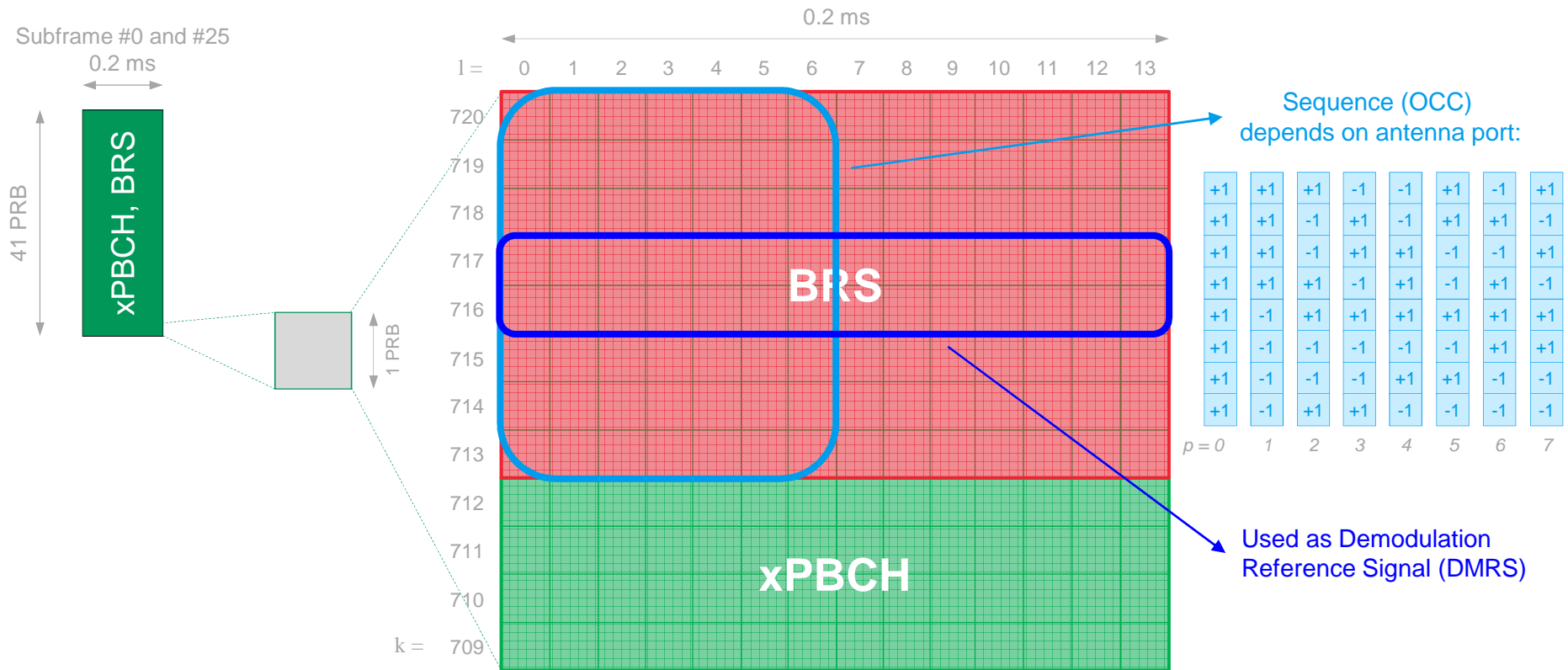

5G air interface aspects: beam sweeping for initial access



traditional approach:
omnidirection Tx of
BCCH for cell detection

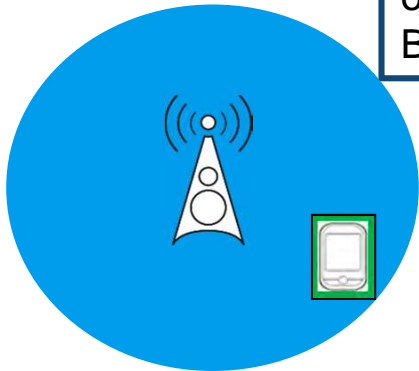

Friis equation

$$\frac{P_{Rx}}{P_{Tx}} = G_{antenna} \left(\frac{c}{4\pi f d} \right)^2$$

at higher frequencies: Free space path loss is high -> beamforming with high gain

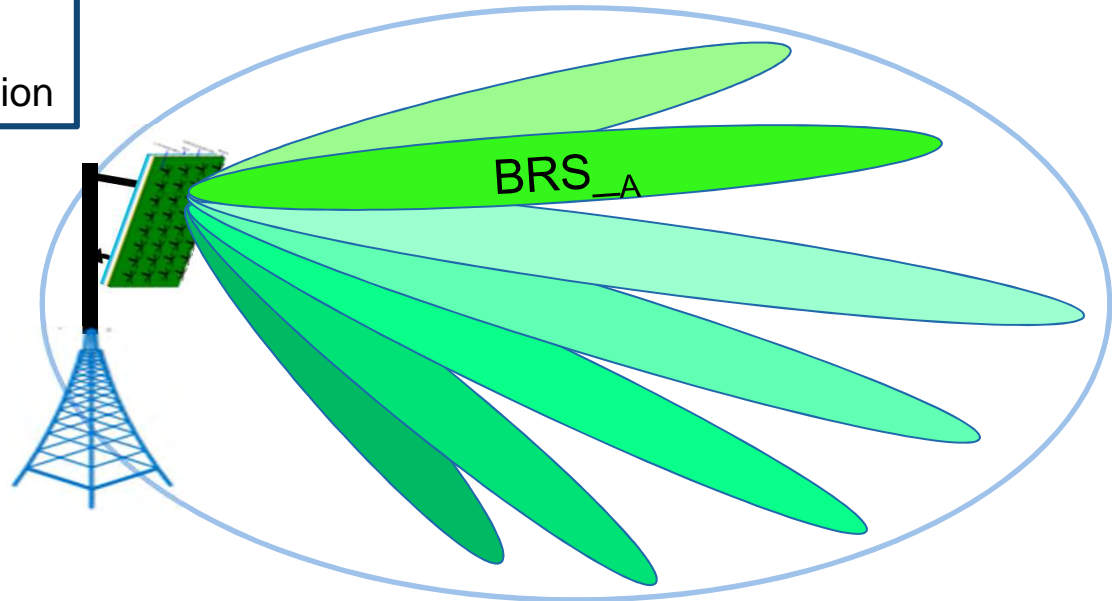

Beam sweeping procedure for power efficiency and cell detection



5G air interface aspects: beam reference signals

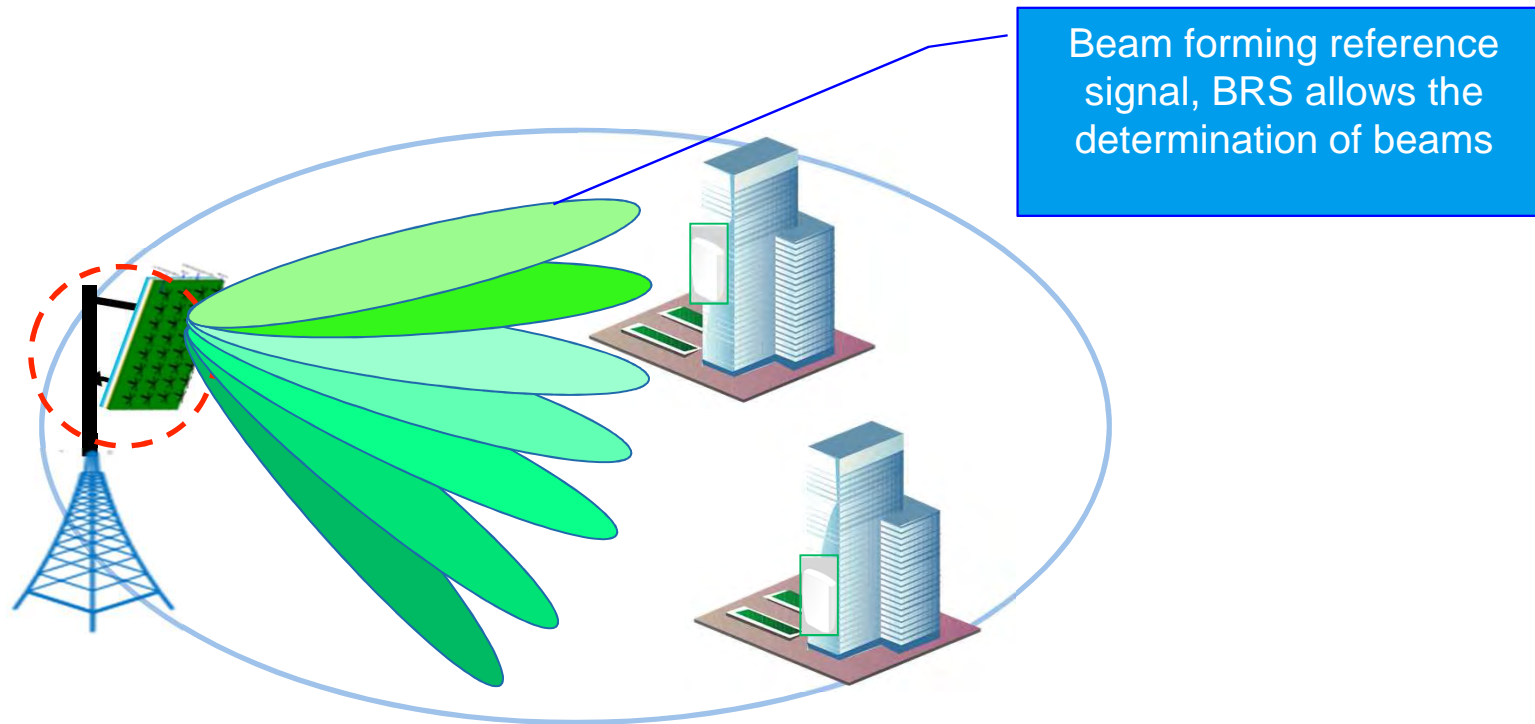

5G air interface aspects: beam reporting

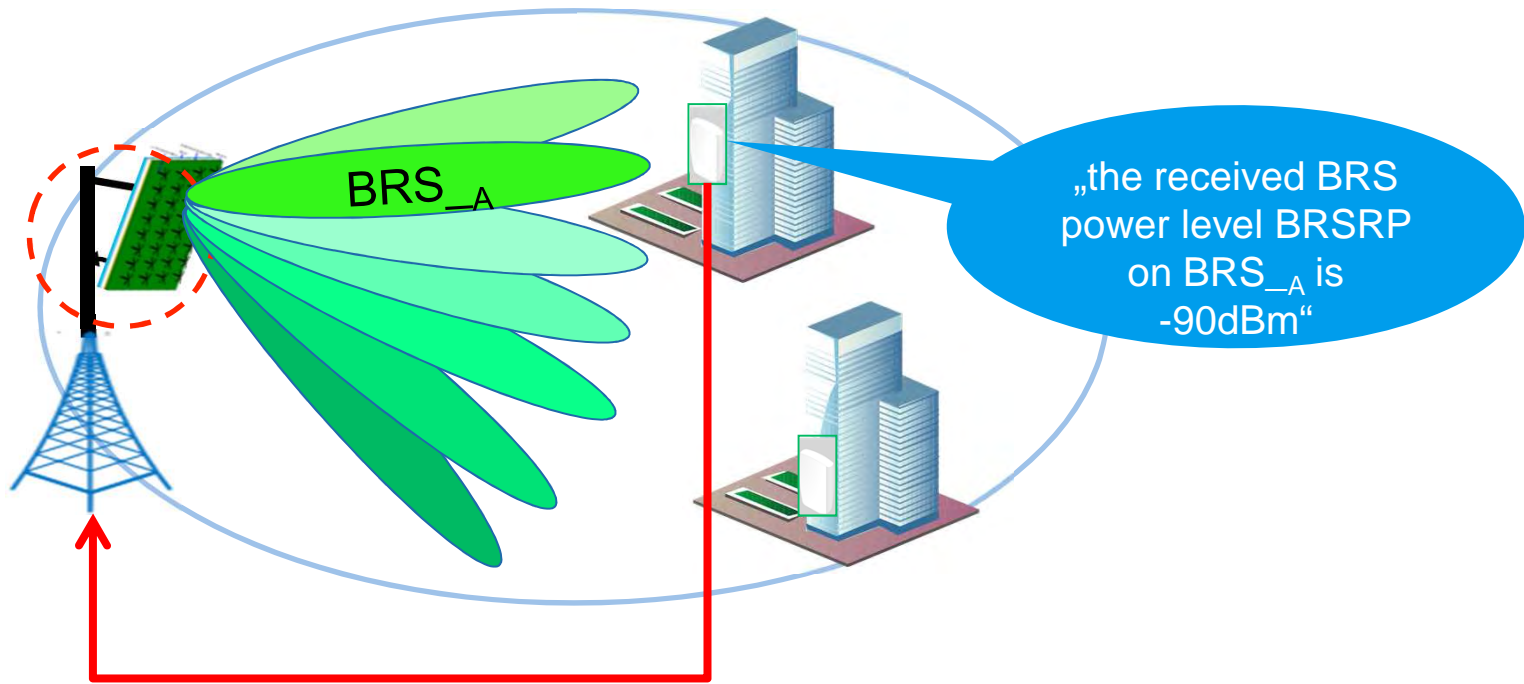

UE reports the beam status indication BSI



5G air interface aspects: beam status reports

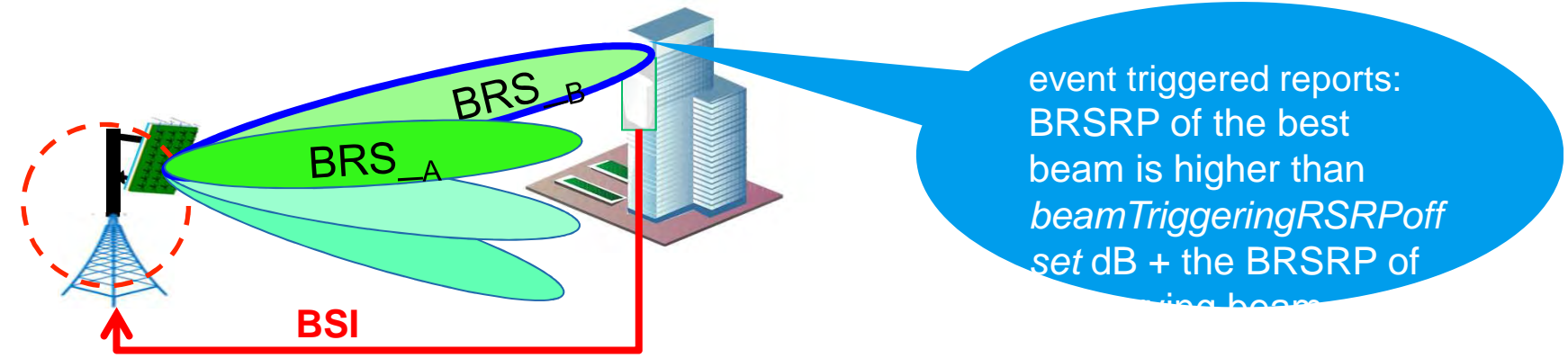
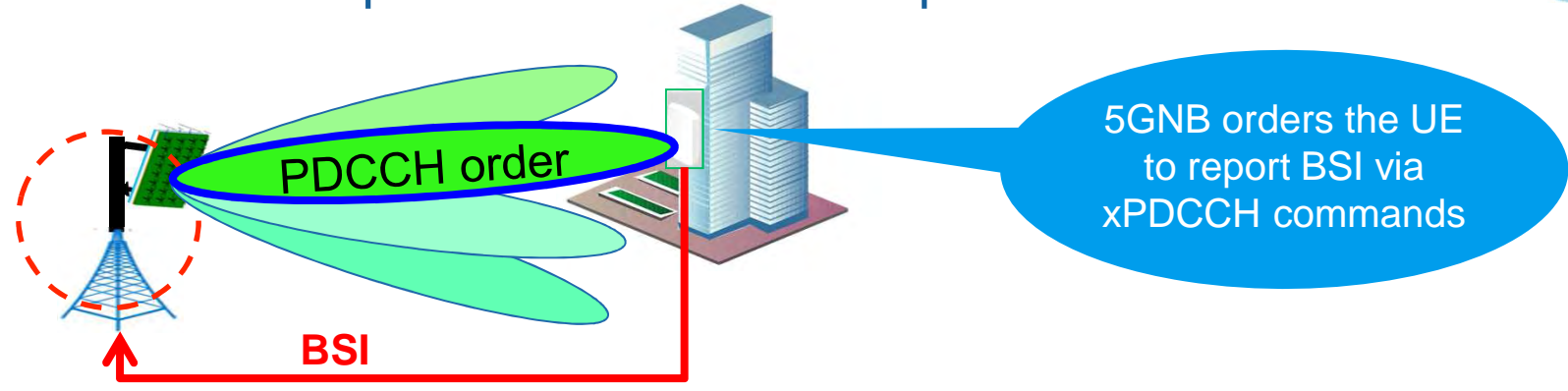

5G air interface aspects: beam forming reporting

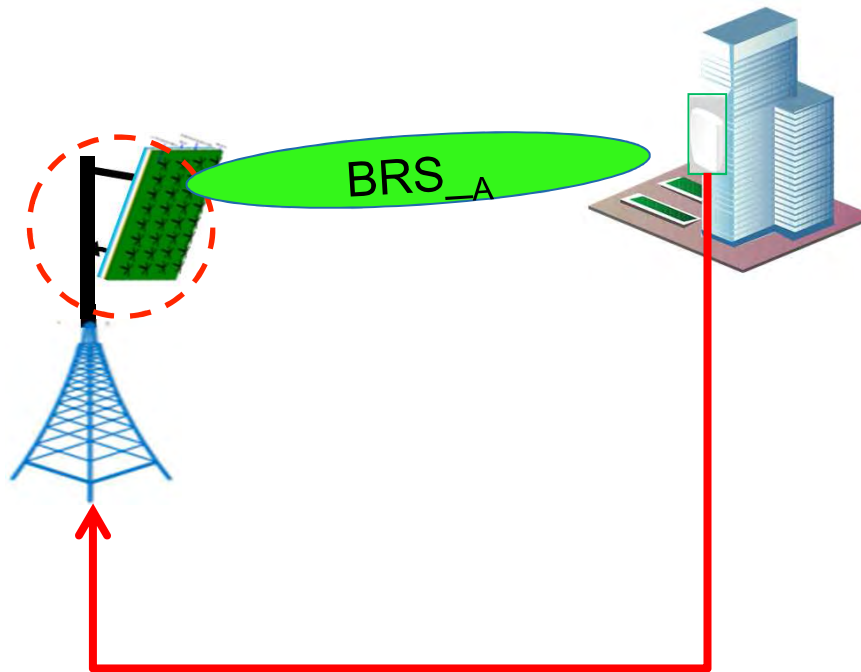

UE maintains up to 4 BSR sets, each set consist of beam indicators + power indicator

Field	Bit width
Beam index	$9 \cdot N$
Wide-band BRSRP	$7 \cdot N$

Field	Bit width
BRRS-RI	$3 \cdot N$
Wide-band BRRS-RP	$7 \cdot N$

UE reports beam index based on BRS or beam refinement index BRRS-RI and power level (i.e. BRSRP or BRRS-RP)



5G air interface aspects: beam switching procedure



DCI based

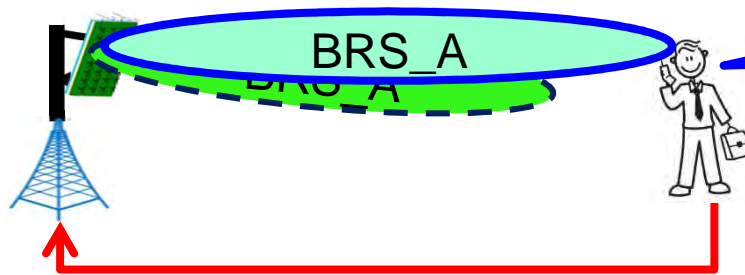

BSI report. Strongest BSRP will be new beam index

MAC-CE based

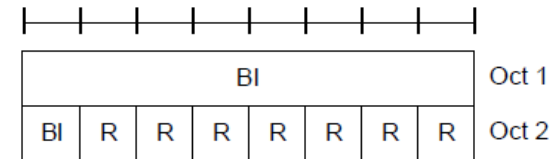
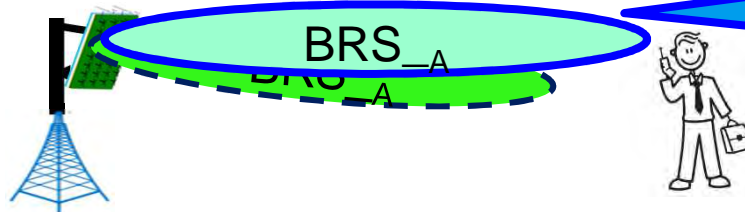

Aspects of DoA estimation – motivation for simpler methods

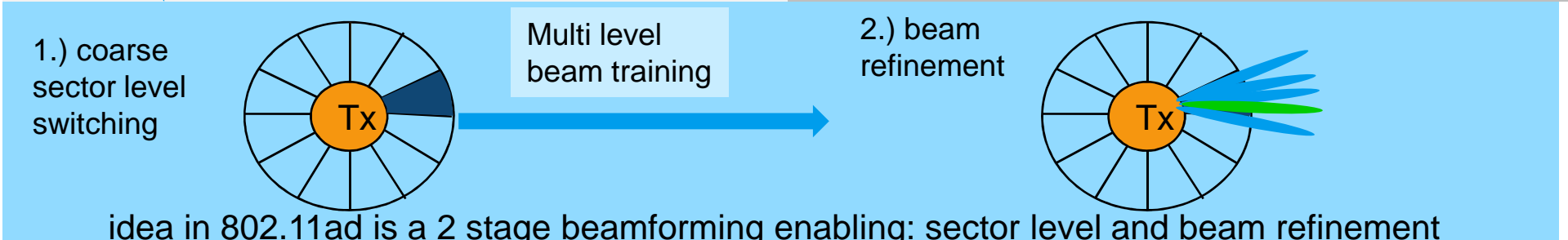
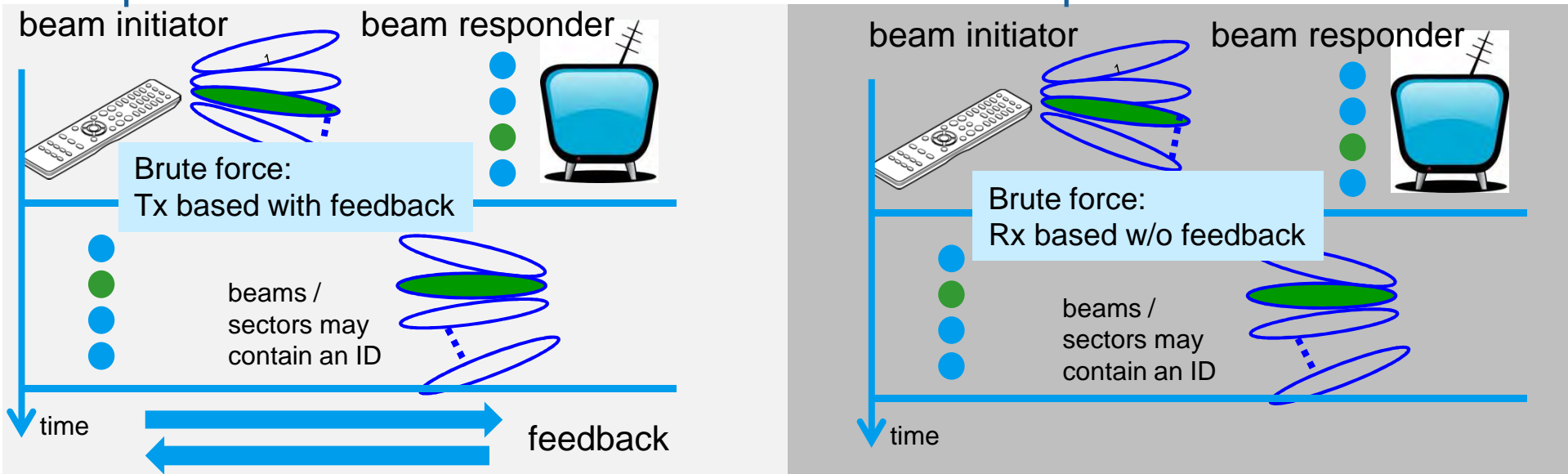

idea in 802.11ad is a 2 stage beamforming enabling: sector level and beam refinement

5G air interface aspects: beam reference and refinement

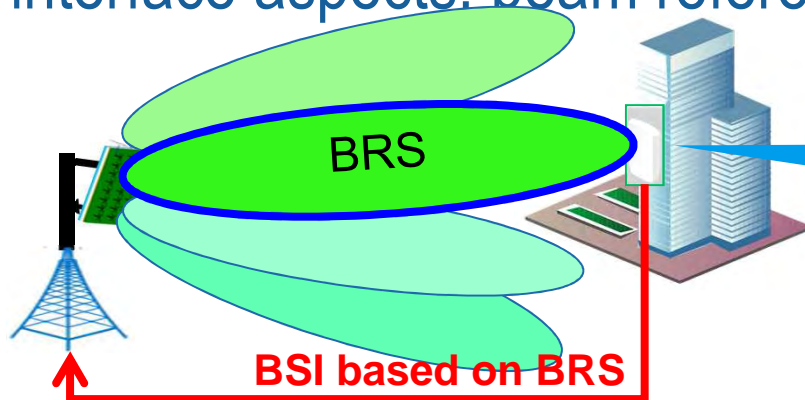

Beam forming reference signals to identify beam and sent feedback

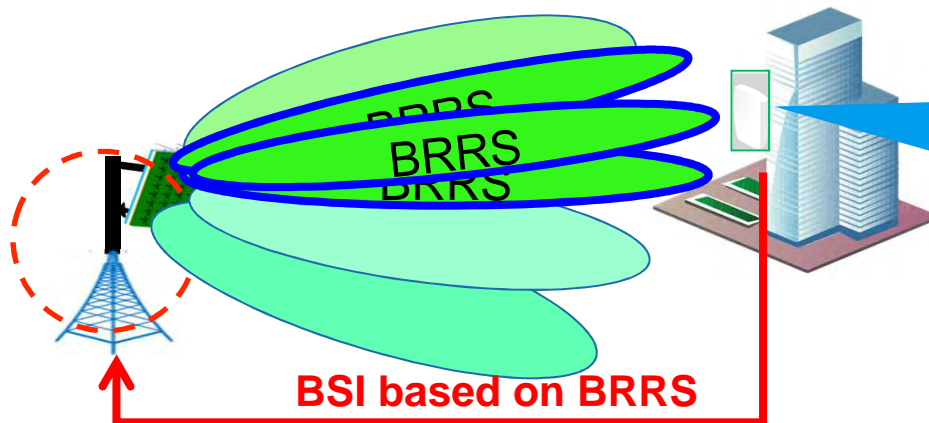

DCI scheduling indicates the transmission of beam refinement signals BRRS. Alternative UE may request BRRS via scheduling requests



5GTF idea of beam forming reference signals BRS

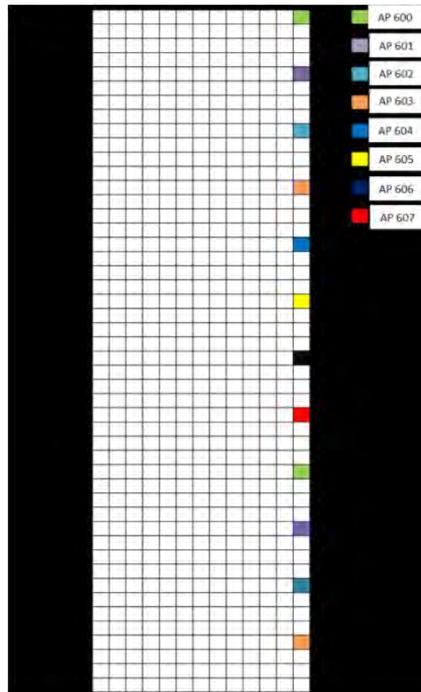

5GNB supports up to 8 antenna ports,
Additionally beam refinement reference
symbols can be sent

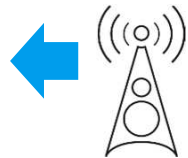

BRS transmission configuration allows
different #of beams per antenna port
+#beams: 7 .. 56 per port

BRS transmission period	# of subframes
1 slot < 5 ms	1
1 subframe = 5 ms	2
2 subframes = 10 ms	4
4 subframes = 20 ms	8

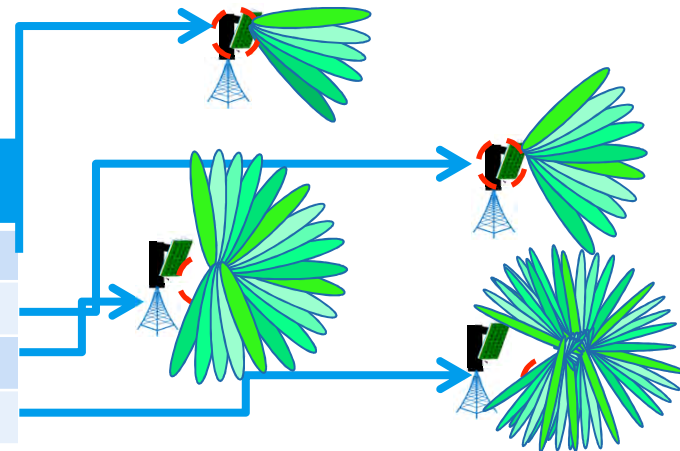

Beam management as per TR38.802

- **Beam management:** a set of L1/L2 procedures to acquire and maintain a set of TRP(s) and/or UE beams that can be used for DL and UL transmission/reception, which include at least following aspects:
 - **Beam determination:** for TRP(s) or UE to select of its own Tx/Rx beam(s).
 - **Beam measurement:** for TRP(s) or UE to measure characteristics of received beamformed signals
 - **Beam reporting:** for UE to report information a property/quality of of beamformed signal(s) based on beam measurement
 - **Beam sweeping:** operation of covering a spatial area, with beams transmitted and/or received during a time interval in a predetermined way.



Technology framework: Multiple access schemes

SDMA = Space division multiple access

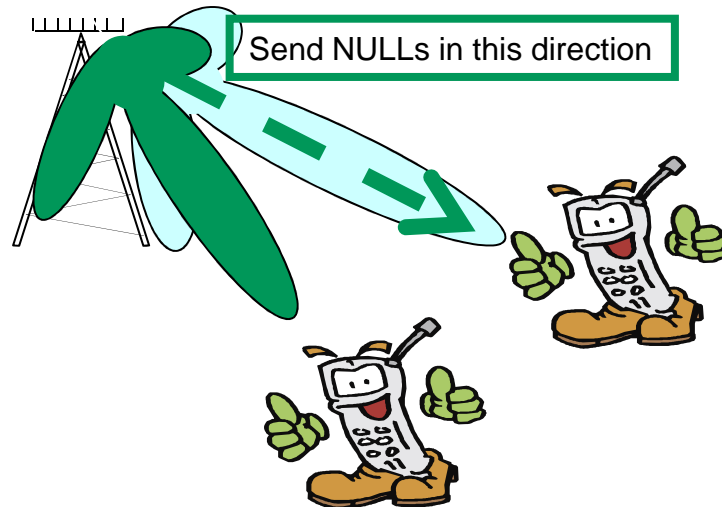

Coordination of pencil beams to steer desired direction & place NULLS in „interfering“ directions

Basic idea is to overlap OFDMA subcarrier principle with code division multiple access
⇒ One subcarrier may contain traffic of multiple users

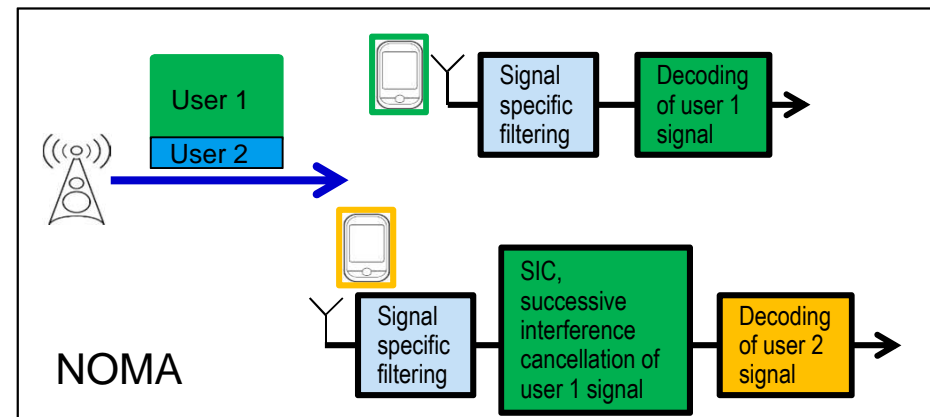
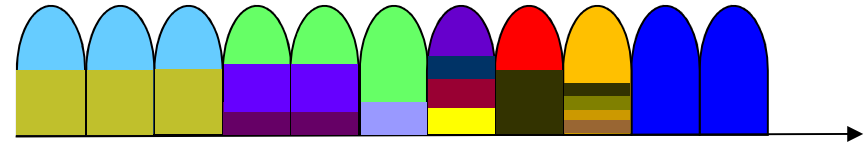

Multiple access – Bit division multiple access BDM

broadcast & multicast problem: tradeoff between coverage & throughput

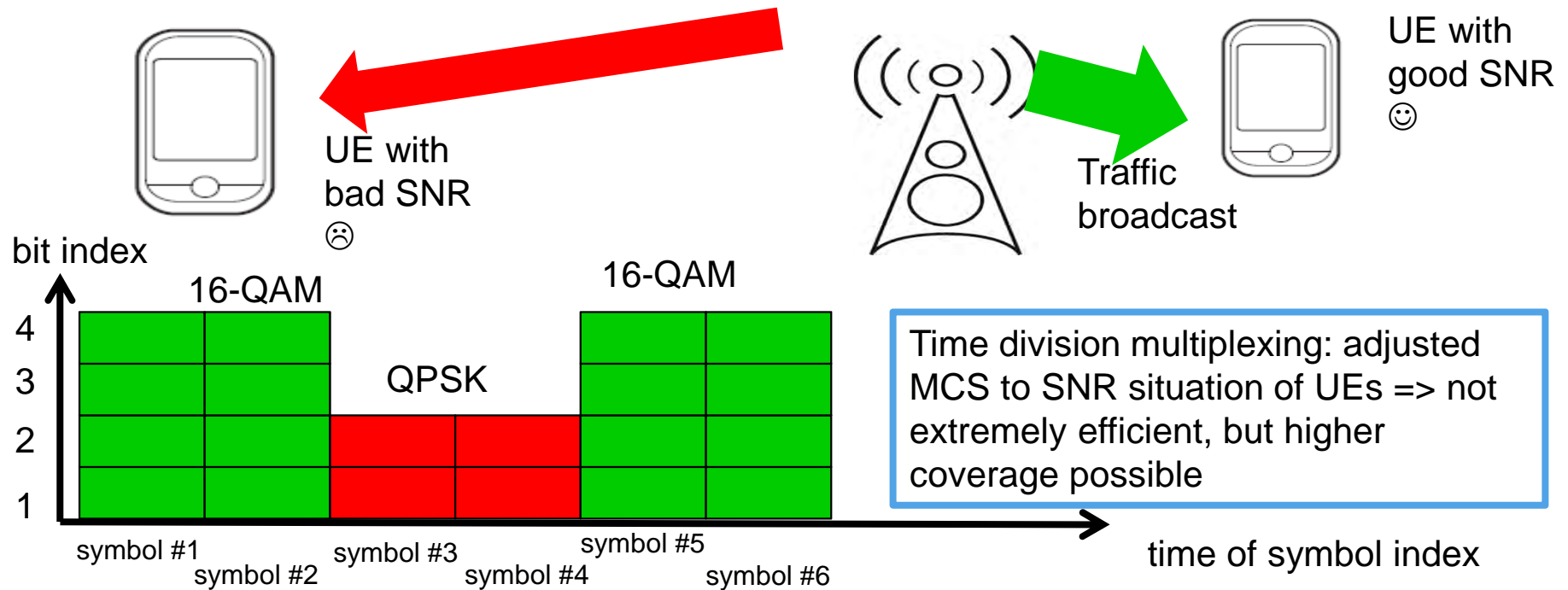

Multiple access – Bit division multiple access BDM

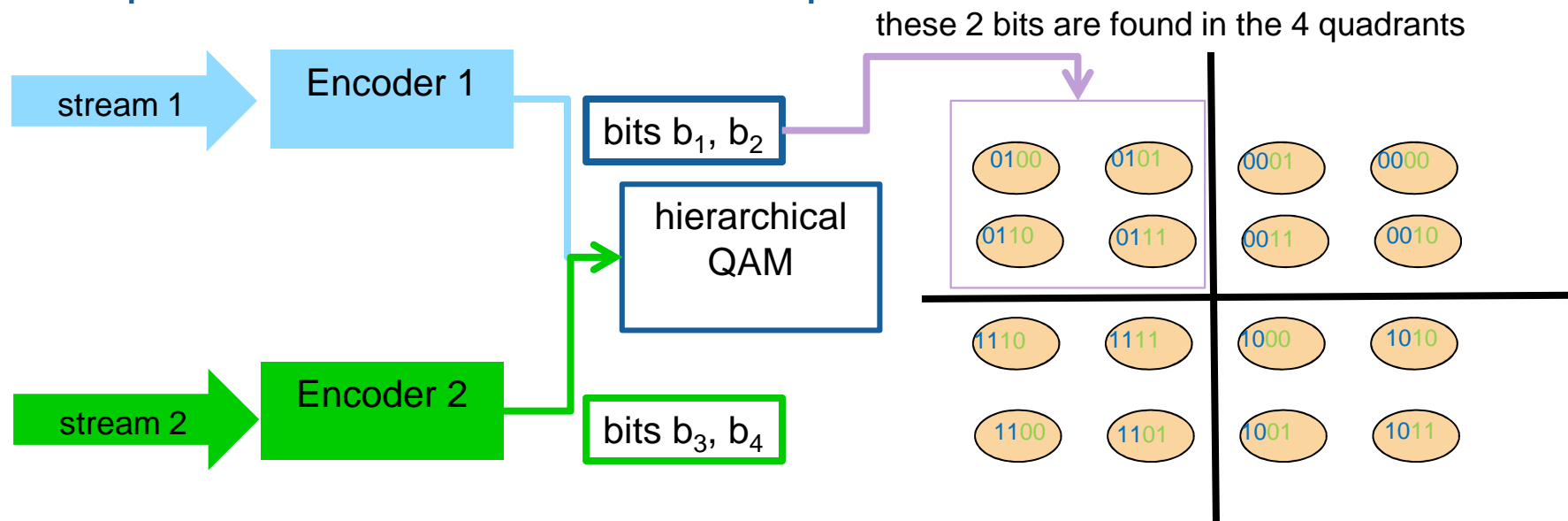

take a closer look into 16-QAM: it can be uniform = same distance between all constellation points or non-uniform. The stream 1, bits b_1 and b_2 are in the 4 quadrants and have thus a better BER as stream 2

Multi-user Bit interleaved coded modulation with iterative decoding

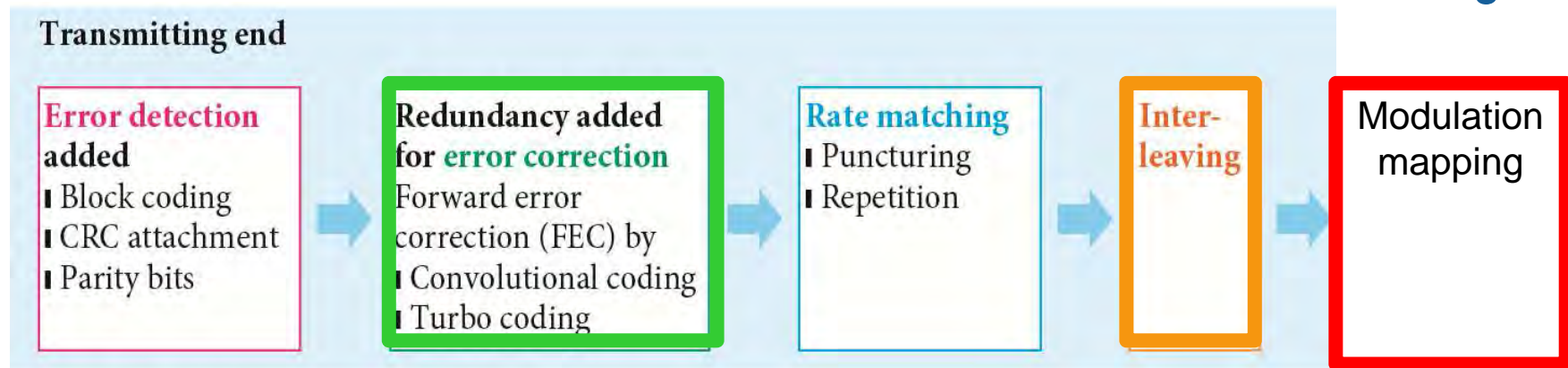

General idea: Is it possible to distinguish different users by different ways of **Channel coding**, **Interleaving** and **Modulation mapping** ? => superimpose the system and approach capacity limit of channel

Multiple access – combination CDMA + OFDMA

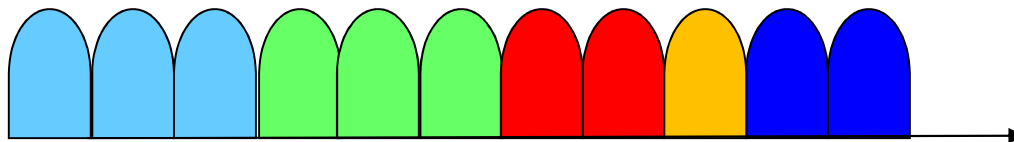

In OFDMA one subcarrier transmits data from one user only



Basic idea is to overlap OFDMA subcarrier principle with code division multiple access
⇒ One subcarrier may contain traffic of multiple users



RSMA – general aspects

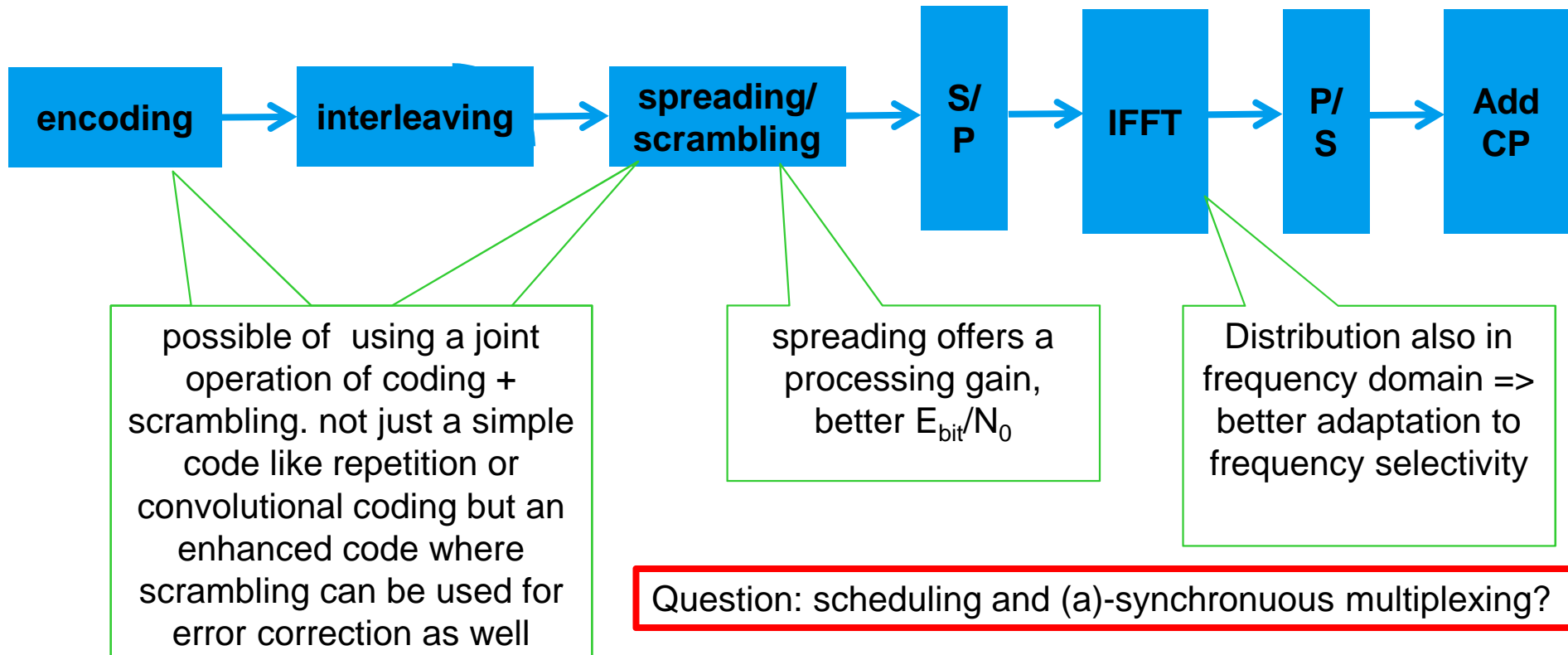

Successive interference cancellation SIC in NOMA

NOMA uses the principle of various power levels that are super-positioned. Each receiver will cancel the stronger signals

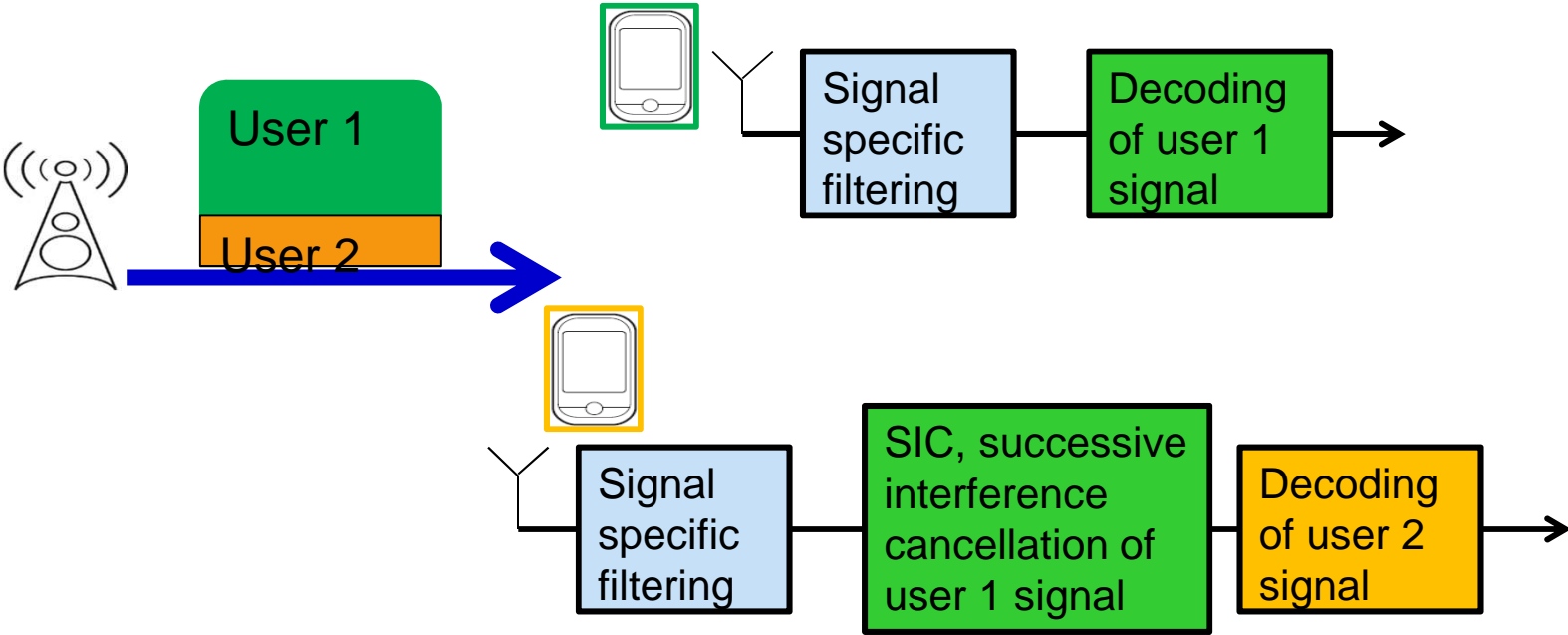

Successive Interference cancellation concept, 1st stage

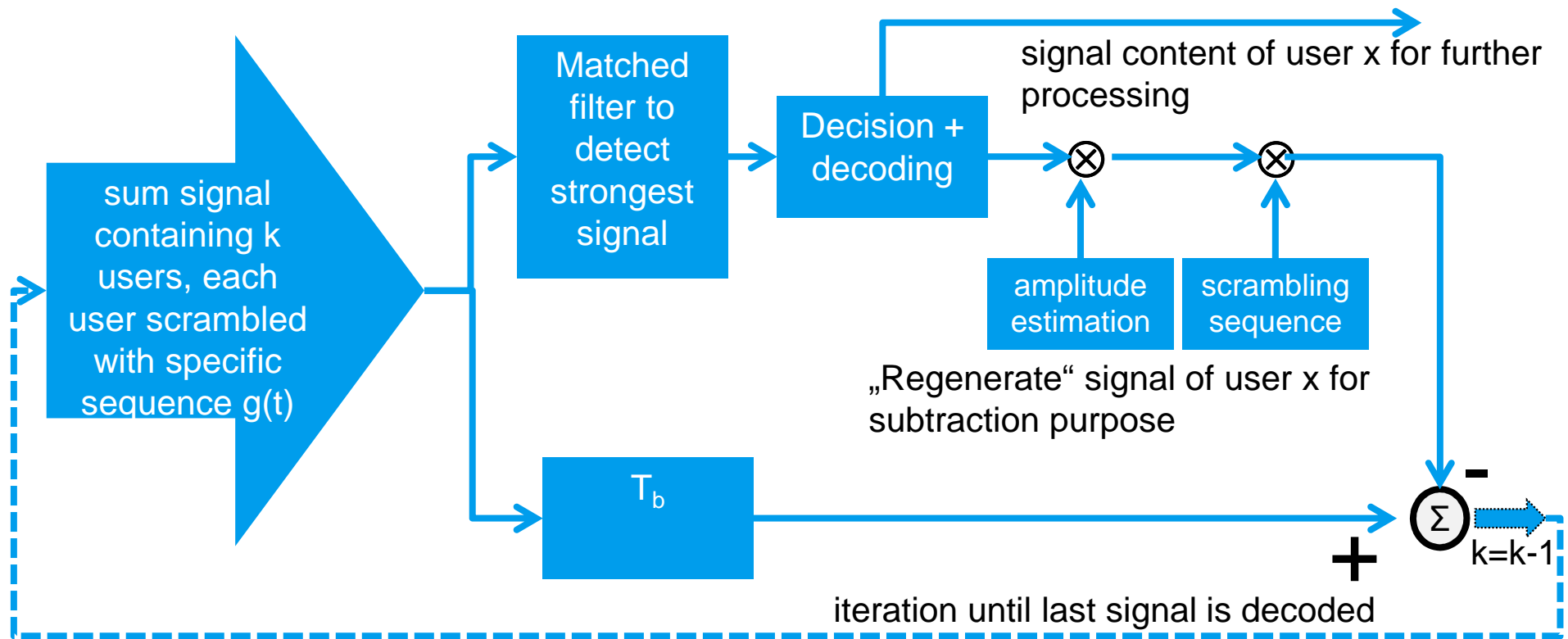

NOMA – downlink example of performance

Orthogonal multiple access OMA:
 2 users where bandwidth is split amongst them.
 channel is symmetric ->
 fair sharing of capacity between them.

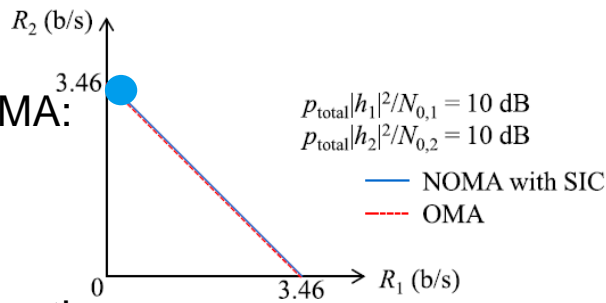

● = whole capacity is allocated to user 2 only.

Performance:
 if we want to obtain a rate for user 2 of 0.8 bit/sec we can get a rate of ~2 b/s if **OMA** is used, but we could get ~4b/s if **NOMA** is used

Non-orthogonal channel:
 2 users with different power levels due to asymmetric channel superpositioned

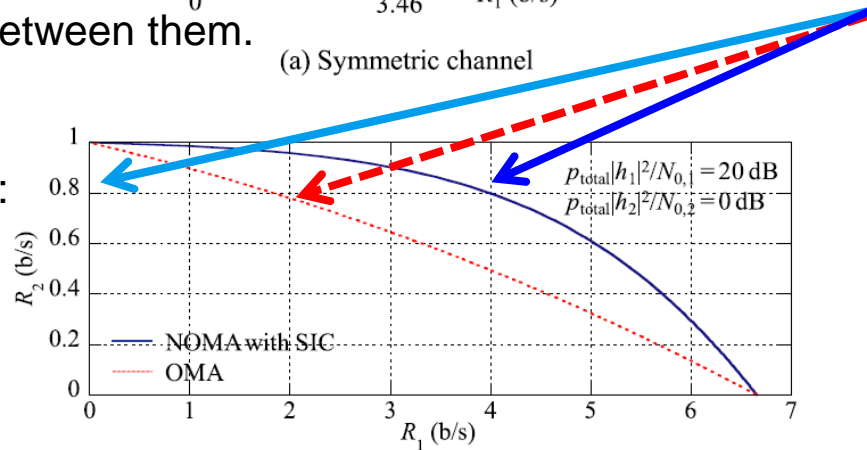

source: NOMA with SIC for future radio access, Higuchi + Benebbour

(b) Asymmetric channel

Low density signature – idea of system overload

Basic idea of low density signature

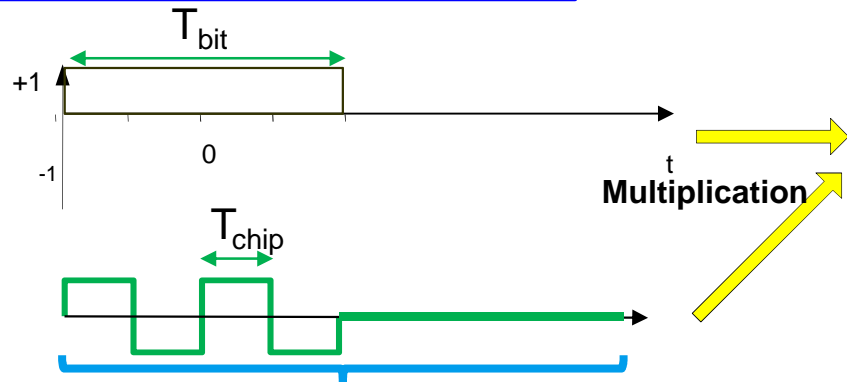

spreading code has length N
but only $d_v < N$ chips will contain non-zero values

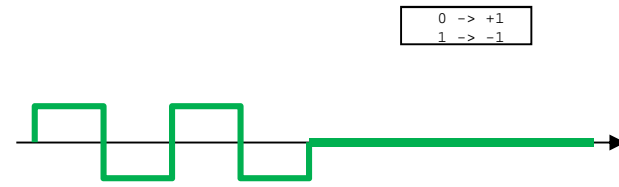

spread signal after channelization
-> only fragment of spectrum is occupied
-> this will result in some kind of sparsity of the code



Low density signature – idea of system overload

Basic idea of low density signature

The fact that the code has $d_v < N$ chip length will result in some kind of interleaving + sparsity of codes

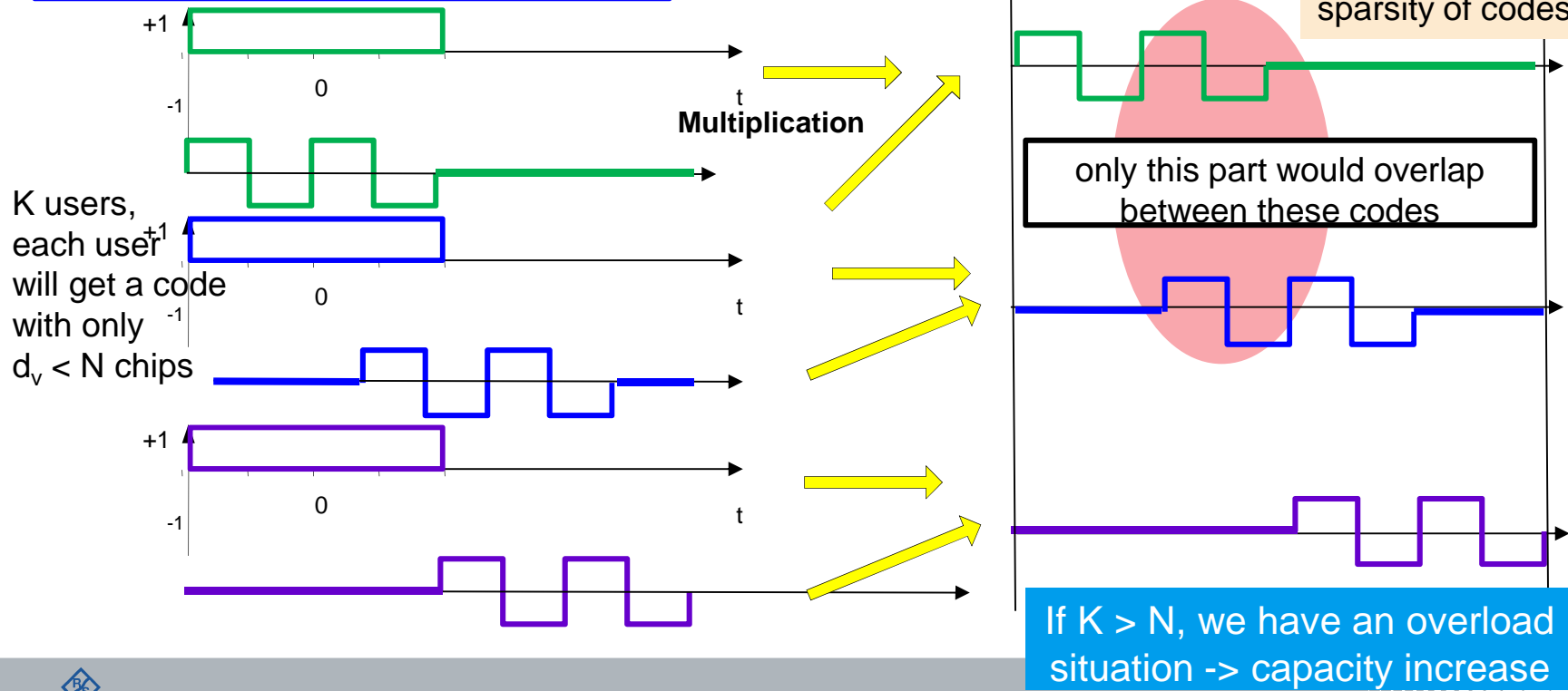

Low density signature codes

example: LDS indicator matrix, one idea how to generate LDS for spreading

K = 16 users

2nd rule: $d_c =$ amount of 1s in one row (users simultaneously vs total amount of users) $\ll K$

N = 12 chips

$F_{12 \times 16} =$

0	0	1	0	0	0	0	1	0	1	0	0	1	0	0	0
0	0	0	1	0	0	1	0	0	0	0	0	1	0	1	0
0	1	0	0	1	0	1	0	0	1	0	0	0	0	0	0
0	0	0	1	0	1	0	0	0	0	1	0	0	1	0	0
0	0	1	0	0	0	0	0	1	0	0	0	0	0	1	1
1	0	0	0	0	1	0	0	0	1	0	0	0	0	1	0
0	0	0	1	0	0	0	1	1	0	0	1	0	0	0	0
0	1	0	0	0	1	0	0	0	0	0	1	0	0	0	1
1	0	0	0	0	0	1	0	0	0	0	0	0	1	0	1
0	0	1	0	1	0	0	0	0	0	0	1	0	1	0	0
0	1	0	0	0	0	0	0	1	0	1	0	1	0	0	0
1	0	0	0	1	0	0	1	0	0	1	0	0	0	0	0

1st rule: $d_v =$ amount of 1s in one column (used chips vs spreading gain) $\ll N$

here: at Chip 3 we would have multiple access interference MAI of users 2, 5, 7 and 10

here: user Nr. 11 will spread its data over chip Nr. 4, 11 + 12

SCMA encoding aspects

reminder: QPSK
data bits are mapped onto constellation symbol

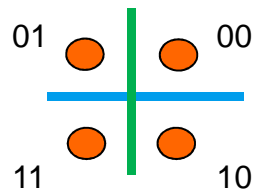

N = dimension of complex constellation
i.e. here N = 2 (IQ-axis)

max number of codebooks:

$$J = \binom{K}{N}$$

in encoding also called layer
e.g. if code length = 4 and 2 symbols are used, we have max = 6 users

1. step: binary data pattern, e.g. 0100111101011001

2. step: mapping of bits onto a codeword size N (here N = 2)

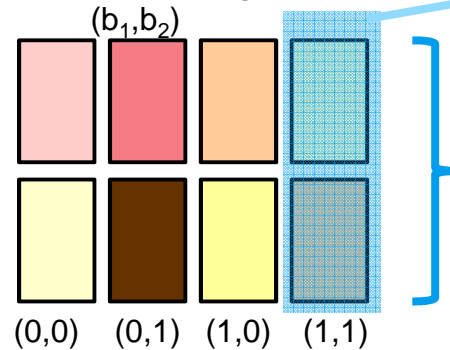

example: codebook containing codewords
-> codebook is UE specific

3. step: Spreading onto K dimensional codeword. K-N zero rows

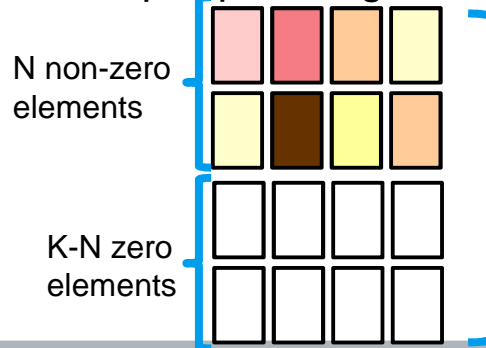

example: codebook of size K = 4 (representing 4 constellation symbols of QPSK) will be spread over 4 OFDM subcarriers (here 4 rows) but only 2 rows are non zero => sparsity of the codeword



SCMA encoding multiple access by using multiple codebooks

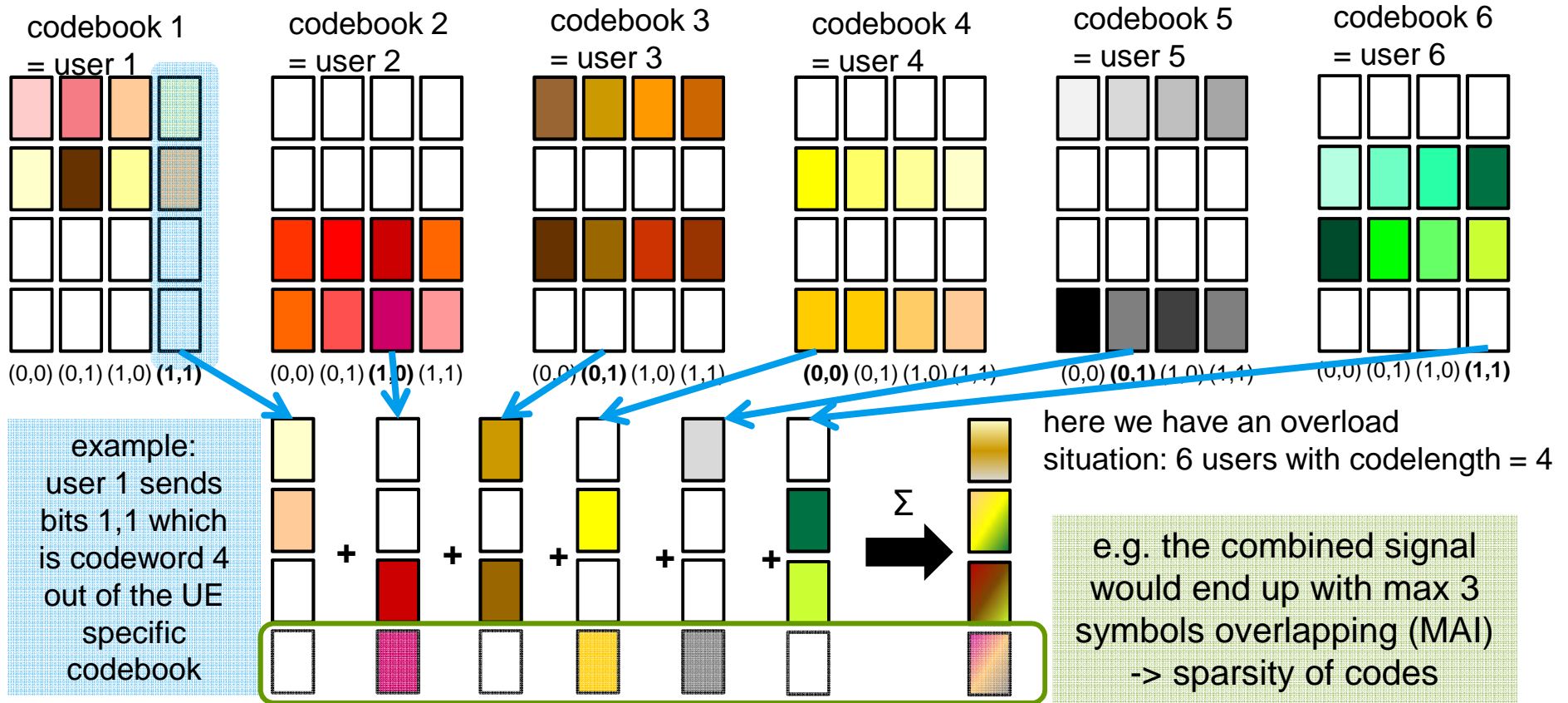

SCMA codebook design, idea of multidimension, rotated + shuffled

Complexity gets high again as idea is to send more data due to multidimensions:

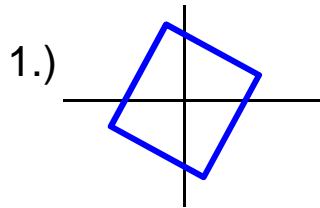

using rotated constellations, so I and Q axis are independent

2.) rotate each constellation diagram, e.g. x-y and x-z axis

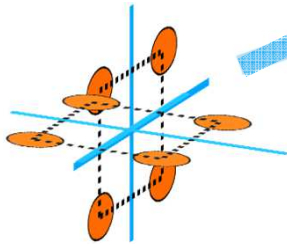

3.) shuffle to separate real + imaginary part -> mother constellation

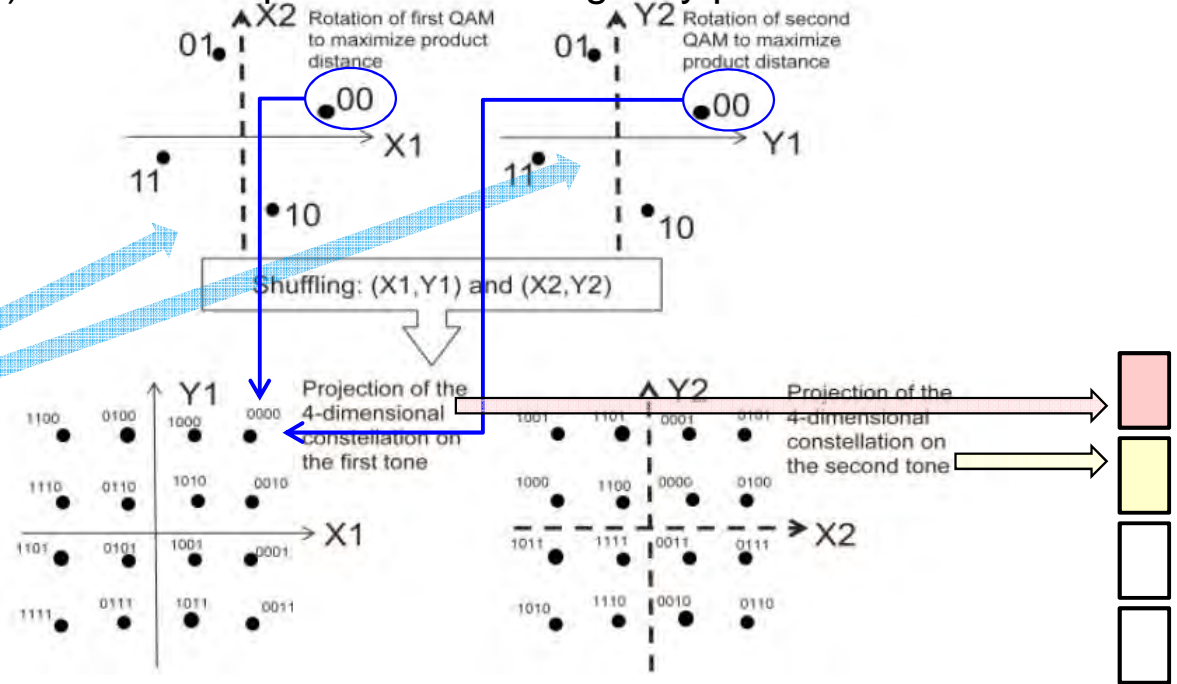

SCMA codebook design, trying to make it simple

1.) We have a bit pattern, e.g. **0000**

2.) e.g. using QAM constellation, here 2 times as we have 2 dimensions

3.) you have to read the constellations as shuffled to get a higher dimension, e.g. one is x-y axis the other is x-z axis

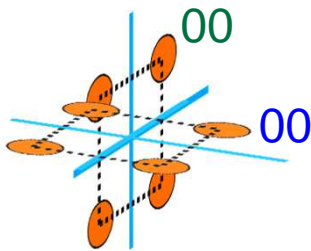

4.) generate the projection of the shuffled as 16-point but 2 dimensions

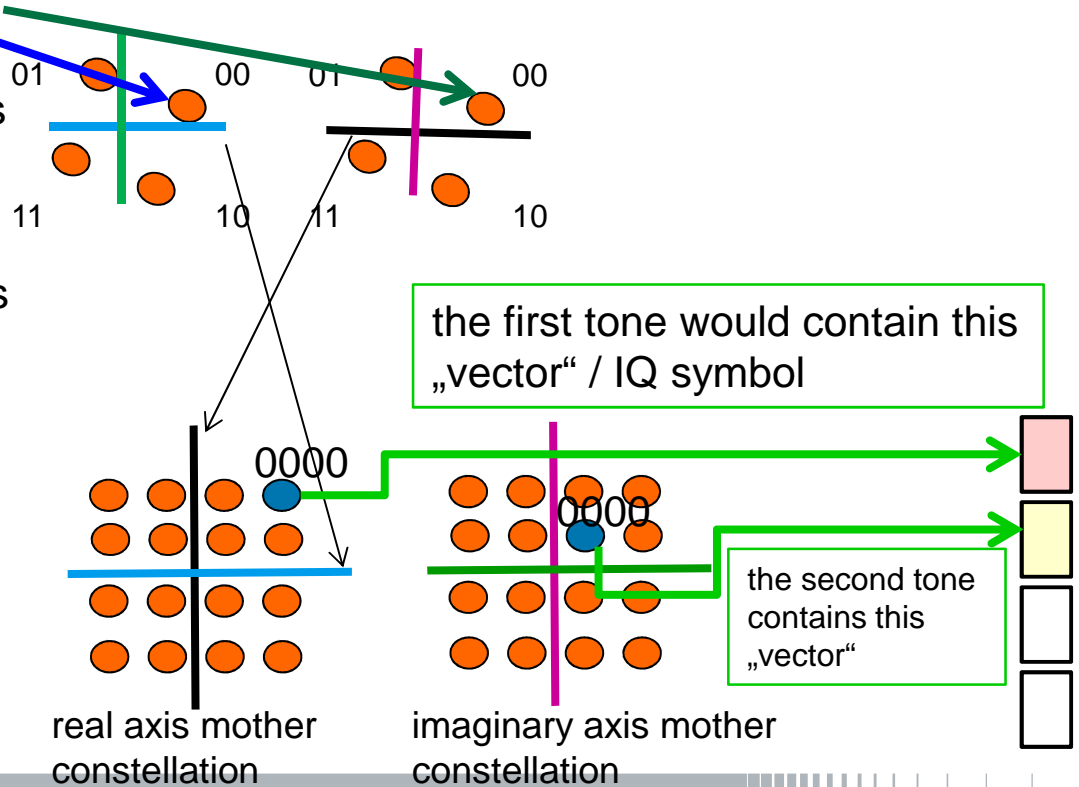

Higher frequencies: path loss issues

Higher frequencies = higher attenuation
 Higher frequencies = smaller antennas

Friis equation

$$\frac{P_{Rx}}{P_{Tx}} = G_{antenna} \left(\frac{c}{4\pi f d} \right)^\gamma$$

Beamforming

EXAMPLE
 @ 28 GHz:

PathLoss 28 GHz	$\gamma = 2$ Free Space	$\gamma = 1.6$ to 1.8 Indoor LOS	$\gamma = 2.7$ to 3.5 Urban Area
1 m	- 61,4 dB	- 52 dB (k=1,7)	-92,1 dB (k = 3)
10 m	- 81,4 dB	-69 dB	-122,1 dB
100 m	- 101,4 dB	-86 dB	- 151,1 dB
1000 m	- 121,4 dB	-103 dB	- 181,1 dB

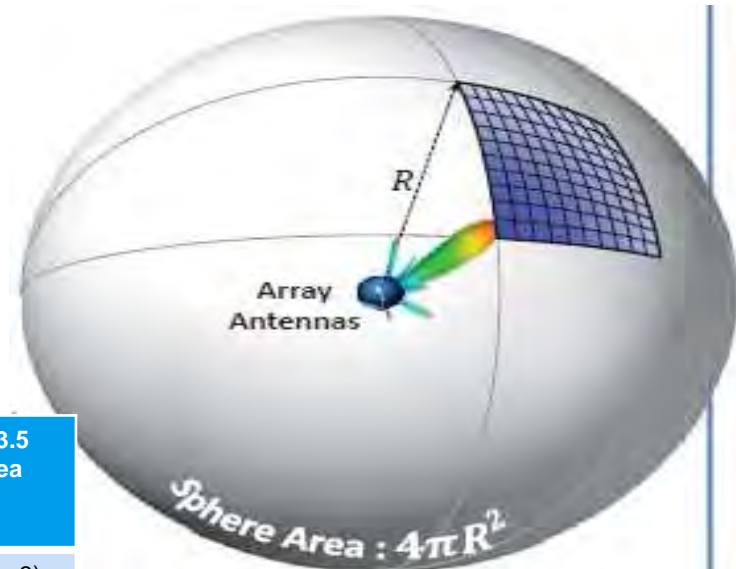

γ = path loss exponent

Channel sounding

Main idea of channel sounding is to understand the wave propagation characteristics
Like attenuation, power delay profile, direction of arrival, correlation aspects etc.
-> especially for the „higher“ frequency ranges

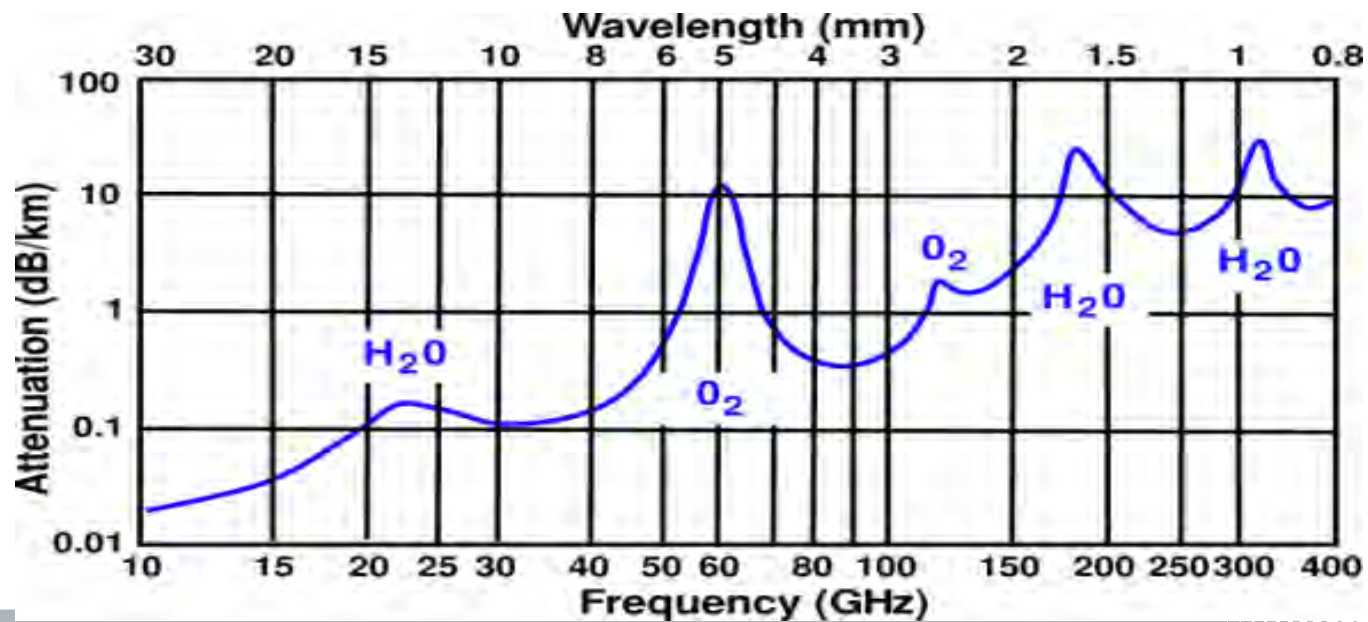

Channel sounding – multipath propagation MPP

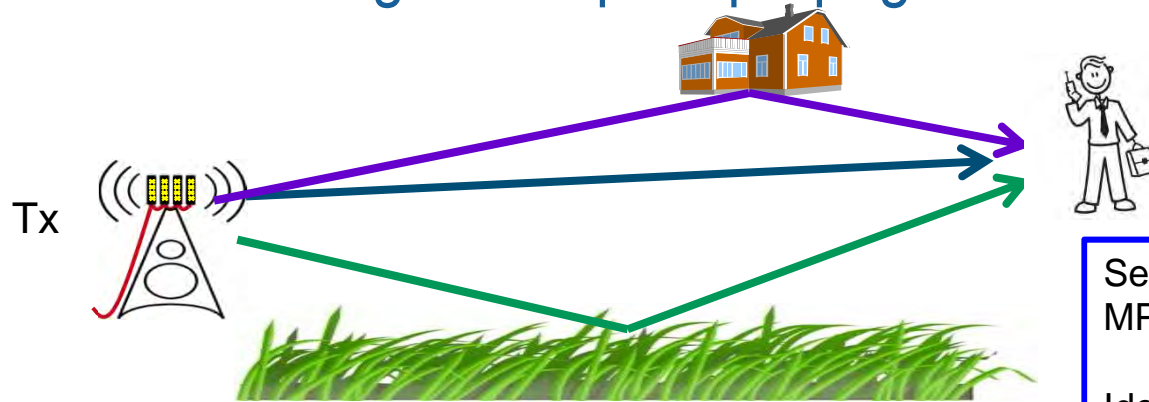

Channel impulse response CIR

$$h(\tau, t) = \sum_{i=0}^{L-1} a_i(t) e^{j\phi_i(t)} \delta(\tau - \tau_i)$$

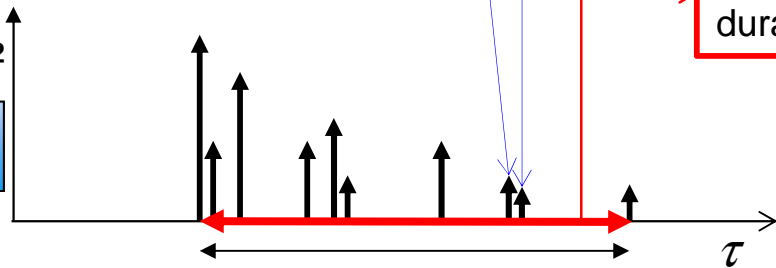

Separability of MPP components
 Identify each MPP component.
 $\tau_{RES} \approx \frac{1}{B}$

Minimum measurement duration

Channel sounding – 5G request

Tx, optionally using beamforming

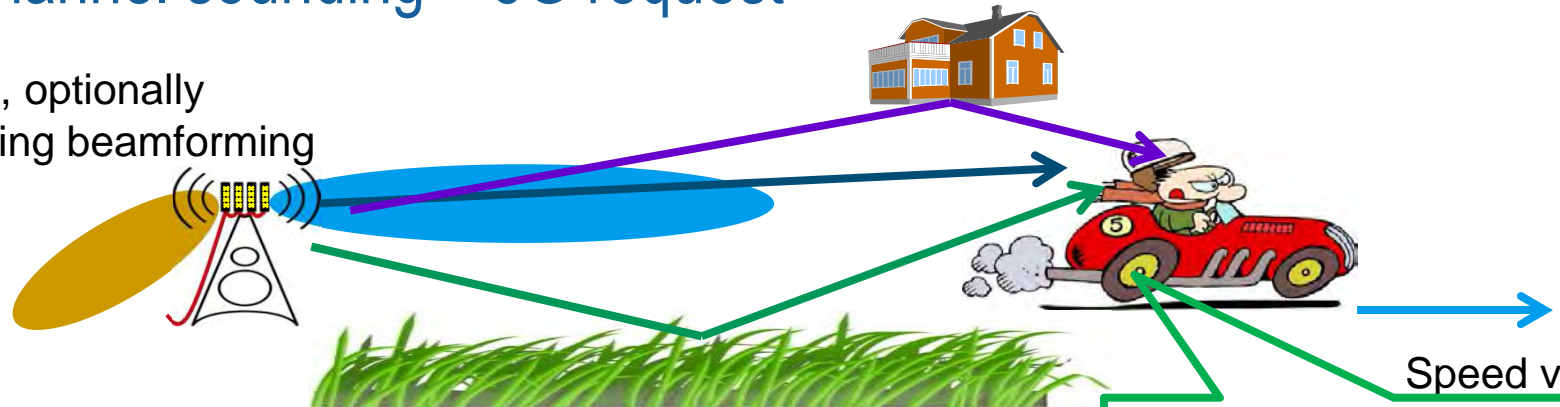

Channel impulse response CIR: time variant and depending on direction of arrival

$$h(t, \tau, \varphi) = \sum_{\Delta\varphi=0^\circ}^{360^\circ} \Delta\varphi \sum_{i=0}^{L-1} a_i(t) \cdot e^{j\Phi(t)} \cdot \delta(\tau - \tau_i)$$

Each multipath component is characterized by:

- Time t
- Angle of arrival $\Delta\varphi$
- Doppler shift
- Excess delay ΔT
- Phase shift
- In MIMO condition it would end up in a $N \times M$ matrix set

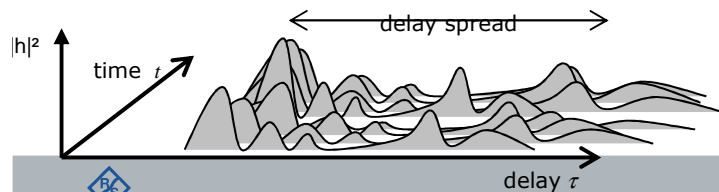

Why channel modeling ?

Objectives

- The performance of a radio system is ultimately determined by the radio channel
- The channel models basis for
 - System design
 - Algorithm design, antenna design
- Without reliable channel models, it is hard to design radio systems that work well in real environments.
- New **challenges** within “5 G mm-waves”
 - *Extremely extended frequency range i.e. frequency dependency of parameters (6 – 100 GHz)*
 - *Spatial information / 3D beamforming / spatial consistency*

- Some examples:
 - behavior in time/place?
 - behavior in frequency?
 - directional properties?
 - bandwidth dependency?
 - behavior in delay?



Channel Modeling Approaches

- Full Electromagnetic Solutions => exact geometry, materials
- Deterministic (Raytracing) => exact geometry, materials
- Quasi Deterministic + Stochastic (3D geometry-based stochastic channel models GSCM) => some geometry, large scale parameters needed, complexity at acceptable level

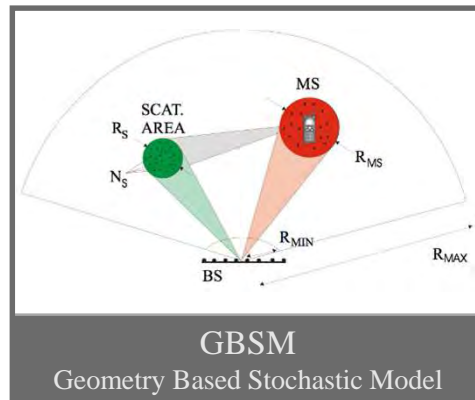

Raytracing

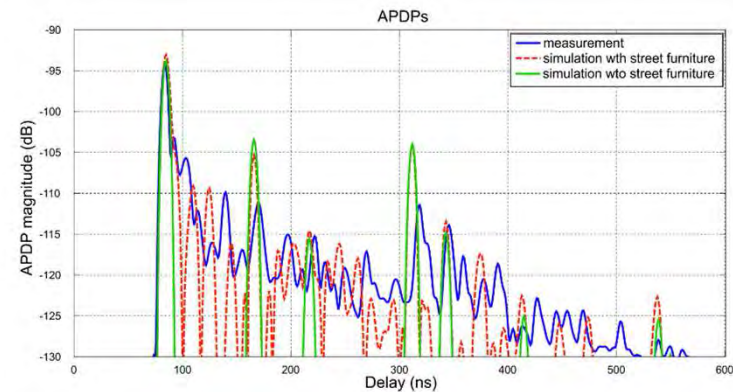
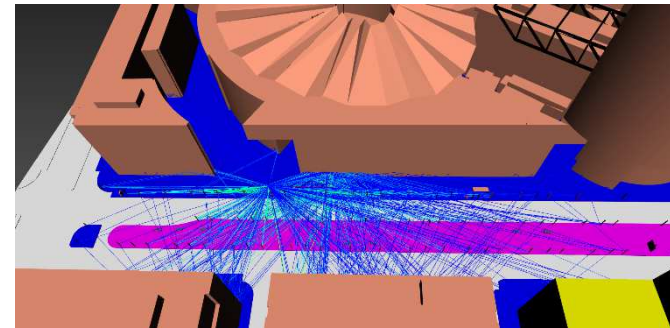

Channel sounding measurement aspects - structure

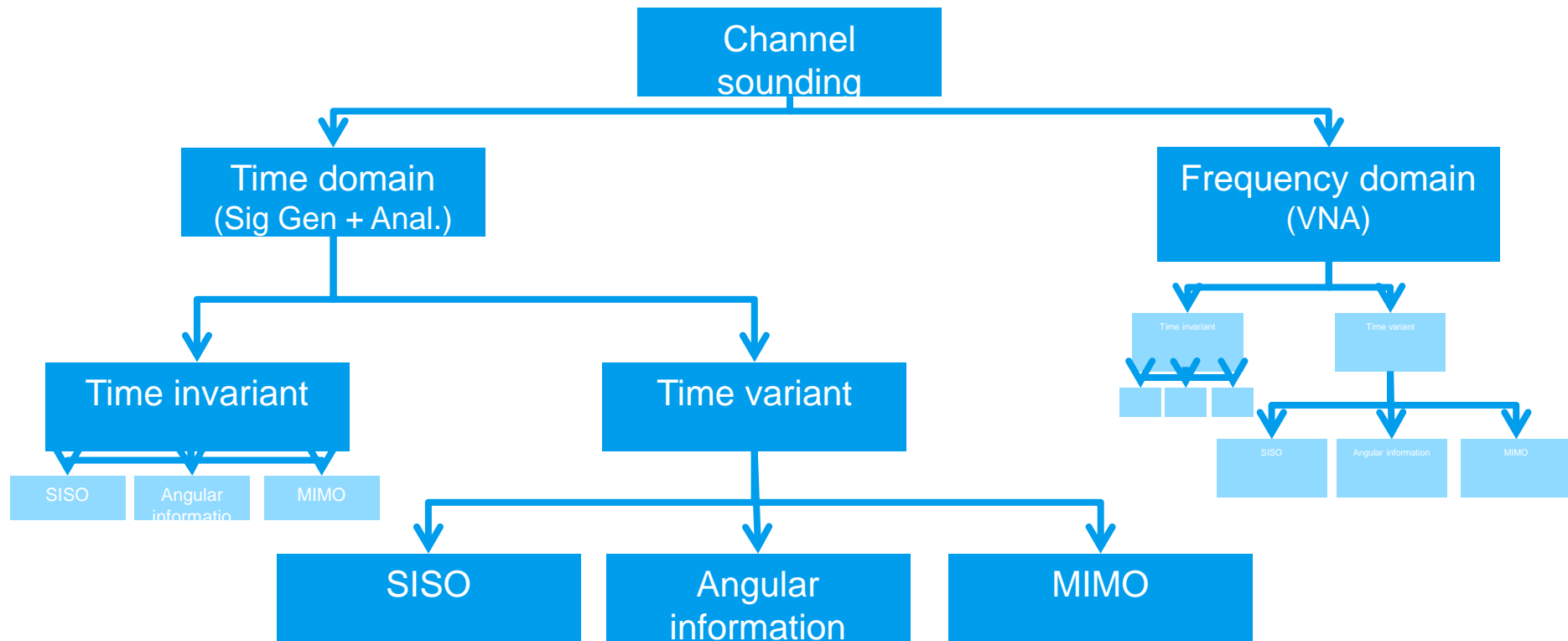

Channel measurements in mmWave frequency bands

R&S TS-5GCS channel sounding solution

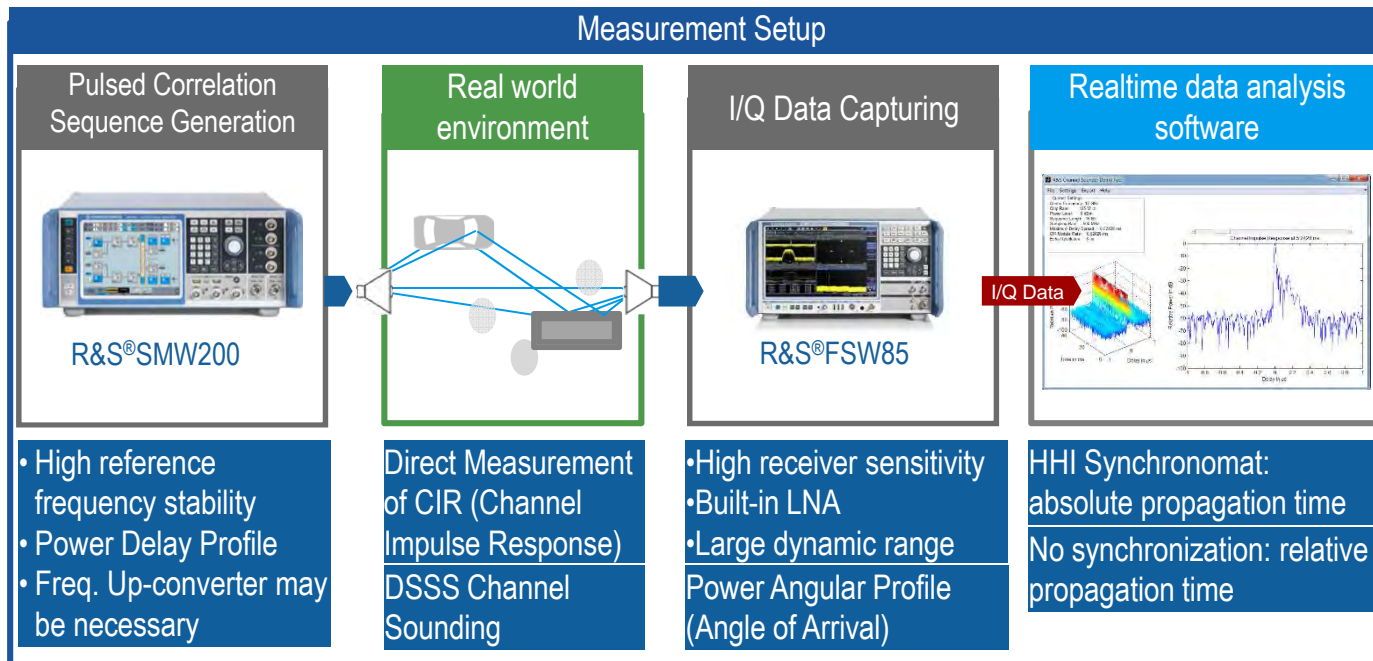

Channel sounding: relative or absolute timing information

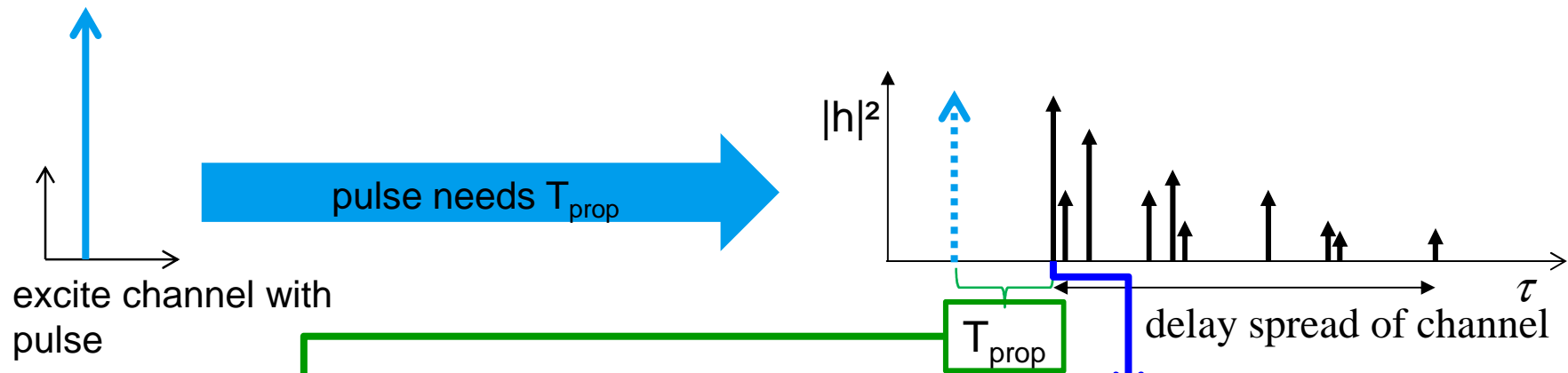

Absolute timing channel sounding:
We want to measure the propagation time between Tx and Rx.
=> some synchronisation will be needed

Relative timing channel sounding:
We do not get any information about the propagation time, the CIR is based on the first pulse received.
=> no synchronisation between Tx and Rx

Sounding @ 82.5 GHz

R&S 5G mmWave Expert Day September 2015

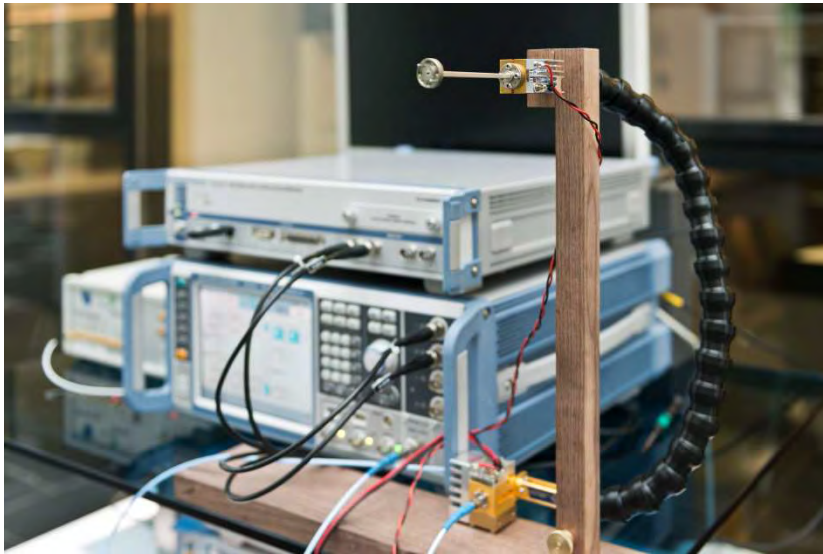

500 MHz BW transmitter AFQ100B + SMW200A



500 MHz BW receiver FSW85

Channel sounding campaign with HHI Fraunhofer (Berlin, Nov. 27th, 2015)



- HHI together with R&S conducted simultaneous measurements at 10 GHz, 28 GHz, 40 GHz and 82 GHz (500 MHz BW for 10 GHz, 1.5 GHz BW for other frequencies).
- Scenarios: Street canyon and shopping mall.
- Evaluation of measurement results under way.

Channel sounding – evaluation aspects

There is no golden setup -> various aspects to consider

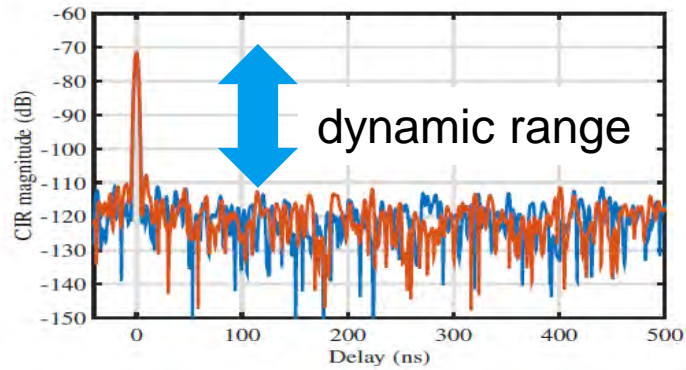

adjustable attenuator:
instantaneous dynamic
range decreases, when
attenuation increases

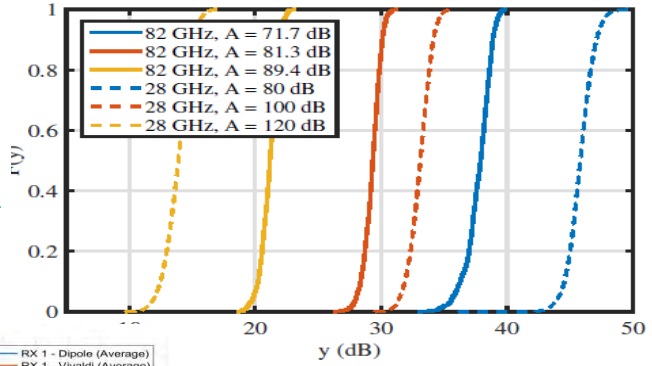

Amplitude error -> calibration required

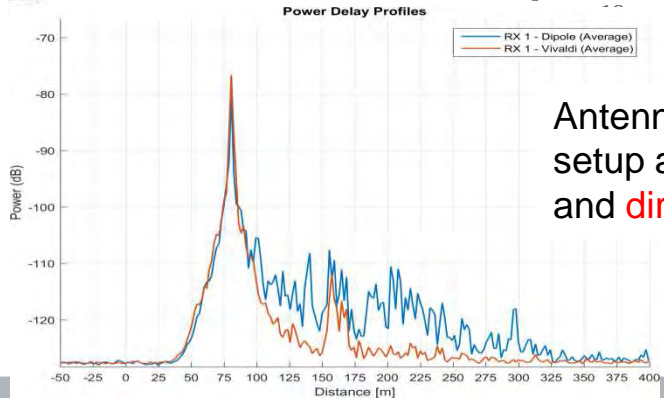
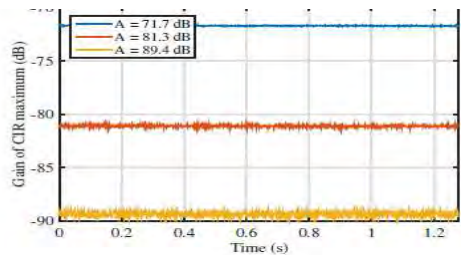

Antenna influence: e.g. outdoor
setup at 17 GHz using omnidirectional
and directional (Vivaldi) antenna

Source: Characterization of mm-wave Channel
sounders
(EuCAP2016 paper #1570230959)

Problem: Where does the echo come from?

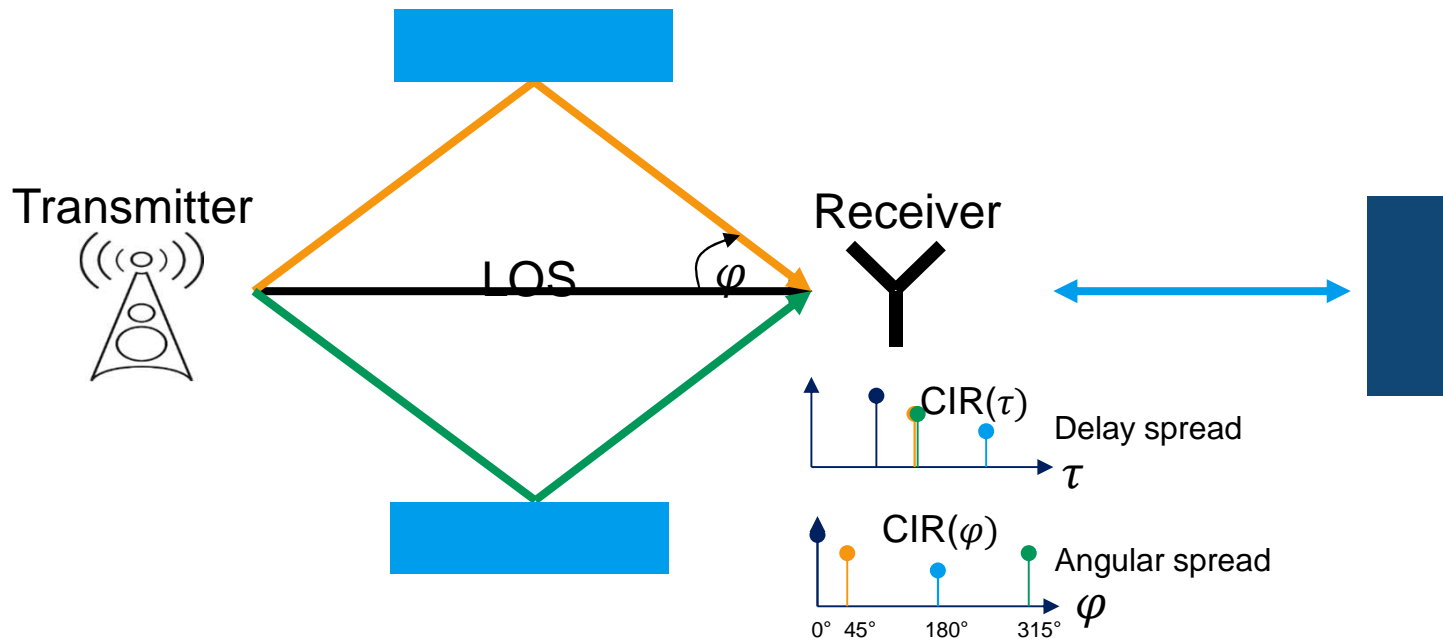

Directional Information: Spatial Filtering

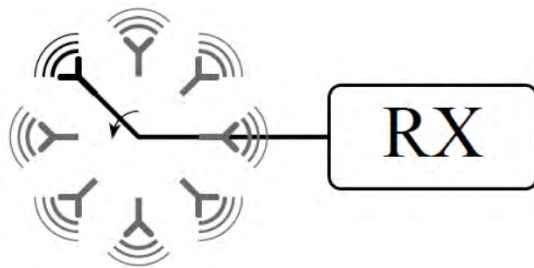

mechanical
Scanning

- Direct measurements of angles of arrivals
- Mechanical scanning is very slow, only suitable for static channels
- Mechanical scanning is very simple
- Limited resolution
- Ambiguity through overlapping patterns owing to the antenna characteristic
- difficult for high frequencies as high gain antennas are needed



Directional Information: Spatial Filtering

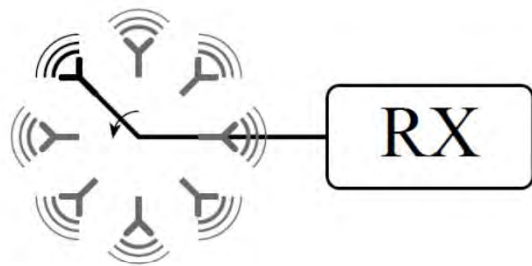

mechanical
Scanning

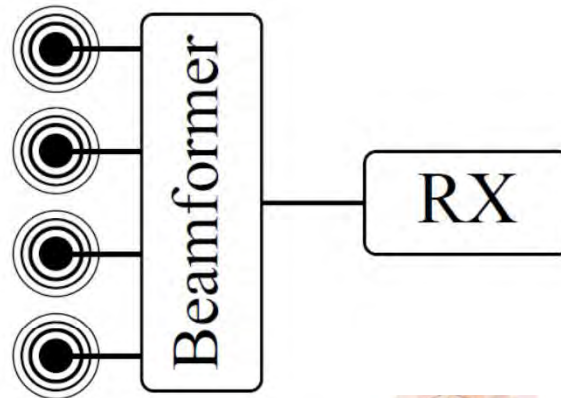

electronic
Scanning

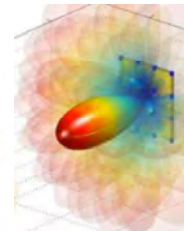

- Direct measurements of angles of arrivals
- High effort and low performance of electronic scanning
- Electronic scanning is very fast
- Limited resolution
- Ambiguity through overlapping patterns owing to the antenna characteristic
- difficult to obtain phase information



Directional Information: Estimation Algorithm

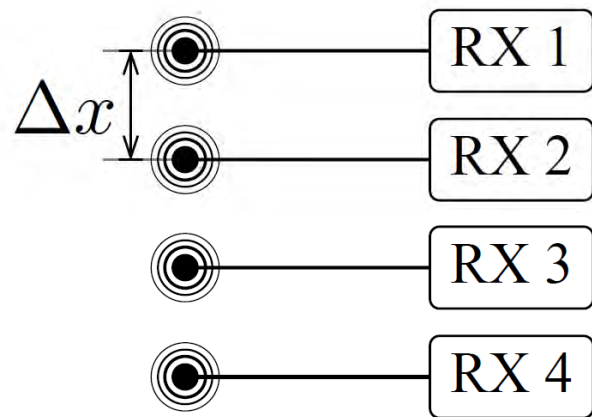

using amplitude
PDP and phase
information and
apply post-
processing, e.g.

MIMO



- Estimation of direction of arrival using array signal processing (MUSIC etc.)
- High hardware effort
- High measurement speed
- Sensitive to phase errors



Directional Information: Estimation Algorithm

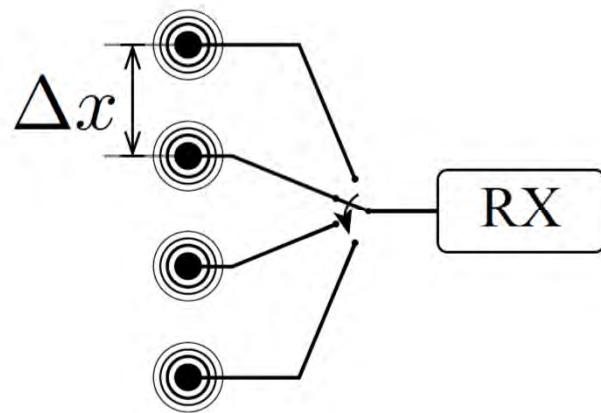

Switched Array



- Estimation of direction of arrival using array signal processing (MUSIC etc.)
- Less hardware effort (in comparison to mechanical antenna)
- High measurement speed
- Typically cylindrical switched array
- Linear, circular or 3D movements for virtual array
- Calibration needed, for every path!
- Sensitive to phase errors = difficult for high frequencies



Circular Switched Array Antenna for 3D DoA Measurements

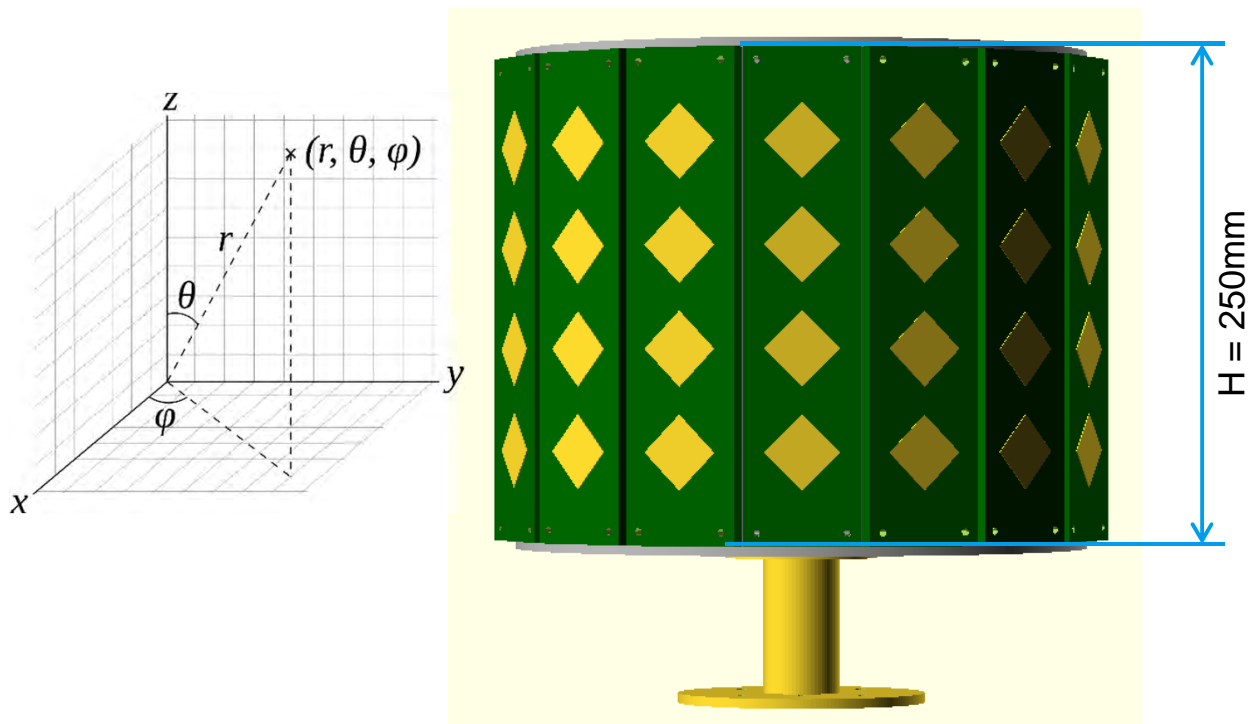

- Design for frequencies up to 18 GHz available
- Uniform cylindrical array
- 16 columns, 4 dual-polarized patch elements per column => 128 elements in total
- Alignment of switching by Synchronomat
- target frequency 3.75GHz
- Target bandwidth 800MHz
- Successfully applied for industry measurements

source: HHI Berlin

Directional Information: Estimation Algorithm

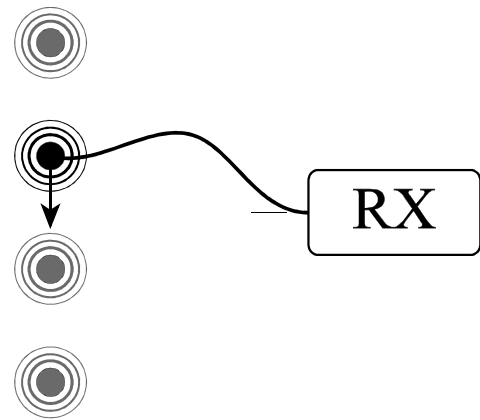

Virtual Array ✓

- Estimation of direction of arrival using array signal processing (MUSIC etc.)
- Less hardware effort (in comparison to mechanical antenna)
- High measurement speed
- Typically cylindrical switched array
- Linear, circular or 3D movements for virtual array
- No calibration needed for virtual array
- Sensitive to phase errors



Angular Information from Virtual Arrays: Proof of Concept

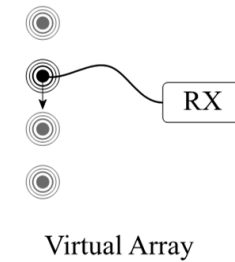

- Indoor measurement in the Rohde & Schwarz R&D center “atrium”
- Frequency: 17 GHz
- Linear moving receiver
- 1 ms snapshot rate
- Measurement bandwidth: 250 MHz



Angular Information from Virtual Arrays: Proof of Concept: Large scale virtual array

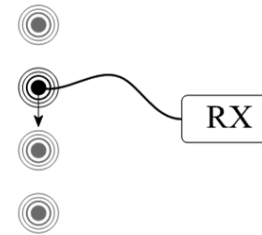

Virtual Array

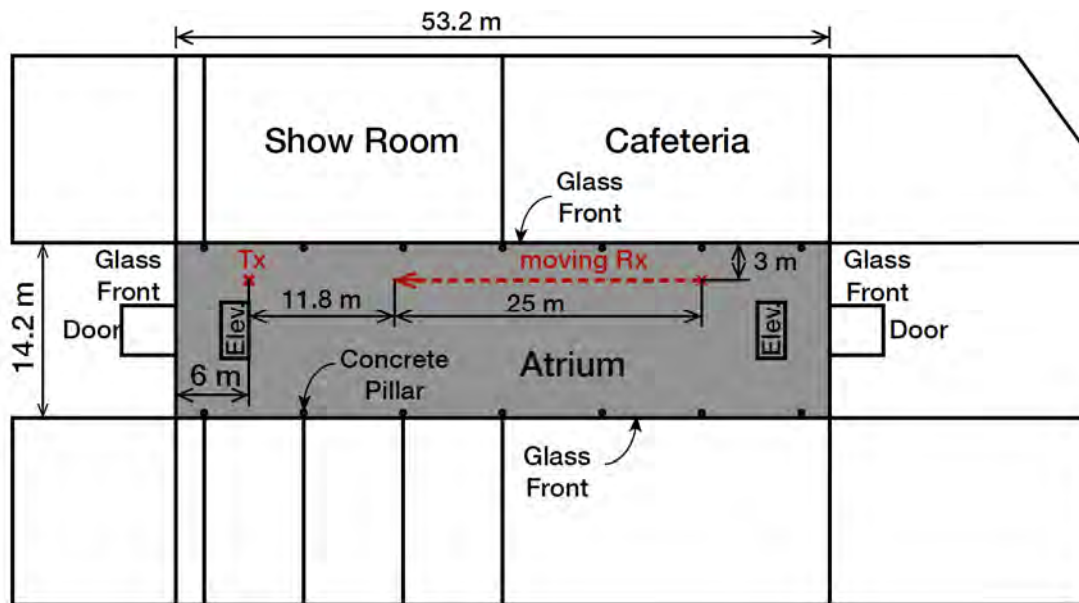

- Indoor measurement in the Rohde & Schwarz R&D center “atrium”
- Frequency: 17 GHz
- Linear moving receiver
- 1 ms snapshot rate
- Measurement bandwidth: 250 MHz

Source: Estimation of DoA based on Large Scale Virtual Array
(EuCAP2016 paper #1570231978)



Evolution of CIRs over moving distance (time)

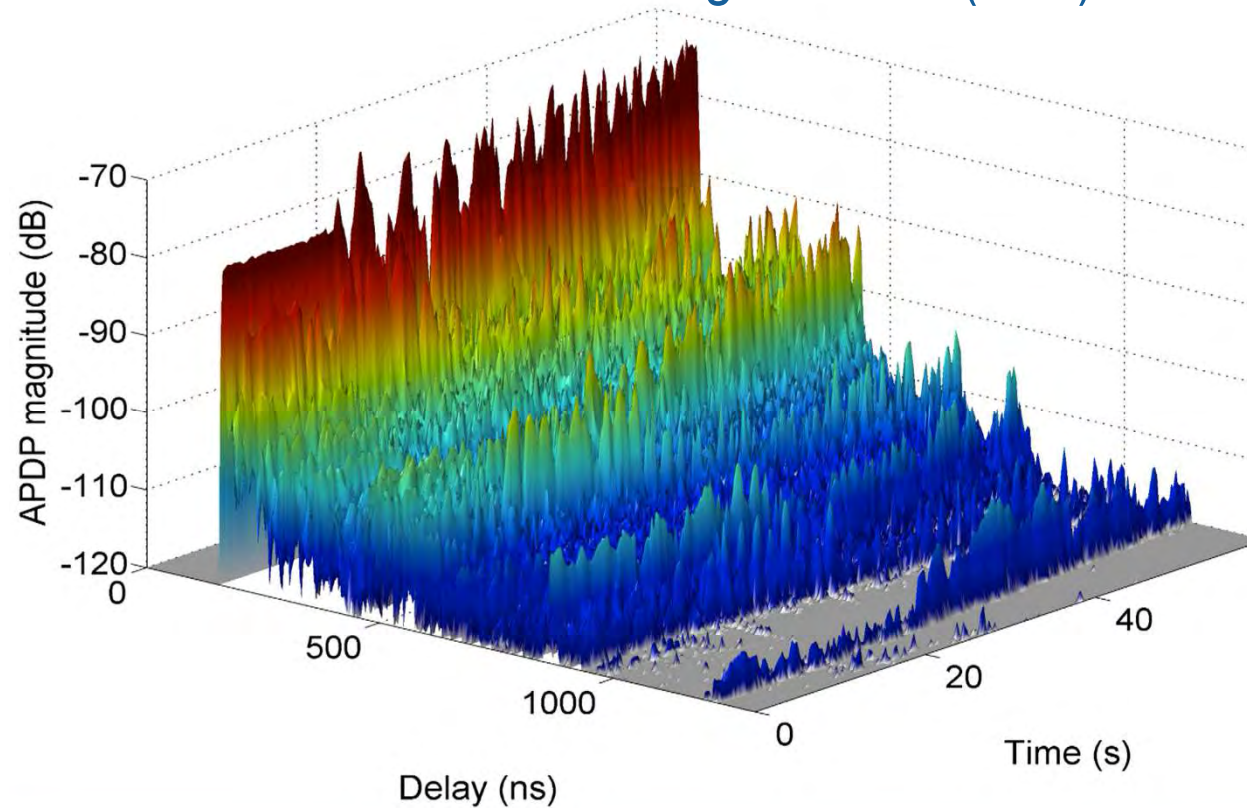

- Direct outcome of measurements at 17 GHz
- 60,000 snapshots in 60s, distance 25m
- In the first 10s no movement
- Line-Of-Sight Path (LOS) and reflected components (multipath contributions: MPC)
- Channel length: $1\mu\text{s}$
- Large-scale fading of MPCs due to RX movement

Evolution of the CIRs over moving distance

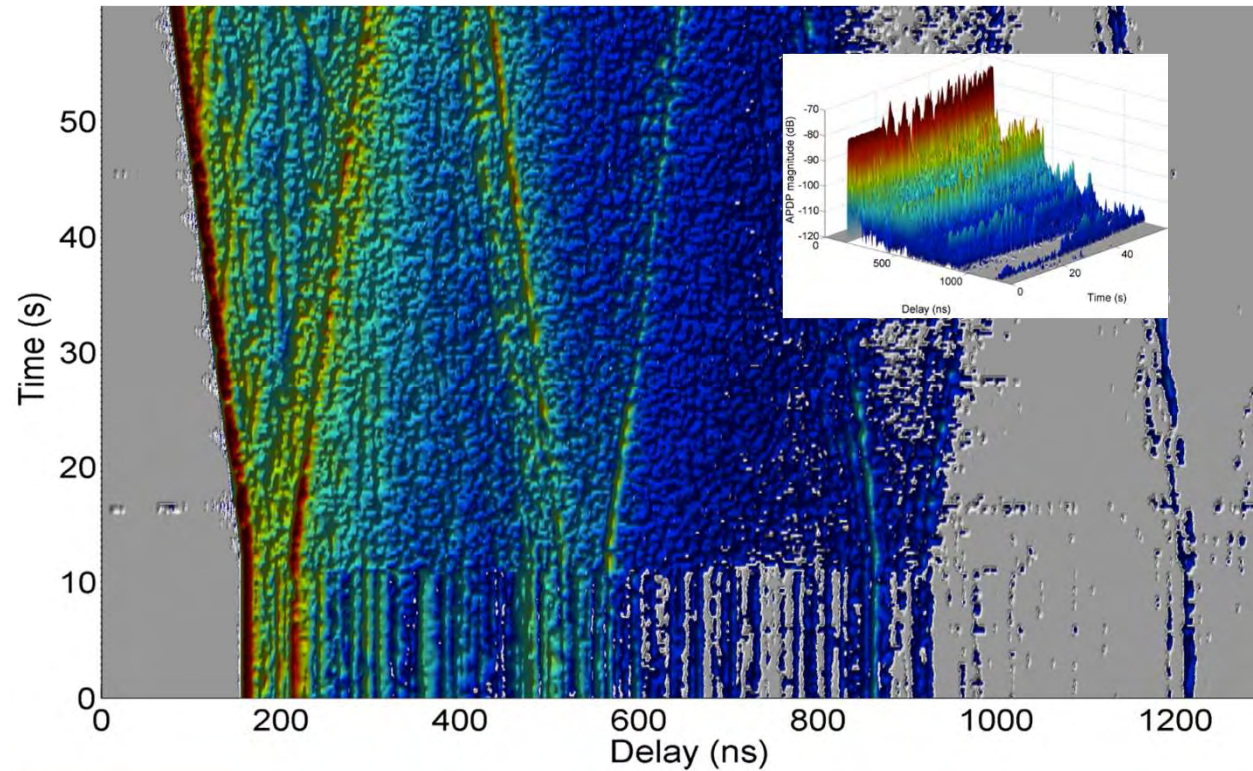

- Top-view of set of power delay profiles
- Change of delays due to movement (piecewise linear)
- Certain paths (tracks) clearly visible



Path Tracking

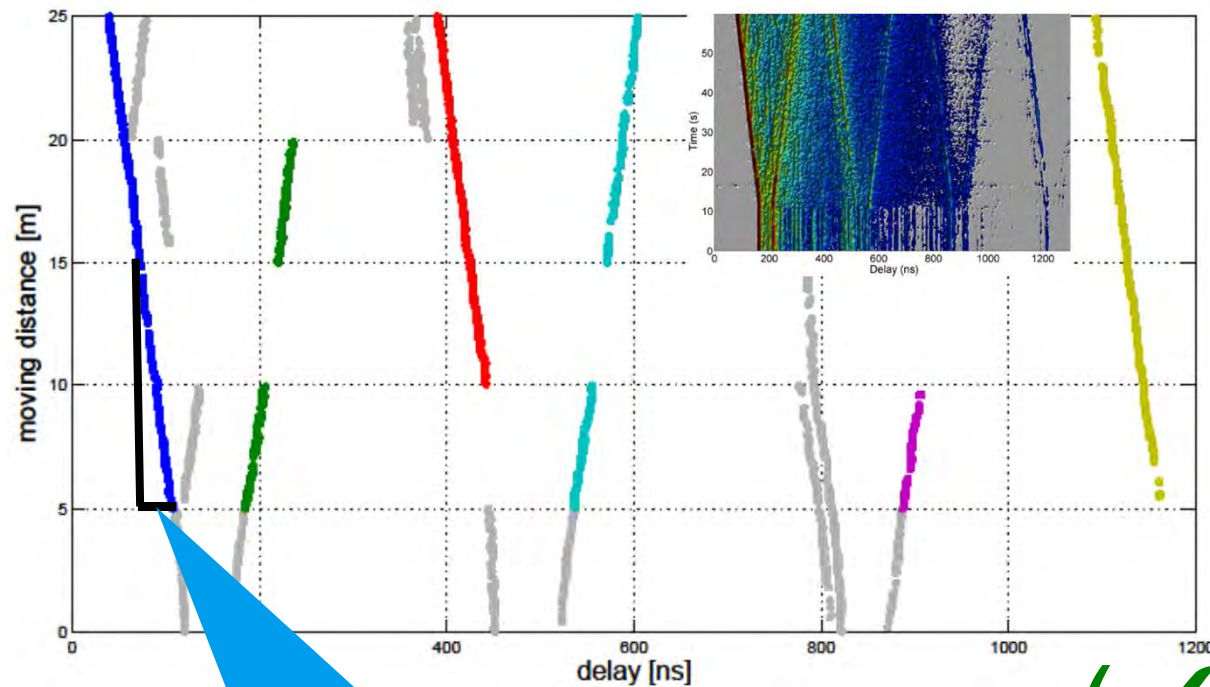

idea: from the steepness of the path we can derive the DoA



- Estimation of the paths by tracking algorithm
- Evolution of delay over time (i.e. distance) yields information about direction of arrival and Doppler shift
- Robust large scale analysis as long as direction of paths do not change during measurement run (farfield assumption)



Direction of Arrival DoA Evaluation

- The relationship between a detected trace and its DoA can be derived from geometry:

$$\phi = \arccos \left(c \cdot \frac{d\tau}{dx} \right), \quad 0 \leq \phi \leq \pi,$$

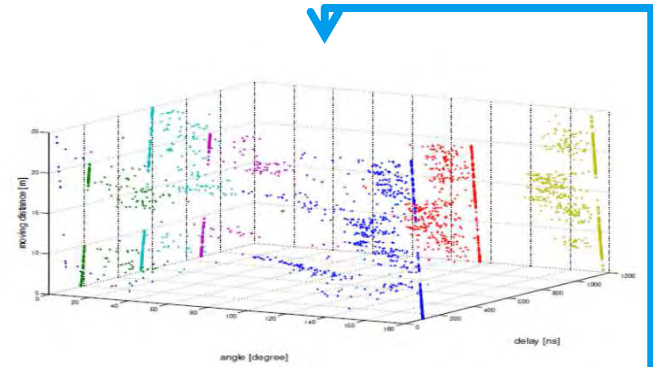

comparison with MUSIC proofs concept

distance [m]	cos(ϕ)							
25 – 20	−1,00	0.92	−0.52	−0.75	−0.96	1.01	−1.13	
15 – 20	−0.97	−0.78	0.94	−1.03	1.08	1.01	−0.99	
10 – 15	−1.03	−1.08	−0.46	−1.02				
5 – 10	−1.09	1.11	1.21	1.24	−1.25	−1.16	1.15	−1.28
0 – 5	−0.65	0.86	−0.33	0.92	−0.81	−0.59	0.90	

Direction of arrival testing

Power Azimuth Profiles

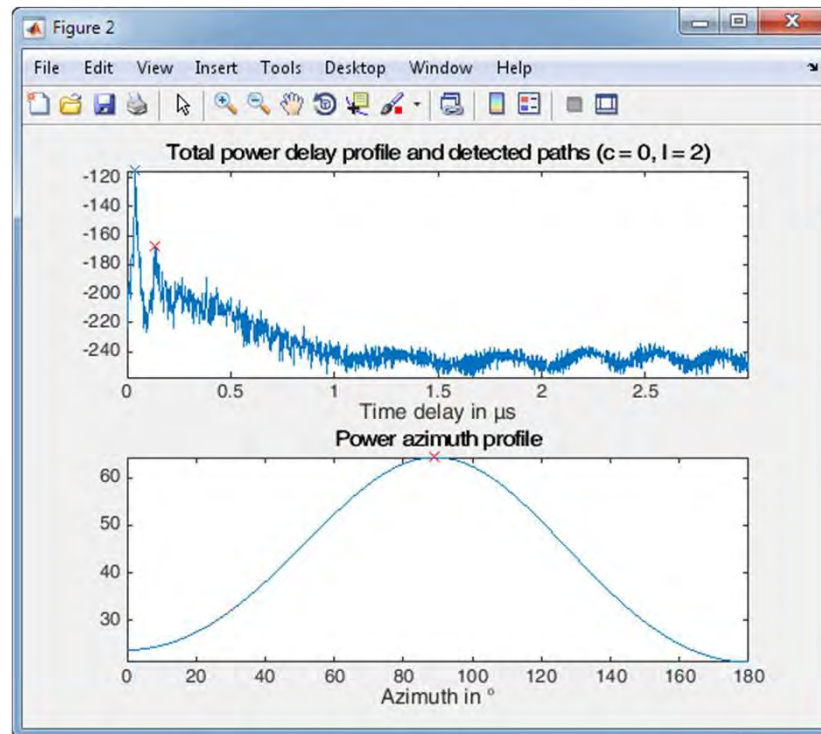

R&S Memmingen Factory Measurement Campaign

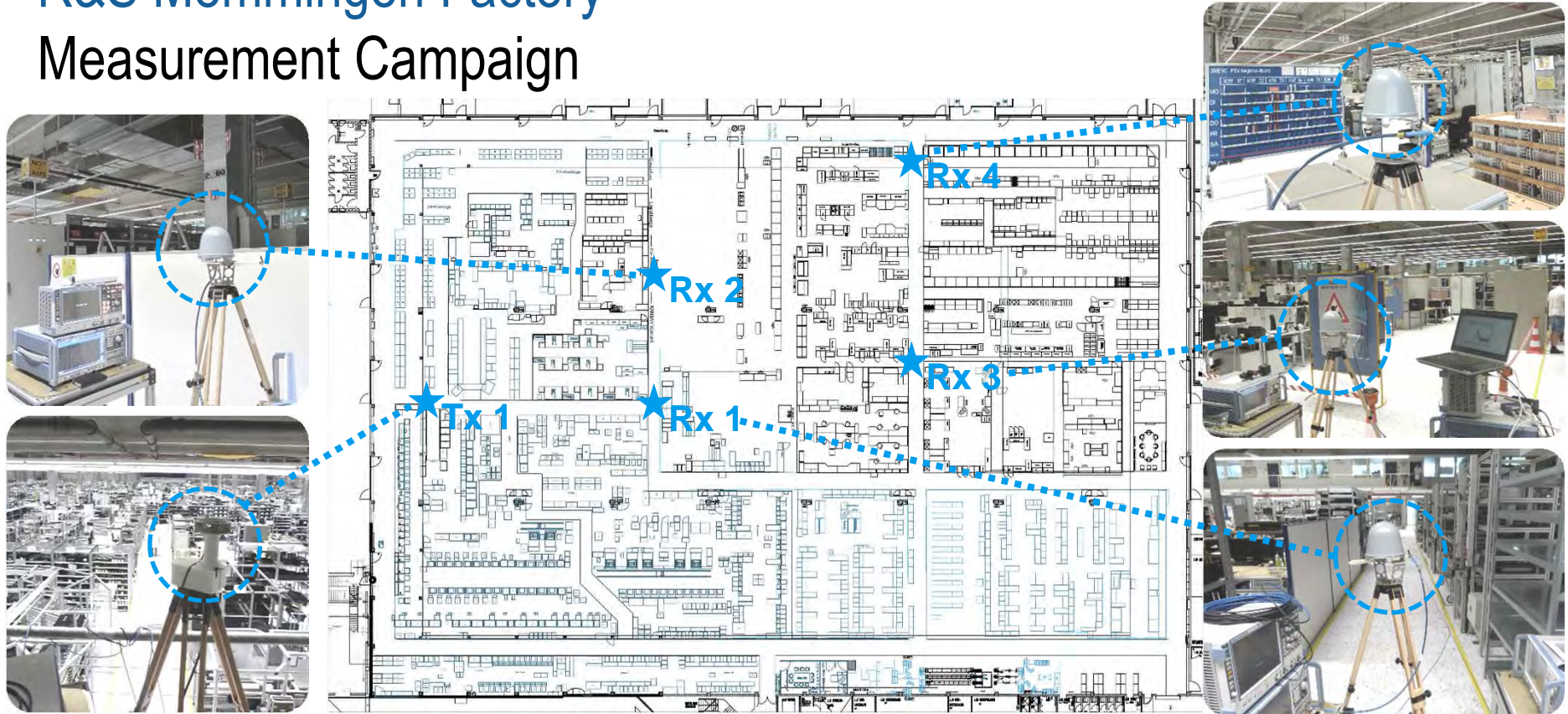

Industry 4.0 channel sounding trial

Position:
Tx1 Rx4 (NLOS)

Frequencies:
38 GHz,
28 GHz,
5.8 GHz

Bandwidth:
500 MHz

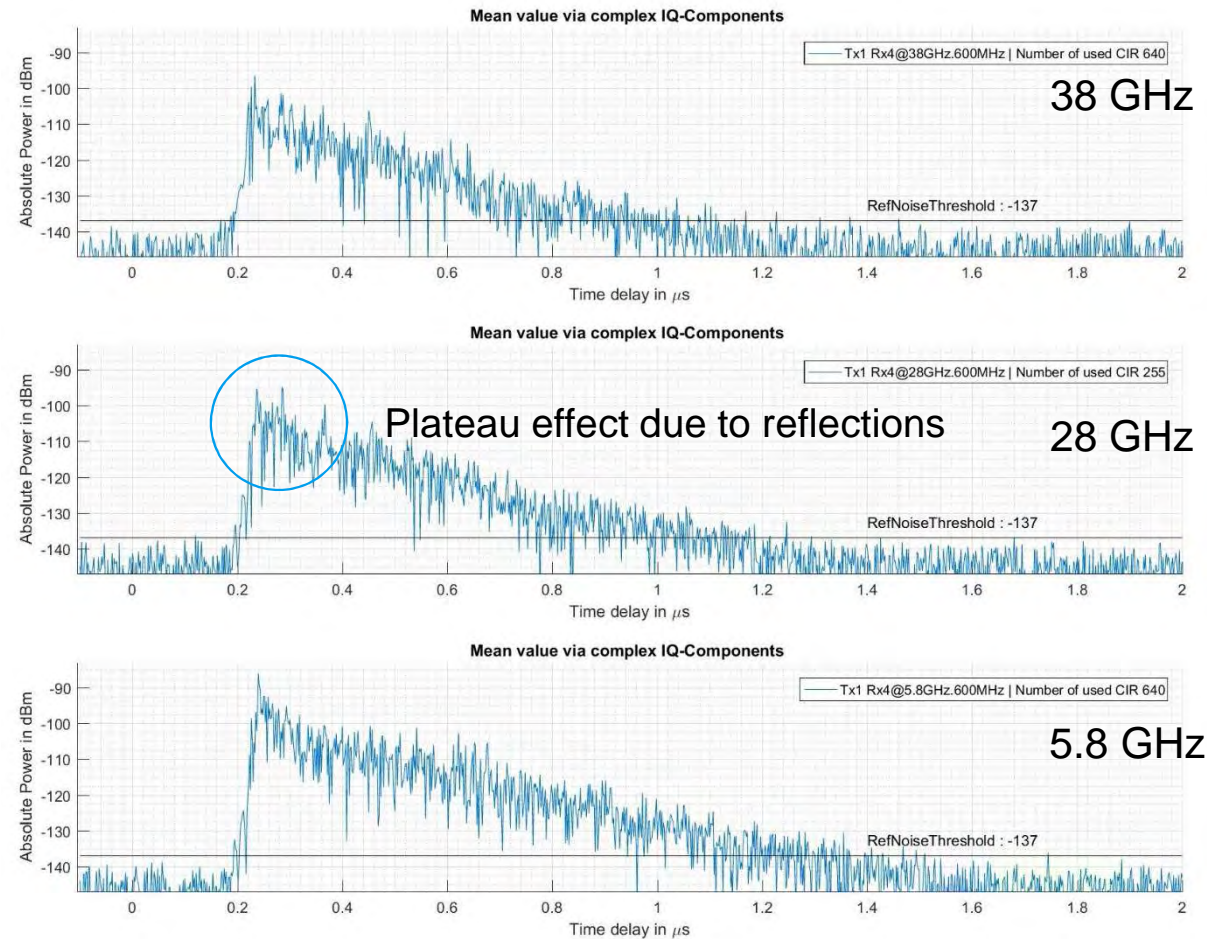

Industry 4.0 trial: Street in Factory Hall, Moving Vehicle Setup Description, R&S factory in Memmingen

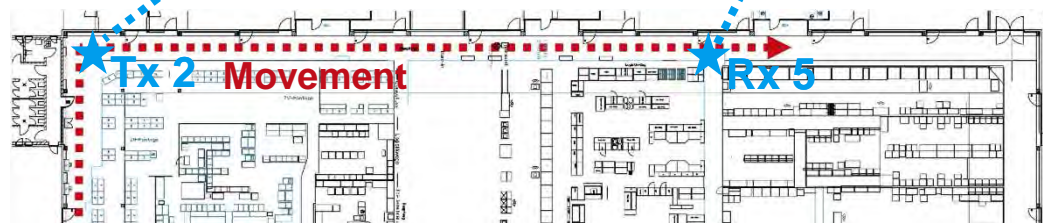

Industry 4.0 trial: Street in Factory Hall, Moving Vehicle R&S factory in Memmingen: Time-Delay Domain

Positions:
Tx2 Rx5

Frequency:
5.8 GHz

Bandwidth:
500 MHz

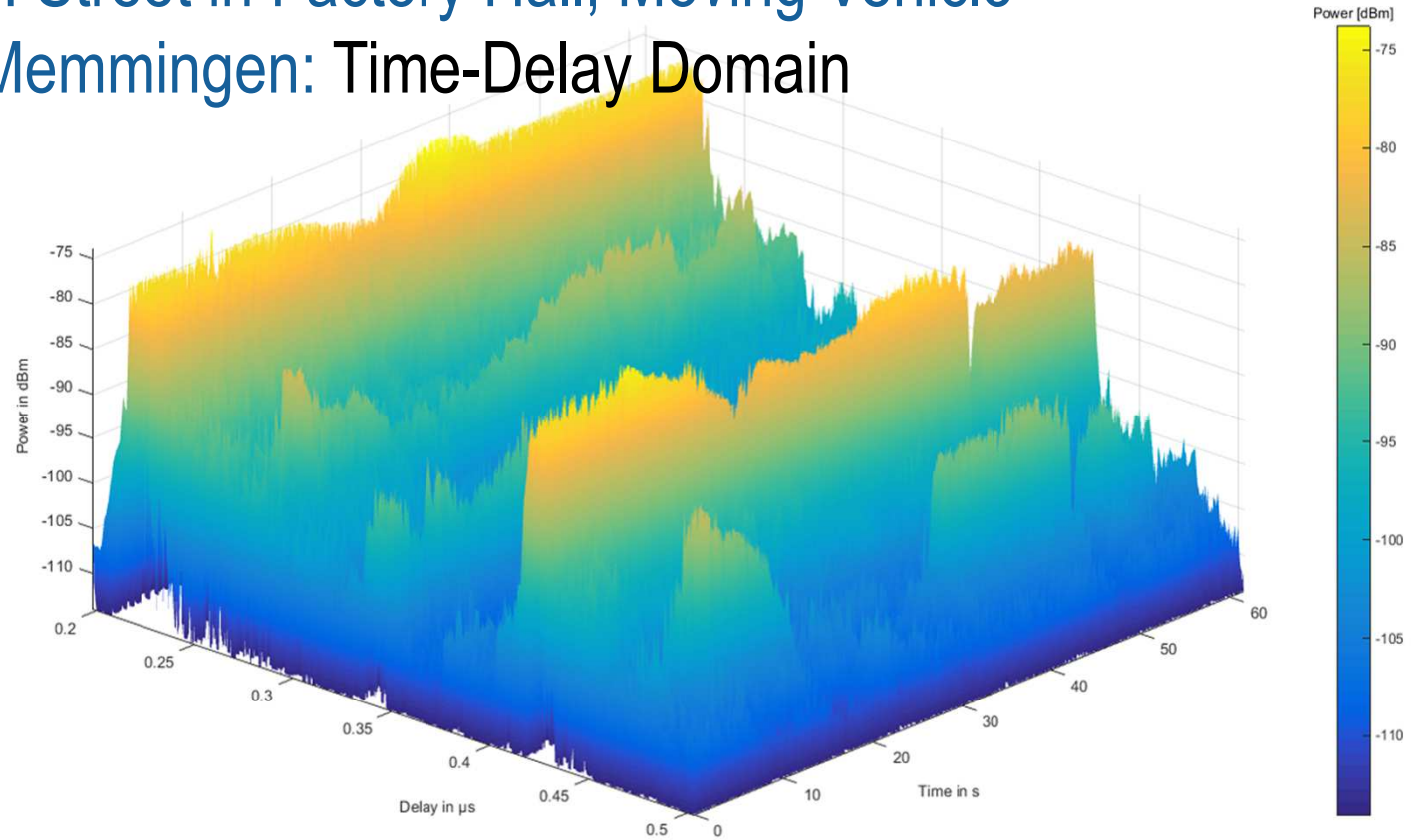

Industry 4.0 trial: balcony scenario: LOS and Rx is moved around a corner Corner Effect

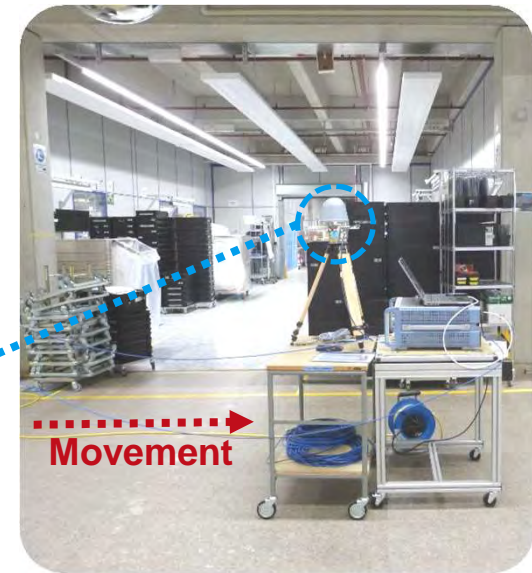
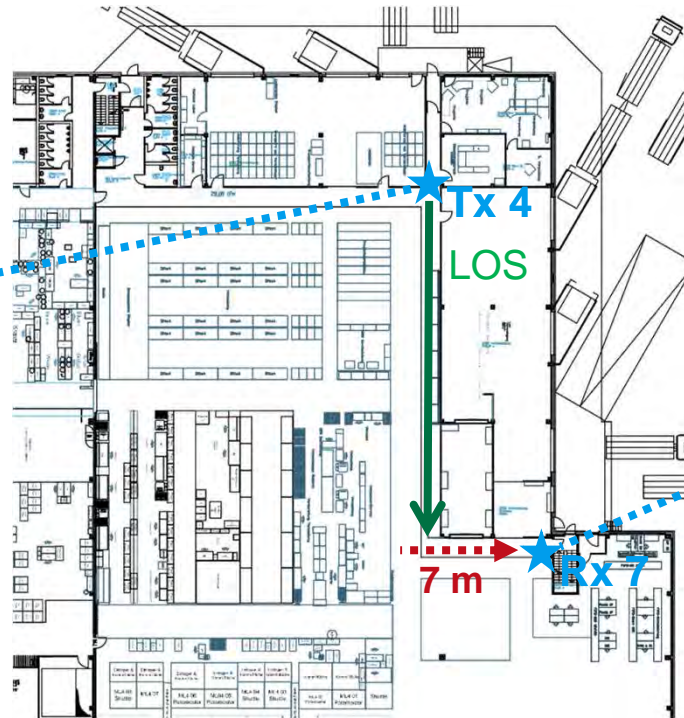

Industry 4.0 trial: power delay profile vs. time

Positions:
Tx4 Rx7

Frequency:
5.8 GHz

Bandwidth:
500 MHz

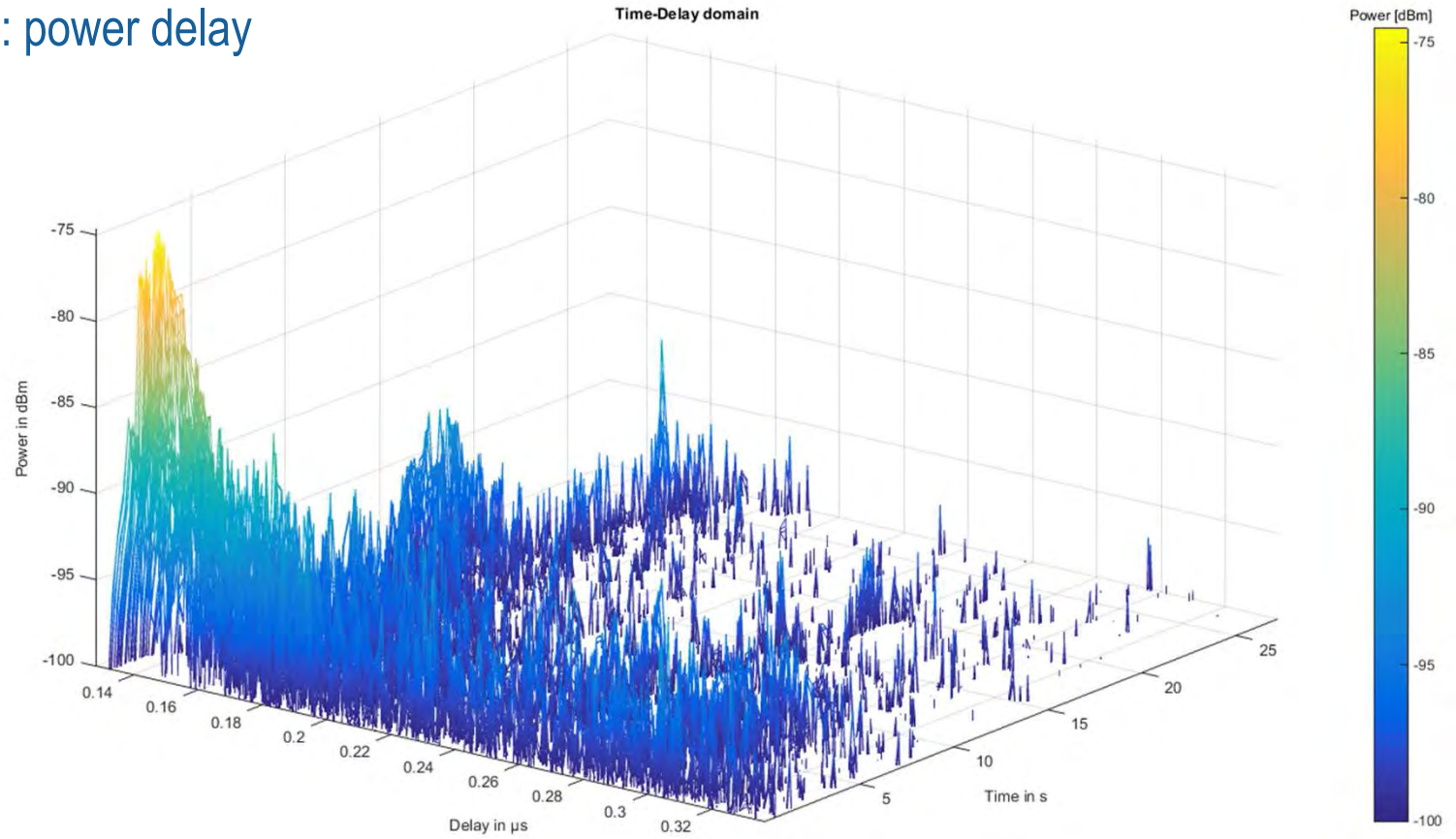

Industry 4.0 trial power delay profile vs. time

Positions:
Tx4 Rx7

Frequency:
38 GHz

Bandwidth:
500 MHz

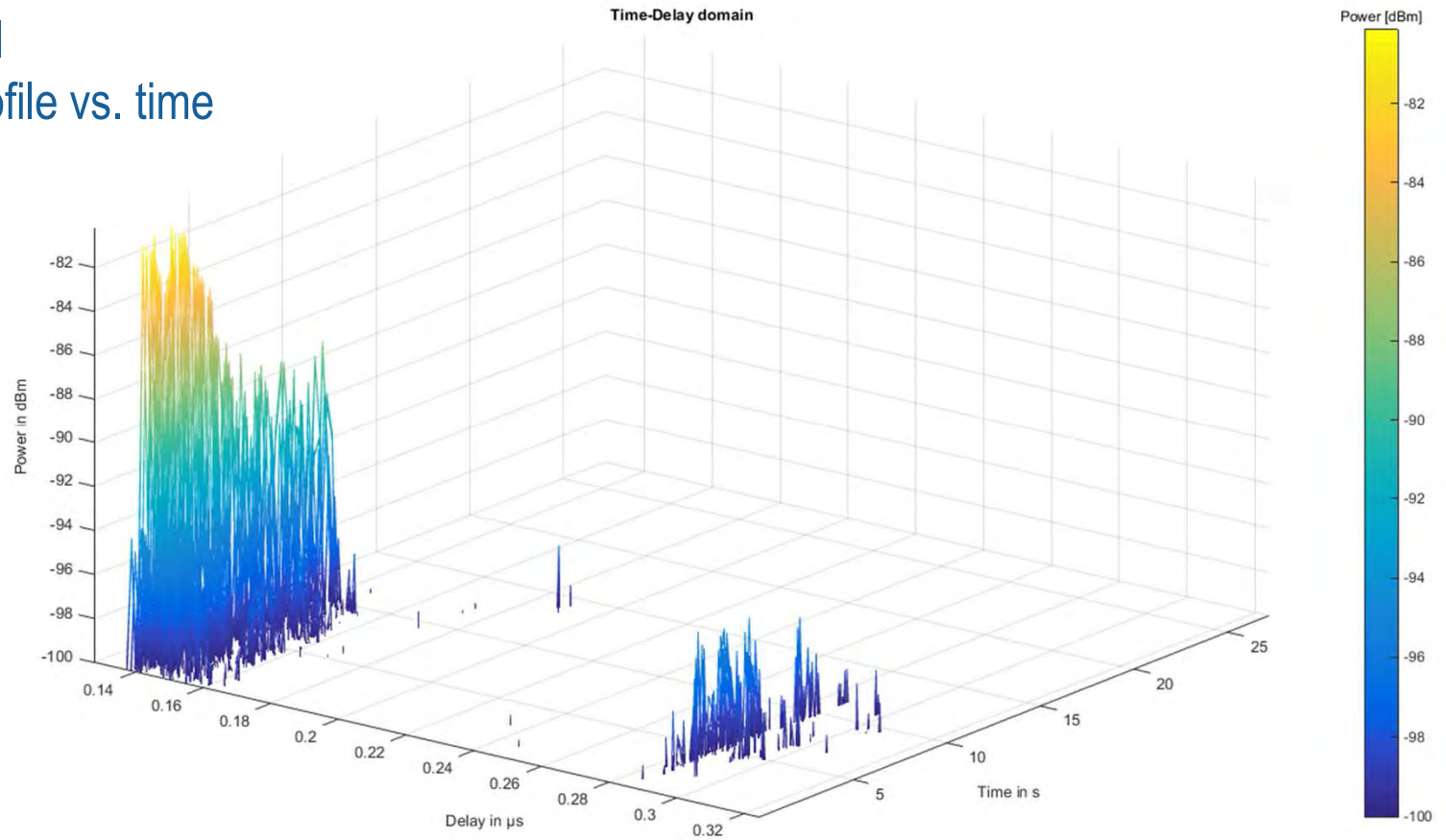

Feature comparison 3GPP 5G vs Pre-5G

Pre-5G

Frequencies:

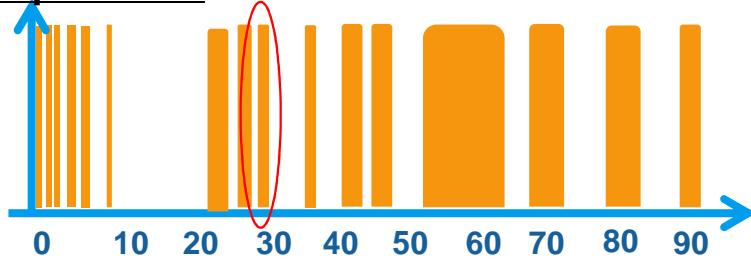

Only 28GHz in focus

Application:

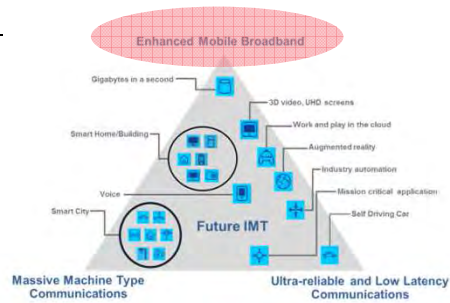

Only focus on eMBB

3GPP 5G + vision

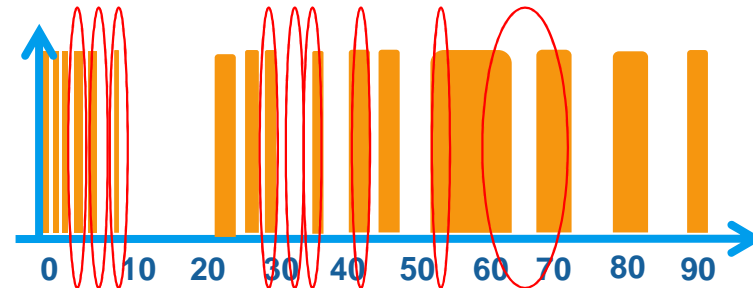

Various frequencies in focus: 700MHz, 3.5GHz, 5.9GHz, 15GHz, 25GHz, 28GHz, 38GHz,

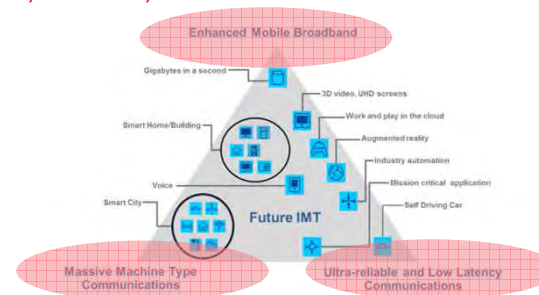

Focus on all: eMBB, mMTC and uRLLC

Feature comparison 3GPP 5G vs Pre-5G

Pre-5G

Bandwidth:

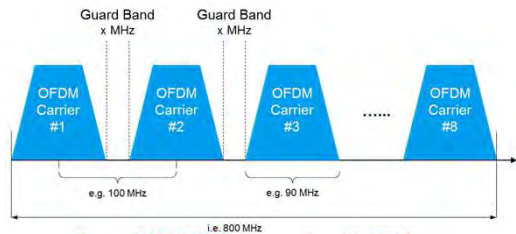

1 channel = 100MHz, up to 8 CCs
800MHz total bandwidth

subcarrier spacing:

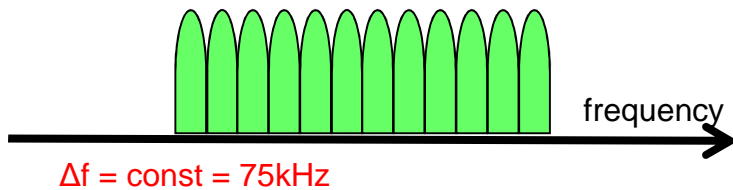

Modulation scheme:

QPSK, 16QAM + 64QAM

3GPP 5G + vision

Bandwidth:

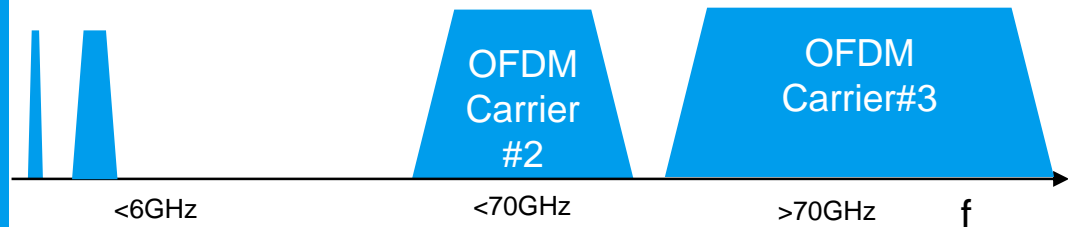

1 channel = 10 or 20MHz | 1 channel ~80MHz | 1 channel ~640MHz
total bandwidth up to 2GHz

subcarrier spacing:

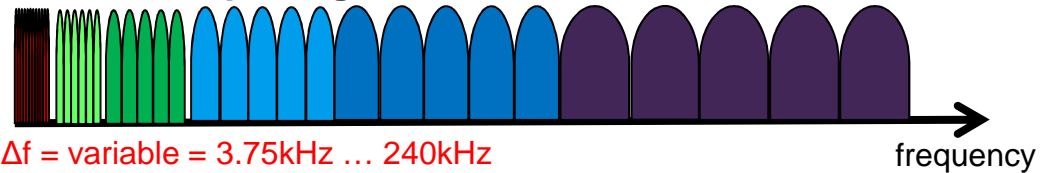

Modulation scheme:

QPSK, 16QAM, 64QAM + 256QAM (higher order tbd + alternative schemes i.e. 12 + 4 PSK or constant envelope)



Massive MIMO Theory & Hardware

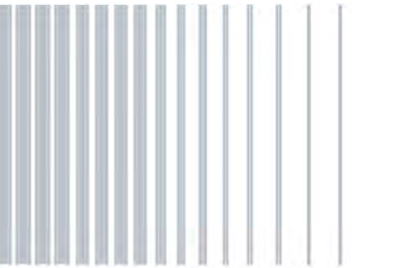

Energy Efficiency: Why Massive?



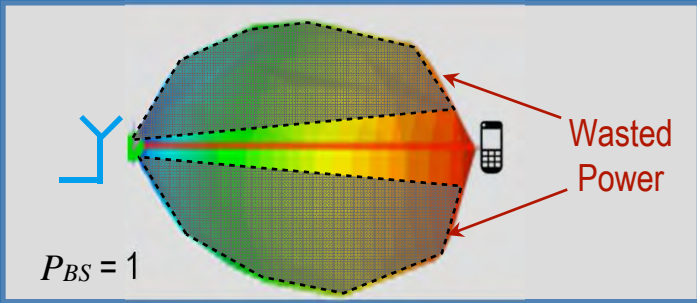

$P_{BS} = 1$

Number of Antennas = 1	
Number of BS Transmit Antennas	1
Normalized Output Power of Antennas	$P_{ant} = \frac{1}{M_t} = 1$
Normalized Output Power of Base Station	$P_{total} = \sum_{i=1}^{M_t} P_{ant}^i = 1$

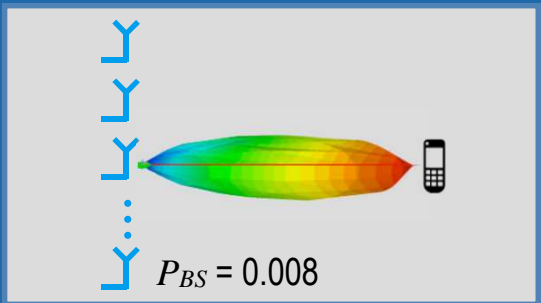

$P_{BS} = 0.008$

Number of UEs: 1 120 antennas per UE	
120	
$P_{ant} = \frac{1}{M_t^2}$	
$P_{total} = \sum_{i=1}^{M_t} P_{ant}^i = 0.008$	

Source: IEEE Signal Processing Magazine, Jan 2013

Energy Efficiency: energy efficiency vs site installation costs

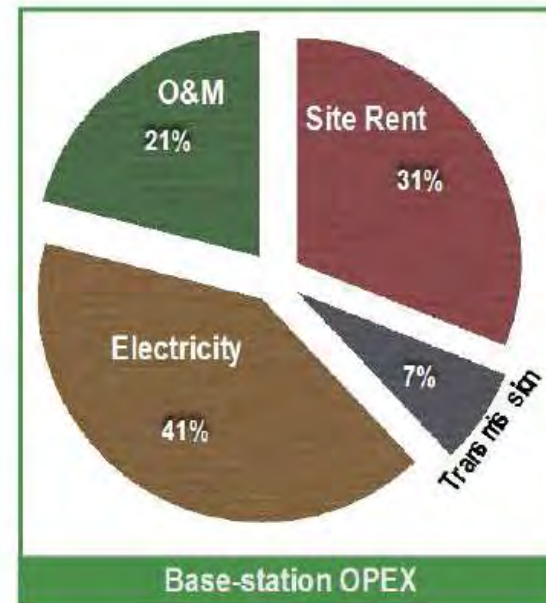
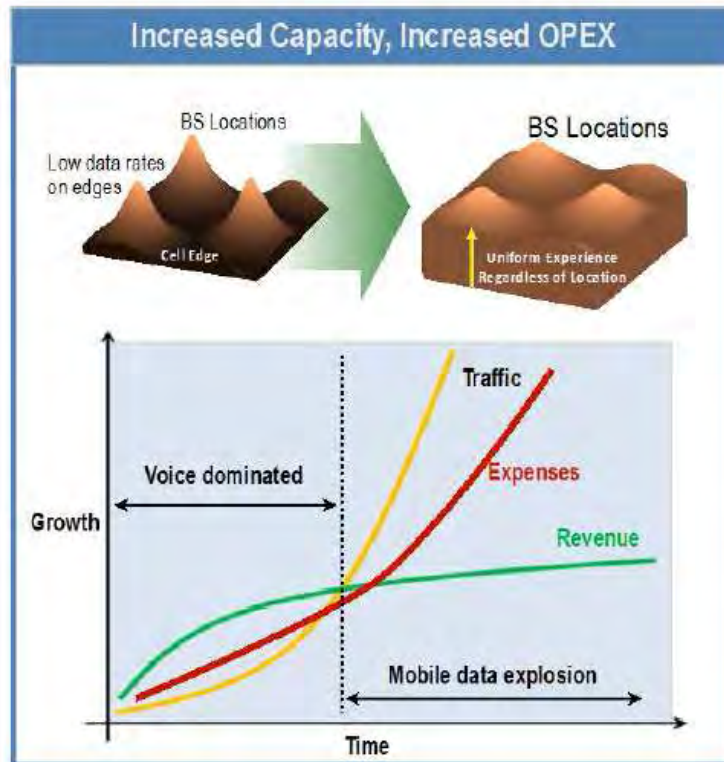

Phased Array Antenna Principle

Example: Linear array

- 8 antenna elements
- Equidistant spacing d
- Incident signal perpendicular to array

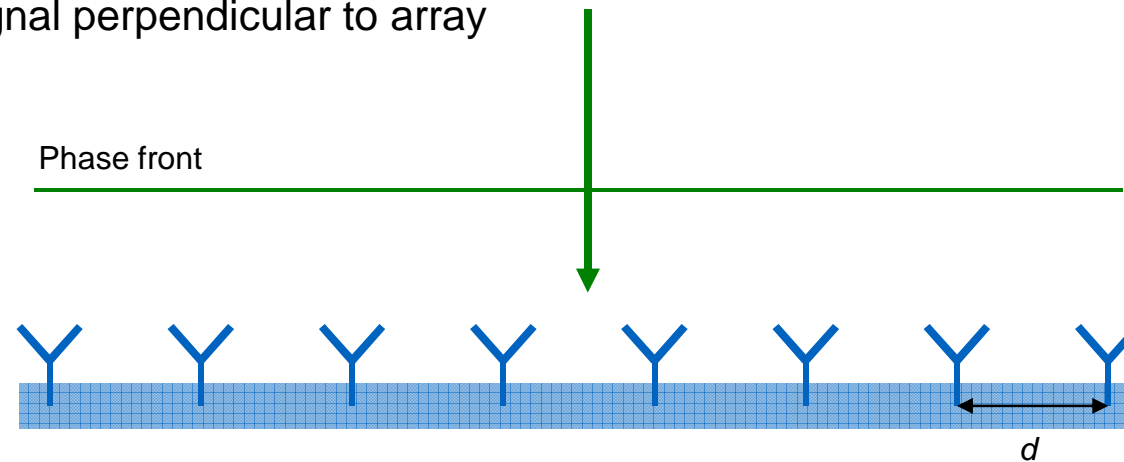

Phase front reaches all antenna elements at same time



Phased Array Antenna Principle

Example: Linear array

- Direction of incident signal with angle θ
- Phase front reaches antenna elements at different times

Idea:

- Compensate for phase difference
- Add phase shifters behind each antenna element!

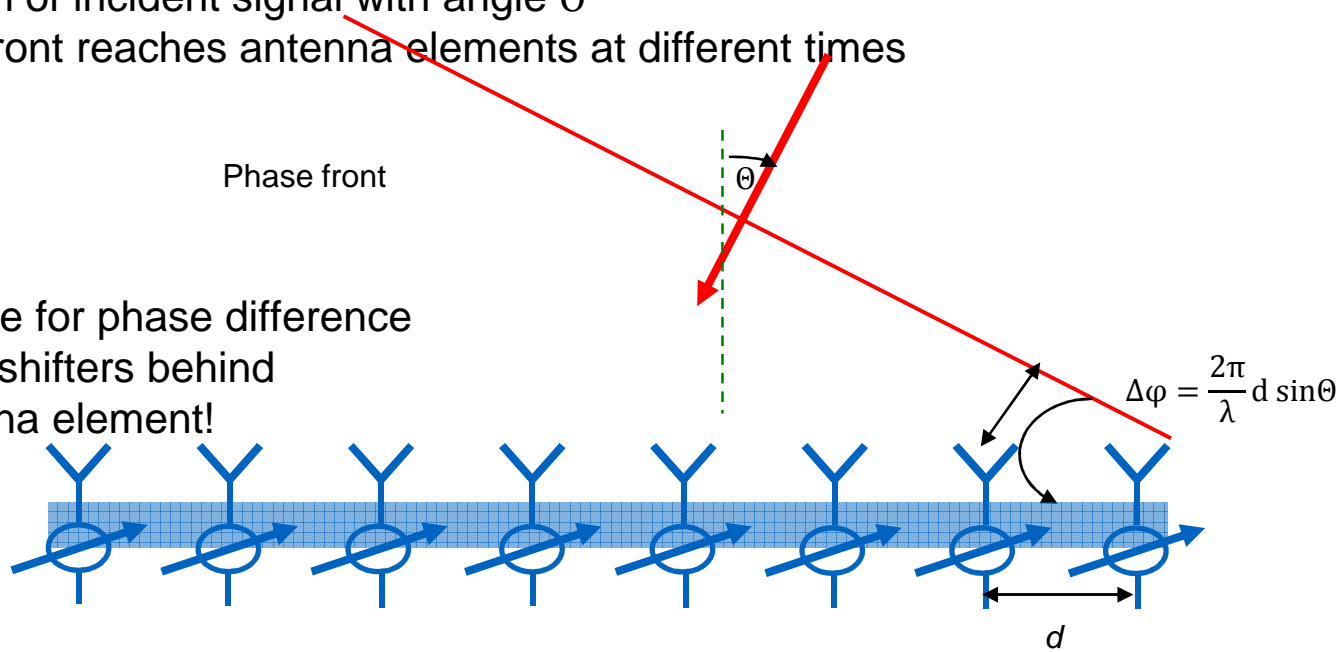

Phased Array Antenna Principle

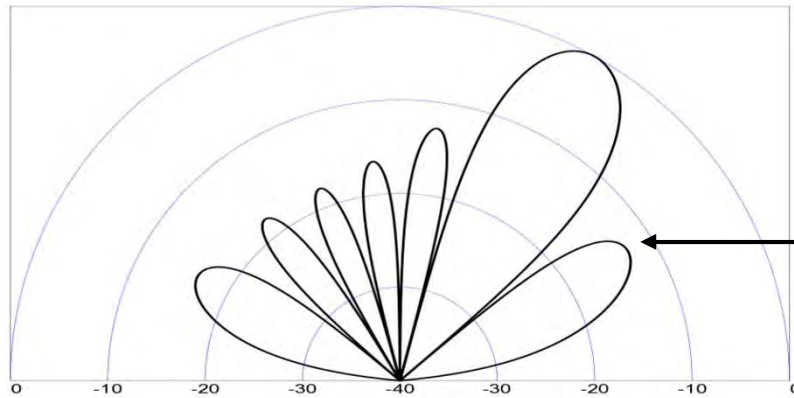

Advantage:
Main beam direction steerable with
phase shifters

Problem:
Still high side lobe level

How to get side lobe level down?

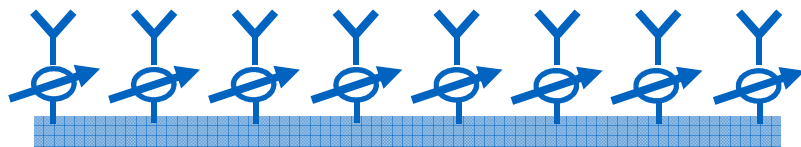

phase shifters:
Weighting by phase

Phased Array Antenna Principle

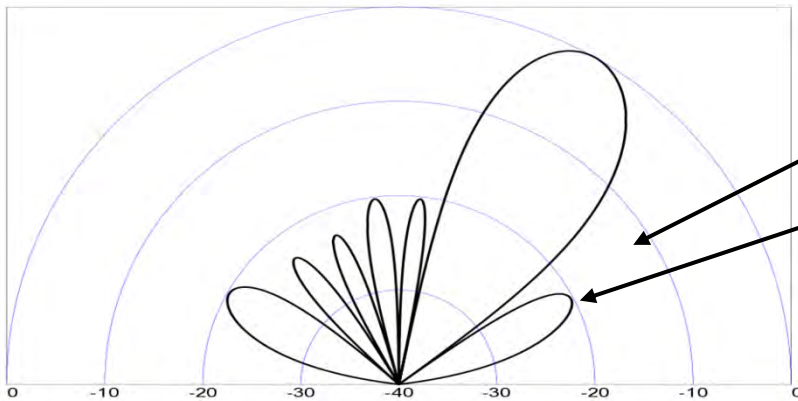

Question:
How to get side lobe level down?

Answer:
Additional weighting by magnitude!

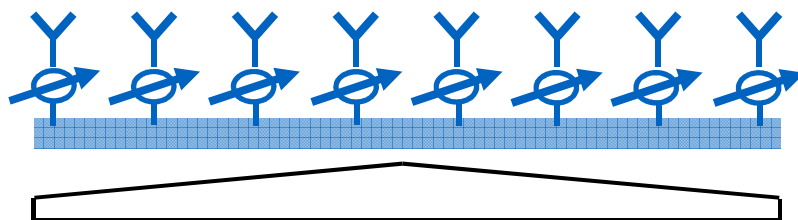

weighting phase and magnitude

Triangular weighting function

beamforming with phased array = phase + amplitude modification

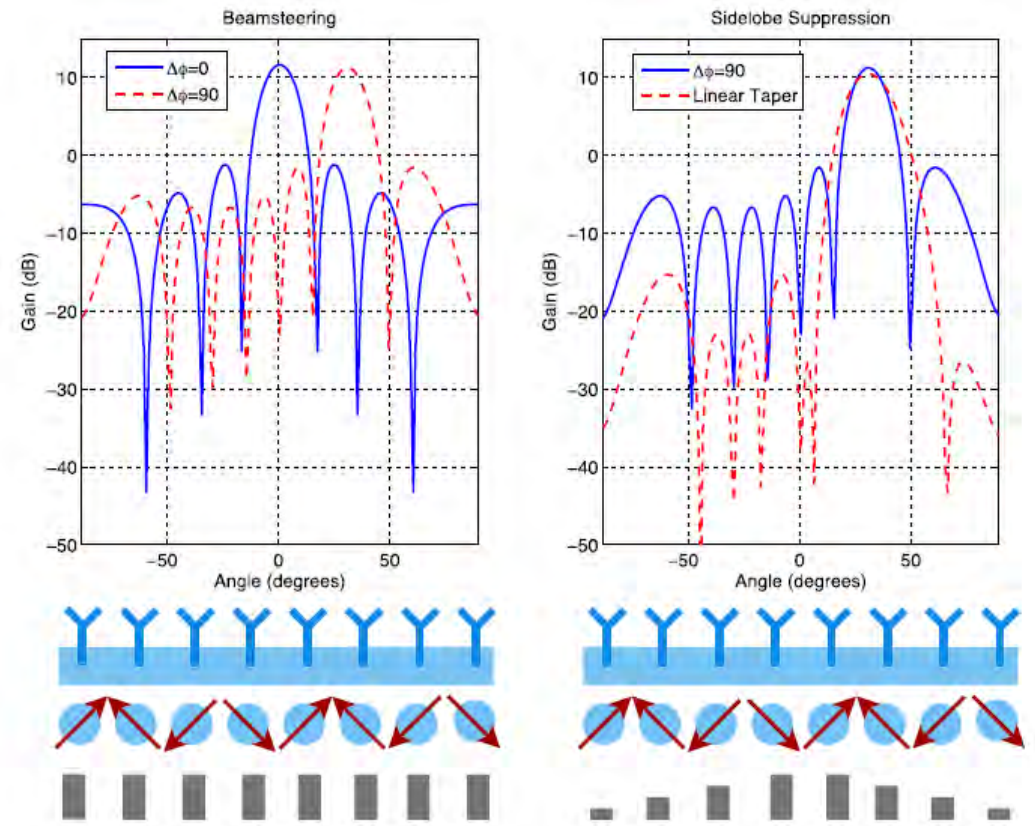

Analog beamforming concept

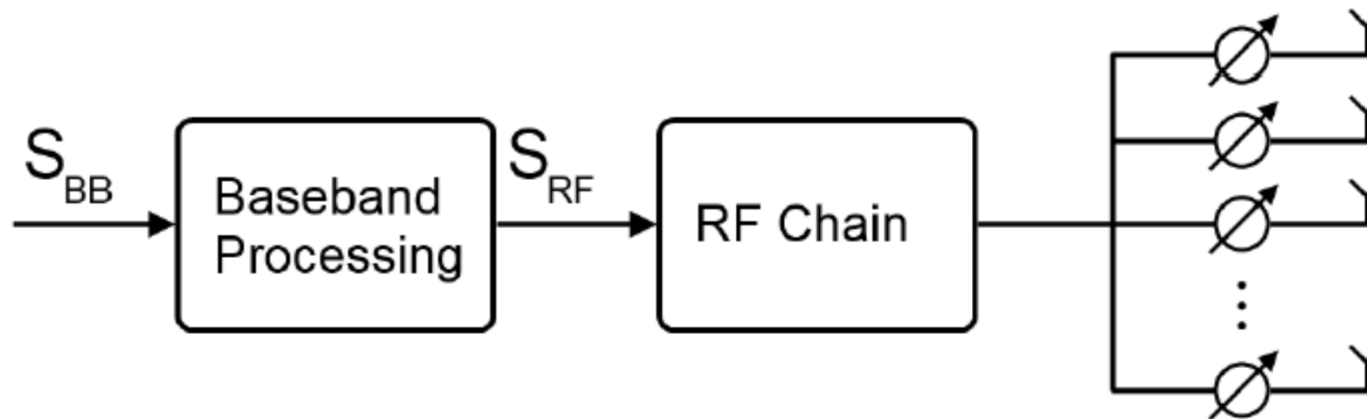

- separate control of the phase of each element
- beam can be steered not only to discrete but virtually any angle using active beamforming antennas
- not as expensive and complex as the other approaches
- On the other hand implementing a multi-stream transmission with analog beamforming is a highly complex task
- one RF chain

Analog beamforming – effect of beam squint

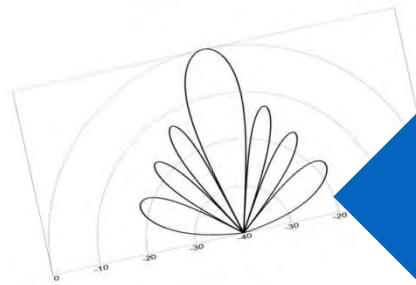
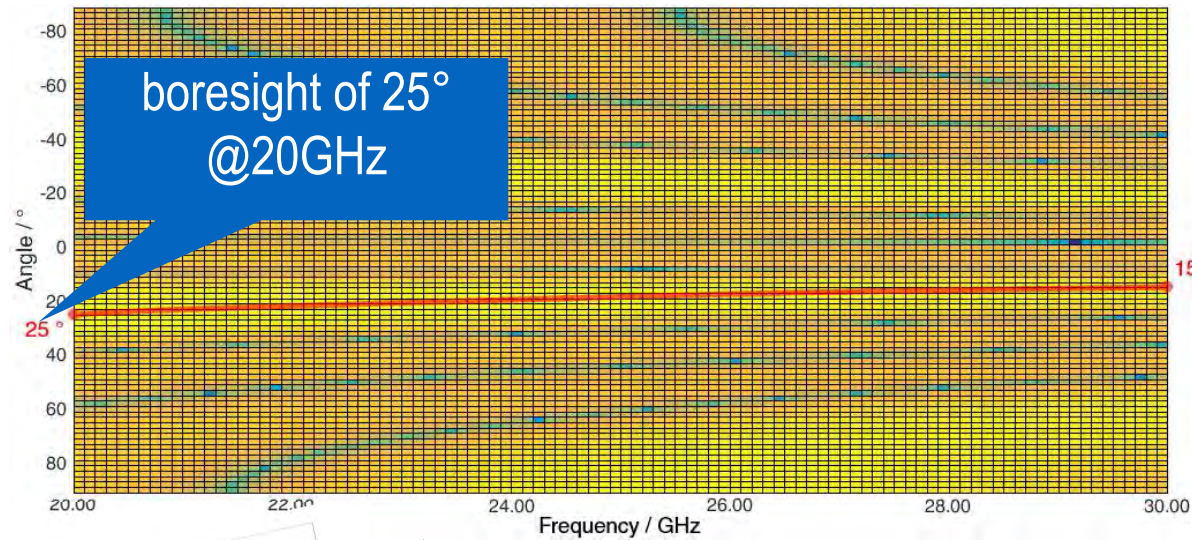

frequency dependency
translates into shift of main lobe: beam
squint

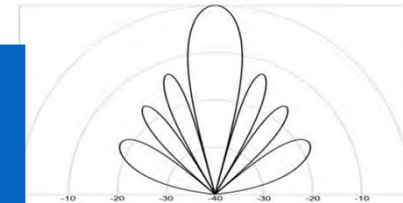

antenna arrays and beamforming scenarios

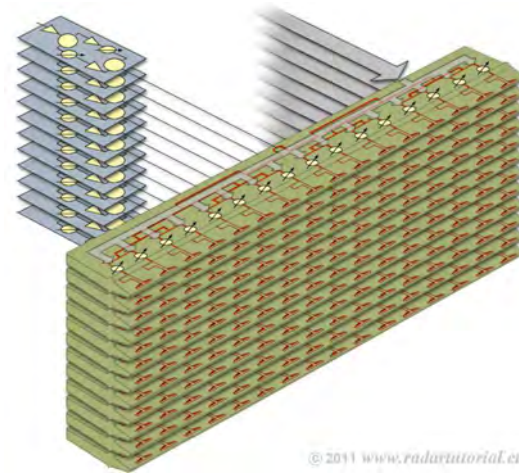
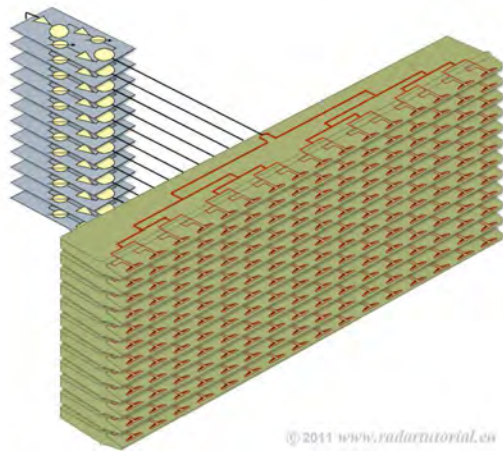

Linear antenna array:

- one phase shifter for antenna element segments
- simpler structure
- beam forming only in one dimension possible

Planar antenna array:

- one phase shift for each antenna element
- structure is more complex
- beam forming in 2 dimensions possible, i.e. horizontal and vertical = 3D beamforming

MIMO reminder – capacity calculations, e.g. 2x2 MIMO

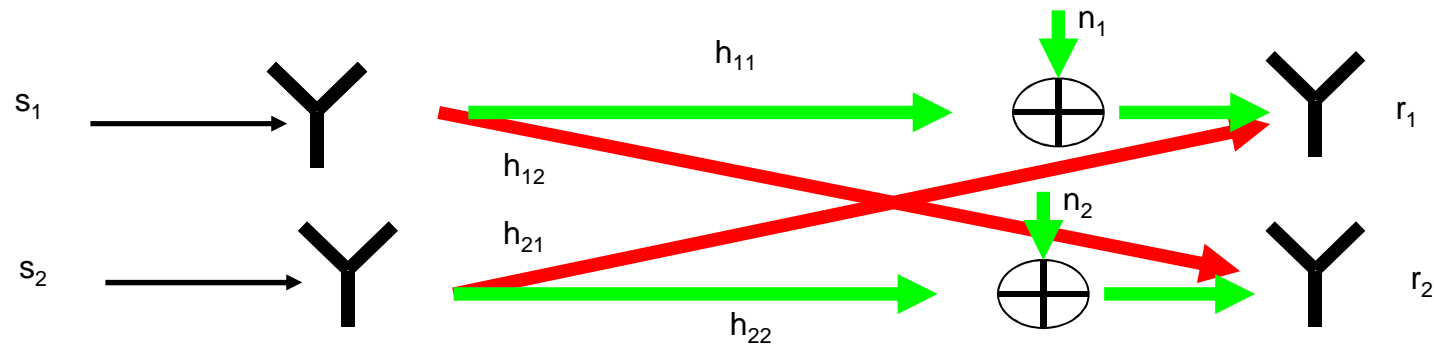

This results in the equations:

$$r_1 = s_1 * h_{11} + s_2 * h_{21} + n_1$$

$$r_2 = s_2 * h_{22} + s_1 * h_{12} + n_2$$

Or as matrix:

$$\begin{bmatrix} r_1 \\ r_2 \end{bmatrix} = \begin{bmatrix} h_{11} & h_{12} \\ h_{21} & h_{22} \end{bmatrix} * \begin{bmatrix} s_1 \\ s_2 \end{bmatrix} + \begin{bmatrix} n_1 \\ n_2 \end{bmatrix}$$

Generally written as:

$$r = s * H + n$$

To solve this equation, we have to know H



MIMO – work shift to transmitter



Transmitter

Channel

Receiver



MIMO – codebook based precoding

Precoding codebook

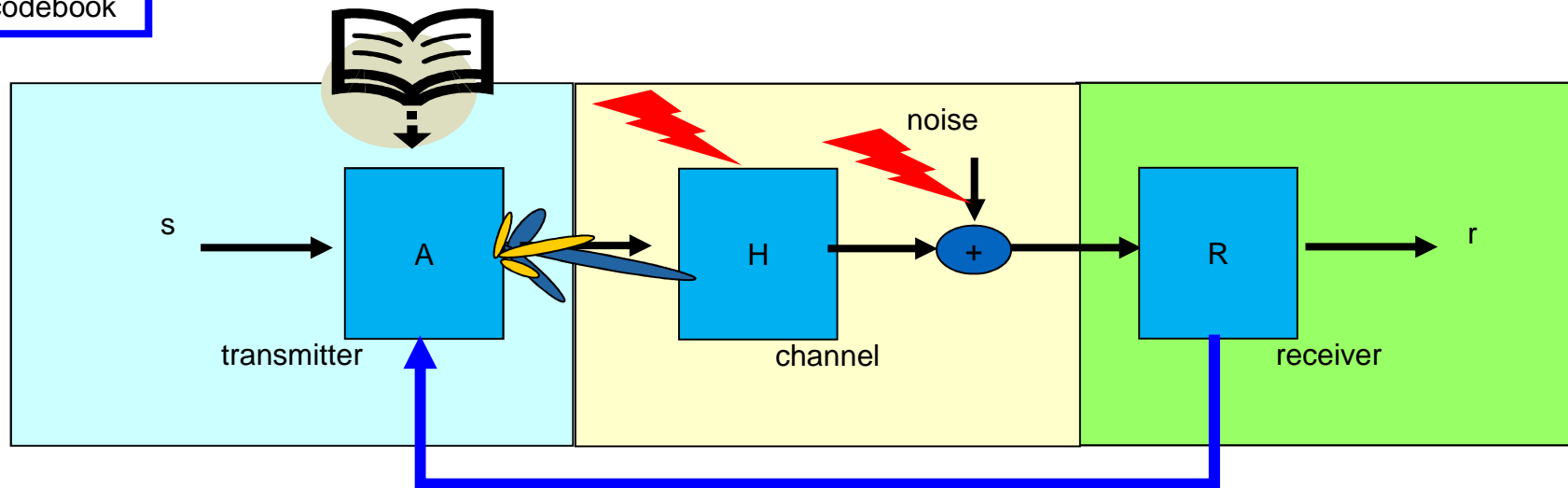

Precoding Matrix Identifier, PMI

Codebook based precoding creates some kind of „beamforming lite“



Digital beamforming concept

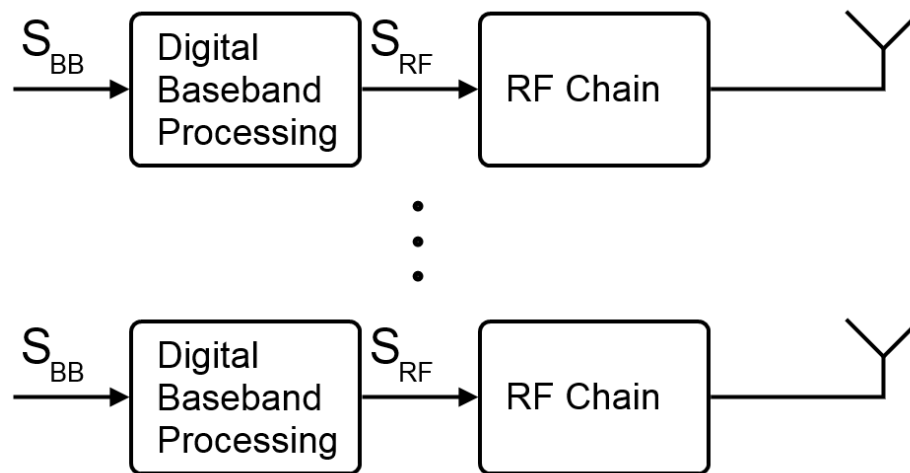

- digital beamforming in theory supports as many RF chains as there are antenna elements
- suitable precoding is done in the digital baseband, this yields higher flexibility regarding transmission and reception
- additional degree of freedom can be leveraged to perform advanced techniques like multi-beam MIMO
- Digital beamforming can accommodate multi-stream transmission and serve multiple users simultaneously
- Digital control of the RF chain enables optimization of the phases according to the frequency over a large band
- very high complexity and requirements regarding the hardware may significantly increase cost, energy consumption and complicate integration in mobile devices

Digital beamforming concept

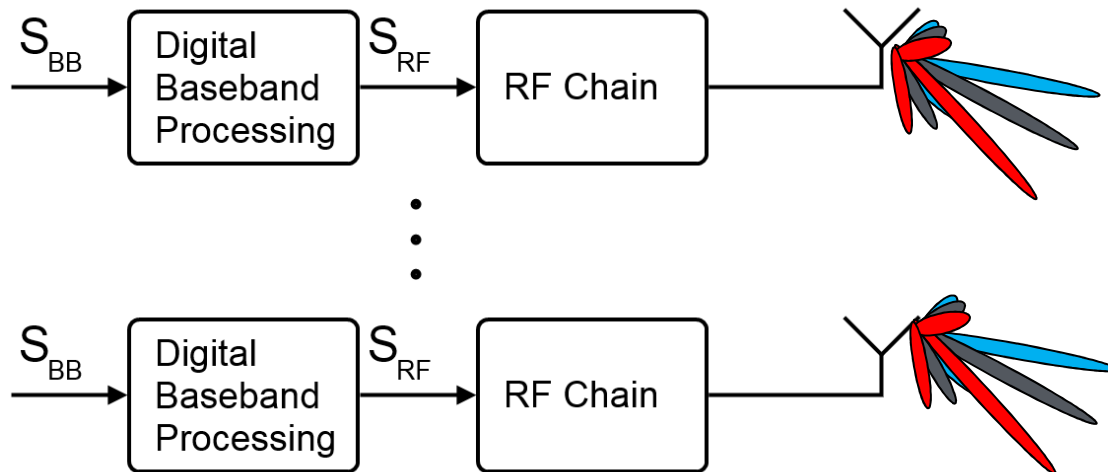

digital beamforming allows to simultaneously generate multiple beams by using the same hardware antenna elements.
-> at the price of higher complexity, i.e. number of RF chains

Hybrid beamforming concept

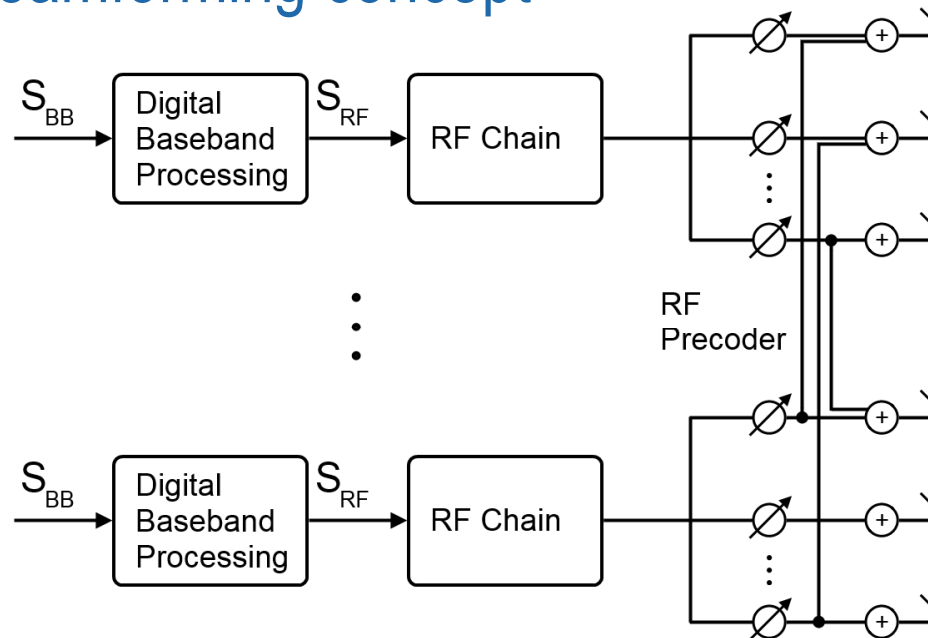

- trial to combine the advantages of both analog and digital beamforming architectures
- reducing the number of complete RF chains
- number of simultaneously supported streams is reduced compared to full blown digital beamforming

Hardware Perspective: Massive MIMO = Beamforming + MIMO

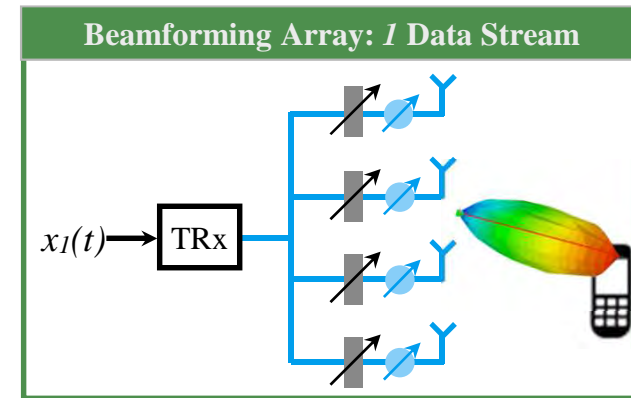
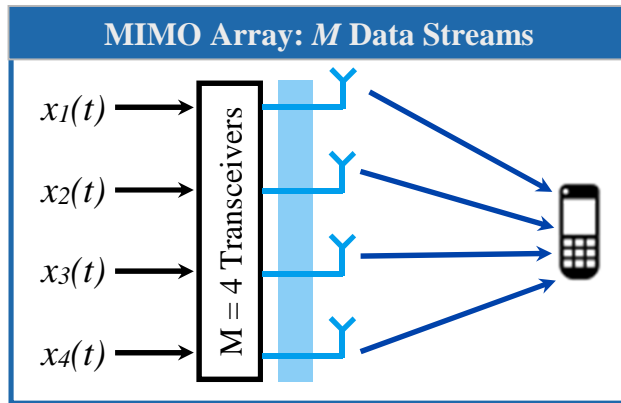

+

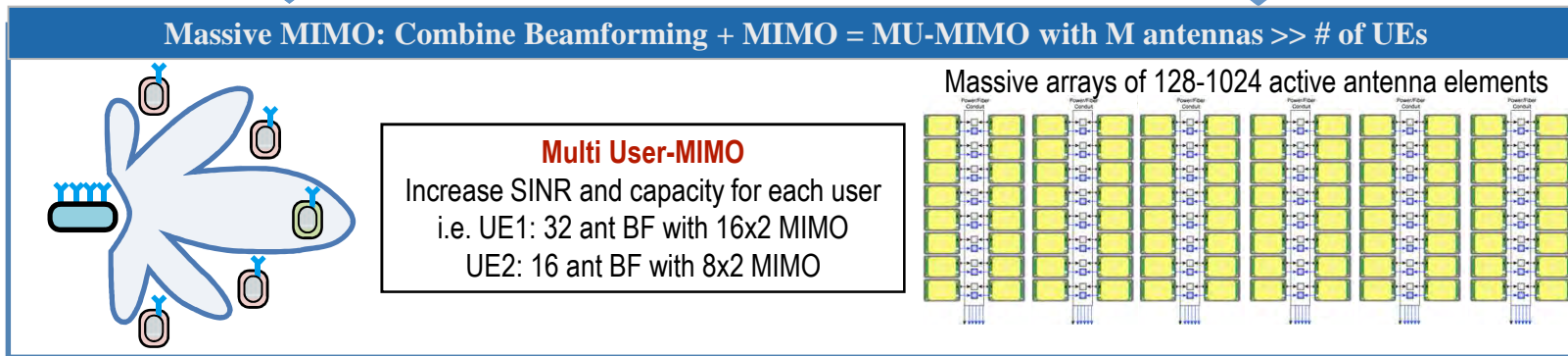

Applications of Massive MIMO from the networks perspective

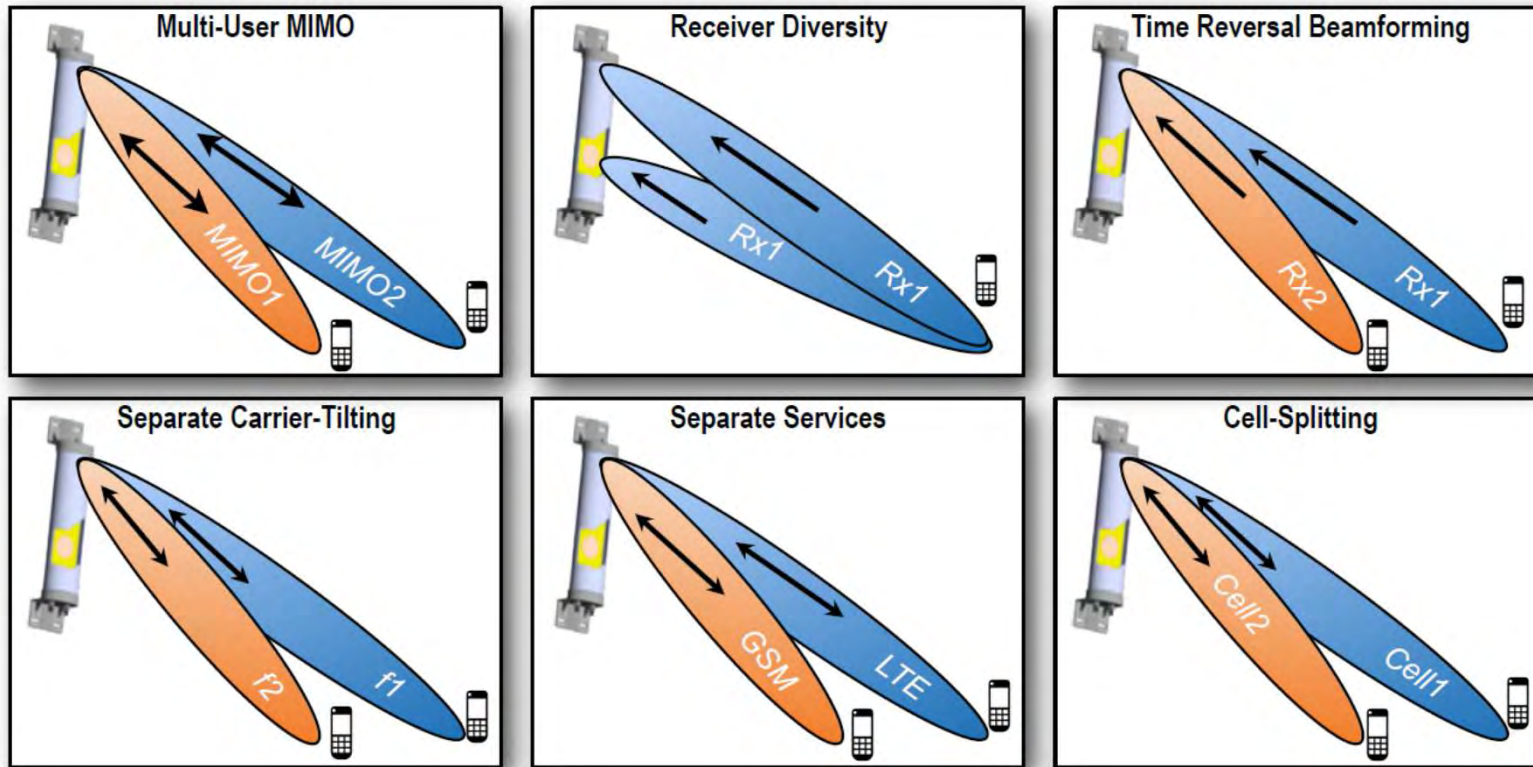

3GPP RAN1#85 mMIMO transceiver architectures

(sources: Tdoc R1-164018, Tdoc R1-164038, Tdoc R1-164334)

- Option 1: Digital beamforming
- Option 2: Analog beamforming
- Option 3: Hybrid beamforming

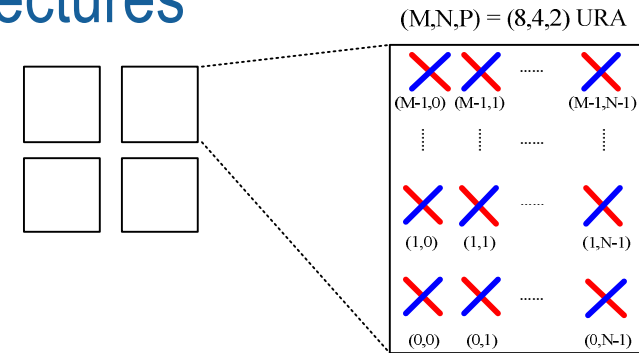
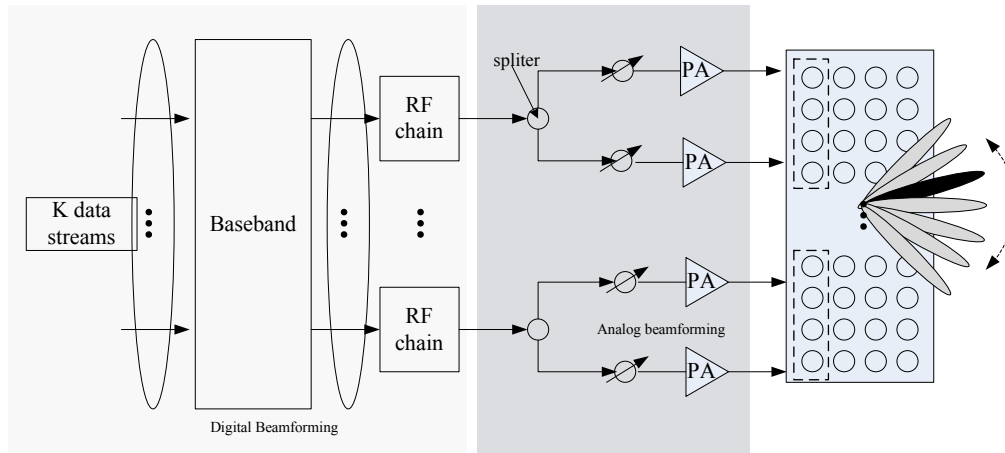

Example: URPA with 2x2 panels
URPA = uniform rectangular panel array

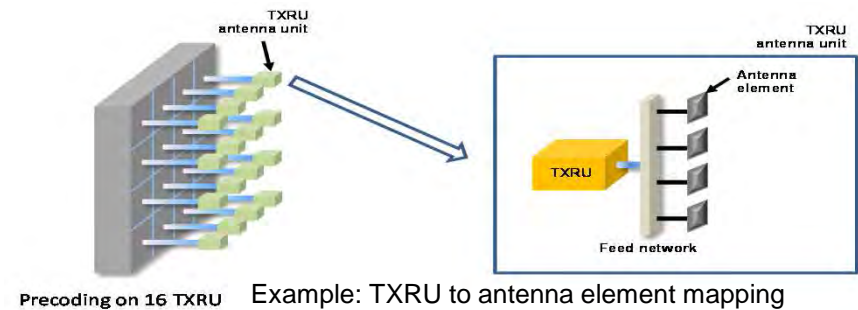

Tdoc R1-164334: “Hybrid beamforming seems the most promising beam steering strategy for massive MIMO systems, and should be supported.”

Passive vs. Active Antennas

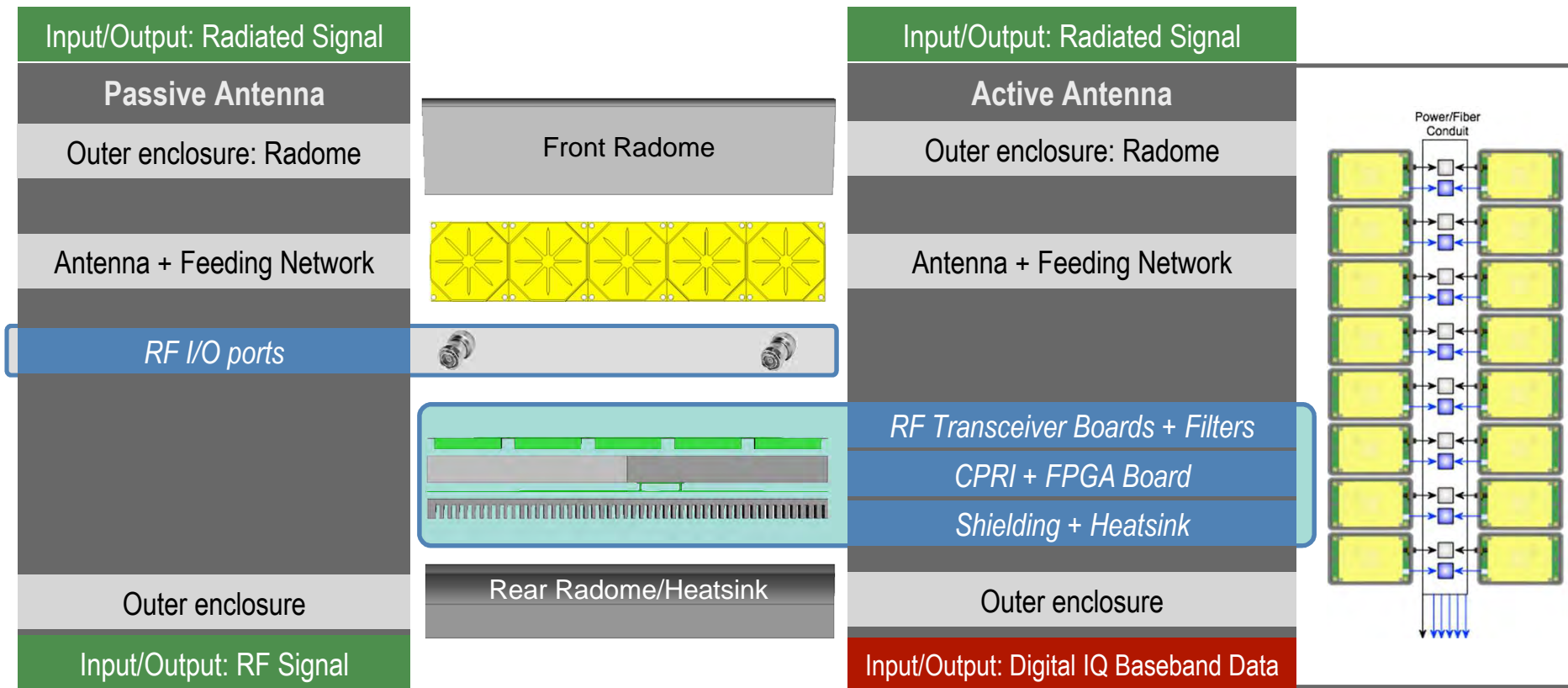

■ Massive MIMO Challenges



Massive MIMO Challenges



Data Bottleneck

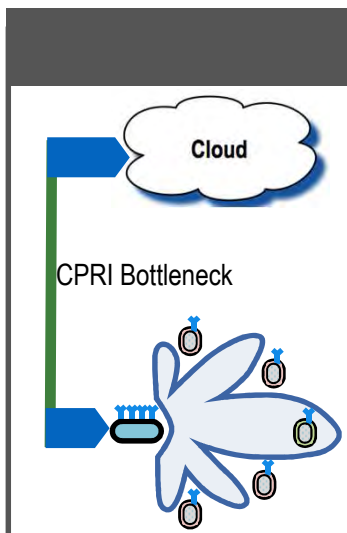

Increased Costs

Calibration

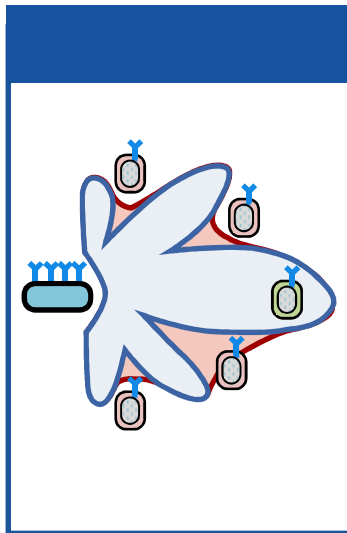

Reduced MU-MIMO

Mutual Coupling

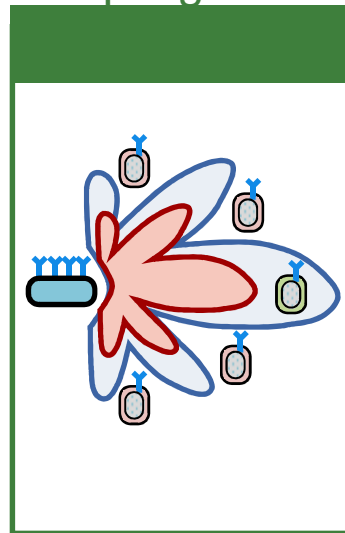

Reduced Capacity

Irregular Arrays

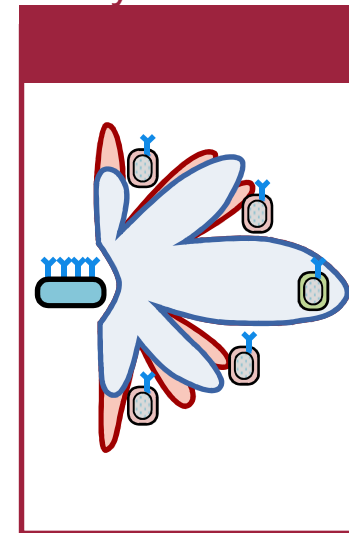

Grating Lobes

Complexity

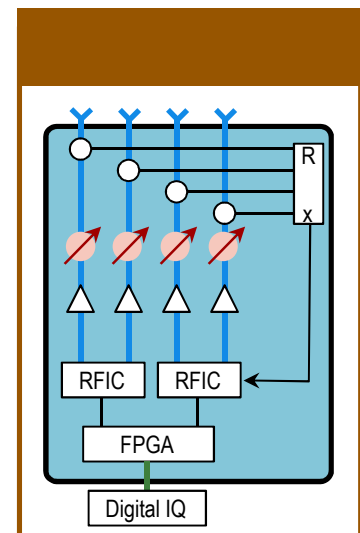

Increased Costs

Limitations of Digital IQ on Fiber: Latency & Capacity

Latency

Round Trip Time	Value
Fronthaul RTT	< 1ms
Sub-frame Processing	400-800 μ s
Optical Fiber RTT	FH _{RTT} - SFP _{RTT}
	200-400 μ s

$v_{fiber} = 2 \cdot 10^8$ m/s

Therefore Maximum Radius = 20-40 km

Lower Latencies will further reduce fiber radius

CPRI Data Bottleneck

Digital I/Q is constant bit-rate (always operates at full capacity)

$$BW_{CPRI} = S \cdot A \cdot f_s \cdot b_s \cdot 2 \cdot O \cdot LC$$

S: Sectors O: Overhead b_s: bits/samples LC: Line Coding

f_s: Sample Rate A: Antennas

Bandwidth requirement scales linearly with antennas and signal bandwidth (15 MS/s per 10 MHz radio bandwidth)

System	IP Data Rate	CPRI Data Rate
2G: GSM with 3 sectors	114 kbps	1.44 Gbps
4G: LTE with 1 antenna	150 Mbps	3.70 Gbps
5G: 32 antennas	10 Gbps	786 Gbps

Active Antenna Arrays: The Calibration Problem

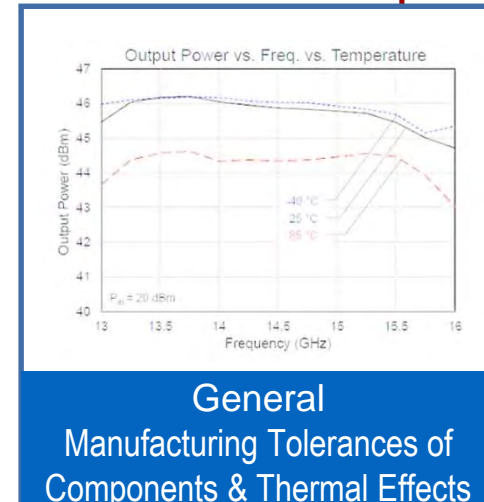
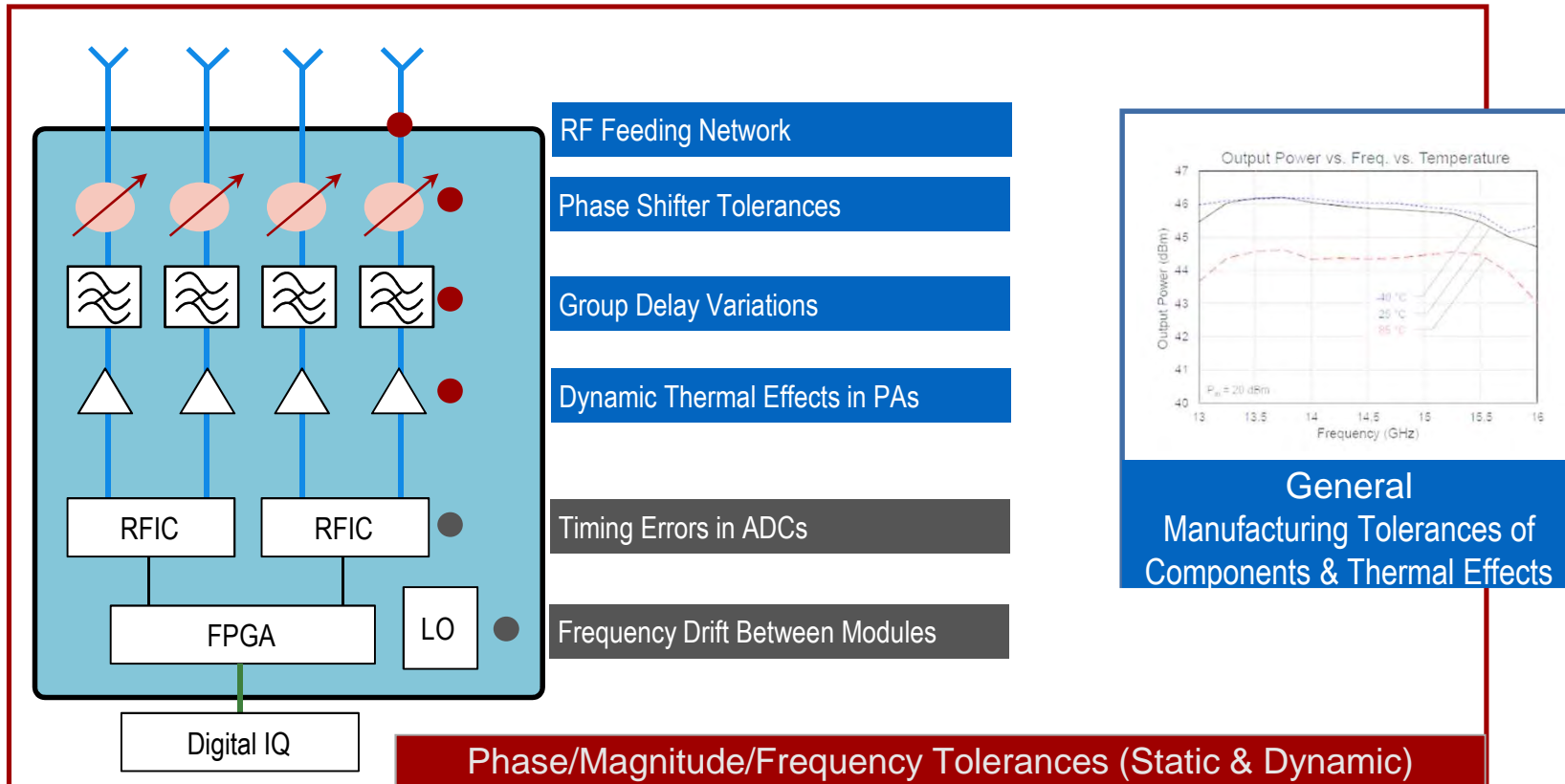

Phase Tolerances

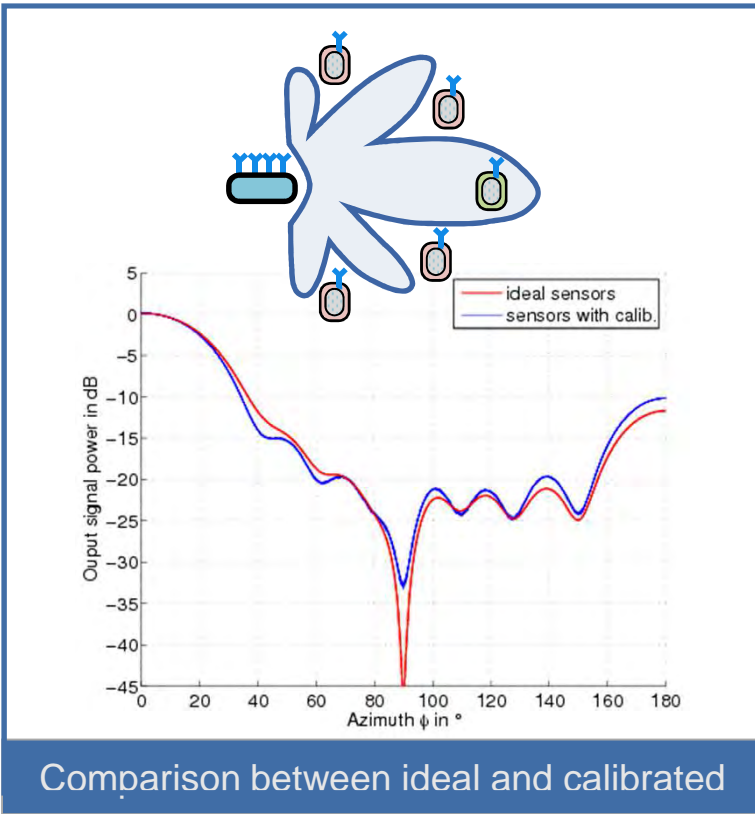

MU-MIMO
Multiple beams
Places nulls at UEs
(Null-steering)
 $\Delta\phi < \pm 2.5^\circ$

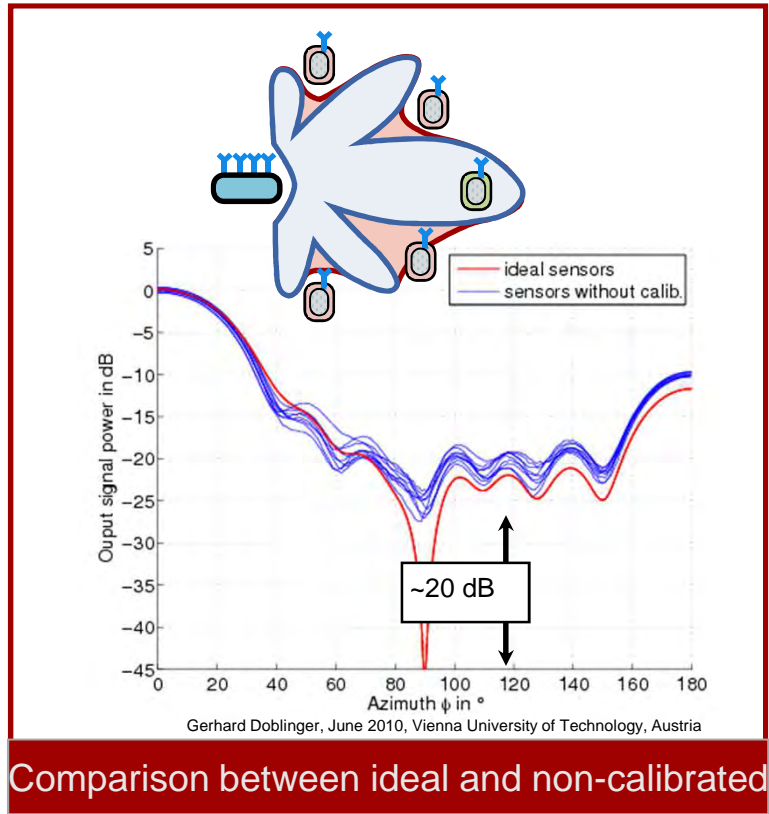

Antenna Self-Calibration

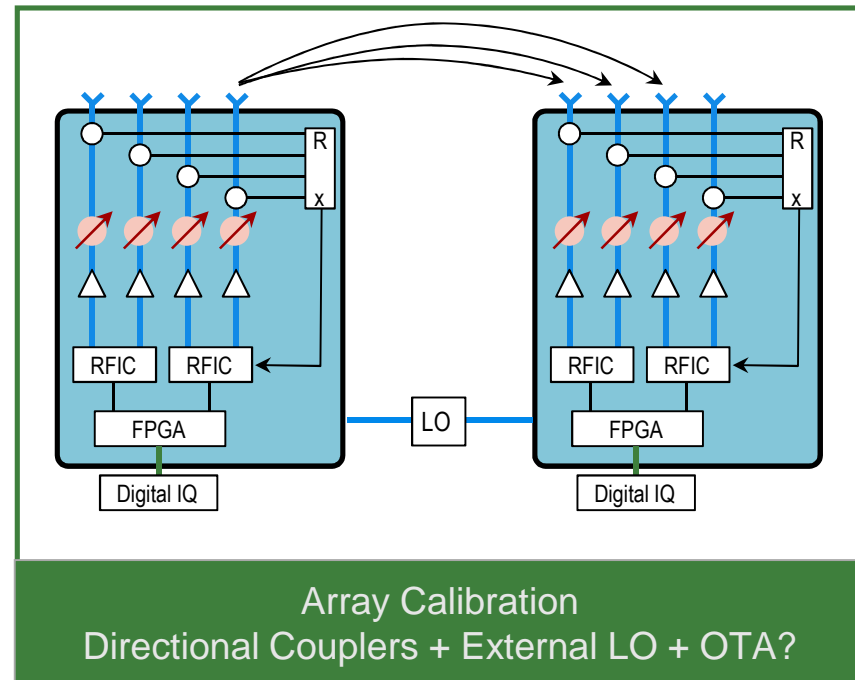
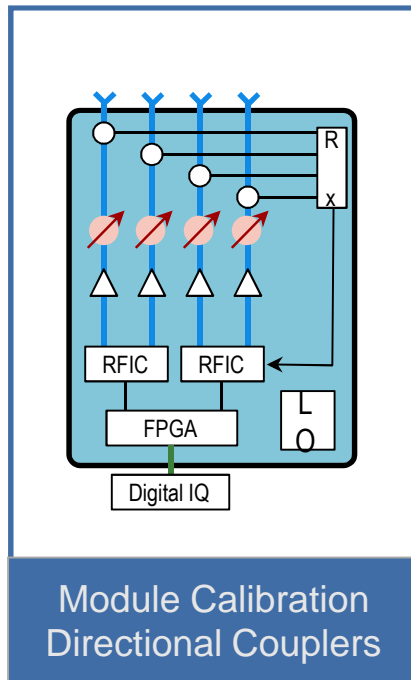

Antenna Mutual Coupling

Basestation Linear Array: 2 Adjacent Antennas

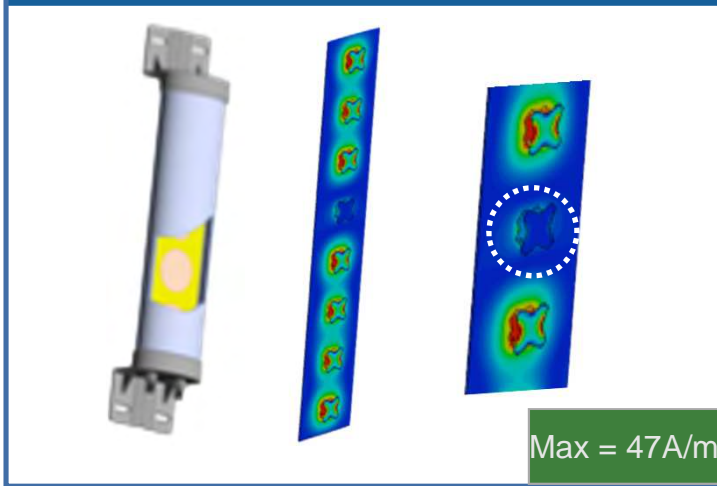

AAS Square Array: 8 Adjacent Antennas

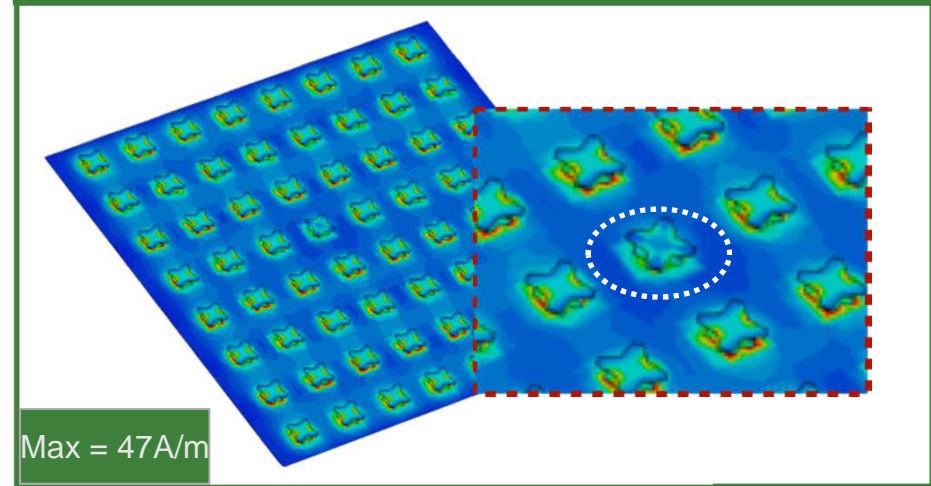

Measure Mutual Couple & Capacity in Massive MIMO



Problem: Antenna mutual coupling reduces capacity

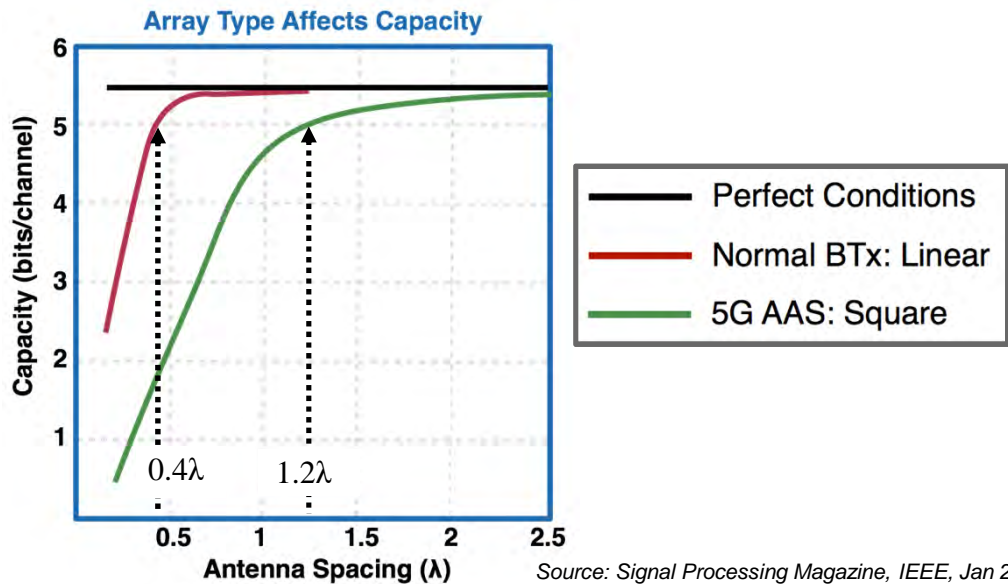

In order to maintain capacity, square antenna arrays require more spacing to reduce antenna mutual coupling

Solution: Measurement with Multi-Port VNA

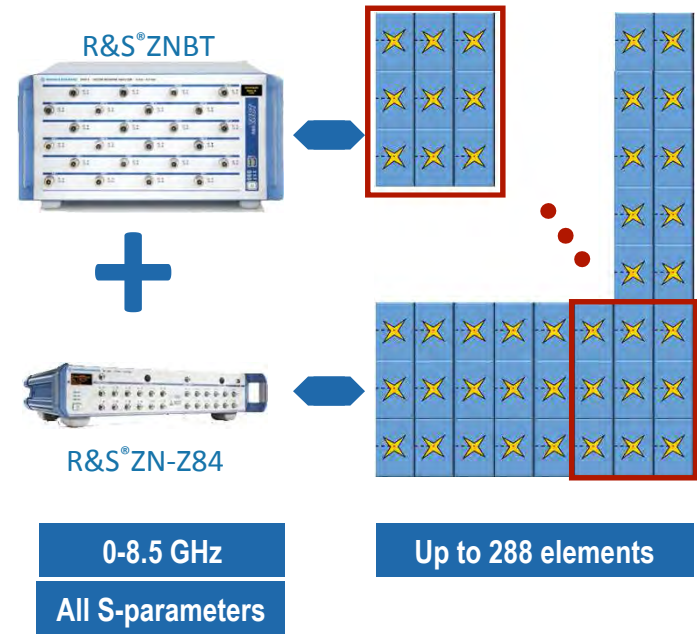

True simultaneous 24-port measurement



The ZNBT is the only VNA capable of measuring mutual coupling in Massive MIMO antenna arrays

Measurements of S-Parameters of Antenna Arrays



Active testing: excite all antenna elements simultaneously and measure the coupling to other elements.
-> this is much faster

$$\begin{bmatrix} S_{11} & S_{12} & S_{13} & S_{14} \\ S_{21} & S_{22} & S_{23} & S_{24} \\ S_{31} & S_{32} & S_{33} & S_{34} \\ S_{41} & S_{42} & S_{43} & S_{44} \end{bmatrix}$$

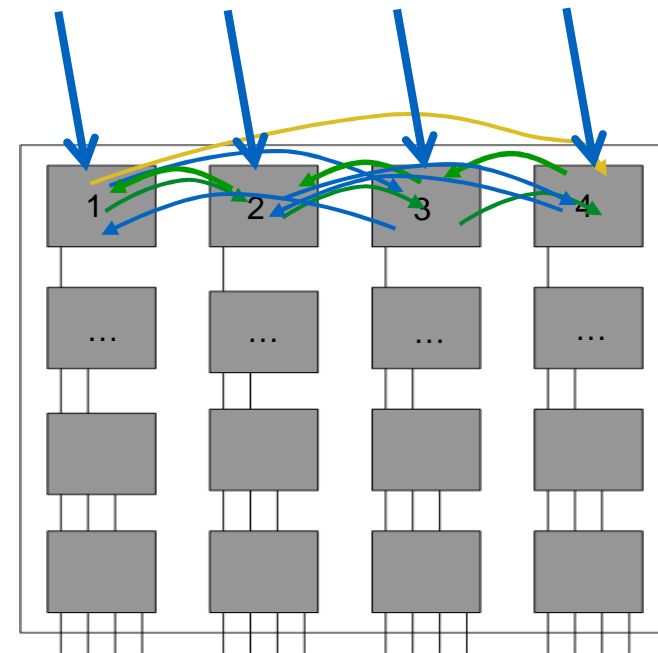

Irregular Arrays



Invisible, but irregular arrays
144 Element Array for TD-LTE



Absorbed into the Environment

Irregular Antenna Arrays: 2D Gain

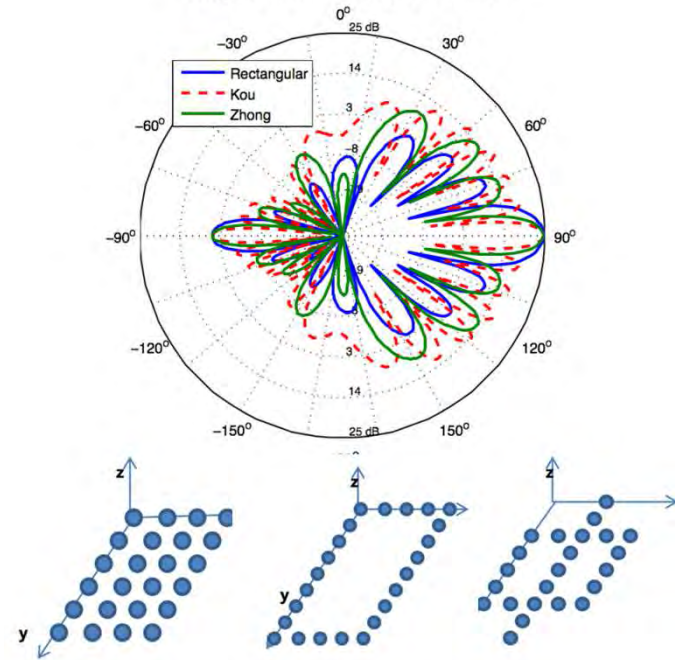

More Sidelobes and Lower Mutual Coupling

Massive MIMO = Complex Basestations

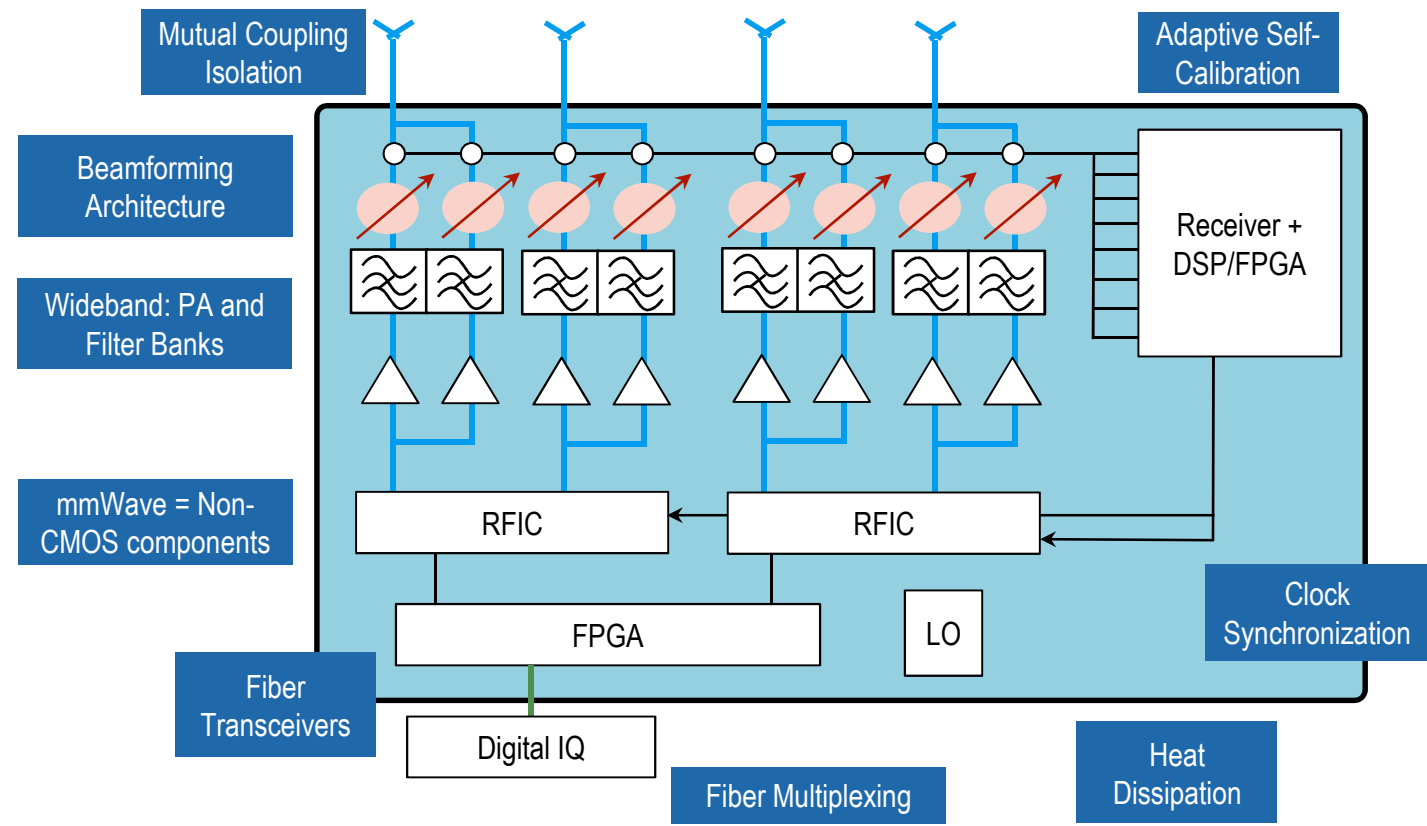

Fundamental Design Parameters for Active & Passive Antennas

Passive Antennas (Conducted)

UEs	Basestations
Impedance matching (Smith Chart)	
S-Parameters & Return Loss	
S ₁₂ & Mutual Coupling	

Active Antennas (Radiated)

User Equipment/Terminals	Basestations
Radiation Gain Patterns (2D/3D)	
Active (UE): TRP, TiS	Active (Basestation): EiRP, EiS
Radiation Efficiency (UE)	5 Point Beam Specification (3GPP)
Specific Absorption Ratio (UE)	Multiple Beam Specification (3GPP)
Beamsteering & Beamtracking (mmWave)	



Fundamental Properties: Electromagnetic Fields



Basestation 8 Element Array at 2.7 GHz

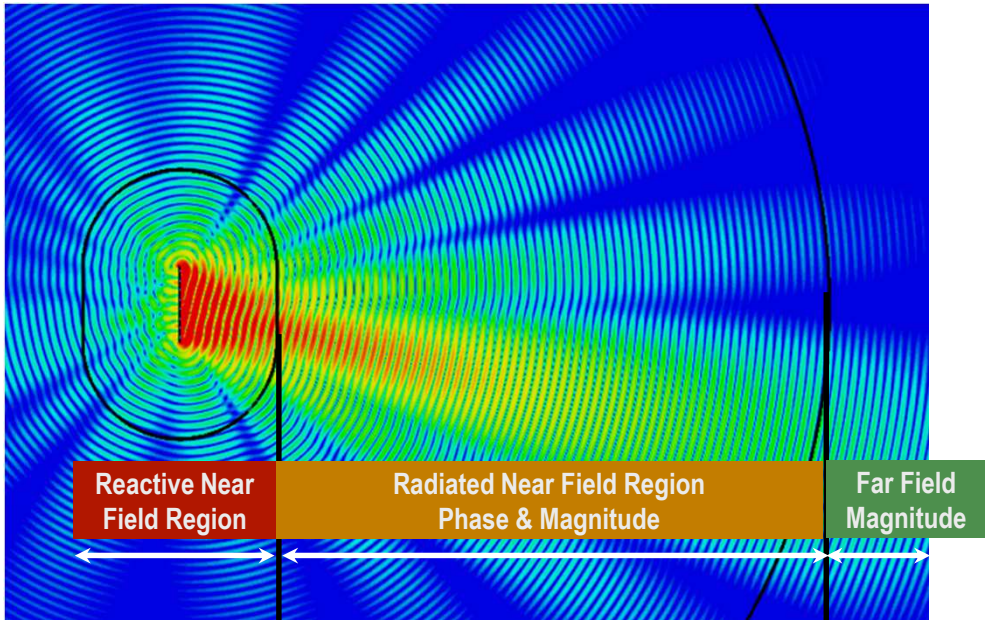

Reactive Near Field Region

Radiated Near Field Region
Phase & Magnitude

Far Field
Magnitude

$$0.62 \sqrt{\frac{D^3}{\lambda}} = 0.6 \text{ m}$$

$$\frac{2D^2}{\lambda} = 4.5 \text{ m}$$

Reactive Near Field Region (< 0.6m)

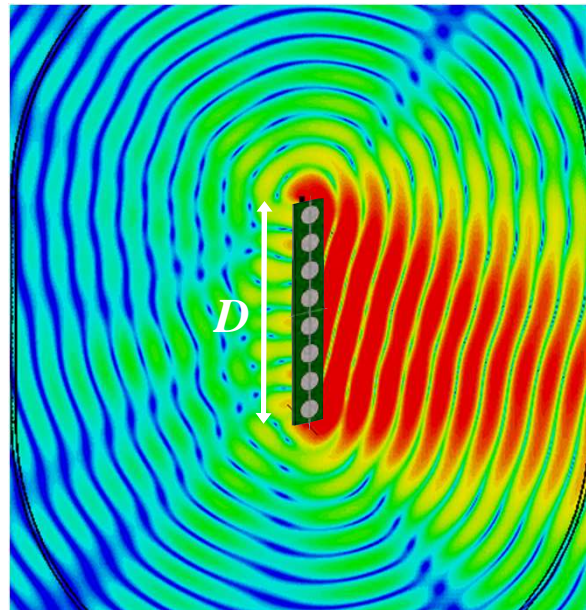

Any object in this region becomes part of antenna system & interferes with the measurements



Chamber Size: Far-field or Near-field?

$$R_{FF} = \left(\frac{2D^2}{\lambda} \text{ or } \frac{2\lambda}{HPBW} \right)$$

HPBW (radians)
Half-power beam width



Basestations: Subarray Measurements ($D_{ant} \ll DUT$)

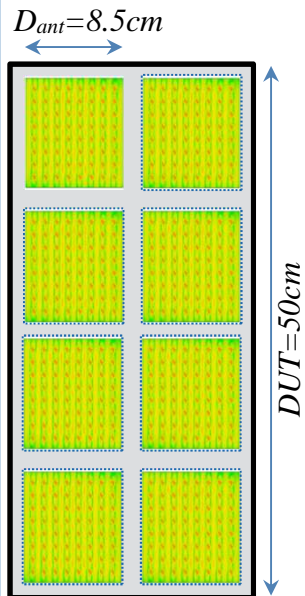

28GHz Subarray ($\lambda = 10.7\text{mm}$, $HPBW=7.2^\circ$)	
Criteria	Far-field Distance
$2\lambda/HPBW^2$	1.35 meters
28GHz Entire Base-station ($HPBW=1.2^\circ$)	
$2D^2/\lambda$	46 meters

UEs: $D_{ant} \sim DUT$

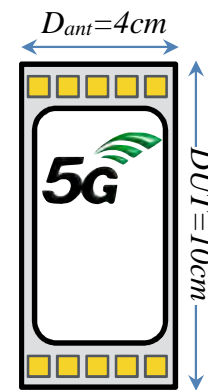

28GHz UE Subarray ($HPBW=15^\circ$)	
Criteria	Far-field Distance
$2\lambda/HPBW^2$	0.30 meters
28GHz Entire UE	
$2D^2/\lambda$	1.86 meters

Far-field criteria is met for UE & Base-station Subarrays for R&S Chambers

3GPP Active Base-station Beam Requirements (2016)

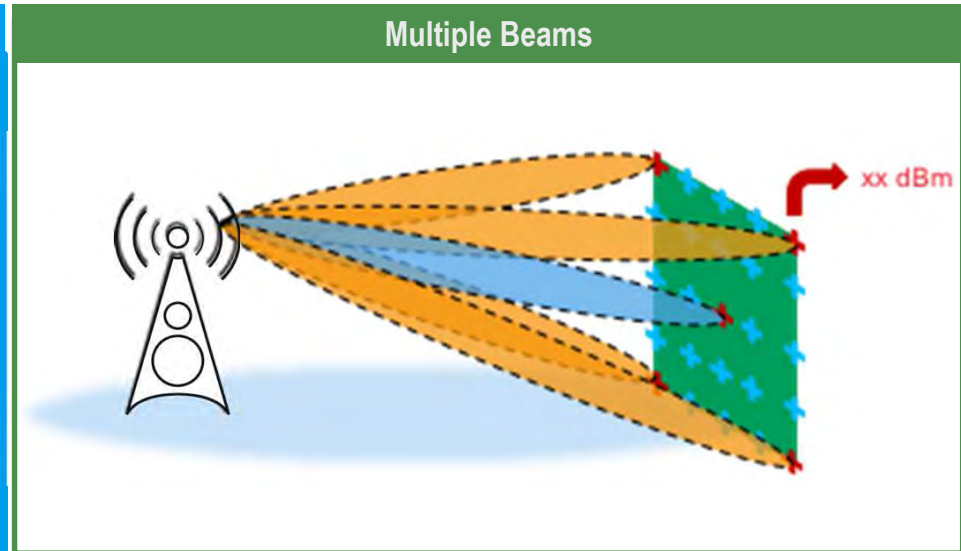
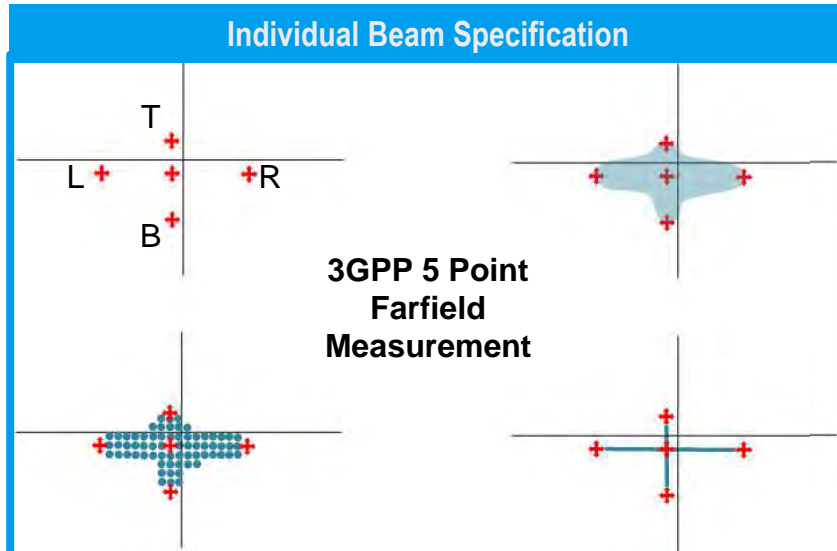

The manufacturer of the AAS will declare both the beam direction and a threshold comprised of four points for each AAS beam. The maximum radiated EIRP of the declared AAS beam is the mean power level measured in the boundary formed by the four points. The four points are defined as B (bottom), T (top) L(left), and R(right); together with the beam peak, this is known as the five point beam test.

The number of beams supported by the AAS is left to the manufacturer to declare where both continuous and non-continuous beam declarations are possible. Radiated transmit power is defined as the EIRP level for a declared beam at a specific beam peak direction. Although the claimed EIRP level (blue and red crosses) has to be achieved for all claimed beam peak directions, however, for compliance only the declaration of the center and the extreme directions are sufficient to be measured (marked with red crosses)



Measuring 5G mmWave & Massive MIMO Systems



OTA Gain, EiS, EiRP

Multiport Antenna Array Measurements

Measure mutual coupling S-Parameters

Element/System OTA EVM, ACLR

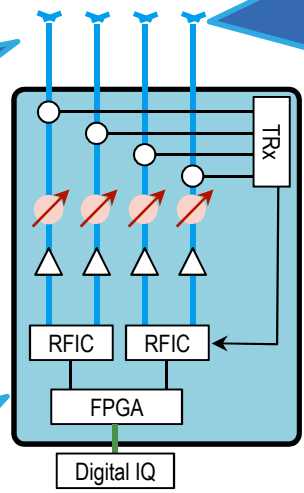

Production TRx & Antenna Calibration



R&S OTA Product Matrix

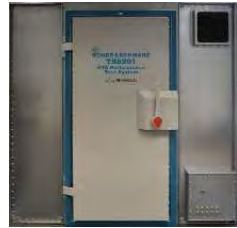

	CTIA OTA: TS8991/WPTC	OTA R&D: Massive MIMO Spiral Scanner	OTA Production: ATS1000	OTA Production: OTA Power Sensors	Benchtop Systems: DST200 & TS7124
Frequencies	0.4 to 18 GHz	0.4 to 40 GHz	0.4 to 90 GHz	28-75 GHz	28-90 GHz
Minimum Size	250x250x220 cm	250x250x220 cm	70x100x140 cm	45x50x48 cm	77x76x70 cm
Fields	Near & Far	Near & Far	Near & Far	Far Field	Far Field
Signals	Modulated/CW	Modulated/CW	Modulated/CW	Modulated/CW	Modulated/CW
Parameters	EiRP, EiS, Gain, EVM, ...	EiRP, EiS, Gain, EVM, ...	EiRP, EiS, Gain, EVM, ...	Gain	EiRP, EiS, Gain, EVM
Availability	Available for purchase	Available for purchase	Available for purchase in Q2 2017	Available for Purchase	Available for Purchase

TS8991: Total Radiated Power Sampling Methods



Stepped Sampling
6 minutes per channel

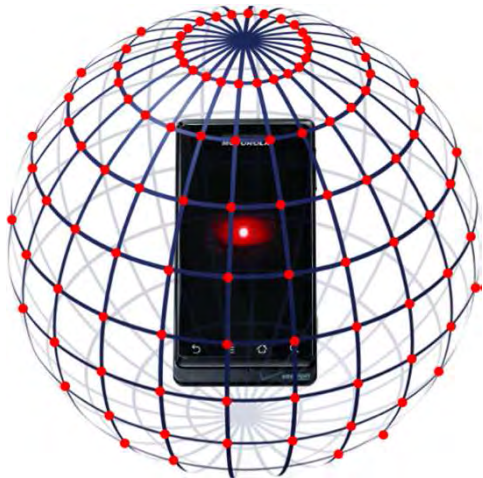

Elevation(θ): Stepped

Azimuth(φ): Stepped

Step-Swept Sampling
2-3 minutes per channel

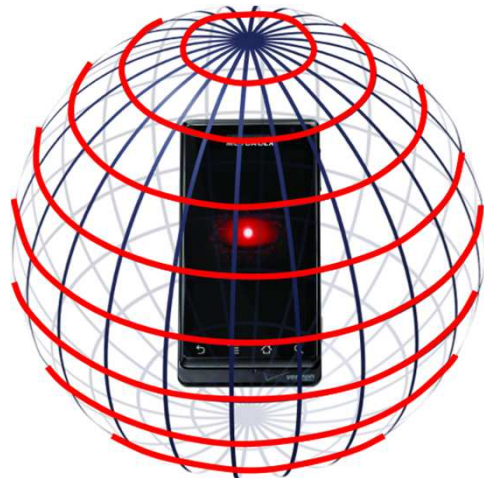

Elevation(θ): Swept

Azimuth(φ): Stepped

Spiral Scan Sampling
30-60 seconds per channel



Elevation(θ): Swept

Azimuth(φ): Swept



Spiral Scanner Reference Antenna OTA System

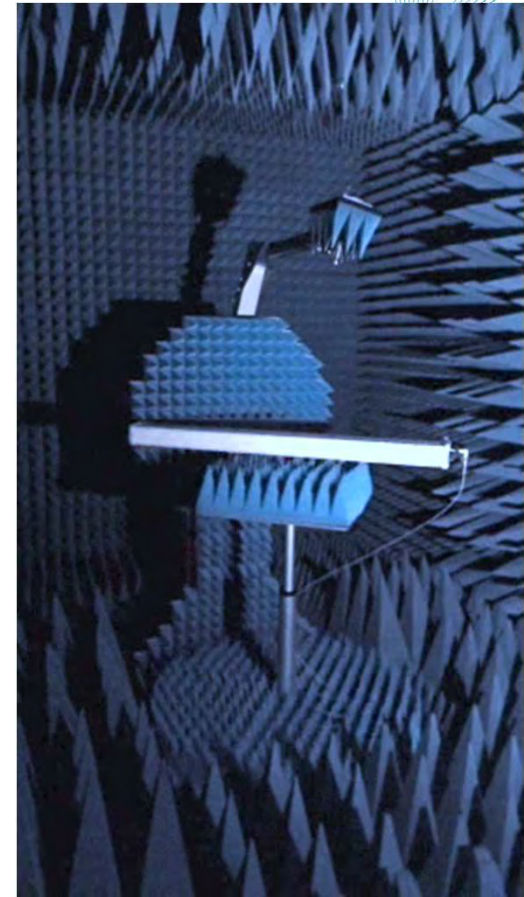
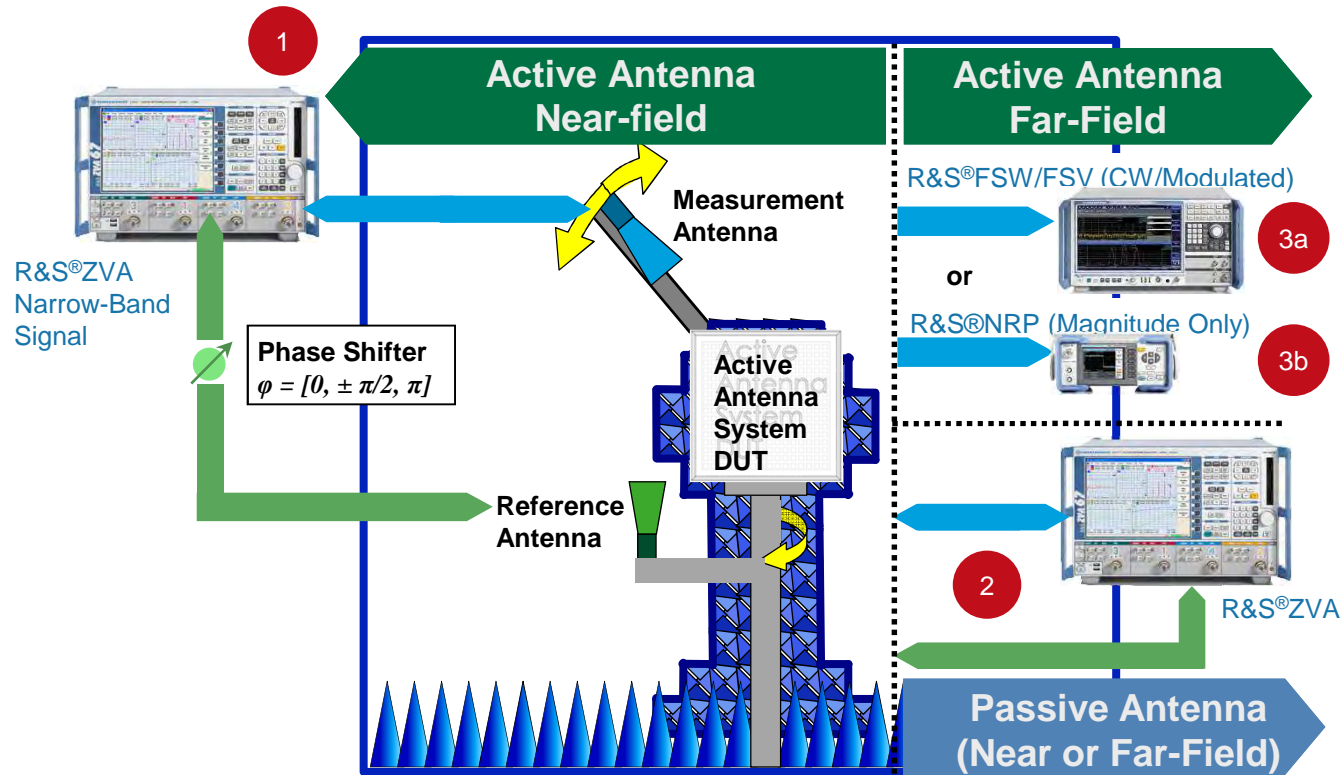

Alternative for far-field TRP measurements

NRPM OTA Power Sensor: Magnitude Measurements

R&S®NRPM OTA Power Sensor

Combination of power sensor and Vivaldi antenna on one module

Integrated level detector diode – no cable losses

Frequency range: 27.5 GHz to 75 GHz

Level range:

-75 dB to -25 dBm (continuous)

-62 dBm to -25 dBm (trace)

Low radar cross section: < -20 dBsm (typical)

Accuracy for relative power measurements @28 GHz and 39 GHz:

Levels \leq -35 dBm: < 0.1 dB

Levels > 35 dBm: < 0.2 dB

NRPM OTA Power Sensor
Antenna Module



3 Channel NRPM OTA Power Sensor



Antenna Array Beamsteering Magnitude Only

mmWave DUTs will not have antenna connectors

OTA Measurements will be mandatory for production

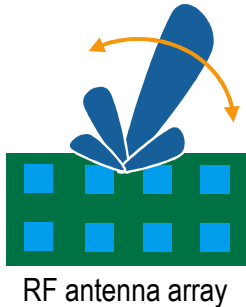
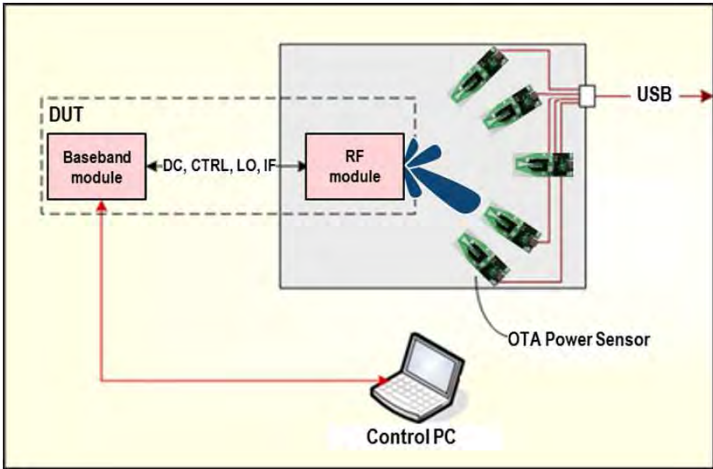

RF antenna array

Measurement Equipment



R&S®TS7124

Shielded chamber (TS7124)



R&S®NRPM

Vivaldi Probe 28-77 GHz

Measurement Scenarios

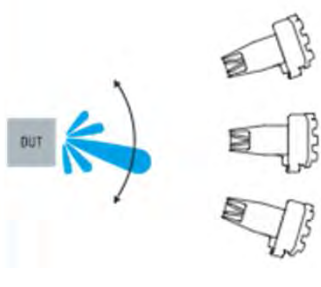

2D Beam-Steering

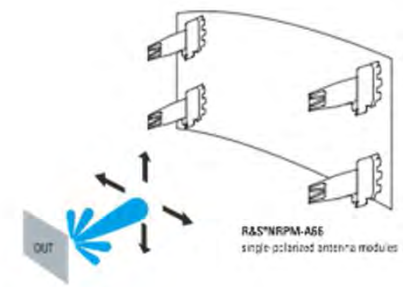

3D Beam-Steering



ATS1000 flexible shielded chamber (launched @ MWC2017)

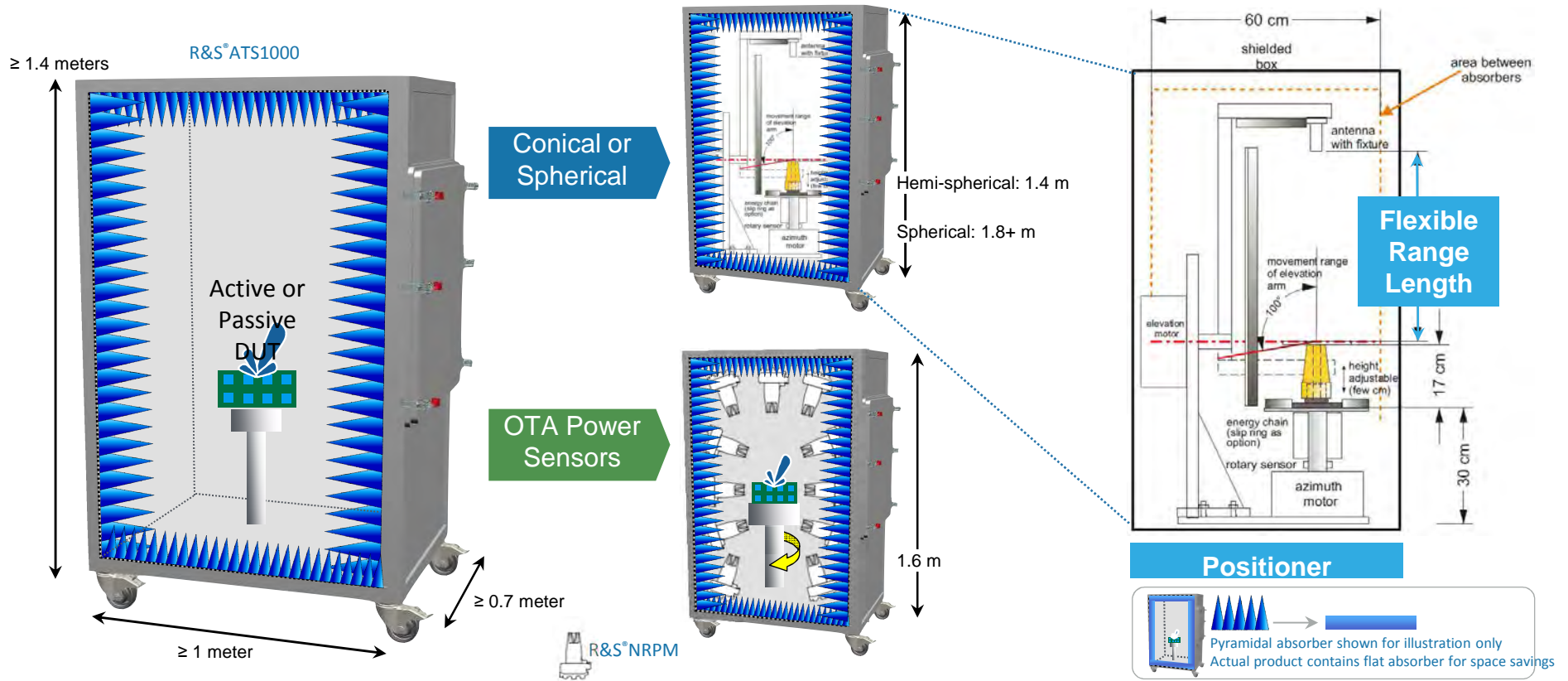

R&S Antenna Test Solutions Summary



Massive MIMO

R&S®TS8991

CTIA Radiation Patterns

R&S®TS8991

R&S®FSV R&S®NRP

mmWave Beamsteering

R&S®NRPM R&S®NRPM-A66

RF Conformance

R&S®TS7380

R&S®ATS1000

mmWave

R&S®ATS1000

R&S®ZVA

R&S®FSW

R&S®SMW200A

Multiport Testing

R&S®SMW200+
6x R&S®SGT100

R&S®ZNBT

- Phase-coherent RF generation
- Multi-port VNA for Active Return Loss

Production & Benchtop

R&S®DST200

R&S®TS7124

R&S®RTO

R&S®FSV/FSP

R&S®ZVC/D



R&S test solutions to investigate, develop and standardize



Wideband Signal Testing

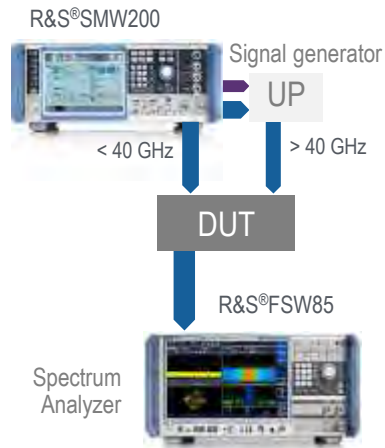

- 40 GHz signal generation
- 85 GHz signal analysis
- 2 GHz bandwidth support

Channel Sounding Solution

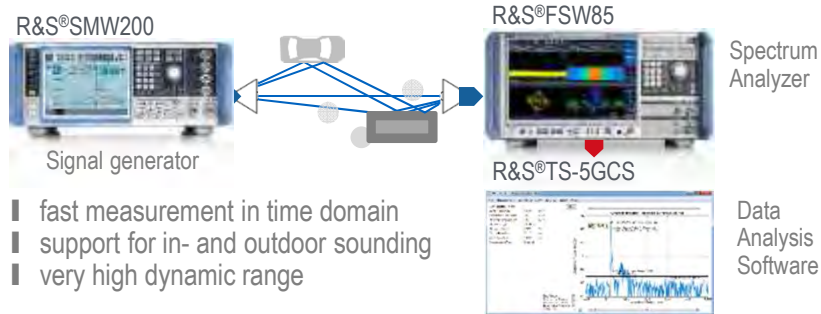

- fast measurement in time domain
- support for in- and outdoor sounding
- very high dynamic range

New 5G PHY Candidates

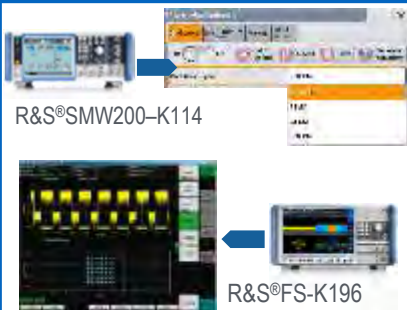

Component Characterization



Massive MIMO - Beamforming

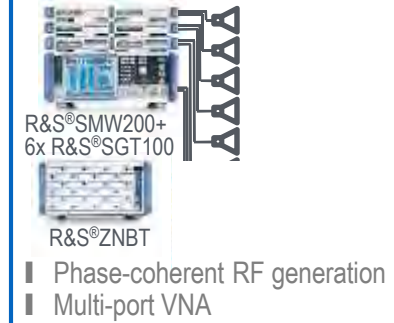

E2e Application Testing

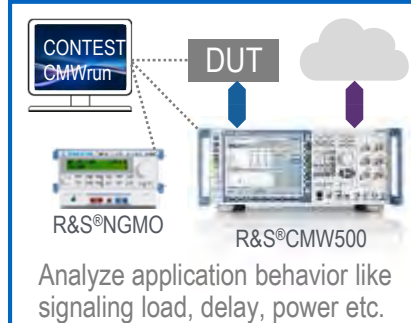

Conclusion

Is 5G just the next generation? No: It is a paradigm shift!

- Approach in industry:
 - UMTS: 1: define a technology for data transmission, 2: for what? / “*what is the killer app?*”
 - LTE (3GPP: e-UTRA): 1: define a better technology than UMTS, 2: use case (mobile web)
 - 5G: 1: define use cases, 2: requirements, 3: elaborate technologies / solutions
- From cell-centric (2G - 4G) to user-centric / application-centric in 5G (beamforming)
- From link efficiency (2G - 4G) to system efficiency in 5G (RAT defined per app)
- From antenna connectors (2G - 4G) to Over-the-Air testing in 5G (antenna arrays, beamforming)
- Increasing demand for security / high reliability in 5G (up to mission- and safety-critical use cases)

Rohde & Schwarz offers all essential capabilities to support the wireless communications industry with solutions needed to investigate, standardize, develop and rollout 5G





*“If you want to go fast, go alone.
If you want to go far, go together!”*

African proverb

